



**NOS VERSION 1
OPERATOR'S GUIDE**

**CDC® COMPUTER SYSTEMS:
CYBER 170 SERIES
CYBER 70
MODELS 71, 72, 73, 74
6000 SERIES**

DSD COMMAND INDEX

DSD Command	Page	DSD Command	Page
A.	4-2	L.ccc...ccc.	3-25
A,.	4-2	LDC,nnnn.	3-29
A,n.	4-2	LOAD,xx,yy.	3-2
A,ACCOUNT FILE.	4-2	LOCK.	3-25
ACCOUNT,.	3-2	LPxx,yy.	3-2
ACCOUNT,xx.	3-2	LRxx,yy.	3-2
ACNcc.	3-29	LSxx,yy.	3-2
A,ERROR MOG.	4-2	LTxx,yy.	3-2
n.ASSIGN,xx.	3-10	n.MAGNET.	3-20
AUTO.	3-22	MAINTENANCE.	3-22
BATCHIO Equipment Commands	3-18	MCHcc.	3-29
BKSPxx.	3-18	n.MCSffff.	3-20
BKSPxx,rr.	3-18	Memory Entry Commands	3-27
BKSPFxx.	3-18	MESSAGE,ccc...ccc.	3-10
BKSPFxx,ff.	3-18	MOUNT,xx.	3-12
BKSPRUxx,ss.	3-18	MSAL,t=xx ₁ ,xx ₂ ,...,xx _n .	3-8
BLITZ.	3-27	n.MSSffff	3-20
n.CDCffff.	3-19	n.NAMffff.	3-20
n.CFO.ccc...ccc.	3-9	O,SU.	4-30
Channel Control Commands	3-28	O,TA.	4-27
CHECK POINT SYSTEM.	3-24	O,TR.	4-27
n.CKP.	3-3	OANcc.	3-29
n.COMMENT.ccc...ccc.	3-9	OFFxx.	3-13
CONTINUExx.	3-18	n.OFFSWx.	3-10
CPxx,yy.	3-2	ONxx.	3-13
CRxx,yy.	3-2	n.ONSWx.	3-10
DATE,yy/mm/dd.	3-26	n.OVERRIDE.	3-9
Dayfile Commands	3-1	Peripheral Equipment Control Commands	3-10
DAYFILE,.	3-2	PURGE,fmt.	3-8
DAYFILE,xx.	3-2	PURGEALL,t.	3-9
DCHcc.	3-29	QUEUE,ot,qt,qP ₁ PPPP,....,qP _n PPPP.	3-4
DCNcc.	3-29	n.RBFffff.	3-20
DEBUG.	3-26	REPEATxx.	3-19
DELAY,t ₁ pppp,....,t _n pppp.	3-7	REPEATxx,yy.	3-19
DIAL,nnnn,ccc...ccc.	3-10	RERUNxx.	3-19
n.DIS.	3-25	RERUNxx,yy.	3-19
DISABLE,op.	3-22	n.RERUN,pppp.	3-4
DISPLAY,fmt.	4-27	ROLLIN,fmt.	3-3
Display Selection Commands	4-1	n.ROLLOUT.	3-3
DOWN,CHcc.	3-13	n.ROLLOUT,xxxx.	3-3
n.DROP.	3-9	SCRATCH,xx.	3-11
E,.	4-13	SERVICE,ot,p ₁ pppp,....,p _n pppp.	3-4
E,A.	4-13	SET,ssss.	4-2
E,C.	4-13	SKIPxx.	3-19
E,M.	4-16	SKIPxx,rr.	3-19
E,P.	4-17	SKIPFxx.	3-19
E,T.	4-17	SKIPFxx,ff.	3-19
E,T+.	4-17	SKIPRUxx,ss.	3-19
E,T-.	4-17	STEP.	3-26
ENABLE,op.	3-22	STEP,xx.	3-26
ENDxx.	3-18	n.STEP.	3-26
ENDxx,yy.	3-18	n.STEP,xx.	3-26
ENGR.	3-26	STOPxx.	3-19
ENID,yy,fmt.	3-2	n.STOP.	3-22
ENPR,pppp,fmt.	3-3	Subsystem Control Commands	3-19
n.ENPR,pp.	3-3	SUPPRESSxx.	3-19
ENQP,pppp,fmt.	3-3	System Control Commands	3-22
n.ENQP,pppp.	3-3	TAFffff.	3-22
n.ENTL,tmlmt.	3-3	TELEX.	3-21
ERRLOG,.	3-2	TEMP=xx ₁ ,xx ₂ ,...,xx _n .	3-13
ERRLOG,xx.	3-2	TIME.hh.mm.ss.	3-26
EVICT,fmt.	3-8	TRAINxx,y.	3-18
n.EXPffff.	3-19	Transaction Subsystem Commands	3-29
FCNcc.	3-29	UNLOAD,xx.	3-12
FORMxx,fc.	3-2	UNLOCK.	3-25
FORMAT,xx.	3-13	UNSTEP.	3-27
FNCcc,xxxx.	3-29	UP,CHcc.	3-13
n.GO.	3-10	VALIDATE,xx.	3-13
H,x.	4-22	VSN,xx.	3-12
IAFffff.	3-20	VSN,xx,.	3-11
IANcc.	3-29	VSN,xx,vsn.	3-10
IDLE.	3-24	WARN.	3-10
n.IDLE	3-20	WARN,ccc...ccc.	3-10
IDLEFAMILY,xx	3-24	X.name.	3-25
INITIALIZE,xx,op.	3-13	X.name,xxxxx.	3-25
n.IO.	3-20	X.name(ccc...ccc)	3-25
Job Processing Control Commands	3-2	99.	3-27
K.ccc...ccc.	3-25	n.*ccc...ccc.	3-9
n.KILL.	3-9		

REVISION RECORD

REVISION	DESCRIPTION
A (06-15-75)	Manual released. This manual supports NOS 1.0 at PSR level 404.
B (03-08-76)	Manual revised to support NOS 1.1 at PSR corrective code level 419/420. This edition obsoletes all previous editions.
C (12-03-76)	Manual revised to support NOS 1.2 at PSR corrective code level 439 and to make editorial and technical corrections. New features documented in this manual include: support of NAM (Network Access Method), RBF (Remote Batch Facility), and TAF (Transaction Facility); 844-44 Disk Storage Subsystem; I/O queue and dayfile utilities QDUMP, QLOAD, QMOVE, and LDLIST; device types NP (2550 Host Communications Processor), LS (580-16 Line Printer), and LT (580-20 Line Printer); FORM and KILL commands; and detection of power/environmental failure. This edition obsoletes all previous editions.
D (07-15-77)	Manual revised to support NOS 1.2 at PSR corrective code level 452 and to make editorial and technical corrections. Support of CDC CYBER 171 is included. The S display is expanded to show service limits in addition to queue priorities. Error messages in appendix B are reformatted.
E (10-21-77)	Manual revised to support NOS 1.2 at PSR corrective code level 460 and to make editorial and technical corrections. Procedures to deadstart from a 669 tape unit using a 7152 tape/disk controller are included. The DIS command RE,xx. is removed.
F (05-17-78)	Manual revised to support NOS 1.3 at PSR corrective code level 472 and to make editorial and technical corrections. New features documented in this manual include: support of IAF (Interactive Facility) and CDCS (CDC CYBER Database Control System); command VALIDATE,xx.; 844 disk full tracking capability (device types DK for full track 844-21 and DL for full track 844-41/44); on-line reconfiguration of mass storage using the REDEFINE command (section 6) and mass storage configuration (E,C.) display; user capability to access ECS; detection of fatal mainframe errors (appendix G); and support of 677/679 magnetic tape units. References to the 841 disk drive, 512 line printer, and 657/659 magnetic tape units are removed. Former sections 5 (Permanent File Utilities) and 6 (Queue/Dayfile Utilities) have been removed and are contained in the System Maintenance Reference Manual. Operation Under DIS Control, formerly section 8, is now section 5. Machine Recovery Utility, formerly section 9, is now section 8. Section 7, Network Operator and Local Operator Commands, replaces comparable sections from the Administrator and Operator Facility Reference Manual. This edition obsoletes all previous editions.
G (08-25-78)	Manual revised to support NOS 1.3 at PSR level 477 and to make technical corrections. Changes are made to the following displays: CDC CYBER 170 Series Memory Check (section 2), E, T, H, Q, S, T, and MREC right screen command descriptions of DELAY, MESSAGE, and UNLOAD have changed.
H (12-22-78)	Manual revised to support NOS 1.3 at PSR level 485 and to make technical corrections.
Publication No. 60435600	

REVISION LETTERS I, O, Q AND X ARE NOT USED

© 1975, 1976, 1977, 1978, 1979, 1980

by Control Data Corporation

All Rights Reserved

Printed in the United States of America

Address comments concerning this manual to:

Control Data Corporation
Publications and Graphics Division
4201 North Lexington Avenue
St. Paul, Minnesota 55112

or use Comment Sheet in the back of this manual.

LIST OF EFFECTIVE PAGES

New features, as well as changes, deletions, and additions to information in this manual, are indicated by bars in the margins or by a dot near the page number if the entire page is affected. A bar by the page number indicates pagination rather than content has changed.

PAGE	REV	PAGE	REV	PAGE	REV	PAGE	REV	PAGE	REV
Front Cover	-	3-1	M	4-25	L	B-1	L	B-60	M
Inside Front Cover	M	3-2	L	4-26	K	B-2	M	B-61	M
Title Page	-	3-3	L	4-27	K	B-3	M	B-62	M
ii	L	3-4	M	4-28	J	B-4	M	B-63	M
ii-a/ii-b	M	3-5	M	4-29	J	B-5	M	B-64	M
iii	M	3-6	M	4-30	L	B-6	M	B-65	M
iv	M	3-7	M	4-31	L	B-7	M	B-66	M
v	M	3-8	M	4-32	M	B-8	M	B-67	M
vi	M	3-9	M	4-33	M	B-9	M	B-68	M
vii	M	3-10	L	4-34	L	B-10	M	B-69	M
viii	M	3-11	M	4-35	L	B-11	M	B-70	M
ix	M	3-12	M	4-36	M	B-12	M	B-71	M
1-1	M	3-13	M	4-37	J	B-13	M	B-72	M
1-2	M	3-14	M	4-38	M	B-14	M	B-73	M
1-3	M	3-15	M	4-39	L	B-15	M	B-74	M
1-4	M	3-16	M	4-40	J	B-16	M	B-75	M
2-1	M	3-17	M	5-1	L	B-17	M	B-76	M
2-2	M	3-18	M	5-2	L	B-18	M	B-77	M
2-3	M	3-19	M	5-3	L	B-19	M	B-78	M
2-4	L	3-20	M	5-4	M	B-20	M	B-79	M
2-5	M	3-21	M	5-5	J	B-21	M	B-80	M
2-6	M	3-22	M	5-6	L	B-22	M	B-81	M
2-7	M	3-23	M	5-7	M	B-23	M	B-82	M
2-8	M	3-24	M	5-8	M	B-24	M	B-83	M
2-9	M	3-25	M	5-9	M	B-25	M	B-84	M
2-10	M	3-26	M	5-10	L	B-26	M	B-85	M
2-11	M	3-27	M	5-11	J	B-27	M	B-86	M
2-12	M	3-28	M	6-1	M	B-28	M	B-87	M
2-13	M	3-29	M	6-2	M	B-29	M	B-88	M
2-14	M	3-30	M	6-3	M	B-30	M	B-89	M
2-15	M	3-31	M	6-4	M	B-31	M	B-90	M
2-16	M	3-32	M	6-5	M	B-32	M	B-91	M
2-17	M	3-33	M	6-6	M	B-33	M	B-92	M
2-18	M	3-34	M	6-7	M	B-34	M	B-93	M
2-19	M	3-35	M	6-8	M	B-35	M	B-94	M
2-20	M	4-1	L	6-9	M	B-36	M	B-95	M
2-21	M	4-2	L	7-1	L	B-37	M	B-96	M
2-22	M	4-3	L	7-2	L	B-38	M	B-97	M
2-23	M	4-4	M	7-3	L	B-39	M	B-98	M
2-24	M	4-5	L	7-4	M	B-40	M	B-99	M
2-25	M	4-6	L	7-5	M	B-41	M	B-100	M
2-26	M	4-7	M	8-1	L	B-42	M	B-101	M
2-27	M	4-8	L	8-2	J	B-43	M	B-102	M
2-28	M	4-9	J	8-3	K	B-44	M	B-103	M
2-29	M	4-10	J	8-4	L	B-45	M	B-104	M
2-30	M	4-11	J	8-5	K	B-46	M	B-105	M
2-31	M	4-12	J	A-1	M	B-47	M	C-1	L
2-32	M	4-13	M	A-2	M	B-48	M	C-2	M
2-33	M	4-14	M	A-3	J	B-49	M	C-3	M
2-34	M	4-15	M	A-4	J	B-50	M	D-1	M
2-35	M	4-16	M	A-5	J	B-51	M	D-2	M
2-36	M	4-17	K	A-6	J	B-52	M	D-3	L
2-37	M	4-18	L	A-7	J	B-53	M	D-4	L
2-38	M	4-19	L	A-8	M	B-54	M	D-5	L
2-39	M	4-20	M	A-9	M	B-55	M	D-6	L
2-40	M	4-21	J	A-10	M	B-56	M	D-7	L
2-41	M	4-22	M	A-11	M	B-57	M	D-8	L
2-42	M	4-23	J	A-12	M	B-58	M	D-9	L
		4-24	L	A-13	M	B-59	M	D-10	L

PAGE	REV	PAGE	REV	PAGE	REV	PAGE	REV	PAGE	REV
D-11	L								
D-12	L								
E-1	L								
F-1	L								
F-2	M								
G-1	M								
G-2	L								
H-1	M								
I-1	L								
J-1	M								
J-2	M								
J-3	M								
J-4	M								
J-5	M								
J-6	M								
J-7	M								
J-8	M								
Index-1	M								
Index-2	M								
Index-3	M								
Index-4	M								
Index-5	M								
Index-6	M								
Index-7	M								
Index-8	M								
Comment Sheet	M								
Inside Back Cover	L								
Back Cover	-								

PREFACE

This manual contains information necessary to establish and control operation of a CDC Network Operating System (NOS) Version 1.4 and is intended for use by the central site (system) operator. NOS was developed by Control Data Corporation to provide network capabilities for time-sharing and transaction processing, in addition to local and remote batch processing on CDC CYBER 170 Series; CDC CYBER 70 Series Models 71, 72, 73, and 74; computer systems; and 6000 Series Computer Systems.

Although all information contained in this manual is considered relevant and necessary for you, a substantial amount of the information requires that you are experienced and thoroughly familiar with the subject and its application with respect to system operation. For example, before you can use the commands described in section 5, Operation Under DIS Control, an installation may require that you have an overall understanding of NOS operation. Another installation may specify which DIS commands you can use, if any.

AUDIENCE AND ORGANIZATION

You are assumed to be familiar with the CYBER 170, CYBER 70, or 6000 Series computer systems and with operating system concepts in general.

If you have limited or no previous NOS experience, you are encouraged to read the following sections of this manual first.

Section 1	Introduction
Section 2	Deadstart: This section describes the process by which NOS is made operational and ready to process user jobs.
Section 3	Operation Under DSD Control: This section provides information concerning console operation and the DSD commands that form the primary operator interface to NOS. Cautions are included with the description of commands that should be used with extreme care or at the direction of the site analyst.
Section 4	DSD Displays: This section contains a description and illustration of the DSD displays that may be brought to the console screens to monitor system operation.
Appendix B	Operator Messages: This appendix contains a sorted listing of the status and error messages that are issued by NOS.
Appendix D	Peripheral Equipment Operation: This appendix contains information concerning the manual operation of each peripheral device associated with NOS.

Since the job requirements of the system operator may vary from one installation to another, this manual should be used in conjunction with established policies and procedures provided by the installation.

CONVENTIONS

Extended memory for the CYBER 170 Model 176 is large central memory extended (LCME). Extended memory for all other NOS computer systems is extended core storage (ECS) or extended semiconductor memory (ESM).

In this manual, the acronym ECS refers to all forms of extended memory unless otherwise noted. However, in the context of a multiframe environment or distributive data path (DDP) access, model 176 is excluded.

Programming information for the various forms of extended memory can be found in the COMPASS Reference Manual and in the appropriate computer system hardware reference manual. Hardware descriptions of the various forms of extended memory can be found in the following manuals.

<u>Control Data Publication</u>	<u>Publication Number</u>
Extended Semiconductor Memory Hardware Reference Manual	60455990
Extended Core Storage Reference Manual	60347100
Extended Core Storage II and Distributive Data Path Reference Manual	60430000

RELATED PUBLICATIONS

The NOS Manual Abstracts is a pocket-sized manual containing brief descriptions of the contents and intended audience of all NOS and NOS product manuals. The abstracts can be useful in determining which manuals are of greatest interest to a particular user.

Control Data also publishes a Software Release History Report of all software manuals and revision packets it has issued. This history lists the revision level of a particular manual that corresponds to the level of software installed at the site.

The following manuals contain additional information about NOS that may prove useful to you.

<u>Control Data Publication</u>	<u>Publication Number</u>	<u>Control Data Publication</u>	<u>Publication Number</u>
COMPASS Version 3 Reference Manual	60492600	Network Products Remote Batch Facility Version 1 Reference Manual	60499600
CYBER 70/Model 71 Computer System Hardware Reference Manual	60453300	Network Products Transaction Facility Version 1 Reference Manual	60455340
CYBER 70/Model 72 Computer System Hardware Reference Manual	60347000	NOS Version 1 Diagnostic Index	60455720
CYBER 70/Model 73 Computer System Hardware Reference Manual	60347200	NOS Version 1 Installation Handbook	60435700
CYBER 70/Model 74 Computer System Hardware Reference Manual	60347400	NOS Version 1 Manual Abstracts	84000420
CYBER 170/Models 171, 172, 173, 174, 175, 176 Computer Systems Hardware Reference Manual	60420000	NOS Version 1 Reference Manual, Volume 1	60435400
CYBER 170 Computer Systems Models 720, 730, 740, 750, and 760 Model 176 (Level B) Hardware Reference Manual	60456100	NOS Version 1 Reference Manual, Volume 2	60445300
Export/Import Reference Manual	60436200	NOS Version 1 System Maintenance Reference Manual	60455380
Extended Core Storage II and Distributive Data Path Reference Manual	60430000	NOS Version 1 Systems Programmer's Instant	60449200
Extended Core Storage Reference Manual	60347100	NOS Version 1 Time-Sharing User's Reference Manual	60435500
Extended Semiconductor Memory Hardware Reference Manual	60455990	On-Line Maintenance Software Reference Manual NOS Version 1	60454200
Network Products Communications Control Program Version 3 Reference Manual	60471400	Software Publications Release History	60481000
Network Products Interactive Facility Version 1 Reference Manual	60455250	TAF/TS Version 1 Reference Manual	60453000
Network Products Message Control System Version 1 Reference Manual	60480300	6400/6500/6600 Computer Systems Hardware Reference Manual	60100000
Network Products Network Access Method Version 1 Network Definition Language Reference Manual	60480000	7155 Disk Storage Subsystem Customer Trouble-Shooting Guide	60456650
Network Products Network Access Method Version 1 Reference Manual	60499500		

DISCLAIMER

This product is intended for use only as described in this document. Control Data cannot be responsible for the proper functioning of undescribed features or parameters.

CONTENTS

<p>1. INTRODUCTION 1-1</p> <p>Operator/System Communication 1-1</p> <p style="padding-left: 20px;">Operating the Keyboard 1-1</p> <p style="padding-left: 20px;">Special Characters 1-2</p> <p>2. DEADSTART 2-1</p> <p>Coldstart 2-1</p> <p style="padding-left: 20px;">Coldstart of Controllers for 667 or 669 Tape Units 2-1</p> <p style="padding-left: 40px;">Coldstart 7021/7152 Tape Controller from Card Reader 2-2</p> <p style="padding-left: 40px;">Coldstart 7152 Tape Controller from Tape Unit 2-2</p> <p style="padding-left: 20px;">Coldstart of Disk Controllers for 844 or 885 Disk Units 2-2</p> <p style="padding-left: 40px;">Coldstart 7054/7154/7152/7155 Disk Controller from Card Reader 2-2</p> <p style="padding-left: 40px;">Coldstart 7152/7155 Disk Controller from Disk Unit 2-3</p> <p style="padding-left: 20px;">Setting the Deadstart Panel 2-3</p> <p style="padding-left: 40px;">Panel Settings for Coldstart of Controller for 667 or 669 Tape Unit 2-4</p> <p style="padding-left: 40px;">Panel Settings for Coldstart of 7021/7152 Tape Controller from Card Reader 2-4</p> <p style="padding-left: 40px;">Panel Settings for Coldstart of 7152 Tape Controller from Tape Unit 2-5</p> <p style="padding-left: 20px;">Panel Settings for Coldstart of 844 or 885 Disk Controllers 2-5</p> <p style="padding-left: 40px;">Panel Settings for Coldstart of 7054/7154/7152/7155 Disk Controller from Card Reader 2-5</p> <p style="padding-left: 40px;">Panel Settings for Coldstart of 7152/7155 Disk Controller from Disk Unit 2-6</p> <p style="padding-left: 20px;">Loading CTI Module to Disk 2-6</p> <p style="padding-left: 20px;">Loading DDS Module to Disk 2-7</p> <p style="padding-left: 20px;">Warmstart 2-8</p> <p style="padding-left: 40px;">Panel Settings for Warmstart 2-11</p> <p style="padding-left: 20px;">Setting Word 13 2-12</p> <p style="padding-left: 40px;">Selecting the CMRDECK 2-12</p> <p style="padding-left: 40px;">Selecting the Deadstart Parameters 2-12</p> <p style="padding-left: 40px;">Selecting the Deadstart Level 2-13</p> <p style="padding-left: 20px;">Keyboard Entries 2-14</p> <p style="padding-left: 20px;">Initiating Deadstart Process 2-14</p> <p style="padding-left: 40px;">Selecting CTI Initial Options (*A*) Display 2-14</p> <p style="padding-left: 60px;">OS Load Automatic (CR) Option 2-15</p> <p style="padding-left: 60px;">Operator Intervention O Option 2-17</p> <p style="padding-left: 60px;">Utilities U Option 2-22</p> <p style="padding-left: 20px;">Modifying the CMRDECK 2-25</p> <p style="padding-left: 20px;">Modifying the IPRDECK 2-27</p> <p style="padding-left: 20px;">Initializing the System 2-28</p> <p style="padding-left: 20px;">Initiating Job Processing 2-28</p> <p style="padding-left: 20px;">Responding to CYBERLOG Displays 2-29</p> <p style="padding-left: 40px;">Event Type Entries 2-29</p> <p style="padding-left: 40px;">Reason Entries 2-30</p> <p style="padding-left: 40px;">Component Entries 2-30</p> <p style="padding-left: 40px;">Elapsed Time Entries 2-30</p> <p style="padding-left: 40px;">Lost Time Entries 2-33</p> <p style="padding-left: 40px;">Impact Entries 2-33</p> <p style="padding-left: 40px;">Edit Entries 2-34</p>	<p style="padding-left: 20px;">Preparing for Recovery Deadstart 2-35</p> <p style="padding-left: 40px;">Level 3 Recovery 2-36</p> <p style="padding-left: 40px;">Level 1 Recovery 2-36</p> <p style="padding-left: 40px;">Level 2 Recovery 2-37</p> <p style="padding-left: 40px;">Level 0 Deadstart 2-37</p> <p style="padding-left: 20px;">Error Processing 2-37</p> <p>3. OPERATION UNDER DSD CONTROL 3-1</p> <p style="padding-left: 20px;">Dayfile Commands 3-1</p> <p style="padding-left: 20px;">Job Processing Control Commands 3-2</p> <p style="padding-left: 20px;">Peripheral Equipment Control Commands 3-10</p> <p style="padding-left: 20px;">BATCHIO Equipment Commands 3-18</p> <p style="padding-left: 20px;">Subsystem Control Commands 3-19</p> <p style="padding-left: 20px;">System Control Commands 3-22</p> <p style="padding-left: 20px;">Memory Entry Commands 3-27</p> <p style="padding-left: 20px;">Channel Control Commands 3-28</p> <p style="padding-left: 20px;">Transaction Subsystem Commands 3-29</p> <p style="padding-left: 40px;">Initialization K Display Options 3-29</p> <p style="padding-left: 40px;">Normal Running Display (K Display) 3-30</p> <p style="padding-left: 40px;">Run Time K Display Commands 3-30</p> <p style="padding-left: 20px;">MSS K Display 3-32</p> <p style="padding-left: 20px;">RBF K Display 3-34</p> <p style="padding-left: 40px;">Description of Header Line Fields 3-34</p> <p>4. DSD DISPLAYS 4-1</p> <p style="padding-left: 20px;">Display Selection 4-1</p> <p style="padding-left: 20px;">Display Screen Headers 4-2</p> <p style="padding-left: 20px;">Dayfile (A) Displays 4-2</p> <p style="padding-left: 20px;">Job Status (B) Display 4-7</p> <p style="padding-left: 20px;">Storage (C, D, F, G, M) Displays 4-8</p> <p style="padding-left: 20px;">Equipment Status (E) Displays 4-13</p> <p style="padding-left: 40px;">EST (E., or E.A.) Display 4-13</p> <p style="padding-left: 40px;">Mass Storage Configuration (E,C.) Display 4-13</p> <p style="padding-left: 40px;">Mass Storage Status (E,M.) Display 4-16</p> <p style="padding-left: 40px;">Resource Mounting Preview (E,P.) Display 4-17</p> <p style="padding-left: 40px;">Tape Status (E,T.) Display 4-17</p> <p style="padding-left: 20px;">File Name Table (H) Display 4-22</p> <p style="padding-left: 20px;">BATCHIO (I) Display 4-24</p> <p style="padding-left: 20px;">Control Point Status (J) Display 4-24</p> <p style="padding-left: 20px;">Central Programmable (K and L) Displays 4-24</p> <p style="padding-left: 20px;">File (N) Display 4-27</p> <p style="padding-left: 20px;">Transaction Status (O) Display 4-27</p> <p style="padding-left: 40px;">Task Library Directories (O,TA.) Display 4-27</p> <p style="padding-left: 40px;">Transaction Terminal Status (O,TR.) Display 4-27</p> <p style="padding-left: 40px;">Subcontrol Point Status (O,SU.) Display 4-30</p> <p style="padding-left: 20px;">PP Communications Area (P) Display 4-30</p> <p style="padding-left: 20px;">Active Job Queues (Q) Display 4-32</p> <p style="padding-left: 20px;">Export/Import Status (R) Display 4-32</p> <p style="padding-left: 20px;">System Control Information (S) Display 4-35</p> <p style="padding-left: 20px;">Time-Sharing Status (T) Display 4-36</p> <p style="padding-left: 20px;">Monitor Functions (Y) Display 4-39</p> <p style="padding-left: 20px;">Directory (Z) Display 4-39</p> <p>5. OPERATION UNDER DIS CONTROL 5-1</p> <p style="padding-left: 20px;">DIS Dayfile (A) Display 5-2</p> <p style="padding-left: 20px;">DIS Job Status (B) Display 5-3</p>
--	--

DIS Memory Displays	5-4	7. NETWORK AND LOCAL OPERATOR	
DIS Directory (Z) Display	5-6	COMMANDS	7-1
Console Operation	5-7		
Display Selection Commands	5-8	NAM Initialization Commands	7-1
DIS Keyboard Entries	5-9	Becoming a Network/Local Operator	7-1
Memory Entry Commands	5-10	NOP/LOP Command Syntax	7-2
PP Call Commands	5-11	Network Element Status Codes	7-2
		Network Operator Commands	7-2
		Local Operator Commands	7-4
6. MASS STORAGE UTILITIES	6-1		
On-Line Reconfiguration (REDEFINE)	6-1	8. MACHINE RECOVERY UTILITY	8-1
On-Line Track Reservation (FLAW)	6-7		
		MREC Procedures	8-1
		MREC Unit and Controller Reservations	8-4

APPENDIXES

A. CHARACTER SETS	A-1	G. EXAMPLE OF END-OF-OPERATION SHUT-	
B. OPERATOR MESSAGES	B-1	DOWN	G-1
C. GLOSSARY	C-1	H. PP CONFIGURATION	H-1
D. PERIPHERAL EQUIPMENT OPERATION	D-1	I. NETWORK FAILURE PROCESSING	I-1
E. MULTIMAINFRAME OPERATION	E-1	J. MAINFRAME RECONFIGURATION	J-1
F. S/C REGISTER ERROR DETECTION	F-1		

INDEX

FIGURES

1-1 Console Keyboard	1-2	2-25 Install CTI or RMS Display	2-25
2-1 CYBER 170 Series Deadstart Panel	2-3	2-26 CYBERLOG Display for Type of Event	2-29
2-2 CYBER 70/6000 Series Deadstart Panel	2-3	2-27 CYBERLOG Display for Scheduled Event	2-30
2-3 Coldstart of 7021/7152 Tape		2-28 CYBERLOG Display for Unscheduled Event	2-31
Controller from Card Reader	2-4	2-29 CYBERLOG Display for Unscheduled Event	
2-4 Coldstart of 7152 Tape Controller		Caused by Other	2-31
from Tape Unit	2-5	2-30 CYBERLOG Display for Unscheduled Event	
2-5 Coldstart of Disk Controller from		Caused by Hardware	2-31
Card Reader	2-5	2-31 CYBERLOG Display for Unscheduled Event	
2-6 Coldstart of 7152/7155 Disk Controller		Caused by Software	2-32
from Disk Unit	2-6	2-32 CYBERLOG Display for Unscheduled Event	
2-7 CTI Initial Options (*A*) Display	2-7	Caused by Communications	2-32
2-8 Utilities (*U*) Display	2-7	2-33 CYBERLOG Display Request for Elapsed	
2-9 I Option	2-7	Time	2-32
2-10 Warmstart	2-9	2-34 CYBERLOG Display Request for Lost Time	2-33
2-11 Set Correct Option to CTI Displays	2-10	2-35 CYBERLOG Display Request for Impact	2-33
2-12 CYBER 170 Series Panel Settings for		2-36 Sample Completed CYBERLOG Entry	2-34
Warmstart from Channel with an		3-1 Record of Original Values in S Display	3-5
Active PP (For Example, Channel 1,		3-2 Record of Original Values	3-5
2, or 11)	2-11	3-3 Record of Original Values in S Display	3-8
2-13 CYBER 70 and 6000 Series Panel		3-4 K Display for INITIALIZE Command	3-15
Settings for Warmstart from Channel		3-5 K Display	3-30
with an Active PP (For Example,		3-6 MSS K Display	3-33
Channel 1, 2, or 11)	2-11	3-7 RBF K Display	3-34
2-14 Panel Setting for Warmstart from		4-1 System Dayfile (A) Display	4-4
Channel with No Active PP (For		4-2 Account Dayfile (A) Display	4-5
Example, Channel 0, 12, or 13)	2-11	4-3 Error Log Dayfile (A) Display	4-6
2-15 CTI Initial Options (*A*) Display	2-15	4-4 Job Status (B) Display	4-7
2-16 CYBER 170 Series Memory Check	2-16	4-5 Central Memory (C) Display	4-10
2-17 CYBER 70 Series Memory Check	2-16	4-6 Central Memory (F) Display	4-11
2-18 6000 Series Memory Check	2-16	4-7 ECS Memory (M) Display	4-12
2-19 Operator Intervention (*O*) Display	2-17	4-8 Equipment Status (E., or E,A.) Display	4-14
2-20 D Option	2-17	4-9 Mass Storage Configuration (E,C.) Display	4-15
2-21 Hardware Reconfiguration (*H*) Display	2-19	4-10 Mass Storage Status (E,M.) Display	4-18
2-22 Deadstart Panel Params (*P*) Display	2-20	4-11 Resource Mounting Preview (E,P.) Display	4-19
2-23 Utilities (*U*) Display	2-22	4-12 Tape Status (E,T.) Display	4-21
2-24 Alternate Deadstart Display	2-22	4-13 File Name Table (H) Display	4-23

4-14	BATCHIO Status (I) Display	4-25	4-25	Directory (Z) Display	4-40
4-15	Control Point Status (J) Display	4-26	5-1	DIS Dayfile (A) Display	5-2
4-16	Task Library Directories (O,TA.) Display	4-28	5-2	DIS Job Status (B) Display	5-3
4-17	Transaction Terminal Status (O,TR.) Display	4-29	5-3	DIS Data Storage (F) Display	5-4
4-18	Subcontrol Point Status (O,SU.) Display	4-30	5-4	DIS Program Storage (G) Display	5-5
4-19	PP Communications Area (P) Display for a CYBER 170	4-31	5-5	DIS Directory (Z) Display	5-6
4-20	Active Job Queues (Q) Display	4-33	6-1	REDEFINE K Display	6-2
4-21	Export/Import Status (R) Display	4-34	6-2	Reconfiguration Run Output	6-3
4-22	System Control Information (S) Display	4-37	6-3	FLAW Utility K Display	6-8
4-23	Time-Sharing Status (T) Display	4-38	6-4	Right Screen FLAW Utility K Display	6-9
4-24	Monitor Functions (Y) Display	4-39	8-1	Machine Configurations	8-1
			8-2	MREC Left Screen K Display	8-2
			8-3	MREC Right Screen K Display	8-3

TABLES

1-1	Special Characters	1-3	3-2	Track Flawing Options	3-16
2-1	Keyboard Entries for the *H* Display	2-17	6-1	Equipment Requirements for Reconfiguration	6-1
2-2	Keyboard Entries for the *P* Display	2-19	6-2	Reconfiguration Parameters	6-4
2-3	CMRDECK Entries	2-24	6-3	Reconfiguration Commands	6-5
2-4	Levels of System Deadstart	2-35	8-1	MREC Options	8-4
2-5	Mass Storage Device Recovery	2-38	8-2	MREC Commands	8-4
3-1	Device Definition Options	3-15			

NOS provides four types of job processing.

Local batch processing

The user enters jobs at the central site and the system processes them using only the central site peripheral equipment attached to the computer.

Remote batch processing

The user enters jobs from remotely located CDC 200 User Terminals, CDC 731-12/732-12/734 Remote Batch Terminals, or CDC CYBER 18-05 Remote Batch Terminals.

Deferred batch processing

The user submits jobs entered from an interactive terminal or another batch job to the batch queue for processing; their output can be routed to user-specified peripheral equipment or remote batch locations.

Interactive terminal processing

The user enters jobs from an interactive network terminal or a time-sharing terminal.

NOS can operate on many different hardware configurations. Refer to the NOS Installation Handbook for general information concerning system configurations.

OPERATOR SYSTEM COMMUNICATION

Both NOS and the programs running under NOS use the display screen to bring information to your attention. You can respond to or instruct the operating system by entering information via the console keyboard.

Two NOS routines, DSD and DIS, provide the interface between the console hardware and other system software. They maintain a current display of system or job status and process commands you type at the keyboard. DSD is the system display routine; information pertaining to all jobs appears on the screen. DIS is the job display routine; the screen shows data from a single job only. DSD has control of the console until you initiate DIS.

At all times DSD occupies PP1, one of the 7 to 20 peripheral processor units in the system. PP0 always contains the system monitor routine MTR which oversees system activities. DIS resides in a PP assigned by the system at the time it is called.

Under DSD, the normal operating mode, you can communicate with the system or any of the jobs under system control. Once a job begins execution, however, you can only respond to job requests for equipment assignment or other actions, change priority or field length, or stop execution permanently or temporarily.

In contrast, DIS operating mode provides more control of job execution. You must advance each control statement in the job. Since you can add control statement instructions from the keyboard, the job need not execute exactly as it entered the system. Commands to DIS include those that allow changes in register contents shown in the exchange package, as well as those that control such items as field length or time limit.

You can use the DIS capability for entering control statements to perform utility tasks or dump permanent files. DIS is used most often by system analysts. Section 5 details procedures for using DIS.

OPERATING THE KEYBOARD

Figure 1-1 shows the keyboard on a CYBER 170 Series console. The PRESENTATION CONTROL switch, located to the right of the spacebar, allows selection of a left screen display only, a right screen display only, or both left and right screen displays of reduced size on a split screen. When in the LEFT position, only those displays referred to in the following sections as left screen displays appear. Only those referred to as right screen displays appear when the switch is in the RIGHT position. A split screen showing both the left and right displays appears when the switch is in the middle or MAINTENANCE position. If a 6612 dual screen display console is used, the requested displays appear simultaneously on the left and right screens, respectively; there is no PRESENTATION CONTROL switch on the keyboard.

Each keyboard entry to DSD is a single line usually ending with a period. As you enter characters from the console, the system displays the accumulated entry on the lower left portion of the left display screen. When you press the carriage return (CR) key, a command is examined for legality. If acceptable, the system processes the command and clears the keyboard entry. If the command is not acceptable, an error message appears above the entry. Then press either the erase key (left blank key) which clears both the command entered and the error message, or the backspace (BKSP) key which deletes only the last character displayed. Use the BKSP key to delete the entry to the position of the error and enter the correction.

You can use the keyboard to initiate and control equipment assigned and job progress. DSD processes keyboard entry of commands as follows: as you type each character at the console, DSD checks the accumulated entry for a match against the table of possible commands. When DSD has received enough characters to recognize the command, it automatically fills in the remaining portion of the command. In general, DSD fills in the rest of the command after three to five characters have been entered. If the character entered is not within the legal range, or not recognized as part of a legal command, it is rejected and not displayed.

Example:

To request that the error log dayfile be displayed on the left console screen, the appropriate DSD command is A,ERROR LOG. Begin by typing A. DSD checks this input but cannot recognize the command since eight other commands also begin with the letter A. Then enter the comma (,). Because four other commands also begin with these characters, DSD still cannot recognize the command. However, when you enter E, the command becomes unique and DSD fills in the remainder of the entry on the display (RROR LOG.). If you do not wait for DSD to complete the command, but continue to type in the remaining characters yourself, those characters are ignored.

DSD signals that a keyboard entry is complete by intensifying individual characters in rotation. At this time, press the CR key. DSD checks the command and begins processing if it is found to be acceptable. If the command is processed successfully, it is erased from the display screen. However, if DSD must wait for a resource to become available (such as a channel), or if the command was not acceptable, one of the following messages is displayed above the command.

ILLEGAL ENTRY.

Command not recognized by DSD. Correct or reenter the command.

DISK BUSY.

DSD is waiting for an overlay to be loaded from a mass storage device.

PPU BUSY.†

DSD is waiting for a PP to be assigned so that it can process a command.

MTR BUSY.†

DSD is waiting for a response from the system.

If such a message persists for any length of time, terminate the entry by pressing the erase or BKSP key.

SPECIAL CHARACTERS

In addition to the command entries, the keys listed in table 1-1 have special meaning to DSD.

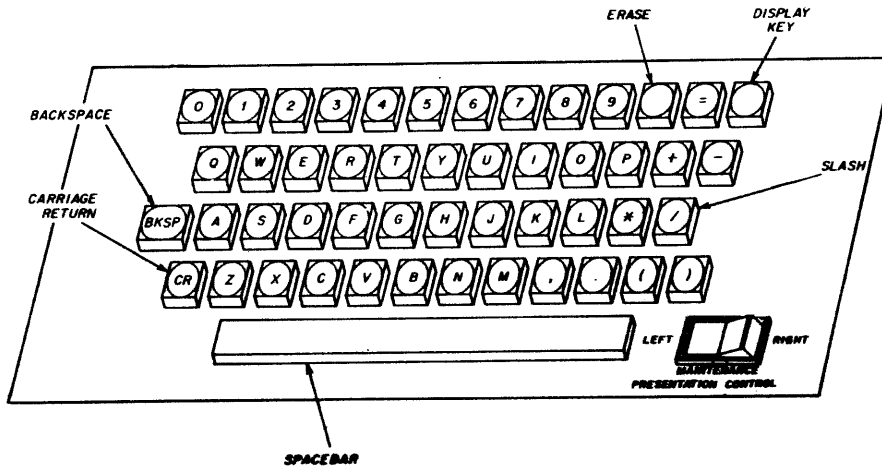

Figure 1-1. Console Keyboard

† If the message is preceded by LOG -, the command has been executed but not yet logged in the system dayfile and/or error log. (Refer to DSD Commands, in section 3.)

TABLE 1-1. SPECIAL CHARACTERS

Key Identifier	Name	Action Initiated		
*	Asterisk	Alternates display control between DSD and DIS each time the key is pressed.		
=	Equals	Alternates left screen memory display (C, D, F, G, or M) between absolute locations and those relative to a control point each time the key is pressed. However, unless a control point memory display is currently selected (refer to Storage Displays in section 4), only absolute locations are displayed. That is, pressing the = key has no effect unless you select the control point memory display.		
+	Plus	Advance left screen display as follows:		
		Memory displays (C, D, F, G, M)	Advances display address by 40 octal locations.	
		E, A display	Advances to next page of equipment status display.	
		H display	Advances to next page of FNT display.	
		N display	Advances file displayed by one-half of a sector.	
		P display	Advances to next page of P display.	
		R, T displays	Advances to next page of R or T display.	
		A, J, K, L displays	Advances control point number.	
		-	Minus	Changes left screen display as follows:
				Memory displays (C, D, F, G, M)
E, A display	Advances equipment status display by one page.			
H display	Advances FNT display by one page.			
N display	Backspaces file displayed by one-half of a sector.			
P display	Decrements P display by one page or displays alternate bank of PPs on a system with more than 10 PPs; does nothing if there are 10 or fewer PPs.			
R, T displays	Decrements R or T display by one page.			
A, J, K, L displays	Decrements control point number.			
(Left parenthesis	Advances right screen display as described for + (plus) character.		
)	Right parenthesis	Changes right screen display as described for - (minus) character.		
/	Slash	Advances left screen memory display by the value in the lower 18 bits of the first word displayed.		

TABLE 1-1. SPECIAL CHARACTERS (Contd)

Key Identifier	Name	Action Initiated
none	Right blank	Advances the left screen display sequence established by SET,ssss command (refer to section 4).
CR	Carriage return	Initiates processing of an entered command. If CR is pressed before the command is entered, the repeat entry flag is set; message REPEAT ENTRY is displayed on the error message line of the left screen. The subsequent command entry is processed but is not erased after completion. That command is processed each time CR is pressed. To clear the repeat entry mode, press the left blank (erase) key.
none	Left blank	Clears current keyboard entry and any resultant error messages.
BKSP	Backspace	Deletes last character displayed and clears error message (if one exists).

Deadstart is the process that makes the system operational and ready to process jobs. System deadstart requires a certain amount of your intervention. The deadstart process is initiated by momentarily activating the deadstart switch. The recommended procedure is to press the deadstart button on the console.

This manual assumes that a deadstart file exists and is configured to meet site requirements. The deadstart file is on a reel of magnetic tape or a disk pack and contains the programs necessary to establish the operating system and its products (such as BASIC, FORTRAN, COMPASS, and so forth) on the system equipment. The same deadstart file can be used for any supported equipment configuration.

In general, the procedure you use most often to deadstart is warmstart. Warmstart from mass storage or a CDC 667/669 Magnetic Tape Unit is possible after the disk controller or tape controller to be used is loaded with the proper controlware and the controlware is functioning. Warmstart is always possible from CDC 677/679 Magnetic Tape Units.

There are three preliminary procedures that might be required before performing warmstart.

1. Coldstart

Loads the tape and/or disk controlware to their respective controllers.

2. Loading CTI module to disk

Loads the common testing and initialization (CTI) module to disk. Doing this procedure enables you to perform warmstart from mass storage and to run the off-line maintenance system.

3. Loading DDS module to disk

Loads the deadstart diagnostic sequencer (DDS) module to disk. Doing this procedure enables you to run the DDS tests at deadstart time.

If coldstart is required, you must do it before any other procedure. Loading the CTI module and the DDS module to disk are optional procedures which each installation may decide to perform in order to enable the features they provide.

NOTE

Attempts to perform deadstart from mass storage could be unsuccessful in configurations with shared access to controllers and drives. Conflicts can arise in both single and multiple mainframe configurations. In a multimainframe configuration, if another mainframe has reserved the controller or drive, deadstart delays momentarily until the reservation is released. In a single mainframe configuration, if another channel has reserved the drive, deadstart will be unsuccessful. In this case, set the deadstart panel for the other channel.

The following subsections explain these procedures in more detail. If the procedures are not required, skip to the subsection entitled Warmstart.

COLDSTART

The coldstart procedures outlined here load the tape and disk controllers with controlware. The tape controlware can be loaded from a card reader or a tape unit depending on the type of controller.

The CDC 7021 Tape Controller for a 667/669 tape unit requires controlware loaded from a card reader. The 7152 tape controller requires controlware loaded from either a card reader or a tape unit.

The CDC 7054 and 7154 Disk Controllers require controlware loaded from a card reader. The controlware for a 7152 disk controller and the 7155 disk controller (CDC 844-4x and 885 Disk Storage Units) can be loaded from either a card reader or a disk unit.

The following paragraphs summarize the procedures needed to perform coldstart. You can use the appropriate summary as a checklist during deadstart. Detailed descriptions of all procedures in the deadstart process are provided throughout the remainder of this section.

This manual assumes that power is applied on all required equipment and that the equipment is functioning properly. If at any time the system loses power or the equipment fails, consult the site analyst or customer engineer.

COLDSTART OF CONTROLLERS FOR 667 OR 669 TAPE UNITS

Coldstart is necessary when deadstarting from 667 or 669 magnetic tape units if the controlware has not yet been loaded to the controller. The coldstart procedure contains a special program that reads the tape controller controlware, loads it to the controller, and then loads the deadstart tape.

The following procedure, Coldstart 7021/7152 Tape Controller from Card Reader, can be used to load either the 7021 or the CDC 7152 Tape Controller. The procedure coldstart from tape unit can be used to load only the 7152 controller.

Use the warmstart procedure once the controlware has been loaded and is functioning properly. Following coldstart from a card reader, the system loads the deadstart tape automatically, and warmstart is used for subsequent deadstarts only. However, following coldstart from a tape unit, a warmstart must be performed to load the system deadstart tape.

It is advisable to reset the deadstart panel (refer to Setting the Deadstart Panel) for a warmstart immediately after a coldstart if the controlware has been loaded successfully. After initial loading of the controlware, there is no reason to perform a coldstart again if the tape subsystem is operating correctly.

Coldstart 7021/7152 Tape Controller from Card Reader

The following steps summarize the procedures necessary to coldstart a 7021 or 7152 tape controller from a card reader. Use this as a checklist during coldstart. Ensure that the tape unit on which the deadstart tape is to be mounted and the card reader are on different channels. The card reader must be on a channel without a PP (for example, channel 12 or 13).

1. Ensure that required mass storage devices have packs mounted and/or are available.
2. Mount the deadstart tape (refer to appendix D for operating instructions).
 - a. Ensure that the write enable ring is not on the reel.
 - b. Mount the tape and ready the unit.
3. Set the deadstart panel for a coldstart from a card reader (refer to figure 2-3). Set MODE switch to LOAD.
4. Press the deadstart switch.
5. Insert card deck† in card reader and activate card reader as follows:
 - a. Press MOTOR POWER.
 - b. Select AUTO MODE.
 - c. Press RELOAD MEMORY.
 - d. Press READY.
6. Continue with the deadstart process by selecting CTI options as described under Selecting CTI Initial Options (*A*) Display later in this section.

Coldstart 7152 Tape Controller from Tape Unit

The following steps summarize the procedures necessary to coldstart a 7152 tape controller from a 669 tape unit. (Coldstart from a 667 tape unit is not possible.) Use this as a checklist during coldstart. Ensure that the 669 tape unit is set to a unit number between 10 and 17. The unit must be on a channel without a PP (for example, channel 12 or 13).

1. Mount the controlware tape on the tape unit to be specified on the deadstart panel (refer to appendix D for operating instructions).
 - a. Ensure that write enable ring is not on reel.
 - b. Mount the tape and ready the unit.
2. Set the deadstart panel for a coldstart from tape unit (refer to figure 2-4). Set MODE switch to LOAD.
3. Press the deadstart switch. No display appears on the console. Unloading of the controlware tape indicates the controlware has been loaded successfully.
4. Perform warmstart to complete the deadstart operation.

COLDSTART OF DISK CONTROLLERS FOR 844 OR 885 DISK UNITS

Coldstart is necessary when deadstarting from 844 or 885 disk units if the controlware has not yet been loaded to the controller. The coldstart procedure contains a special program that reads the disk controller controlware, loads it to the controller, and then loads the deadstart file.

The following procedure, Coldstart 7054/7154/7152/7155 Disk Controller from Card Reader, can be used to load all disk controllers. If the maintenance software library (MSL) is available at your site, the next procedure, Coldstart 7152/7155 Disk Controller from Disk Unit, can be used to load the 7152 disk controller and the 7155 disk controller.

Use the warmstart procedure once the controlware has been loaded and is functioning properly. Following coldstart from a card reader, the system loads the deadstart tape automatically, and warmstart is used for subsequent deadstarts only.

It is advisable to reset the deadstart panel (refer to Setting the Deadstart Panel) for a warmstart immediately after a coldstart if the controlware has been loaded successfully. After initial loading of the controlware, there is no reason to perform a coldstart again if the disk subsystem is operating correctly.

Coldstart 7054/7154/7152/7155 Disk Controller from Card Reader

The following steps summarize the procedures necessary to coldstart a disk controller from a card reader. Use this as a checklist during coldstart. Ensure that the card reader and disk unit on which the deadstart device is mounted are on different channels. The card reader must be on a channel without a PP (for example, channel 12 or 13).

1. Ensure that required mass storage devices have packs mounted and/or are available.
2. Mount the deadstart disk unit if using an 844 disk unit (refer to appendix D for operating instructions).
3. Set the deadstart panel for a coldstart from a card reader using 844 or 885 disk units (refer to figure 2-5). Set MODE switch to LOAD.
4. Press the deadstart switch.
5. Insert card deck† in card reader and activate card reader as follows:
 - a. Press MOTOR POWER.
 - b. Select AUTO MODE.
 - c. Press RELOAD MEMORY.
 - d. Press READY.
6. Continue with the deadstart process by selecting CTI options as described under Selecting CTI Initial Options (*A*) Display later in this section.

† For detailed information on the controlware deck, refer to the NOS Installation Handbook.

Coldstart 7152/7155 Disk Controller from Disk Unit

If controlware is loaded on a disk unit,† use the following procedure to perform deadstart. The following steps summarize the procedures necessary to perform coldstart from a disk unit. Use this as a checklist during coldstart.

1. Ensure that required mass storage devices have packs mounted and/or are available.
2. Mount the deadstart disk unit if using an 844 disk unit (refer to appendix D for operating instructions).
3. Set the deadstart panel for coldstart from a disk unit (refer to figure 2-6). Set MODE switch to LOAD.
4. Press the deadstart switch.
5. Continue with the deadstart process by selecting CTI options as described under Selecting CTI Initial Options (*A*) Display later in this section.

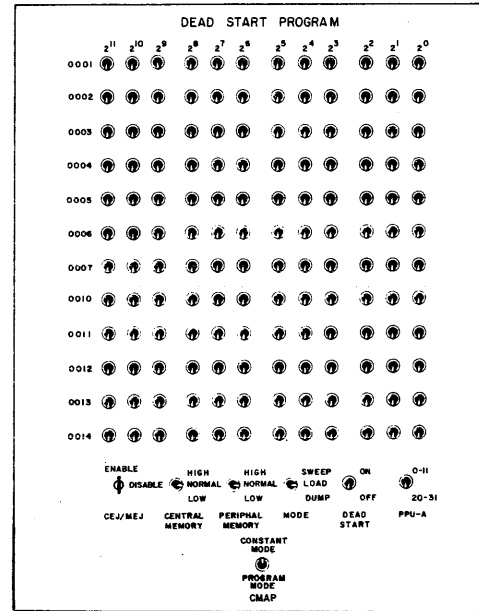

Figure 2-2. CYBER 70/6000 Series Deadstart Panel

SETTING THE DEADSTART PANEL

The CYBER 170 Series deadstart panel (figure 2-1) contains a 16-by-12 matrix of toggle switches. Its rows are numbered from 1 through 20 octal. The CYBER 70 Series and 6000 Series deadstart panel (figure 2-2) is a 12-by-12 matrix containing rows numbered from 0001 through 0014 octal. Each row of switches represents a 12-bit PP instruction word in the deadstart program. Thus, by setting these switches in a prescribed manner, you create the program necessary to deadstart. This program is subsequently loaded into PPO memory and executed whenever the deadstart switch is activated.

The function of the deadstart program is as follows:

- Identifies the tape/disk unit, controller, and channel number to be used to access the deadstart device (specified in words 1 through 10).
- Reads the first record from the deadstart file. The function of this routine is to initiate processing the remainder of the deadstart file according to the options specified on the deadstart panel (word 13).

In the following illustrations of the deadstart panel, the switch positions indicated by a 1 (switch in up position) or a 0 (switch in down position) are mandatory settings. However, the switch positions for fields represented by alphabetic characters are determined by each installation. Each of these fields is described in the topics that follow.

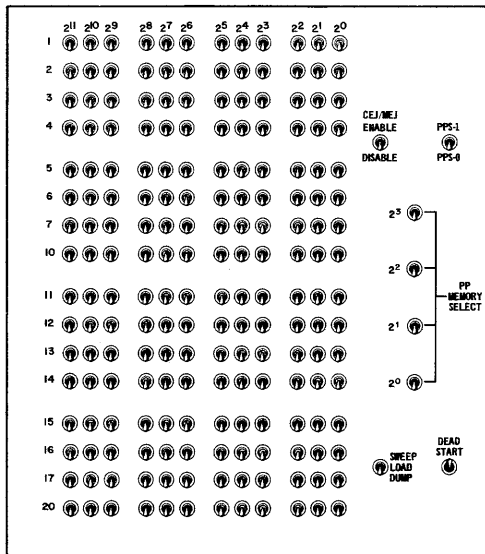

Figure 2-1. CYBER 170 Series Deadstart Panel

NOTE

Before activating the deadstart switch (on console or deadstart panel), ensure that the maintenance switch (labeled MODE in figure 2-2) on the deadstart panel is set to the LOAD position.

The CMAP option, if available, should be set to CONSTANT MODE.

For CYBER 70 and 6000 Series, the CEJ/MEJ key must be turned fully counterclockwise to enable CEJ/MEJ. The key is turned fully clockwise to disable CEJ/MEJ.

†Refer to a customer engineer for further information on loading controlware to the disk.

By default, the CEJ/MEJ option is logically enabled. If there is no CEJ/MEJ switch or if the CEJ/MEJ switch is physically set to the disable position on the deadstart panel, and you do not logically disable it via the *H* display (refer to Operator Intervention O Option later in this section), the following error message display results after the final CR is pressed for the CTI options.

CEJ/MEJ OPTION NOT ENABLED

FOR CEJ/MEJ USAGE, ENABLE SWITCH
ON DEADSTART PANEL AND DEADSTART

(CR) FOR NON CEJ/MEJ USAGE

If you wish to use the CEJ/MEJ option, enable the switch on the deadstart panel and deadstart again. Press CR if you do not want to use the CEJ/MEJ option.

This display appears also if there is a hardware failure of the CEJ/MEJ switch and it has not been logically disabled.

Panel settings for coldstart of tape and disk controllers are described in the next two subsections. A later subsection describes the panel settings for word 13 of the deadstart panel.

PANEL SETTINGS FOR COLDSTART OF CONTROLLER FOR 667 OR 669 TAPE UNIT

Panel Settings for Coldstart of 7021/7152 Tape Controller from Card Reader

The specific function of the deadstart program during coldstart from a card reader is as follows:

- Identifies the controller and channel number used to access the card reader from which the controlware is to be read. Also specifies the controller, channel, and unit number of the tape unit on which the deadstart tape is mounted.
- Reads the controlware card deck. The function of this deck is to load the tape controller. Processing of the deadstart tape according to the options specified on the deadstart panel is then initiated.

The equipment necessary for the devices used during coldstart is identified by setting the switches shown in the unshaded area of the deadstart panel illustrated in figure 2-3. This includes the channel number and controller associated with the card reader and the channel, controller, and unit number of the tape unit.

The tape unit on which the deadstart tape is mounted and the card reader must be on different channels. The card reader must be on a channel without a PP (for example,

channel 12 or 13). Refer to appendix H to determine the channels without a PP at your site.

	Binary				Octal†
1	111	101	1cc	ccc	75cc
2	111	111	0cc	ccc	77cc
3	fff	000	000	000	f000
4	000	000	000	000	0000
5	111	111	0cc	ccc	77cc
6	001	100	000	000	1400
7	111	100	0cc	ccc	74cc
10	111	001	0cc	ccc	71cc
11	111	110	110	100	7664
12	000	000	0tt	ttt	00tt
13	xxx	ppp	xxx	xxx	rpxx
14	eee	010	1uu	uuu	e2uu

Figure 2-3. Coldstart of 7021/7152 Tape Controller from Card Reader

cc ccc	Represents the channel number used to access the card reader from which the controlware is to be read.
fff	Represents the controller number to which the card reader is connected.
tt ttt	Represents the channel number used to access the deadstart tape equipment.
u uuu	Represents the physical unit number of the tape unit on which the deadstart tape is mounted.
eee	Represents the controller number to which the tape unit is connected.
xxx xxx ††	Represents the CMR number.
ppp ††	Represents the deadstart parameters.
rrr ††	Represents the deadstart level.

The numbers are entered in binary form; each switch represents one bit in a 12-bit PP instruction word.

Refer to Setting Word 13 later in this section for detailed information on word 13 parameters.

In general, you should reset the deadstart panel for a warmstart immediately after a coldstart from a card reader if the controlware has been loaded successfully. If the tape subsystem is functioning properly, there is no need to perform another coldstart after initial loading of the controlware.

† In many cases, the range of the third octal digit is restricted by the setting of the 2⁵ (and sometimes 2⁴) bit.

†† The instruction for setting the bits represented by these parameters are given in Setting Word 13.

Panel Settings for Coldstart of 7152 Tape Controller from Tape Unit

The specific function of the deadstart program during coldstart from a tape unit is as follows:

- Identifies the channel and unit number of the tape unit on which the controlware tape is mounted and to be read.
- Reads the controlware tape which loads the tape controller.

The tape unit and the channel used to access the unit are identified by setting the switches shown in the unshaded area of the deadstart panel illustrated in figure 2-4. The tape unit number must be between 10 and 17 and the unit must be on a channel without a PP (for example, channel 12 or 13). Refer to appendix H to determine the channels without a PP at your site.

	Binary				Octal †
1	111	101	ttt	ttt	75tt
2	011	110	001	101	3615
3	001	000	001	100	1014
4	001	111	000	001	1701
5	000	101	111	110	0576
6	111	111	ttt	ttt	77tt
7	000	000	uuu	uuu	00uu
10	000	011	000	000	0300

Figure 2-4. Coldstart of 7152 Tape Controller from Tape Unit

- ttt ttt Represents the channel number used to access the controlware tape equipment.
- uuu uuu Represents the physical unit number of the tape unit on which the controlware is mounted.

The numbers are entered in binary form; each switch represents one bit in a 12-bit PP instruction word. The remainder of the panel is not used.

Unloading of the controlware tape indicates that the controlware has been loaded successfully. It is necessary to reset the deadstart panel for a warmstart immediately in order to proceed with the loading of the system deadstart tape.

PANEL SETTINGS FOR COLDSTART OF 844 OR 885 DISK CONTROLLERS

Panel Settings for Coldstart of 7054/7154/7152/7155 Disk Controller from Card Reader

The specific function of the deadstart program during coldstart from a card reader is as follows:

- Identifies the controller and channel number used to access the card reader from which the controlware is to be read. Also specifies the controller, channel, and unit number of the drive on which the deadstart disk is mounted.

†In many cases, the range of the third octal digit is restricted by the setting of the 2⁵ (and sometimes 2⁴) bit.

- Reads the controlware card deck. The function of this deck is to load the disk controller. Processing of the deadstart tape according to the options specified on the deadstart panel is then initiated.

The equipment necessary for the devices used during coldstart is identified by setting the switches shown in the unshaded area of the deadstart panel illustrated in figure 2-5. This includes the channel number and controller associated with the card reader and the channel, controller, and unit number of the disk unit.

The drive on which the deadstart disk is mounted and the card reader must be on different channels. The card reader must be on a channel without a PP (for example, channel 12 or 13). Refer to appendix H to determine the channels without a PP at your site.

	Binary				Octal †
1	111	101	ccc	ccc	75cc
2	111	111	ccc	ccc	77cc
3	fff	000	000	000	f000
4	000	000	000	000	0000
5	111	111	ccc	ccc	77cc
6	001	100	000	000	1400
7	111	100	ccc	ccc	74cc
10	111	001	ccc	ccc	71cc
11	111	110	110	100	7664
12	000	000	ttt	ttt	00tt
13	rrr	ppp	xxx	xxx	rpxx
14	eee	011	uuu	uuu	e3uu

Figure 2-5. Coldstart of Disk Controller from Card Reader

NOTE

When deadstarting from a 7054 or 7154 disk controller, incorrect panel settings, such as channel or unit numbers, can hang the controller. To free the controller, correct the panel settings and master clear the controller.

- ccc ccc Represents the channel number used to access the card reader from which the controlware is to be read.
- fff fff Represents the controller number to which the card reader is connected.
- ttt ttt Represents the channel number used to access the deadstart disk equipment.
- uuu uuu Represents the physical unit number of the drive on which the deadstart disk is mounted.

eee Represents the controller number to which the disk unit is connected.

xxx xxx† Represents the CMR number.

ppp† Represents the deadstart parameters.

rrr† Represents the deadstart level.

tt ttt Represents the channel number used to access the deadstart disk equipment.

eee Represents the controller number to which the disk unit is connected.

vvv vvv Represents the physical unit number of the disk drive from which the coldstart operation is to be completed.

uuu uuu Represents the physical unit number of the disk drive from which the warmstart operation is to be completed.

xxx xxx† Represents the CMR number.

ppp† Represents the deadstart parameters.

rrr† Represents the deadstart level.

The numbers are entered in binary form; each switch represents one bit in a 12-bit PP instruction word.

Refer to Setting Word 13 later in this section for detailed information on word 13 parameters.

In general, you should reset the deadstart panel for a warmstart immediately after a coldstart from a card reader if the controlware has been loaded successfully. If the disk subsystem is functioning properly, there is no need to perform another coldstart after initial loading of the controlware.

The numbers are entered in binary form; each switch represents one bit in a 12-bit PP instruction word.

Refer to Setting Word 13 later in this section for detailed information on word 13 parameters.

In general, you should reset the deadstart panel for a warmstart immediately after a coldstart if the controlware has been loaded successfully. If the disk subsystem is functioning properly, there is no need to perform another coldstart after initial loading of the controlware.

Panel Settings for Coldstart of 7152/7155 Disk Controller from Disk Unit

The specific function of the deadstart program during coldstart from a disk unit is as follows:

- Identifies the controller and channel number used to access the disk unit from which the controlware is to be read. Also specifies the controller, channel, and unit number of the drive on which the deadstart disk is mounted.
- Reads the controlware. The function of this controlware is to load the disk controller. Processing of the deadstart file according to the options specified on the deadstart panel is then initiated.

The equipment necessary for the devices used during coldstart is identified by setting the switches shown in the unshaded area of the deadstart panel illustrated in figure 2-6. This includes the channel number and controller associated with the card reader and the channel, controller, and unit number of the disk unit.

The disk unit must be on a channel with no active PP (for example, channel 0, 12, or 13). Refer to appendix H to determine the channels without a PP at your site.

The numbers are entered in binary form; each switch represents one bit in a 12-bit PP instruction word.

Refer to Setting Word 13 later in this section for detailed information on word 13 parameters.

In general, you should reset the deadstart panel for a warmstart immediately after a coldstart if the controlware has been loaded successfully. If the disk subsystem is functioning properly, there is no need to perform another coldstart after initial loading of the controlware.

LOADING CTI MODULE TO DISK

Loading the CTI module to disk enables you to perform warmstart from disk. It also enables the off-line maintenance system to be run if MSL is available at your site and is subsequently installed on disk. Before CTI can be loaded, the tape controlware must be loaded and functioning properly. This is accomplished by coldstart as described earlier in this section.

Use the following procedure to prepare a scratch disk and load CTI to the disk.

1. Mount the operating system deadstart tape (refer to appendix D for operating instructions).
 - a. Ensure that the write enable ring is not on the reel.
 - b. Mount the tape and ready the unit.
2. Set the deadstart panel for warmstart (refer to Panel Settings for Warmstart later in this section).
3. Activate the deadstart switch. The initial options (*A*) display appears (figure 2-7).
4. Select the U option. The utilities (*U*) display appears (figure 2-8).
5. Select the I option. The display shown in figure 2-9 appears.

	Binary				Octal ††
1	000	000	000	000	0000
2	111	101	1tt	ttt	75tt
3	111	111	0tt	ttt	77tt
4	eee	001	vvv	vvv	e1vv
5	111	111	0tt	ttt	77tt
6	eee	011	uuu	uuu	e3uu
7	111	100	0tt	ttt	74tt
10	111	001	0tt	ttt	71tt
11	111	011	000	001	7301
12	000	000	000	000	0000 †††
13	rrr	ppp	xxx	xxx	rpxx
14	000	000	000	000	0000

Figure 2-6. Coldstart of 7152/7155 Disk Controller from Disk Unit

†The instructions for the setting of the bits represented by these parameters are given in Setting Word 13.
 ††In many cases, the range of the third octal digit is restricted by the setting of the 2⁵ bit.
 †††This word can be set if MSL is installed (contact a customer engineer for more information).

6. Press R. The system now requests the channel, equipment, and unit numbers for the device from which a previously installed CTI is to be released. This also serves to properly prepare a disk which has not previously had CTI installed on it. Enter the channel, equipment and unit number for the device.

7. Press CR. The following message appears:

ENTRY OF (CR) WILL CAUSE
RELEASE OF CMSE-RESERVED SPACE

8. Press CR. The following message appears if the operation is successful:

RELEASE COMPLETE
(CR) TO PROCESS DIFFERENT DEVICE

9. Press CR. The display in figure 2-9 appears.

10. Press CR. The following warning message appears.

WARNING

PERMANENT FILES MAY BE LOST IF
DISK DEADSTART MODULE NOT
PREVIOUSLY INSTALLED ON DEVICE

(CR) TO CONTINUE

Before proceeding to the next step, you should be certain that the disk to which you will load CTI does not already contain any permanent files or information which must be preserved unless you are just replacing an existing copy of CTI with another.

11. Press CR. The system now requests the channel, equipment, and unit numbers for the device on which CTI is to be installed. Enter the channel, equipment, and unit number for the device.

The following message appears if CTI is loaded successfully.

INSTALL COMPLETE
(CR) TO PROCESS DIFFERENT DEVICE

Steps 6 through 11 may be repeated for each disk upon which you wish to install CTI. When the CTI installation process is complete, you must activate the deadstart switch to return to the *A* display. The version of CTI is indicated at the bottom of the *A* display.

During the next deadstart, Initialize the device you used to load CTI.

A

(CR) - OS LOAD AUTOMATIC

O - DEADSTART WITH OPERATOR INTERVENTION

U - UTILITIES

M - OFFLINE MAINTENANCE †

CTI A01

Figure 2-7. CTI Initial Options (*A*) Display

† This line only appears if MSL is available on this deadstart disk.

U

(BS) - RETURN TO *A* DISPLAY

S - ALTERNATE DEADSTART

E - EXPRESS DEADSTART DUMP

I - INSTALL CTI ON RMS

Figure 2-8. Utilities (*U*) Display

ENTER ONE OF THE FOLLOWING

(CR) - INSTALL DEADSTART
MODULE ON DISK

R - RELEASE CMSE-RESERVED
DISK SPACE

Figure 2-9. I Option

LOADING DDS MODULE TO DISK

Loading the DDS module to disk from tape enables you to run DDS in subsequent deadstarts. DDS is a system confidence test that can be selected as an option in the CTI displays (refer to the Operator Intervention O Option subsection later in this section). If MSL is available at your site and will be installed on disk, it will provide the DDS module without the need to install the DDS installation tape.

Before DDS can be loaded, the disk controlware must be loaded and functioning properly. If the 66x tape subsystem is being used, its controlware must be loaded and functioning properly also. This is accomplished by coldstart as described earlier in this section.

If the disk to which the DDS is to be loaded does not already contain the CTI module which is currently in use at your site, or if the previous content of the disk is not known, it is recommended that the CTI module be loaded to disk before the DDS module is loaded to disk. Refer to the procedure Loading CTI Module to Disk earlier in this section.

Use the following procedure to load the DDS module to disk.

1. Mount the DDS installation tape (refer to appendix D for operating instructions).
 - a. Ensure that the write enable ring is not on the reel.
 - b. Mount the tape and ready the unit.
2. Set the deadstart panel for warmstart from tape (refer to Panel Settings for Warmstart).
3. Press the deadstart switch.
4. The first display that appears requests the disk type. The console displays the default value 1.

DISK TYPE 01

1 = 844-21, 2 = 844-4X, 3 = 885

Enter the correct disk type parameter, if different from the default value shown, and press CR.

5. The next display asks you to specify the channel connected to the 844 or 885 disk subsystem upon which DDS will reside.

DISK CHAN 01

Enter the channel number of the 844 or 885 disk subsystem, if different from the default value shown, and press CR.

6. The next display requests the equipment number of the disk controller.

DISK EQUIP 00

Enter the equipment number of the 844 or 885 disk subsystem, if different from the default value shown, and press CR.

7. The next display requests the unit number of the disk.

DISK UNIT 00

Enter the number of the disk unit that is to receive DDS, if different from the default value shown, and press CR.

8. The next display requests the type of tape unit.

MT TYPE 02

1=60X/65X,† 2=66X, 3=67X

Select the type of tape unit, if different from the default value shown, and press CR.

9. The next display requests the channel number of the tape controller or 66x tape subsystem on which the DDS installation tape is mounted.

MT CHAN 13

Enter the channel number of the tape controller or 66x tape subsystem, if different from the default value shown, and press CR.

10. The next display requests the equipment number of the tape controller or 66x tape subsystem.

MT EQUIP 00

Enter the equipment number of the tape controller or 66x tape subsystem, if different from the default value shown, and press CR.

11. The next display requests the unit number of the tape drive.

MT UNIT 00

Enter the unit number of the tape drive on which you mounted the DDS tape, if different from the default value, and press CR.

While DDS is being loaded to disk, names of the programs placed on the disk are displayed on the left side of the display screen.

Press the S key if you want to stop the system from copying programs to the disk. Press the space bar if you want the system to resume copying programs to the disk.

Upon completion of loading DDS to the disk from tape, the following message appears.

END

12. Press the deadstart switch.

During the next deadstart, initialize the device you used to load DDS.

WARMSTART

Warmstart is the deadstart procedure used when the controlware is loaded and functioning properly. Figure 2-10 illustrates the warmstart procedure. Detailed information concerning all phases of the deadstart process is provided throughout the remainder of this section.

The following steps summarize the procedures necessary to perform warmstart from a 66x/67x magnetic tape unit or 844/885 disk unit. Use this as a checklist during warmstart.

1. Ensure that required mass storage devices have packs mounted and/or are available.
2. Mount the deadstart tape or pack (refer to appendix D for operating instructions).
3. Set the deadstart panel for warmstart (refer to Setting the Deadstart Panel later in this subsection).
 - a. Select the correct deadstart function.
 - b. Select the correct CMRDECK.
4. Press the deadstart switch.
5. Select the correct CTI options.
6. Modify the CMRDECK.
7. Type NEXT to modify the IPRDECK or type GO if there are no changes to the IPRDECK.
8. Initialize the system (refer to Initializing the System).
 - a. Enter the date.
 - b. Enter the time.

†NOS does not support 60x/65x tape drives. They are provided for compatibility with other systems.

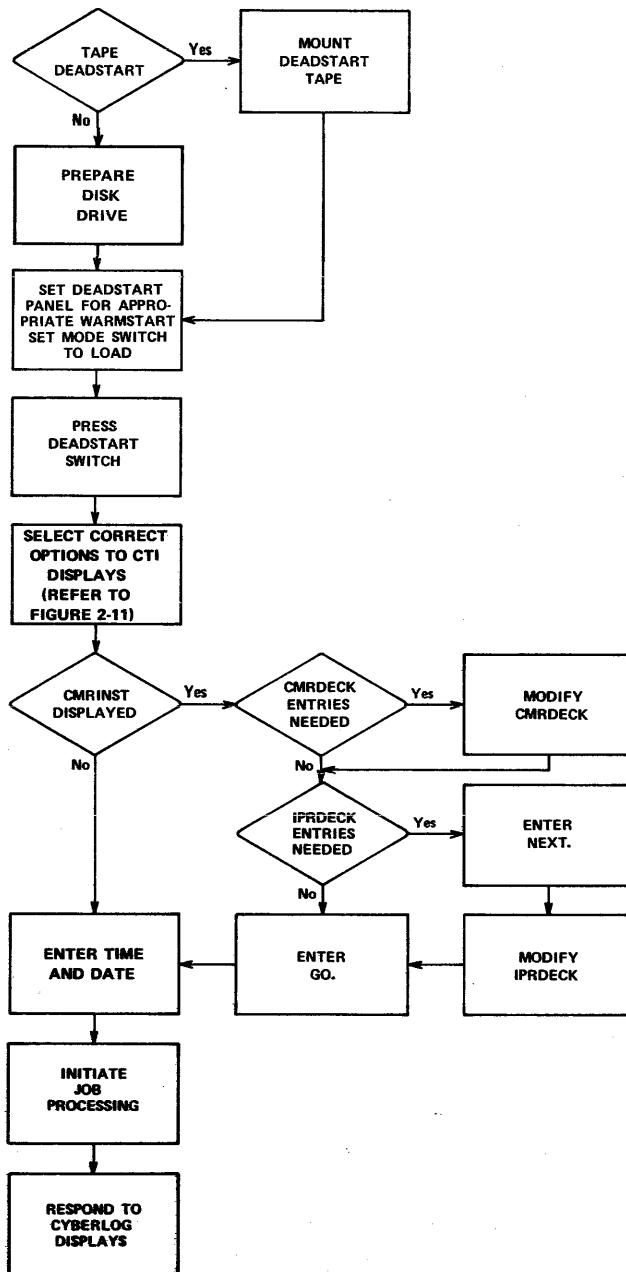

Figure 2-10. Warmstart

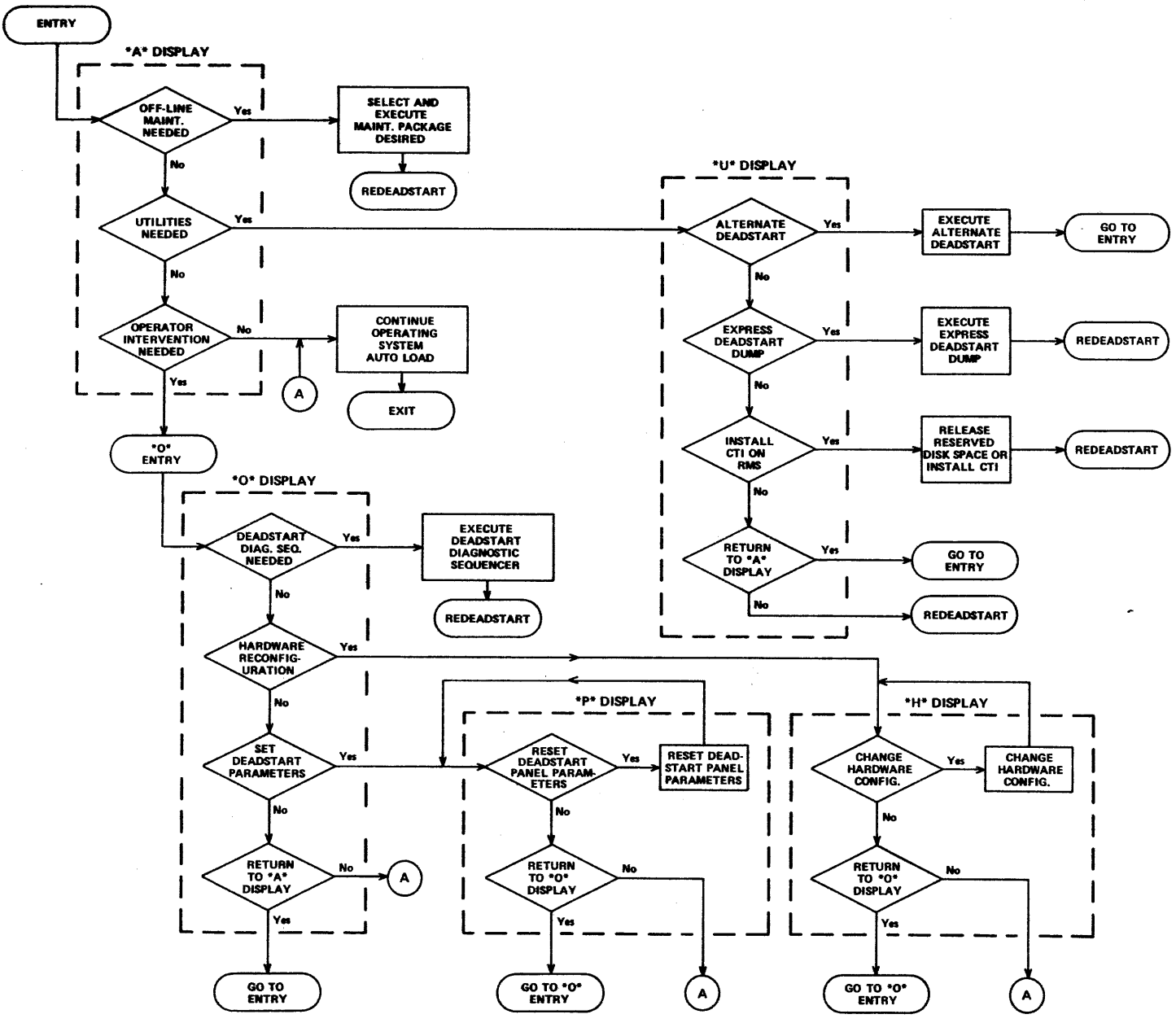

Figure 2-11. Set Correct Options to CTI Displays

9. Initiate job processing (refer to Initiating Job Processing) by typing AUTO or MAINTENANCE if job processing was not initiated during IPRDECK modification.

10. Respond to CYBERLOG displays.

PANEL SETTINGS FOR WARMSTART

There are two types of warmstart panel settings; one for use when the deadstart device is connected to an active PP channel and the other for when the device is connected to a channel without an active PP. When the device is connected to an active PP channel, there are two different panel settings because there are fewer switches on the CYBER 70/6000 panels.

The deadstart device on which the deadstart tape or disk pack is mounted, its associated controller, and the channel used to access this equipment are identified by setting the switches shown in the unshaded area of the deadstart panels illustrated in figures 2-12, 2-13, and 2-14. Refer to appendix H to determine which channels are connected to active PPs at your site.

	Binary				Octal†
1	001	100	000	010	1402
2	111	011	0tt	ttt	73tt
3	000	000	001	111	0017
4	111	101	1tt	ttt	75tt
5	111	111	0tt	ttt	77tt
6	eee	ddd	ddd	ddd	edddd
7	111	100	0tt	ttt	74tt
10	111	001	0tt	ttt	71tt
11	111	011	000	001	7301
12	000	000	000	000	0000††
13	rrr	ppp	xxx	xxx	rpxxx
14	000	000	000	000	0000
15	000	000	000	000	0000
16	000	000	000	000	0000
17	000	000	000	000	0000
20	111	001	001	010	7112

Figure 2-12. CYBER 170 Series Panel Settings for Warmstart from Channel with an Active PP (For Example, Channel 1, 2, or 11)

	Binary				Octal†
1	001	100	000	010	1402
2	111	011	0tt	ttt	73tt
3	000	000	001	011	0013
4	111	101	1tt	ttt	75tt
5	111	111	0tt	ttt	77tt
6	eee	ddd	ddd	ddd	edddd
7	111	100	0tt	ttt	74tt
10	111	001	0tt	ttt	71tt
11	111	011	000	001	7301
12	rrr	ppp	xxx	xxx	rpxxx
13	000	000	000	000	0000
14	111	001	001	010	7112

Figure 2-13. CYBER 70 and 6000 SERIES Panel Settings for Warmstart from Channel with an Active PP (For Example, Channel 1, 2, or 11)

	Binary				Octal†
1	000	000	000	000	0000
2	000	000	000	000	0000†††
3	000	000	000	000	0000†††
4	111	101	1tt	ttt	75tt†††
5	111	111	0tt	ttt	77tt
6	eee	ddd	ddd	ddd	edddd
7	111	100	0tt	ttt	74tt
10	111	001	0tt	ttt	71tt
11	111	011	000	001	7301
12	000	000	000	000	0000††
13	rrr	ppp	xxx	xxx	rpxxx
14	000	000	000	000	0000

Figure 2-14. Panel Setting for Warmstart from Channel with No Active PP (For Example, Channel 0, 12, or 13)

NOTE

When deadstarting from a 7054 or 7154 disk controller, incorrect panel settings, such as channel or unit numbers, can hang the controller. To free the controller, correct the panel settings and master clear the controller.

tt ttt Represents the channel number used to access the deadstart equipment.

eee Represents the controller number to which the deadstart unit is connected.

† In many cases, the range of the third octal digit is restricted by the setting of the 2⁵ bit.
 †† This word can be set if MSL is installed (contact a customer engineer for further information).
 ††† If a 6681 data channel converter is the first equipment on the channel or if it precedes the deadstart device controller, words 2, 3, and 4 must be set as follows:

	Binary				Octal
2	111	101	1tt	ttt	75tt
3	111	111	0tt	ttt	77tt
4	010	001	000	000	2100

ddd ddd ddd Represents the deadstart function and depends on device type as follows:

- 010 11u uuu 66x tape units.
- 001 01u uuu 677 tape units at 800 bpi and 679 tape units.
- 011 01u uuu 677 tape units at 556 bpi.
- 011 uuu uuu 844 or 885 disk units.
u uuu
or
uuu uuu Represents the physical unit number on which the deadstart tape or disk pack is mounted.

- xxx xxx† Represents the CMRDECK number.
- ppp† Represents the deadstart parameters.
- rrr† Represents the deadstart level.

The numbers are entered in binary form; each switch represents one bit in a 12-bit PP instruction word.

Refer to Setting Word 13 later in this section for detailed information on word 12 and 13 parameters.

SETTING WORD 13

Three unique fields exist in word 13 (word 12 on CYBER 70 and 6000 Series machines) of the deadstart panel which allow you to select the CMRDECK, the deadstart parameters, and the level of deadstart. The switches that represent these fields are shown in the following illustration of the deadstart panel.



- xxx xxx Specifies the CMRDECK number.
- ppp Specifies the deadstart parameters.
- rrr Specifies the level of deadstart.

SELECTING THE CMRDECK

The CMRDECK contains the equipment configuration to be used for system operations. Up to 64 CMRDECKS can be included on the deadstart file (numbered 0 through 77g). This provides an installation with the ability to select one of several equipment configurations when the system is deadstarted.

†The instructions for setting the bits represented by the parameters are given in Setting Word 13. On a CYBER 70 or 6000 Series machine, word 12 is set in place of word 13 when warmstarting from a channel with an active PP. Also on these machines, word 12 can be reset to deadstart MSL if it is installed (contact a customer engineer for more information).

NOTE

The CMRDECK can be selected only during a level 0 (initial) deadstart. If it is necessary to perform a level 1, 2, or 3 (recovery) deadstart, the CMRDECK selected during the most recent level 0 deadstart must be used. Refer to the discussion under Selecting the Deadstart Level for information concerning the levels of deadstart.

The number of the CMRDECK to be used is selected by setting the switches (bits 5 through 0) shown in the unshaded area of the deadstart panel illustrated.



- xxx xxx Specifies the CMRDECK number (0 through 77g) to be used.

For example, assume that CMRDECK number 26g is to be used to define the equipment configuration at deadstart. In this case, the corresponding switches on the deadstart panel would be set as follows (0 indicates that switch is placed in down position; 1 indicates that switch is placed in up position):

xxx xxx 010 110

It is not necessary to specify the CMRDECK on the deadstart panel. In this case, the *P* display (described later in this section) allows you to specify the CMRDECK to be used from the console keyboard. In addition, values entered via the options display have precedence over those specified on the deadstart panel. For example, bits 0 through 5 of word 13 on the deadstart panel (xxx xxx) could be set to select the CMRDECK most frequently used by an installation. Another CMRDECK could then be selected when necessary via the *P* display during a level zero deadstart.

SELECTING THE DEADSTART PARAMETERS

You can select deadstart parameters to control miscellaneous deadstart functions by setting bits 8 through 6 in word 13. The switches that represent this field of bits are shown in the unshaded area of the deadstart panel illustrated.

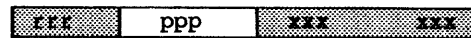

- ppp Specifies miscellaneous deadstart functions.

Value of ppp (bits 8-6)	Switch Position	Description
Bit 8	Down	Reserved for future use.
Bit 7 = 0	Down	Indicates that the system will not save the contents of PP0 in central memory when performing an express deadstart dump.

Value of ppp (bits 8-6)	Switch Position	Description
Bit 7 = 1	Up	Indicates that the system will attempt to save the original contents of PP0 in central memory when performing an express deadstart dump. This will be done only if a free block of central memory is available. A free memory block is field length beyond CMR which is not assigned to a subsystem.
		If there is no free block of central memory available, the original contents of PP0 cannot be saved.
Bit 6 = 0	Down	Indicates that the CMRDECK will not be displayed during deadstart.
Bit 6 = 1	Up	Indicates that the CMRDECK will be displayed during all levels of deadstart.

SELECTING THE DEADSTART LEVEL

You can select one of four levels of deadstart by setting bits 11, 10, and 9 in word 13. The switches that represent this field of bits are shown in the unshaded area of the deadstart panel illustrated.



Value of rrr (bits 11-9)	Description
000	Indicates an initial or level 0 (zero) deadstart in which the system is loaded from the deadstart file. This is not considered to be a recovery deadstart although permanent files, queue files (if QPROTECT is enabled†), and system dayfiles are recovered automatically. An attempt to recover these files is made on all levels of system deadstart. Level 0 deadstart is normally specified under the following conditions. <ul style="list-style-type: none"> • For the first deadstart following a period in which the system has been inoperative, or has been used for purposes other than NOS operations. • When a system malfunction has occurred and other levels of system deadstart prove ineffective.

Value of rrr (bits 11-9)	Description
	If it becomes necessary to redeadstart the system (for example, due to system malfunction), it is recommended that a level 3 recovery deadstart be attempted. If level 0 is selected, the system is reloaded from the deadstart file. All permanent files, queue files (if QPROTECT is enabled), and system dayfiles are recovered. All central memory and PP contents are destroyed by the memory confidence test.
001	Indicates a level 1 recovery deadstart whereby the system, all jobs, and all active files are recovered from checkpoint information on mass storage. Permanent files are also recovered. A level 1 deadstart can be done only if the DSD command CHECK POINT SYSTEM (refer to section 3) was successfully executed immediately prior to deadstart. Once level 1 recovery deadstart begins, all central memory and PP contents are destroyed by the memory confidence test.
	Level 1 recovery deadstart is normally used to allow maintenance to be performed and then resume normal processing. It is also useful in system test situations. Level 1 recovery deadstart should never be used to attempt recovery from a system malfunction or to preserve queue files.
010	Indicates a level 2 recovery deadstart whereby all jobs and active files are recovered from checkpoint information on mass storage. However, no attempt is made to recover the system. Instead, the system is loaded from the deadstart file as in level 0 deadstart. In all other respects, level 2 recovery deadstart is identical to that described for a level 1 recovery deadstart (refer to preceding description). Once level 2 recovery deadstart begins, all central memory and PP contents are destroyed by the memory confidence test.
	Level 2 recovery deadstart is normally used in system test situations and is not recommended for the normal production environment.
011	Indicates a level 3 recovery deadstart whereby all jobs, active files, and the system, with the exception of the library directory, are recovered from central memory tables. A level 3 deadstart is the only level that preserves the

†Refer to the NOS Installation Handbook for more information on the QPROTECT installation option.

contents of central memory. If a deadstart level less than 3 is selected early in the deadstart process, a memory test pattern is written throughout central memory. In order to avoid inadvertent destruction of central memory contents when a level 3 deadstart was intended, it is recommended that level 3 is always selected on the deadstart panel. If a deadstart level other than 3 is needed, you can specify the level by changing the *P* display. The library directory is recovered from mass storage. Permanent files are also recovered. A CHECK POINT SYSTEM command must have been issued prior to deadstart to prevent loss of SYSEDIT (system library modification) information. Only PP memory confidence testing occurs during a level 3 recovery deadstart; central memory is unaffected.

A level 3 recovery deadstart is normally performed following an equipment malfunction (for example, channel or PP hung), providing central memory and mass storage remain intact. Unless it can be determined that central memory is no longer reliable, a level 3 recovery should be attempted following a malfunction. If level 3 recovery fails, a level 0 deadstart must be performed.

NOTE

Attempting a level 1 or 2 recovery deadstart after a level 3 deadstart fails will not correctly recover system activity and can endanger system and permanent file integrity. You must perform a level 0 deadstart.

For additional information concerning levels of deadstart, refer to Preparing for Recovery Deadstart later in this section.

KEYBOARD ENTRIES

The following statements apply to operator/console communication during deadstart.

Refer to the illustration of console keyboard in section 1.

- Entries typed from the console keyboard are displayed on the bottom of the left console screen as they are entered.
- The BKSP key deletes the previous character typed.

- The left blank key deletes the current line being typed (left blank is third key from right on top row of keyboard).
- The following message may appear above the console entry if the entry is unrecognizable: INVALID ENTRY.

INITIATING DEADSTART PROCESS

Initiate the deadstart process by momentarily activating the deadstart switch. Use the deadstart button on the display console.

Most of what you do during system deadstart is preliminary. That is, you specify the conditions of deadstart. Deadstart proceeds automatically until you are required to initialize the system or an error is encountered (refer to Initializing the System later in this section). Generally, automatic deadstart consists of the following steps.

1. Validate labels on all mass storage devices. This is done to ensure that the configuration matches that specified in the CMRDECK being used.
2. Build central memory tables that reflect information contained in the device labels (level 0 deadstart only). If a recovery deadstart is being performed, the central memory tables can be recovered from checkpoint information on mass storage (level 1 or 2) or verified against information in device labels if central memory is found to be intact (level 3).
3. Load base operating system (core system) programs into central memory. Again, the level of deadstart determines the amount of loading to be performed.

You can monitor deadstart progress on the console display screen(s). If errors are encountered during deadstart, a descriptive message is displayed on the right console screen and deadstart halts. Refer to Error Processing at the end of this section for complete information and corrective action.

If the left display screen is replaced by an error display, an irrecoverable error has occurred. Deadstart halts. Refer to appendix B for a description of the messages and appropriate action.

SELECTING CTI INITIAL OPTIONS (*A*) DISPLAY

This section describes the deadstart displays and options provided by the common testing and initialization (CTI) module. The initial options (*A*) display always appears first. From the *A* display, you can select additional options or you can instruct the system to proceed with automatic system deadstart.

The *A* display provides four options as figure 2-15 illustrates.

Option	Description
(CR)	OS load automatic. Refer to following description of OS Load Automatic (CR) Option for detailed information. Press CR to load the operating system with no intervention on your part. Additional options cannot be selected after this entry.
O	Deadstart with operator intervention. Select this option to display the operator intervention (*O*) display. The *O* display is described later in this section.
U	Utilities. Select this option to display the utility (*U*) display. The *U* display is described later in this section.
M†	Offline maintenance. Select this option to initiate the offline maintenance tests. Refer to a customer engineer more information.

The version of CTI is indicated at the bottom of the *A* display.

A		
(CR)	-	OS LOAD AUTOMATIC
O	-	DEADSTART WITH OPERATOR INTERVENTION
U	-	UTILITIES
M	-	OFFLINE MAINTENANCE
CTI	-	A01

Figure 2-15. CTI Initial Options (*A) Display

OS Load Automatic (CR) Option

When you press CR, deadstart proceeds to the loading of the memory confidence test. The system bypasses the memory confidence test for central memory at a level 3 deadstart so that memory contents are preserved. The memory confidence test verifies the ability of PP and central memory to hold simple data patterns and presets the contents of PP and central memory to a known state of all ones (777...777) before the operating system is loaded. The control bits of the status/control (S/C) register on CYBER 170 Series machines are cleared and then set to a known state. The interlock register on CYBER 70 Series machines is cleared so that no bits are set when and if the S/C register simulator SCRSIM is called.

The current address being tested for each processor is displayed on the left screen. Any memory data errors are displayed on the right screen. The information displayed varies depending on the system being used. The left screen

of the CYBER 170 Series machines shows the current S/C register and its respective bit, the PP number and current PP data address being checked, the current central memory address being checked, and the value of the P register. The right screen shows the current PP being checked, any PP or central memory data errors, and any S/C register errors (figure 2-16).

The CYBER 70 Series left screen displays the same information as on the CYBER 170 display except the interlock register and its bit are used in place of the S/C register and bit. The right screen shows the current PP being tested and any PP or central memory data errors (figure 2-17).

The 6000 Series left screen displays the PP number, the current PP and central memory address being tested, and the P register. The right screen shows the current PP being tested and any PP or central memory data errors (figure 2-18).

If the system detects any errors, it adds an explanatory message to the right display and stops processing. Otherwise, NONE appears on the line below each header.

A PP or central memory data error message has the following format:

```
ADDRESS
EXPECTED DATA
ACTUAL DATA
DIFFERENCE
```

Additional information will appear after each entry.

When there is an S/C register error, the following message appears at the bottom of the left screen:

DEADSTART ABORTED - FATAL ERRORS.

The actual error message appears on the right screen and has the following format:

word 16

```
SC-0-2  yyy yyy yyy yyy yyy
SC-0-1  yyy yyy yyy yyy yyy yyy
SC-0-0  yyy yyy yyy yyy yyy yyy
```

word 0

yyy is the contents of a word in the S/C register with word 0 at the lower right and word 16 at the upper left. Appearing below the S/C register contents are the English text explanations of the error bits currently set. If the message:

SECDED DOUBLE - QUADRANT n, CSUxxx.

appears, the system has detected a double bit memory error. You may want to reconfigure central memory so that the system does not use the part of central memory causing the error (refer to CM Reconfiguration for CYBER 170 Series in appendix J). Following these explanations, the contents of the channel 36 S/C register, if it exists,

†The off-line maintenance (M) option does not appear if MSL is not installed at your site.

appears in similar format with 1 replacing 0 in the m field of SC-m-n. Finally, the explanation of the channel 36 error bits currently set appear. Overflow from the left display appears on the right screen with an information message indicating the overflow.

If problems occur during PP memory testing, the following messages appear.

PROCESSOR NOT RESPONDING

FATAL ERROR - DEADSTART ABORTED

Inform a customer engineer.

```
CHECK COMPUTER MEMORY.  
S/C REGISTER 01 BIT 0314  
PP05 0567  
CM ADDRESS 056472 PO=001104
```

Left Screen

```
MEMORY DATA ERRORS  
  
PP05  
NONE  
  
CENTRAL MEMORY  
NONE  
  
S/C REGISTER ERRORS  
NONE
```

Right Screen

Figure 2-16. CYBER 170 Series Memory Check

```
CHECK COMPUTER MEMORY.  
INTERLOCK REGISTER 00 BIT 0077  
PP21 0000  
CM ADDRESS 000005 PO=001104
```

Left Screen

```
MEMORY DATA ERRORS  
  
PP21  
NONE  
  
CENTRAL MEMORY  
NONE
```

Right Screen

Figure 2-17. CYBER 70 Series Memory Check

```
CHECK COMPUTER MEMORY.  
PP10 2473  
CM ADDRESS 003021 PO=001102
```

Left Screen

```
MEMORY DATA ERRORS  
  
PP10  
NONE  
  
CENTRAL MEMORY  
NONE
```

Right Screen

Figure 2-18. 6000 Series Memory Check

Operator Intervention O Option

Selecting the O option from the *A* display causes the operator intervention (*O*) display to appear on the left screen. Figure 2-19 illustrates the *O* display.

Option	Description
(CR)	Enter OS load automatic. Refer to preceding OS Load Automatic (CR) Option for detailed information. Press CR to load the operating system with no intervention on your part. Additional options cannot be selected after this entry.
(BS)	Return to *A* display. Press BKSP to return to the *A* display.
D	Deadstart diagnostic seq. Select this option to load the DDS. DDS controls the execution of a set of confidence tests of the peripheral processor subsystem (PPS), first level peripheral processors (PPUs), central memory (CM), extended memory (EM), and the central processor unit (CPU).

If you are going to perform a level 3 deadstart after selecting this option, you must have set the deadstart panel for a level 3 recovery at deadstart.

After D is selected, the display shown in figure 2-20 appears.

The * indicates that the corresponding hardware is to be tested. †

Word	Description
CM	Central memory size.
RA	Relative address for all central memory accesses.

Option

Description

Word	Description
FL	Field length for all central memory accesses.
CPU0	Test status of CPU0.
CPU1	Test status of CPU1.
PPS	Test status of PPs in the system.
PPUS	Test status of PPUs in the system.
EM	Extended memory selection.
EMRA	Relative address for all EM accesses.
EMFL	Field length of all EM accesses.

To add or delete hardware to be tested, make the following entries.

Entries	Description
A,CM or D,CM	Add (A) or delete (D) central memory tests.
A,C0 or D,C0	Add or delete CPU0 tests.
A,C1 or D,C1	Add or delete CPU1 tests.
A,PS or D,PS	Add or delete PPS tests.
A,PU or D,PU	Add or delete PPU tests.
A,EM or D,EM	Add or delete extended memory tests.

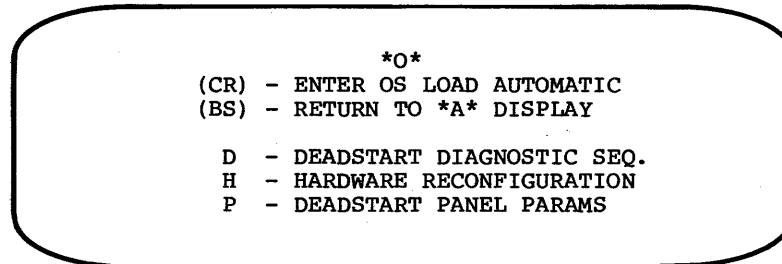

Figure 2-19. Operator Intervention (*O*) Display

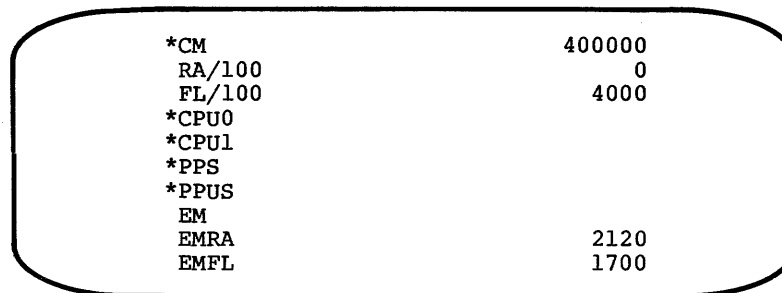

Figure 2-20. D Option

† DDS does not test hardware that is turned off (refer to the *H* display).

Option

Description

Press CR to start testing.

In general, each test depends upon the results of a previous test. DDS displays the following messages during the tests.

TESTING REG
TESTING PPS
TESTING PPU
TESTING CM
TESTING CPU xx
TESTING EM

If an error condition occurs, one of the following messages appears.

ERROR PP xx
ERROR PPU xx
ERROR CM
ERROR CPU xx
ERROR EM
ERROR REG
SCR ERROR yyyy

xx indicates the PP, PPU or CPU in error. Consult a customer engineer.

yyyy indicates an SCR word 0 error. Consult a site analyst. If the error is fatal, CTI will display it on a subsequent deadstart.

Upon test completion, DDS checks for any status/control register errors (CYBER 170 only) and displays SCR ERROR yyyy or DEADSTART DIAGNOSTICS COMPLETED followed by DEADSTART IS REQUIRED.

Toggle the deadstart switch after testing to ensure that the system is returned to initial deadstart condition prior to system loading or recovery. Do this whether testing was successful or not.

Refer to the On-Line Maintenance Software Reference Manual for additional information.

Option

Description

H

Hardware reconfiguration. Select this option to alter the hardware configuration. The *H* display appears on the left screen as illustrated in figure 2-21.

The *H* display shows the current hardware configuration. This display initially reflects the default condition, which is that every hardware element is available to use. Through keyboard entries, you can alter the hardware configuration to prevent use of selected hardware elements.

Press CR if you wish to continue system deadstart processing with no further intervention on your part. You cannot select additional options after this entry.

Press BKSP if you wish to return to the *O* display.

Enter CM=nnnn to set the central memory size to less than the maximum physically available.

When you turn off any element of the types CPU, PP, or PPU, its identifier is added to the list of OFF ELEMENTS on the display. The identifiers will be removed from the list if the element is subsequently turned back on. The list is empty when you first bring up the display.

Table 2-1 shows the keyboard entries that you can make to reconfigure the hardware. Entries are in the form keyword=option.

P

Deadstart panel params. Select this option to change any of the following: the deadstart level, the CMRDECK, or deadstart panel words 12 and 14. The *P* display appears on the left screen as illustrated in figure 2-22.

Press CR if you wish to cause system deadstart processing to continue with no further intervention on your part. Refer to preceding OS Load Automatic (CR) Option for detailed information. Additional options cannot be selected after this entry.

Press BKSP if you wish to return to the *O* display.

Table 2-2 shows the keyboard entries that you can make to change deadstart panel parameters.

H

(CR) - ENTER OS LOAD AUTOMATIC
 (BS) - RETURN TO *O* DISPLAY

CEJ/MEJ=ON
 CMU=ON

OFF ELEMENTS

Figure 2-21. Hardware Reconfiguration (*H*) Display

TABLE 2-1. KEYBOARD ENTRIES FOR THE *H* DISPLAY

Keyword	Option	Function														
CM=	nnnn	<p>Specifies the size in octal of central memory in hundreds of words. Therefore, for:</p> <table style="margin-left: auto; margin-right: auto;"> <thead> <tr> <th style="text-align: left;"><u>Central Memory Size</u></th> <th style="text-align: left;"><u>nnnn</u></th> </tr> </thead> <tbody> <tr><td>49 K</td><td>1400</td></tr> <tr><td>65 K</td><td>2000</td></tr> <tr><td>98 K</td><td>3000</td></tr> <tr><td>131 K</td><td>4000</td></tr> <tr><td>198 K</td><td>6000</td></tr> <tr><td>262 K</td><td>10000</td></tr> </tbody> </table> <p>If you enter CM=0 or do not enter the CM=nnnn parameter, the system sets the maximum central memory size.</p> <p>If the nnnn value you specify exceeds the amount of physical memory, the following error message appears.</p> <p style="text-align: center;">UNAVAILABLE</p> <p>If you specify a central memory size that is not large enough for a system deadstart, the following message appears.</p> <p style="text-align: center;">INVALID ENTRY</p>	<u>Central Memory Size</u>	<u>nnnn</u>	49 K	1400	65 K	2000	98 K	3000	131 K	4000	198 K	6000	262 K	10000
<u>Central Memory Size</u>	<u>nnnn</u>															
49 K	1400															
65 K	2000															
98 K	3000															
131 K	4000															
198 K	6000															
262 K	10000															
CPU _n =	OFF/ON	<p>Specifies the logical status of each available CPU. Values for n are 0 or 1.</p> <p>If you enter a CPU_n = OFF command and the other CPU is already off, the following error message appears.</p> <p style="text-align: center;">INVALID ENTRY</p> <p>If your site has only one CPU, the system uses it even if you turn it off.</p>														
PP _{nn} =	OFF/ON	<p>Specifies the logical status of one or more peripheral processors. Values for nn are any octal number in the range 3 through 11 (excluding 10) or 20 through 31. Values for nn can also be in the form a-b (a through b), where a and b are octal numbers in the range 3 through 11 (excluding 10) or 20 through 31 and a is less than b. PP₀, 1, 2, 3, and 10 must be on before you can deadstart the NOS system.</p> <p>For example, the following entries are valid.</p> <p style="margin-left: 40px;">PP₄ = OFF</p> <p style="margin-left: 40px;">PP₅₋₇ = OFF</p> <p>The following entries are invalid.</p> <table style="margin-left: auto; margin-right: auto;"> <thead> <tr> <th style="text-align: left;"><u>Entry</u></th> <th style="text-align: left;"><u>Description</u></th> </tr> </thead> <tbody> <tr> <td>PP₂ = OFF</td> <td>PP₂ must be on to deadstart.</td> </tr> <tr> <td>PP₇₋₅ = OFF</td> <td>a must be less than b.</td> </tr> <tr> <td>PP₃₋₃₁ = OFF</td> <td>Illegal range.</td> </tr> </tbody> </table>	<u>Entry</u>	<u>Description</u>	PP ₂ = OFF	PP ₂ must be on to deadstart.	PP ₇₋₅ = OFF	a must be less than b.	PP ₃₋₃₁ = OFF	Illegal range.						
<u>Entry</u>	<u>Description</u>															
PP ₂ = OFF	PP ₂ must be on to deadstart.															
PP ₇₋₅ = OFF	a must be less than b.															
PP ₃₋₃₁ = OFF	Illegal range.															

TABLE 2-1. KEYBOARD ENTRIES FOR THE *H* DISPLAY (Contd)

Keyword	Option	Function
PPUnn=	OFF/ON	Specifies the logical status of the indicated physical first level peripheral processor (PPU). Values for n are any octal number in the range 1 through 15. Values for nn can also be of the form a-b (a through b), where a and b are both octal numbers in the range 1 through 15 and a is less than b.
CEJ/MEJ=	OFF/ON	Specifies the logical status of CEJ/MEJ. If status is ON, CEJ/MEJ will be used if present. If there is no CEJ/MEJ switch or the CEJ/MEJ switch is physically set to the disable position on the deadstart panel and the logical status is set to ON (default), an error message display results after the final CR is pressed for the CTI options. Refer to Setting the Deadstart Panel earlier in this section for a description of the error message display.
CMU=	OFF/ON	Specifies the logical status of the compare/move unit (CMU) hardware. If the logical status is ON, CMU will be used if present.

p

(CR) - ENTER OS LOAD AUTOMATIC
 (BS) - RETURN TO *O* DISPLAY

I=x - INIT/RECOVERY LVL
 C=xx - CMRDECK NUMBER
 D=x - DISPLAY CMRDECK
 W12=xxxx - D/S PANEL WORD 12
 W14=xxxx - D/S PANEL WORD 14

Figure 2-22. Deadstart Panel Params (*P*) Display

TABLE 2-2. KEYBOARD ENTRIES FOR THE *P* DISPLAY

Entry	Function
I=x	Specifies the level of deadstart. The value of x can be 0, 1, 2, or 3. Refer to Preparing for Recovery Deadstart later in this section for additional information concerning the levels of deadstart.
C=xx	<p>Specifies the CMRDECK number. The value of xx can be 0 through 77 octal.</p> <p>If a level 1, 2, or 3 recovery deadstart is to be performed, the CMRDECK selected during the most recent level 0 deadstart must be used.</p> <p>For additional information concerning CMRDECK selection, refer to Selecting the CMRDECK earlier in this section.</p>
D=x	<p>Specifies whether the CMRDECK is to be displayed. The value of x can be:</p> <p>Y Display CMRDECK.</p> <p>N Do not display CMRDECK.</p>
<p>NOTE</p> <p>The following entries are for maintenance operations and do not affect operating system deadstart.</p>	
W12=xxxx	Specifies the value for deadstart panel word 12. Refer to a customer engineer for additional information.
W14=xxxx	Specifies the value for deadstart panel word 14. Word 14 is reserved for the operating system or maintenance system.

Utilities U Option

Selecting the U option from the *A* display causes the utilities (*U*) display to appear on the left screen. Figure 2-23 illustrates the *U* display.

<u>Option</u>	<u>Description</u>
(BS)	Return to *A* display. Press BKSP to return to the *A* display.

Option

S

Description

Alternate deadstart. Select this option to specify an alternate tape unit or disk device which can be used to deadstart from. This device can be deadstarted using the panel settings described previously. The display shown in figure 2-24 appears on the left screen.

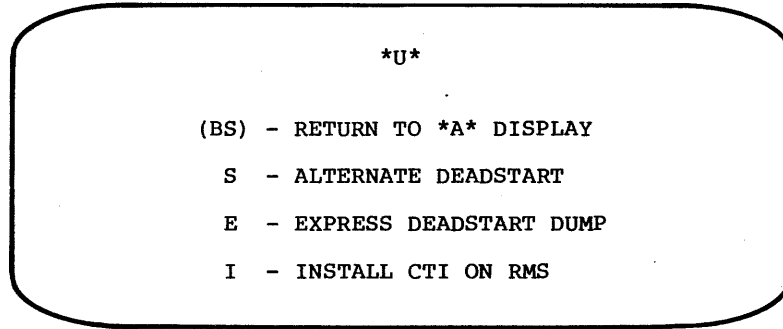

Figure 2-23. Utilities (*U*) Display

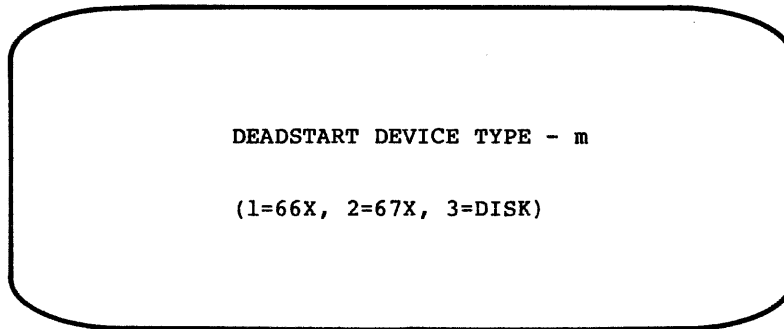

Figure 2-24. Alternate Deadstart Display

Option

Description

m is the device type currently indicated on the deadstart panel. Press CR to use this device type. To specify an alternate device type, enter a 1, 2, or 3 to replace m and press CR. The following line appears.

CHANNEL - cc

cc is the channel currently indicated on the deadstart panel. Press CR to use this channel. To specify an alternate channel, enter the channel number to replace cc and press CR. The following line appears.

EQUIPMENT - e

e is the equipment currently indicated on the deadstart panel. Press CR to use this equipment. To specify an alternate equipment, enter the equipment number to replace e and press CR. The following line appears.

UNIT - uu

uu is the unit number currently indicated on the deadstart panel. Press CR to use this unit number. To specify an alternate unit number, enter the unit number to replace uu and press CR.

The system now deadstarts from the alternate device. The initial options (*A*) display reappears.

E

Express deadstart dump (EDD). Select this option to dump to tape the contents of PP memories, central memory, CPU hardware registers, and S/C registers (CYBER 170 Series). You can also dump ECS for CYBER 170 Series, and dump the tape and disk controlware. DSDI can interpret the dump at a later time (refer to the NOS System Maintenance Reference Manual).

When EDD dumps PP memories, it destroys some of the contents of the PPs. The following locations are affected:

<u>PP</u>	<u>Locations</u>
PP0	0 through 21 _g and 6000 _g through 7777 _g .
PP1	0 through 7.
All others:	0 through 3 and 7774 _g through 7777 _g .

If you want to dump the entire contents of PP0, you must reconfigure PPs to deadstart from another PP, or transfer the contents of PP0 to another PP before you use EDD. When possible you should reconfigure (refer to appendix J). If you cannot reconfigure PPs, the following process can be used to transfer the contents of PP0 to another PP prior to the dump.

1. Choose an active channel PP to which the system can transfer the contents of PP0.

Option

Description

2. Set the following program on the deadstart panel.

1	010 000 000 000	LDC 00
2	111 111 111 110	77 76
3	111 011 ppp ppp	OAM PP
4	000 000 000 000	00 00
5	000 011 000 000	UJN 00

ppp ppp Binary representation of the number of the PP you chose to hold the contents of PP0.

3. Activate the deadstart switch. The system transfers the contents of PP0 to the PP you chose. The contents of that PP is destroyed by the transfer.
4. Reset the deadstart panel for the appropriate warmstart.

If you have reconfigured PPs or transferred the contents of PP0, you must redeadstart to use EDD. Remember which PP has the contents of PP0 so that when the system dumps the PPs you will know which PP to print to get the contents of PP0.

When you activate the deadstart switch, the system displays the initial options (*A*) display. Enter U to select the utilities display. Then enter E to start the dump process. When you select E, the console displays the line:

MT CH 00

Enter the two-digit channel number of the tape unit to which memory is to be dumped and press CR. The console then displays:

MT ECUU 0000

Enter the one-digit number of the tape unit's controller (E), the one-digit number specifying controller type (C is 1 for 677/679 tape units and C is 2 for 667/669 tape units), and the two-digit number of the tape unit (UU). The default controller type is 2. Press CR. The console displays:

EXPRESS DUMP NUMBER 00

Enter the two-digit dump identifier and press CR. This dump identifier will be placed on the first record of the tape for future reference. The console displays:

NONZERO INHIBITS REWIND

To prevent the tape from rewinding before and after a dump, enter a nonzero octal number and press CR. To rewind the tape before and after the dump, either enter 0 and press CR, or press CR with no entry. Multiple dumps may be taken on a tape by inhibiting rewind on each dump.

Option

Description

The contents of central memory, PP memories, S/C register (CYBER 170 Series), and the CPU hardware register is dumped.

If an error occurs during a dump, the following message is issued:

type,CSaaaa,DSbbbb.

type Type of error
 which occurred:

CON Connect reject.
FCN Function reject.
WRT Write error.

aaaa Channel converter status.

bbbb Controller status.

To retry the dump operation, press CR.

NOTE

If a CPU is logically turned off, a flag indicating this is set in the dump and the CPU is not exchanged during EDD execution. If CPU0 is down on a one-CPU machine, both CPU0 and CPU1 must be logically turned off at deadstart to avoid exchanging of the registers.

For the CYBER 170 Series you can optionally dump ECS. The console displays:

ECS SIZE/1000 0000

To dump ECS memory, enter a four-digit number representing ECS size/1000 and press CR. To prevent dumping of ECS, either enter 0 and press CR, or press CR with no entry.

NOTE

If both CPUs are logically turned off, no ECS dump is performed regardless of the value entered.

The buffer controller memory of disk and tape systems can then optionally be dumped. The console displays:

CONTROLWARE CHANNEL 00

Enter the two-digit channel number of the controller to be dumped and press CR. This sequence continues until you press CR with no entry.

Option

Description

NOTE

There is no capability in the deadstart dump interpreter (DSDI) to translate controlware dumps.

Whenever EDD is waiting for input, the dump can be stopped by entering the character S. The console displays:

DUMP id STOPPED

id Dump identifier.

When the dump is complete, the console displays:

DUMP id COMPLETE

id Dump identifier.

If you reconfigured the PPs before the dump, reconfigure them back to their normal settings after the system completes the dump.

Activate the deadstart switch. The initial options (*A*) display reappears and additional options can be selected.

I

Install CTI on RMS. Select this option to load the CTI module onto an 885 or 844 mass storage device or to release space occupied by the CTI module on an 885 or 844 mass storage device. The console displays as shown in figure 2-25.

NOTE

When installing CTI for the first time on a disk, select the R option first to ensure that the reserved disk space has been released and the disk is properly prepared. This will also release the space reserved for DDS or MSL.

If you press CR, the following warning message appears.

WARNING

PERMANENT FILES MAY BE LOST IF
DISK DEADSTART MODULE NOT
PREVIOUSLY INSTALLED ON DEVICE

(CR) TO CONTINUE

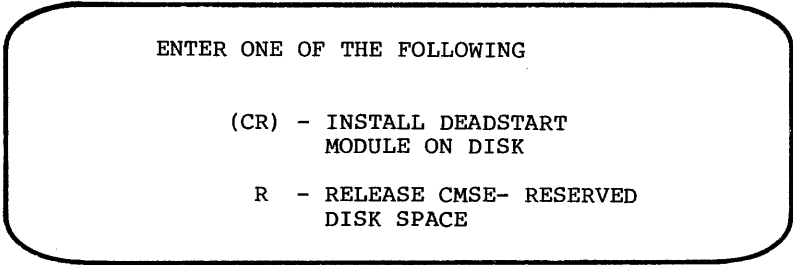

Figure 2-25. Install CTI on RMS Display

<u>Option</u>	<u>Description</u>
	Before proceeding to the next step, be certain that the disk to which you will load CTI does not contain any permanent files or information that must be preserved, unless you are just replacing an existing copy of CTI with another.
	Press CR to continue.
	After you select CR or R, the system then asks for the channel, equipment, and unit numbers for the device CTI is to be loaded on or released from. Use the same procedure to enter these digits as shown in the description of the S option (alternate device deadstart) earlier in this section.
	The display header will be either one of the following.
	INSTALL DISK DEADSTART MODULE
	RELEASE CMSE-RESERVED DISK SPACE
	Once you have specified a device, the system attempts to read the deadstart sector from the device. If the specified device is inaccessible, the system displays the following message.
	UNABLE TO ACCESS DISK (CR) TO PROCESS DIFFERENT DEVICE
	Press CR to process a different device.
	If the system is able to rewrite the deadstart sector on the device, the following message appears.
	xxxxxxx COMPLETE (CR) TO PROCESS DIFFERENT DEVICE
	xxxxxxx Either INSTALL or RELEASE, depending on the process being performed.
	Press CR to process a different device.
	If the system encounters any error conditions during the loading process (other than not being able to access the specified device to

<u>Option</u>	<u>Description</u>
	read the deadstart sector), the following message appears.
	ERRORS IN INSTALL (CR) TO PROCESS DIFFERENT DEVICE
	Press CR to install or release a different device.
	Activate the deadstart switch to end this utility. The initial option (*A*) display reappears and additional options can be selected.

MODIFYING THE CMRDECK

If bit 6 of word 13 (word 12 for warmstart on a CYBER 70 or 6000 Series machine with an active PP) is set to one (ppp=001), or if the D=Y option is selected on the *P* display, an instruction display entitled CMRINST appears on the console screen(s) after you press the final CR in response to the CTI displays. All valid CMRDECK entries are defined in this display. Several of the entries listed are assigned system default values. These values are assumed if the entries do not appear in the CMRDECK being used. To view the contents of the CMRDECK being used, press the right blank key (rightmost key on top row of console keyboard; refer to illustration in section 1). The CMRINST display is returned by pressing the right blank key again. The display alternates each time the right blank key is pressed. If either the CMRDECK or CMRINST overflows two screens, the display can be advanced by pressing the + key.

Modify the CMRDECK by entering the appropriate changes or additions from the console keyboard. These entries can be made when either CMRDECK or CMRINST is being displayed. Each console entry supersedes the value currently specified in the CMRDECK (or default value in CMRINST).

Since the extent of operator responsibility in modifying the CMRDECK can vary from one installation to another, table 2-3 describes only the operator entries that can be entered only from the console. Refer to the NOS Installation Handbook for complete information concerning all CMRDECK entries.

NOTE

The modified CMRDECK remains in effect only until the next deadstart is performed. Changes to the CMRDECK are not recovered for the next deadstart unless a new deadstart file is created to reflect those changes.

TABLE 2-3. CMRDECK ENTRIES

Entry	Function																
AUTOLOAD.	<p>Toggles the selection of buffer controller autoloading for all 7054/7154/7152/7155 controllers. This entry is illegal in the CMRDECK and can only be entered from the console at deadstart time. This entry, which affects all 7054/7154/7152/7155 controllers defined on the mainframe being deadstarted, is not necessary for normal system operation but is provided as an aid to hardware checkout.</p>																
GRENADE.	<p>Toggles the selection of the grenade function. The grenade function is issued to all 7054/7154/7152/7155 controllers, once the controlware is loaded. This function causes unit reservations to be cleared on all 844 units physically connected to each controller. This entry is normally used when a unit reservation from a downed mainframe exists on a device. Use this entry with caution since it can interrupt the operation of another machine that could be accessing affected units through another controller. This entry is illegal in the CMRDECK and can be entered only from the console at deadstart time.</p>																
INITIALIZE,xx,op.	<p>Blank labels a mass storage device during a level 0 deadstart. This entry is valid only when entered from the console keyboard. That is, the INITIALIZE entry cannot be included as part of the CMRDECK on the deadstart file. Before any mass storage device defined in the CMRDECK (by an EQ entry) can be used, it must have a label that can be recognized by the system. Existing labels are normally recovered automatically during all levels of system deadstart. However, should the existing label be destroyed (for example, during maintenance operations on the device) or a new mass storage device be added to the system, you enter the INITIALIZE command to create a new label.</p> <p>xx One- to two-digit number specified in EQ entry for device (for example, EQ05...). This is also the EST ordinal for the device.</p> <p>op Level of initialization</p> <table data-bbox="617 934 958 1123"> <tr><td>AL</td><td>Total initialize</td></tr> <tr><td>PF</td><td>Permanent files</td></tr> <tr><td>QF</td><td>Queue files</td></tr> <tr><td>DF</td><td>System dayfile</td></tr> <tr><td>AF</td><td>Account dayfile</td></tr> <tr><td>EF</td><td>Error log dayfile</td></tr> <tr><td>FP</td><td>Format pack (844)</td></tr> <tr><td>MF</td><td>Binary maintenance log</td></tr> </table> <p>Depending upon the levels of initialization selected, all or part of the previously existing information on the device is lost when the new label is created. Total initialization or 844 format pack (AL or FP options) destroys all information on a device. The other options selectively purge information. A separate INITIALIZE entry is required for each option selected. Selecting FP results in an automatic system selection of AL. The system deletes all existing information (including the system deadstart file) from a device initialized with the AL option (you cannot initialize the device from which you are deadstarting). You should initialize the device if you have loaded CTI, DDS, or MSL on it.</p> <p>No options (except AL and FP) are processed until deadstart is completed. At that time, the K display is requested and you must enter the family name (FM) and device number (DN) of the device to be initialized. This is a final check to ensure that the correct device is being initialized; the selected options are then processed.</p> <p>If permanent files are to reside on the device being initialized, the CMRDECK should contain a PF entry for that device. The PF entry corresponds to the EST ordinal specified in the EQ entry and indicates that permanent files can reside on the device. If the CMRDECK displayed contains a PF entry for the device being initialized, a new PF entry is not required unless the existing entry is to be altered, or the associated EQ entry is altered. Modification of an existing EQ entry clears all other associated entries except SYSTEM, LINK, and FAMILY entries (PF, INITIALIZE, and so forth, are cleared). In addition, if PF entries do not exist in the CMRDECK, initializing the device causes a default family name and device number to be assigned. Thus, it is necessary to reestablish the PF entry via the console keyboard if the device is to remain a permanent file device. For this reason, it is recommended that the PF entry for all mass storage devices used for permanent files reside in the CMRDECK. Although this is recommended, it is not required. Refer to the Installation Handbook for complete information concerning the PF entry to CMRDECK.</p>	AL	Total initialize	PF	Permanent files	QF	Queue files	DF	System dayfile	AF	Account dayfile	EF	Error log dayfile	FP	Format pack (844)	MF	Binary maintenance log
AL	Total initialize																
PF	Permanent files																
QF	Queue files																
DF	System dayfile																
AF	Account dayfile																
EF	Error log dayfile																
FP	Format pack (844)																
MF	Binary maintenance log																

TABLE 2-3. CMRDECK ENTRIES (Contd)

Entry	Function
INSTALL=xx.	<p>If the EQ entry in the CMRDECK displayed indicates that the status of a particular mass storage device is OFF when the INITIALIZE entry is made, initialize status is maintained and occurs automatically when the DSD command ON is entered for that device during normal system operation.</p> <p>It should be noted that initialization of mass storage devices can also be accomplished during normal system operation via the DSD command INITIALIZE (refer to description of command in section 3).</p> <p>Specifies the mass storage device on which the system deadstart file is to be installed. The INSTALL entry must follow the EQ entry for the specified device and the status must be set to ON. A full INITIALIZE must have been specified for a shared (MMF) device. The device must be a single-unit device, such as an 844 or 885, and must have CTI installed. This entry is illegal in the CMRDECK and can be entered only from the console on a level 0 deadstart. It is recommended that neither the mass storage device nor any controllers accessing the device be accessible from another mainframe.</p>

After completing all CMRDECK modifications, you can also modify the IPRDECK being used. The specific IPRDECK to be used, if other than default, is specified in the CMRDECK IPD entry as described previously. The IPRDECK contains installation parameters which describe the mode of system operation. It is important to note that nearly all IPRDECK entries are also valid DSD commands. Therefore, IPRDECK modification is seldom required during deadstart since DSD commands can be used to make the same changes during normal system operation as the need arises. Installation parameters changed during normal system operation (via DSD commands or modification of the IPRDECK) are retained only across a level 3 recovery deadstart. All valid DSD commands are described in section 3 of this manual.

If it is necessary to modify the IPRDECK, continue with the next section (Modifying the IPRDECK). Otherwise, to indicate that all modifications to the CMRDECK and/or IPRDECK have been completed, type

GO.

and press CR.

MODIFYING THE IPRDECK

When the CMRDECK or CMRINST is currently being displayed, type

NEXT.

and press CR to modify the IPRDECK. An instruction display entitled IPRINST then appears on the console screen(s). All valid IPRDECK entries are defined in this display. Most of these entries are also valid DSD commands. To view the contents of the IPRDECK being used, press the right blank key. The display alternates each time the right blank key is pressed. If either the IPRDECK or IPRINST overflows two screens, the display can be advanced by pressing the + key.

Modify the IPRDECK by entering the appropriate changes or additions from the console keyboard. These entries can be made when either IPRINST or IPRDECK is being displayed. Each console entry supersedes the value currently specified in the IPRDECK.

NOTE

The modified IPRDECK remains in effect only until the next level 0, 1, or 2 deadstart is performed. Changes to the IPRDECK are retained if a level 3 recovery deadstart is performed.

For complete information concerning IPRDECK entries, refer to the NOS Installation Handbook and also section 3 of this manual (DSD commands).

To indicate that modifications to the CMRDECK and/or IPRDECK have been completed, type

GO.

If a level 0 or level 2 deadstart is being performed, the system library is automatically loaded from the deadstart file to each mass storage device specified as a system device. If no system device was specified, the system is loaded on the first nonremovable mass storage device in the EST.

If a level 1 or level 3 recovery deadstart is specified, the system library is not reloaded. In this case, the deadstart file is rewound and is not accessed again until another deadstart operation is performed. The system library is recovered from checkpoint information on mass storage. Central memory resident (CMR) tables such as the file name table (FNT), equipment status table (EST), and track reservation table (TRT) are either recovered from checkpoint information for level 1 or from central memory (and the link device, ECS, if in multimainframe mode) for level 3.

If a deadstart error occurs, a message appears on the right console screen and, depending upon the nature of the error, deadstart processing may halt. Refer to Error Processing at the end of this section for complete information and corrective action. In addition, if the system is being loaded (level 0 or 2 only), the name of each system library program is also displayed on the right console screen as it is being loaded. This allows you to monitor deadstart progress.

The left console screen contains the message ENTER DATE YY/MM/DD and indicates that you can begin system initialization (refer to Initializing the System later in this section). System initialization can be performed while the system is being loaded.

INITIALIZING THE SYSTEM

Each time a system deadstart function is performed, it is necessary to initialize the system. Essentially, this consists of entering the current date and time. The system uses the date and time (updated every second) for dayfile messages and to update permanent file catalogs and directories for files being accessed. This includes the creation, last modification and last access date and time for each permanent file in the system. Thus, it is extremely important to enter the correct date and time in order to accurately maintain these system records. If a level 3 recovery deadstart is being performed, it is possible to recover the date and time from the previous system deadstart. However, this is not recommended since the new date and time recorded for system records would no longer be accurate.

When the system loading (or recovery) phase of deadstart is about to begin, the following one-line message appears in the center of the left console screen and requests entry of the current date.

ENTER DATE YY/MM/DD.

Type the current date, followed by CR, in the following format.

yy/mm/dd.

yy Year; 00 through 99.

mm Month; 01 through 12.

dd Day; 01 through nn (nn is the number of days in the month).

For deadstart levels 0, 1, and 2, pressing CR without first entering the date causes the system to assume the date when the deadstart tape was created. For level 3 recovery deadstart, pressing CR alone recovers both the previous date and time (time entered during the last deadstart plus time accumulated until this deadstart).

When the system has accepted the date entry, it displays the following request for entry of the current time.

ENTER TIME HH.MM.SS.

Type the current time followed by CR in the following format.

hh.mm.ss.

hh Hour; 00 through 23.

mm Minute; 00 through 59.

ss Second; 00 through 59.

For deadstart levels 0, 1, and 2, pressing CR without first entering the time causes the system to set the time to 00.00.00. If CR alone was entered following the date prompt on a level 3 recovery, this prompt to enter time does not appear and the previous time is assumed.

Normal job processing is initiated automatically by DSD commands specified in the IPRDECK. If a level 1 or level 3 recovery deadstart is being performed, the system recovers all jobs and active files and resumes normal operation immediately. However, if an initial deadstart (level 0) or level 2 recovery deadstart is being performed, job processing may not be initiated immediately. This depends upon the length of time required to load the system from the deadstart tape (progress can be monitored on the right console screen). If tape loading is not completed when the time entry is made, the DSD commands specified in IPRDECK are displayed on the lower portion of the left screen and are flashed. In the period of time until tape loading completes, one or more of the DSD commands can be cleared by pressing the left blank key (third key from right on top row of keyboard) as many times as is necessary to clear the flashing entry. Clearing a command prevents it from being executed when tape loading completes. In this case, the commands necessary to initiate job processing must be entered manually from the console keyboard (refer to Initiating Job Processing).

INITIATING JOB PROCESSING

Control point assignment is automatic under system operation. Once deadstart is complete, processing proceeds with little or no intervention on your part. As mentioned previously, the DSD commands necessary to initiate job processing are set up in the IPRDECK. If you decide to clear the initial DSD commands, you must manually initiate job processing by typing either

AUTO. or MAINTENANCE.

Following entry of the AUTO or MAINTENANCE command during an initial (level 0) deadstart, the deadstart sequencing process begins. Deadstart sequencing causes job processing to be suspended until all system files in the default family are initialized. If a family other than the default is entered, enter the command

X.ISF(FM=family)

family Alternate family of devices.

For additional information concerning the ISF command and deadstart sequencing, refer to the NOS System Maintenance Reference Manual.

Normal job processing begins after the deadstart sequencing job completes. If the AUTO command was entered, the subsystems enabled in the IPRDECK are automatically assigned to control points. Assuming all standard subsystems were set to be enabled, the system would call them to specific control points as follows:

Control Point Number	Job Name	Activity
1	IAF. or TELEX.	Interactive facility or time-sharing subsystem executive routine.
2	TAF.	Transaction subsystem executive routine.
3	NEXT.	Available for automatic system assignment.
.	.	.
.	.	.
n-4	NEXT.	
n-3	NAM.	Network Access Method.
n-2	MAGNET.	Magnetic tape subsystem executive routine.
n-1	BATCHIO.	Central site automatic batch input/output.
n	RBF. or EXP.	Remote batch facility or Export/Import; remote batch job input/output.
n+1	SYSTEM.	

If CYBRLOG appears at a control point, there will be a request message on the B display asking you to assign the K display to the CYBRLOG job. Type

K,n.

n Control point number of CYBRLOG.

Refer to Responding to CYBERLOG Displays later in this section.

The MAINTENANCE command performs the same function as AUTO but additionally assigns several maintenance routines, according to mainframe type, to available control

points and runs them as normal jobs with minimum queue and CPU priorities. These routines are CPU or central memory test routines designed to detect hardware errors. These routines display error messages either at the control point on the B display (refer to section 4) or in the system error log. To display the error log, type:

A,ERROR LOG.

You should monitor these routines from time to time. If a maintenance routine displays an error message indicating a hardware malfunction has occurred, call a customer engineer. It is recommended that these programs be run at all times. The maintenance programs use little memory, are run at minimum CPU and queue priority, and are automatically rolled out if necessary; thus, system performance is not severely affected. Descriptions of the maintenance routines can be found in the On-Line Maintenance Software Reference Manual.

RESPONDING TO CYBERLOG DISPLAYS

The CYBERLOG displays request data about the event which caused the system to be down or degraded. The path through the displays is determined by the selection of event type. Following are the data items recorded for the two event types.

Scheduled Event	Unscheduled Event
Reason	Reason
Elapsed time	Component
	Elapsed time
	Lost time
	Impact

EVENT TYPE ENTRIES

The initial display (figure 2-26) asks for the type of event being recorded. Enter 0 for a scheduled event and 1 for an unscheduled event.

The item you select appears on the line labeled EVENT TYPE. Also, the next list of options for selection appears on the bottom of the display.

CYBERLOG

ENTER THE CODE FOR THE TYPE OF EVENT

CODE DESCRIPTION

0 SCHEDULED

1 UNSCHEDULED

Figure 2-26. CYBERLOG Display for Type of Event

CYBERLOG	
EVENT TYPE: SCHEDULED	
ENTER THE CODE FOR THE REASON FOR THE EVENT	
CODE	DESCRIPTION
0	BEGINNING OF NORMAL DAY
1	HARDWARE RECONFIGURATION
2	SOFTWARE RECONFIGURATION
3	MAINTENANCE
4	OTHER

Figure 2-27. CYBERLOG Display for Scheduled Events

REASON ENTRIES

Figure 2-27 shows the resulting display when 0 was entered in the initial display.

Enter the code that corresponds to the reason for the scheduled event. The item you select appears on the line labeled REASON.

NOTE

Exact information is required for all reason entries. If you do not know the reason for the event, enter the code for UNKNOWN.

Figure 2-28 shows the resulting display when 1 was entered in response to the initial display.

Select the most likely reason for the event. The item you select appears on the line labeled REASON. Selecting 0, 1, 2, or 3 leads to a subsidiary list asking for the component causing the failure. Selecting 4 (UNKNOWN) causes a branch to the elapsed time display.

NOTE

For scheduled events the system does not ask for the component, lost time, or impact entries. The next display that appears asks for the elapsed time. This entry is described following the component descriptions.

COMPONENT ENTRIES

If the reason for an unscheduled event is OTHER, the following display (figure 2-29) appears.

Enter the code that caused the event. The item you select appears on the line labeled COMPONENT.

If the reason for an unscheduled event is a hardware failure, the following display (figure 2-30) appears, to allow more specific identification to be made.

Enter the code for the component causing the hardware failure. The item you select appears on the line labeled COMPONENT.

If the reason for an unscheduled event is a software failure, the following display (figure 2-31) appears.

Enter the code for the component causing the software failure. The item you select appears on the line labeled COMPONENT.

NOTE

Exact information is required for all component entries. If you do not know the component causing the failure, enter the code for UNKNOWN.

If the reason for an unscheduled event is communication, the following display (figure 2-32) appears.

Enter the code for the component causing the communications failure. The item you enter appears on the line labeled COMPONENT.

ELAPSED TIME ENTRIES

The time that the event had an effect on the system is recorded as elapsed time. The request for elapsed time appears for both scheduled and unscheduled events. Figure 2-33 illustrates a sample display showing the request for elapsed time.

Enter the elapsed time in hours and minutes in the format shown. The range of values for hours is 0 through 99 and the range of values for minutes is 00 through 59. A leading zero is not required for hours, but two digits are required for the minutes entry. A period is required to delimit the hours from the minutes. The time you enter appears on the line labeled ELAPSED TIME.

For scheduled events, the lost time and impact do not apply. The lost time field is set to 00.00. The impact field is blank.

CYBERLOG

EVENT TYPE: UNSCHEDULED

ENTER THE CODE FOR REASON FOR EVENT

CODE	DESCRIPTION
0	OTHER
1	HARDWARE
2	SOFTWARE
3	COMMUNICATIONS
4	UNKNOWN

Figure 2-28. CYBERLOG Display for Unscheduled Event

CYBERLOG

EVENT TYPE: UNSCHEDULED

REASON: OTHER

ENTER THE CODE FOR THE COMPONENT CAUSING FAILURE

CODE	DESCRIPTION
0	OTHER
1	TEMP - HUMIDITY
2	ELECTRICAL
3	POWER SUPPLY
4	PROCEDURAL
5	UNKNOWN

Figure 2-29. CYBERLOG Display for Unscheduled Event Caused by Other

CYBERLOG

EVENT TYPE: UNSCHEDULED

REASON: HARDWARE

ENTER THE CODE FOR THE COMPONENT CAUSING FAILURE

CODE	DESCRIPTION
0	OTHER
1	CPU
2	PPU/CHANNEL
3	MEMORY
4	EXTENDED MEMORY
5	TAPE SUBSYSTEM
6	DISK SUBSYSTEM
7	MASS STORAGE SUBSYSTEM
8	UNKNOWN

Figure 2-30. CYBERLOG Display for Unscheduled Event Caused by Hardware

```

CYBERLOG

EVENT TYPE:  UNSCHEDULED

REASON:      SOFTWARE

ENTER THE CODE FOR THE COMPONENT CAUSING FAILURE

CODE        DESCRIPTION
  0          OTHER
  1          OPERATING SYSTEM
  2          COMPILER/ASSEMBLER
  3          APPLICATION PROGRAMS
  4          DATA MANAGEMENT
  5          UNKNOWN

```

Figure 2-31. CYBERLOG Display for Unscheduled Event Caused by Software

```

CYBERLOG

EVENT TYPE:  UNSCHEDULED

REASON:      COMMUNICATIONS

ENTER THE CODE FOR THE COMPONENT CAUSING FAILURE

CODE        DESCRIPTION
  0          OTHER
  1          SUBSYSTEM HARDWARE
  2          HOST SOFTWARE
  3          LINE ADAPTER
  4          MODEM
  5          SUBSYSTEM SOFTWARE
  6          UNKNOWN

```

Figure 2-32. CYBERLOG Display for an Unscheduled Event Caused by Communications

```

CYBERLOG

EVENT TYPE:  UNSCHEDULED

REASON:      HARDWARE

COMPONENT:   DISK SUBSYSTEM

ENTER THE ELAPSED TIME SINCE THE SYSTEM WAS FULLY OPERATIONAL
IN THE FORM

HH.MM

```

Figure 2-33. CYBERLOG Display Request for Elapsed Time

LOST TIME ENTRIES

The lost time is the length of time during which the system or part of the system was down or degraded. The request for lost time appears for unscheduled events only. Figure 2-34 illustrates a sample display showing the request for lost time.

Enter the lost time in hours and minutes in the format shown. The same restrictions in format apply as in the elapsed time entry.

IMPACT ENTRIES

The final entry you make identifies the impact of the event; that is, was the system degraded or down. Degraded implies that the system resources were reduced, and down means that they were unavailable. Figure 2-35 illustrates a sample display showing the request for impact. This request is made for unscheduled events only.

Enter the code for the impact. The item you select appears on the line labeled IMPACT.

```

                                CYBERLOG

EVENT TYPE:    UNSCHEDULED
REASON:        HARDWARE
COMPONENT:     DISK SUBSYSTEM
ELAPSED TIME:  03.15
ENTER THE TIME LOST IN THE FORMAT:
                HH.MM
```

Figure 2-34. CYBERLOG Display Request for Lost Time

```

                                CYBERLOG

EVENT TYPE:    UNSCHEDULED
REASON:        HARDWARE
COMPONENT:     DISK SUBSYSTEM
ELAPSED TIME:  03.15
LOST TIME:     03.15
ENTER THE CODE FOR THE IMPACT OF THE EVENT
CODE           DESCRIPTION
0              DEGRADED
1              DOWN
```

Figure 2-35. CYBERLOG Display Request for Impact

EDIT ENTRIES

After you have made all the entries, you are given the opportunity to change any of the responses. By entering the number which now precedes each line that has an entry, that line is blanked and any subsequent lines which depend on that line are removed from the display. Those choices are then presented again.

To add a comment to an entry, type

CYB, comment.

The maximum length of the comment, excluding CYB, and the period, is 35 characters. The system inserts the word

COMMENT on the display before the comment as shown in figure 2-36.

Figure 2-36 illustrates a sample display showing a completed CYBERLOG entry.

After completing edit entries, enter NEXT or END to transfer the data to the error log dayfile. If you enter NEXT, the CYBERLOG program transfers the data to the error log dayfile and restarts from the beginning to allow a different event to be recorded. With END, after the message is written to the error log dayfile, the CYBERLOG program terminates.

```

                                CYBERLOG

0  EVENT TYPE:      UNSCHEDULED
1  REASON:          HARDWARE
2  COMPONENT:       DISK SUBSYSTEM
3  ELAPSED TIME:    03.15
4  LOST TIME:       03.15
5  IMPACT:          DEGRADED
  COMMENT           CYB, THIS IS A SAMPLE COMMENT LINE.

TO CHANGE ANY LINE, ENTER THE LINE NUMBER

TO WRITE CURRENT MESSAGE AND REPEAT FOR NEW MESSAGE,
ENTER "NEXT"

TO EXIT, ENTER END

TO WRITE A COMMENT, ENTER *CYB,* FOLLOWED BY NO MORE
THAN 35 CHARACTERS, TERMINATED BY A PERIOD.
```

Figure 2-36. Sample Completed CYBERLOG Entry

PREPARING FOR RECOVERY DEADSTART

Sometimes during system operation an error occurs that prevents further system activity and that cannot be corrected by you. Often the situation can be corrected by deadstarting the system and recovering prior activity. The success of such a recovery depends upon the severity of the problem and the extent to which system information has been destroyed. There are three levels of recovery deadstart available (levels 1 to 3). Table 2-4 lists each deadstart level, including level 0 (initial deadstart), and describes the extent of recovery possible. Unless specifically noted, this information applies regardless of whether the QPROTECT installation option is set.

If you are deadstarting in a multiframe environment, refer to appendix E on multiframe operation.

If the MS VALIDATION installation option† is enabled during a level 1 or 2 recovery, or if both the MS VALIDATION and PF VALIDATION options† are enabled during a level 3 recovery, the system performs the following actions.

- Verifies selected mass storage files.
- Checks files identified in the file name table (FNT) to ensure that all tracks in the chain are reserved and no circular linkage exists.
- Depending on file type, checks the track reservation table (TRT) to ensure that the file is preserved.
- Checks all preserved files for proper length.

If the system encounters a verification failure, it clears the FNT/FST entry but does not release disk space assigned to the file. If a length error is detected, the system sets error idle status and terminates recovery operations on the device.

During level 0 deadstart, the system verifies the length of preserved files regardless of the setting of the MS VALIDATION option. If a length error is detected, the system reads the disk chain to determine the correct length of the file, issues a message to the B display, and stops recovery of the device. To alter the EOI for the file and proceed with recovery, enter

n.GO.

n System control point number.

To terminate recovery of the device, enter

n.NOGO.

The following topics provide general information concerning each level of system deadstart and recommended steps of preparation.

CAUTION

Before attempting any level of recovery deadstart (including level 0), examine the current status codes listed for each mass storage device in the mass storage status (E,M.) display. Delay deadstart if status code C (checkpoint requested) appears for any device. When the system has processed the request, status code C is cleared (maximum of 30 seconds). Refer to section 4 for complete information concerning the mass storage status (E,M.) display. Failure to observe this caution may result in the loss of permanent file information.

TABLE 2-4. LEVELS OF SYSTEM DEADSTART

Deadstart Level	Information Recovered				
	Jobs	Active Files	Permanent Files	System	System Dayfiles
0	Dependent on QPROTECT option†	No	Yes	No	Yes††
1	Recovered from last checkpoint	Recovered from last checkpoint	Yes	Recovered from last checkpoint	Yes
2	Recovered from last checkpoint	Recovered from last checkpoint	Yes	No	Yes
3	Recovered from CM copy of FNT†††	Recovered from CM copy of FNT	Yes	Yes	Yes

†If the QPROTECT option was on when the queues (input, output, and rollout) were created and is on during recovery, the input and output queues are recovered. Rollout queues are also recovered as input files. Input files associated with jobs currently executing are returned to the input queues. If the QPROTECT option is off, all jobs are lost.

††Dayfiles are recovered unless initialized by an INITIALIZE entry in the CMRDECK.

†††Jobs in central memory are reinitiated. The INPUT file is rewound and put back into the input queue.

†Refer to the NOS Installation Handbook for a description of the MS VALIDATION and PF VALIDATION IPRDECK entries.

LEVEL 3 RECOVERY

A level 3 recovery deadstart is typically performed following an equipment malfunction (for example, channel or PP hung) providing the system remains intact. Basically, the FNT, TRT, equipment status table (EST), and control point areas of central memory must be intact in order to successfully perform a level 3 recovery deadstart. However, unless it can be determined that central memory is no longer intact, attempt level a 3 recovery deadstart before a level 0 deadstart. This is recommended because current system activity, as it existed at the time of the malfunction, can best be recovered by performing a level 3 recovery deadstart. Only PP memory confidence testing occurs during a level 3 recovery deadstart; central memory is not affected.

Requests for device checkpoint are retained over a level 3 deadstart. Therefore, if a system malfunction prevents a device checkpoint from being done, the checkpoint is processed after level 3 recovery is successfully completed. If a level 3 recovery fails, determine during level 0 deadstart if checkpoint requests were pending. This can be done by dumping mass storage tables and examining them for checkpoints. If any checkpoint requests are found pending on a device, dump and reload the permanent files residing on the device to save the files as they were at the time of the malfunction.

A level 3 recovery deadstart is impossible after any of the following situations.

- An attempted checkpoint recovery (level 1).
- An aborted level 0 (initial) deadstart.
- While in multimainframe mode, the MREC utility (refer to section 8) has been run for the machine to be deadstarted.

It is recommended that you stop current system activity prior to beginning the system deadstart procedure (that is, before activating the deadstart switch). To accomplish this, enter the following DSD commands.

1. ONSW1.

Notifies the time-sharing subsystem to enter all users into recovery state when the subsystem is terminated. This and the following command are necessary only if the time-sharing subsystem is active.

1. STOP.

Drops the time-sharing subsystem.

CHECK POINT SYSTEM.

Provides for termination of job processing and writing the contents of central memory tables to mass storage. For a complete description of this process, refer to the CHECK POINT SYSTEM command in section 3.

UNLOCK.

Necessary only if console is currently locked.

STEP.

Prevents the system from processing PP requests. This stops all central memory I/O operations. The STEP command should be entered after all device checkpoints have completed. Determine checkpoint status from the mass storage status (E,M.) display (refer to section 4).

LEVEL 1 RECOVERY

A level 1 recovery deadstart is usually performed in order to resume normal processing following maintenance procedures. The system, all jobs, and all active files are recovered from checkpoint information on mass storage. In a multimainframe environment, ECS resident tables must be intact.

NOTE

A level 1 recovery deadstart is not intended to be a recovery process after a system/equipment malfunction. It should never be attempted after a level 3 recovery deadstart fails.

Level 1 recovery is also useful in system test situations. If two systems are being alternated, separate mass storage devices and tapes (if tape jobs are being checkpointed) must be available for both systems. Tapes are not repositioned after a level 1 deadstart. Thus, if a job was previously assigned to the tape unit which has been used for deadstarting, the job cannot be recovered. The tape unit should be left unloaded after recovery until it is no longer assigned to the job (job aborted).

The following rules apply when performing a level 1 recovery deadstart.

- The DSD command CHECK POINT SYSTEM (refer to section 3) must have been successfully completed immediately before the end of the last NOS operating period.
- Memory dumps must be completed before level 1 recovery deadstart begins since memory confidence testing destroys the contents of both central memory and PPs.
- The mass storage equipment configuration must be the same as specified during the most recent level 0 deadstart, that is, the same CMRDECK must be used.
- The system devices (mass storage devices on which the system library resides) must be the same as or fewer than those specified during the most recent level 0 deadstart.

It is recommended that you stop current system activity before beginning the system deadstart procedure (that is, before activating the deadstart switch). To accomplish this, enter the following DSD commands.

CHECK POINT SYSTEM.

Provides for termination of job processing and writing the contents of central memory tables to mass storage. For a complete description of this process, refer to the CHECK POINT SYSTEM command in section 3.

UNLOCK.

Necessary only if console is currently locked.

STEP.

Prevents the system from processing PP requests. This stops all central memory I/O operations.

LEVEL 2 RECOVERY

Level 2 recovery deadstart is normally used in system test situations and is not recommended for the normal production environment. If level 2 recovery is selected, all jobs and active files are recovered from checkpoint information on mass storage as in level 1 recovery. However, no attempt is made to recover the system. Instead, the system is loaded from the deadstart file as in level 0 deadstart. In all other respects, level 2 recovery is identical to that described for level 1 in the preceding description, and all rules apply.

LEVEL 0 DEADSTART

Level 0 or initial deadstart is used in cases where a recovery deadstart is not possible. This is a complete or initial load from the deadstart file. Only preserved files, which includes permanent files, queue files, and system dayfiles, are recovered (preserved files are recovered on all levels of system deadstart). Because memory confidence testing destroys the contents of central memory and PPs, all memory dumps must be completed before deadstart begins.

NOTE

If the machine is the first machine being deadstarted in a multiframe environment, the PRESET CMRDECK entry (refer to Installation Handbook for description) must be entered.

ERROR PROCESSING

If no display appears after activating the deadstart switch, perform the following steps as needed. After each step, activate the deadstart switch again to see if the problem has been eliminated.

For deadstart from tape:

1. If the unit select switch on the deadstart tape unit is not on (tape does not move), check the channel, controller, and unit selections on the deadstart panel to ensure they are set correctly.
2. If the unit select switch is on, the correct unit was selected; however, check word 11 of the deadstart panel to ensure it is set correctly.
3. Ensure that a 7-track tape is not mounted on a 9-track drive or vice versa. Also, ensure that a deadstart tape with density of 6250 cpi is not mounted on a tape unit which does not support that density.
4. Ensure that the deadstart tape is an I-mode unlabeled tape.
5. Ensure that the card reader and tape unit (667 or 669 only) are not on the same channel and the card reader is not on a channel with a PP. Also, ensure that two or more units do not have the same physical unit number.
6. If still no display appears after activating the deadstart switch, inform a site analyst. There might be a parity error on one of the first records of the deadstart tape or the magnetic tape controller might have detected a channel parity error on a CYBER 170 Series machine.

For deadstart from disk:

1. Ensure that the disk is spinning, the READY light is on, and the SELECT light is on.
2. Ensure that the disk has the CTI module loaded.
3. Ensure that the deadstart panel is set correctly.
4. Select an alternate channel.
5. If still no display appears after activating the deadstart switch, inform a site analyst. There might be a parity error on one of the first records of the deadstart file or the disk controller might have detected a channel parity error on a CYBER 170 Series machine.

For a proper understanding of the problems which may occur during deadstart, there are several basic concepts with which you should be familiar. For example, because most errors that occur involve mass storage devices, you should be familiar with their use in the system. Each mass storage device has a label that contains descriptive information about its contents. For certain levels of recovery deadstart, this information must be consistent with corresponding information contained in central memory or provided through deadstart procedures. Conflicts can result in deadstart error messages. An attempt is made to recover all mass storage devices defined in the EST during all levels of system deadstart. The specific recovery function performed depends upon the level of deadstart selected. Table 2-5 describes the recovery function performed for each deadstart level as well as the type of errors that can be encountered. The system response to errors and the recommended action for you to take are also listed.

Refer to appendix B for information concerning all deadstart messages.

TABLE 2-5. MASS STORAGE DEVICE RECOVERY

Recovery Function	Level of Deadstart	Description of Error	Type of Device	System Response to Error	Operator Action
Read and verify the label on each mass storage device against that specified by the EQ definition for the device in CMRDECK.	0	Device being recovered is not ready and, therefore, cannot be read.	Removable.	Error code NR and status U set in MST; device is left unavailable.	None.
			Nonremovable.	Wait and retry. Error message is flashed on the right screen display.	Check to ensure that all nonremovable devices are ready.
		Read error occurred when attempting to read label (parity error, surface error, and so forth).	All.	Advance to next track and try to read. A predetermined number of tracks will be searched if error persists. If this number is exceeded, the device is treated as if a bad label existed. Refer to description of Bad Label Error.	None.
		Label verification error. The label was read but could not be verified. For example, label indicates device is first unit of a three-unit multi-spindle pack (DK-3), but units 2 of 3 and/or 3 of 3 are not present.	Nonsystem device.	Error code CE and status U set in MST; device is left unavailable.	Examine E,M display after deadstart is complete to determine corrective action. None.
			System device (non-removable with system residence).	<ol style="list-style-type: none"> If permanent files do not reside on the device, it is initialized automatically using parameters in existing label. If permanent files reside on the device, the following message appears on the right console display and deadstart processing halts. CONTINUING DESTROYS PFS RECOVERY OF DEVICE IMPOSSIBLE. 	
		Bad label. Information read was not recognized as a label sector.	Nonsystem device.	Error code LE and status U set in MST; device is left unavailable.	Device must be initialized after deadstart if it is to be used (refer to DSD command INITIALIZE).
System device (non-removable with system residence).	Device is initialized automatically. Any permanent files that reside on device will be lost.		None.		

TABLE 2-5. MASS STORAGE DEVICE RECOVERY (Contd)

Recovery Function	Level of Deadstart	Description of Error	Type of Device	System Response to Error	Operator Action
	1, 2, 3	Label verification error. The label was read but could not be verified. For example, label indicates device is first unit of a three-unit multi-spindle pack (DK-3), but units 2 of 3 and/or 3 of 3 are not present.	Removable (no active direct access files).	Error code indicates cause of error and status U set in MST; device is left unavailable.	Examine E,M display after deadstart is complete to determine corrective action.
			Nonremovable or removable with active direct access files.	The following message appears on the right console display and deadstart processing halts. ERROR ON DEVICE WITH ACTIVE FILES. NOTE Active direct access files are attached when checkpoint was taken (level 1,2) or when deadstart was initiated. It is assumed that all removable devices have active direct access files.	Perform level 0 deadstart or redefine configuration to match that of system being recovered.
Chain removable devices with consecutive physical unit numbers (applies only to 844-21 (DI or DK) and 844-41/44 (DJ or DL). This will allow a multispindle pack (for example, DK-3) to be mounted on devices defined in EST as single spindle devices (for example, DK-1). Definition for devices in EST is changed to reflect a multispindle device.	0, 1, 2	Label verification error. Label on remaining spindles of multispindle pack could not be verified.	Removable.	All units are returned to their original status in EST and device with label specifying multispindle pack is left unavailable (U status set in MST). The labels on remaining devices that were chained are then checked to determine if they are valid.	Examine the E,M display after deadstart is complete to determine corrective action.

TABLE 2-5. MASS STORAGE DEVICE RECOVERY (Contd)

Recovery Function	Level of Deadstart	Description of Error	Type of Device	System Response to Error	Operator Action
Read TRT into central memory.	0	TRT could not be read successfully.	All.	The following message appears on the right console display and deadstart processing halts. LENGTH OF DEVICES TRT BAD - RECOVERY OF DEVICE IMPOSSIBLE.	Type GO. to proceed. If this is done, the device is initialized using parameters in existing label; permanent files will be lost.
	1, 2	TRT could not be read successfully.	Removable (no active direct access files).	Error code TL and status U set in MST; device is left unavailable.	Examine the MST display after deadstart is complete to determine corrective action.
			Nonremovable or removable with active direct access files.	The following message appears on the right console display and deadstart processing halts. LENGTH OF DEVICES TRT BAD.	Perform level 0 deadstart and initialize the device.
Edit TRT to remove nonpermanent file information.	0	Edit was not successful. This could be caused by specifying a new RTK entry (flawed track) in CMRDECK.	All.	The following message appears on the right console display and deadstart processing halts. PERM. FILE LINKAGE ERROR RECOVERY OF DEVICE IMPOSSIBLE.	Type GO. to proceed. If this is done, the device is initialized using parameters in existing label; permanent files will be lost. If RTK entry was specified, re-deadstart and omit RTK entry.
Verify all mass storage devices in system to ensure permanent file integrity.	0	Two devices in same family have the same device number or the same bits set in the device mask, or two auxiliary devices have the same packname.	System device (non-removable with system residence).	The following message appears on the right console display and deadstart processing halts. EQxx EQyy CONFLICTING { DN. } { UM. } { PN. } xx and yy are the EST ordinals of the conflicting devices.	Perform one of the following: ● Remove one of the specified devices and re-deadstart. ● Re-deadstart and logically turn off one of the specified devices (via CMRDECK entry).
			Nonsystem device.	Error code DN, UM, or PN and status U set in MST; both of the devices are left unavailable.	Examine the E,M display after deadstart is complete to determine the type of error. Either remove, or logically turn off one of the devices; the remaining device is recovered automatically.

TABLE 2-5. MASS STORAGE DEVICE RECOVERY (Contd)

Recovery Function	Level of Deadstart	Description of Error	Type of Device	System Response to Error	Operator Action
Clear interlock data for direct access files.	0	Failure to read legal system sector. The TRT indicates track is beginning of direct access chain but first sector was not a system sector.	All.	Increment count of direct access files in error. Message appears in dayfile in following format. EQxx nnnn PRESERVED FILE ERRORS. xx EST ordinal of device. nnnn Number of files in error.	Examine dayfile after deadstart completes. Message described in preceding column indicates the number of direct access files in error.
		Interlock data specified file was in WRITE mode and last sector for file in TRT was not an EOI sector.	All.	Clear interlocks for file and re-write system sector. Issue following message to error log and system dayfile: LENGTH ERROR filenam uindex. filenam Name of file on which error was encountered. uindex User index of file owner. Also, increment count of direct access file errors. The following message appears in the system dayfile. EQxxnnnnDIRECT ACCESS FILE ERRORS. xx EST ordinal of device. nnnn Total number of length errors.	Examine system and error log dayfiles after deadstart completes. The number of LENGTH ERROR messages issued and the count of DIRECT ACCESS FILE ERRORS should match. To recover files in error: 1. ATTACH old file. 2. PURGE old file. 3. DEFINE new file with old file name. 4. COPY old file to new file.
Recovering queued files.	0	Last sector of file specified by TRT is not an EOI sector.	All.	The following message is issued to the dayfile and error log: QF LENGTH ERROR filnam. filnam Name of file being recovered. The following message is issued to the dayfile at the end of recovery: EQxx nnnn QUEUED FILE ERROR COUNT. xx EST ordinal of device. nnnn File count.	The utility QREC issues messages to the system dayfile indicating the location and job name of all files in error during the requeue operation. The message format is filnam TKxxxx LENGTH ERROR.

TABLE 2-5. MASS STORAGE DEVICE RECOVERY (Contd)

Recovery Function	Level of Deadstart	Description of Error	Type of Device	System Response to Error	Operator Action
Recovery of multi-mainframe link device.	0	ECS resident table containing machine IDs of active mainframes is full.	ECS.	The following message appears on the right console display and deadstart processing halts. MAXIMUM NUMBER MIDS ACTIVE	<ol style="list-style-type: none"> 1. Verify that the correct machine ID is specified in the CMRDECK. 2. Run MREC on active machine for specified machine ID if not initial deadstart.
	0, 1, 2, 3	A valid label track for ECS was not found within predetermined limits.	ECS.	The following message appears on the right console display and deadstart processing halts. ECS LABEL TRACK NOT FOUND.	Perform a level 0 deadstart with INITIALIZE and PRESET selected if no other machines are active.
	0	Machine ID selected if CMRDECK is in use.	ECS.	The following message appears on the right console display and deadstart processing halts. MID CURRENTLY ACTIVE	Either redeadstart specifying a different machine ID or, if correct machine ID was entered, run MREC on another machine.
	1, 2, 3	The machine ID as maintained in CMR was not found in the ECS resident table. This indicates that ECS has been changed, either abnormally or by the execution of MREC on another machine.	ECS.	The following message appears on the right console display and deadstart processing halts. MID UNDEFINED IN ECS.	A level 0 deadstart must be performed.
	0, 1, 2, 3	Error exit was taken while attempting to execute instruction accessing ECS.	ECS.	The following message appears on the right console display and deadstart processing halts. ECS READ/WRITE PARITY ERRORS.	Inform customer engineer. Recovery is impossible.

After the system has been deadstarted successfully, you can enter the DSD commands necessary to provide optimum performance and reliability for users. There are nine general categories of DSD commands available for this purpose.

Dayfile

Dump the system, account, or error log dayfile to a specified device.

Job processing control

Provide added control over job scheduling and processing.

Peripheral equipment control

Control the peripheral equipment available to the system.

BATCHIO equipment

Control the local batch peripheral devices (card readers, card punches, and line printers).

Subsystem control

Schedule a subsystem to a control point or terminate a current subsystem.

System control

Maintain system integrity in a normal production environment or debug a system that is in an abnormal state.

Memory entry

Change the contents of control memory and ECS.

Channel control

Control activity on a specified data channel in circumstances where abnormal hardware and/or system operation is detected.

Transaction subsystem

Control operation of the transaction subsystem after it is brought to a control point.

Although all DSD commands (approximately 100) are generally available, many of them are seldom used in a normal production environment. Many DSD commands are used only by the system analyst for maintenance or debugging purposes. These commands include all memory entry and channel control commands as well as several commands in the other categories listed.

When unusual problems arise, do not attempt corrective action unless you have considerable experience in that area or have received specific instructions relating to the current problem. If not, consult a systems analyst to determine corrective action. Attempts to correct a system problem can often destroy information required to eliminate repetition of the problem.

To assist customer engineers in maintaining the hardware, the system enters the first characters (up to 25) of the following commands into the error log after each execution.

OFFxx.

ONxx.

99.

Memory entry commands

Channel control commands

Any other commands that the system analyst specifies at installation time.

These commands are prefixed by the characters DS in the error log but otherwise appear exactly as they are entered. This feature can be enabled and disabled using the 99 command (refer to System Control Commands).

The manner in which the DSD commands are entered and the use of special keyboard characters is described in section 1. Command formats are fixed field; that is, the fields in the command format must be specified as shown. Embedded blanks are allowed in octal fields. Leading spaces in operator entries are not allowed.

Since the commands that follow are arranged according to function rather than alphabetically, use the alphabetical command index inside the front cover for a quick page reference.

DAYFILE COMMANDS

The system saves messages in five types of dayfiles.

System dayfile

Control point dayfile

Account dayfile

Error log dayfile

Binary maintenance log dayfile

The system dayfile keeps a history of all control statements for all jobs processed. Control point dayfiles keep entries for individual jobs. The account dayfile keeps a record of all resources charged to a job. This dayfile can be used for customer billing and other accounting purposes. The error log dayfile records system error messages, such as disk errors. The binary maintenance log dayfile records the information used in Control Data maintenance in binary format. The following commands dump the system, account, or error log dayfile to a specified device or to a system-defined device. The system automatically prints the control point dayfile at the end of the job's output. The binary maintenance log dayfile is designed to be processed through an interpreter program, and therefore is normally dumped to tape or disk. Refer to section 4 for descriptions of dayfile displays as well as additional information on dayfile messages and commands.

<u>Command</u>	<u>Description</u>
DAYFILE,xx.	Requests that system dayfile be dumped to equipment specified by EST ordinal xx. If the equipment specified is a mass storage device, the dayfile is written on the device and the resultant file is put in the output queue for printing. The mass storage file is not permanent. If a tape is assigned, the dayfile is written on the tape in default format.
DAYFILE,.	Requests that system dayfile be dumped to system-defined mass storage. The resultant mass storage file is put in the output queue for printing.
ACCOUNT,xx.	Requests that account dayfile be dumped to equipment specified by EST ordinal xx. If the equipment specified is a mass storage device, the dayfile is written on the device and the resultant file is put in the output queue for printing. The mass storage file is not permanent. If a tape is assigned, the dayfile is written on the tape in default format.
ACCOUNT,.	Requests that account dayfile be dumped to system-defined mass storage. The resultant mass storage file is put in the output queue for printing.
ERRLOG,xx.	Requests that error log dayfile be dumped to equipment specified by EST ordinal xx. If the equipment specified is a mass storage device, the dayfile is written on the device and the resultant file is put in the output queue for printing. The mass storage file is not permanent. If a tape is assigned, the dayfile is written on the tape in default format.
ERRLOG,.	Requests that error log dayfile be dumped to system-defined mass storage. The resultant mass storage file is put in the output queue for printing.

JOB PROCESSING CONTROL COMMANDS

Under normal circumstances, control over job processing is performed automatically by the system. Although the following commands may not be used frequently, they provide an added measure of control over job processing. Several of the commands described here change internal system parameters which control job scheduling and processing. Give careful consideration to their use since job flow and overall system performance can be affected. Refer to the individual command descriptions for further information.

LOAD,xx,yy.

Requests that a job be loaded from equipment defined by EST ordinal xx (normally tape unit). The job is assigned a numeric identifier yy which can range from 00 to 67 octal. Examine the E display (refer to section 4) to determine the EST ordinal of the equipment to be used.

CRxx,yy.

Assigns a numeric identifier (ID) yy to the card reader defined by EST ordinal xx. The value of yy can range from 00 to 67 octal. All subsequent jobs loaded from card reader xx will be assigned the identifier yy.

ENID,yy,fmt.

Assigns a numeric identifier (ID) yy to a batch origin output queue entry defined by FNT ordinal fmt. The FNT ordinal is determined by examining the H display (refer to section 4). Valid queue type files to which an identifier may be assigned are listed in the H display as PR (print) and PH (punch). The value of yy can range from 00 to 67 octal. This ID remains assigned to the entry only as long as the system remains up and the entry is in the output queue. Use the QALTER utility to make the ID assignment permanent.

CPxx,yy.

Assigns a numeric identifier (ID) yy to the card punch defined by EST ordinal xx. The value of yy can range from 00 to 67 octal. In this manner, only those files in the punch queue with an identifier equal to yy are directed to card punch xx. Refer to description of LOAD, CR, and ENID commands to assign an identifier to a job or queue type file.

LPxx,yy. or LRxx,yy. or LSxx,yy. or LTxx,yy.

Assigns a numeric identifier (ID) yy to the line printer defined by EST ordinal xx. The value of the identifier can range from 00 to 67 octal. In this manner, only those files in the print queue with an identifier equal to yy are directed to line printer xx. Refer to description of LOAD, CR, and ENID commands to assign an identifier to a job or queue type file. The user usually assigns the ID to the file.

FORMxx,fc.

Assigns a two-character forms code (FC) fc to the line printer or card punch defined by EST ordinal xx. Only those files in the output queue assigned the forms code fc are directed to equipment xx. A user can assign a forms code to an output file via the ROUTE control statement. (For a description of the ROUTE statement, refer to the NOS Reference Manual, Volume 1.) The value of the forms code can range from AA to 99. If forms code is not present, the current forms code field is cleared (value is null).

NOTE

For best system performance, the forms code should be a value from AA to AF or null.

n.ROLLOUT.

Removes job currently assigned to control point n and places it in the rollout queue. The queue priority for the job is set to 1. This is a special queue priority value which indicates that the job will not be scheduled back to a control point automatically. That is, your action is required to return the job to a control point. This can be done by using the ROLLIN,fnt. command or resetting the job's priority with either the ENQP,pppp,fnt. or ENPR,pppp,fnt. commands

n.ROLLOUT,xxxx.

Removes job currently assigned to control point n and places it in the rollout queue for xxxx job scheduler delay intervals. The job is automatically scheduled back to a control point after this period of time. However, you can return the job to a control point before the time specified by xxxx has elapsed through the use of the ROLLIN,fnt., ENQP,pppp,fnt., or ENPR,pppp,fnt. commands.

The amount of time required for one job scheduler interval is initially set in the IPRDECK but may be changed via the DELAY command (JS parameter) described later in this section. Normally, it is a one second interval.

ROLLIN,fnt.

Allows the job defined by FNT ordinal fnt to be scheduled to an available control point. The system does this by assigning maximum queue priority (MXPS) to the job. Examine the H display (refer to section 4) to determine the FNT ordinal of the job.

n.CKP.

Checkpoints job currently assigned to control point n. The checkpoint information includes a copy of the job's central memory, the system information used for job control, and the name and contents of all local files currently assigned to the control point. It is the responsibility of the user's job to establish a magnetic tape or mass storage permanent file to receive the checkpoint information. Otherwise, checkpoint information is automatically written to a local file named CCCCCC and will not be available if a restart becomes necessary (RESTART is also user-controlled and is accomplished via control statement). Use of this command should be discreet (typically used at the request of or by the site analyst) since job and system overhead are increased. Refer to the NOS Reference Manual, Volume 1 for supplementary information concerning the checkpoint/restart feature available to users.

NOTE

If a job has secure system memory (SSM) status set, it cannot be checkpointed. SSM status is set for certain jobs to prevent dumping of the job's field length. Also, subsystems or jobs with a queue priority greater than MXPS or less than MNPS may not be checkpointed.†

The following job control commands affect scheduling and execution of jobs in the system. These commands are normally used only by the site analyst although you may also be required to use them periodically. However, do not enter these commands unless specifically directed to do so. Improper use of these commands can drastically hamper job flow as well as system performance. In certain cases, jobs may be lost.

n.ENTL,timlmt.

Enters time limit of timlmt for job currently assigned to control point n. The value of timlmt can range from 0 to 77777 octal (values 77770 to 77777 are considered infinite). The value entered is rounded up to a multiple of 10g. This command overrides the time limit specified when the job entered the system. The current time limit can either be increased (up to maximum value) or decreased. However, if the value of timlmt is less than the current elapsed time, the job aborts.

n.ENPR,pp.

Enters CPU priority pp for job currently assigned to control point n. The value of pp can range from 1 to 70 octal. This command overrides the CPU priority set by the SERVICE command. The current CPU priority can be either increased (up to maximum value) or decreased. Note that this command is valid only if the queue priority for the job does not exceed MXPS.†

n.ENQP,pppp.

Enters queue priority of pppp for the job currently assigned to control point n. The value of pppp can range from MNPS (minimum queue priority)† to MXPS (maximum queue priority).† This command overrides the current queue priority. The current queue priority can be either increased or decreased. This command is valid only if the current queue priority for the job does not exceed MXPS.

ENQP,pppp,fnt. or ENPR,pppp,fnt.

Enters queue priority of pppp for a queue type file defined by FNT ordinal fnt. The FNT ordinal is determined by examining the H display (refer to section 4). The value of pppp can range from MNPS to MXPS.† The value specified overrides the current queue priority for the file. The current queue priority can either be increased or decreased using this command.

† The released values for MNPS and MXPS are 0100 and 7760 octal, respectively. These values are subject to future change.

n.RERUN,pppp.

Terminates the job currently assigned to control point n, then reruns the job from the beginning with a queue priority of pppp. The job must be in rerun status as set by the RERUN control statement or macro. The value of pppp can range from MNPS to MXPS.† This value overrides the current queue priority for the job.

QUEUE,ot,qt,qP1pppp,....,Pq1pppp.

Alters the queue priorities associated with the input, rollout, and output queues for each job origin type and job class. Examine the S display (refer to section 4) to determine the priority values currently associated with each job origin type and job class.

ot†† Job Origin Type

SY System

BC Local batch

TX Time-sharing

EI Remote batch

MT Multiterminal

ot†† Job Class

NS Network Supervisor

qt Job Queue Type

IN Input

RO Rollout

OT Output

qp Queue Priority

LPpppp Lowest priority at which a job can enter the queue and still be aged (MNPS ≤ pppp ≤ MXPS).†

OPpppp Original (entry) priority. This is the priority associated with the job when it initially enters the specified queue. The value of pppp is normally within the boundaries specified by LP and UP.

UPpppp Highest priority a job can reach in the specified queue; aging stops when this priority is reached. The job is also given this priority when initially assigned to a control point. The value of pppp is normally greater than LP and OP but cannot exceed MXPS.†

qp Queue Priority

INpppp Number of scheduler cycles before incrementing the job priority by one.

The priority associated with each queue is established via QUEUE command entries in the IPRDECK for each job origin type. These entries normally reflect the ideal queue priorities for the job mix of the particular installation. The values specified in the IPRDECK are considered critical to optimum system performance and are not normally altered. However, when necessary, the changes are usually temporary and the original values will be reset. Figure 3-1 provides space to record the original values (specified in the S display) for that purpose. For additional information concerning the QUEUE command, refer to the NOS Installation Handbook.

SERVICE,ot,P1pppp,....,Pnpppp.

Alters the service limits associated with each job origin type.

ot†† Job Origin Type

SY System

BC Local batch

TX Time-sharing

EI Remote batch

MT Multiterminal

ot†† Job Class

NS Network Supervisor

Pi Service Limits

PRpp CPU priority (1 ≤ pp ≤ 77g). Jobs with highest priority get CPU first. All job origin types except SY, NS, and MT are normally set to the same CPU priority. System (SY) jobs are run at the lowest CPU priority. Network supervisor (NS) jobs are run at a higher priority than any of the other job origin types to provide good response time to network users. Multiterminal (MT) jobs are normally set to a higher CPU priority than batch (BC) and timesharing (TX) jobs since they require little CPU time.

CPpppp CPU time slice (milliseconds *64). This parameter specifies the maximum amount of time a job of the specified origin type can use the CPU before its queue priority is set to the lower boundary. Only the last four digits entered are used.

†The released values for MNPS and MXPS are 0100 and 7760 octal, respectively. These values are subject to future change.
 ††Can specify job origin type or job class.

ORIGIN TYPE/ JOB CLASS	PRIORITIES FOR EACH QUEUE TYPE											
	INPUT QUEUE				ROLLOUT QUEUE				OUTPUT QUEUE			
	OP	LP	UP	IN	OP	LP	UP	IN	OP	LP	UP	IN
SY												
BC												
TX												
EI												
MT												
NS												

Figure 3-1. Record of Original Values in S Display

ORIGIN TYPE/ JOB CLASS	SERVICE LIMITS									
	PR	CP	CM	NJ	FL	AM	FC	CS	FS	DS
SY										
BC										
TX										
EI										
MT										
NS										

Figure 3-2. Record of Original Values

Pi

Service Limits

CMpppp

Central memory time slice in seconds. This parameter specifies the maximum amount of time a job of the specified origin type can remain at a control point before it becomes eligible to be rolled out. A job is not necessarily rolled out when its time slice is exceeded. It is set to a lower priority and then may be replaced by a job of higher priority. The value of pppp can range from 0 to 7777 octal. Only the last four digits entered are used.

Pi

Service Limits

NJpppp

Maximum number of jobs. For time-sharing origin jobs, this parameter specifies the number of terminals that can be logged into the system. The NJ parameter has no meaning for other job origin types. Only the last four digits entered are used.

FLpppp

Maximum field length/100g for any job of the specified job origin type. Jobs with field lengths which exceed this value are not considered for scheduling unless no other jobs are waiting

P_i Service Limits
 to be scheduled and sufficient field length is available without rolling out any jobs. However, a time-sharing job which exceeds the value for a time-sharing origin type job is aborted. Only the last four digits entered are used.

AMpppp Maximum field length/100_g for all jobs of the specified job origin type. This parameter is used to partition central memory by limiting the total field length available to each job origin type. For example, if scheduling a job to a control point exceeds the field length specified for its job origin type, it may not be scheduled until the required field length is available. This means that a lower priority job from a different origin may be scheduled first. However, a job that would normally exceed the field length for its job origin type can be scheduled to a control point if there are not enough jobs to fill the field length specified for another job origin type. The system always attempts to use central memory to its greatest capacity. Only the last four digits entered are used.

ECpppp Maximum ECS/1000_g for any job of the specified job origin type. Only the last four digits entered are used.

EMpppp Maximum ECS/1000_g for all jobs of the specified origin type.

FCv Number of permanent files allowed where v is used to specify the corresponding octal values shown in the following table.

<u>v</u>	<u>Limit Value</u>
0	Unlimited
1	10
2	20
3	30
4	40
5	50
6	100
7	Unlimited

P_i Service Limits
 CSv Cumulative size in PRUs allowed for all indirect access permanent files; v is used to specify the corresponding octal values shown in the following table.

<u>v</u>	<u>Limit Value</u>
0	Unlimited
1	1000
2	2000
3	5000
4	10 000
5	50 000
6	100 000
7	Unlimited

FSv Size in PRUs allowed for individual indirect access permanent files; v is used to specify the corresponding octal values shown in the following table.

<u>v</u>	<u>Limit Value</u>
0	Unlimited
1	10
2	20
3	30
4	40
5	50
6	60
7	Unlimited

DSv Size in PRUs allowed for individual direct access permanent files; v is used to specify the corresponding octal values shown in the following table.

<u>v</u>	<u>Limit Value</u>
0	Unlimited
1	1000
2	2000
3	5000
4	10 000

<u>Pi</u>	<u>Service Limits</u>
<u>v</u>	<u>Limit Value</u>
5	50 000
6	100 000
7	Unlimited

The service limits associated with each job origin type are established via SERVICE command entries in the IPRDECK. These entries normally reflect the ideal service limits for the job mix of the particular installation. The values specified in the IPRDECK are important to optimum system performance and are not normally altered. However, when changes are necessary they are usually temporary and the original values will be reset. Figure 3-2 provides space to record the original values for that purpose. For additional information concerning the SERVICE command, refer to the NOS Installation Handbook.

DELAY,t₁pppp,...,t_npppp.

Alters current system delay parameters. Examine the S display (refer to section 4) to determine the current delay parameter values.

<u>t_i</u>	<u>Delay</u>
JSpppp	Job scheduler interval in seconds. This parameter specifies the interval at which the job scheduler and priority increment routines are called. The scheduler may also be called at other times. This parameter cannot be zero.

<u>t_i</u>	<u>Delay</u>
CRpppp	CPU recall period in milliseconds. This parameter specifies the amount of time a job remains in recall (X status) when an RCL request is placed in RA+1. This parameter cannot be zero.
ARpppp	PP auto recall interval in milliseconds. This parameter specifies the time interval at which peripheral processor units (PPs) in auto recall are recalled. One PP routine is activated each time period. This parameter cannot be zero.
JApppp	This field is not currently used but reserved for future use.
CSpppp	CPU job switch interval in milliseconds. This parameter specifies the amount of time the CPU executes any one job if several jobs of equal CPU priority all require the CPU. This parameter cannot be zero.

The value for each system delay parameter may be established via a DELAY command entry in the IPRDECK. If no DELAY entry is present, default values are provided. Figure 3-3 provides space to record the original values (specified in the S display) in the event that any are altered temporarily. For additional information concerning the DELAY command, refer to the NOS Installation Handbook.

DELAY VALUES	
JS	
CR	
AR	
JA	
CS	

Figure 3-3. Record of Original Values in S Display

MSAL,t=xx₁,xx₂,...,xx_n.

Assigns job files of type t to mass storage device defined by EST ordinal xx. The specified mass storage device must be nonremovable. Examine the mass storage status (E,M.) display to determine if the device is nonremovable.

<u>t</u>	<u>File Type</u>
B	LGO
L	Local
D	User dayfile
P	Primary
O	Output
I	Input
T	Temporary
R	Rollout
S	Secondary rollout

If no devices are specified for a file type, the system selects a temporary device.

Secondary rollout files do not exist until the IPRDECK command SRST=nn (where n is the size in sectors of the file, 0 through 77₉) defines a threshold; the default value of a threshold is zero. All rollout files smaller than the threshold are secondary rollout files. These files are assigned to the devices specified with the MSAL, S=xx_i command.

All files greater than or equal to the threshold are assigned to the rollout file devices (MSAL, R=xx_i command).

The following example illustrates a use for secondary rollout files.

```

CMRDECK
.
.
EQ11=DP,ON, 1000, 27.   Equipment 11 is
                        ECS via DDP.
.
.
MSAL,S=11.              Assigns second-
                        ary rollout
                        files to ECS.
.
.
IPRDECK
.
.
SRST=20.                Sets the thresh-
                        old count so
                        files under 20
                        sectors long are
                        assigned to ECS.
.
.

```

For additional information concerning the SRST command, refer to the NOS Installation Handbook.

EVICT,fnt.

Eliminates queue type file defined by FNT ordinal fnt from the system. Examine the H or Q display to determine the FNT ordinal (refer to section 4).

For jobs evicted from the rollout queue, the system sets an error priority. Then it rolls the jobs in without their field length and aborts them. Job error processing is not allowed. Use this command rather than PURGE to eliminate from the rollout queue jobs requiring a large amount of field length since the system will roll them in without their field length. For all other queue type files, EVICT acts the same as PURGE.

NOTE

If the EVICT command is issued for an interactive job in the rollout queue, the job is logged off with no warning.

PURGE,fnt.

Purges queue type file defined by FNT ordinal fnt from the system. Examine the H display to determine the FNT ordinal (refer to section 4).

For jobs purged from the rollout queue, the system sets an error priority. Then it rolls the jobs in with their field length and aborts them. Job error processing is allowed.

PURGEALL,t.

Purges all files of queue type t from the system.

<u>t</u>	<u>Type</u>
I	Input
O	Output
P	Punch
R	Rollout†
T	Timed/event rollout† (sets error priority and is aborted when rolled back in)

n.DROP.

Drops the job currently assigned to control point n. The job's current output and dayfile (if any) are printed and the job is eliminated from the system.

NOTE

Before pressing CR, check to ensure that the correct control point number has been specified and that the job is still at the same control point.

n.KILL.

Drops the job currently assigned to control point n without exit processing. This command is useful for terminating jobs which loop in an exit processing sequence when n.DROP. is used.

NOTE

Before pressing CR, check to ensure that the correct control point number has been specified and that the job is still at the same control point.

n.OVERRIDE.

CAUTION

Exercise extreme caution in using the n.OVERRIDE. command. Undesirable situations (such as interlocks being left set, VSN entries remaining uncleared, or certain tape/PP activities left outstanding) could occur which would cause potentially damaging system activity. Never use this command during normal operations.

Certain types of job processing are unaffected by the n.DROP., n.KILL., and n.STOP. commands. These include operations such as setting permanent file device interlocks, interlocking files/tracks, clearing VSN entries, and waiting for certain types of tape/PP activity to end. The n.OVERRIDE. command terminates this type of processing and drops the job currently assigned to control point n regardless of queue priority. Unlock the console (refer to UNLOCK command) to enter this command. Use of this command is recorded in the error log dayfile.

The following job control commands are used to respond to a job currently assigned to a control point.

n.COMMENT.ccc...ccc. or n.*ccc...ccc.

Enters comment ccc...ccc (49 characters maximum) in the dayfile for control point n.

n.CFO.ccc...ccc.

Sends a message ccc...ccc (36 characters maximum) from the operator to the program currently assigned to control point n. The program sets bit 14 of RA and the message is placed in locations RA+70g through RA+74g of the program's field length.

† For jobs purged from the rollout queue, the system sets an error priority. Then it rolls the jobs in with their field length and aborts them. Job error processing is allowed.

n. ONSWx.

Turns on sense switch x (1≤x≤6) at control point n. Refer to Subsystem Control Commands in this section for definition of sense switches that can be set for the remote batch, BATCHIO, time-sharing, and transaction subsystems.

n. OFFSWx.

Turns off sense switch x (1≤x≤6) at control point n.

n. GO.

Clears the pause bit at control point n. A job may set the pause bit if an error is encountered or if an operator response is required. The pause bit causes the job to relinquish use of the CPU until it is cleared via entry of this command.

The following job control commands apply only to jobs of time-sharing origin. The time-sharing subsystem must be active at control point 1.

MESSAGE,ccc...ccc.

Changes TELEX header message output to terminal when TELEX user logs in to ccc...ccc (48 characters maximum).† This message also appears at the time-sharing subsystem control point on the B display (refer to section 4).

DIAL,nnnn,ccc...ccc.

Sends message ccc...ccc (48 characters maximum) to terminal currently using line number nnnn. Examine the T display (refer to section 4) to determine the appropriate line number. The message is sent to the terminal immediately except when output is being sent to the terminal. In that case, the message follows the output data.

WARN,ccc...ccc.

Sends message ccc...ccc (48 characters maximum) to all terminals currently logged into the system. The message is received at a terminal upon completion of the current command or at the end of a job step. Each subsequent terminal to log in also receives this message. This continues until either a new message is entered or the message is cleared (refer to following command). In addition, the current message also appears at the time-sharing subsystem control point on the B display.

When sent to a time-sharing terminal, the message ccc...ccc is always preceded by the statement

hh.mm.ss. WARNING

time (hours.minutes.seconds) when you entered the WARN command

For example, if the operator enters

WARN,SYSTEM SHUTDOWN AT 1500.

the following information would be transmitted to all terminals.

hh.mm.ss. WARNING

SYSTEM SHUTDOWN AT 1500.

This command is typically used to notify time-sharing users of an interruption in service or system shutdown.

WARN.

Clears message entered by the WARN,ccc...ccc. command. Unless this command is entered, the existing message (if any) will continue to be transmitted to each new terminal that logs into the system.

PERIPHERAL EQUIPMENT CONTROL COMMANDS

The commands described in this category provide overall control of the peripheral equipment available to the system.†† Become familiar with the following DSD displays which are closely associated with the use of these and other commands described throughout this section.

- Equipment status table (EST) display.
- Mass storage status table display.
- Tape status display.
- Resource mounting preview display.

A complete description of each of these displays is given in section 4 of this manual.

n.ASSIGN,xx.

Assigns equipment defined by EST ordinal xx (normally tape unit) to job at control point n. This command is entered in response to a flashing REQUEST message at that control point. Use of this command for assignment of a tape unit should not normally be required because tape assignment is performed automatically when a volume serial number (VSN) is specified in the job request. However, if a VSN is not specified in the job request for a labeled or unlabeled tape, the REQUEST message appears at the job's control point (on B display), and the ASSIGN command must be entered to assign a tape unit to the job.

VSN,xx,vsn.†††

Assigns VSN vsn to an unassigned magnetic tape unit defined by EST ordinal xx. This command allows you to specify a 1- to 6-character VSN for a mounted, unlabeled tape so it may be assigned and referenced automatically. For example, when a job specifies a VSN in the request for an unlabeled tape, an entry for that job appears in the resource mounting preview display (E,P.). This display indicates the FNT ordinal of the job, the type of tape unit, 7-track (MT) or 9-track (HD, PE, or GE), on which the tape is to be mounted, the required VSN, user number of the job, and the required write ring status (IN or OUT). If the correct tape is not currently mounted, mount the tape on an available unit (ensuring that track type and write ring status are

† IAF users do not receive the message; it appears only at the IAF control point.

†† Operation of peripheral equipment is described in appendix D.

††† Special characters cannot be entered using this command. If a special character is encountered in vsn, the VSN entered is truncated at the character preceding the special character.

correct), read the unit, and enter this command. The system equates the VSN entered by you with that specified by the job and assigns the tape automatically upon demand.

If the tape mounted on the tape unit defined by EST ordinal xx is a labeled tape, has already had a VSN assigned by console command, or has not yet been checked for a label by MAGNET, this command is ignored. The message

ILLEGAL ENTRY.

appears on the left console screen. To change a VSN previously assigned by this command, clear the first VSN by entering

VSN,xx.

xx EST ordinal of the tape unit.

The command

VSN,xx,vsn.

vsu New VSN.

can then be entered. (The preceding message and procedure for changing a VSN are also applicable to the VSN,xx, command.)

If a job specifies a VSN in the request for a labeled tape, assignment occurs automatically, without your intervention, unless the correct tape is not mounted. In this case, an entry is formed in the resource mounting preview (E,P.) display which describes the tape to be mounted. When the tape is mounted and the tape unit made ready, assignment occurs automatically without additional intervention by you. For multireel files, automatic tape assignment occurs only if the tape units on which the tapes are mounted are similar and on the same channel(s). That is, if the first reel of the file is on a 669 tape unit on channels 13 and 33, all subsequent reels must be on a 669 unit on channels 13 and 33. When assigning tapes, models 679-2, -3, and -4 drives (800/1600 cpi) are similar. Also models 679-5, -6, and -7 drives (1600/6250 cpi) are similar.

If two or more unassigned tapes having identical VSNs are mounted on units of the same track type, the flashing message

REQUEST,eq,vsu

appears on the B display. The eq field is either the device type MT or the density requirement HD, PE, or GE; vsu is the VSN required.

You must assign one of the tapes using the ASSIGN command. If the duplicate VSNs are SCRATCH, the resource executive routine RESEX assigns one automatically

NOTE

It is not possible to specify a VSN of SCRATCH with this command since only six characters may be used to define a VSN. To define a scratch tape (used to satisfy scratch VSN requests), refer to the description of the SCRATCH,xx, command.

SCRATCH,xx.

Declares the tape mounted on an unassigned magnetic tape unit, defined by EST ordinal xx, to be a scratch tape. This command enables a tape to be available to satisfy scratch VSN requests and still be assigned by its original VSN. Thus, the VSN defined on the tape (in VOL1 label) is not redefined as scratch although the VSN will appear as SCRATCH on the tape status (E,T.) display.

Scratch status is retained for only one job assignment. This allows a tape to be used for scratch purposes on a temporary basis. For example, a job requests a tape mounted on the tape unit defined in this command by specifying the current VSN for that tape in the request. The tape is then assigned to the job as a scratch tape (the original VSN is retained and not made scratch). When that job releases the tape, SCRATCH status is cleared, and unless this command is entered again, that tape would not be assigned as a scratch tape in future requests. To determine if SCRATCH status is in effect for a tape, monitor the tape status (E,T.) display.

VSN,xx,.

Declares the tape mounted on an unassigned magnetic tape unit, defined by EST ordinal xx, to be a scratch tape. This command is similar in function to the SCRATCH,xx, command in that it enables a tape to be available to satisfy scratch VSN requests. However, if the tape is labeled and a write function is performed, the VSN specified in the VOL1 label will be rewritten as a scratch VSN, destroying the original VSN and making the tape available for future scratch VSN requests. The VSN also appears as SCRATCH on the tape status (E,T.) display. Refer to the VSN,xx,aaaaaa, command for a discussion of the ILLEGAL ENTRY message which is also applicable to VSN,xx,.

VSN,xx.

Clears current VSN for magnetic tape unit defined by EST ordinal xx and then checks to determine if a VSN is specified in the VOL1 label of the tape mounted on that unit. This command is valid only if the tape unit specified is not currently assigned.

UNLOAD,xx.

Physically unloads a tape or logically removes a removable mass storage device from the operating system. Also, in a multiframe environment, the UNLOAD command must be issued if another mainframe wants to initialize a shared mass storage device, whether the device is removable or nonremovable (refer to INITIALIZE command). The device to be unloaded is defined by EST ordinal xx (examine the E display to determine the EST ordinal). If a magnetic tape is specified, the tape is physically unloaded. If a removable mass storage device is specified, you can dismount the disk pack on that device.

NOTE

If a nonremovable shared mass storage device is to be specified, the console must be unlocked (refer to UNLOCK command).

Magnetic tape units: If a tape is currently assigned to a job, it cannot be unloaded. If this is attempted, the UNLOAD command is ignored and the following message appears on the left console screen.

UNIT NOT AVAILABLE

Examine the tape status (E,T.) display before entering the UNLOAD command to determine if the tape to be unloaded is currently assigned to a job. If the tape is not currently assigned, entering this command unloads the specified tape.

Mass storage devices: The UNLOAD command is valid for any shared mass storage device in a multiframe environment for the purpose of initialization. Otherwise, the command is valid only for removable devices. (Only removable devices may be physically removed by unloading.) After entering the UNLOAD command, monitor the mass storage status (E,M.) display. Execution of this command immediately causes local unload (L) status to appear in the STATUS field for that device. While L status is displayed, no new users are permitted to access files on the device. A user currently accessing files on the device can continue while at least one direct access file from the device is attached to the job. When the user count is zero and there are no checkpoint requests pending, one of the following two actions occurs.

- If the device is removable and the L status is set in all machines accessing the device, global unload (N) status is displayed. This indicates that the device may now be physically dismounted.

NOTE

If a situation occurs such as a DI-2 family mounted on two DI-1's, only the first DI-1 shows global unload status.

- If an initialize is pending on the device and all other machines accessing the device have L status set, the initialization proceeds. However, initialization cannot take place if the device has been unloaded.

NOTE

A device should be physically dismounted only if global unload status (N) is displayed on all machines accessing the device.

If a removable pack is dismounted before the N status is displayed, the following may occur.

- Mass storage device status errors.
- Permanent file errors when pack is remounted at some later date.
- If another pack has been mounted, accesses made by a previously attached user may destroy information on the new pack or the user may retrieve information from the new device which he is not necessarily privileged to access. Mass storage device status errors are also possible in this situation.

NOTE

If the Mass Storage Subsystem (MSS) is active, it must be idled before unloading a removable family pack which has MSS files. After dismounting the family pack, MSS can be initialized again.

MOUNT,xx.

Clears local unload (L) and global unload (N) status for a mass storage device and reactivates the device. The device is defined by EST ordinal xx (examine the E display to determine the EST ordinal).

If the device defined by EST ordinal is not a mass storage device, the MOUNT command is ignored and the following message appears on the left console screen.

ILLEGAL EQUIPMENT.

If the device is shared in a multimainframe environment and another mainframe has an unsatisfied initialize request pending for that device, the MOUNT command is ignored and the following message appears at the system control point on the job status (B) display.

INITIALIZE PENDING ON THIS DEVICE.

OFFxx.

Logically turns off device defined by EST ordinal xx. This command allows the operator to logically remove a device from the operating environment. Examine the E,A. display to determine the EST ordinal and current status (ON or OFF) of the device. If xx specifies a mass storage device and the system library or temporary files (local, rollout, and so forth) reside on that device, it should not be turned off. Examine the mass storage status (E,M.) display (refer to section 4) to determine which mass storage devices have system residency or allow system allocation of temporary files. In addition, if an MSAL entry is currently specified for a mass storage device, it is cleared when that device is turned off. The MSAL designation is not reset automatically when the device is turned back on and must be reset manually (if necessary) via the DSD command MSAL (refer to Job Processing Control Commands).

ONxx.

Logically turns on device defined by EST ordinal xx. This command allows you to activate a device currently having OFF status in the EST. Examine the E,A. display to determine the EST ordinal and current status (OFF or ON) of the device.

DOWN, CHcc. or DOWN,CHcc,EQxx.

Discontinues use of channel cc for all tape and storage I/O operations. If channel cc is the only channel available to a mass storage device, its use will not be discontinued for that device. If EQxx is specified, as in the second form of the command, channel cc is discontinued only for mass storage equipment xx. The equipment specification is legal only for mass storage equipments. If channel cc is not defined as a magnetic tape or mass storage channel, the command is ignored and the following message appears on the left screen.

ILLEGAL ENTRY

This command is normally used only by the site analyst or customer engineer. It should be used with caution since it directly affects the operation of system peripheral equipment.

UP, CHcc. or UP,CHcc,EQxx.

Resumes normal use of channel cc by tape units and/or mass storage, reversing DOWN condition.

† Device must be removable.

If EQxx is specified, as in the second form of the command, use of channel cc resumes only for mass storage equipment xx. The equipment specification is legal only for mass storage equipments. If channel cc is up, the command is ignored and the following message appears on the left screen.

ILLEGAL ENTRY

This command is normally used only by the site analyst or customer engineer. It should be used with caution since it directly affects the operation of system peripheral equipment.

TEMP=xx1,xx2,...,xxn.

Reverses current set or clear condition of temporary file status for mass storage devices defined by EST ordinals xx. When temporary file status is set, the system can use the specified device for allocation of temporary files. This command is not valid if the device specified is defined as removable. Examine the mass storage status (E,M.) display (refer to section 4) to determine:

- EST ordinal of device.
- If device is defined as removable.
- If temporary file status is currently selected (set) for the device.

FORMAT,xx.

Reverses current format pending status for device xx. When this status bit is set, the full initialize status bit is automatically set also. However, if the format pending status is cleared, the full initialize status bit is not changed. Unlock the console before entering this command (refer to UNLOCK command).

VALIDATE,xx.

Causes validation of mass storage tables associated with the equipment defined by EST ordinal xx. The equipment must be available mass storage and the MS VALIDATION option must have been selected in the IPRDECK at deadstart.

INITIALIZE,xx,op.

Reverses current setting of initialize option op for mass storage device defined by EST ordinal xx (examine E,A. display to determine correct EST ordinal).

<u>op</u>	<u>Level of Initialization</u>
AL	Total initialize
HT	Total initialize as half track device†
FT	Total initialize as full track device†
PF	Permanent files
QF	Inactive queue files
DF	Inactive system dayfile
AF	Inactive account dayfile

<u>op</u>	<u>Level of Initialization</u>
EF	Inactive error log dayfile
FP	Format pending †
MF	Binary maintenance log

This command provides the capability to initialize and flaw tracks on any mass storage device during normal system operation.

If local unload (L) status is set for the device, the INITIALIZE command is ignored and the following message appears on the left console screen.

ILLEGAL ENTRY.

However, the INITIALIZE command will be allowed to execute while local unload is set if an error code (CE, IL, LE) is set.

Entry of this command does not in itself initialize the specified device. It merely sets initialize status for the device so that it may be initialized. However, if fast attach files (special system files) are active on the specified device and initialization level of AL or PF is specified, initialize status cannot be set until these files are returned. In this case, the message

FAST ATTACH FILES ON DEVICE.

appears at the system control point on the job status (B) display. Refer to the description of this message in appendix B for additional information.

The procedure involved in initializing a mass storage device is outlined later in this description. The following describes system activity when initialization occurs.

If the device is shared in a multimainframe environment, initialization does not proceed until all other mainframes sharing the device have processed an UNLOAD command for the device and user counts on all machines are zero. If all machines have not unloaded the device, the following control point message is displayed.

EQxx BUSY ON ID=nn.

nn is the machine ID of the first machine found without unload status set and xx is the EST ordinal.

If initialize status is set on this device for another mainframe, the INITIALIZE command is ignored and the following message appears at the system control point on the job status (B) display.

INITIALIZE PENDING ON THIS DEVICE.

When the AL initialization option is specified, the label on the device to be initialized is either updated or a new label is created. If the label on the device is bad or cannot be recognized, the new label is created and all current data on the device is lost. If the label is found to be good, it is updated and all permanent file information is

cleared. In this case, system library or temporary files (local, rollout, and so forth) residing on the device are not disturbed. If the device being initialized is a master device, the system scans all other mass storage devices in the family that contain direct access files and releases the space for files with catalogs on this device. If the device being initialized contains direct access files, the system scans all other master devices and sets the catalog entries on those devices to indicate that the files were purged. All or part of the permanent file system can be initialized and then reloaded if necessary (refer to the description of permanent file utilities in the NOS System Maintenance Reference Manual).

The INITIALIZE command can also be used to reconfigure certain removable devices (844-21 and 844-41/44) to suit user needs. For example, if a user currently has two single unit 844 packs (DK-1s), both packs can be initialized and linked together to form a multispindle device (DK-2). However, this can only be done if the following requirements are met for the devices to be linked.

- Same device type.
- Same channels.
- Same share status (shared or nonshared).
- Removable.
- Not currently in use.

The INITIALIZE command must be entered to set initialize status for each device to be chained. Current multispindle devices can also be initialized providing all packs that form the device are mounted in logical order as determined by the unit list on the E,C display. It is only necessary to enter the INITIALIZE command for the first unit of a current multispindle device.

NOTE

Examine the COUNT field in the mass storage status (E,M.) display before entering the INITIALIZE command. The user count for the device must be zero before this command is valid.

The following procedure describes the steps necessary to initialize and (if necessary) flaw tracks on a mass storage device.

1. Enter the INITIALIZE command for the device(s) to be initialized followed by a carriage return. Examine the B display for the following message.

REQUEST*K*DISPLAY.

Note the number of the control point displaying the message.

† Sets format pending bit in the MST for 881/883 pack reformatting. Refer to the description of the FORMAT program in the NOS System Maintenance Reference Manual.

2. Activate the K display for that control point by typing

K,n.

n Control point number.

The K display (figure 3-4) appears on the left console screen. All parameters required to initialize and (if necessary) flaw the specified device are entered through the K display.

The top half of the K display lists all valid parameters used in initializing a device (under OPTION column). Refer to table 3-1 for a description of each option. Flaw entries (RTK, STK, and TTK) are described on the bottom half of the display. Refer to table 3-2 for additional information. The EST ordinal of the device to be initialized is listed in the center of the display under INITIALIZE EQUIPMENT.

TABLE 3-1. DEVICE DEFINITION OPTIONS†

Option	Description
FM=	One- to seven-character family name. Specifies the permanent file family in which the initialized device is to be included. All devices must have a family name or packname. The name 0 (single character zero) is reserved and cannot be used. This parameter cannot be used to change the family name of the link device in a multimainframe environment. If TY=X, this option specifies a one- to seven-character packname to be associated with an auxiliary device. To clear an existing entry, FM=NULL must be entered.
UN=	One- to seven-character user number. This option is specified only when initializing an auxiliary device (TY=X). If specified, the device is considered to be a private auxiliary device. Only the user number specified will be allowed to create files on the device (perform SAVE, REPLACE, or DEFINE requests). To clear an existing entry, UN=NULL must be entered.

```

*** MASS STORAGE DEVICE INITIALIZATION ***

CURRENT INITIALIZATION OPTIONS
*TOTAL*
OPTION VALUE DESCRIPTION
FM = 0 FAMILY NAME/ PACK NAME
FM = PACK NAME FOR TYPE =X
UN = 0 USER NUMBER
TY = 0 ACCESS TYPE - F OR X
DM = 0 DEVICE MASK
SM = 0 SECONDARY MASK
NC = 0 CATALOG TRACKS
EQ = 0 EST ORDINAL OF DEVICE
NP = 0 NUMBER OF PACKS
DN = 0 DEVICE NUMBER
INITIALIZE EQUIPMENT
(list of equipment to be initialized)

RTK,STK AND TTK ENTRIES, ENTER SINGLY
GENERAL FORMAT- XTK=A.
WHERE, *XTK* IS-
RTK = RESERVE TRACK
TTK = TOGGLE TRACK
STK = SET LOGICAL TRACK
AND *A* = EQUIPMENT FORMAT-

DE/DP - A000000 = ADDR/10B
DI - 0000 STK ONLY
DJ - 0000 STK ONLY
DK - 0000 STK ONLY
DL - 0000 STK ONLY
DM - 0000 STK ONLY
DQ - 0000 STK ONLY

LIMIT = 20B ENTRIES.

```

Figure 3-4. K Display for INITIALIZE Command

TABLE 3-1. DEVICE DEFINITION OPTIONS† (Contd)

Option	Description
DM=	Three-digit (octal) device mask (0 to 377). This option is required whenever a permanent file master device is being initialized. It defines which users will have this device as their master device. This option cannot be entered if TY=X.
SM=	Three-digit (octal) secondary device mask (0 to 377) used to control the residence of direct access files. This option is only meaningful on family devices.
NC=	Octal number of catalog tracks (power of two). This option is used only if the number of catalog tracks specified as system default for the device type is not satisfactory. The maximum value is 200g.
EQ=	EST ordinal of device to be initialized. For multispindle devices, this must be the first of NP consecutive removable units.
NP=	Number of physical units to be included in a multispindle device. The default value is 1. Each unit to be included in the multispindle chain must currently be defined as removable in the mass storage status (E,M.) display (refer to section 4).
DN=	Two-digit (octal) logical device number (1 to 77) that uniquely identifies the device in its permanent file family. This option is not entered if TY=X.
TY=F	Initialized device may contain direct and indirect access permanent files. However, if DM=0, only direct access files may reside on the device. If SM=0 and DM=0, the device may only contain special system permanent files. Indirect access files can only reside on a master device (that is, DM≠0).
TY=X	Initialized device is an auxiliary device. This is a mass storage device that is not part of a permanent file family. An auxiliary device is a supplementary permanent file storage device that may be privately owned (UN option specified) or may be shared by many users (UN not specified). Auxiliary devices may contain direct or indirect access permanent files.
†Device definition may be changed only if AL initialization is specified.	

TABLE 3-2. TRACK FLAWING OPTIONS†

Option	Description
RTK	Converts input physical address to a logical address and sets TRT to indicate that track is a reserved, flawed track.
TTK	Input is the same as RTK option but track reservation is toggled. That is, if the track was previously not reserved, this option produces the same results as the RTK option. If the track was previously reserved as a flawed track, that reservation is removed.
STK	Performs the same function as RTK except that input address is a logical address (no conversion required).
†Flawing of 881 and 883 disk packs is automatic; only flaws additional to current information should be entered.	

3. Enter the INITIALIZE command for each additional device to be initialized. This can also be done before activating the K display. In either case, only the first device specified will initially be listed (by EST ordinal) in the K display. Thus, to update the K display to show additional devices, enter the following command.

K.RERUN.

If more than one device is listed, they are initialized one at a time as they appear in the list from left to right. Multispindle devices (more than one EST ordinal) are considered one device.

4. The system has already checked the label on each mass storage device. If the label was found to be good, it is necessary to enter parameters (requested in messages that appear in the K display) to identify the device. This is to ensure that the device selected is indeed the correct device to be initialized. The messages appear automatically and are displayed until the correct parameter is entered. If an incorrect parameter is entered, it is ignored. Refer to table 3-1 for a description of each storage parameter. Examine the mass storage status (E,M.) and/or mass storage configuration (E,C.) display to determine the current parameter values.

The following possible messages may be displayed and the appropriate response should be entered. If none of these appears, the device label was not recognized or was found to be bad. In this event, proceed to step 5.

- ENTER OLD FAMILY NAME

This message appears only if more than one family of permanent file devices are currently active in the system. Enter the following response.

K. FM=family name.

- ENTER OLD DEVICE NUMBER

This message appears if the device to be initialized is a permanent file family device. Enter the following response.

K. DN=device number.

- ENTER OLD PACK NAME

This message appears only if the device to be initialized is an auxiliary device. Enter the following response.

K. PN=pack name.†

- ENTER OLD USER NUMBER

This message appears only if the auxiliary device to be initialized is a private auxiliary device (associated with a specific user number). Enter the following response.

K. UN=user number.†

If it is discovered that the wrong device was specified in the INITIALIZE command, initialize status for that device can be cleared by entering

K. CLEAR.†

The device to be processed by the clear entry must be a valid device. That is, the device cannot have a device number that conflicts with another device in its family or a pack name that duplicates one already in the system. Its mask bits must meet standard requirements.

The leftmost device in the list of devices to be initialized is cleared. One of the preceding messages will then be displayed for the next device to be initialized (if any) providing the label on that device is good.

5. When the following message appears on the K display, enter the parameters which specify the new characteristics to be associated with the device when it is initialized (refer to tables 3-1 and 3-2).

ENTER PARAMETERS

The new parameters can be entered one at a time or as a string. For example:

K.option₁=value₁,...,
option_n=value_n.

or

K.option₁=value₁.

K.option₂=value₂

K.option_n=value_n.

If flaw entries are to be specified (refer to table 3-2), they must be entered singly as illustrated in the last example. If the label on the device being initialized was good, all current flaws on that device are normally recovered. However, if the label was not recognized or was bad, the flaw entries cannot be recovered and must be entered (if necessary) using this mechanism. A maximum of 20 octal flaw entries are permitted. In addition to RTK, TTK, and STK entries, the flaw information recorded in the utility sector on an 881 or 883 disk pack is read during initialization of 844 equipment and the appropriate areas automatically reserved by the system.

If the NP option is specified (NP≠0), the device is to be initialized as a multispindle device. In this case, the number of packs specified by NP indicate the number of spindles to be linked. This is the next n number of devices waiting to be initialized. Each device must be defined as removable and mounted on consecutive physical unit numbers. To determine if a device is defined as removable, examine the mass storage status (E,M.) display (refer to section 4). If the units are configured correctly, the labels on each unit are checked. If any label is not recognized or is bad, that unit is free for initialization and chaining. However, if the label is good, the message

ENTER IDENTITY OF EQxx

appears in the K display (xx is the EST ordinal of the device). One of the following responses is required.

- K. FM = family name, DN = device number.

†All parameter entries must be prefixed by K period (K.). However, when pressing CR after the first parameter entry, everything but the K. is erased. This allows another parameter to be entered without first having to enter K. If it becomes necessary to enter a DSD command during parameter entry, simply press BKSP to erase the K., enter the command, and then continue parameter entry by typing K. and the parameter.

- K. DN = device number.
- K. PN = pack name.
- K. PN = pack name, UN = user number.

This is a precautionary measure to ensure that the devices specified are the correct devices to be chained.

6. After all the necessary parameters have been entered for a specific device, enter the following command to proceed with initialization.

K. GO.

If there are remaining devices waiting to be initialized, steps 4 through 6 of this procedure are repeated for each device.

TRAINxx,y.

Assigns or changes print train identification y of line printer defined by EST ordinal xx. This command can set the identification if it was not specified in the EQ entry of the CMRDECK, or change an identification previously included in the CMRDECK. An LR designation in the EQ entry indicates a 580-12 line printer, LS is a 580-16 line printer, and LT is a 580-20 line printer. LP is applicable to all line printer types. Print trains supported for the 580 printers are 596-1 and 596-5. The y field specifies the print train.

<u>y</u>	<u>Print Train</u>
1	596-1 (for CDC graphic 64-character set files); default.
2	Reserved for future use.†
3	Reserved for future use.†
4	596-5 (for ASCII graphic 64-character set files).
5	596-5 (for ASCII graphic 64-character set files).
6	596-6 (for ASCII graphic 95-character set files).
7	596-6 (to print ASCII graphic 64-character set files as on a 596-5).

BATCHIO EQUIPMENT COMMANDS

The following commands are valid only if the BATCHIO subsystem is currently assigned to a control point. The BATCHIO subsystem controls the local batch peripheral devices (card readers, card punches, and line printers). Current activity of BATCHIO equipment can be monitored on the BATCHIO (I) display. Refer to section 4 for information concerning the I display.

† These values are allowed but will default to 596-1.

BKSPxx.

Backspaces one logical record on print file on equipment defined by EST ordinal xx.

BKSPxx,rr.

Backspaces rr logical records on print file on equipment defined by EST ordinal xx.

BKSPFxx.

Backspaces one file on print file on equipment defined by EST ordinal xx.

BKSPFxx,ff.

Backspaces ff files on print file on equipment defined by EST ordinal xx.

BKSPRUxx,ss.

Backspaces ss sectors on print file on equipment defined by EST ordinal xx. Printing resumes at the beginning of a line.

CONTINUExx.

Resumes printing on equipment defined by EST ordinal xx.

ENDxx.

Terminates current operation on BATCHIO equipment defined by EST ordinal xx. If xx defines a line printer or card punch, BATCHIO will then assign the next available file to that equipment. If xx defines a card reader that is actively reading cards when ENDxx is entered, the job terminates at the last card read. The next card is treated as the beginning of a new job. If another card deck follows the end-of-information card (multipunch 6/7/8/9), it is processed normally.

If xx defines a card reader that is stopped because of a compare error when ENDxx is entered, perform the following steps:

1. Remove the remainder of the card deck, except the end-of-information card, from the card reader input hopper.
2. Ready the card reader to read the end-of-information card.

The job terminates and if another card deck follows the end-of-information card, it is processed normally.

ENDxx,yy.

Terminates current operation on BATCHIO equipment defined by EST ordinal xx. The yy parameter replaces any portion of the repeat count specified for that equipment (refer to REPEAT commands). For example, if the current operation on equipment xx had been set to be

repeated five times (operation performed six times), entering a value of 03 for yy would only permit the operation to be performed three times. If the repeat count is zero, this command performs the same function as the preceding command.

REPEATxx.†

Repeats the current operation on BATCHIO equipment defined by EST ordinal xx one time.

REPEATxx,yy.†

Repeats the current operation on BATCHIO equipment defined by EST ordinal xx the number of times specified by yy. The maximum value that can be entered for yy is 77 octal.

RERUNxx.††

Terminates current operation on BATCHIO equipment defined by EST ordinal xx and reenters the job in the correct queue at a default queue priority.

RERUNxx,yy.††

Terminates current operation on BATCHIO equipment defined by EST ordinal xx and reenters the job in the correct queue with a queue priority specified by yy00 (MNPS yy00 MXPS).

SKIPxx.

Skips forward one logical record on print file on equipment defined by EST ordinal xx.

SKIPxx,rr.

Skips forward rr logical records on print file on equipment defined by EST ordinal xx.

SKIPFxx.

Skips forward one file on print file on equipment defined by EST ordinal xx.

SKIPFxx,ff.

Skips forward ff files on print file on equipment defined by EST ordinal xx.

SKIPRUxx,ss.

Skips forward ss sectors on print file on equipment defined by EST ordinal xx (a sector is 100g central memory words); ss is limited to 10g sectors (the current buffer size) plus the number of sectors remaining in the buffer. If the buffer was empty, ss would be limited to 20g sectors. If ss is larger than the number of sectors remaining in the buffer, the buffer is filled again and the additional sectors skipped on the new print file. For example, if five sectors remained in the print file and ss was specified as 10, the remaining five sectors would be skipped, the buffer filled again, and five additional sectors skipped. Printing resumes at the beginning of a line.

STOPxx.

Stops printing on equipment defined by EST ordinal xx.

SUPPRESSxx.

Suppresses automatic printer carriage control on line printer defined by EST ordinal xx. Examine the I display to determine the correct EST ordinal. This command stops the page eject function on the line printer to provide a continuous listing for the current job.

SUBSYSTEM CONTROL COMMANDS

The commands that follow provide control over which subsystems are to be used. When a system deadstart is performed, parameters specified in the IPRDECK determine which subsystem will initially be available. Scheduling other subsystems to a control point or terminating a current subsystem depends on your action.

When a subsystem is scheduled to a control point, any job currently assigned to that control point will be rolled out if its queue priority is MXPS or less. However, if the job has a queue priority greater than MXPS, it cannot be rolled out and the command used to call the subsystem would not be valid. In this case, either terminate the job (if subsystem required that control point) or specify another control point. Under normal circumstances, do not terminate the job unless you have received specific instructions to do so.

n. CDCffff.†††

Calls the CYBER Database Control System (CDCS) to control point n. This command is not valid if a job currently assigned to control point n has a queue priority greater than MXPS. CDCffff.††† calls a procedure file named CDCffff under the system user index, which initiates the CDCS subsystem.

n. EXPffff.†††

Calls Export/Import subsystem to control point n. This should be the control point immediately preceding the system (last) control point. This command is not valid if a job currently assigned to control point n has a queue priority greater than MXPS. EXPffff.††† calls a procedure file named EXPffff under the system user index which initiates the Export/Import subsystem. Activity at the Export/Import control point can be monitored on the R display (refer to section 4).

The disposition of Export/Import punch files is controlled by setting sense switches as follows:

<u>Entry</u>	<u>Response</u>
n. ONSW1.	Sends all punch files to local batch (on site) card punch.
n. ONSW2.	Purge all punch files.
n	Control point number for Export/Import.

† When the current BATCHIO operation is repeated/rerun, maximum line and card limits are reinitialized prior to printing or punching of the file being processed. User control limits apply individually to each output file copy produced.
 †† Not currently used by the system but provided for support of a future product set member.
 ††† The characters ffff are optional; if required, installation personnel must supply the one to four alphanumeric characters to be used.

Sense switch 1 has precedence over sense switch 2. Export/Import punch files are ignored if neither is set.

n. IO.

Calls the BATCHIO subsystem to control point n. This should be the second from last control point. For example, if the system (last) control point is number 24, BATCHIO should be assigned to control point 22. This command is not valid if a job currently assigned to control point n has a queue priority greater than MXPS. BATCHIO must be active in order to use any of the local batch peripheral devices. Activity at the BATCHIO control point can be monitored on the I display (refer to section 4).

Response to line printer errors is controlled by setting sense switch 1 as follows:

Entry	Response
n. ONSW1.	Lines causing print error messages are not flagged or retried.
n	Control point number for BATCHIO.

n. MAGNET.

Calls the magnetic tape subsystem to control point n. This should be the third from last control point. For example, if the system (last) control point is number 24, MAGNET should be assigned to control point 21. This command is not valid if a job currently assigned to control point n has a queue priority greater than MXPS. MAGNET (the magnetic tape executive) must be active in order for tape processing and resource allocation to take place and to make the resource mounting preview (E,P.) available. Tape use can be monitored on the tape status and preview displays (refer to description of E display in section 4).

NOTE

Unit numbers on tape units must not be changed after MAGNET is initialized. Also, MAGNET should not be stopped (via the STOP command) while tapes are assigned.

n. MCSffff.†

Calls the message control system (MCS) to control point n. This command is not valid if a job currently assigned to control point n has a queue priority greater than MXPS. MCSffff.† calls a procedure file named MCSffff under the system user index, which initiates the MCS subsystem.

n.MSSffff.†

Calls the mass storage subsystem processing program to control point n. This command is not valid if a job currently assigned to control point n has a queue priority greater than MXPS. The MSSffff.† command calls a procedure file named MSSffff, under the system user index 377777g, which initiates the mass storage subsystem (MSS).

n.NAMffff.†

Calls the network access method (NAM) to control point n. This command is not valid if a job currently assigned to control point n has a queue priority greater than MXPS. NAMffff.† calls a procedure file named NAMffff under the system user index, which initiates several NAM supervisor modules. These modules appear momentarily at different control points as needed during NAM activity.

Additional commands which you can enter during NAM initialization are described in section 7.

n. RBFffff.†

Calls the remote batch facility (RBF) to control point n. This command is not valid if a job currently assigned to control point n has a queue priority greater than MXPS. RBFffff.† calls a procedure file named RBFffff under the system user index to initialize RBF. NAM must be active at a control point to use RBF.

IAFffff.†

Calls the interactive facility (network time-sharing subsystem) to control point 1. This command is not valid if a job running at control point 1 has a queue priority greater than MXPS. A time-sharing subsystem (either IAF or TELEX) must be active before jobs can be entered from a time-sharing terminal. Only one time-sharing subsystem can be active at a time. Use the T display (refer to section 4) to monitor activity at the time-sharing subsystem control point.

Ensure that NAM is active at a control point (refer to the B display) before you enter the IAFffff.† command.

Several options are available to control the operation of IAF. Select these options by setting sense switches after the subsystem is activated. Although normal operation does not require these sense switches to be set, sense switch 5 (1.ONSW5.) is set by default when the time-sharing subsystem is activated. Once set, the sense switches may be turned off again by entering 1.OFFSWx. (x is the sense switch number.)

Entry	Response
1.ONSW1.	When the time-sharing subsystem is terminated (by 1.STOP command), enter users into recover state and inhibit restarting operations.

† The characters ffff are optional; if required, installation personnel must supply the one to four alphanumeric characters to be used.

<u>Entry</u>	<u>Response</u>
1.ONSW2.	Enable the time-sharing subsystem to use the delay queue feature. This allows response time to appear more consistent to users by delaying response in a lightly loaded system. Analysts can set this parameter by altering assembly constants within IAF.
1.ONSW3.	Abort the time-sharing subsystem on all abnormal conditions. This ensures that the subsystem does not continue to operate if an internal malfunction occurs. This may be used with sense switch 5 to enable an analyst to determine the problem. Some conditions cause the time-sharing subsystem to abort even though sense switch 3 is not set.
1.ONSW4.	Enable dump on normal termination. This option should be activated whenever a dump is desired after a 1. STOP. entry.
1.ONSW5.	Call DMP, which dumps information to the OUTPUT file after the time-sharing subsystem is dropped or aborted. This option provides a listing which may assist an analyst in determining the problem that existed when the subsystem dropped or aborted. This sense switch is set by default when the time-sharing subsystem is activated.
1.ONSW6.	Release OUTPUT file containing dump information written after the time-sharing subsystem is dropped or aborted (refer to 1.ONSW5. operation) immediately after the dump is taken. When sense switch 6 is not set, the OUTPUT file is not released until the time-sharing subsystem is terminated. It is then printed with the dayfile. This switch applies only when sense switch 5 is set.

TELEX.

Calls the time-sharing subsystem to control point 1. This command is not valid if a job currently assigned to control point 1 has a queue priority greater than MXPS. The time-sharing executive must be active before user can enter jobs from a time-sharing terminal. Use the T display (refer to section 4) to monitor activity at the time-sharing subsystem control point.

Several options are available to control the operation of TELEX. Select these options by setting sense switches after the subsystem is

<u>Entry</u>	<u>Response</u>
	activated. Although normal operation does not require these sense switches to be set, sense switch 5 (1.ONSW5.) is set by default when the time-sharing subsystem is activated. Once set, the sense switch may be turned off again by entering 1.OFFSWx. (x is the sense switch number.)
1.ONSW1.	When the time-sharing subsystem is terminated (by 1.STOP command), enter users into recover state and inhibit restarting operations.
1.ONSW2.	Enable the time-sharing subsystem to use the delay queue feature. This allows response time to appear more consistent to users by delaying response in a lightly loaded system. Analysts can set this parameter by altering assembly constants within TELEX.
1.ONSW3.	Abort the time-sharing subsystem on all abnormal conditions. This ensures that the subsystem does not continue to operate if an internal malfunction occurs. This may be used with sense switch 5 to enable an analyst to determine the problem. Some conditions cause the time-sharing subsystem to abort even though sense switch 3 is not set.
1.ONSW4.	Enable dump on normal termination. This option should be activated whenever a dump is desired after a 1.STOP entry.
1.ONSW5.	Call DMP, which dumps information to the OUTPUT file after the time-sharing subsystem is dropped or aborted. This option provides a listing which may assist an analyst in determining the problem that existed when the subsystem dropped or aborted. This sense switch is set by default when the time-sharing subsystem is activated.
1.ONSW6.	Release OUTPUT file containing dump information written after the time-sharing subsystem is dropped or aborted (refer to 1.ONSW5. option) immediately after the dump is taken. When sense switch 6 is not set, the OUTPUT file is not released until the time-sharing subsystem is terminated. It is then printed with the dayfile. This switch applies only when sense switch 5 is set.

TAFfff.†

Calls the transaction subsystem to control point 2. This command is not valid if a job currently assigned to control point 2 has a queue priority greater than MXPS. The transaction subsystem must be active for transaction processing to take place.

TAFfff.† calls a procedure file named TAFfff under the system user index to initialize TAF. This procedure file can be set up for TAF to use either the time-sharing subsystem or NAM mode of terminal communications. To run TAF interfacing with the time-sharing subsystem, TELEX (not IAF) must be active at control point 1. NAM must be active at a control point to run TAF interfacing with NAM. Only one version of the transaction subsystem can be active at a time.

Response to an operator drop or fatal error is controlled by setting sense switches as follows:

<u>Entry</u>	<u>Response</u>
2.ONSW4.	Attempt recovery after the transaction subsystem is dropped or aborted. To successfully drop the transaction subsystem once this entry has been made, the command 2.OFFSW4. must be entered prior to 2.STOP command.
2.ONSW5.	Dump entire field length and release OUTPUT after the transaction is dropped or aborted.
2.ONSW6.	Print job dayfile upon termination.

Activity at the transaction control point can be monitored on the O display (refer to section 4). For further information concerning transaction operations, refer to Transaction Subsystem Commands later in this section.

n.IDLE.

Sets idledown status for subsystem currently assigned to control point n. The subsystem then will terminate when idledown conditions are met. The magnetic tape subsystem (MAGNET) will terminate when no tapes are assigned. MSS will terminate when no requests are outstanding and no MSS utilities are connected. The BATCHIO subsystem will terminate when no active buffers remain. For all other subsystems, there are no idledown conditions; they terminate immediately.

The system will not initiate new activity, such as assigning tapes and beginning print jobs, when idledown status is set. It is recommended that you use this command for terminating all subsystems with a queue priority greater than MXPS + 1.

n.STOP.

Drops (terminates) subsystem currently assigned to control point n. This command can also be entered in order to drop any job with a queue priority greater than MXPS + 1. Unlock the console to enter this command.

Refer to the System Control Commands AUTO, ENABLE, DISABLE, and MAINTENANCE for additional information concerning subsystem control.

SYSTEM CONTROL COMMANDS

The following DSD commands control the operating system as well as the subsystems which run under the system. Several of these commands are typically used only by the site analyst for debugging purposes when the system is in an abnormal state. You may use others frequently to maintain system integrity in a normal production environment. Appropriate cautions are included with individual command descriptions in cases where you do not normally use the command or it is not recommended for use in a production environment.

AUTO.

Calls specific subsystems to control points and initiates automatic job processing. The IPRDECK used at deadstart time determines which subsystems will be activated by default. However, any of those subsystems not currently assigned to a control point can be disabled or others enabled through use of the DISABLE and ENABLE commands. Individual subsystems can also be called to a control point or removed independent of the AUTO command by using the Subsystem Control Commands described earlier in this section. For additional information concerning the AUTO command, refer to Initiating Job Processing in section 2.

MAINTENANCE.

This command performs the same functions as the AUTO command but additionally starts several maintenance routines. Refer to Initiating Job Processing at the end of section 2 for complete information concerning this command.

ENABLE,op.
or
DISABLE,op.

Enables or disables option op. If you enter the ENABLE command and op is currently enabled, the system ignores the command. The system also ignores the DISABLE command if you enter it and op is already disabled. The ENABLE or DISABLE command does not assign a subsystem to a control point or drop a subsystem when you enter the command (refer to the footnote on page 3-23).

†The characters ffff are optional; if required, installation personnel must supply the one to four alphanumeric characters to be used.

op can be one of the following options.

ACCOUNT

Enables or disables processing of VAL=special entry point programs. Disabling ACCOUNT causes all VAL=entry point program request statements (such as USER and CHARGE) to be issued to the dayfile but not processed further. ACCOUNT is normally enabled when running in a production environment. Use of this feature is usually restricted to performance testing in order to reduce the overhead of processing USER/CHARGE statements.

AUTOROLL

Enables or disables automatic rollout of jobs. This option improves time-sharing operation but could be disabled if running in a batch environment.

BATCHIO†

Enables or disables BATCHIO subsystem. If not running local batch, disabling BATCHIO frees a control point for other use.

CDCS

Enables or disables the system control point version of the CDCS data management subsystem. If this facility is not in use, disabling CDCS frees a control point for other use. CDCS can still be used within user jobs.

EI200†

Enables or disables Export/Import (EXP) subsystem. If not running remote batch, disabling EI200 frees a control point for other use.

FILE STAGING

Enables or disables the staging of MSF resident permanent files to disk. Disabling FILE STAGING causes job attempts to access MSF resident files to be aborted. If the MSSEXEC is running, enabling FILE STAGING allows MSF resident files to be staged to disk when accessed.

IAF†

Enables or disables interactive facility. If your site is not running a time-sharing facility, disabling IAF frees a control point for other uses.

MAGNET†

Enables or disables magnetic tape subsystem (MAGNET). If magnetic tape operations are not used, disabling MAGNET frees a control point for other use.

MCS†

Enables or disables MCS. If this facility is not in use, disabling MCS frees a control point for other use.

MS VALIDATION

Enables or disables automatic verification of mass storage tables. This command cannot be used unless the MS VALIDATION option has been selected in the IPRDECK used at deadstart. The validation which occurs for each level of recovery deadstart is described in section 2, Preparing for Recovery Deadstart.

MSS†

Enables or disables MSS processing.

MSS MASTER

Enables or disables master mainframe mode for MSS processing. When MSS is brought to a control point, the MSSEXEC program runs if master mainframe mode is enabled. The MSSSLV program runs if master mainframe mode is disabled. This entry has no effect unless MSS processing is activated.

NAM†

Enables or disables NAM. If this facility is not in use, disabling NAM frees a control point for other use.

PF VALIDATION

Enables or disables verification of BOI/EOI on preserved files. Selection of this option causes BOI/EOI information to be verified when a direct access file is attached or purged, and when an existing local file is defined as a direct access permanent file.

PRIORITY AGING

Enables or disables priority aging. Disabling this option causes larger jobs to be scheduled before smaller jobs of equal priority. There may be environments in which it is advantageous to run the larger jobs first (for example, a nontime-sharing environment).

RBF†

Enables or disables RBF. If this facility is not in use, disabling RBF frees a control point for other use.

REMOVABLE PACKS

Enables or disables automatic label checking for mass storage devices defined as removable. Examine the mass storage status (E,M.) display (refer to section 4) to determine which mass storage devices (if any) are defined

†Option does not cause a subsystem to be assigned to a control point, or dropped. Instead, the option merely determines if the specified subsystem is to be assigned to a control point upon entry of the next AUTO or MAINTENANCE command. In addition, a currently active subsystem (assigned to a control point) will not be dropped by entering the DISABLE command followed by AUTO or MAINTENANCE. The n.IDLE command should be entered to drop an active subsystem.

as removable. If this option is disabled, all removable devices subsequently introduced into the system cannot be accessed. This option must be enabled to perform label verification before those devices can be accessed.

SECONDARY USER CARDS

Enables or disables the acceptance of more than one USER statement in a job. If disabled, any USER statement encountered after the first one causes the job to be aborted with no exit processing. A time-sharing origin job which issues a USER statement is logged off. Unlock the console (refer to UNLOCK command) to enable or disable this option.

TELEX†

Enables or disables time-sharing subsystem. If not running time-sharing, disabling the time-sharing subsystem frees a control point for other use.

TAF†

Enables or disables TAF. If transaction processing is not being done, disabling the transaction subsystem frees a control point for other use.

USER ECS

Enables or disables use of the user accessible area of ECS. If disabled, no job can access the user area of ECS and, other than subsystems, all jobs currently accessing the area will be rolled out. Unlock the console (refer to UNLOCK command) to enable or disable this option.

VALIDATION

Enables or disables running of jobs without USER statements. Disabling VALIDATION allows jobs without USER statements to be run. If a USER statement is present, it will be processed depending on the x=ACCOUNT option discussed earlier. The system processes jobs with no VALIDUS file defined, but access to permanent files, tapes, and private packs is not allowed for any of the jobs. VALIDATION is normally enabled when running in a production environment. The console must be unlocked (refer to UNLOCK command) to enable or disable this option.

IDLE.

Prevents any new jobs from being scheduled to a control point but does not terminate the job currently assigned. If a job is rolled out while this command is in effect, it will not be scheduled

back to a control point until the AUTO or MAINTENANCE command is entered. When the BATCHIO subsystem is idle, it is terminated.

IDLEFAMILY,xx.

This command performs one of the two following functions, depending on the status of the family.

- If the family is active, the IDLEFAMILY command causes all new jobs and USER statements for the family on the equipment specified by EST ordinal xx to be rejected. Jobs in progress are allowed to complete.
- If the family is inactive, the IDLEFAMILY command allows jobs to access the family on the equipment specified by EST ordinal xx.

The fame column of the E,M display shows the number of jobs in progress on the equipment.

CHECK POINT SYSTEM

Provides for termination of job processing and writes the contents of central memory tables to mass storage. This command is typically entered in preparation for recovery deadstart. The following sequence of operations takes place:

1. The sense switch for the time-sharing subsystem which causes all users to be placed in the recovery file on an operator drop is set. When all users are in the recovery file, the time-sharing subsystem is dropped and the checkpoint continues.
2. All job scheduling is inhibited. (This has the same effect as if the IDLE command was entered.)
3. Jobs less than or equal to MXPS queue priority are rolled out. All of these jobs are recovered on a level 1 or level 2 recovery.
4. The system moves the system dayfile buffers maintained in CMR to disk.
5. All subsystems except MAGNET (the magnetic tape executive) are aborted.
6. MAGNET is rolled out when no other jobs are active. The rolling out of MAGNET allows recovery of all tape files associated with jobs rolled out if the tapes are not repositioned prior to the level 1 or level 2 recovery. Because of this, if a tape unit is used for deadstart, it should be unassigned prior to the checkpoint command.
7. The system is left in an idle state. Normal processing may be continued with an AUTO command. If this is done, no attempt should be made to later perform a level 1 or level 2 recovery unless another checkpoint command is performed.

†Option does not cause a subsystem to be assigned to a control point, or dropped. Instead, the option merely determines if the specified subsystem is to be assigned to a control point upon entry of the next AUTO or MAINTENANCE command. In addition, a currently active subsystem (assigned to a control point) will not be dropped by entering the DISABLE command followed by AUTO or MAINTENANCE. The n.IDLE command should be entered to drop an active subsystem.

During the processing of the checkpoint, the message

PROCESSING CPn.

is issued at the system control point indicating which control point is currently being processed (n is the control point number). Most of the checkpoint process must be performed in a serial manner so that occasionally one control point number may be displayed for a period of time. This is especially true of the time-sharing subsystem if many users were active when the checkpoint was issued. It is also possible that under certain circumstances the checkpoint routine (ICK) will not be able to properly abort a job (such as one that has NOEXIT selected and is at MXPS+1 priority). If such a job continues processing after ICK has aborted it, it is then necessary for the operator to abort the job for the checkpoint to continue. A more desirable approach to this situation is to ensure that jobs such as PFDUMPs are finished prior to the checkpoint. For additional information concerning the CHECK POINT SYSTEM command, refer to Preparing for Recovery in section 2.

n.DIS.

Calls the job display package (DIS) to an active control point specified by n. The A and B display for DIS automatically appear on the left and right console screen, respectively. Refer to section 5 for complete information concerning the DIS package.

X.name.

or
X.name(ccc...ccc)
or
X.name,xxxxx.

Calls a system program or utility specified by name to an available control point. If parameters are to be passed to the program (for example, PFDUMP or MODVAL), the second form of the command is used where (ccc...ccc) specifies the parameters. In both the first and second form of the command, a default field length of 60000 octal is assumed. If a field length different from the default is required, the third form of the command is used. The field length is specified by xxxxx. Only the first 38 characters following X. are used.

K.ccc...ccc.

or
L.ccc...ccc.

Allows entry of data ccc...ccc in user- or system-defined CPU buffer for control when K or L display is active. Refer to section 4 for information concerning the K and L displays.

UNLOCK.

Unlocks the console keyboard. When this command is active, the message UNLOCKED appears in the header of the left screen display.

Although all DSD commands can be entered when the console is unlocked, the following commands are restricted to entry only when the console is unlocked.

BLITZ.

DATE.yy/mm/dd.

DEBUG.

DISABLE, SECONDARY USER CARDS.

DISABLE, VALIDATION.

ENABLE, SECONDARY USER CARDS.

ENABLE, VALIDATION.

ENGR.

FORMAT,xx.

n.OVERRIDE.

STEP.

STEP,xx.

STEP,xx,b,v.

n.STEP.

n.STEP,xx.

n.STEP,xx,b,v.

n.STOP.

TIME.hh.mm.ss.

UNLOAD,xx. (xx specifies a nonremovable shared mass storage device)

UNSTEP.

All memory entry commands

All channel control commands

Always lock the console when the system is being used in a production environment. However, you can unlock the console to enter the STEP command if a system failure requiring a recovery deadstart occurs (refer to Preparing for Recovery Deadstart in section 2) or to enter the UNSTEP command after a power or environmental interrupt (refer to appendix F).

LOCK.

Locks the console keyboard. This command prevents entry of restricted commands (refer to UNLOCK command for list of restricted commands). All other DSD commands can be entered when the console is locked. The console is normally locked when the system is being used in a production environment.

DATE.yy/mm/dd.

Changes the current system date. Unlock the console before entering this command (refer to UNLOCK command).

- yy Year; 00 through 99.
- mm Month; 01 through 12.
- dd Day; 01 through nn (nn is the number of days in the month).

TIME.hh.mm.ss.

Changes the current system time. Unlock the console before entering this command (refer to UNLOCK command).

- hh Hour; 00 through 23.
- mm Minute; 00 through 59.
- ss Second; 00 through 59

DEBUG.

Reverses the current set or clear condition of debug mode. When debug mode is set, the message DEBUG appears in the header of the left screen display. Debug mode provides system origin privileges to validated users and allows modifications to be made to the running system. Unlock the console before entering this command (refer to UNLOCK command). Use of debug mode is not commonly allowed in normal production environment.

ENGR.

Reverses current setting of engineering mode. When engineering mode is set, the message ENGR appears in the header of the left screen display. Engineering mode allows PP/hardware diagnostics and FORMAT/FDP to be executed if the user has system origin privileges. Unlock the console before entering this command (refer to UNLOCK command).

STEP.

Sets monitor in step mode. Setting monitor in step mode stops all central memory I/O operations and prevents the system from processing PP requests when the next monitor function is encountered. Pressing the spacebar releases the present step and stops again for each subsequent monitor function. If a DSD command is entered while the system is in step mode and all PPs are assigned, it is possible the request cannot be satisfied. In that case, the screen(s) will blink until you correct the condition by clearing the entry.

When step mode is set, the message STEP appears in the header of the left screen display. Unlock the console before entering this command (refer to UNLOCK command).

This command is generally used by the site analyst for debugging purposes and should not be used in a normal production environment. In addition, the system may set step mode automatically upon

detection of a main power failure or abnormal environmental condition (refer to S/C Register Error Detection, appendix F).

- STEP,xx.
- or
- STEP,xx,b,v.

Sets step mode for monitor function xx.† The second form of this command sets step mode for monitor function xx† only when byte b of the output register contains a specified value v. b can be 1, 2, 3, or 4 and the range for v is 0 through 7777g. Setting step mode for monitor function xx may stop all central memory I/O operations and prevent the system from processing PP requests when monitor function xx is encountered. Pressing the spacebar releases the present step and stops again at the next function xx. If a DSD command is entered while the system is in step mode and all PPs are assigned, it is possible the request cannot be satisfied. In that case, the screens will blink until you correct the condition by clearing the entry.

When this mode is set, the message STEP followed by function number xx appears in the header of the left screen display. The console must be unlocked before entry of this command is permitted (refer to UNLOCK command).

This command is generally used only by the site analyst for debugging purposes and should not be used in a normal production environment. Do not enter this command unless specifically directed to do so. In addition, do not enter this command if the system has automatically set step mode because of a power failure or abnormal environmental condition (refer to S/C Register Error Detection, appendix F).

- n.STEP.
- or
- n.STEP,xx.
- or
- n.STEP,xx,b,v.

Sets monitor in step mode for control point n. The second form of this command sets step mode for monitor function xx.† The third form sets steps mode for monitor function xx† only when byte b of the output register contains a specified value v. b can be 1, 2, 3, or 4 and the range for v is 0 through 7777g. These commands perform the same function as STEP., and STEP,xx,b,v., except only control point n is stepped. Other control points may be affected depending on the operation being performed at control point n. Only one control point at a time can be placed in step mode. If a DSD command is entered while the system is in step mode and all PPs are assigned, it is possible the request cannot be satisfied. In that case, the screens will blink until you correct the condition by clearing the entry.

When this mode is set, the message STEP preceded by control point number n appears in the header of the left screen display. If xx was specified, it appears to the right of the STEP message. The console must be unlocked before entry of these commands is permitted (refer to UNLOCK command).

†Monitor functions are described in the NOS Systems Programmer's Instant.

These commands are generally used only by site analysts for debugging purposes. Do not enter either command unless specifically directed. In addition, do not enter these commands if the system has automatically set step mode because of a power failure or abnormal environmental condition (refer to S/C Register Error Detection, appendix F).

UNSTEP.

Clears step mode. This command clears the effect of any format of STEP command. Unlock the console before entering this command (refer to UNLOCK command). Depending on current syntax overlay residency, you may have to enter the 99 command before entering the UNSTEP. command (refer to 99 command description). If the system has set step mode because of a main power failure or abnormal environmental condition (refer to S/C Register Error Detection, appendix F), do not enter this command until the conditions that caused the automatic setting have again become normal.

BLITZ.

Drops jobs at all control points except subsystems (queue priority is greater than MXPS+1). The command n.DROP. performs the same function for a job at an individual control point (refer to Job Processing Commands). To ensure proper idledown, terminate the subsystem with the n.IDLE command after entering the BLITZ command. To resume job processing after entering BLITZ, enter the AUTO or MAINTENANCE command. Do not enter the BLITZ command unless specifically directed to do so. Unlock the console before entering this command (refer to UNLOCK command).

99.

Disables or enables syntax overlay processing and logging of DSD commands in the system dayfile/error log. That is, depending upon current status, syntax overlay processing and logging are reversed.

When syntax overlay processing and logging of DSD commands is disabled, DSD does not check syntax. Disable overlay processing and logging only when the system is in abnormal state to prevent PPs from being requested when they cannot perform the necessary tasks (for example, when a system disk channel is hung). A 99 command which enables logging will be logged itself, but a 99 command which disables logging will not be logged.

This command is normally used only by the site analyst for debugging purposes. Do not enter this command unless you are given specific instructions concerning its use. When the system is in abnormal state, the commands which require entry of the 99 command depend on which syntax overlays for DSD are currently in central memory.

MEMORY ENTRY COMMANDS

The following commands are used to change the contents of central memory and ECS. Either absolute locations or those relative to a control point may be changed. Character values or numeric data can replace the current word contents. Either one 12-bit byte or 60 bits can be changed. A single byte can be changed by inserting the byte number after the location; bytes are numbered 0 through 4 from left to right. The address and contents are assembled right-justified with leading zero fill. Leading zeros may be omitted in the entry. Finally, the console keyboard must be unlocked to change memory under DSD (refer to UNLOCK command).

CAUTION

Do not enter any of the following memory entry commands unless explicitly directed to do so.

These commands are typically used only by the site analyst. Extreme caution must be observed when using these commands to avoid damage to the system or to user jobs. Again, the console must be unlocked in order to enter any of the memory entry commands. Formats and descriptions for these commands are as follows:

aaaaaa,yyy...yyy.
or
aaaaaa±yyy...yyy.

Changes the contents of absolute memory location aaaaaa to yyy...yyy (20 digits). The second form of the command performs essentially the same function but is used when it is necessary to change successive memory locations.†

aaaaaa,b,yyyy.
or
aaaaaa±b,yyyy.

Changes the contents of byte b at absolute memory location aaaaaa to yyyy. Note that each location consists of five 12-bit bytes, numbered 0 through 4 from left to right. The second form of the command performs essentially the same function but is used when it is necessary to change successive memory locations.†

aaaaaa,Dyyy...yyy.
or
aaaaaa±Dyyy...yyy.

Changes the contents of absolute memory location aaaaaa to display code characters yyy...yyy (left-justified and zero-filled). The second form of the command performs essentially the same function but is used when it is necessary to change successive memory locations.†

†If the + sign is specified, the address is incremented by one location (aaaaaa+1) after the initial entry is processed; the - sign causes the address to be decremented by one location (aaaaaa-1). This allows immediate entry for the next (or previous) memory location. If the message REPEAT ENTRY is displayed above the entry, the yy...yy field is not cleared and can be entered in successive memory locations as many times as desired by pressing CR. This repeat entry mode is enabled by pressing CR before initial entry of the command.

n.aaaaaa,yyy...yyy.
or
n.aaaaaa±yyy...yyy.

Changes the contents of memory location aaaaaa to yyy...yyy (20 digits). Location aaaaaa is relative to the reference address (RA) for the control point specified by n. The second form of the command performs essentially the same function but is used when it is necessary to change successive memory locations.†

n.aaaaaa,b,yyyy.
or
n.aaaaaa±b,yyyy.

Changes the contents of byte b at memory location aaaaaa to yyyy. Location aaaaaa is relative to the reference address (RA) for the control point specified by n. Note that each memory location consists of five 12-bit bytes, numbered 0 through 4 from left to right. The second form of the command performs essentially the same function but is used when it is necessary to change successive memory locations.†

n.aaaaaa,Dyyy...yyy.
or
n.aaaaaa±Dyyy...yyy.

Changes the contents of memory location aaaaaa to display code characters yyy...yyy (left-justified and zero-filled). Location aaaaaa is relative to the reference address (RA) for the control point specified by n. The second form of the command performs essentially the same function but is used when it is necessary to change successive memory locations.†

Eaaaaaaa,yyy...yyy.
or
Eaaaaaaa±yyy...yyy.

Changes the contents of absolute ECS location aaaaaa to yyy...yyy (20 digits). The second form of the command performs essentially the same function but is used when it is necessary to change successive ECS locations.†

Eaaaaaaa,b,yyyy.
or
Eaaaaaaa±b,yyyy.

Changes the contents of byte b at absolute ECS location aaaaaa to yyyy. Note that each location consists of five 12-bit bytes, numbered 0 through 4 from left to right. The second form of the command performs essentially the same function but is used when it is necessary to change successive ECS locations.†

Eaaaaaaa,Dyyy...yyy.
or
Eaaaaaaa±Dyyy...yyy.

Changes the contents of absolute ECS location aaaaaa to display code characters yyy...yyy

(left-justified and zero-filled). The second form of the command performs essentially the same function but is used when it is necessary to change successive ECS locations.†

n.Eaaaaaaa,yyy...yyy.
or
n.Eaaaaaaa±yyy...yyy.

Changes the contents of ECS memory location aaaaaa to yyy...yyy (20 digits). Location aaaaaa is relative to the ECS reference address (RAE) for the control point specified by n. The second form of the command performs essentially the same function but is used when it is necessary to change successive memory locations.†

n.Eaaaaaaa,b,yyyy.
or
n.Eaaaaaaa±b,yyyy.

Changes the contents of byte b at ECS memory location aaaaaa to yyyy. Location aaaaaa is relative to the ECS reference address (RAE) for the control point specified by n. Note that each memory location consists of five 12-bit bytes, numbered 0 through 4 from left to right. The second form of the command performs essentially the same function but is used when it is necessary to change successive memory locations.†

n.Eaaaaaaa,Dyyy...yyy.
or
n.Eaaaaaaa±Dyyy...yyy.

Changes the contents of ECS memory location aaaaaa to display code characters yyy...yyy (left-justified and zero-filled). Location aaaaaa is relative to the ECS reference address (RAE) for the control point specified by n. The second form of the command performs essentially the same function but is used when it is necessary to change successive memory locations.†

CHANNEL CONTROL COMMANDS

The following commands enable control activity on a specified data channel in circumstances where abnormal hardware and/or system operation is detected. These commands are typically used only by the site analyst or customer engineer since they directly affect the operation of system peripheral equipment. Extreme caution must be exercised if any of these commands are entered during normal system operation. In addition, the console keyboard must be unlocked before entry of any of these commands is permitted (refer to description of UNLOCK command). DSD does not reserve the channel specified in any of the channel control commands. The channels are numbered 0 to 13 octal in a 10-PP system and 0 to 13, 20 to 33 in a 20-PP system.

CAUTION

Do not enter any of the following channel control commands unless explicitly directed to do so.

†If the + sign is specified, the address is incremented by one location (aaaaaa+1) after the initial entry is processed; the - sign causes the address to be decremented by one location (aaaaaa-1). This allows immediate entry for the next (or previous) memory location. If the message REPEAT ENTRY is displayed above the entry, the yy...yy field is not cleared and can be entered in successive memory locations as many times as desired by pressing CR. This repeat entry mode is enabled by pressing CR before initial entry of the command.

ACNcc.

Activate channel cc. This command alerts and prepares peripheral equipment on channel cc for the exchange of data.

DCNcc.

Deactivate channel cc. As a result, peripheral equipment on channel cc stops and any current I/O operation is terminated.

DCHcc.

Drop channel cc. This is a software function to release the current reservation of channel cc.

MCHcc.

Master clears and removes all 3000-series peripheral equipment selections on channel cc (6681 function code 1700g is issued).

IANcc.

Input to pseudo A register from channel cc.

LDC,nnnn.

Load pseudo A register with nnnn (normally a peripheral equipment function code). The current value of nnnn is the rightmost field in the header of the right screen display (adjacent to channel status).

OANcc.

Output contents of pseudo A register to channel cc.

FNCcc,xxxx.

Output function code xxxx to channel cc.

FCNcc.

Output a zero function code (no activity) to channel cc. This releases all equipment selections on that channel.

TRANSACTION SUBSYSTEM COMMANDS

The following commands control operation of the transaction subsystem. Bring the transaction subsystem to control point 2 via the TAF command before issuing these commands.

INITIALIZATION K DISPLAY OPTIONS

When the transaction executive is brought to control point 2, the message REQUEST *K* DISPLAY appears at the control point. Respond with the entry:

K,2.

Any of the following initialization options can then be entered. If no values are to be changed, enter the command:

K.END.

Values are decimal unless otherwise indicated.

K.ECS=n.

Sets the ECS field length to be used by the transaction executive; n is octal thousands of words. Default = 0.

K.END.

Ends input of the transaction executive initialization parameters. Initialization is completed when the normal running display appears.

K.MDM=n.

Sets the number of data manager buffers (one to six) to be reserved. Default = 3.

K.MFL=n.

Sets the maximum field length (40000 to 377700) to be used by the transaction executive. Default = 377700.

K.REC=a.

Specifies the setting of the recovery bit in the user area of each terminal status table entry (YES or NO). Default = NO.

K.SCP=n.

Changes number of subcontrol points (2 to 31). Default = 12.

K.TLF=a.

Changes the name of the system task library file (any legal file name). Default = TASKLIB.

K.CMB=n.

Changes the maximum number of communication blocks (4 to 40) allowed to the subsystem. Default = 10.

NORMAL RUNNING DISPLAY (K DISPLAY)

When the transaction subsystem is at a control point, the console K display indicates:

- Latest transaction sequence number.
- Number of words of unused memory.
- Maximum field length.
- Global task dump limit.
- Subsystem default values for memory dump arguments.

The K display appears on the system console as shown in figure 3-5.

The subsystem default values are used to control memory dumps when explicit arguments are not included in the CMDUMP or DSDUMP command. Any of these default arguments can be changed by specifying the corresponding argument in the K. DSDUMP command.

The default values for CMDUMP and DSDUMP are given on the display. The parameters are:

- FW First word address of task memory to be dumped.
- LW Last word address of task memory to be dumped.
- EP Exchange package: 0 or 1 (1 indicates that the exchange package is to be dumped).
- OQ Output queue:
- BC Local batch.
 - EI Remote batch.
 - PF Permanent file.
- QD Queue destination:
- User number (if OQ=BC).
 - Equipment identification (if OQ=EI).
 - Permanent file name (if OQ=PF).

DB Data base option

If DB=1, all data base file buffers held by this user are dumped.

If DB=0, no buffers are dumped.

RUN TIME K DISPLAY COMMANDS

When the transaction executive is at its control point, the following commands can be entered from the system console or submitted from tasks via the KPOINT request. Any task can issue the K.DUMP command. Only tasks that reside on the system task library can issue the other K display commands. (Refer to the Network Products Transaction Facility Reference Manual or the TAF/TS Reference Manual for additional information on the KPOINT request and the system task library.)

K.ASSIGN,xx.
K.ASSIGN,xx,db,n.

Assigns a magnetic tape unit to be used for a journal file. xx is the EST ordinal of the tape unit. The first form of the command makes unit xx available for the transaction executive to assign to the next tape journal file that encounters end of reel. Two tape units may be preassigned. If a tape has not been preassigned in this manner, an end of reel on a journal file causes subsequent entries for that file to be placed on disk.

The second form of the command forces journal file n (n=1, 2, or 3) for data base db, defined as a tape file, from disk to tape. The transaction executive copies the data from the disk journal file to tape xx and places all subsequent entries for that file on the tape. This command is necessary after the transaction executive initialization to assign tape units to the tape journal files or after an end of reel on a tape journal file when no tape had been preassigned to the transaction executive. All data residing on the disk for the tape journal file must be able to fit on the tape assigned by this command or else the transaction executive unloads the tape and issues the message *UNABLE TO USE TAPE*.

TRANSACTION EXECUTIVE STATUS DISPLAY

SEQUENCE NUMBER	1	
UNUSED FL	3000	
MAXIMUM FL	377700	
GLOBAL TASK DUMP LIMIT	0	
FW= 0	LW= 100000	EP= 1
OQ= BC	QD= USER123	DB= 0

Figure 3-5. K Display

K.DDROPN.

Drops a task executing at subcontrol point n that is waiting for a data manager task to complete. It sets the abort bit for the task and clears the function code field on all data manager input queue entries originating from the task. This command can be used to drop a task that is deadlocked waiting for a locked data manager record or file.

K.DEBUG.

Turns on the application interface program (AIP) debug option which logs all messages on trace file ZZZZZDN. Use this command only when TAFNAM is installed with the DEBUG option.

K.DROPN.

Drops an executing task at subcontrol point n.

K.DSDUMP,FW=addr,LW=addr,EP=pkg,OQ=outq, QD=qdest,DB=ob.

Allows you to modify the standard system default parameters controlling memory dumps. The command does not directly cause a dump. Rather, it sets default values to be used when a subsequent CMDUMP request is received or when abort conditions occur. Refer to the description of the normal running K display for explanations of the parameters.

K.DUMP,fwa,lwa.

K.DUMP,lwa. K.DUMP.

Dumps all or part of the field length of the transaction facility. You can specify in octal the first word address (fwa) and the last word address (lwa) of the area to be dumped. Default value for fwa is 0 and for lwa is 377777g. The default base is octal. If no parameters are specified (third form of command), the entire field length is dumped. The output is routed to a printer that has an ID of zero. Unlike other K display commands, the K.DUMP command can be issued from any task. Other K display commands can be issued by tasks only if they are on the system task library. It can be issued from any task (refer to the Network Products Transaction Facility Reference Manual or the TAF/TS Reference Manual).

Since secure information may be contained in a dump of the transaction facility, the following safeguards have been taken to protect dumped information; however, the installation must take the ultimate responsibility for the protection of dumped information.

- The global task dump limit (GTDL) can be set by the K.DUMPLIM command to limit the number of times the K.DUMP command can be issued from tasks. The initial value of the GTDL is zero, so the K.DUMP command is disabled from use by a task by default. (Refer to the K.DUMPLIM command in this section.)

- For all dumps of the transaction facility, whether you initiated it or a task did, a one-page header precedes the dump. This header page indicates the output is secure and should be given only to the TAF central site systems analyst.
- When the transaction facility is dumped, the message TAF FIELD LENGTH DUMP RELEASED is issued to the system dayfile, the transaction facility dayfile, and line one of the control point.

K.DUMPLIM,n.

Sets GTDL to value n. If n is not specified, the GTDL is set to zero. The range for n is 0 through 9 999 999. The default base is decimal.

The GTDL is the number of times the K.DUMP command can be issued from tasks. This value is displayed on the normal running K display shown in figure 3-3. The initial value of the GTDL is zero. When the GTDL is zero, no dumps of the transaction facility can occur from tasks. Thus, the K.DUMP command is disabled from tasks by default.

To enable the K.DUMP command for tasks, issue the K.DUMPLIM command to set the GTDL to a value greater than zero. Each time a task issues a K.DUMP command, the GTDL is decreased by one until it equals zero. When the first K.DUMP command is issued from a task with the GTDL equal to zero, the message GLOBAL TASK DUMP LIMIT EXHAUSTED is issued to the transaction facility dayfile, the system dayfile, and line one of the control point. Also, the message DUMPS LOST is displayed on the K display in place of the value of the GTDL. This message remains until the value of GTDL is set to a value greater than or equal to zero. The K.DUMPLIM command should be used with care in system tasks, since this might allow unauthorized users to alter the GTDL.

K.IDLE.

Idles down the transaction control point. Once idle down has been initiated, no new transactions will be permitted but currently executing transactions will be allowed to finish.

K.JEND,db,n.

Forces end-of-reel processing (writes EOI and rewinds file) on tape journal file n of data base db. If n is not a tape journal file, the command is ignored.

K.MAXFL,n.

Alters the transaction executive maximum field length. The transaction executive does not attempt to obtain more than n words of storage. This command is rejected if the value for n is more than 377700g or less than the field length currently required for TAF.

K.MESSAGE, TN=b.
message.

Directs the transaction executive to send message to a terminal specified by terminal name b.

K.NAMON.

Allows TAF to resume communication with NAM after NAM has been dropped.

K.NODEBUG.

Turns off the application interface program (AIP) debug option which logs all messages on trace file ZZZZZDN. Use this command only when TAFNAM is installed with the DEBUG option.

L.OFFLINE, CH=c, EQ=e, PT=m.†

Logically turns off all terminals on multiplexer channel c, equipment e, and port m.

K.OFFTASK, a, db.

Disables the use of task a, where a is the task name in the data base db task library directory (dbTASKL). The data base name db is not specified for tasks in the system task library.

K.OFFTERM, TN=a.†

Logically turns off terminal a.

K.ONLINE, CH=c, EQ=e, PT=m.†

Logically turns on all terminals on multiplexer channel c, equipment e, and port m.

K.ONTASK, a, db.

Reverses the effect of a previous OFFTASK for the specified task a in the data base db task library directory (dbTASKL). The data base name db is not specified for tasks in the system task library (TASKLIB).

K.ONTERM, TN=a.†

Logically turns on terminal a.

K.SWITCH.

Causes the console K display to change to a display listing all allowable console commands. When K.SWITCH is entered a second time, the normal display returns. This command activates task KDIS and forces TAF to remain rolled in.

K.TST, TN=a, RS=n, US=m, DB=db, U=nnnn, UL=mmmm, NN=b.

Changes entries in the terminal status table for terminal a. The following entries can be changed: read security n, update security m, data base name db, user area upper 12 bits (nnnn), user area lower 12 bits (mmmm), and new terminal name b. The changes do not affect the network and simulation files. Do not use this command if the terminal is logged in.

MSS K-DISPLAY

The mass storage subsystem (MSS) uses the K display to present messages that require your action. You can use the MSS K display to reply to these messages and to control the rate that files are staged/destaged between MSF hardware and disk.

When MSS enters messages into the K display, a request for the K display flashes on the B-display. Enter K,n to activate the K display for MSS at control point n. After you have responded to all K display messages, the flashing B display message terminates.

The MSS K display provides space for four messages with up to three lines per message. If you enter an incorrect command, the incorrect command appears under a line containing *** REJECT ***. Figure 3-6 illustrates a sample MSS K display.

Valid MSS commands are as follows:

<u>Command</u>	<u>Description</u>
K.FILES,x	Controls the rate that files are staged/destaged between MSS and disk by changing the number, x, of concurrent files staged/destaged between MSF and disk. Increasing or decreasing the number of concurrent files by one results in a corresponding increase or decrease in field length of approximately 6500 ₈ central memory words. x Single digit
K.m.GO	Enters a GO response to the message at message ordinal m.
K.m.DROP	Enters a DROP response to the message at message ordinal m.
K.	Clears the previously entered incorrect command and the *** REJECT *** line.

MSS clears a message when an acceptable action is taken. Usually this action is entering the K.m.GO or K.m.DROP commands. However, for actions such as closing or emptying the input or output drawers on a cartridge storage unit, the message is cleared automatically when the hardware status indicates the requested action has occurred.

If you enter an invalid command, the *** REJECT *** line and the command are both displayed. Valid commands are those described previously. The K.m.GO and K.m.DROP commands are invalid if there is no message displayed at message ordinal m or if the GO/DROP response is not appropriate. Clear the *** REJECT *** line by entering a valid command. Refer to appendix B for the appropriate action for each message.

† This command is not applicable to TAF interfacing with NAM.

MASS STORAGE SUBSYSTEM

1. CS30, MSID 006.
CLOSE UPPER DRAWER.
2. STAGING DELAY, DISK FULL.
FM=NOSCLSH, UI= 2470.
REPLY GO TO CONTINUE.
3. CT32, MSID 027.
DEVICE NOT READY
REPLY GO TO RETRY - DROP TO OFF DEVICE.
4. CS40, MSID 007.
DEVICE TURNED OFF.
RESPOND GO TO ACKNOWLEDGE.

*** REJECT ***

4.DROP

MESSAGE
ORDINAL

INVALID
OPERATOR
COMMAND

Figure 3-6. MSS K Display

RBF K DISPLAY

Whenever RBF is in operation, a display of user connection and activity is available at the operator console through the DSD K or L display.

The use of the RBF K display is an operator option. To begin the RBF K display the operator enters the following:

K,n. n is the control point number at which RBF is running.

Data on the RBF display is updated at intervals in the main processing loop of RBF to reflect terminals becoming active or inactive.

Terminals are identified by termname, a unique name defined by the site. Terminals are displayed in alphabetical order. There are multiple lines on the K display per terminal; one line for the terminal console, and one line for each batch device (card reader, line printer, card punch, or plotter).

If there are more terminals and devices active than can be displayed on one screen, the message

MORE LINES FOLLOW.

appears at the lower left corner of the display. Additional screens can be displayed by entering:

K.+

The use of the K.+ command advances the display page-by-page and end-around from the last page to the first. All screens are displayed in a forward direction. The use of the console input K.- does not move the screen back to the previous display.

DESCRIPTION OF HEADER LINE FIELDS

The following lines are at the top of each page of the RBF K display.

TERM NAME	DEV TYP	TCLASS /STATE	USR/FILE NAME	FAMILY/ FILESIZE	FORMS ERRORS	CODE
--------------	------------	------------------	------------------	---------------------	-----------------	------

TERM NAME Name of the terminal. A unique name, termname, assigned by the installation during network startup. This field is filled only for console devices.

DEV TYP Device type. The device type code is one of the following:

Code	Description
CO	Console device
CRi	Card reader
LPi	Line printer
CPI	Card punch
PLi	Plotter

The ordinal number, i, of the device has a range of one to seven.

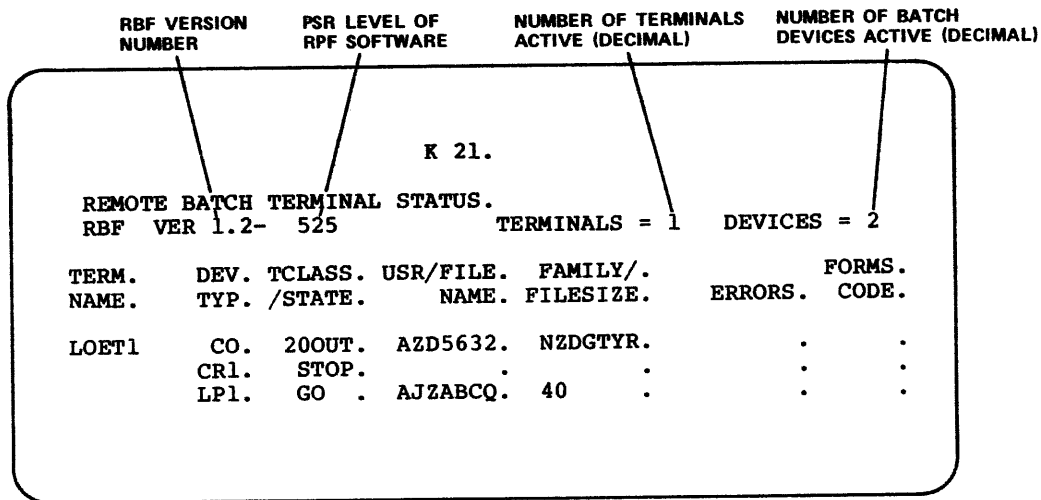

Figure 3-7. RBF K Display

**TCLASS
/STATE**

If this field is in the same line as the termname, the contents of the field is the terminal class mnemonic (refer to the Remote Batch Facility Reference Manual). If this field occurs in a line not containing a termname, the device status code is one of the following:

<u>Code</u>	<u>Description</u>
NULL	Console is not connected, but RBF devices are. This code appears only when the device type is a console (device type code CO).
PREC	Preconnect status (device connection not complete).
CONN	Device is connected (initial state).
GO	Device is ready for input.
END	Device stops transmission at EOI.
STOP	Device is not ready for transmission of data.
ABRT	File in transmission is to be discarded.
ENDA	File being aborted; device will stop at EOI.
ENDI	Device will stop at EOI; idle down requested.
STPA	Device is stopped; current file to be aborted.
STPE	Device is stopped.
STPI	Device is stopped due to idle down request.
ENDC	End connection.

**USR/FILE
NAME**

If this field is in the same line as the termname, the content of the field is the user name currently logged on this terminal. Otherwise, this field gives the system job name of the user's job.

**FAMILY/
FILESIZE**

If this field is in the same line as the termname, the content of this field is the family associated with the username. The user index and family combination determine terminal identifier (TID) used by the system for routing jobs. Otherwise, the contents of this field is the size of the output file in PRUs.

ERRORS

Contents of this field, if present, is one of the following error messages:

<u>Message</u>	<u>Description</u>
DISK FULL	A disk full indication was received while RBF was attempting to write to disk.
DISK ERROR	Data has been lost due to an unrecoverable disk failure.
QUEUE FULL	The system input queue has reached its limit of jobs waiting to begin execution.
NOT READY	The device the user specified has become not available (for example, line printer out of paper or card jam in card reader).

**FORMS
CODE**

Forms code for output devices as specified by the user and defined by the site.

You communicate with the system through the console keyboard and one or more console display screens. The system provides information about job and system status through displays on the console screen(s). Data entered from the keyboard is also displayed. You can request a permanent record, called a system dayfile, of all system/console communication.

The two major display programs are system display, controlled by the DSD program, and control point job display, controlled by the DIS program (refer to section 5). DSD controls the display console. The primary functions of DSD are as follows:

- Maintain a current display of system status.
- Process keyboard entries from the operator.

At the console keyboard, you can perform the following:

- Assign equipment.
- Exercise control over job scheduling and execution.
- Initiate utility programs.
- Select displays.

The CYBER 170 Series console keyboard contains a PRESENTATION CONTROL switch which allows you to display a left screen display only, a right screen display only, or both the left and right screen displays on a split screen. Refer to section 1 for a description of the PRESENTATION CONTROL switch.

DISPLAY SELECTION

Select any of the DSD displays with the console command

xy.

x and y Represent the letter designation of the displays.

x appears on the left screen and y appears on the right. If x and y are identical, both screens display the same information. The displays available under DSD are as follows:

<u>Letter Designation</u>	<u>Display</u>	<u>Description</u>
A	Dayfile†	Chronological history of system operations.
B	Job status	Current status of all jobs assigned to control points.

<u>Letter Designation</u>	<u>Display</u>	<u>Description</u>
C,D	Central memory	Contents of 32 central memory words (four selectable eight-word groups) in five columns of four octal digits with display code equivalents.
E	Equipment status	Status of peripheral devices.
F,G	Central memory	Contents of 32 central memory words (four selectable eight-word groups) in four columns of five octal digits with display code equivalents.
H	FNT	List of FNT entries for all active files in the system.
I	BATCHIO status	Status of central site unit record devices.
J	Control point status †	Status of the specified control point.
K,L	CPU programmable†	Dynamic operator/CPU communication.
M	ECS display	Contents of 32 60-bit words of ECS memory (four selectable eight-word groups) in five columns of four octal digits with display code equivalents.
N	File display	Contents of any file assigned to an FNT ordinal. Display is initially selected with the DISPLAY,xxx. command (refer to description of File (N) Display later in this section).
O	Transaction status	Status of the transaction subsystem.
P	PP communications area	Current contents of PP registers.

†This display is control-point oriented. Use the + and - keys (or left and right parentheses) to page forward and backward, respectively, through the display for each control point. The number of the control point also appears at the top next to the letter designator (for example, A5).

<u>Letter Designation</u>	<u>Display</u>	<u>Description</u>
Q	Queue status	Status of active input, output, and rollout queues.
R	Export/Import status	Status of remote batch operations.
S	System control information	Parameters used to control job flow.
T	Time-sharing status	Status of time-sharing users.
Y	Monitor functions	List of all monitor mnemonics and codes.
Z	Directory	List of the letter designators and descriptions of all DSD displays.

To preselect the left screen display sequence, enter the following DSD command.

SET,ssss.

ssss Letter designating any four of the DSD displays listed. Note that four display identifiers must be specified.

After you have entered this command, you can press the right blank key to cause the first display specified to appear on the left console screen. Pressing the key again selects the second display. Each time you press the right blank key, the next display in the specified sequence appears on the left console screen.

DISPLAY SCREEN HEADERS

Standard system headers appear on each of the display screens. The left screen header provides the following information.

- Time and date (specified by the DSD TIME and DATE commands) in the form hh.mm.ss. and yy/mm/dd.
- Comment lines (specified by the NAME entry in CMRDECK).
- Job count represented by a four-character sequence number ranging from AAAA to 9999. A job count of AAAD indicates that three jobs have entered the system since deadstart.
- Console status (either UNLOCKED or blank). Refer to section 3 for a description of the LOCK and UNLOCK commands.
- System modification status (either DEBUG or blank). Refer to section 3 for a description of the DEBUG command.
- Monitor step mode (either STEP or blank). Refer to section 3 for a description of the STEP and UNSTEP commands.
- Engineering mode (either ENGR or blank). Refer to section 3 for a description of the ENGR command.

The right screen header provides the following information.

- Contents of the P register(s).
- Control point to which the CPU is assigned.
- Status of the channels.
- Amount of central memory and ECS memory which is unassigned.

In addition, at the bottom of the right screen, each peripheral processor is represented by an entry for the program currently running and the control point to which the program is assigned. PP0 and PP1 are dedicated to monitor (MTR) and DSD, respectively.

Any display can appear on the left or the right screen, and therefore, can have a left screen or a right screen header. Figures 4-1 and 4-4 illustrate the left and right screen headers, respectively. All other displays illustrated in this section are shown without a header.

DAYFILE (A) DISPLAYS

The system saves five types of dayfiles. The system dayfile contains the system history. The account dayfile keeps the accounting record for further processing (for example, customer billing). The error log dayfile records system error messages, such as disk errors. Control point dayfiles record the operations of each job. The binary maintenance log dayfile records information used in Control Data maintenance. You cannot display the binary maintenance log dayfile.

To bring the system, account, or error log dayfile to the screen, type one of the following:

<u>DSD Command</u>	<u>Dayfile</u>
A,.	System
A,ACCOUNT FILE.	Account
A,ERROR LOG.	Error log

To display other control point dayfiles, enter either of the following DSD commands:

A,n. n is the control point number

or

A,. Locate the control point dayfile you want by pressing the + or - key (or left or right parenthesis).

Only the most recent dayfile messages appear on the A display. To examine previous messages, reset the A display to the beginning of the dayfile buffer by entering the DSD command:

A.

If the A display is not currently selected, this command resets the system dayfile to the beginning of the dayfile buffer and brings it to the left console screen.

The system adds dayfile messages to one or more of the dayfiles when:

- The system processes a control statement or a system action occurs which is not in direct response to a control statement (such as an error message).
- The system detects an error.
- A user enters a comment either via a COMMENT control statement or MESSAGE macro.
- You enter a message at the console.

When a job terminates, the system sends the messages to the account dayfile which contains a record of the resources charged to the job. In addition, control-point dayfile entries are printed at the end of a job's output. The system dayfile, which includes entries for all jobs processed, is available as a record of all action taken since deadstart. Although the A display shows only the entries currently in the dayfile buffer, you can obtain the entire contents by dumping the file to a print file or tape unit.

Messages on the A display appear in the following formats.

System dayfile messages:

time.jobname.message.

Account dayfile messages:

time.jobname.activity,additional information.

Error log dayfile messages:

time.jobname.message.

The time is the time of day as entered into the system at deadstart or by a TIME command to DSD. For example, if the system is deadstarted at 8:00 a.m. and the time is entered at deadstart, the time in 10 minutes is 08.10.00. If the time was not entered at deadstart, the time in 10 minutes is 00.10.00. The time is followed by the name of the job associated with the message and the message itself. As a job is processed, messages are sent to the dayfile by PP programs or central memory programs.

The job name is a combination of several parameters which describe the job. The first seven characters are the system-assigned job name and the eighth character indicates the origin of the job. The job name is constructed as follows:

System origin jobs

The first field consists of the first four characters of the utility function specified. If fewer than four characters are entered, the field is zero-filled. The next field consists of the three rightmost characters of the job sequence number, which ranges from AAA to ZZZ. For example, if the operator enters X.PFS, the job name may be PFS0AACS. If X.BLANK is entered, the job name may be BLANAADS. The eighth character for system origin jobs is S.

Batch origin and Remote Batch Facility jobs

The first four characters are derived from the user index associated with the user number supplied on the USER statement. The next three characters are the rightmost characters of the job sequence number. The eighth character for batch origin jobs is B.

Time-sharing origin and Export/Import jobs

The first four characters are derived from the user index associated with the user number supplied by the user when he logs into the system. The next three characters represent the number of the terminal on which the user is logged in for time-sharing jobs and the job sequence number for remote batch jobs. The eighth character is T for time-sharing jobs and E for remote batch jobs.

The activity given in account dayfile messages is a unique four-character identifier which defines a particular activity. The first character identifies the information group; the second character, the event which caused the message to be entered into the account file; and the third and fourth characters, the activity being recorded. The purpose of this field and the additional information which follows it is to record system usage and provide a means of accurately billing users. Complete descriptions of account file activity messages can be found in the NOS System Maintenance Reference Manual.

Each control statement executed, including the job statement, is entered into the dayfile. The dayfile may be observed as follows:

- On the console screen (A display), the file is moved up the display screen as messages are generated.
- At the end of a job's printed output, all dayfile messages associated with that job are printed. However, time-sharing origin (TXOT) jobs must request the dayfile listing via terminal command.

If the A display is on the left screen, you can alternate between the system dayfile and a control-point dayfile using + and - keys. The + and - keys page the A display through each control-point dayfile forward and backward, respectively. After the last control point, the display returns to the system dayfile. The right screen is paged with the left and the right parentheses keys.

To dump a dayfile to a specified equipment, type:

<u>DSD Command</u>	<u>Dayfile</u>
DAYFILE,xx.	System
ACCOUNT,xx.	Account
ERRLOG,xx.	Error log
xx	Equipment status table (EST) ordinal of the equipment to which the dayfile is to be dumped.

Refer to description of EST (E,A. or E,) display. Check to ensure that the tape or disk specified is ready and immediately available for the dayfile dump. Additional information is given under Dayfile Commands in section 3.

Figure 4-1 illustrates the system dayfile display, figure 4-2 illustrates the account dayfile display, and figure 4-3 illustrates the error log dayfile display.

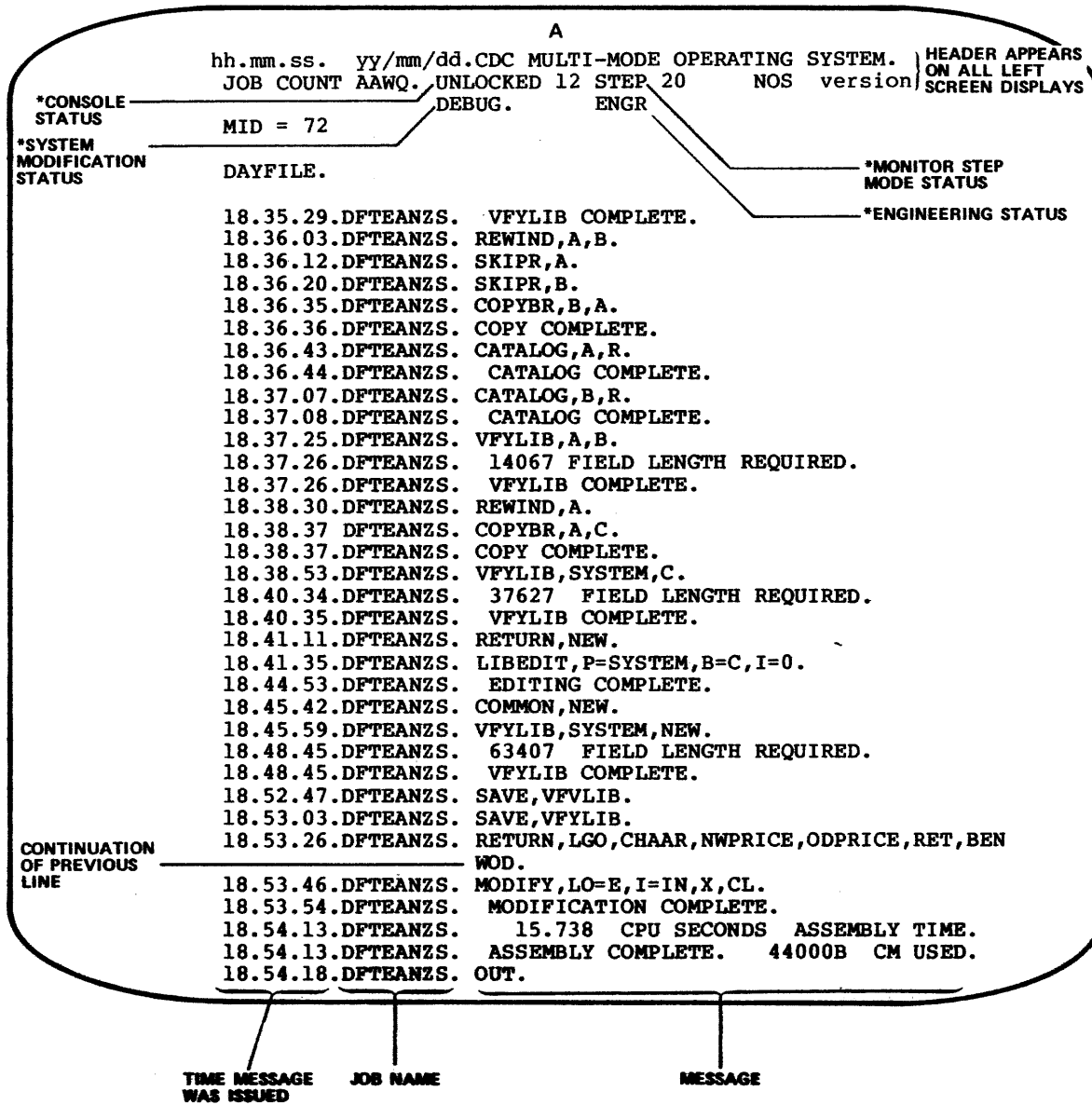

Figure 4-1. System Dayfile (A) Display

A

hh.mm.ss. yy/mm/dd. CDC MULTI-MODE OPERATING SYSTEM.
JOB COUNT AAWQ. UNLOCKED 12 STEP 20 NOS version .
MID = 72 DEBUG. ENGR.

ACCOUNT FILE.

16.43.46.DFTEANZS.	SPCT, CATALOG.	
16.43.47.DFTEANZS.	SPDF, ERA0414, , .	
16.43.48.DFTEANZS.	APPN.	
16.43.51.DFTEANZS.	APPN.	
16.43.51.DFTEANZS.	SPCT, CATALOG.	
16.43.51.DFTEANZS.	APPN.	
16.43.52.DFTEANZS.	SPCT, CATALOG.	
16.43.52.DFTEANZS.	SPCT, CATALOG.	
16.43.52.DFTEANZS.	APPN, PACKEI.	
16.43.52.DFTEANZS.	SPCT, CATALOG, , PACKEI.	
16.43.53.DFTEANZS.	APPN.	
16.43.59.AACIO46T.	UECO,	0.652KCHS.
16.43.59.AACIO46T.	UECI,	0.200KCHS.
16.43.59.AACIO46T.	UEPF,	0.160KUNS.
16.43.59.AACIO46T.	UEMS,	6.120KUNS.
16.43.59.AACIO46T.	UECP,	15.100SECS.
16.43.59.AACIO46T.	AESR,	16.715UNTS.
16.44.15.DFTEANZS.	UEPF,	0.004KUNS.
16.44.15.DFTEANZS.	UEMS,	0.104KUNS.
16.44.15.DFTEANZS.	UECP,	0.420SECS.
16.44.15.DFTEANZS.	AESR,	1.000UNTS.
16.44.20.AAAQO53T.	SPCT, INPUT.	
16.44.36.QFSPANRS.	UCLP, 23,	0.102 KLNS.
16.44.39.QFSPAMYS.	UCLP, 22,	0.256 KLNS.
16.44.42.DFTEANZS.	UCLP, 23,	0.256 KLNS.
16.45.27.AAAQO53T.	SPGT, COMSSCP, , .	
16.45.42.AACIO46B.	UCLP, 23,	1.472 KLNS.
16.45.44.AACIO46B.	UCLP, 22,	1.472 KLNS.
16.46.37.AAAQO53T.	UCCO,	4.096KCHS.
16.46.44.AAAQO53T.	UECO,	0.099KCHS.
16.46.44.AAAQO53T.	UECI,	0.139KCHS.

Figure 4-2. Account Dayfile (A) Display

A

hh.mm.ss. yy/mm/dd. CDC MULTI-MODE OPERATING SYSTEM.
JOB COUNT AAWQ. UNLOCKED 12 STEP 20 NOS version.
MID = 72 DEBUG. ENGR.

ERROR LOG.

MT,C12-5-01,****51,RD, ,S0,3207, 0000.
16.19.19.DFTEANZS. MT,C12,F06,E00,B001033, PARITY.
16.19.20.DFTEANZS. MT,C12-5-01,****51,RD, ,S0,3207, 0000.
16.19.20.DFTEANZS. MT,C12,F06,E00,B001034, PARITY.
16.19.20.DFTEANZS. MT,C12-5-01,****51,RD, ,S0,3207, 0000.
16.19.20.DFTEANZS. MT,C12,F06,E00,B001035, PARITY.
16.19.20.DFTEANZS. MT,C12-5-01,****51,RD, ,S0,3207, 0000.
16.19.20.DFTEANZS. MT,C12,F06,E00,B001036, PARITY.
16.19.21.DFTEANZS. MT,C12-5-01,****51,RD, ,S0,3207, 0000.
16.19.21.DFTEANZS. MT,C12,F06,E00,B001037, PARITY.

Figure 4-3. Error Log Dayfile (A) Display

JOB STATUS (B) DISPLAY

DSD displays the status of control points. Figure 4-4 illustrates the job status (B) display. The number of control

points is specified at deadstart time (23 maximum). The system adds one control point to the number specified and dedicates it to system use.

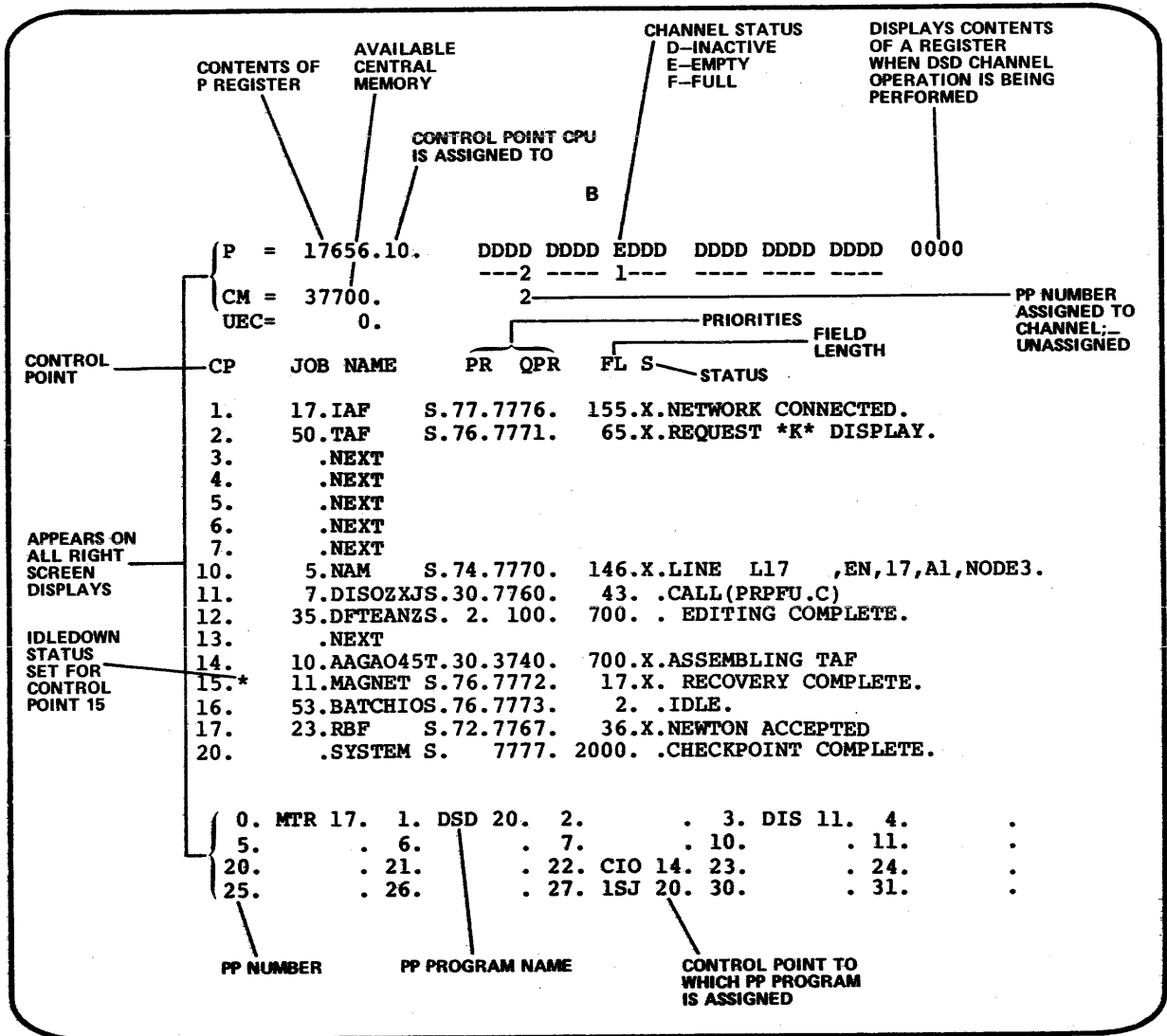

Figure 4-4. Job Status (B) Display

A control point entry appears in the following format.

n job jobname pr qpr * fl s mes

n Control point number. A job is assigned to a control point when it is residing in central memory. If an * follows the control point number, idledown status is set for that control point.

job FNT ordinal of the job. All jobs are assigned an entry in the FNT (refer to the H display).

jobname Names assigned by the system to uniquely identify the job. The job name consists of a seven-character identifier with an eighth character appended to signify the job origin type. The five job origin types are:

S System job.

T Time-sharing job.

B Local batch job.

E Remote batch job.

M Multiterminal job.

pr CPU priority (the job priority for the CPU.)

qpr Queue priority (use the queue priority to control the scheduling of the job from the queues).

* If present, job has ECS field length assigned.

fl Field length/100 of job being processed.

s CPU status:

A Control point using CPUA.

B Control point using CPUB (dual CPU systems only).

W Control point waiting for CPU.

X Control point is in recall.

I Control point is in autorecall (waiting for completion of system request: I/O tape, assign, and so forth).

blank CPU not needed at this control point.

mes First 30 characters of the message area for the control point. Messages requiring your intervention, control statements being processed, and error messages are displayed here. If a message requires your action, it may be periodically intensified by the system.

When a machine is running in multimainframe mode, certain configurations may cause jobs to wait because of controller reservations by another machine. When this happens, the disk error message specifying a controller reservation (CR as error code) appears in this field. The message

ECS ERROR.

appears in this field at the system control point when the system encounters errors in ECS.

STORAGE (C,D,F,G,M) DISPLAYS

These displays show the contents of central memory (C, D, F, and G displays) and ECS memory (M display). Each storage display consists of four groups of either central memory or ECS memory words, with the groups numbered 0 through 3 from top to bottom. The format of each line of the display is:

address octal word display code equivalent

Central memory and ECS memory can be displayed with absolute or relative addresses. The octal words in the C, D, and M displays are shown in five columns of four octal digits; words in the F and G displays have four columns of five digits. The character equivalent to the display-coded octal digits appear to the right of the octal word. Blanks appear for any character with an octal display code above 57, as well as for display codes 00, 53, and 55.

The FR field at the top of the M display shows the contents of the ECS flag register as of the last status. (Status is taken once every second by the monitor.) ECS parity errors in words on the M display are denoted by intensifying the address and data of the words in error.

To bring the C, D, F, G, and M displays to the screens, enter one of the following commands.

xy.

Brings the x and y displays to the left and right console screens, respectively (x and y are C, D, F, G, or M). Unless a control point memory display has previously been selected (refer to following command), all words displayed represent absolute memory locations.

x,n.

Brings a specified control point memory display to the left console screen as follows:

- x Display identifier (C, D, F, G, or M).
- n Control point number.

All words displayed are relative to the reference address (RA for central memory, RAE for ECS memory) for the control point specified by n. When addresses relative to a control point are displayed, the control point number appears next to the display identifier at the top of the screen (for example, D15.). However, after a control point memory display has initially been selected, either absolute addresses or those relative to the control point may be displayed. Pressing the = key alternates the display between its relative and absolute settings. When absolute memory locations are displayed, the display identifier appears alone at the top of the screen (the control point number is erased).

xz,aaaaaa.

Brings a specified memory display to the left console screen, if not currently selected, and provides display modification as follows:

- x Display identifier (C, D, F, G, or M).
- z Type of display modification:
 - z=0-3 Changes the specified word group (0 through 3) to display the eight words beginning at memory location aaaaaa.
 - z=4 Changes the display so that all four eight-word groups are displayed as 32 contiguous memory locations beginning at location aaaaaa.
 - z=5 Advances the display by aaaaaa locations.
 - z=6 Decrements the display by aaaaaa locations.

aaaaaa Location parameter.

If a control point number appears with a memory display identifier (C, D, F, G, or M) at the top of the screen, the memory locations shown in the display are relative to that control point. If no

control point number is indicated, all memory locations shown are absolute.

When a memory display is on the left screen, the address can be stepped forward or backward 40 octal locations by pressing the + or - key; the right screen is paged with the left and right parentheses keys. Memory displays can also be set to advance or decrement by a specified constant by using the x5,aaaaaa. and x6,aaaaaa. entries.

For example:

- Carriage return Causes the REPEAT ENTRY message to appear (refer to section 1).
- C5,101. Increments present C display by 101. Each successive carriage return increments the displays by 101.

x6,aaaaaa. is used in the same manner to decrement by the value specified.

The selection of a control point memory display and/or the selection of addresses for any word group on a memory display remain in force even though the display is not on either screen. For instance, if the standard format of xy. is used to recall the C display to the screen, the control point and/or the addresses shown are those specified by the last call in the format C,n. and/or Cz,aaaaaa. For example, if the A and B displays are on the left and right screens and you type in the following sequence, the displays change as follows:

- C,5. The A display on the left screen is replaced by the C display showing the words at locations 0 through 37 relative to control point 5.
- C3,1234. The fourth group of words on the display changes from words at locations 30 through 37 to those at locations 1234 through 1243.
- AB. The B display remains on the right screen; the C display is replaced by the A display on the left screen.
- CB. The C display for control point 5 is brought back to the left screen still showing the words at locations 0 through 7 (group 0), 10 through 17 (group 1), 20 through 27 (group 2), and 1234 through 1243 (group 3).

Figure 4-5 illustrates the C and D central memory displays, figure 4-6 illustrates the F and G central memory displays, and figure 4-7 illustrates the M ECS memory display.

C

ADDRESS	MEMORY CONTENTS					DISPLAY CODE EQUIVALENT
000000	0000	0000	0000	0000	0000	
000001	0002	2156	0012	0004	4000	BQ, J D5
000002	0003	6112	0000	0027	6200	C J W
000003	6320	0001	7417	0000	0003	P A O C
000004	6600	7600	0000	0001	3340	A05
000005	6500	6600	6504	0000	0000	D
000006	0003	6111	0003	7302	0000	C I C B
000007	0003	6265	0003	7323	0000	C C S
000010	0000	0000	0000	0000	0000	
000011	0000	0000	0000	0000	0000	
000012	0000	0000	0000	0000	0000	
000013	0000	0000	0000	0000	0000	
000014	0000	0000	0000	0000	0000	
000015	0000	0000	0000	0000	0000	
000016	0000	0000	0000	0000	0000	
000017	0000	0000	0000	0000	0000	
000020	0000	0000	0000	0000	0377	C
000021	2331	2324	0515	5555	0000	SYSTEM
000022	0000	0000	0001	0102	2700	AABW
000023	0000	0000	0000	0000	2067	P
000024	0000	0010	1000	0010	0010	HH H H
000025	0000	0000	0000	0000	0000	
000026	0000	0000	0042	3634	3534	73121
000027	0000	0000	0305	0120	3147	CEAPY*
000030	5534	4157	3540	5736	4457	16.25.39.
000031	5542	4350	3340	5035	4457	78/05/29.
000032	5503	0403	5515	2514	2411	CDC MULTI
000033	4615	1704	0555	1720	0522	-MODE OPER
000034	0124	1116	0755	2331	2324	ATING SYST
000035	0515	5700	0000	0000	0000	EM.
000036	0000	0000	0000	0000	0000	
000037	0000	0000	0000	0000	0000	

FIVE COLUMNS
OF FOUR
CHARACTERS

Figure 4-5. Central Memory (C) Display

F

ADDRESS	MEMORY CONTENTS				DISPLAY CODE EQUIVALENT
000000	00000	00000	00000	00000	
000001	00022	15600	12000	44000	BQ, J DS
000002	00036	11200	00002	76200	C J W
000003	63200	00174	17000	00003	P A O C
000004	66007	60000	00000	13340	A05
000005	65006	60065	04000	00000	D
000006	00036	11100	03730	20000	C I C B
000007	00036	26500	03732	30000	C C S
000010	00000	00000	00000	00000	
000011	00000	00000	00000	00000	
000012	00000	00000	00000	00000	
000013	00000	00000	00000	00000	
000014	00000	00000	00000	00000	
000015	00000	00000	00000	00000	
000016	00000	00000	00000	00000	
000017	00000	00000	00000	00000	
000020	00000	00000	00000	00377	C
000021	23312	32405	15555	50000	SYSTEM
000022	00000	00000	01010	23100	AABY
000023	00000	00000	00000	02530	UX
000024	00000	01010	00001	00010	HH H H
000025	00000	00000	00000	00000	
000026	00000	00000	42363	43534	73121
000027	00000	00003	05012	03252	CEAPZ)
000030	55344	15735	41573	73557	16.26.42.
000031	55424	35033	40503	54457	78/05/29.
000032	55030	40355	15251	42411	CDC MULTI
000033	46151	70405	55172	00522	-MODE OPER
000034	01241	11607	55233	12324	ATING SYST
000035	05155	70000	00000	00000	EM.
000036	00000	00000	00000	00000	
000037	00000	00000	00000	00000	

FOUR COLUMNS OF FIVE CHARACTERS

Figure 4-6. Central Memory (F) Display

```

FLAG REGISTER    000000

00000000 3700 0000 1401 0205 1400 4 LABEL
00000001 0002 0036 0000 3700 4003 B 3 4 5C
00000002 0000 0000 0100 1343 3032 A K8XZ
00000003 0000 0000 0602 2023 4642 FBPS-7
00000004 0000 0000 0000 0000 0000
00000005 0000 0000 0000 0000 0000
00000006 0000 0000 0000 0000 0000
00000007 0000 0000 0000 0000 0000

00000010 0000 0000 0000 0000 0000
00000011 0000 0000 0000 0000 0000
00000012 0000 0000 0000 0000 0000
00000013 0000 0002 4235 2514 1102 B72ULIB
00000014 0000 0000 0000 0000 0000
00000015 0000 0000 0000 0000 0000
00000016 0000 0000 0000 0000 0000
00000017 0402 0020 0000 0000 0000 DP P

00000020 1401 0205 1400 0001 0500 LABEL AE
00000021 3440 0000 0000 0000 0000 15
00000022 0000 0006 0221 1524 1600 FBQMLN
00000023 0000 0000 0000 0000 0000
00000024 0000 0000 0000 0000 0000
00000025 0000 0000 0000 0000 0000
00000026 0000 0000 0000 0000 0000
00000027 0000 0000 0000 0000 0000

00000030 0000 0000 0000 0000 0000
00000031 0000 0000 0000 0000 0000
00000032 0000 0000 0000 0000 0000
00000033 0000 0000 0000 0000 0000
00000034 0000 0000 0000 0000 0000
00000035 0000 0000 0000 0000 0000
00000036 0420 0020 0000 0000 0000 DP P
00000037 0000 0000 0000 0000 0000

```

Figure 4-7. ECS Memory (M) Display

EQUIPMENT STATUS (E) DISPLAYS

The E display lists the status of peripheral equipment. The type of information supplied varies according to the subdisplay specified.

<u>Command</u>	<u>Display</u>
E, or E,A.	Equipment status table (EST).
E,C.	Mass storage configuration.
E,M.	Mass storage status.
E,P.	Resource mounting preview.
E,T.	Tape status.

EST (E, OR E,A.) DISPLAY

The EST display lists the status of all devices in the equipment status table. Each entry appears in the following format.

no	type	stat	eq	un	channels
no			EST ordinal.		
type	Device type.				
stat	Equipment status (ON, OFF, or DWN†).				
eq	Equipment number.				
un	Unit number (serves as ID code for unit record devices).				
channels	Channel(s) on which equipment is available.				

A control point number precedes the equipment number in each entry if that piece of equipment is assigned to a control point. An asterisk (*) instead of a period (.) following the channel number entry indicates that the channel is down. The identifier code (un parameter) provides a method of grouping peripheral devices when a site has several units. Output from a job read in through a card reader with identifier xx can only be directed to a device with the same identifier. Changing the identifier code via the ROUTE control statement or an LP DSD command can direct program output to a special printer (for example, for form control or multiple copy forms). The following device types can appear in the second column of the equipment status display.

CP	415 Card Punch.
CR	405 Card Reader.
CS	MSS Cartridge Selector.
CT	MSS Cartridge Transport.
DE	ECS.
DI	844-21 Disk Storage Subsystem (half track).
DJ	844-41/44 Disk Storage Subsystem (half track).
DK	844-21 Disk Storage Subsystem (full track).

DL	844-41/44 Disk Storage Subsystem (full track).
DM	885 Disk Storage Subsystem (half track).
DP	Distributive data path to ECS.
DQ	885 Disk Storage Subsystem (full track).
DS	Console display.
LP	Any line printer.
LR	580-12 Line Printer.
LS	580-16 Line Printer.
LT	580-20 Line Printer.
MT	Magnetic tape drive (7-track).
NQ	NPU Entry for NPS Stimulation.
NP	255x Network Processing Unit.
NT	Magnetic Tape Drive (9-track).
ST	Export 6671/6676/2550-100 Multiplexer.
TT	6671/6676/2550-100 Multiplexer.

The system creates the following device types at deadstart for internal use. Physical hardware does not exist for this equipment. The device types appear in the second column of the equipment status display along with the real device types.

NE	Null equipment.
RD	Used for on-line reconfiguration of mass storage.
TE	Tape equipment.
TT	Used for assignment of terminal files (equipment number 75).

Figure 4-8 illustrates the equipment status display.

MASS STORAGE CONFIGURATION (E,C.) DISPLAY

The E,C display shows the current configuration of mass storage devices in the system. Each line in the display appears in the following format.

eq	type	chan	fm/pn-un	iam	dam	dn	units
eq	EST ordinal.						
type	Device type.						
	DE	ECS.					
	DI	844-21	Disk	Storage	Subsystem (half track).		
	DJ	844-41/44	Disk	Storage	Subsystem (half track).		
	DK	844-21	Disk	Storage	Subsystem (full track).		

†DWN is DOWN status. An equipment cannot be logically turned ON when in DWN status.

DL 844-41/44 Disk Storage Subsystem (full track).

DM 885 Disk Storage Subsystem (half track).

DP Distributive data path to ECS.

DQ 885 Disk Storage Subsystem (full track).

fm/pn-un Family name/packname-user number.

iam Indirect access file mask.

dam Direct access file mask.

dn Device number.

units List of units which are defined in the CMRDECK.

chan Channels.

Figure 4-9 illustrates the mass storage configuration display.

E

EQUIPMENT STATUS TABLE. ADDRESS = 6500. INDEX = .

NO.	TYPE	STAT	EQ	UN	CHANNELS	
0.	RD	ON	. 0.	0.	0.	.
1.	DI	ON	. 1.	0.	3.	.
2.	DJ	ON	. 6.	0.	4.	.
3.	DJ	ON	. 6.	1.	4.	.
10.	DS	ON	11.	7.	0.	10.
11.	CR	ON	. 4.	0.	13.	.
12.	CP	ON	. 5.	0.	13.	FORMS = AA.
13.	DE	DWN	22.	.
20.	LP	ON	. 6.	0.	13.	FORMS = .
21.	LP	ON	. 3.	0.	13.	FORMS = .
22.	LP	OFF	. 7.	0.	13.	FORMS = AF.
37.	TT	OFF	. 7.	1.	2.	.
40.	TT	ON	1.	7.	0.	1.
50.	MT	ON	. 5.	0.	12.	.
51.	MT	ON	4.	5.	1.	12.
52.	MT	ON	. 5.	2.	12.	.
53.	MT	ON	3.	5.	3.	12.
55.	CS	ON	. 1.	0.	5.	ID = 01 000.
56.	CT	ON	. 1.	1.	5.	ID = 01 001.
60.	MT	ON	. 4.	0.	12.	11*
61.	NT	ON	. 4.	1.	12.	11*
62.	NT	ON	. 4.	2.	12.	11*
63.	NT	ON	. 4.	3.	12.	11*
64.	NT	ON	. 4.	4.	12.	11*
75.	TT	ON	. 0.	0.	0.	.
76.	TE	ON	. 0.	0.	0.	.
77.	NE	ON	. 0.	0.	0.	.

EST
ORDINAL

EQUIPMENT
STATUS

EQUIPMENT
TYPE

EQUIPMENT
STATUS

CONTROL POINT TO WHICH
EQUIPMENT IS ASSIGNED

EQUIPMENT
NUMBER

PHYSICAL UNIT
NUMBER

Figure 4-8. Equipment Status (E., or E,A.) Display

E

MASS STORAGE CONFIGURATION.

E.Q.	TYPE	CHAN	FM/PN-UN	IAM	DAM	DN	UNITS
1.	DJ	26. 32	SYST72	377	377	1.	6
2.	DJ	26. 32.	SYST72	0	0	2.	7
3.	DJ	26. 32.	SYST72	0	0	3.	1
4.	DI	26. 32.	PACK8C	377	377	0.	2
5.	DI	26. 32.		0	0	0.	3
6.	DI	26. 32.		0	0	0.	4
7.	DI	26. 32.	SYS172	377	377	40.	5
11.	DP	30.	SYS172	0	0	10.	0

Figure 4-9. Mass Storage Configuration (E,C.) Display

MASS STORAGE STATUS (E,M.) DISPLAY

The mass storage status display provides detailed status information about all mass storage devices. The PFNL entry is described in the NOS System Programmer's Instant. Each entry in the display appears in the following format.

eq type status files trks famc dafc

eq EST ordinal.

type Device type:

DE ECS.
 DI 844-21 Disk Storage Subsystem (half track).
 DJ 844-41/44 Disk Storage Subsystem (half track).
 DK 844-21 Disk Storage Subsystem (full track).
 DL 844-41/44 Disk Storage Subsystem (full track).
 DM 885 Disk Storage Subsystem (half track).
 DP Distributive data path to ECS.
 DQ 885 Disk Storage Subsystem (full track).

status Status conditions. Any combination of conditions can exist. The following codes are listed in the order in which they appear on the display.

S System resides on this device.
 M Device is shared by more than one mainframe.
 R Device is removable.
 U Device is unavailable.
 L Device is in local unload status and, therefore, not available for permanent file access.
 C Checkpoint requested for specific device. Ensure that C status is not present before dismounting a removable device, issuing an OFF command to logically remove a device, or attempting to perform deadstart.
 I Initialization requested or format is pending.
 A Alternate system device.

X Device is an auxiliary permanent file device.

O Catalog track overflowed.

F CTI is installed on the device.

D System deadstart file is installed on the device.

* Reconfiguration is requested.

N Device is in global unload status (all machines sharing the device have it in local unload status). Do not physically remove a pack unless N status is displayed on all machines sharing the device.

P A permanent file utility is active.

files Types of files which are allowed on this device. Any combination of types can exist. The following codes are listed in the order in which they appear on the display.

S Secondary rollout.

B LGO.

L Local.

P Primary.

D User dayfile.

R Rollout.

O Output.

I Input.

T Temporary.

trks Number of tracks available on device.

famc Number of jobs in that device's family.

dafc Number of direct access files attached.

In addition, if an error is detected, the system displays (and periodically intensifies) an error code following the dafc field.

CA Checkpoint abort (unable to checkpoint device); contact a site analyst.

CE Configuration error (active device has one of the packs mounted or defined incorrectly).

CS The size of permanent file catalogs on the device is incorrect for the current system.

DN Device number conflicts with that of another device in the family.

EI Error idle status has been set for the device as a result of some error; contact a site analyst.
 IL Incorrect label (the label on an active device is incorrect); contact a site analyst.
 IN Device has initialize status set (only if set via deadstart).
 LE Label error (unrecognizable label).
 LK Error in TRT linkage detected when recovering permanent files. No recovery possible. Can occur only when introducing removable devices after deadstart; contact a site analyst.
 NR Not ready.
 OF Device has OFF status.
 PN Duplicate pack name exists.
 TL Length of device's TRT entry is in error; no recovery possible; contact a site analyst.
 UM Sum of the device masks for family does not equal 377g; contact a site analyst.
 VE Error status set in MST because of failure during mass storage table validation; contact a site analyst.

GE Magnetic tape unit (6250-cpi, 9-track).
 DIi 844-21 Disk Storage Subsystem (1≤i≤8) (half track).
 DJi 844-41/44 Disk Storage Subsystem (1≤i≤8) (full track).
 DKi 844-21 Disk Storage Subsystem (1≤i≤8) (half track).
 DLi 844-41/44 Disk Storage Subsystem (1≤i≤8) (full track).

pn/vsn One- to six-character volume serial number of the required tape or one- to seven-character pack name of the required pack. The pn/vsn is obtained from the user's control statement.†

usernum User number of job.

ring Magnetic tape ring enforcement (if any):

IN Write enable required (ring in).
 OUT Write disable required (ring out).
 — No ring enforcement.

label Magnetic tape label requirements (if any):

YES A labeled tape is required.
 — No label is required.

status Operator message indicating an error condition (refer to message's entry in appendix B) or a MOUNT request. If MOUNT appears in this field, the next volume of a multireel file should be mounted. Subsequent reels of a multireel file must be mounted on a drive of similar type and on the same channel(s) as the first reel of the file. That is, if the first reel of a file is on a 669 tape unit on channel 13 and 33, all subsequent reels must be on a 669 unit on channels 13 and 33. For purposes of reel swapping, models 679-2, -3, and -4 drives (800/1600 cpi) and models 679-5, -6, and -7 drives (1600/6250 cpi) are considered different drive types.

NOTE

When a VE status error occurs, the device becomes interlocked. A PP program that attempts to access that device cannot complete until the interlock is cleared. Enter the DSD command VALIDATE to remove the VE error and interlock.

Figure 4-10 illustrates the mass storage status display.

RESOURCE MOUNTING PREVIEW (E,P.) DISPLAY

The preview display identifies the tapes and packs needed to satisfy user's requests. In order for this display to be selected, the magnetic tape subsystem (MAGNET) must be executing at a control point. Each line in the display appears in the following format.

```

no eq pn/vsn usernum ring label status
no      FNT ordinal job.
eq      Resource type:
        MT  Magnetic tape unit (7-track).
        HD  Magnetic tape unit (800-cpi,
           9-track).
        PE  Magnetic tape unit (1600-cpi,
           9-track).
  
```

Figure 4-11 illustrates the preview display.

TAPE STATUS (E,T.) DISPLAY

The tape status display summarizes the status of all magnetic tape units in the system. To page the display forward and backward, use the following commands.

E,T+ Displays next available page.
 E,T- Displays previous page.

† If the user's VSN request is in the form VSN, file=vsn1=vsn2, the E,P display will display the first volume serial number (vsn1) as the VSN of the tape which is requested. If the second tape (with VSN of vsn2) is subsequently mounted, the system will assign it to the job, but assignment may not be immediate. The maximum delay is the time a job is rolled out waiting for a specific VSN (approximately 2 minutes). If the job ordinal is known, the job can be rolled in (refer to ROLLIN,xxx command in section 3).

E

MASS STORAGE STATUS.

PFNL 0000 0000 0000 0007 0101

E.Q.	TYPE	STATUS	FILES	TRKS	FAMC	DAFC	
1.	DJ	S-----	-----T	2624.	.	.	
2.	DJ	S-----F---	-----T	2624.	.	.	
3.	DJ	-----F---	-----T	3137.	.	.	
4.	DI	--R---X-FD--	-----	503.	.	.	
5.	DI	--RU-----	-----	3140.	.	.	NR
6.	DI	--RU-----	-----	3140.	.	.	NR
7.	DI	-----OF---	-----	1101.	13.	5.	
11.	DP	-----A-----	-----	7.	.	.	

Figure 4-10. Mass Storage Status (E.M.) Display

E

RESOURCE MOUNTING PREVIEW.

NO.	EQ	PN/VSN	USERNUM	RING	LABEL	STATUS
41	PE	TEST	USER123	IN	YES	MOUNT
31	MT	5037	UI10	IN	YES	MT60 RING CONFLICT
20	MT	A	TTEST	--	--	
26	HD	TAPE1	AJL25	OUT	YES	

Figure 4-11. Resource Mounting Preview (E,P.) Display

These commands can be used regardless of whether the display is on the left or right screen. Each entry appears in the following format.

<p>eq vsn den r f cp job status fileid m cv</p> <p>eq Identifies the equipment being used:</p> <p style="padding-left: 40px;">MTuu 7-track; uu is the EST ordinal</p> <p style="padding-left: 40px;">NTuu 9-track; uu is the EST ordinal</p> <p>vsn Volume serial number of the mounted tape. The E,T display shows a VSN of ****uu when the tape does not contain a recognizable label. The uu portion of the display is the EST ordinal.</p> <p>den Density (bpi/cpi):</p> <p style="padding-left: 40px;">200 200 bpi (implies 7-track).</p> <p style="padding-left: 40px;">556 556 bpi (implies 7-track).</p> <p style="padding-left: 40px;">800 800 bpi/cpi (7- or 9-track).</p> <p style="padding-left: 40px;">1600 1600 cpi (implies 9-track).</p> <p style="padding-left: 40px;">6250 6250 cpi (implies 9-track).</p> <p>r Ring status (IN if the write enable ring is in; blank if the ring is out).</p> <p>f Data format:</p> <p style="padding-left: 40px;">I Internal.</p> <p style="padding-left: 40px;">SI System internal (NOS/BE system default format).</p> <p style="padding-left: 40px;">S Stranger.</p> <p style="padding-left: 40px;">L Long block stranger.</p> <p style="padding-left: 40px;">F Foreign.</p> <p>cp Control point to which the specified job is assigned.</p> <p>job Name of the job to which the tape unit is assigned.</p> <p>status Status of the tape unit:</p> <p style="padding-left: 40px;">READY Unit is ready.</p> <p style="padding-left: 40px;">IDLE Unit is idle.</p>	<p>LOADPT Tape is positioned at load point.</p> <p>ROLLED Job using tape unit has been rolled out.</p> <p>DOWN Unit has been logically removed from the operating environment via the OFF command. DOWN status is not set until a subsequent operation is attempted on that unit.</p> <p>NOTRDY Unit is not ready.</p> <p>MOUNT Indicates that next reel should be mounted. Reel to be mounted may be identified by VSN, or if tape is unlabeled, by reel number.</p> <p>fileid File identifier obtained from tape label. No column heading is displayed for this field; it is the first field in the second line of the entry and appears under the vsn field.</p> <p>rn Reel number currently in use or reel to be mounted if MOUNT status is set. No column heading is displayed for this field although the characters RN identify its position in the second line of the entry.</p> <p>cv Conversion mode of mounted tape. If tape is not assigned, this is the conversion mode of labels. If the tape is assigned, this is the conversion mode of labels and coded data. No column heading is displayed for this field although the characters C. precede the value for cv in the second line of the entry. Values for conversion mode are:</p> <p style="padding-left: 40px;">Blank No conversion (unlabeled and not assigned).</p> <p style="padding-left: 40px;">BC BCD (7-track).</p> <p style="padding-left: 40px;">AS ASCII (9-track).</p> <p style="padding-left: 40px;">EB EBCDIC (9-track).</p>
--	--

Figure 4-12 illustrates the tape status display.

All subsequent reels of a labeled multireel file must have the same characteristics as the first reel of the file; that is, they must be labeled (at the same density), they must be the same track type, and they must have the same conversion mode.

E

EQ	VSN	DEN	R	F	CP	JOB	STATUS
MT50	****50	800					IDLE
	UNLABELED				RN	1.C.	
MT51	****51	800	IN	I	4.	DFTEANZS	LOADPT
	UNLABELED				RN	1.C.BC	
MT52		800					IDLE
MT53	****53	800		I	3.	DISOAAOS	NOTRDY
	UNLABELED				RN	1.C.BC	
MT60		1600					IDLE
NT61	PACKC	1600					IDLE
	SYSTEMPF				RN	1.C.AS	
NT62		1600					IDLE
NT63		1600					IDLE
NT64		1600					IDLE

Figure 4-12. Tape Status (E,T.) Display

FILE NAME TABLE (H) DISPLAY

Use the H display to obtain information about a file such as its status, type, and the control point to which it is assigned. When the display is on the left screen, the + or - key can be used to step the display forward one page; the right screen is paged with the left and right parentheses keys. More than one page exists if the message

MORE FILES FOLLOW.

appears at the bottom of the display. The format of each line is:

```
no name cp ty eq pr id stat
```

no Unique number (FNT ordinal) assigned to the file by the system when the file is created and retained by that file as long as it is in the system.

name File name.

cp Control point to which the file is assigned.

ty File type (an asterisk following the file type indicates a read-only file):

- CM Common file (limited support).
- IN Input file.
- FA Fast-attach file.
- LI Library file.
- LO Local file.
- PM Direct access permanent file.
- PR Print file.
- PT Primary file.
- PH Punch file.
- RO Rollout file.
- S1 Special file type 1.
- S2 Special file type 2.
- S3 Special file type 3.
- SY System file.
- TE Timed/event rollout file.

eq EST ordinal of the device on which the file resides.

pr Queue priority (for queue type files only).

id Numeric file identifier associated with the file or one of the following two-character status codes associated with a rolled-out file:

MG Waiting for MAGNET.

PF Waiting for permanent file.

RS Waiting for resources.

TE Timed/event rollout file.

UA Waiting for utility.

stat Status of the file; this field contains one of the following:

- The letters FL followed by the central memory field length/100g and the ECS field length/1000g. (ECS field length is not shown for timed-event rollout files.)
- A numeric status code for all files other than those in the input, rollout, print, or punch queues. The status code consists of up to four octal digits (bits numbered 0 through 11 from right to left, respectively) and is defined as follows:

Bit Position	Description
0	Set if file is not busy.
1	Set if last operation was a write.
2-3	If last operation was a read:
0	Incomplete.
1	End-of-record (EOR).
2	End-of-file (EOF).
3	End-of-information (EOI).
	If last operation was a write or position:
0	Incomplete.
1	Complete.
4-5	Not used.
6	Set if file has been written since attachment or creation.
7	Set if file has been written since opened.
8	Set if file has been opened.
9-10	Not used.
11	Set if labeled tape.

The H display can also be set to indicate only files of a certain file type. For example:

H,t.

t	Significance
A	All files.
C	Common files (limited support).
I	Input files.
L	Local files.
O	Output files.

t	Significance
P	Punch files.
R	Rollout files.
T	Timed/event rollout files.
n	Control-point number.

Entering H,L for all local files followed by H,15. displays all local files for control point 15. Entering H,0. (zero) restores the display for all local files. To return to the main FNT display, enter H,0. (zero), then H,A.

Figure 4-13 illustrates the file name table (H) display.

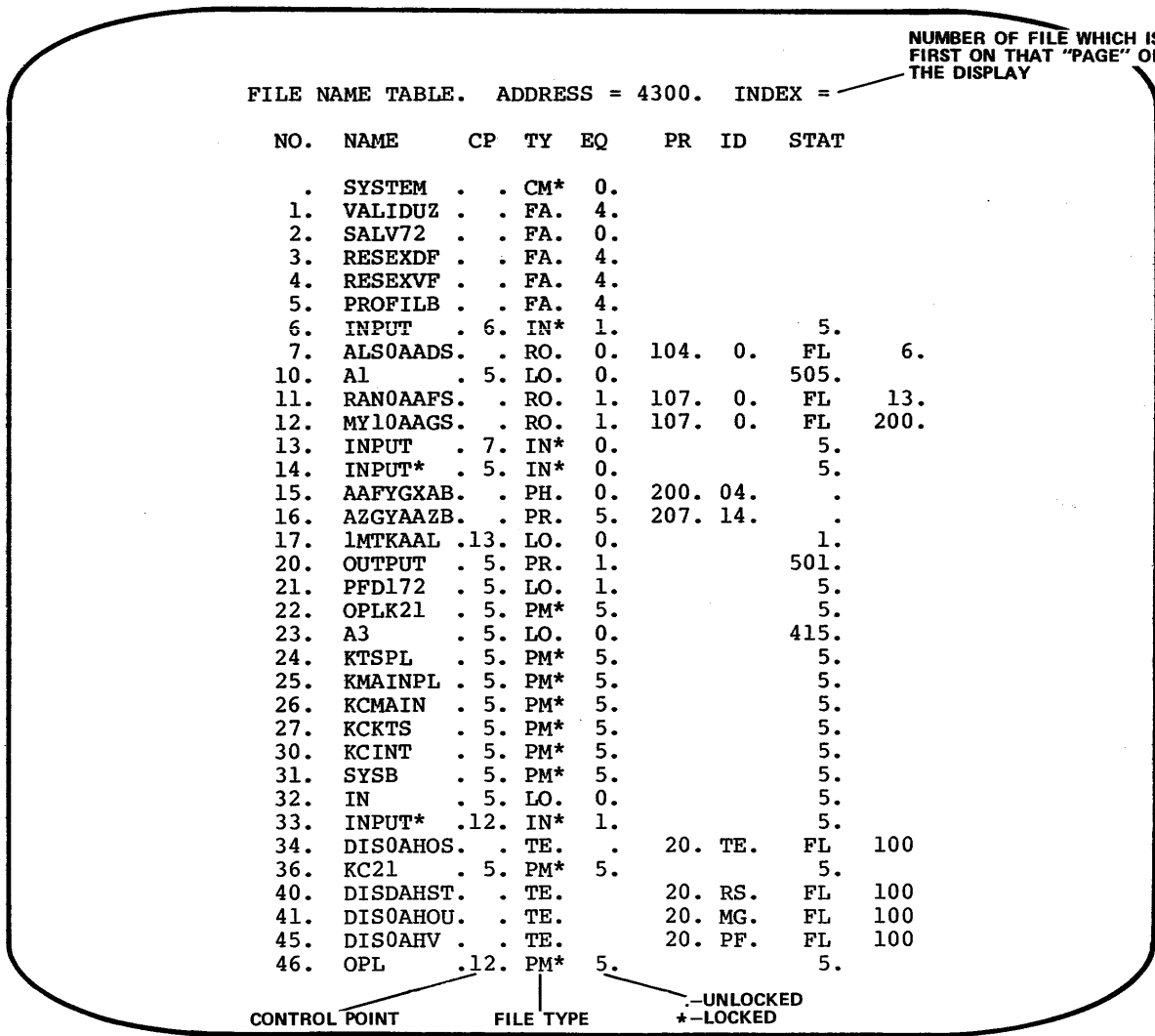

Figure 4-13. File Name Table (H) Display

BATCHIO (I) DISPLAY

The BATCHIO display shows the status of BATCHIO unit record devices. Each entry is in the following format.

jobname	eq	id	ret	forms	status
jobname					System job name (name of job using the device).
eq					Peripheral equipment (mnemonic and EST ordinal); for example: CR11 Card reader. CP12 Card punch. LP20 Line printer.
id					Refer to the EST display description for a list of all equipment mnemonics.
ret					Equipment ID.
ret					Repeat count (refer to the REPEAT command in section 3).
forms					Two-character alphanumeric forms code assigned to the line printer or card punch.
status					Equipment status (for example, NOT READY; NOT READY status could be caused by pressing the STOP button).

At the BATCHIO control point (B display), a message appears whenever a device is active. The message appears as:

```
n  BUFFERS ACTIVE
      n  Number of buffers in use by BATCHIO.
```

Figure 4-14 illustrates the BATCHIO status (I) display.

CONTROL POINT STATUS (J) DISPLAY

The J display shows the status of control points. The current buffer of control statements for a job are

displayed, allowing you to anticipate future job requirements. The next control statement to be processed is intensified. The J display shows control point parameters: control point number, job name, account block SRU limit, accumulated SRUs (an approximation), CPU status, contents of P register, central memory reference address and field length, ECS reference address and field length (if any), and the equipment assigned to the control point.

Figure 4-15 illustrates the control point status (J) display.

CENTRAL PROGRAMMABLE (K AND L) DISPLAYS

Using the K or L display, a job at a control point can place information on the console screen and receive information from the keyboard. The information entered is not executed by DSD, but is used by the job. Normally, these displays are used for utility programs, such as REDEFINE and FLAW (refer to section 6).

The job first issues a request message on the B display, asking you to bring up the K or L display.

Type

K,n. or L,n.

n Control point number of the requesting job.

When the display is assigned to control point n, the type-in (K, followed by data) is transferred to a specified area of the job field length when the carriage return terminates the type-in. If more than 50 characters are entered as data, the message

LINE TOO LONG.

appears on the screen. DSD does not accept the entry until the data string is shortened.

Both the K and L displays are control point oriented. That is, to page forward or backward through the display for each control point, use the + and - keys, respectively. The number of the control point appears at the top of the display next to the display letter designator (for example, K5).

BATCHIO STATUS.

JOB	EQ	ID	RCT	FORMS	STATUS
IDLE	.CR11.	.	.	.	NOT READY
IDLE	.CP12.	.	.	.	
ZZZZ03	.LP20.	.	.	AA.	
IDLE	.LP21.	04	.	.	
IDLE	.LP22.	.	.	.	

Figure 4-14. BATCHIO Status (I) Display

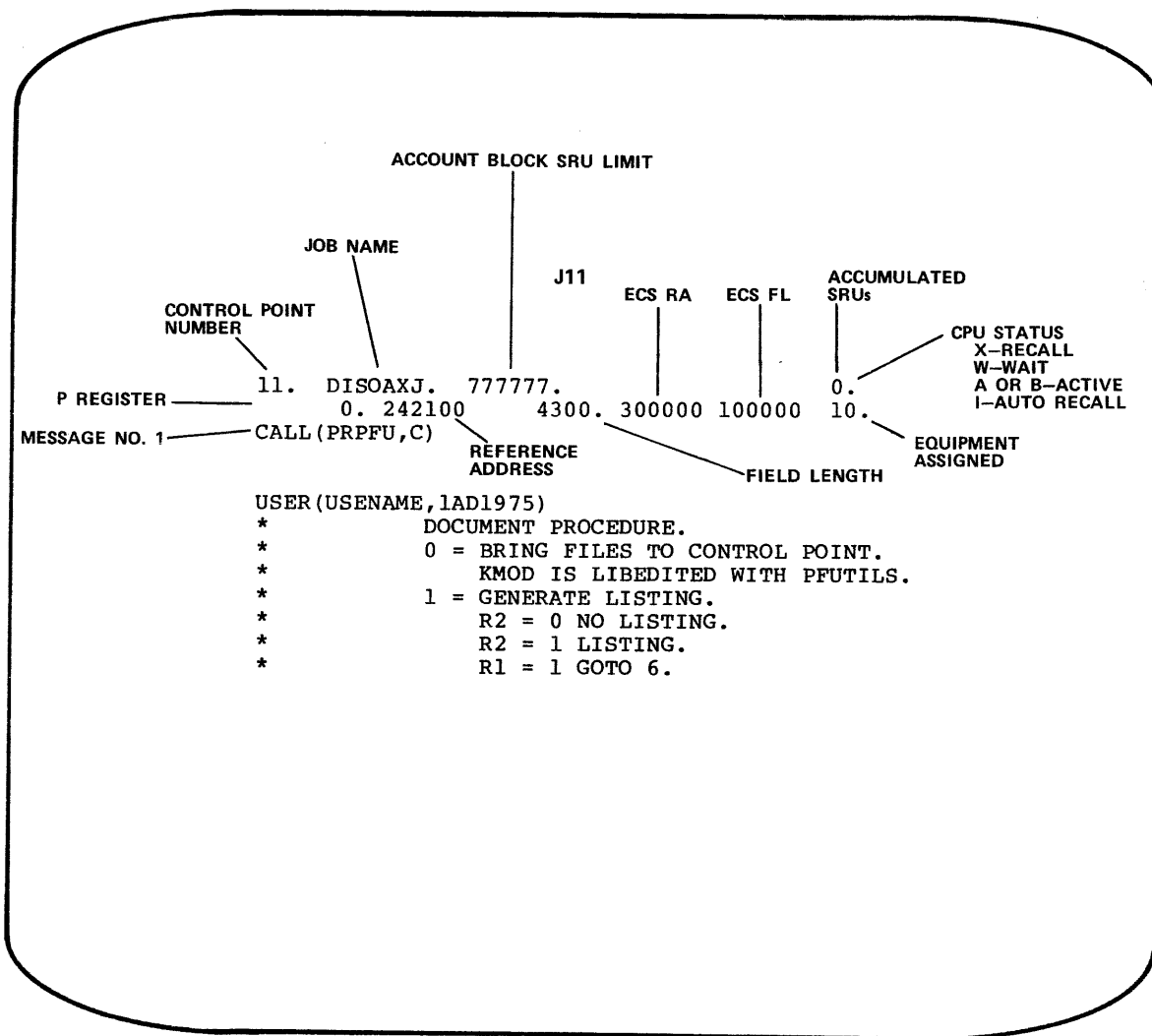

Figure 4-15. Control Point Status (J) Display

FILE (N) DISPLAY

To display a file on the left screen, type

DISPLAY,fnt.

fnt FNT ordinal (refer to the H display).

The file is displayed on the N display. Any subsequent commands

Ny. or yN.

y Legal display letter.

cause the last file selected via the DISPLAY command to be displayed. At the top of the display is the file name, the control point to which the file is attached, and the file status (blank, EOR, and EOF). To page through the file, use the + and - keys. DSD displays approximately 40g central memory words of the file at a time.

The data being displayed is contained in the last 40g words of the system control point area. In addition, words 76g and 77g of the system control point area contain file status and disk linkage information, respectively.

TRANSACTION STATUS (O) DISPLAYS

The O display gives the status of the task library directory, transaction terminals, or subcontrol points depending on the command entered.

Command	Display
O,TA.	Task library directories.
O,TR.	Transaction terminal status.
O,SU.	Subcontrol point status.

When the transaction subsystem has no transactions active or is rolled out, the words

SUBSYSTEM INACTIVE

appear in the upper-right corner of each display. The rest of the display is blank.

TASK LIBRARY DIRECTORIES (O,TA.) DISPLAY

The task library directories display provides information on each task within a library directory. The system task library directory, TASKLIB, is shown first by default. Each individual task library directory, xxTASKL, is displayed by paging through the display with the + (plus) key. Each entry appears in the following format:

no	name	times called	times loaded	fl	status
no					Line number on display.
	name				Task name.

† This field is zero for time-sharing terminals under TAF interfacing with TELEX and blank under TAF interfacing with NAM.

†† This field is zero for time-sharing terminals under TAF interfacing with TELEX and pn is the connection number under TAF interfacing with NAM.

times called	Number of times task was requested.
times loaded	Number of times task was loaded into memory.
fl	Field length.
status	Additional task information. Presence of a letter in a line indicates it applies to the corresponding task.
	S System privileges.
	R Reusable (disk resident).
	C Memory resident.
	E ECS resident.
	O ON/OFF (presence of O indicates task OFF).
	X Not used.

Figure 4-16 illustrates a task library directories display.

TRANSACTION TERMINAL STATUS (O,TR.) DISPLAY

The transaction terminal status display provides information about each active terminal. The number preceding TERMINALS in the title line indicates the number of transaction terminal lines currently in use. Each entry is in the following format.

no	name	db	rs	us	userarg	ch	e	pn	count
no									Line number on display.
	name								Terminal name.
	db								Data base (two-character name).
	rs								Read security (0 to 7).
	us								Update security (0 to 7).
	userarg								User-accessible argument area.
	ch								Channel of multiplexer. †
	e								Equipment number. †
	pn								Port number. ††
	count								Number of transactions submitted.

Figure 4-17 illustrates the transaction terminal status display.

TASK LIBRARY DIRECTORIES.

ADDRESS = 3400

NO.	NAME	TIMES CALLED	TIMES LOADED	FL	S	R	C	E	O	X
1.	AITASK	0	0	400	-	-	-	-	-	-
2.	ITASK	2	0	600	-	-	C	-	-	-
3.	TESTI	0	0	7700	-	R	-	-	-	-
4.	DMTASK	4	4	1200	-	-	-	-	-	-

Figure 4-16. Task Library Directories (O,TA.) Display

TRANSACTION TERMINAL STATUS 2. TERMINALS

NO.	NAME	DB	RS	US	USERARG	CH	E	PN	COUNT
1.	C02001A	SY	5	5	00000000	1	7	5	4
2	NX00012	MA	1	1	00000003	2	5	1	0

Figure 4-17. Transaction Terminal Status (O,TR.) Display

SUBCONTROL POINT STATUS (O,SU.) DISPLAY

The subcontrol point status display lists subcontrol points, tasks which are currently active at specific subcontrol points, and information about those tasks. Each entry is in the following format.

cp name ra fl a
cp Subcontrol point number.
name Task name if active; NEXT if inactive.
ra Reference address.
fl Field length.
a Number of requests queued if active.

Figure 4-18 illustrates the subcontrol point status display.

PP COMMUNICATIONS AREA (P) DISPLAY

The P display shows the first three words of each peripheral processor's communication area.

Line 1 Input register; normally contains the first three characters of the program name. The fourth character is the control point. This is followed by the input parameters (FET address, function call, and so forth).

Line 2 Output register; one of the system requests (RCHM, SFBM, and so forth).

Line 3 First word of message buffer; the first 10 characters of the last message issued.

The name of the current monitor function being issued by a peripheral processor is displayed to the left of its output register. Normally, this display is used by system programmers for debugging purposes. To page forward or backward through the display, use the + and - keys, respectively. This is effective only for 20-PP systems. In this case, two pages are required; the first page contains PP0 through PP11 octal and the second page contains PP20 through PP31 octal. For CYBER 170 Series mainframes, this display also includes the P address for each PP.

Figure 4-19 illustrates the PP communications area (P) display for a CYBER 170 machine.

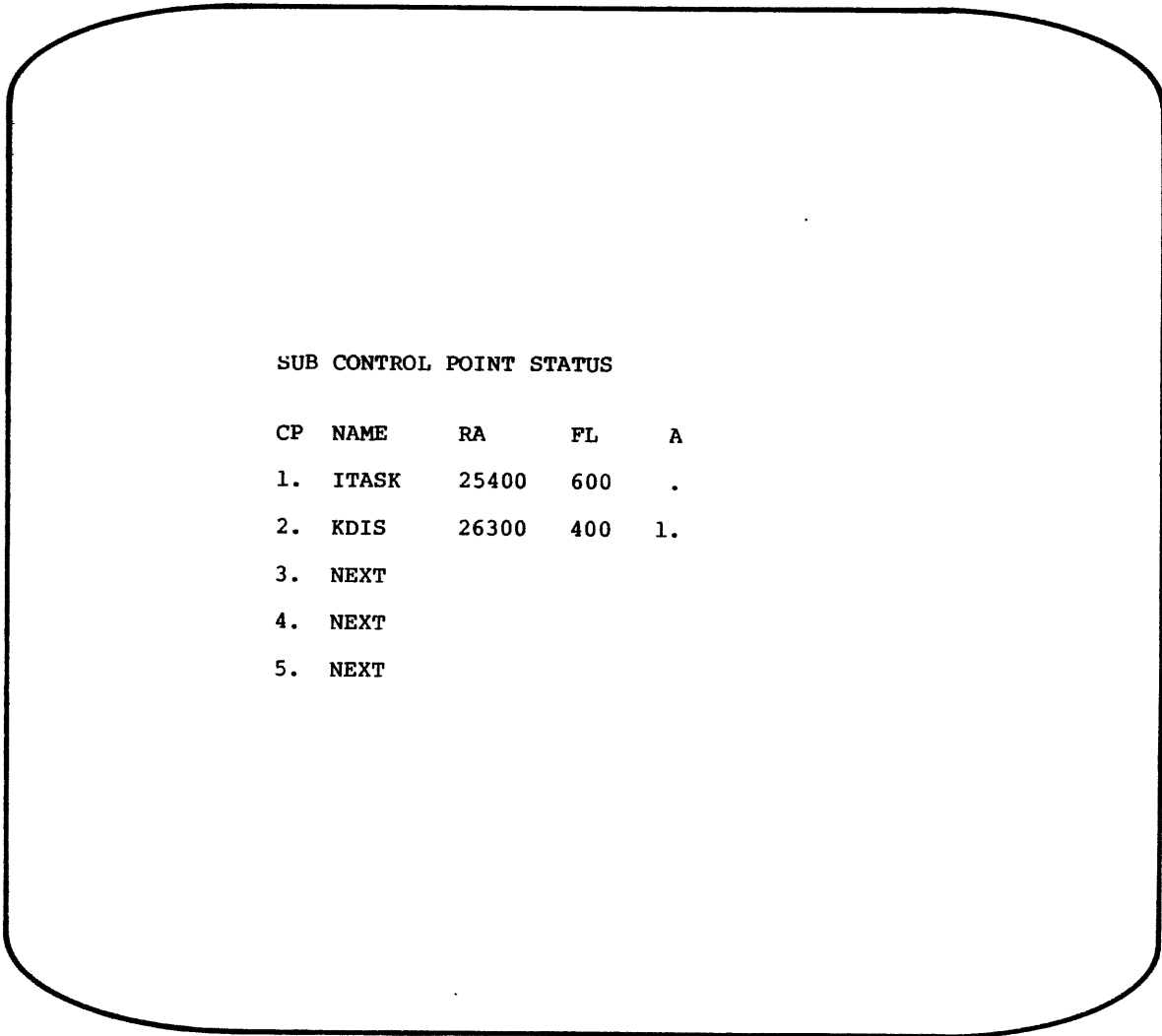

Figure 4-18. Subcontrol Point Status (O,SU.) Display

P

						DISPLAY CODE EQUIVALENT	PROGRAM ADDRESS
PP REGISTERS. ADDRESS = 6200.							
0.	MTR.	1524	2225	0000	0000	0000	MTRU P = 1351
		0000	0000	0000	0000	0000	
		2111	2310	0000	0003	0171	QISH CA
1.	DSD.	0423	0430	0000	0000	0000	DSDX P = 6766
		0000	6260	0000	0000	0000	
		3404	1430	0010	0044	0120	1DLX H 9AP
2.		0000	0000	0000	0000	6300	P = 112
		0000	0000	0000	0000	0000	
		0000	0000	0000	0000	0000	
3.		0000	0000	0000	0000	6310	H P = 112
		0000	0000	0000	0000	0000	
		0000	0000	0000	0000	0000	
4.		0000	0000	0000	0000	6260	P = 113
		0000	0000	0000	0000	0000	
		0000	0001	5400	0000	0000	A=
5.		0000	0000	0000	0000	6220	P P = 113
		0000	0000	0000	0000	0000	
		0301	2401	1417	0756	2401	CATALOG.TA
6.		0000	0000	0000	0000	6230	X P = 112
		0000	0000	0000	0000	0000	
		0000	0001	5400	0003	0001	A= C A
7.	ITD.	3424	0441	0000	0000	0000	1TD6 P = 1473
		0000	0000	0000	0000	4000	
		0000	0055	0000	0002	0001	5
10.		0000	0000	0000	0000	0000	B A P = 113
		0000	0000	0000	0000	0000	
		0000	0000	0000	0000	0000	
11.		0000	0000	0000	0000	6250	/ P = 113
		0000	0000	0000	0000	0000	
		0000	0001	5400	0003	0001	A= C A

CONTENTS OF COMMUNICATIONS
AREA FOR EACH PP

Figure 4-19. PP Communications Area (P) Display for a CYBER 170

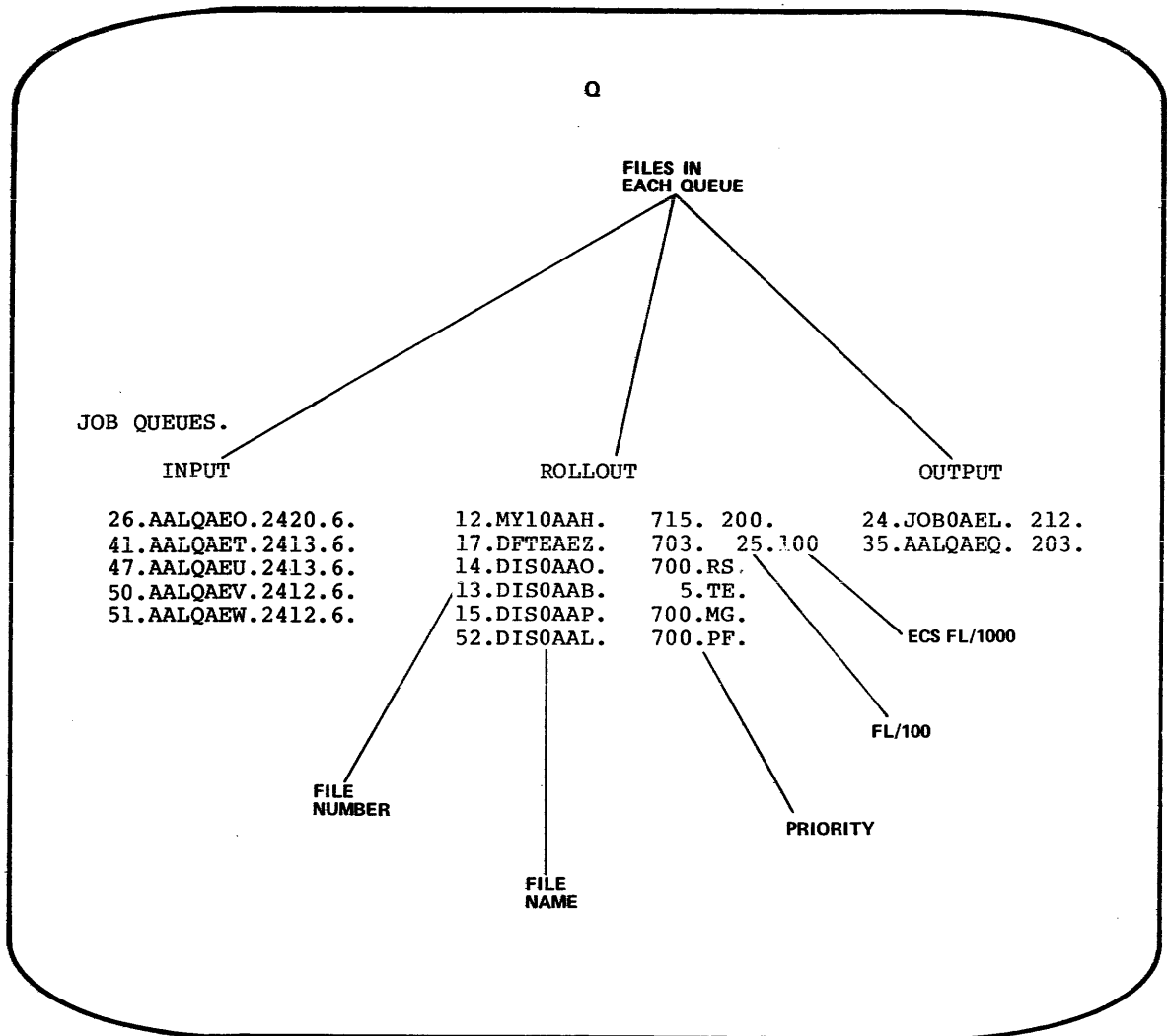

Figure 4-20. Active Job Queues (Q) Display

R

EXPORT STATUS. USER COUNT = 12. ACTIVE USERS = 3.

LINE	LOGIN	USER	READ	PRINT	JOBS IN	JOBS OUT
1.	17.00	WA12345	NOT READY	SUSPENDED	36.	34.
4.	10.02	WTOUZEL	AJPIAJB	AJPIAJA	2.	1.
11.	05.22	LOGIN	IDLE	IDLE	1.	1.

Figure 4-21. Export/Import Status (R) Display

SYSTEM CONTROL INFORMATION (S) DISPLAY

The S display shows the parameters used to control job flow for the various origin types and class. For each origin type or class, queue priorities and service limits are shown. Each field in the entry is described as follows:

jobtype	Job origin type/class:
	SY System.
	BC Local batch.
	TX Time-sharing.
	EI Remote batch.
	MT Multiterminal.
	NS Network supervisor.

Queue priorities:

queue	Queue type; one of each of the following for each job type:
	IN Input.
	RO Rollout.
	OT Output.
op	Original priority (priority at which job is initially set in the queue).
lp	Lowest priority at which a job can be entered and aged.
up	Highest priority a job can reach in the queue; aging stops when this priority is reached. (Job is also given this priority when initially assigned to central memory.)
in	Interval at which jobs are aged while in the queue.

Service limits:

pr	CPU priority.
cp	CPU time slice (milliseconds * 100 octal).
cm	Central memory time slice (seconds).
ec	Maximum ECS field length/1000 octal for any individual job of the origin type.
nj	Maximum number of jobs.
fl	Maximum field length/100 octal for any individual job of the origin type.
am	Maximum field length/100 octal for all jobs of the origin type.
em	Maximum ECS field length/1000 octal for all jobs of the origin type.

ds†	Size in PRUs allowed for individual direct access permanent files.
fc†	Number of permanent files allowed.
cs†	Cumulative size in PRUs allowed for all indirect access permanent files.
fs†	Size in PRUs allowed for individual indirect access permanent files.

Refer to the QUEUE and SERVICE commands in section 3 for further information about these parameters.

At the bottom of the display are five entries controlling the time or delay in system operations. These are installation parameters used to control system operation.

JS	Job scheduler delay interval (seconds).
CR	CPU program recall (milliseconds).
AR	PP auto recall (milliseconds).
JA	Job advance (milliseconds).
CS	CPU switch (milliseconds).

The system status (control) word and the system interlock word are displayed at the bottom of the S display, each in five groups of four octal digits. The display code equivalent is shown at the right of each word. The following bits may be set in the control word. (The commands that can be used to change these conditions are described in section 3.)

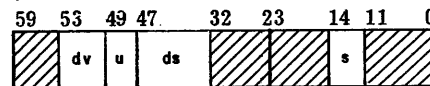

dv Disable ECS/validation:

Bit Set	Significance
53	Disable user ECS.
52	Disable PF validation.
51-50	Disable MS validation.

u User number verification:

Bit Set	Significance
49	Ignore USER statement; allows job to be run without a USER statement. Accepts the statement if it is there, but one is not required.
48	Disable validation; allows jobs to run with no VALIDUS file. The USER statement is ignored even if present.

† The entry in this field is not the actual value but an index to a table of values. Refer to the SERVICE command in section 3 and find the parameter which corresponds to the S-display field (such as, the FCx parameter for the FC field). The table in the parameter description shows the actual value. If the default value is used, the entry does not appear in the display.

ds Disable subsystem:

Bit Set	Significance
47	Disable BATCHIO subsystem.
46	Disable time-sharing subsystem.
45	Disable Export/Import subsystem.
44	Disable MAGNET.
43	Reserved.
42	Disable removable device checking.
41	Disable protected queues.
40	Disable secondary USER statements.
39	Disable system control point (SCP) facility.
38	Disable TAF.
37	Disable NAM.
36	Disable RBF.
35	Disable subcontrol points.
34	Disable MCS.
33	Disable CDCS.

s Console/system modification status:

Bit Set	Significance
14	System is in engineering mode.
13	Console is locked.
12	System is in debug mode.

The following bits may be set in the interlock word.

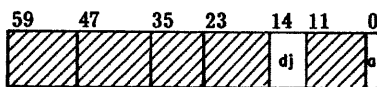

dj Disable job flow parameters:

Bit Set	Significance
14	Disable priority aging.
13	Disable job scheduler.
12	Disable auto roll.

a Abort interlock.

Bit Set	Significance
0	Subsystem abort interlock is set.

Figure 4-22 illustrates the system control information (S) display.

TIME - SHARING STATUS (T) DISPLAY

The T display shows the status of time-sharing terminals. A header line contains the number of successful logins since the time-sharing subsystem was activated; it also contains the number of currently active users as well as those who are logging in. Each entry is in the following format.

type	line	userno	status	lastop	system
Type of connection:					
			NAM	Network terminal.	
			MUX	TELEX terminal.	
Line number on which the user is logged in. Ports 0 to 3 are reserved. (Port 4 is physical port 0 on the first multiplexer used.†)					
User number.					
Mode of terminal operation:					
			E	User job currently in execution.	
			C	Time-sharing subsystem waiting for commands to direct job processing.	
			I	User job is waiting for input.	
			O	User job is transmitting output.	
			R	Job in execution has been rolled out and is waiting to be rolled back in.	
			T	User job has reached completion and has terminated.	
Last time-sharing command entered.					
Subsystem currently being used:					

ACC	Access.
BAS	BASIC.
BAT	Batch.
EXE	Execute.
FOR	Time-Sharing FORTRAN Version 5.
FTN	Time-Sharing FORTRAN Extended Version 4.
NUL	None.
TRAN†	Transaction subsystem.

The word WARN following the subsystem entry indicates that the terminal has not received the current warning message (refer to WARN,ccc...ccc. command in section 3).

Figure 4-23 illustrates the time-sharing status (T) display.

† Not applicable to IAF.

SYSTEM CONTROL INFORMATION.

JOB TYPE	QUEUE	PRIORITIES			IN	SERVICE LIMITS			EC/EM
		OP	LP	UP		PR/NJ	CP/FL	CM/AM	
SY.	IN.	6600.	700.	3000.	1.	1.	100.	20.	7777.
	RO.	6000.	100.	1000.	1.	7777.	7777.	7777.	7777.
	OT.	400.	100.	7700.	1.				
BC.	IN.	2400.	2000.	4010.	1.	30.	400.	200.	7777.
	RO.	2400.	1010.	4004.	1.	7777.	7777.	7777.	7777.
	OT.	200.	100.	7000.	1.	DS 3.	FC .	CS . FS	
EI.	IN.	3400.	2400.	4010.	1.	30.	400.	200.	7777.
	RO.	3400.	1400.	4006.	1.	7777.	7777.	7777.	7777.
	OT.	200.	100.	7600.	1.				
TX.	IN.	4000.	3770.	7006.	1.	30.	400.	10.	7777.
	RO.	4004.	3740.	7000.	1.	7777.	7777.	7777.	7777.
	OT.	200.	100.	7000.	1.				
MT.	IN.	6774.	6700.	7400.	1.	31.	400.	60.	7777.
	RO.	6774.	4000.	7400.	1.	7777.	7777.	7777.	7777.
	OT.	6000.	100.	7700.	1.				
NS.	IN.	7374.	7360.	7500.	1.	73.	400.	200.	7777.
	RO.	7374.	7350.	7500.	1.	7777.	7777.	7777.	7777.
	OT.	500.	100.	7700.	1.				

DELAYS.

JS	CR	AR	JA	CS
1.	10.	1000.	10.	10.

CONTROL 0001 1200 0000 0002 0000 AJ B
 INTERLK 0000 0000 0000 0000 0000

Figure 4-22. System Control Information (S) Display

T

```
TIMESHARING STATUS.  USER COUNT = 5.  ACTIVE USERS = 3.  
TYPE  LINE  USER NO.  STATUS  LAST OP.  SYSTEM  
NAM    5.  USER123.  O.    CATLIST.  BAS.  
NAM   12.  USER456.  C.    LNH      .  EXE. WARN.  
NAM   40.  USER789.  C.    RNH      .  BAS.
```

Figure 4-23. Time-Sharing Status (T) Display

MONITOR FUNCTION (Y) DISPLAY

The Y display lists all monitor function mnemonics and their respective codes. Codes 1 through 35 represent PP monitor functions; codes 36 through 77 represent CPU monitor functions. Figure 4-24 illustrates the Y display.

DIRECTORY (Z) DISPLAY

The Z display lists all the displays available under DSD control. Figure 4-25 illustrates the directory (Z) display.

MONITOR FUNCTIONS.			
	1.	CEFM	35.
	2.	DCPM	36.
CCHM	3.	SFIM	37.
DCHM	4.	DTKM	40.
DEQM	5.	DPPM	41.
CDBM	6.	ECSM	42.
	7.	RCLM	43.
SEQM	10.	RCPM	44.
PRLM	11.	RDCM	45.
RCHM	12.	IAUM	46.
REMM	13.	ACTM	47.
REQM	14.	RPPM	50.
EATM	15.	RSJM	51.
DSWM	16.	RTCM	52.
RJSM	17.	SFBM	53.
	20.	STBM	54.
RSTM	21.	UADM	55.
	22.	SPLM	56.
DSRM	23.	JACM	57.
ECXM	24.	DLKM	60.
TGPM	25.	TDAM	61.
TSEM	26.	TIOM	62.
DEPM	27.	RLMM	63.
DRCM	30.	LCEM	64.
RECM	31.	CSTM	65.
ROCM	32.	CKSM	66.
ABTM	33.	LDAM	67.
CCAM	34.	VMSM	70.
		PIOM	71.
		SJCM	72.
		PLFM	73.
		VFPM	74.
		DFMM	75.
		BFMM	76.

Figure 4-24. Monitor Functions (Y) Display

Z

DIRECTORY.

A DAYFILES.
B SYSTEM STATUS.
C,D CENTRAL MEMORY, 5 GROUPS OF 4.
E EQUIPMENT STATUS TABLES.
OPTIONS - A, C, M, P, T.
F,G CENTRAL MEMORY, 4 GROUPS OF 5.
H FILE NAME TABLE.
I BATCHIO STATUS.
J JOB DISPLAY.
K,L CENTRAL PROGRAM DISPLAY BUFFER.
M ECS MEMORY.
N FILE DISPLAY.
O TRANSACTION STATUS.
P PP STATUS.
Q INPUT/OUTPUT/ROLLOUT QUEUES.
R REMOTE BATCH STATUS.
S SYSTEM CONTROL INFORMATION.
T TIME SHARING STATUS.
Y MONITOR FUNCTION TABLE.

DISPLAY NAME

Figure 4-25. Directory (Z) Display

OPERATION UNDER DIS CONTROL

DIS displays information of a single job assigned to a control point. Under DIS, the B display shows the exchange package area for the job. Central memory addresses relative to the job's reference address are used for the data and program displays.

Bring DIS to a control point to monitor the progress of a job with any of the following methods.

- Control statement in the form DIS (job must be system origin or have system origin privileges).
- Operator call to DIS by typing n.DIS. for the job active at control point n.
- Operator call to DIS by typing X.DIS,fl. (fl=field length desired) or X.DIS. (field length of 60 000 octal assumed by default). This brings DIS to an empty control point to initiate utility programs.

When DIS is controlling the console, use the * key to alternate the display between DSD and DIS. DIS permanently returns control to DSD when DROP. is typed; the job is not dropped unless no control statements remain.

When DIS is called to a control point, automatic control statement processing stops and the A and B displays for DIS appear on the left and right display screens, respectively. Keyboard entry is necessary to begin processing of subsequent control statements. Unless automatic control statement processing is reenabled, the job is stopped after each control statement is processed. That is, only one control statement can be processed at a time. Under DIS, the B display shows only the condition of the control point to which it is assigned, including upcoming control statements. When the job is not using the central processor, a copy of its exchange package is displayed. Displays available under DIS are selected in the same manner as DSD displays. The PRESENTATION CONTROL switch on the CYBER 170 Series console enables you to display a left screen display only (switch in LEFT position), a right screen display only (switch in RIGHT position), or both left and right displays on a split screen (switch in MAINTENANCE position). Refer to section 1 for further information on the PRESENTATION CONTROL switch and Console Operation in this section for information concerning display selection commands and DIS keyboard entries.

The displays available under DIS are:

<u>Display</u>	<u>Description</u>
A	Dayfile messages and files attached to the control point.

<u>Display</u>	<u>Description</u>
B	Job status, control statements, and the exchange package.
C,D	Data storage: contents of 32 central memory words (four selectable eight-word groups) in five columns of four octal digits with display code equivalents (same as DSD C and D displays).
F	Data storage: contents of 32 central memory words (four selectable eight-word groups) in four columns of five octal digits with display code equivalents.
G	Program storage: contents of 32 central memory words (four selectable eight-word groups) in four columns of five octal digits with COMPASS instruction equivalents.
H	Control point file name table: all files assigned to control point as well as equipment assigned to files.
M	ECS storage: contents of 32 60-bit words of ECS memory (four selectable eight-word groups) in five columns of four octal digits with display code equivalents (same as DSD M display).
N	Blank screen.
T,U	Text display; displays text from central memory in coded lines (up to 60 characters per line). The T display terminates after 240 words have been displayed; the U display terminates after 300 words have been displayed.
V	Central memory buffer; displays directly from central memory. The display terminates after 512 words have been displayed.
Y	Monitor functions; displays mnemonics and the values of all monitor functions (same as the DSD Y display).
Z	Directory of DIS displays available.

NOTE

Although all displays listed may appear on the left screen, only the B, C, D, N, T, and U displays may appear on the right screen. If you attempt to bring any other display to the right screen, the message ILLEGAL CONTROL CARD is issued to the job dayfile and is displayed in the message buffer of the B display.

DIS DAYFILE (A) DISPLAY

Figure 5-1 illustrates the DIS dayfile display. The figure shows the dayfile messages for the control point to which DIS is currently assigned and as many files attached to that control point as will fit in the display. All files attached to the control point can be observed via the file name table (H) display. The header information illustrated in figure 5-1 appears on all left screen DIS displays.

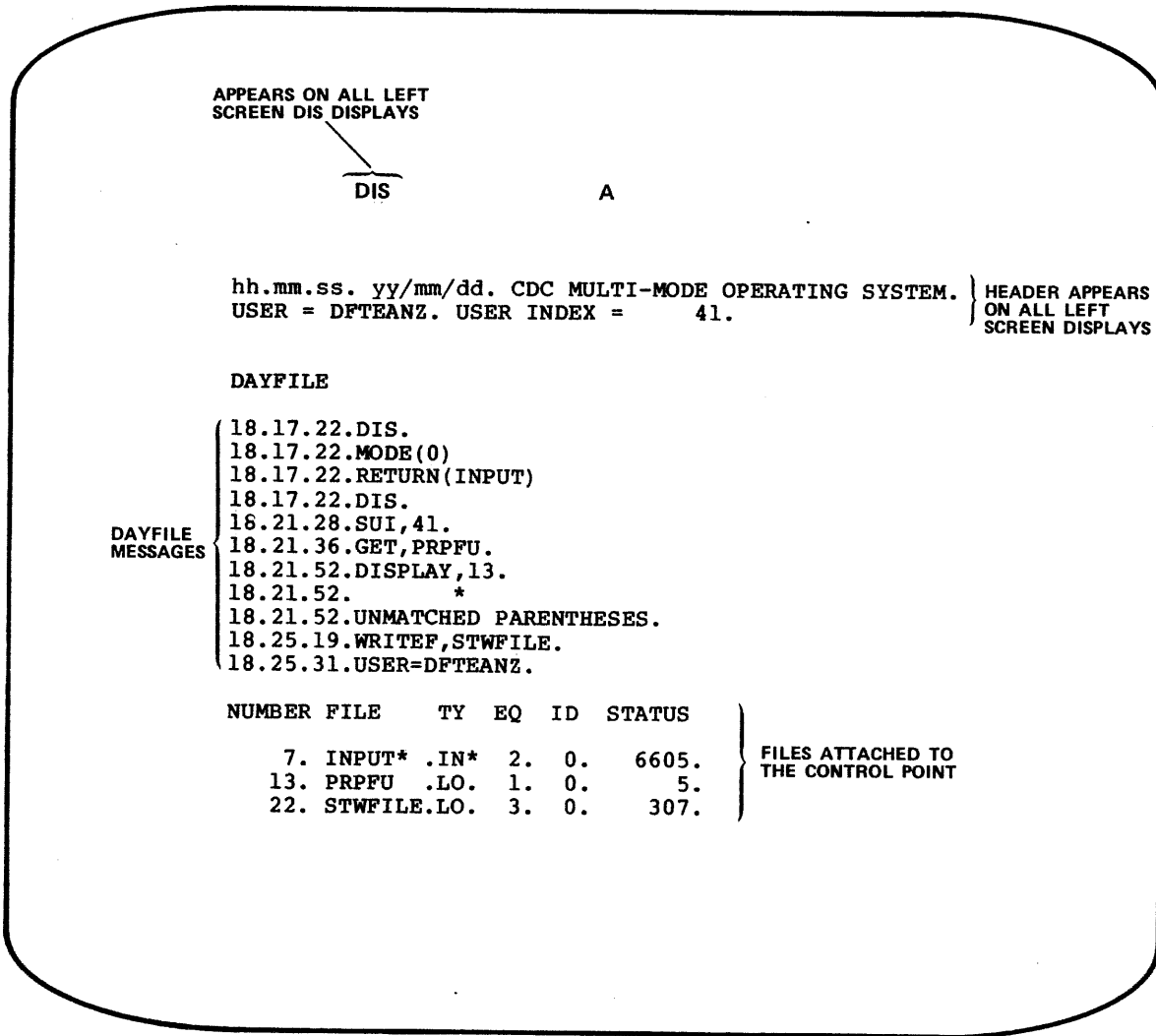
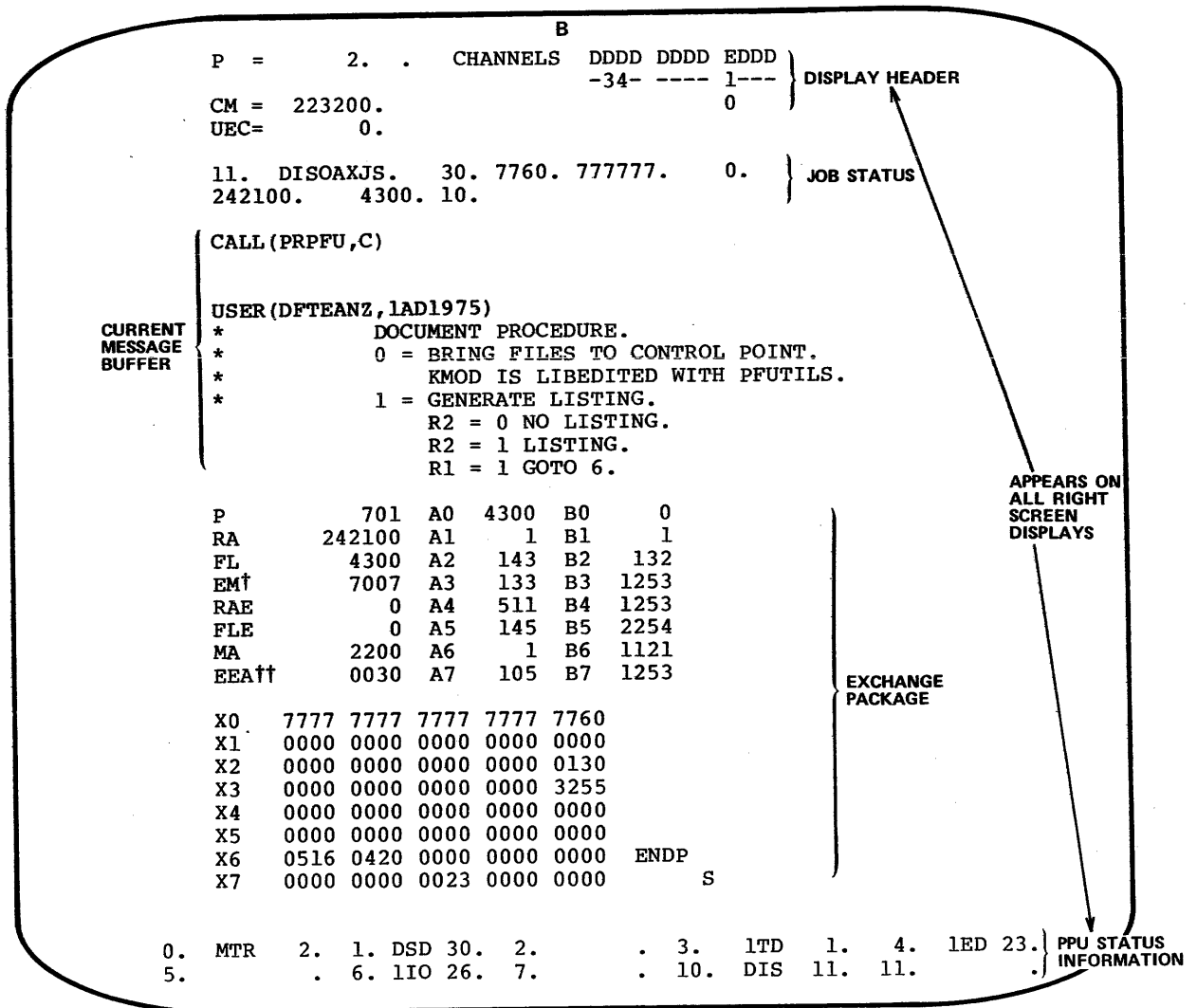

Figure 5-1. DIS Dayfile (A) Display

DIS JOB STATUS (B) DISPLAY

Figure 5-2 illustrates the DIS job status display. The figure shows the job status, current message buffer, job control statements, and exchange package. The job status is a two-line entry in which the first line identifies the control point to which the job is assigned (11), the job name (DISOAXJS), CPU priority (30), queue priority (7760), account block SRU limit (777777), accumulated SRUs (an approximation), and the CPU status. The second line of job status contains the central memory reference address (RA=242100), the job's field length (4300), the ECS reference address (blank), the job's ECS field length (blank), and assigned equipment (10 - the display console). ECS field length is shown only if central memory field length is equal to or greater than 10 000.

Although this figure shows the B display on the right console screen, it may also be displayed on the left screen. The header information illustrated in figure 5-2 appears on all right screen displays. In addition, at the bottom of the right screen displays, each PP is represented by an entry for the program currently running and the control point to which the program is assigned (PP status information in figure). PP0 and PP1 are dedicated to monitor (MTR) and DSD, respectively. The header and PP status information for DIS right screen displays is identical to that displayed for DSD right screen displays (refer to the description of DSD B display in section 4 for complete information).



† For a CYBER 170 Model 176 machine, PSD appears in place of EM.
 †† The EEA entry appears only for a CYBER 170 Model 176 machine.

Figure 5-2. DIS Job Status (B) Display

DIS MEMORY DISPLAYS

Figure 5-3 illustrates the DIS data storage (F) display. The contents of each central memory word is displayed in four columns of five octal digits along with the display code equivalent. Refer to figure 4-5 in section 4 for an illustration of the DSD C/D displays (same as DIS C/D displays).

Figure 5-4 illustrates the DIS program storage (G) display. The G display shows the contents of central memory and the COMPASS mnemonic translation.

DIS	F				
hh.mm.ss. yy/mm/dd. CDC MULTI-MODE OPERATING SYSTEM.					
USER =	. USER INDEX =				0.
000100	00000	00000	00000	00000	
000101	03171	51505	16240	00226	COMMENT BV
000102	15170	40500	00000	00117	MODE AO
000103	16170	53011	24000	00126	NOEXIT AV
000104	17160	53011	24000	00133	ONEXIT AO
000105	17162	32700	00000	00134	ONSW AI
000106	17060	62327	00000	00156	OFFSW A,
000107	22061	40000	00000	00157	RFL A.
000110	22171	41417	25240	00166	ROLLOUT A
000111	23052	42022	00000	00171	SETPR A
000112	23052	42414	00000	00200	SETTL A
000113	23251	10000	00000	00210	SUI BH
000114	23271	12403	10000	00134	SWITCH AI
000115	25230	50320	25000	00217	USECPU BO
000116	22061	45400	00000	00314	RFL= CL
000117	51200	00064	61100	00001	(P H A
000120	73720	66700	51500	00002	F (/ B
000121	03070	00230	01000	00252	CG BXA B)
000122	03140	00230	72767	77767	CL BX
000123	51000	00000	01230	00024	(AS T
000124	02132	32000	00000	00175	BKSP A
000125	03171	51517	16000	00202	COMMON BB
000126	04112	32017	23050	00227	DISPOSE BW
000127	05261	10324	00000	00352	EVICT C)
000130	14170	31300	00000	00357	LOCK C.
000131	17252	40000	00000	00364	OUT C
000132	22051	40501	23050	00371	RELEASE C
000133	22051	60115	05000	00406	RENAME DF
000134	22052	71116	04000	00425	REWIND DS
000135	22052	42522	16000	00416	RETURN DN
000136	23131	12005	11000	00444	SKIPEI D9
000137	23131	12006	00000	00451	SKIPF D(

Figure 5-3. DIS Data Storage (F) Display

DIS		G			
hh.mm.ss. yy/mm/dd. CDC MULTI-MODE OPERATING SYSTEM					
USER = . USER INDEX = 0.					
000100	00000	00000	00000	00000	PS PS
000101	03171	51505	16240	00226	NZ X BXX+-X PS
000102	15170	40500	00000	00117	BXX*-X FXX*X PS
000103	16170	53011	24000	00126	BXX+-X SAX+B NX XB PS
000104	17160	53011	24000	00133	BXX--X SAX+B NX XB PS
000105	17162	32700	00000	00134	BXX--X DXX+X PS
000106	17060	62327	00000	00156	BXX--X SBX+K PS
000107	22061	40000	00000	00157	LX XB FXX*X PS
000110	22171	41417	25240	00166	SX XB RXX*X ZX XB PS
000111	23052	42022	00000	00171	AX XB DXX*X PS
000112	23052	42414	00000	00200	AX XB DXX*X PS
000113	23251	10000	00000	00210	AX XB BX X PS
000114	23271	12403	10000	00134	AX XB BXX+X BX X PS
000115	25230	50320	25000	00217	ZX XB SAA+K PS
000116	22061	45400	00000	00314	LX XB RXX/X PS
000117	51200	00064	61100	00001	SAB+K SBB+K
000120	73720	66700	51500	00002	SXX+B SBB+B SAB+K
000121	03070	00230	01000	00252	ZR X RJ/RWE
000122	03140	00230	72767	77767	NZ X SXX+K
000123	51000	00000	01230	00024	SAB+K RJ/RWE
000124	02132	32000	00000	00175	JPB+K PS
000125	03171	51517	16000	00202	NZ X BXX+-X PS
000126	04112	32017	23050	00227	EQ BB AX XB PS
000127	05261	10324	00000	00352	NE BB PS
000130	14170	31300	00000	00357	BX -X FXX-X PS
000131	17252	40000	00000	00364	BXX--X FXX*X PS
000132	22051	40501	23050	00371	LX XB FXX*X AX XB PS
000133	22051	60115	05000	00406	LX XB SBA+K PS
000134	22052	71116	04000	00423	LX XB SXB+K PS
000135	22052	42522	16000	00416	LX XB DXX*X BXX+-X PS
000136	23131	12005	11000	00444	AX XB BXX+X BXX*X PS
000137	23131	12006	00000	00451	AX XB BXX+X PS
ADDRESS	MEMORY CONTENTS			COMPASS MNEMONIC TRANSLATION	

Figure 5-4. DIS Program Storage (G) Display

DIS DIRECTORY (Z) DISPLAY

Figure 5-5 illustrates the DIS directory display. The Z display lists all displays available under DIS control. If the

letter entered to select the left screen display is not a valid display identifier (E, I, J, K, L, O, P, Q, R, S, W, or X are valid), the Z display is selected automatically.

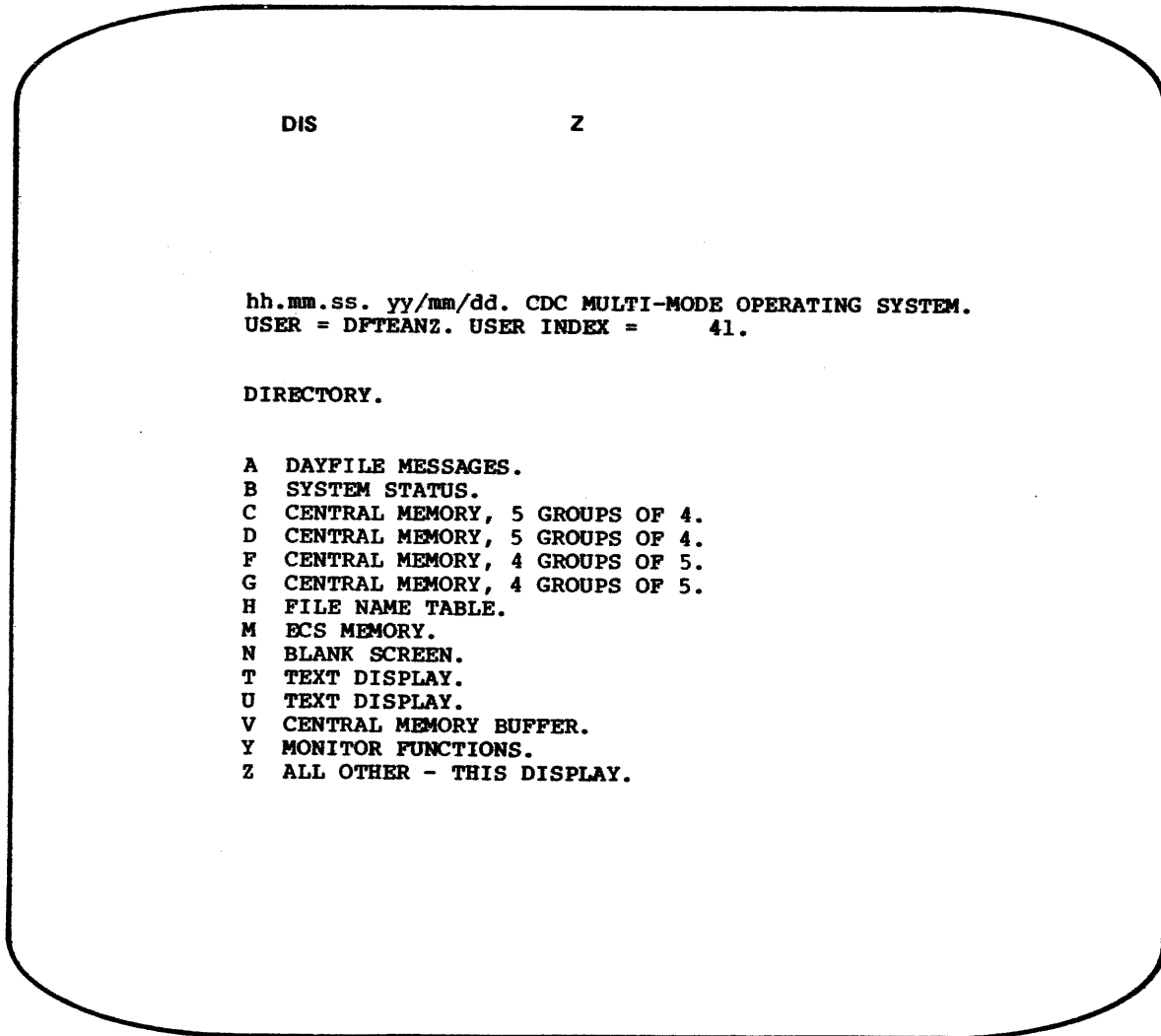

Figure 5-5. DIS Directory (Z) Display

CONSOLE OPERATION

Unlike DSD, DIS is not interpretive. You must complete every type-in and signal DIS to act upon the message by pressing CR. The following rules apply to all DIS commands.

- Spaces in an octal field are ignored, but can be inserted for readability.
- All octal fields are assembled right-justified with leading zero fill; excess octal digits are ignored.

In addition to the command entries, the following keys have special meaning to DIS when entered as the first character. The following paragraphs describe the action initiated when the key is activated.

*

If DSD has relinquished the main display console to DIS, * acts as a quick hold, and DIS drops the display channel so that DSD can use it.

=

CAUTION

Central memory changes made while in absolute mode[†] are placed in absolute core addresses.

Alternately selects relative or absolute mode for memory references made from the console keyboard (mode changes each time = key is pressed). There is no visual indication when relative mode is selected, and memory locations shown in the C, D, F, and G memory displays are relative to the reference address (RA) for the control point to which DIS is assigned. When absolute mode is in effect, the letters ABS appear at the top of the left screen next to the display identifier, and memory displays C, D, F, and G show absolute locations.

For example, 100,1,4000. is entered into core at RA+100 in relative mode and at central memory address 100 in absolute mode.

+

Advances by 40 octal locations the address of any of the following displays: C, D, F, G, M, T, U.

-

Decrements by 40 octal locations the address of any of the following displays: C, D, F, G, M, T, U.

(

Breakpoint program to (P+1).

)

Breakpoint program to (P-1).

/

Advances left screen memory display address by the value in the lower 18 bits of the first word displayed (applicable only to memory displays C, D, F, G, and M).

.

Set AUTO MODE (initiates automatic control statement processing). This key performs the same function as the RCS command described under DIS Keyboard Entries in this section.

8

Advances the pointer indicating the first address of managed tables for the left screen (applicable only to memory displays C, D, F, and G).

9

Decrements the pointer indicating the first address of managed tables for the left screen (applicable only to memory displays C, D, F, and G).

Right blank (display key)

Advances the left screen display sequence established by the SET,ssss...s. command (refer to Display Selection Commands).

CR (carriage return)

Sets the repeat entry flag; message REPEAT ENTRY is displayed on the error message line of the left screen. The subsequent command entry is processed but is not erased after completion. That command is processed each time the carriage return key is pressed. To clear the repeat entry mode, press the left blank (erase) key.

[†]The keyboard must be unlocked under DSD to make memory changes while in absolute mode (refer to the UNLOCK command in section 3).

The following keys are interpreted as control characters by DIS.

Left blank (erase)

Clears current DIS keyboard entry and any resultant error message; AUTO MODE (automatic control statement processing) is also cleared.

BKSP (backspace)

Deletes last character displayed and clears error message (if one exists).

CR (carriage return)

Initiates processing of an entered command.

The following keyboard messages may appear above the type-in.

ILLEGAL ENTRY.

Command cannot be processed.

REPEAT ENTRY.

Command in control statement buffer is repeated each time carriage return is pressed; cleared by left blank key.

OUT OF RANGE.

Memory entry address is greater than the field length.

SYSTEM BUSY - DISK.

DIS is waiting for an overlay to be loaded from a mass storage device.

SYSTEM BUSY - PPU.

DIS is waiting for a PP to be assigned in order to process a keyboard entry.

JOB ACTIVE.

Previous request not completed; command must be reentered when job is not active.

AUTO MODE.

Control statement buffer is read automatically. Automatic control statement processing can be selected by the RCS command or by pressing the . key.

DIRECT CPU INPUT.

N. command has been entered and all data entered from the keyboard is being passed directly to central memory.

DISPLAY SELECTION COMMANDS

Indicate the displays to be shown on the left and right screens on the console with the following commands. Follow the type-in with a carriage return.

xy.

Brings the x and y displays to the left and right screens, respectively. Note that although all DIS displays may appear on the left console screen, only the B, C, D, N, T, and U displays may appear on the right screen. If you attempt to bring any other display to the right screen, the message ILLEGAL CONTROL CARD is issued. In addition, if the letter entered to select the left screen display (x) is not a valid display identifier, the Z display is selected automatically.

xz,aaaaaa.

Brings specified memory display to the left screen, if not currently selected, and provides display modifications as follows:

x Display identifier (C, D, F, G, or M).

z Type of display modifications:

z=0-3 Changes the specified group to display the eight words beginning at location aaaaaa.

z=4 Changes the entire display so that all four eight-word groups are 32 contiguous locations beginning at location aaaaaa.

z=5 Advances the display by aaaaaa locations.

z=6 Decrements the display by aaaaaa locations.

aaaaaa Location parameter.

x,addr.

If x specifies one of the central memory displays (C, D, F, G, or M), addr is the address used to obtain the bias address for the managed table display. (The bias address is the lower 18 bits of the word at addr).

SET,ssss...s.

Sets the left screen display sequence; ssss...s consists of one to eight display identifiers. Pressing the right blank (display) key after this command is entered causes the first display to appear on the left console screen. Pressing the key again selects the second display. The next display in the specified sequence appears on the left screen each time the right blank key is pressed, for example, SET, ACFDH.

DIS KEYBOARD ENTRIES

If a job is currently active (CPU active, waiting, on recall, or PP active), many commands are not accepted; JOB ACTIVE is displayed.

BEGIN, pname, pfile.

Sets AUTO MODE and calls the CCL procedure pname that is on file pfile.

BKPA, addr.

Breakpoint to address addr in the program with assigned PPs. Central processor execution begins at the current value of P and stops when P=addr. PPs attached to the control point can still be active. DIS clears addr to stop the program at that point. The breakpoint may be cleared by setting the breakpoint address to a new value.

BKP, addr.

Breakpoint to address addr in the program. Central processor execution begins at current value of P and stops when P=addr, and DIS is the only PP active at the control point.

CALL, proc.

Sets AUTO MODE and calls KCL procedure proc.

DCP.

Drops the central processor and displays the exchange package area on the B display.

DIS.

Reloads main DIS overlay.

DROP.

Drops DIS, but normal processing of the job continues (it does not drop the job until all control statements are processed).

ELS, ccc...ccc.

Allows entry of control statement ccc...ccc after the last statement in the control statement buffer, if there is space.

ENAi, addr.

Sets register Ai=addr in the exchange package area.

ENBi, addr.

Sets register Bi=addr in the exchange package area.

ENEM, m.

Sets CPU program exit mode to m (0 m 7).

ENFL, nnnnn.

Sets central memory field length FL=nnnnn in the exchange package area. nnnnn 10000 if user ECS is assigned.

ENFLE, nnnn.

Sets ECS field length FLE to nnnn000 in the exchange package area. If user ECS is assigned (nnnn 0), FL set by the ENFL command must be greater than or equal to 10000.

ENP, addr.

Sets P=addr (next instruction address).

ENPR, pp.

Sets job priority to pp (1 pp 70g).

ENS, ccc...ccc.

Allows entry of control statement ccc...ccc as the next unprocessed statement in the control statement buffer. The statement can then be processed using RNS, RSS, or DROP. ENS clears the control statement buffer of previous statements if a KCL procedure file is in effect. Use of ENS, with CCL procedure files will produce unexpected results. This command is valid only when AUTO MODE is not set.

ENTER, /cccccc./dddd./

Allows entry of control statements ccccc and dddd from the keyboard and sets AUTO MODE.

ENTL, timlmt.

Sets the job time limit to timlmt (77777g is infinite).

ENXi, xxx...xxx.

Sets register Xi=xxx...xxx in the exchange package area.

ENXi, Lxxx...xxx.

Sets register Xi=xxx...xxx, left-justified, in the exchange package area.

ENXi, Dccc...ccc.

Sets register Xi to ccc...ccc display code characters.

ENXi, b, xxxx.

Sets byte b of register Xi to xxxx.

ERR.

Sets error flag, terminates program execution, and clears AUTO MODE if set.

GO.

Restarts a program which has paused.

HOLD.

DIS relinquishes the display console, but the job is held at the present status. The console must be reassigned to continue the use of DIS.

M, ccc...ccc.

Enters ccc...ccc as a CPU program command. Data is stored at RA+CCDR.

N.ccc...ccc.

Sets DIRECT CPU INPUT mode. Characters entered from keyboard are passed one character at a time, right-justified, directly into central memory at RA+CCDR. Pressing the left blank (erase) key twice clears DIRECT CPU INPUT mode.

OFFSWx.

Turns off sense switch x for the job ($1 \leq x \leq 6$).

ONSWx.

Sets sense switch x for the job ($1 \leq x \leq 6$).

O26.

Calls the O26 file editor to a control point. Refer to the NOS Systems Programmer's Instant for complete operating instructions.

RCP.

Requests central processor. Depending on job priority, execution begins at the next program address for a job suspended by a DCP request.

RCS.

Sets AUTO MODE and initiates automatic control statement processing. All succeeding control statements are read from the control statement buffer and processed automatically until an SCS command or an error is encountered, or until job completion. A period (.) may also be used to initiate automatic control statement processing.

RNS.

Reads and processes the next control statement in the DIS control statement buffer.

ROLLOUT.

Allows the job to roll out. This should be issued when the message ROLLOUT REQUESTED appears (or * may be used).

ROLLOUT,xxxx.

Places job in rollout queue for xxxx job scheduler delay intervals. The job is automatically rolled back in after this period of time.

RSS.

Reads the next statement from the control statement buffer and stops prior to CPU execution. This is used to initiate breakpointing of a program.

RSS,ccc...ccc.

Reads statement ccc...ccc and stops prior to CPU execution. Action is similar to ENS.ccc...ccc. followed by RSS. except that the control statement buffer is not cleared.

SCS.

Clears AUTO MODE and stops automatic control statement processing.

T,addr.

Changes the T display to start at address addr.

U,addr.

Changes the U display to start at address addr.

UCC=c.

Sets the uppercase character to c.

V,addr.

Changes the V display to start at address addr.

X,ccc...ccc.

Processes ccc...ccc as the next control statement. Only the first 50 characters following X are used.

* xxx.

If an asterisk (*) followed by a blank and xxx is encountered during automatic control statement processing (AUTO MODE), xxx is interpreted as a direct DIS command rather than a control statement. For example, *C4,100. will set the left screen display to the central memory C display at address 100. Using this feature, it is possible to set up procedure files that use DIS to breakpoint a program to a desired stopping point.

xxxx.

Processes xxxx as a control statement if it is not a recognizable DIS command.

MEMORY ENTRY COMMANDS

The following commands are used in conjunction with the C, D, F, G, and M memory displays to change the contents of central memory and ECS. Either absolute locations or those relative to the control point to which DIS is assigned may be changed. Character values or numeric data can replace the current word contents. Either one 12-bit byte, one 15-bit parcel, one 30-bit parcel, or 60 bits can be changed. A single byte can be changed by inserting the byte number after the location to be changed; bytes are numbered 0 through 4 from left to right. The address and contents are assembled right-justified with leading zero fill. Leading zeros may be omitted in the entry.

CAUTION

Improper use of these commands may result in damage to the system or to user jobs.

Unlock the console keyboard to change the contents of absolute memory locations (refer to description of UNLOCK command in section 3). The = key is used to alternate between relative and absolute settings. When absolute mode is in effect, the letters ABS appear next to the display identifier at the top of the left screen. There is no visual indication when relative mode is in effect. Formats and descriptions of the memory entry commands are as follows:

aaaaaa,yyy.....yyy.
or
aaaaaa+yyy...yyy.

Changes the contents of memory location aaaaaa to yyy...yyy. The second form of the command performs essentially the same function but leaves the address at aaaaaa+1 allowing immediate entry for the next memory location.†

aaaaaa,b,yyyy.
or
aaaaaa+b,yyyy.

Changes the contents of byte b at memory location aaaaaa to yyyy. Note that each location consists of five 12-bit bytes, numbered 0 through 4 from left to right. The second form of the command performs essentially the same function but leaves the address at aaaaaa+1 allowing immediate entry for the next memory location.†

aaaaaa,Dyyy...yyy.
or
aaaaaa+Dyyy...yyy.

Changes the contents of memory location aaaaaa to display code characters yyy...yyy (left-justified and zero-filled). The second form of the command performs essentially the same function but leaves the address at aaaaaa+1 allowing immediate entry for the next memory location.†

aaaaaa,Lyyy...yyy.
or
aaaaaa+Lyyy...yyy.

Changes the contents of memory location aaaaaa, left-justified to yyy...yyy. The second form of the command performs essentially the same function but leaves the address at aaaaaa+1 allowing immediate entry for the next memory location.†

aaaaaa,In,yyyyy.
or
aaaaaa+In,yyyyy.

Changes the contents of instruction n (0 through 3 from left to right) at memory location aaaaaa to yyyy; yyyy may be a 15- or 30-bit instruction. However, one or more bits must be set in the upper 15 bits of a 30-bit instruction or the entry will be treated as a 15-bit instruction. The second form of the command performs essentially the same function but leaves the address at aaaaaa+1, allowing immediate entry for the next memory location.†

Eaaaaaaa,yyy...yyy.
or
Eaaaaaaa+yyy...yyy.

Changes the contents of ECS location aaaaaa to yyy...yyy. The second form of the command performs essentially the same function but leaves the address at aaaaaa+1 allowing immediate entry for the next ECS location.†

Eaaaaaaa,b,yyyy.
or
Eaaaaaaa+b,yyyy.

Changes the contents of byte b at ECS location aaaaaa to yyyy. Note that each location consists of five 12-bit bytes, numbered 0 through 4 from left to right. The second form of the command performs essentially the same function but leaves the address at aaaaaa+1 allowing immediate entry for the next ECS location.†

Eaaaaaaa,Dyyy...yyy.
or
Eaaaaaaa+Dyyy...yyy.

Changes the contents of ECS location aaaaaa to display code characters yyy...yyy (left-justified and zero-filled). The second form of the command performs essentially the same function but leaves the address at aaaaaa+1 allowing immediate entry for the next ECS location.†

PP CALL COMMANDS

Any PP program with a name that begins with a letter may be called to the control point by DIS. However, before entering any of these commands, it is necessary to have a working knowledge of the PP program to be called. This will ensure correct use of the specified program.

CAUTION

Improper use of these commands may result in damage to the system or to user jobs.

In the following list, prg denotes the name of the PP program, and n is the control point number.

Command	Description	Format of PPU Call Initiated
prg.	Calls PP program prg to control point.	18/3Lprg,6/n, 36/0
prg,xxx.	Calls PP program prg to control point; xxx is a parameter required by prg.	18/3Lprg,6/n, 18/0,18/xxx
prg,xxx,yyy.	Calls PP program prg to control point; xxx and yyy are parameters required by prg.	18/3Lprg,6/n, 18/xxx,18/yyy

†If the message REPEAT ENTRY is displayed above the entry line, the yy...yy field is not cleared and may be entered in successive memory locations as many times as desired by pressing CR. The repeat entry mode is enabled by pressing CR before initial entry of the command. This is also applicable to the b and n fields of the second, fifth, and seventh commands.

This section describes the operation of the REDEFINE and FLAW mass storage utilities.

NOTE

There are special cases when on-line reconfiguration cannot be performed. In these cases, the only reconfiguration possible is by performing a level 0 deadstart and defining the failing device to another drive. The special cases are:

- Reconfiguring an 885 disk drive that is the sole system device defined.
- Reconfiguring an 844 or 885 disk drive that is the sole temporary device defined.

ON-LINE RECONFIGURATION (REDEFINE)

Use the REDEFINE utility to reconfigure 844 and 885[†] disk drives on line and thus logically eliminate a unit which is malfunctioning without performing a level 0 initial deadstart. A single unit or multiunit device^{††} which fails can be replaced with an unused unit. Unused units must be available or made available across channels or on the same channel as the failing unit by physically moving the disk pack from the failing unit to the replacement unit. Table 6-1 gives the equipment requirements for reconfiguration.

TABLE 6-1. EQUIPMENT REQUIREMENTS FOR RECONFIGURATION

Operation To Be Performed	Current Equipment	Replacement Equipment		Special Considerations
		Must be in EST.	Must be unloaded, removable.	
Add or Return a Unit	Yes.	No.	Yes.	Equipment must have less than eight units.
Delete a Unit	Must be removable; if not unloaded, the unit must be in the EST.	N/A.	N/A.	Equipment must have at least one unit.
Replace a Unit	No.	Not necessary.	Yes, if in EST.	The system does not perform label verification on packs that are unloaded before the failing unit is replaced. If the unloaded pack is not moved from the failing unit or the wrong pack is moved, the system issues an error message the next time the replacement unit is accessed.
Recable a Unit	No.	N/A.	No.	None.

[†]When reconfiguring an 885 disk drive, a customer engineer must be present.

^{††}When reconfiguring a multiunit device, all units of the device must be on the same controller(s).

The reconfiguration sequence is as follows:

1. Request reconfiguration of the mass storage device defined by EST ordinal xx by entering:

REDEFINE,xx.

The message REQUEST*K*DISPLAY appears at the appropriate control point on the job status (B) display. Reentry of the REDEFINE command can be done as many times as there are devices to be reconfigured. Multispindle devices that include two or more units are considered one device.

If an INITIALIZE command is being processed, the REDEFINE entry is not processed until the initialization is complete.

2. Redefine using the K display (figure 6-1). Bring the K display to the left console screen by entering:

K,n. n is the number of the control point requesting the K display.

The current EST description of the device being reconfigured appears under the header CURRENT EQUIPMENT CONFIGURATION. The EST description of the device as changes are made appears under the heading REQUESTED EQUIPMENT CONFIGURATION. Any devices listed under IDLED EQUIPMENTS are devices that have been previously selected by your REDEFINE,xx command but have yet to be processed in the reconfiguration run.

The K display may not list all relevant devices. If more than one device is listed, they are processed one at a time as they appear in the list with one exception: all shared devices are processed prior to nonshared devices.

You are guided through the reconfiguration process in two ways. First, by a list of commands and parameters shown on the K display under LEGAL PARAMETER DEFINITIONS. These are the only commands and parameters valid at that time. Second, by the system responses and error messages.

3. Enter all the valid parameters (table 6-2) that define the reconfiguration characteristics for the specified device. Parameters are entered singly followed by CR. Parameters are processed left to right; no terminator is necessary.

NOTE

If the unit number specified in the UL= parameter represents a unit which is not defined in the EST, the unit number is accepted without validation. Ensure that the unit number entered represents a valid device.

If you enter an incorrect parameter or option (for example, the wrong channel number), the error can be corrected by retyping the correct parameter and option(s).

```

                                     K 17.
                                     *** MASS STORAGE FAILURE RECOVERY ***
LEGAL PARAMETER DEFINITIONS.
CLEAR          CLEARS IDLE AND SUSPEND ON CURRENT EQUIPMENT.
END            CLEAR ALL DEVICE IDLES, AND END *CONFIG*.
GO            INITIATES PROCESSING OF ENTERED CONFIGURATION.
RERUN         RESTARTS *CONFIG* UTILITY PROCESSING.
RESET        RESETS CURRENT EQUIPMENT TO DEFAULT PARAMETERS.
SUSPEND      SUSPEND ALL SYSTEM OPERATION ON CURRENT EQUIPMENT.
CH=C1,C2    C1 AND OPTIONALLY C2 ARE NEW CHANNELS FOR ACCESS.
EQ=EE       SET EQUIPMENT EE TO BE PROCESSED.
UL=U1,U2 ..UN SET UNIT LIST AS SPECIFIED.
UR=UU       UNIT UU IS TO BE RECABLED WITH A NEW DRIVE.

CURRENT EQUIPMENT CONFIGURATION.
34. DJ-1 CH05,07 UL=05 -- -- -- -- -- ST = I---

REQUESTED EQUIPMENT CONFIGURATION.
34. DJ-1 CH05,07 UL=05 -- -- -- -- -- ST = I---
    CHANGED UNITS

IDLE EQUIPMENTS
27. DJ-1 CH26,32 UL=07 -- -- -- -- -- ST = I---
```

Figure 6-1. REDEFINE K Display

4. Enter

K.GO

to initiate the processing of the parameters when all parameters and commands (table 6-3) have been entered for specific device. This command is entered after each set of parameters to signal the system to go ahead with the reconfiguration you have defined. If more devices remain to be reconfigured, repeat steps 3 and 4.

5. Enter

K.END

to end a reconfiguration run when there are no more devices to be processed.

You can stop the reconfiguration procedure by entering either the K.ABORT command or the K.CLEAR command (depending on which command is posted in the list of valid commands on the K display). In either case, processing advances to the next device in the list of devices under IDLED EQUIPMENTS.

If the device specified is a shared device in a multimainframe environment and reconfiguration is not desirable on one or more of the mainframes, use the following procedure.

1. Enter

REDEFINE,xx xx is the EST ordinal of the shared device.

at the console of each mainframe for which reconfiguration of the shared device is not desired.

2. Enter

K,n. n is the number of the control point requesting the K display.

3. Enter

K.IGNORE

and processing on the shared device in the list is ignored by that mainframe. The machine must wait until the shared device is done with its processing.

4. Enter

K.END

to end the reconfiguration.

Enter either the RERUN or RESET command to clear the IGNORE command.

Figure 6-2 shows the output for a sample reconfiguration run.

ORD	TYPE	CHANNELS	UNITS	STATUS
01	DJ-1	CH26, 32	UL=06	ST = ----
02	DJ-1	CH26, 32	UL=07	ST = ----
03	DJ-1	CH32	UL=01	ST = ----
04	DJ-1	CH13	UL=02	ST = ----
05	DI-1	CH26	UL=03	ST = ----
06	DI-1	CH32	UL=11	ST = ----
07	DI-1	CH26, 32	UL=04	ST = I----
11	DP-1	CH00, 30	UL=12	ST = ----

Figure 6-2. Reconfiguration Run Output

The following are examples of reconfiguration of mass storage devices and how their status changes in the EST display.

Example 1, Returning a unit to the system:

Assume the unit of equipment 2, the system's spare disk drive, was used to replace a failing disk drive. Now that the defective unit has been repaired, it is to be returned as the unit of the spare disk drive.

Mass storage configuration before the REDEFINE:

EST Ordinal	Equipment Type	Channel Number(s)	Unit Number	Status
2	DJ-0	00	-	I--

Enter the following commands:

REDEFINE,2.
K,n. n is the number of the control point requesting the K display.

K.CH=32,26 32 and 26 are the channel numbers to be used by equipment 2.

K.UL=7
K.GO 7 is the unit number of the device being returned.

The system responds with the message:

EQ 2 PROCESSING COMPLETE.

To end the reconfiguration, enter:

K.END

Mass storage configuration after the REDEFINE:

EST Ordinal	Equipment Type	Channel Number(s)	Unit Number	Status
2	DJ-1	32,26	7	--

Example 2, Reconfiguring a failing unit:

Assume equipment 3 and equipment 4 are defined in the EST display. Equipment 3 is a spare unit currently not being used. Equipment 4 has a pack mounted and is the failing device. Before the failing device can be reconfigured, the spare unit must be removed from the EST. The following stipulations apply when deleting a unit from the EST:

- If the equipment is defined in a single mainframe environment or if it is not shared in a multimainframe environment, then having device unavailable status (U status in the E,M display) for that equipment is sufficient.
- If the equipment is shared in a multimainframe environment, then that equipment must have device unavailable status and be globally unloaded (U and N status in the E,M display) before a reconfiguration can be performed.

Mass storage configuration before the REDEFINE:

EST Ordinal	Equipment Type	Channel Number(s)	Unit Number	Status
3	DJ-1	32	1	I--
4	DJ-1	13	2	---

TABLE 6-2. RECONFIGURATION PARAMETERS

Parameter	Description
CH=c ₁ ,c ₂	<p>Specifies the channel numbers (c₁ and, optionally, c₂) to be used under the new device definition.</p> <p>This parameter is used when the entire device is to be redefined to alternate channel number(s). It can also be used to add or delete channels from an equipment definition. New channels can be added by specifying new channel numbers for a defined equipment. Channels can be deleted by specifying CH=. when deleting a unit. Acceptable values for c₁ and, optionally, c₂ are 0 to 13₈ for systems having 10 or less PPs; 0 to 13₈ and 20₈ to 33₈ for systems having more than 10 PPs. Leading zeros can be omitted.</p>
EQ=nn	<p>Specifies the equipment with EST ordinal nn is to be processed. Enter this parameter when the processing of equipments is order dependent; for example, when a device must first be made available before it can replace a failing device. The system ignores all parameters not processed before you enter the EQ=nn parameter. Parameters entered after EQ=nn refer to the specified equipment until another EQ=nn is entered or a command is entered that causes the next equipment in the list to be selected for processing.</p>
UL=u ₁ ,u ₂ ,...,u _n	<p>Specifies the unit list for the new configuration.</p> <p>When a unit is to be replaced, added, or deleted the entire unit configuration must be entered with this parameter. The equipment must be unloaded (multimainframe mode) or otherwise have an unavailable status if a unit is to be added or deleted. Any number of units can be changed. By specifying UL=, the current unit configuration is deleted.</p>
UR=nn	<p>Specifies that the device with EST ordinal nn is to be recabled. This parameter is used when a device is to be physically replaced by a new device with the same unit number. More than one device can be specified for recabling at the same time.</p>

TABLE 6-3. RECONFIGURATION COMMANDS

Command	Description
ABORT	Discontinues processing of the current command. It is entered only in response to a detected error condition and is used to initiate error recovery procedures. This command cannot be followed immediately by an END command.
CLEAR	Clears the suspend and redefinition request status for the current equipment. Label and read/write verification of the device is performed. This command should be entered only when no further processing is desired for the current equipment.
END	Terminates reconfiguration processing. The K display parameters are set to the default values as control is returned. This command cannot be entered immediately after an ABORT command.
GO	Initiates processing of specified reconfiguration parameters previously entered.
IGNORE	Informs the system on which the command was entered to ignore processing on this device (multimainframe mode only). This should be entered during an add or delete unit reconfiguration run on the machine(s) within the multimainframe complex which, for control reasons, cannot add to or delete from the specified equipment. Also, you can use this command to ignore an error message pertaining to marginally unacceptable servo timing check which is performed automatically when reconfiguring an 885 disk drive.
NEXT	Is entered in response to an 885 disk drive servo timing check that meets requirements. Entry of this command will cause processing to continue with the next device or the next step of processing. This command is valid only when reconfiguring 885 disk drives.
RECHECK	Retries a verification/diagnostic process which previously gave an error. Only the commands RECHECK, ABORT, and IGNORE are accepted by the system when an error message is issued.
RERUN	Sets the parameters to default values and updates the list of equipment to be reconfigured.
RESET	Resets the parameters to default values.
SUSPEND	Causes system processing on the specified device to be suspended indefinitely while the device is in a not ready state. Only diagnostic access to the device is allowed. All other jobs accessing the device will be unable to continue until the device is returned to a ready state. More than one equipment can be suspended at the same time.

To perform the reconfiguration, the following commands are used:

REDEFINE,3.
 REDEFINE,4.
 K,n. n is the number of the control point requesting the K display.

K.CH=. Deletes the channel number(s) assigned to equipment 3 from the EST.

K.UL=.
 K.GO Deletes the unit number of equipment 3 from the EST.

The system responds with:

EQ 3 PROCESSING COMPLETE.

Enter the reconfiguration commands for the failing device as follows:

K.CH=32 32 is the channel number that was assigned to equipment 3.

K.UL=1
 K.GO 1 is the unit number of equipment 3.

The system responds with:

SPIN DOWN UNIT 02. 02 is the unit number of equipment 4.

After the unit is spun down, the system responds with:

MOVE PACK FROM UNIT 02 TO UNIT 01 AND SPIN UP.

After the pack is moved and the new unit is spun up, the system responds with:

EQ 4 PROCESSING COMPLETE.

To end the reconfiguration, enter:

K.END

Mass storage configuration after the REDEFINE:

EST Ordinal	Equipment Type	Channel Number(s)	Unit Number	Status
3	DJ-0	00	—	—
4	DJ-1	32	1	—

Example 3, Reconfiguring devices across channels:

Units may be reconfigured across channels with the REDEFINE command. Assume that equipment 5 is the failing unit (or possibly the failing channel) and is on channel 26. Equipment 6 is the spare unit on channel 32. The following commands illustrate a reconfiguration across channels:

Mass storage configuration before the REDEFINE:

EST Ordinal	Equipment Type	Channel Number(s)	Unit Number	Status
5	DI-1	26	3	—
6	DI-1	32	11	—

Enter the following commands:

REDEFINE,5.
 REDEFINE,6.
 K,n. n is the number of the control point requesting the K display.

K.EQ=6 Selects the spare unit to be processed first.

K.SUSPEND Suspends the spare unit to clear it from the EST.

The system responds with:

SYSTEM USAGE OF EQ 6 SUSPENDED.

To continue with the reconfiguration on equipment number 5, enter:

K.EQ=5 Selects the failing unit for processing.

K.CH=32 Switches equipment 5 to the channel number of equipment 6.

K.UL=11
 K.GO Assigns the old unit number of equipment 6 to equipment 5.

The system responds with:

EQ 5 PROCESSING COMPLETE.

Mass storage configuration at this point in example 3.

EST Ordinal	Equipment Type	Channel Number(s)	Unit Number	Status
5	DI-1	32	11	I—
6	DI-1	32	11	IS—

All SUSPEND status flags must be cleared before a reconfiguration run can be ended. The system therefore automatically selects equipment 5 again for the next equipment to be processed.

To continue with the reconfiguration, enter:

K.CH=26 Assigns the old channel number of equipment 5 as the channel number of equipment 6.

K.UL=3
 K.GO Assigns the old unit number of equipment 5 as the unit number for equipment 6.

The system responds with:

EQ 6 PROCESSING COMPLETE.

To end the reconfiguration, enter:

K.END

Mass storage configuration after the REDEFINE:

EST Ordinal	Equipment Type	Channel Number(s)	Unit Number	Status
5	DI-1	32	11	—
6	DI-1	26	3	—

ON-LINE TRACK RESERVATION (FLAW)

The FLAW utility reserves (flaws) tracks on any mass storage device during normal system operation. Each entry identifies an area of mass storage that is unusable (flawed area) and prevents the system from accessing it. Since 881 and 883 disk packs normally contain flaw information in the utility sector, the FLAW utility should be used on an 881 or 883 only to specify additional areas not currently in the utility sector. Obtain flaw addresses from the customer engineer or the system analyst.

Flawing tracks on mass storage devices is accomplished using the K display (figure 6-3). Note that all console entry is performed under DSD control. The sequence is as follows:

1. Call FLAW utility by typing

X.FLAW.

2. Bring K display to left console screen by typing

K,n.

n Control point number requesting the K display (message REQUEST*K*DISPLAY appears at control point n on B display).

3. Specify mass storage device on which tracks are to be flawed. Enter

K.EQ=xx.

xx EST ordinal of the mass storage device.

4. Enter flaws. A maximum of 20 octal flaw entries is allowed for each call to the FLAW utility. In addition, there are three types of flaw entries that may be specified. The general format for K display entry is

K.xtk=ta.

xtk Specifies type of flaw entry.

STK

Sets track reservation table (TRT) entry for the specified logical track to indicate that track is unavailable for use.

TTK

Toggles track reservation table entry for specified physical ECS track. If TRT indicates that track is currently unavailable, track is made available and vice versa.

RTK

Sets the track reservation table entry for the specified physical block (track) address in ECS to indicate that the block is unavailable for use.

ta Specifies track address to be reserved.

ttt

Logical track address for 844 disk, 885 disk, or extended core storage. (Use with STK.)

4000g-7137g for 844-21 disk (DI/DK)

4000g-7147g for 844-41/44 disk (DJ/DL)

4000g-7222g for 885 disk (DM/DQ)

4000g-7620g for 2048K ECS (DE/DP)

Aaaaaa

Physical block (track) address for ECS. (Use with TTK or RTK.)

aaaaaa

ECS address divided by 10g.

5. Initiate flawing of specified device by typing

K.GO.

The FLAW utility provides two messages in the system dayfile which indicate the results of the flawing operation. The first message is

nn TRACKS FLAWED.

nn Octal number of tracks that were successfully flawed.

The second message appears only if some of the flaws specified were not processed. This occurs when the track specified for flawing is already reserved by the system (but not as a flawed track). In this case, the following message also appears in the system dayfile.

nn FLAWS NOT PROCESSED,
list.

nn Octal number of flaws not processed.

list List of the logical tracks that were not flawed.

The entries described here are similar to those entered in CMRDECK for flawing a device at deadstart time. However, the flaw entries specified via the FLAW utility or DSD command INITIALIZE (refer to section 3) are not recovered if the device is initialized at deadstart time. Only the flaw entries specified in CMRDECK will be recovered. If a device is initialized during normal system operation (INITIALIZE command), all flaws specified in devices TRT, including those entered via FLAW

*** MASS STORAGE DEVICE INITIALIZATION ***

CURRENT INITIALIZATION OPTIONS

OPTION VALUE	DESCRIPTION
FM = 0	FAMILY NAME/ PACK NAME
	FM = PACK NAME FOR TYPE =X
UN = 0	USER NUMBER
TY = 0	ACCESS TYPE - F OR X
DM = 0	DEVICE MASK
SM = 0	SECONDARY MASK
NC = 0	CATALOG TRACKS
EQ = 0	EST ORDINAL OF DEVICE
NP = 0	NUMBER OF PACKS
DN = 0	DEVICE NUMBER

SET FLAWS.

RTK,STK AND TTK ENTRIES, ENTER SINGLY

GENERAL FORMAT- XTK=A.
WHERE, *XTK* IS-
RTK = RESERVE TRACK
TTK = TOGGLE TRACK
STK = SET LOGICAL TRACK
AND *A* = EQUIPMENT FORMAT-

DE/DP - A000000 = ADDR/10B
DI - 0000 STK ONLY
DJ - 0000 STK ONLY
DK - 0000 STK ONLY
DL - 0000 STK ONLY
DM - 0000 STK ONLY
DQ - 0000 STK ONLY
DV/DW - C000,T00,S00

LIMIT = 20B ENTRIES.

Figure 6-3. FLAW Utility K Display

utility or INITIALIZE command, will be recovered providing the device has a good label at the time of initialization. If the label is bad, or cannot be recognized, all current flaws are cleared.

The right console screen (figure 6-4) shows all flaw entries made through the FLAW utility and INITIALIZE command. It lists the flaw entry and its logical track equivalent, and indicates entries which duplicate setting flaws on the same logical track.

NO.	** VALUES ENTERED **	TRT ENTRY DUPLICATE
1	STK=4002.	4002
2	STK=4130	4130
3	STK=5201	5201
4		

Figure 6-4. Right Screen FLAW Utility K Display

The commands described in this section are used when the network access method (NAM) is being initialized or is active. They initialize and control the 255x Network Processing Units (NPU's), trunks, lines, terminals, and application programs under network supervision. Initiating NAM (refer to the NAM command in section 3) causes NAM, the network supervisor (NS), the communications supervisor (CS), and the network validation facility (NVF) to be loaded and initiated at control points. NS coordinates all of the NPUs in the communication network. CS coordinates the network activities of the host computer and all of its communication elements. It establishes logical connections between the application programs and the terminals as they become available.

The network recognizes two types of operators: the network operator and the local operator (neither is to be confused with the system console operator). The network operator (NOP) controls network elements (NPUs, trunks, and logical links) by communicating with NS. The local operator (LOP) controls applications and communication elements (lines and terminals) by communicating with CS. The NOP and LOP can be either the system console operator or a terminal user who is validated for the operator privileges. A user at a single terminal can be both types of operator at once but only one network operator and one local operator can be declared at a time.

NAM INITIALIZATION COMMANDS

The following commands can be entered by the system console operator after entering the NAM command. In addition to these commands, the NOP/LOP commands ENABLE, DISABLE, and RELOAD can also be entered during initialization. Entry of the NAM command (n.NAMffff.) calls a procedure file called NAMffff. The system console operator can call procedure files with different default values for configuration files and possible inclusion of the GO command to automatically initiate processing. If defaults are not specified in the procedure file or are to be changed, the commands described below can be used. They are usually entered in the order shown. If a file containing GO is specified, these commands cannot be entered and the operator cannot enable or disable elements prior to initialization.

If the network or a network program fails, use the procedure described in appendix I on Network Failure Processing to resume network processing.

n.CFO.NCF,pfn,userid,passwd †

Assigns the network configuration file (NCF) specified by pfn. The NCF establishes the configuration of NPUs, trunks, and logical links in the network, and sets the initial state (enabled or disabled) of those elements. The operator can change the state of an element using the NOP/LOP ENABLE and DISABLE commands but subsequent entry of the NCF command cancels the settings.

n.CFO.LCF,pfn,userid,passwd †

Assigns the local configuration file (LCF) specified by pfn. The LCF establishes the applications, lines, and terminals in the network, and sets the initial state (enabled or disabled) of those elements. The operator can change the state of an element using the NOP/LOP ENABLE and DISABLE commands but subsequent entry of the LCF command cancels the settings.

n.CFO.CCP,pfn,userid,passwd †

Assigns the CCP load file specified by pfn. This file is used to load NPUs with the CCP software. This command can also be entered after an NPU load to change the load file for subsequent NPU loads.

n.CFO.GO. †

Initiates processing and communication with the network. NPUs requesting to be loaded are loaded and configured. Configured NPUs are not reloaded automatically at initialization but their configuration status is recovered. NETON requests and connections between applications are allowed. Logical links between NPUs and the host are established and connections between terminals and applications are established.

BECOMING A NETWORK/LOCAL OPERATOR

Initially the console operator is considered both the NOP and LOP. Once NAM has been activated, a terminal user with the proper validation can become a NOP or LOP using the following procedure.

1. Log in as described in the Network Access Method Reference Manual.
2. In response to

APPLICATION:

enter one of the following operator types.

- LOP Local operator.
- NOP Network operator.
- NOPLOP Both local and network operator.

3. The system informs the console operator that he no longer has NOP and/or LOP status and then sends the following message to the terminal user.

HELLO, YOU ARE NOW THE type OPERATOR

type Identifies the operator status (NETWORK, LOCAL, or LOP/NOP).

† In this command, n is the NAM control point number.

This message is followed by the prompt

.. (two consecutive periods)

and the terminal user can then perform the operator functions described in the remainder of this section.

To relinquish operator control, the NOP or LOP at the terminal should enter

END

The system informs the console operator that he has NOP and/or LOP status once again.

NOP/LOP COMMAND SYNTAX

All commands consist of a command verb and, optionally, one or more parameters separated by a comma and/or one or more blanks. A blank can replace a comma in the following commands. Some commands and parameters can be shortened to a two- or three-character abbreviation. Allowable abbreviations are underlined in the command format.

Parameters are order dependent and you can specify them in one of the following formats.

keyword

option

keyword=option

Option is an element name, an overlay name, or a character string. Parameter values identifying network or communication elements are indicated by an element name. In all command formats, the value of element name is a name not exceeding seven characters. The network definition language statements define the element names.

If you are the system console operator and also the network operator or local operator, you must enter all network and local operator commands using the operating system command-from-operator (CFO) command. The format of the command is:

n.CFO.command

n NAM control point.

command One of the network or local operator commands. The command cannot exceed 36 characters.

For example, you would enter

4.CFO.DISABLE, NETWORK
or
4.CFO.DI,NE

if NAM is at control point 4 and you want to disable the network.

If you enter the CFO command and are not the network or local operator, the system returns the message

ILLEGAL COMMAND.

A NOP or LOP at a terminal enters only the network or local operator command. When entered from a terminal, the command can be more than 36 characters.

The normal system response to a command is a prompt (..), which indicates that the command has been accepted and will be processed. The prompt indicates readiness to accept the next command. An abnormal system response to a command is an informative error message followed by the prompt. The error messages are in appendix B.

NETWORK ELEMENT STATUS CODES

<u>Code</u>	<u>Status</u>	<u>Description</u>
DI	Disabled	The element is not active and cannot become active unless enabled by an operator command.
EN	Enabled	The element is not active but can become active during network operations.

The following two status codes are substates of the enabled status.

<u>Code</u>	<u>Status</u>	<u>Description</u>
AC	Active	The element is loaded and configured (where appropriate) and capable of handling network data traffic. Only enabled elements can become active.
DN	Down	The element was active, but a failure was detected that terminated data traffic for the element. If the failure condition ceases, the element returns to the enabled status. If the element is an NPU, down status indicates that the NPU is being dumped or loaded. The element becomes active when the load is complete.

NETWORK OPERATOR COMMANDS

The network operator is responsible for control of network elements (NPUs, trunks, and logical links), loading of overlays in NPUs, and shutdown of network operations.

†If entered by the system console operator during NAM initialization, this command temporarily updates the NCF and is used only if the NPU supporting the element must be reloaded. Trunks cannot be enabled/disabled prior to entry of the GO command; the action is performed after GO is entered.

DISABLE,NETWORK

Causes immediate shutdown of network operations. All applications must terminate immediately.

DISABLE,NPU=npu †
or
DISABLE,TRUNK=trunk †
or
DISABLE,LLINK=loglink †

The options are as follows:

npu Name of the Network Processing Unit.
trunk Name of the trunk.
loglink Name of the logical link.

The site analyst defines these element names in the network configuration file. The DISABLE command allows you to disable the NPU, trunk, or logical link. If the element is active when you enter the DISABLE command, data transmission is terminated and affected application programs are notified.

DUMP,npu,ON
or
DUMP,npu,OFF

Sets the dump flag that indicates whether the system should take a memory dump of the NPU during the next load procedure. The system does not dump the NPU at the time you enter the command. The network supervisor automatically sets the dump flag to ON at the following times.

- After each successful load of the NPU.
- After the system recovers the NPU following a deadstart recovery or a network recovery.
- At network initialization, if the previous NAM run aborted or stopped by some means other than the network operator command, DISABLE, NETWORK (for example, the STOP command).

If none of the above has occurred, during initialization the network supervisor uses the dump flag setting in the network configuration file.

ENABLE,NPU=npu †
or
ENABLE,TRUNK=trunk †
or
ENABLE,LLINK=loglink †

The options are as follows:

npu Name of the Network Processing Unit.
trunk Name of the trunk.
loglink Name of the logical link.

The site analyst defines these element names in the network configuration file. The ENABLE command allows you to ready the NPU, trunk, or logical link for use.

IDLE,NETWORK

Idles network operations. The system warns applications of the upcoming shutdown. It rejects new NETON requests, logins, and interapplication connections and ignores newly operational NPUs. As the applications become idle, they disconnect from the network. When there are no active applications, NAM leaves the system.

OVERLAY,npu,LOAD=ovl
or
OVERLAY,npu,DATA=string
or
OVERLAY,npu,DROP

The options are as follows:

npu Name of the Network Processing Unit.
ovl Three-character name of the NPU load file defined during installation.
string Response to the message that the executing overlay sent.

Usually site analysts or customer engineers use the OVERLAY commands to take the indicated action on a specific NPU overlay. The first form of the command loads the specified overlay. The second form responds to a message the overlay sent. The overlay sends a message in the following format.

FROM npu/ovl...string

The third form terminates overlay execution.

RELOAD,npu
or
RELOAD,npu,DUMP

Stops an active NPU, then reloads and reactivates the NPU. If you use the second form of the command, the system dumps the NPU before reloading it. The system rejects this command if the console operator enters it during initialization or if the NPU is not active.

STATUS,NPU=npu
or
STATUS,TRUNK=trunk
or
STATUS,LLINK=loglink

The options are as follows:

npu Name of the Network Processing Unit.
trunk Name of the trunk.
loglink Name of the logical link.

† If entered by the system console operator during NAM initialization, this command temporarily updates the NCF and is used only if the NPU supporting the element must be reloaded. Trunks cannot be enabled/disabled prior to entry of the GO command; the action is performed after GO is entered.

The site analyst defines these options in the network configuration file. The STATUS command requests the status of a single NPU, trunk, or logical link. For status purposes, the system treats the couplers as trunks. The comand

STATUS,TRUNK=name

where name is the coupler, returns the status of that coupler.

The system responds to a STATUS command in one of the following formats.

NPU: name,status,node

TRUNK: name,status,node/port,remote/port

LLINK: name,status,RL=n,host/term

The parameters are as follows:

host Host node number.

name Name of element.

node Element node number.

port Port number.

RL=n Regulation level currently in effect.

remote Remote node number.

status Status of element:

DI (disabled).

EN (enabled).

AC (active).

DN (down).

term Terminal node number.

The site analyst defines the host, name, node, part, remote, and term options in the network configuration file. The options for the regulation level (n) are in the Communications Control Program Version 3 Reference Manual.

STATUS,NPUS

or

STATUS,TRUNKS,NPU=name

or

STATUS,LLINKS

Requests status of all NPUs, trunks, or logical links. For status purposes, the system treats the couplers as trunks. The command

STATUS,TRUNKS

returns the status of all trunks and couplers. If you include the NPU=name parameter in the second form of the command, the system returns the status of all trunks connected to the specified NPU.

Response to a STATUS command consists of a single status line for each element referenced. The previous command description shows the response format.

LOCAL OPERATOR COMMANDS

The local operator is responsible for control of network applications and communications elements (lines and terminals).

DISABLE,LINE=name[†]

or

DISABLE,TERM=name^{††}

or

DISABLE,APPL=name

Disables the line, terminal, or application having the specified name. If the line associated with a terminal is down, the terminal cannot be disabled until the line becomes active. If the line, terminal, or application is active when you enter the DISABLE command, the system terminates data being transmitted and notifies affected application programs.

If the operator disables all terminals on a line, that line is automatically disconnected (dial-up line) or disabled (hardwired line) after a certain period of time.^{†††}The line will not be disconnected or disabled if the operator enables a terminal on the line before the time period expires.

NAM rejects the second form of the command during NAM initialization. The third form controls an application's access to the network during initialization and any time the application is not executing.

[†]If entered by the system console operator during NAM initialization, this command temporarily updates the LCF and is used only if the NPU supporting the element must be reloaded.

^{††}This command is illegal if the specified terminal has been defined on an X.25 line type (line type H1; refer to the Network Definition Language Reference Manual).

^{†††}The time period is set by installation option.

ENABLE,LINE=name†
or
ENABLE,TERM=name††
or
ENABLE,APPL=name

Enables the line, terminal, or application having the specified name. A terminal cannot be enabled until its associated line is active. The second form of the command is rejected during NAM initialization.

IDLE,APPL=name

Idles the network application with the specified name. This command requests an eventual NETOFF action be taken.

MSG,ALL,message
or

MSG,element=name,message

Sends a message of 1 to 50 characters to the specified terminal(s). If the first form of the command is used, the message is sent to all terminals regardless of the user's application. Element can be either one of the following:

TERM

NPU

You can use this command to respond to a message from a terminal user. The system displays a message from a terminal in the following format.

FROM terminal name:
message

STATUS,APPL=name
or
STATUS,LINE=name
or
STATUS,TERM=name

Requests status of a single application, line, or terminal with the specified name. Response to a STATUS command is given in one of the following formats.

NPU: name,**,node
LINE: name,status,port,ltype,ntpu
APPL: name,status,count
TERM: name,status,dt/tc,appl/acn,line,caddr,taddr

The parameters are as follows:

acn Application connection number for terminal's connection.
appl Name of application to which terminal is currently connected.
caddr Cluster address. Refer to the Network Definition Language Reference Manual.
count Number of active connections to this application.
dt Device type.

† If entered by the system console operator during NAM initialization, this command temporarily updates the LCF and is used only if the NPU supporting the element must be reloaded.

†† This command is illegal if the specified terminal has been defined on an X.25 line type (line type H1; refer to the Network Definition Language Reference Manual).

line Name of line to which terminal is connected.

ltype S1, S2, S3, and so forth. Refer to the Network Definition Language Reference Manual.

name Name of element.

node Element node number.

ntpu Name of NPU.

port Port number.

status Status of element:

DI (disabled).
EN (enabled).
AC (active).
DN (down).

taddr Terminal address. For HASP multileaving terminals, this is the stream number. For X.25 circuits (permanent and switched), this is the logical channel number.

tc Terminal class.

STATUS,APPLS, or STATUS,LINES or STATUS,TERMS

Requests status of all applications, lines, or terminals.

STATUS,APPLS,ON

Requests status of netted on applications only.

STATUS,LINES,NPU=name

Requests status of all lines on the specified NPU.

STATUS,TERMS,type=name

Requests status of all terminals. This command can be entered in any of the following formats.

STATUS,TERMS,APPL=name

STATUS,TERMS,LINE=name

STATUS,TERMS,NPU=name

These commands return status of all terminals connected to a specific application, all terminals on a specific line, and all terminals on a specific NPU.

Response to a STATUS command consists of a single status line for each element referenced in the format shown in the description of commands that request status of single elements.

STATUS,ON or STATUS,OFF

Allows or disallows the logging of unsolicited line status messages. STATUS,ON causes all unsolicited line status messages to be logged. STATUS,OFF suppresses the logging of all unsolicited messages except those that report the DI (disabled) status. The initial setting is by an installation option (Control Data default is ON).

When a machine that has been in a multi-mainframe configuration has a malfunction that requires a level 0 deadstart, before you can begin the deadstart, the machine recovery utility program (MREC) must be run on every machine which shares devices with the machine that is not working properly. MREC releases local mass storage space on the shared devices and clears interlocks set before the malfunction occurred.

For example, assume that machines A and B share disk unit 12 and machines B and C share disk unit 13 as shown in figure 8-1.

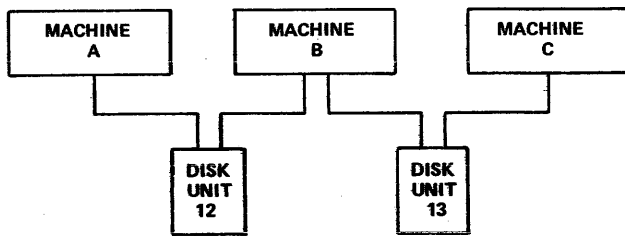

Figure 8-1. Machine Configurations

If machine A must be deadstarted using a level 0 deadstart, MREC must be run on machine B to recover disk unit 12. Machine C need not be involved since it is not aware of the existence of disk unit 12. However, if machine B must be deadstarted using a level 0 deadstart, MREC must be run on machine A to recover disk unit 12 and on machine C to recover disk unit 13.

NOTE

Once MREC has been run for an inoperative machine, any level of deadstart on the machine other than 0 is illegal.

MREC PROCEDURES

Use of the MREC utility can be accomplished through keyboard entry to a K display or by direct keyboard entry under DSD or DIS.

The following procedure describes K display usage for MREC operations under DSD control.†

1. Call MREC by typing

X.MREC.
2. Examine the DSD job status (B) display. When MREC is scheduled to a control point, it is indicated on the B display. The message

REQUEST *K* DISPLAY

appears in the message field for that control point.

3. Activate the K display for that control point by typing

K,n. (n is the control point number)

The K display for MREC (figure 8-2) appears on the left console screen.

The MREC left screen K display lists all the devices that are shared by the machine on which MREC is being run. The machine ID of this machine is given in the second line of the display. Information describing the devices is given in the following format.

eq type un dn fm/pn status mid(s)sharing device

eq

EST ordinal of equipment.

type

Device type.

un

Unit number of device.

dn

Device number.

fm/pn

Family name/pack name.

status

Status bits from MST:

- U Unavailable.
- R Removable.
- N Global unload.
- X Auxiliary permanent file device.

mid(s) sharing device

Machine IDs of other machines that are currently accessing the device. If there is an * by the machine ID, the machine is determined to be down.

4. The right screen K display for MREC contains the commands and parameters which may be selected. To activate the right screen K display (figure 8-3), type

KK.

† Under DIS control, the command MREC. followed by a carriage return calls the MREC utility.

*** MACHINE RECOVERY UTILITY ***

SHARED DEVICES MID = 72.

EQ	TYPE	UN	DN	FM/PN	STATUS	MID(S)	SHARING DEVICE
02	DI-2	0	40	SYS172	----	27*	33
04	DJ	1	60	MMF	-R--	27*	42*
11	DE	0	12	SYSTEM	----	27*	33 42*

ID = MID OF DOWNED MACHINE

EQ = ALL EQ(S) TO RECOVER

Figure 8-2. MREC Left Screen K Display

*** MACHINE RECOVERY UTILITY ***

DESCRIPTION OF TABLE ENTRIES.

EQ - EST ORDINAL OF EQUIPMENT.
UN - UNIT NUMBER.
DN - DEVICE NUMBER.
FM/PN - FAMILY OR PACK NAME (IF ANY)
STATUS - U UNAVAILABLE.
 R REMOVABLE.
 N GLOBAL UNLOAD.
 X AUXILIARY PERMANENT FILE DEVICE.
MID(S) SHARING DEVICE - MACHINE ID(S) OF OTHER
 MACHINES CURRENTLY SHARING DEVICE.
 (* BY MID INDICATES MACHINE HAS
 BEEN DETERMINED TO BE DOWN.)

DESCRIPTION OF PARAMETERS.

ID - MID OF DOWNED MACHINE TO PROCESS.
EQ - EST ORDINALS OF DEVICES SHARED BETWEEN THIS
 MACHINE AND DOWNED MACHINE TO PROCESS. I.E.
 EQ=XX,XX,...,XX. DEFAULT = ALL. I.E. EQ=ALL.
OP=I AND OP=R ARE PARAMETERS WHICH MAY BE
 ENTERED IF 844 OR 885 RESERVE SITUATIONS OCCUR. OP=I WILL
 CAUSE THE DEVICE TO BE IGNORED. OP=R WILL CAUSE
 ALL UNIT RESERVES ON THAT CONTROLLER TO BE CLEARED.
 THESE PARAMETERS ARE ONLY VALID FOR THE CURRENT
 RESERVED 844 OR 885 UNIT AND MUST BE REENTERED
 UPON REOCCURENCE OF ANOTHER RESERVE SITUATION.

DESCRIPTION OF K DISPLAY COMMANDS.

GO - INITIATE PROCESSING OF DEVICES SPECIFIED.
RERUN - REINITIALIZE K DISPLAY AND RERUN PROGRAM.
STOP - TERMINATE PROGRAM.
+ - PAGE RIGHT DISPLAY IF .GT. 24D SHARED DEVICES.

Figure 8-3. MREC Right Screen K Display

5. Enter MREC parameters in the following format.

K.option₁=value₁,option₂=value₂,...,
option_n=value_n.

The options entered (and error messages, if any) are displayed on the lower portion of the left screen K display.

6. If it is desired to reset options to their default values or to refresh the device descriptions on the top portion of the left screen K display, type

K.RERUN.

Parameters can then be reentered.

Table 8-1 describes the parameters available and table 8-2 describes the commands.

TABLE 8-1. MREC OPTIONS

Option	Description						
ID=	One- or two-character machine ID of the inoperative machine which is to be processed. This option must be entered before processing can take place.						
EQ=	EST ordinals of devices to process. Only devices shared between the machine which is down and the machine on which MREC is running are processed. If the equipments are entered that cannot be processed, they are ignored. The form of the entry is EQ=xx ₁ ,xx ₂ ,...,xx _n . or EQ=ALL. The latter form means that all devices shared between this machine and the inoperative machine are to be processed. Default is EQ=ALL.						
OP=x	This option may only be entered via the K display (that is, it cannot be used if MREC is called by control statement) and is to be used only if a unit or controller cannot be accessed by MREC due to physical hardware reservations. Its use is illegal if a unit reservation is not in effect. <table border="1" style="width: 100%; border-collapse: collapse;"> <thead> <tr> <th style="text-align: left;"><u>x</u></th> <th style="text-align: left;"><u>Description</u></th> </tr> </thead> <tbody> <tr> <td>R</td> <td>Directs MREC to release all unit reservations (via GRENADE function, refer to the Installation Handbook) for 844-n or 885 equipment. Refer to the next note in this section.</td> </tr> <tr> <td>I</td> <td>Directs MREC to ignore certain functions on the equipment for which the reservation message was issued. Functions that do not require the unit to be accessed will still be performed.</td> </tr> </tbody> </table> Refer to MREC Unit and Controller Reservation later in this section.	<u>x</u>	<u>Description</u>	R	Directs MREC to release all unit reservations (via GRENADE function, refer to the Installation Handbook) for 844-n or 885 equipment. Refer to the next note in this section.	I	Directs MREC to ignore certain functions on the equipment for which the reservation message was issued. Functions that do not require the unit to be accessed will still be performed.
<u>x</u>	<u>Description</u>						
R	Directs MREC to release all unit reservations (via GRENADE function, refer to the Installation Handbook) for 844-n or 885 equipment. Refer to the next note in this section.						
I	Directs MREC to ignore certain functions on the equipment for which the reservation message was issued. Functions that do not require the unit to be accessed will still be performed.						

TABLE 8-2. MREC COMMANDS

Command	Description
GO.	Directs MREC to proceed with processing of the entered parameters.
RERUN.	Reinitializes the device descriptions and parameters on the K display.
STOP.	Terminates MREC and ends K display interaction.
+	Toggles the right screen K display between the K display instructions and the second page of device descriptions if there are more than 24 (decimal) shared devices.

7. After the desired parameters have been entered, initiate MREC processing by typing

K.GO.

When processing is complete, the message

PROCESSING COMPLETE

is displayed at the bottom of the left screen.

8. After all MREC operations are complete, end the utility by typing

K.STOP.

It is also possible to call MREC and specify appropriate options without the use of the K display. This is accomplished via a single keyboard entry (under DSD or DIS) in the following format.

X.MREC(option₁=value₁,option₂=value₂,...,
option_n=value_n)

option_i=value_i Option parameters described in table 8-1.

The ID=parameter must be entered.

When the MREC control statement is entered with parameters, the K display is not activated but processing occurs automatically. If an error occurs using this procedure, the message

REQUEST *K* DISPLAY

appears on the DSD B display. Activate the K display and continue as described in the preceding procedure.

MREC UNIT AND CONTROLLER RESERVATIONS

When attempting to access a device, MREC may find the controller access or unit reserved by another machine. When this occurs, the following message is displayed on the left screen K display.

EQxx,CHcc, CONTROLLER RESERVED.

or

EQxx,UNuu, UNIT RESERVED.

- xx EST ordinal of the device.
- cc Channel number.
- uu Physical unit number (0 through 77g).

Assuming the inoperative machine is the machine holding the reservation, clear the reservation or direct MREC to clear it by using the following procedures.

To clear a controller reservation, activate the deadstart switch on the machine which is down.

To clear a unit reservation, perform one of the following procedures.

- On an 885 or 844 device that is connected to a 7155 controller, activate the deadstart switch on the machine which is down.
- On an 844 device that is not connected to a 7155 controller, toggle the OFF LINE/ON LINE switch on the back of the drive to OFF LINE and then back to ON LINE.
- If either of the preceding procedures cannot be performed, select the OP=R option to clear an 844 or 885 device reservation.

NOTE

Do not select the OP=R option unless the other procedures cannot be performed. It is recommended that all machines in the multmainframe environment be put in IDLE status or put in STEP mode when the OP=R option is selected.

Once the correct action has been taken, type

K.GO.

to continue processing. If the reservation is still not cleared, you are again notified. Repeat one of the steps above or type

K.OP=L

This directs MREC to ignore certain operations on the device. Processing may then continue.

A character set is composed of graphic and/or control characters. A code set is composed of codes used to represent each character within a character set.

A graphic character may be displayed at a terminal or printed by a line printer. Examples are the characters A through Z and the digits 1 through 9. A control character initiates, modifies, or stops a control operation. An example is the backspace character that moves the terminal carriage or cursor back one space. Although a control character is not a graphic character, a terminal may produce a graphic representation when it receives a control character.

All references within this manual to the ASCII character set or the ASCII code set refer to the character set and code set defined in the American National Standard Code for Information Interchange (ASCII, ANSI Standard X3.4-1977). References in this manual to the ASCII character set do not necessarily refer to the ASCII code set.

NOS supports the following character sets:

- CDC graphic 64- (or 63-) character set
- ASCII 128-character set
- ASCII graphic 64- (or 63-) character set
- ASCII graphic 95-character set

Each installation selects either the 64-character set or the 63-character set. The differences between the two are described under 63/64 Character Set Anomalies in this appendix. Any reference in this appendix to the 64-character set implies either the 63- or 64-character set unless otherwise stated.

NOS supports the following code sets:

- Display code
- 6/12 display code
- 12-bit ASCII code

Display code is a set of 6-bit codes from 00_g to 77_g.

The 6/12 display code is a combination of 6-bit codes and 12-bit codes. The 6-bit codes are 00_g through 77_g, excluding 74_g and 76_g. (Refer to Character Set Anomalies for the interpretation of the 00_g and 63_g codes.) The 12-bit codes begin with either 74_g or 76_g and are followed by a 6-bit code. Thus, 74_g and 76_g are considered escape codes and are never used as 6-bit codes within the 6/12 display code set. The 12-bit codes are 7401_g, 7402_g, 7404_g, 7407_g, and 7601_g through 7677_g. All other 12-bit codes (74xx_g and 7600_g) are undefined.

The 12-bit ASCII code is the ASCII 7-bit code (as defined by ANSI Standard X3.4-1977) right-justified in a 12-bit byte. Assuming that the bits are numbered from the right starting with 0, bits 0 through 6 contain the ASCII code, bits 7 through 10 contain zeros, and bit 11 distinguishes the 12-bit ASCII 0000_g code from the end-of-line byte. The 12-bit codes are 0001_g through 0177_g and 4000_g.

CHARACTER SET ANOMALIES

NOS interprets two codes differently when the installation selects the 63-character set rather than the 64-character set. In tables A-1 and A-2, the codes for the colon and percent graphic characters in the 64-character set are unshaded; the codes for the colon and percent graphic characters in the 63-character set are shaded.

If an installation uses the 63-character set, the colon graphic character is always represented by a 63_g code. However, if the installation uses the 64-character set, output of 6/12 display codes 7404_g or 00_g produces a colon. In time-sharing ASCII mode, a colon can be input only as a 7404_g 6/12 display code.

When using either the 63- or 64-character set, the use of undefined 6/12 display codes in output files produces unpredictable results and should be avoided.

Also, two 00_g codes may be confused with an end-of-line byte and should be avoided (refer to Card File Data Conversion in the NOS Reference Manual, Volume 1 for further explanation).

CHARACTER SET TABLES

This appendix contains character set tables for batch users and magnetic tape users. Table A-1 is for batch users. Table A-2 is a conversion table used to cross-reference 12-bit ASCII codes and 6/12 display codes and to convert ASCII codes from octal to hexadecimal.

Tables A-3, A-4, and A-5 list the magnetic tape codes and their display code equivalents.

The character set tables are designed so that the user can find the character represented by a code (such as in a dump) or find the code that represents a character. To find the character represented by a code, the user looks up the code in the column listing the appropriate code set and then finds the character on that line in the column listing the appropriate character set. To find the code that represents a character, he first looks up the character and then finds the code on the same line in the appropriate column.

BATCH USERS

Table A-1 lists the CDC graphic 64-character set, the ASCII graphic 64-character set, and the ASCII graphic 95-character sets. It also lists the code sets and card punch codes (026 and 029) that represent the characters.

The 64-character sets use display code as their code set; the 95-character set uses 12-bit ASCII code. The 95-character set is composed of all the characters in the ASCII 128-character set that can be printed at a line printer (refer to Line Printer Usage). Only 12-bit ASCII code files can be printed using the ASCII graphic 95-character set. To print a 6/12 display code file (usually created in time-sharing ASCII mode), the user must convert the file to 12-bit ASCII code. To do this, he issues the PCOPY control statement (refer to the NOS Reference Manual, Volume 1). The 95-character set is represented by 12-bit ASCII codes 0040₈ through 0176₈.

LINE PRINTER USE

The batch character set printed depends on the print train used on the line printer to which the file is sent. The following are the print trains corresponding to each of the batch character sets.

Character Set	Print Train
CDC graphic 64-character set	596-1
ASCII graphic 64-character set	596-5
ASCII graphic 95-character set	596-6

The characters of the default 596-1 print train are listed in the table A-1 column labeled CDC Graphic (64 Char); the 596-5 print train characters are listed in the table A-1 column labeled ASCII Graphic (64 Char); and the 596-6 print train characters are listed in the table A-1 column labeled ASCII Graphic (95 Char).

If a transmission error occurs when printing a line, the system prints the line again. The CDC graphic print train prints a concatenation symbol (⌘) in the first printable

column of a line containing errors. The ASCII print trains print an underline (⎵) instead of the concatenation symbol.

If an unprintable character exists in a line (that is, a 12-bit ASCII code outside of the range 0040₈ through 0176₈, the number sign (#) appears in the first printable column of a print line and a space replaces the unprintable character.

Table A-6 lists the frame and level configurations for the line printer format tape.

MAGNETIC TAPE USERS

Coded data to be copied from mass storage to magnetic tape is assumed to be represented in display code. NOS converts the data to external BCD code when writing a coded 7-track tape and to ASCII or EBCDIC code (as specified on the tape assignment statement) when writing a coded 9-track tape.

Because only 63 characters can be represented in 7-track even parity, one of the 64 display codes is lost in conversion to and from external BCD code. Figure A-1 shows the differences in conversion depending on the character set (63 or 64) which the system uses. In parentheses is the ASCII character for the specified character set. The output arrow shows how the display code changes when it is written on tape in external BCD. The input arrow shows how the external BCD code changes when the tape is read and converted to display code.

If a lowercase ASCII or EBCDIC code is read from a 9-track coded tape, it is converted to its uppercase 6-bit display code equivalent. To read and write lowercase ASCII or EBCDIC characters, the user must assign the tape in binary mode and perform his own conversion of the binary data.

Tables A-3 and A-4 show the character set conversions for 9-track tapes. Table A-3 lists the conversions to and from the ASCII character code and display code. Table A-4 lists the conversions between EBCDIC character code and display code. Table A-5 shows the character code conversions between external BCD and display code for 7-track tapes.

63-Character Set					
Display Code			External BCD		Display Code
00			16	(%)	00
33	(0)	Output →	12	(0)	33 (0)
63	(:)		12	(0)	33 (0)
64-Character Set					
Display Code			External BCD		Display Code
00	(:)		12	(0)	33 (0)
33	(0)	Output →	12	(0)	33 (0)
63	(%)		16	(%)	63 (%)

Figure A-1. Conversion Differences

TABLE A-1. BATCH CHARACTER SETS

CDC Graphic (64 Char)	ASCII Graphic (64 Char)	ASCII Graphic (95 Char)	Display Code	6/12 Display Code	12-Bit ASCII Code	Punch Code	
						026	029
: colon†	: colon†		00 †			8-2	8-2
Display code 00 is undefined at sites using the 63-character set.							
A	A	A	01	01	0101	12-1	12-1
B	B	B	02	02	0102	12-2	12-2
C	C	C	03	03	0103	12-3	12-3
D	D	D	04	04	0104	12-4	12-4
E	E	E	05	05	0105	12-5	12-5
F	F	F	06	06	0106	12-6	12-6
G	G	G	07	07	0107	12-7	12-7
H	H	H	10	10	0110	12-8	12-8
I	I	I	11	11	0111	12-9	12-9
J	J	J	12	12	0112	11-1	11-1
K	K	K	13	13	0113	11-2	11-2
L	L	L	14	14	0114	11-3	11-3
M	M	M	15	15	0115	11-4	11-4
N	N	N	16	16	0116	11-5	11-5
O	O	O	17	17	0117	11-6	11-6
P	P	P	20	20	0120	11-7	11-7
Q	Q	Q	21	21	0121	11-8	11-8
R	R	R	22	22	0122	11-9	11-9
S	S	S	23	23	0123	0-2	0-2
T	T	T	24	24	0124	0-3	0-3
U	U	U	25	25	0125	0-4	0-4
V	V	V	26	26	0126	0-5	0-5
W	W	W	27	27	0127	0-6	0-6
X	X	X	30	30	0130	0-7	0-7
Y	Y	Y	31	31	0131	0-8	0-8
Z	Z	Z	32	32	0132	0-9	0-9
0	0	0	33	33	0060	0	0
1	1	1	34	34	0061	1	1
2	2	2	35	35	0062	2	2
3	3	3	36	36	0063	3	3
4	4	4	37	37	0064	4	4
5	5	5	40	40	0065	5	5
6	6	6	41	41	0066	6	6
7	7	7	42	42	0067	7	7
8	8	8	43	43	0070	8	8
9	9	9	44	44	0071	9	9
+	+	+	45	45	0053	12	12-8-6
-	-	-	46	46	0055	11	11
*	*	*	47	47	0052	11-8-4	11-8-4

† The interpretation of this character or code may depend on its context. Refer to Character Set Anomalies elsewhere in this appendix.

TABLE A-1. BATCH CHARACTER SETS (Contd)

CDC Graphic (64 Char)	ASCII Graphic (64 Char)	ASCII Graphic (95 Char)	Display Code	6/12 Display Code	12-Bit ASCII Code	Punch Code	
						026	029
/	/	/	50	50	0057	0-1	0-1
(((51	51	0050	0-8-4	12-8-5
)))	52	52	0051	12-8-4	11-8-5
\$	\$	\$	53	53	0044	11-8-3	11-8-3
=	=	=	54	54	0075	8-3	8-6
space	space	space	55	55	0040	no punch	no punch
, comma	, comma	, comma	56	56	0054	0-8-3	0-8-3
. period	. period	. period	57	57	0056	12-8-3	12-8-3
≡ equiv.	# num. sign	# num. sign	60	60	0043	0-8-6	8-3
[l. bracket	[l. bracket	[l. bracket	61	61	0133	8-7	12-8-2
] r. bracket] r. bracket] r. bracket	62	62	0135	0-8-2	11-8-2
% †	% †	% †	63 †	63 †	0045	8-6	0-8-4
: colon	: colon	: colon	64	64	0072	8-7	8-2
≠	" quote	" quote	64	64	0042	8-4	8-7
⎯ underline	⎯ underline	⎯ underline	65	65	0137	0-8-5	0-8-5
∧	& ampersand	& ampersand	66	66	0041	11-0	12-8-7
^	& ampersand	& ampersand	67	67	0046	0-8-7	12
↑	' apostrophe	' apostrophe	70	70	0047	11-8-5	8-5
↓	? question	? question	71	71	0077	11-8-6	0-8-7
<	<	<	72	72	0074	12-0	12-8-4
>	>	>	73	73	0076	11-8-7	0-8-6
≤	@	@	74	74		8-5	8-4
≥	\ rev. slant	\ rev. slant	75	75	0134	12-8-5	0-8-2
ˆ circumflex	ˆ circumflex	ˆ circumflex	76	76		12-8-6	11-8-7
; semicolon	; semicolon	; semicolon	77	77	0073	12-8-7	11-8-6
		@		7401	0100		
		ˆ circumflex		7402	0136		
		: colon †		7404 †	0072		
		ˆ circumflex		7404 †	0045		
		' grave accent		7407	0140		
		a		7601	0141		
		b		7602	0142		
		c		7603	0143		
		d		7604	0144		
		e		7605	0145		
		f		7606	0146		
		g		7607	0147		

† The interpretation of this character or code may depend on its context. Refer to Character Set Anomalies elsewhere in this appendix.

TABLE A-1. BATCH CHARACTER SETS (Contd)

CDC Graphic (64 Char)	ASCII Graphic (64 Char)	ASCII Graphic (95 Char)	Display Code	6/12 Display Code	12-Bit ASCII Code	Punch Code	
						026	029
		h		7610	0150		
		i		7611	0151		
		j		7612	0152		
		k		7613	0153		
		l		7614	0154		
		m		7615	0155		
		n		7616	0156		
		o		7617	0157		
		p		7620	0160		
		q		7621	0161		
		r		7622	0162		
		s		7623	0163		
		t		7624	0164		
		u		7625	0165		
		v		7626	0166		
		w		7627	0167		
		x		7630	0170		
		y		7631	0171		
		z		7632	0172		
		{ left brace		7633	0173		
		vert. line		7634	0174		
		} right brace		7635	0175		
		~ tilde		7636	0176		

79AA2A
3 OF 3

TABLE A-2. ASCII TO 6/12 DISPLAY CODE CONVERSION

ASCII Character (128 Char)	12-Bit ASCII Code		6/12 Display Code	ASCII Character (128 Char)	12-Bit ASCII Code		6/12 Display Code
	Octal	Hex			Octal	Hex	
NUL	4000	00	7640	0	0060	30	33
SOH	0001	01	7641	1	0061	31	34
STX	0002	02	7642	2	0062	32	35
ETX	0003	03	7643	3	0063	33	36
EOT	0004	04	7644	4	0064	34	37
ENQ	0005	05	7645	5	0065	35	40
ACK	0006	06	7646	6	0066	36	41
BEL	0007	07	7647	7	0067	37	42
BS	0010	08	7650	8	0070	38	43
HT	0011	09	7651	9	0071	39	44
LF	0012	0A	7652	: colon †	0072	3A	7404 †
VT	0013	0B	7653	: colon	0072	3A	63
FF	0014	0C	7654	; semicolon	0073	3B	77
CR	0015	0D	7655	<	0074	3C	72
SO	0016	0E	7656	=	0075	3D	54
SI	0017	0F	7657	>	0076	3E	73
				?	0077	3F	71
DLE	0020	10	7660	@	0100	40	7401
DC1	0021	11	7661	A	0101	41	01
DC2	0022	12	7662	B	0102	42	02
DC3	0023	13	7663	C	0103	43	03
DC4	0024	14	7664	D	0104	44	04
NAK	0025	15	7665	E	0105	45	05
SYN	0026	16	7666	F	0106	46	06
ETB	0027	17	7667	G	0107	47	07
CAN	0030	18	7670	H	0110	48	10
EM	0031	19	7671	I	0111	49	11
SUB	0032	1A	7672	J	0112	4A	12
ESC	0033	1B	7673	K	0113	4B	13
FS	0034	1C	7674	L	0114	4C	14
GS	0035	1D	7675	M	0115	4D	15
RS	0036	1E	7676	N	0116	4E	16
US	0037	1F	7677	O	0117	4F	17
space	0040	20	55	P	0120	50	20
!	0041	21	66	Q	0121	51	21
" quote	0042	22	64	R	0122	52	22
# number sign	0043	23	60	S	0123	53	23
\$	0044	24	53	T	0124	54	24
% †	0045	25	63 †	U	0125	55	25
%	0045	25	7404	V	0126	56	26
& ampersand	0046	26	67	W	0127	57	27
' apostrophe	0047	27	70	X	0130	58	30
(0050	28	51	Y	0131	59	31
)	0051	29	52	Z	0132	5A	32
*	0052	2A	47	[left bracket	0133	5B	61
+	0053	2B	45	\ reverse slant	0134	5C	75
, comma	0054	2C	56] right bracket	0135	5D	62
-	0055	2D	46	^ circumflex	0136	5E	7402
. period	0056	2E	57	_ underline	0137	5F	65
/	0057	2F	50				

† The interpretation of this character or code may depend on its context. Refer to Character Set Anomalies elsewhere in this appendix.

TABLE A-2. ASCII TO 6/12 DISPLAY CODE CONVERSION (Contd)

ASCII Character (128 Char)	12-Bit ASCII Code		6/12 Display Code	ASCII Character (128 Char)	12-Bit ASCII Code		6/12 Display Code
	Octal	Hex			Octal	Hex	
` grave accent	0140	60	7407	p	0160	70	7620
a	0141	61	7601	q	0161	71	7621
b	0142	62	7602	r	0162	72	7622
c	0143	63	7603	s	0163	73	7623
d	0144	64	7604	t	0164	74	7624
e	0145	65	7605	u	0165	75	7625
f	0146	66	7606	v	0166	76	7626
g	0147	67	7607	w	0167	77	7627
h	0150	68	7610	x	0170	78	7630
i	0151	69	7611	y	0171	79	7631
j	0152	6A	7612	z	0172	7A	7632
k	0153	6B	7613	{ left brace	0173	7B	7633
l	0154	6C	7614	vertical line	0174	7C	7634
m	0155	6D	7615	} right brace	0175	7D	7635
n	0156	6E	7616	~ tilde	0176	7E	7636
o	0157	6F	7617	DEL	0177	7F	7637

79AA3A
2 OF 2

TABLE A-3. ASCII 9-TRACK CODED TAPE CONVERSION

Code Conversion†		Character and Code Conversion††		Display Code	
Code (Hex)	Character	Code (Hex)	Character	ASCII Character	Code (Octal)
20	space	00	NUL	space	55
21	!	7D	}	!	66
22	"	02	STX	"	64
23	#	03	ETX	#	60
24	\$	04	EOT	\$	53
25	%	05	ENQ	%	63
25	%	05	ENQ	space†††	55
26	&	06	ACK	&	67
27	'	07	BEL	'	70
28	(08	BS	(51
29)	09	HT)	52
2A	*	0A	LF	*	47
2B	+	0B	VT	+	45
2C	,	0C	FF	,	56
2D	-	0D	CR	-	46
2E	.	0E	SO	.	57
2F	/	0F	SI	/	50
30	0	10	DLE	0	33
31	1	11	DC1	1	34
32	2	12	DC2	2	35
33	3	13	DC3	3	36
34	4	14	DC4	4	37
35	5	15	NAK	5	40
36	6	16	SYN	6	41
37	7	17	ETB	7	42
38	8	18	CAN	8	43
39	9	19	EM	9	44
3A	:	1A	SUB	:	00††††
3A	:	1A	SUB	:	63
3B	;	1B	ESC	;	77
3C	<	7B	{	<	72
3D	=	1D	GS	=	54
3E	>	1E	RS	>	73
3F	?	1F	US	?	71
40	@	60	\	@	74

TABLE A-3. ASCII 9-TRACK CODED TAPE CONVERSION (Contd)

Code Conversion †		Character and Code Conversion ††		Display Code	
Code (Hex)	Character	Code (Hex)	Character	ASCII Character	Code (Octal)
41	A	61	a	A	01
42	B	62	b	B	02
43	C	63	c	C	03
44	D	64	d	D	04
45	E	65	e	E	05
46	F	66	f	F	06
47	G	67	g	G	07
48	H	68	h	H	10
49	I	69	i	I	11
4A	J	6A	j	J	12
4B	K	6B	k	K	13
4C	L	6C	l	L	14
4D	M	6D	m	M	15
4E	N	6E	n	N	16
4F	O	6F	o	O	17
50	P	70	p	P	20
51	Q	71	q	Q	21
52	R	72	r	R	22
53	S	73	s	S	23
54	T	74	t	T	24
55	U	75	u	U	25
56	V	76	v	V	26
57	W	77	w	W	27
58	X	78	x	X	30
59	Y	79	y	Y	31
5A	Z	7A	z	Z	32
5B	[1C	FS	[61
5C	\	7C		\	75
5D]	01	SOH]	62
5E	^	7E	~	^	76
5F	_	7F	DEL	_	65

† When these characters are copied from/to a tape, the characters remain the same and the code changes from/to ASCII to/from display code.

†† These characters do not exist in display code. Therefore, when the characters are copied from a tape, each ASCII character is changed to an alternative display code character. The corresponding codes are also changed. Example: When the system copies a lowercase a, 61 hexadecimal, from tape, it writes an uppercase A, 01 octal.

††† A display code space always translates to an EBCDIC space.

†††† Display code 00 is undefined at sites using the 63-character set.

TABLE A-4. EBCDIC 9-TRACK CODED TAPE CONVERSION

Code Conversion†		Character and Code Conversion††		Display Code	
Code (Hex)	Character	Code (Hex)	Character	ASCII Character	Code (Octal)
40	space	00	NUL	space	55
4A	¢	1C	IFS	[61
4B	.	0E	SO	.	57
4C	<	C0	{	<	72
4D	(16	BS	(51
4E	+	0B	VT	+	45
4F		D0	}	!	66
50	&	2E	ACK	&	67
5A	!	01	SOH]	62
5B	\$	37	EOT	\$	53
5C	*	25	LF	*	47
5D)	05	HT)	52
5E	;	27	ESC	;	77
5F	-	A1	~	^	76
60	-	0D	CR	-	46
61	/	0F	SI	/	50
6B	,	0C	FF	,	56
6C	%	2D	ENQ	%	63
6C	%	2D	ENQ	space†††	55
6D	-	07	DEL	-	65
6E	>	1E	IRS	>	73
6F	?	1F	IUS	?	71
7A	:	3F	SUB	:	00
7A	:	3F	SUB	:	63 ††††
7B	#	03	ETX	#	60
7C	@	79	\	@	74
7D	'	2F	BEL	'	70
7E	=	1D	IGS	=	54
7F	"	02	STX	"	64
C1	A	81	a	A	01
C2	B	82	b	B	02
C3	C	83	c	C	03
C4	D	84	d	D	04
C5	E	85	e	E	05
C6	F	86	f	F	06
C7	G	87	g	G	07

TABLE A-4. EBCDIC 9-TRACK CODED TAPE CONVERSION (Contd)

Code Conversion [†]		Character and Code Conversion ^{††}		Display Code	
Code (Hex)	Character	Code (Hex)	Character	ASCII Character	Code (Octal)
C8	H	88	h	H	10
C9	I	89	i	I	11
D1	J	91	j	J	12
D2	K	92	k	K	13
D3	L	93	l	L	14
D4	M	94	m	M	15
D5	N	95	n	N	16
D6	O	96	o	O	17
D7	P	97	p	P	20
D8	Q	98	q	Q	21
D9	R	99	r	R	22
E0	\	6A		\	75
E2	S	A2	s	S	23
E3	T	A3	t	T	24
E4	U	A4	u	U	25
E5	V	A5	v	V	26
E6	W	A6	w	W	27
E7	X	A7	x	X	30
E8	Y	A8	y	Y	31
E9	Z	A9	z	Z	32
F0	0	10	DLE	0	33
F1	1	11	DC1	1	34
F2	2	12	DC2	2	35
F3	3	13	TM	3	36
F4	4	3C	DC4	4	37
F5	5	3D	NAK	5	40
F6	6	32	SYN	6	41
F7	7	26	ETB	7	42
F8	8	18	CAN	8	43
F9	9	19	EM	9	44

[†] When these characters are copied from/to a tape, the characters remain the same (except EBCDIC codes 4A, 4F, 5A, and 5F) and the code changes from/to EBCDIC to/from display code.

^{††} These characters do not exist in display code. Therefore, when the characters are copied from a tape, each EBCDIC character is changed to an alternative display code character. The corresponding codes are also changed. Example: When the system copies a right brace (]), 7D hexadecimal, from tape, it writes an exclamation point (!), 66 octal.

^{†††} All EBCDIC codes not listed translate to display code 55g(space). A display code space always translates to an EBCDIC space.

^{††††} Display code 00 is undefined at sites using the 63-character set.

TABLE A-5. 7-TRACK CODED TAPE CONVERSIONS

External BCD	ASCII Character	Octal Display Code	External BCD	ASCII Character	Octal Display Code
01	1	34	40	-	46
02	2	35	41	J	12
03	3	36	42	K	13
04	4	37	43	L	14
05	5	40	44	M	15
06	6	41	45	N	16
07	7	42	46	O	17
10	8	43	47	P	20
11	9	44	50	Q	21
12 †	0	33	51	R	22
13	=	54	52	!	66
14	"	64	53	\$	53
15	@	74	54	*	47
16 †	%	63	55	'	70
17	[61	56	?	71
20	space	55	57	>	73
21	/	50	60	+	45
22	S	23	61	A	01
23	T	24	62	B	02
24	U	25	63	C	03
25	V	26	64	D	04
26	W	27	65	E	05
27	X	30	66	F	06
30	Y	31	67	G	07
31	Z	32	70	H	10
32]	62	71	I	11
33	,	56	72	<	72
34	(51	73	.	57
35	-	65	74)	52
36	#	60	75	\	75
37	&	67	76	^	76
			77	;	77

† Conversion of these codes depends on whether the tape is being read or written.

TABLE A-6. LINE PRINTER FORMAT TAPE CONFIGURATION

FRAME	Levels to be Punched											
	1	2	3	4	5	6	7	8	9	10	11	12
0	x	x	x	x	x	x	x	x	x	x	x	x
1												
2												
3			x									
4			x						x			
5			x									
6			x		x							
7			x									
8			x									
9			x									
10			x									
11			x									
12			x									
13			x									
14			x									
15			x									
16			x									
17			x									
18			x									
19			x									
20			x									
21			x									
22			x									
23			x									
24			x									
25			x									
26			x									
27			x									
28			x									
29			x									
30			x									
31			x									
32			x									
33			x									
34			x									
35			x									
36			x									
37			x									
38			x									
39			x									
40			x									
41			x									
42			x									
43			x									
44			x									
45			x									
46			x									
47			x									
48			x									
49			x									
50			x									
51			x									
52			x									
53			x									
54			x									
55			x									
56			x									
57			x									
58			x									
59			x									
60			x									
61			x									
62			x									
63			x									
64			x									
65			x									

FRAME	Levels to be Punched											
	1	2	3	4	5	6	7	8	9	10	11	12
66	x	x	x	x	x							
67												
68												
69												
70												
71												
72												
73												
74												
75												
76												
77												
78												
79												
80												
81												
82												
83												
84												
85												
86												
87												
88												
89												
90												
91												
92												
93												
94												
95												
96												
97												
98												
99												
100												
101												
102												
103												
104												
105												
106												
107												
108												
109												
110												
111												
112												
113												
114												
115												
116												
117												
118												
119												
120												
121												
122												
123												
124												
125												
126												
127												
128												
129												
130												
131												
132	x	x	x	x	x	x	x	x	x	x	x	x
133												
134	x	x	x	x	x	x	x	x	x	x	x	x

Cut the tape on the line at frame 134 and glue together. Overlap frames 0 and 132. After the tape is glued into a loop, be sure to repunch the holes in frame 129.

This appendix contains a sorted listing of all console messages and network messages which could be of importance to the operator. Each message is followed by an explanation of the message and/or the circumstances causing it to be issued, the recommended operator action, and the routine which issued the message. Messages beginning with numbers follow the alphabetical list.

Lowercase letters are used within a message to identify fields that are variable. All messages beginning with lowercase (variable) fields are listed alphabetically according to the first nonvariable field following the messages beginning with numbers.

The messages in this appendix may appear on the following displays.

- Job status (B) display.
- System dayfile (A) display.
- System error log dayfile (A,ERROR LOG) display.
- Resource mounting preview (E,P) display.
- Utility (K) display.
- Console display during deadstart.

Network and local operator (NOP/LOP) error messages can also be issued to a terminal user who has network/local operator privileges.

<u>MESSAGE</u>	<u>SIGNIFICANCE</u>	<u>ACTION</u>	<u>ROUTINE</u>
ABNORMAL OVDAT/DATA/type, DLSSTATE=n, BEGINNING ADDRESS = nnnnn.	Informative message indicating the type of OVDAT/DATA command that failed and the NS dump/load state after an NPU dump/load failure. type LOAD, START, or DUMP n = 0 Loading dump/load overlay 1 Starting dump/load sequence 2 Dumping coupler registers 3 Dumping macro memory 4 Loading dump bootstrap 5 Dumping register and micro memory 6 Phase 1 load 7 Phase 2 load 8 Awaiting LOAD/INIT nnnnn Hexadecimal beginning address taken from the OVDAT/DATA response.	Try a different CCP load file or consult customer engineer.	NS
ABORT OF CDCS DETECTED.	Self-explanatory.	None.	TAF
ACTIVE FILES ON EQxx CANNOT INITIALIZE.	Informative message indicating that mass storage device with EST ordinal xx has initialize status set but cannot be initialized because permanent files are active on that device. The initialize request will be honored when the active file count reaches zero.	When active file count reaches zero, REQUEST*K*DISPLAY message appears on B display and initialization of device can proceed.	MSI
ADL ASSIGNED PFN= filename UN= usernam.	Informative message indicating the file name and user name of the application definition language (ADL) file attached by MCS. filename File name usernাম User name	None.	MCS
ADL CREATED yy/mm/dd. hh.mm.ss.	Informative message indicating the creation date and time of application definition language (ADL) file.	None.	MCS
ADL NOT AVAILABLE PFN=filename, UN=usernam.	The system could not attach the named application definition language (ADL) file. filename File name usernাম User name	Assign correct file.	MCS
AIP LOAD ERROR.	During an attempt to load network AIP relocatable subroutines, a loader error was returned.	Inform site analyst.	IAFEX
AIP TOO LARGE FOR LOADING.	A fatal error occurred causing TAF to abort.	Inform site analyst. TWFA must be increased in deck COMKTAF.	TAF

<u>MESSAGE</u>	<u>SIGNIFICANCE</u>	<u>ACTION</u>	<u>ROUTINE</u>
ALARM ON PORT nn FRMHDR=hdr si/ei.	CCP received an abnormal frame on a port serviced by the X.25 Terminal Interface Program. nn Port identifier hdr Frame header si State identifier ei Event identifier	Inform site analyst.	CCP
ALARM ON PORT nn LCN=numb PKID=id CAUSE=cc DIAG=dd.	CCP received an abnormal packet on a port serviced by the X.25 Terminal Interface Program. nn Port identifier numb Logical connection number id Packet identifier cc Cause identifier (first byte after packet header) dd Diagnostic identifier (second byte after packet header) This message is generated as the result of a mismatch between the packet switching network and Network Definition Language parameters.	Inform site analyst.	CCP
ANOTHER RBF ALREADY NETTED ON.	Another copy of RBF has entered the network.	No action required. The second copy of RBF will be dropped automatically.	RBF
APP SENT BLK ON BROKEN CONNECTION.	Informative message indicating that an application has sent a block on a broken connection.	No action is required. NIP discards the block in question.	NIP
APPL. name,status,count	Application status message sent in response to a STATUS command, or when a significant change in status has occurred. name Name of application status Status of application DI Disabled EN Enabled AC Active DN Down count Number of active connections to this application	None. Check dayfile for other messages which might indicate a change in status, such as an application error, failure, or netoff.	CS
APPL - applnam INITIALIZED.	Informative message indicating that named application was started and is now active. applnam Application name	None.	MCS
APPL - applnam JOURNAL journal DISABLED.	Because of CIO errors or an invalid owner name, the recording of messages in the journal was disabled. applnam Application name journal Journal file name	Correct owner name if appropriate.	MCS

<u>MESSAGE</u>	<u>SIGNIFICANCE</u>	<u>ACTION</u>	<u>ROUTINE</u>
APPL - applnam MONITOR monitor DISABLED.	Because of CIO errors or an invalid owner name, the monitor file was disabled. applnam Application name monitor Monitor file name	Correct owner name if appropriate.	MCS
APPL - applnam PROG program CONNECTED.	Informative message indicating that a test mode program has connected to MCS. applnam Application name prognam Program name	None.	MCS
APPL - applnam PROG program DISCONNECT.	Informative message indicating that a test mode program has disconnected from MCS. applnam Application name prognam Program name	None.	MCS
APPL - applnam PROG program REVOKED.	Informative message indicating that MCS aborted the named program. applnam Application name prognam Program name	None.	MCS
APPL - applnam Q queuenam FLUSHED.	Informative message indicating that the named queue file has been moved to disk. applnam Application name queuenam Queue file name	None.	MCS
APPL - applnam Q queuenam PURGED.	Informative message indicating that the named queue file was purged because it could not be verified upon recovery. applnam Application name queuenam Queue file name	None.	MCS
APPL - applnam QUEUE queuenam IN CM.	Named disk queue file was moved to central memory because of an invalid owner name. applnam Application name queuenam Queue file name	Correct owner name.	MCS
APPL - applnam RECOVERED FILE filenam.	Informative message that is displayed for each file when the application is initiated. applnam Application name queuenam Queue file name	None.	MCS
APPL - applnam SHUTDOWN	Informative message indicating that the application was terminated successfully. applnam Application name	None.	MCS
APPL - applnam START FAILED, FILE BUSY.	Named application file is busy. This causes application initiation to be aborted. This message is preceded by a message specifying the name of the busy file. applnam Application name	Inform site analyst. Return the busy file and retry initiation.	MCS

<u>MESSAGE</u>	<u>SIGNIFICANCE</u>	<u>ACTION</u>	<u>ROUTINE</u>
APPL - applnam START FAILED, I/O ERROR.	Errors were encountered in trying to read application definition language (ADL) file for the named application. applnam Application name	Inform site analyst. Recreate ADL file.	MCS
APPL - applnam START FAILED, NO MEMORY.	No memory is available to start the application. applnam Application name	Retry later.	MCS
APPLICATION ALREADY RUNNING.	An attempt was made to start an application that was already active.	None.	MCS
APPLICATION ERROR - ec,name	An error condition was detected during processing of the application. ec Error condition 1 Unrecognizable ACN was returned 2 Unrecognizable ACT was returned on CON/REQ/N 3 Unrecognizable MINACN/MAXACN detected during NETON 4 Unknown application was attempting NETON action 5 Nonprivileged application was attempting actions reserved for privileged applications	Error codes 1 and 2 are nonfatal errors. If they occur repeatedly, drop the application. Error codes 3 through 5 are fatal errors. The application is aborted by NAM; no action is required.	CS
APPLICATION FAILURE	The application specified in the status message immediately preceding this message has failed.	Restart the application if desired.	CS
APPLICATION NETOFF	The application specified in the status message immediately preceding this message has terminated normally.	Restart the application if desired.	CS
ARGUMENT ERROR.	Dayfile message indicating that the parameter list on the ISF entry contained an illegal parameter.	Repeat the ISF entry with the correct parameter list.	ISF
ASSIGN DBFORM LOAD TAPE.	B-display message requesting that the operator mount either a DBFORM reformat load tape or the next tape in a sequence of load tapes.	Mount a DBFORM reformat load tape.	DBFORM
ASSIGN EQUIPMENT NUMBER xx.	B-display message requesting that the operator assign mass storage equipment with EST ordinal xx to DBFORM's control point.	Enter an n.ASSIGN command to assign the requested equipment to DBFORM.	DBFORM
ASSIGNED FOR DIAGNOSTICS, FILE lfn AT addr.	A MALET user attempted a CIO operation on a preassigned tape with file name lfn and FET address addr.	Enter only CIO operations that remove the file from the system tables (for example, RETURN or UNLOAD).	CIO

<u>MESSAGE</u>	<u>SIGNIFICANCE</u>	<u>ACTION</u>	<u>ROUTINE</u>
ATTACH ERROR ON - filename.	The transaction executive cannot attach the file filename under present conditions. This usually implies that the file does not exist or permission has not been given to the TAF user name.	Correct error and reinitialize executive, or contact site analyst.	TAF
ATTACH MODE MUST BE W, M, R, OR RM.	The mode parameter on the CRM statement must be one of the specified values.	Correct the mode parameter on the CRM statement or inform site analyst.	TAF
AUTO HOST INITIALIZATION-GO NOT REQUIRED	The NAM procedure file (NAMffff) which was specified during initialization initiated a job containing a GO directive. The GO directive causes processing to continue automatically and disallows any operator intervention during initialization. The default NCF and LCF as specified in the jobs initiated by NAMffff are used.	None.	CS
AUTO-RECOGNITION TERMINAL	An attempt to enable an auto-recognition terminal was unsuccessful. Necessary information was not specified in the LCF.	None. It is not possible to enable the terminal.	CS
BAD CCP - MISSING EOR	The CCP file being used by NS contains unrecognizable data. NS encountered an EOF instead of an EOR.	Assign a new CCP file (refer to n.CFO.CCP command in section 7), and reenble the NPU.	NS
BAD DIRECTORY ON ADL.	An incorrect application definition language (ADL) file was encountered during MCS initiation.	Inform site analyst. Recreate ADL file.	MCS
BAD DUMP INDEX, DUMP ABANDONED.	The dump index file NDA4IND which NS uses to find names for NPU dmp files contains invalid data.	Purge NDA4IND and all NPU dump files.	NS
BAD NETON STATUS	NS received an unrecognizable status when attempting a NETON action.	None. NS will abort and restart itself.	NS
BAD NETWORK BLOCK DISCARDED.	Informative message indicating that NIP has received a block from the network that it cannot recognize. NIP discards such blocks, and records in the dayfile the NAM block header word, followed by the network header word, followed by the text of the block. This message occurs when NAM stops running because of deadstart recovery or network shutdown for example, and the NPU remains active. With the host down, CCP places all upline messages in the input queue. When NAM is initialized again, all these messages are delivered to the host. NIP does not	If during NAM initialization, ignore. Otherwise, consult site analyst.	NIP

<u>MESSAGE</u>	<u>SIGNIFICANCE</u>	<u>ACTION</u>	<u>ROUTINE</u>
	recognize most, if not all, of these messages because logical links, supervisory links, and logical connections are not reestablished yet. Ignore this message during NAM initialization; however, if the network is up and running, then this message indicates an error has occurred in the network. The error is not serious and the network need not be taken down, unless the error occurs consistently.		
BAD VERIFICATION RECORD FILE LF=lfm. or BAD VERIFICATION RECORD FILE NF=lfm.	The NDL processor opened an existing local configuration file (LF) or network configuration file (NF) with the local file name indicated by lfm. This file did not contain a verification header record. This message is also issued at the end of a file creation job when fatal errors were detected during processing.	The unverifiable file should be recreated or a different file used for NDL processor input.	NDL
BAD VERIFICATION RECORD ON ADL.	An incorrect application definition language (ADL) file was encountered during MCS initiation.	Inform site analyst. Recreate ADL file.	MCS
BKF xx,nn.	System dayfile message indicating that the operator requested a backspace of nn logical files on the print file on BATCHIO equipment xx.	None.	QAP
BKP xx,nn.	System dayfile message indicating that the operator requested a backspace of nn sectors (PRUs) on the print file on BATCHIO equipment xx.	None.	QAP
BKR xx,nn.	System dayfile message indicating that the operator requested a backspace of nn logical records on the print file on BATCHIO equipment xx.	None.	QAP
BLANK LABELS DO NOT VERIFY.	This message can occur only during blank labeling of a tape and indicates that the tape label read does not match the label written.	Repeat the blank labeling operation or inform the site analyst.	BLANK
BLANK MESSAGE IGNORED	The local operator attempted to send a null or blank message to a single terminal or all the terminals on an NPU. The message is ignored.	None.	CS
BLOCK SEQUENCE ERROR, lfm AT addr.	For a specific block, the block number recorded on the tape did not match the block number expected by the system tape loader.	Perform either of the following actions. - Type GO. to continue deadstart. Further block checking is	DIO

<u>MESSAGE</u>	<u>SIGNIFICANCE</u>	<u>ACTION</u>	<u>ROUTINE</u>
		disabled and the information transferred from tape may not be valid. - Redeadstart using a different tape unit or a different deadstart tape.	
BLOCKAGE AMONG CM RESIDENT TASKS.	The sum of initial field lengths for the CM resident tasks exceeds the minimum size of total task area.	Correct error.	TAF
BREAK OUTSTANDING.	Informative message indicating that an application attempted to send a block on a connection which was not reset following a break or stop from the NPU.	None.	NIP
BUFFER CONTROL WORD ERROR.	Dayfile message indicating that the word count in the disk linkage is greater than 100B.	Inform site analyst.	SLL
Ccc DOWNED.	Magnetic tape channel cc has been logically turned off by the system.	Inform site analyst.	IMT
Ccc, MTS FIRMWARE LOAD ERRORS.	Unable to load magnetic tape controller firmware on channel cc.	Inform customer engineer.	IMT
Ccc, Tt ATS CONVERSION TABLE LOAD ERRORS. or Ccc, Tt MTS CONVERSION TABLE LOAD ERRORS.	Errors occurred in loading of conversion table. cc Channel number t Conversion table (one of the following). 1 ASCII table 2 EBCDIC table 3 BCD table	Inform site analyst.	IMT
CANNOT ALLOCATE DEVICE.	Cannot allocate a multispindle device for one of the following reasons. - Not enough spare spindles available - Spare spindles not up and allocatable - An attempt was made to allocate a nonremovable device	Perform one of the following. - Decrease pack count and enter GO. - Enter CLEAR to clear initialize status for the device.	MSI
CANNOT ENABLE npu.	The attempt to enable npu failed.	Verify that the trunk is operational. If npu is a remote NPU, load its SAM. After you load SAM, wait for the message NPU: npu,DI,node to appear before	NS

<u>MESSAGE</u>	<u>SIGNIFICANCE</u>	<u>ACTION</u>	<u>ROUTINE</u>
CANNOT LOAD	Several attempts to load the NPU were unsuccessful.	entering the ENABLE command. Otherwise, no action is required. Inform site analyst.	NS
CANNOT SEND MESSAGE TO PASSIVE DEVICE	The local operator attempted to send a message to a passive device (that is, a line printer, card reader, punch, or plotter).	No action is required. If desired, reenter command specifying name of an interactive (console) device.	CS
CANT DISABLE	Following an attempt to disable the trunk, an abnormal response was received.	None.	NS
CANT ENABLE	Following an attempt to enable the trunk, an abnormal response was received.	None.	NS
CARTRIDGE CONFLICT, X=x, Y=y. RESPOND GO TO ACKNOWLEDGE.	K-display message indicating that the cartridge storage unit was unable to place the cartridge into cubicle X=x, Y=y because another cartridge is already there. Both cartridges were placed in the lower I/O drawer. x X coordinate of the cubicle (0-57) y Y coordinate of the cubicle (0-36)	Enter K.m.GO to clear the message. Run ASLABEL to restore the cartridge to the cartridge storage unit (refer to the NOS System Maintenance Reference Manual). m Message ordinal	MSSEXEC
CARTRIDGE WEAR NOTED, X=x, Y=y. RESPOND GO TO ACKNOWLEDGE.	K-display message indicating that the cartridge in the mass storage transport has been read with two tracks automatically corrected. Normally this indicates wear of the recording surface. Schedule the cartridge for replacement. This message is written in the error log file also. x X coordinate of the cubicle (0-57) y Y coordinate of the cubicle (0-36)	Enter K.m.GO to clear the message. m Message ordinal	MSSEXEC
CCP ASSIGNED, PFN=filenam, UN=username	The CCP load file has been attached following a CCP command or, if not in response to a CCP command, the NPU load has started. filenam Name of CCP load file username User name under which CCP load file is stored	None.	NS
CCP FILE MUST BE ATTACHED FOR COMMAND	The network operator entered an OVERLAY command but a valid CCP file was not available.	Assign another CCP file and reenter the OVERLAY command.	NS

<u>MESSAGE</u>	<u>SIGNIFICANCE</u>	<u>ACTION</u>	<u>ROUTINE</u>
CCP/LCF CONFIGURATION MISMATCH	The line specified in the status message immediately preceding this diagnostic cannot be configured because CCP, as installed, cannot accept a port number as large as that given in the LCF, or because it does not include the TIP type given in the LCF.	None. Either CCP or LCF must be configured differently.	CS
CCP NOT AVAILABLE(,PFN=filenam,UN=userid)	The CCP load file to be used by NS could not be attached. If PFN and UN are not shown, a default CCP file was not specified by the installation. If the message	Assign another CCP file.	NS
	<p style="text-align: center;">ASSIGN VALID CCP FILE</p> <p>follows the original message, the current CCP file cannot be used for NPU loads.</p> <p>filenam Name of CCP load file</p> <p>userid User name under which CCP load file is stored</p>		
CCP VERSION 3.1,LEVEL nnnn,VAR mmmm	Informative message sent to the network operator following a successful NPU load indicating the version, level, and variant of the CCP software loaded in the NPU.	None.	NS
	<p>nnnn Level of CCP software</p> <p>mmmm Variant of CCP software</p>		
CE DIAGNOSTICS IN PROGRESS	A customer engineer is currently running diagnostics on the line which was specified in the status message immediately preceding this diagnostic.	No action is required. The local operator can attempt to enable the line at a later time.	CS
CHcc MAaaa - Ann.	Informative message indicating the controlware name and revision number for a 7054, 7154, or 7155 mass storage controller.	None.	OCI
	<p>cc Channel number</p> <p>aaa Type of controlware</p> <p>710 7054/7154 controlware</p> <p>401 7154 controlware</p> <p>721 7155 controlware</p> <p>nn Controlware revision number in octal</p>		
CHcc, Unuu - Szzzz.	Operator message indicating the status zzzz of unit uu on deadstart channel cc. This message is significant only if the deadstart process halts.	If hardware malfunction is suspected, inform customer engineer. Otherwise, try a different deadstart tape or disk unit.	DIO
CHANGED TLD DETECTED - filenam, userid.	An unrecognizable library directory format was encountered during a library directory update attempt.	Inform site analyst.	TAF

<u>MESSAGE</u>	<u>SIGNIFICANCE</u>	<u>ACTION</u>	<u>ROUTINE</u>
CHANNEL cc PARITY ERROR.	A parity error was detected on channel cc.	Inform site analyst and customer engineer.	SCE
CHECK *E,P* DISPLAY.	An error condition or request for operator action is currently being displayed on the E,P display. Operator action is required.	Bring E,P display to console screen and perform necessary action. (See status field of E,P display, section 4.)	IMT
CHECKPOINT ABORTED.	The checkpoint operation was aborted by the operator, possibly by dropping the control point at which ICK was executing following a device initialization.	Retry the checkpoint if desired.	ICK
CHECKPOINT COMPLETE.	Informative message indicating the checkpoint operation completed successfully.	None.	ICK
CLEAN READ/WRITE HEAD ASSEMBLY. RESPOND GO AFTER CLEANING.	Contamination of the read/write head in the mass storage transport is causing data errors.	Clean the read/write head assembly and respond K.m.GO to retry the operation. m Message ordinal	MSSEXEC
CLEANUP SALVARE FILE.	Informative message indicating that the time-sharing subsystem has begun to release all system resources currently assigned to terminals in the recovery state. This occurs only when the time-sharing subsystem is dropped (I.STOP. command).	None.	IAFEX TELEX
CLOSE DOOR ON UNIT.	K-display message indicating that a door (not I/O drawer) is open on the cartridge storage unit or mass storage transport (as indicated in line 1 of message).	Close the door.	MSSEXEC
CLOSE wwwww DRAWER.	K-display message indicating that the upper or lower (wwwww) drawer of the cartridge storage unit is open or not closed securely.	Close and lock the indicated I/O drawer. Push the position switch to IN.	MSSEXEC
CMC PARITY ERROR.	A central memory control (CMC) parity error has occurred.	Inform site analyst and customer engineer.	SCE
CMR LENGTH CHANGED.	The MST address determined by SET or the first word address of the RPL (REC) has changed on a recovery level deadstart. Possible causes include the following. - CMRDECK changes made on the initial deadstart were not made on the recovery deadstart. - MST pointer in EST was destroyed. - Condition of CM has changed (upgraded/downgraded) since initial deadstart.	Correct CMRDECK and retry recovery deadstart or perform an initial (level 0) deadstart.	SET REC

<u>MESSAGE</u>	<u>SIGNIFICANCE</u>	<u>ACTION</u>	<u>ROUTINE</u>
CMR OVERFLOW.	Operator message indicating that the address of the FNT/FST (file name/file status table) is greater than 12 bits.	Inform site analyst.	SET ICM
CMRDECK NOT ON TAPE.	Operator message indicating that the CMRDECK number specified on bits 3 through 8 of word 13 on the deadstart panel is not contained on the deadstart tape being used.	Reheadstart and select the correct CMRDECK number via deadstart panel switches or deadstart options display.	SET
COMMAND ABORTED.	The redefinition procedure for the equipment was terminated by the operator.	None. RDM	IRM
COMMAND ALREADY RECEIVED	Informative message indicating that the command just entered has already been entered and is currently being processed. The second entry of the command is ignored.	None.	NS CS
COMMAND ILLEGAL AFTER DISABLE NETWORK	An attempt was made to enter a command considered illegal at this time. All network/local operator commands (except STATUS,APPLS and STATUS,APPL=name) are illegal after the network has been disabled.	None.	CS
COMMAND ILLEGAL AFTER GO	The command which was just entered is illegal after the GO command has been entered.	None.	NS CS MCS
COMMAND ILLEGAL BEFORE GO	The command which was just entered is illegal before the GO command is entered.	No action is required. If desired, reenter command after network is initialized.	NS CS
COMMAND OUTSTANDING	Informative message indicating that a previous network/local operator command is still being processed.	Reenter the command after .. prompt.	CS
COMPARE FILE DEFINE ERROR. filenam FOR jobnam NOT STAGED.	The staging of file filenam for job jobnam was abandoned because of a system error.	Submit a Programming System Report (PSR) with supporting material.	EXSTGE
COMPARE FILE PURGE ERROR. filenam FOR jobnam NOT STAGED.	The staging of file filenam for job jobnam was abandoned because of a system error.	Submit a Programming System Report (PSR) with supporting material.	EXSTGE
COMPLETE.	Informative message indicating that the time-sharing subsystem termination is complete.	None.	IAFEX TELEX

<u>MESSAGE</u>	<u>SIGNIFICANCE</u>	<u>ACTION</u>	<u>ROUTINE</u>
CON xx.	System dayfile message indicating that the operator resumed printing on BATCHIO equipment xx.	None.	QAP
CON CSaaaa DSbbbb.	Operator message indicating that a connect reject error has occurred during an express deadstart dump. aaaa Channel converter status bbbb Controller status	Press carriage return to retry the dump operation.	EDD
CONFIG UTILITY COMPLETE.	All redefinition requested equipments have been processed.	None.	CONFIG
CONNECT REJECT, lfn AT addr.	Unable to connect unit.	Inform site analyst.	IMT
CONTINUING DESTROYS PFS RECOVERY OF DEVICE IMPOSSIBLE.	System residence was requested for device on which permanent files reside but device cannot be recovered as configured. For example, all packs of a multispindle device are not present in the configuration, packs are out of order, and so on. Preceded by message RECOVERY,dtxx. which indicates the equipment in error.	Inform site analyst; recommended action is one of the following. - Redeadstart without system on this device. - Correct configuration and redeadstart. - Type GO to initialize device with parameters defined in label. Deadstart continues and permanent files on device are lost.	RMS
COUPLER ENABLE/DISABLE ILLEGAL	The network operator tried to enable or disable a coupler which is illegal.	If the coupler should not be used, disable the NPU associated with the coupler.	NS
COUPLER ERROR-ec	An error was detected in the coupler. ec Error code 1 Activated channel empty too long 2 Channel active too long after function 3 Channel full after output 4 Coupler disabled 5 Coupler not responding 6 Error retry on input 7 Channel full after activated on output 8 Channel inactive after output 9 Channel full before function 10 Interrupt by channel disconnect 11 Change for wait NPU status too long	Inform customer engineer.	NS

<u>MESSAGE</u>	<u>SIGNIFICANCE</u>	<u>ACTION</u>	<u>ROUTINE</u>
	12 Invalid NPU status		
	13 NPU time-out		
	14 Inbound message too large		
	15 Abnormal coupler register contents		
	16 Reserved		
	17 NPU load memory compare error		
COUPLER UNAVAILABLE	The coupler defined in the NCF is either off or not defined in the EST.	Inform site analyst.	NS
CPxx,....	Refer to description of corresponding message beginning with EQ.		
CPxx, COMPARE ERROR.	Detected compare error on card punch with EST ordinal xx.	Job output must be repunched via DSD command RERUN (refer to section 3).	1CD
CPxx, FEED FAILURE.	Card punch with EST ordinal xx experiencing card feed failure.	Inform customer engineer.	1CD
CPU x P REGISTER PARITY ERROR.	A central processor P register parity error was detected on CPU x. x CPU number (0 or 1)	Inform site analyst and customer engineer.	SCE
CPUMTR ERROR EXIT.	CPUMTR has executed an error exit sequence. The exit mode condition bits of location zero of CMR contain the conditions causing CPUMTR to error exit.	Inform customer engineer. Redeadstart is necessary.	DSD
CRxx,....	Refer to description of corresponding message beginning with EQ.		
CRxx, ADVANCE 1 CD, RE-RD 3 CDS.	Card reader with EST ordinal xx has encountered a transmission parity error, an incomplete data transfer, or a binary checksum error.	1. Move back all cards in input hopper except first card in hopper (in the feed station). 2. Advance this card to output hopper by pressing RELOAD MEMORY while holding back remaining cards. (The input hopper must appear to be empty to the card reader.) 3. Place last three cards from output hopper in front of cards in input hopper. 4. Release cards in	1CD

<u>MESSAGE</u>	<u>SIGNIFICANCE</u>	<u>ACTION</u>	<u>ROUTINE</u>
CRxx, BINARY CARD ERROR.	Binary checksum error on card.	input hopper and press READY switch. Reread two cards.	2RC
CRxx, CHcc FCN ff REJECT.	Function reject error was detected on a 405 card reader. xx EST ordinal of device cc Channel number ff Function code	Inform customer engineer.	2RC
CRxx, CHcc, XMSN PARITY ERROR.	A transmission parity error was detected. xx EST ordinal of device cc Channel number	Inform customer engineer.	2RC
CRxx, COMPARE ERROR.	Compare error was detected on card reader with EST ordinal xx.	Reread deck.	1CD
CRxx, COMPARE ERROR.	Compare error was detected on card. xx EST ordinal of 405 card reader	Reread one card.	2RC
CRxx. RE-RD 1 CD. COMPARE ERROR.	Card compare error was detected on card reader with EST ordinal xx.	1. Remove first card in input hopper from feed station. 2. Place last card from output hopper in front of cards in input hopper (including card just removed from feed station). 3. Release cards in input hopper and press READY switch.	1CD
CRxx, RE-READ n CARD(S).	Error in cards read from card reader. xx EST ordinal of 405 card reader n Number of cards to be reread	Reread last n cards in the output stacker. If error still occurs, mark the card as mispunched and end job.	2RC
CRM(...parameter-list...)	This is a copy of a CRM statement that is in error. A subsequent message follows.	Inform site analyst.	TAF
CRM DATA MANAGER SUCCESSFULLY LOADED.	Self-explanatory.	None.	TAF
CS=ssss.	A coupler status error has occurred. ssss Status (four octal digits)	Redeadstart. If message persists, inform site analyst.	CDX
CS CODE LEV=yyy, LCF CODE LEV=xxx	Informative message indicating that the code level xxx at which the LCF was created is not the same as the present code level yyy of CS.	Rerun NDLP to create new LCF.	CS

<u>MESSAGE</u>	<u>SIGNIFICANCE</u>	<u>ACTION</u>	<u>ROUTINE</u>
CS FAILURE.	The Communication Supervisor (CS) has aborted. NAM takes an internal dump and terminates.	Reinitialize NAM. Supply dumps to site analyst.	NIP
CSxx,MSID id.	K-display message indicating that there is an error condition on the cartridge storage unit. xx EST ordinal id Cartridge storage unit identifier	Refer to the message(s) following this message for appropriate action.	MSSEXEC
CSM - ILLEGAL COMMUNICATION FUNCTION.	An illegal or unrecognizable request was received by the transaction executive from the CPU monitor.	Inform site analyst.	TAF
CSU x ADDRESS PARITY ERROR.	A central storage unit (CSU) address parity error was detected on CSU x. x CSU number (0 or 1)	Inform site analyst and customer engineer. (For further explanation and procedures, refer to S/C Register Error Detection, Appendix F.)	SCE
CSU EST ERROR xx. pfn FOR jobname NOT FOUND ON MSF. REPLY GO TO CONTINUE.	K-display message indicating that an error was detected on a cartridge label from the cartridge storage unit with EST ordinal xx. A probable cause of this error is entering the wrong identifier on the EST entry for the cartridge storage unit. pfn Permanent file name jobname Job name	Enter K.m.GO to clear the message. m Message ordinal	EXSTGE
CSU x FAULT.	A central storage unit (CSU) hardware error was detected on CSU x. x CSU number (0 or 1)	Inform site analyst and customer engineer. (For further explanation and procedures, refer to S/C Register Error Detection, Appendix F.)	SCE
CSU GROUP INITIALIZATION COMPLETE. CSUx, EST ORDINAL = yy.	The initialization of a CSU and its associated MSTs has been completed and cartridges in the output drawer have been processed.	None.	MSSEXEC
CSU INITIALIZATION ABANDONED. CSUx, EST ORDINAL = yy.	The initialization of a CSU was abandoned.	Inform site analyst.	MSSEXEC
CSU INITIALIZATION COMPLETE. CSUx, EST ORDINAL = yy.	The initialization of a CSU was completed.	None.	MSSEXEC
CSU id INPUT DRAWER d EMPTY.	A cartridge is needed from slot d of the input drawer of the cartridge storage unit (CSU id) to process the directive to ASLABEL or ASDEBUG. id CSU identifier (A through M)	Put the required cartridge into the input drawer slot.	ASLABEL ASDEBUG

<u>MESSAGE</u>	<u>SIGNIFICANCE</u>	<u>ACTION</u>	<u>ROUTINE</u>
CSU id INPUT DRAWER EMPTY.	A cartridge is needed from the input drawer of the cartridge storage unit (CSU id) to process the directive to ASLABEL or ASDEBUG. id CSU identifier (A through M)	Put the required cartridge into the input drawer.	ASLABEL ASDEBUG
CSU id OUTPUT DRAWER NOT EMPTY.	An empty slot in the output drawer of the cartridge storage unit (CSU id) is needed to process the directive to ASLABEL or ASDEBUG. id CSU identifier (A through M)	Remove cartridges from the output drawer.	ASLABEL ASDEBUG
CTxx,MSID id.	K-display message indicating that there is an error condition on the mass storage transport. xx EST ordinal id Mass storage transport identifier	Refer to the message(s) following this message for appropriate action.	MSSEEXEC
CTI CYLINDER OVERFLOW	CTI overflowed the area reserved on cylinder.	Redeadstart.	ICD
CVL CALL ERROR.	The validation routine, CVL, encountered one of the following errors while processing the CEVAL macro. - Recall bit was not set. - Illegal function number was specified. - Insufficient or improper combination of parameters was specified. - The user supplied mnemonic does not match the preassigned tape mnemonic when CVL was called by preassignment. - A tape was not preassigned when CVL was called by preassignment. - The user attempted to load tape controlware when CVL was called by preassignment. - A labeled tape was preassigned when CVL was called by preassignment.	Correct error and resubmit program.	CVL
D/L OVERLAY ACTIVE - TRY LATER	The network operator tried to load a diagnostic overlay but the NPU is either dumping or loading a remote NPU.	Reenter the OVERLAY command at a later time.	NS
DExx,Ccc,1,sec,ann,Stttt,Aaddr.	An error has been detected on extended core storage. The nature of the error is determined by examining each parameter in the message. xx EST ordinal of ECS unit cc Channel number l Link code used to associate multiple lines of messages occurring for the same error. s Error recovery status (one of the following) blank Status of error	Dump error log dayfile to printer (refer to description of ERRLOG, xx. command), and make it available to the customer engineer and/or site analyst.	6DE

<u>MESSAGE</u>	<u>SIGNIFICANCE</u>	<u>ACTION</u>	<u>ROUTINE</u>
	(recovered or unrecovered) has not been determined		
	R Error has been recovered		
	U Error is not recoverable		
	ec Error code (one of the following)		
	PE Parity error		
	AD Address error		
	a Type of operation (one of the following)		
	R Read		
	W Write		
	nn Retry count; error is considered irrecoverable after the following number of retries.		
	PE 10		
	AD 10		
	tttt Device status; implies there was an incomplete transfer if tttt does not indicate an error		
	addr Physical address at beginning of block		
DEADSTART DEVICE UNDEFINED.	The deadstart device is not defined in the CMRDECK.	Redeadstart and enter the equipment definition for the deadstart device at CMRDECK time.	SET
DEFINED DEVICE ALREADY EXISTS.	The device as defined during initialization already exists in the multimainframe environment.	Remove the duplicate device from the complex or change the parameters for the device being initialized.	MSI
DETECTED IN CLD.	Error was encountered during the building of the system library. Disk resident overlay (OVL) or absolute (ABS) program is not formatted correctly. Deadstart processing halts when this error is detected.	Redeadstart at a different tape density or use another tape unit or a different deadstart tape. If the error persists, inform the site analyst.	SYSEDIT
DETECTED IN DIRECTORY.	System file error occurred during the building of the system library. Start of the system library was not found. Deadstart processing halts when this error is detected.	Redeadstart at a different tape density or use another tape unit or a different deadstart tape. If the error persists, inform the site analyst.	SYSEDIT

<u>MESSAGE</u>	<u>SIGNIFICANCE</u>	<u>ACTION</u>	<u>ROUTINE</u>
DETECTED IN PLD.	System file error occurred during the building of the system library. Disk resident PP program or central memory resident PP program is not formatted correctly. Deadstart processing halts when this error is detected.	Redeadstart at a different tape density or use another tape unit or a different deadstart tape. If the error persists, inform the site analyst.	SYSEEDIT
DETECTED IN RCL.	Error was encountered during the building of the system library. Central memory resident overlay (OVL) or absolute (ABS) program is not formatted correctly. Deadstart processing halts when this error is detected.	Redeadstart at a different tape density or use another tape unit or a different deadstart tape. If the error persists, inform the site analyst.	SYSEEDIT
DETECTED IN RPL.	Error was encountered during the building of the system library. Central memory resident overlay (OVL) or absolute (ABS) program is not formatted correctly. Deadstart processing halts when this error is detected.	Redeadstart at a different tape density or use another tape unit or a different deadstart tape. If the error persists, inform the site analyst.	SYSEEDIT
DEVICE DOES NOT EXIST. REPLY GO TO RETRY - DROP TO OFF DEVICE.	K-display message indicating that the cartridge storage unit or the mass storage transport (as indicated in line 1 of message) is not configured as described in the EST entry.	Inform the site analyst and/or customer engineer. If the equipment can be attached, enter K.m.GO. Otherwise enter K.m.DROP. m Message ordinal	MSSEXEC
DEVICE NOT FIRST IN CHAIN.	To prevent destroying the integrity of a chained multispindle device, initialization will take place only if the device is first in the chain.	The only input accepted at this time is RERUN or CLEAR. Enter RERUN to update list (on K display) of devices with initialize status set. If first device in chain is not included in new list, enter CLEAR to clear initialize status for the current device.	MSI
DEVICE NOT FIRST IN CHAIN.	An equipment other than the first equipment in a linked device was entered to be reconfigured. Linked device reconfiguration preserved.	Enter the CLEAR or RERUN command and redefine the first equipment in the linked device.	CONFIG
DEVICE NOT READY. REPLY GO TO RETRY - DROP TO OFF DEVICE.	K-display message indicating that the cartridge storage unit or mass storage transport (as indicated in line 1 of message) returned a NOT READY response.	Either make the device ready and enter K.m.GO or enter K.m.DROP to logically turn off the	MSSEXEC

<u>MESSAGE</u>	<u>SIGNIFICANCE</u>	<u>ACTION</u>	<u>ROUTINE</u>
DEVICE NOT REMOVABLE.	A nonremovable device was selected for chaining in a multispindle string. Before initialization and chaining can be performed, it is required that all physical units to be included in the multispindle string be defined as removable.	device. m Message ordinal Enter CLEAR to clear initialize status for nonremovable device.	MSI
DEVICE SET OFF - DEVICE UNAVAILABLE. RESPOND GO TO ACKNOWLEDGE.	K-display message indicating that the cartridge storage unit or mass storage transport (as indicated by line 1 of this message) is being used through another interface, is off-line, is turned off, or is inoperative. The EST entry is set to OFF.	Enter K.m.GO to clear the message. m Message ordinal	MSSEXEC
DEVICE TURNED OFF. RESPOND GO TO ACKNOWLEDGE.	K-display message indicating that the cartridge storage unit or mass storage transport (as indicated in line 1 of message) has its EST entry turned off.	Call customer engineer and enter K.m.GO. On a cartridge storage unit, check for cartridges that are out of position before using again. m Message ordinal	MSSEXEC
DIxx,Ccc,l,sec,ann,Stttt, FNqqqq. or DIxx,Ccc,l,sec,ann,Stttt,Uuu Cyyy Sttss.	An error has been detected on mass storage device with EST ordinal xx. The message as illustrated indicates a half track 844-21 disk. Any of the following device types can appear in place of DI: DJ (half track 844-41/44 disk), DK (full track 844-21 disk), DL (full track 844-41/44 disk), DM (half track 885 disk), or DQ (full track 885 disk). The nature of the error is determined by examining each parameter in the message. xx EST ordinal of 844/885 disk cc Channel number l Link code used to associate multiple lines of messages occurring for the same error. s Error recovery status (one of the following) blank Status of error (recovered or unrecovered) has not been determined R Error has been recovered U Error is irrecoverable ec Error code (one of the following) PE Parity error/checkword error AD Address error ST Device status error FT Function timed out with no	Dump error log dayfile to printer (refer to description of ERRLOG, xx. command), and make it available to the customer engineer and/or site analyst.	7DI

MESSAGESIGNIFICANCEACTIONROUTINE

response
 RS Device reserved
 CR Controller reserved
 NR Device not ready
 a Type of operation (one of the following)
 R Read
 W Write
 nn Retry count; error is considered irrecoverable after the following number of retries.
 PE 10
 AD 10
 ST 64
 FT 3
 RS 64
 CR 64
 NR indefinite
 tttt Device status - implies there was an incomplete transfer if status does not indicate an error
 qqqq Function which timed out
 uu Physical unit
 yyyy Physical cylinder
 tt Physical track
 ss Physical sector

DIxx,Lsss.....sss.
 DIxx,Lsss.....sss.
 DIxx,Lsss.....sss.

This message may accompany the DIxx,Ccc,l,sec,... error log message to provide additional status information. The message as illustrated indicates a half track 844-21 disk. Any of the following device types can appear in place of DI: DJ (half track 844-41/44 disk), DK (full track 844-21 disk), DL (full track 844-41/44 disk), DM (half track 885 disk), or DQ (full track 885 disk).

xx EST ordinal of 844/885 disk
 s...s First and second lines of 32 digits and third line of 16 digits containing detail status. Refer to the appropriate disk storage subsystem operation and programming reference manual for a description of these bits.

Dump error log dayfile to printer (refer to description of ERRLOG, xx. command), and make it available to the customer engineer and/or site analyst.

7SI

DIxx, Uuu, PS=serialn.

Informative message indicating the pack serial number of the pack mounted on the device defined by EST ordinal xx. The message as illustrated indicates a half track 844-21 disk. Any of the following device types can appear in place of DI: DJ (half track 844-41/44 disk), DK (full track 844-21 disk), DL (full track 844-41/44

None.

OPI

<u>MESSAGE</u>	<u>SIGNIFICANCE</u>	<u>ACTION</u>	<u>ROUTINE</u>
	disk), DM (half track 885 disk), or DQ (full track 885 disk). xx EST ordinal of 844/885 disk uu Physical unit number on which the pack is mounted serialn Pack serial number		
DJ...	Refer to description of the corresponding message beginning with DI or EQ.		
DK...	Refer to description of the corresponding message beginning with DI or EQ.		
DKxx, NO FT CONTROLLER.	The equipment with EST ordinal xx has been defined as a full track 844-21 disk but there is no 7154 full track controller present.	If a full track controller is not present, redefine the device as a half track device. If a full track controller is actually present but not detected, ensure the correct controlware is specified on the LBC CMRDECK entry.	STL BCL
DKxx, 2X PPU REQUIRED.	The equipment with EST ordinal xx requires 2X PPUs but 2X PPUs do not exist.	Enable 2X PPUs or redefine the device as a half track device.	STL BCL
DL...	Refer to description of corresponding message beginning with DI or EQ.		
DLxx, NO FT CONTROLLER.	The equipment with EST ordinal xx has been defined as a full track 844-41/44 disk but there is no 7154 full track controller present.	If a full track controller is not present, redefine the device as a half track device. If a full track controller is actually present but not detected, ensure the correct controlware is specified on the LBC CMRDECK entry.	STL BCL
DLxx, 2X PPU REQUIRED.	The equipment with EST ordinal xx requires 2X PPUs but 2X PPUs do not exist.	Enable 2X PPUs or redefine the device as a half track device.	STL BCL
DM...	Refer to description of corresponding message beginning with DI or EQ.		

<u>MESSAGE</u>	<u>SIGNIFICANCE</u>	<u>ACTION</u>	<u>ROUTINE</u>
DN CANNOT BE ZERO.	DN=0 was entered to clear a duplicate device number error. The device number (DN) cannot be zero for a family type device.	Enter a nonzero value to continue or enter GO to override the error.	MSI
DPxx,Ccc,l,sec,ann,Stttt,FNqqq. or DPxx,Ccc,l,sec,ann,Stttt,Aaddr,Wwww DPxx,Ccc,l,Gggg...g. DPxx,Ccc,l,Bbbb...b. or DPxx,Ccc,l,sec,ann,Stttt,Aaddr,Wwww DPxx,Ccc,l,ddd...d.	An error has been detected on distributive data path (DDP). The nature of the error is determined by examining each parameter in the message. xx EST ordinal of DDP/ECS cc Channel number l Link code used to associate multiple lines of messages occurring for the same error. s Error recovery status (one of the following) blank Status of error (recovered or unrecovered) has not been determined R Error has been recovered u Error is not recoverable ec Error code (one of the following) PE Parity error/checkword error AD Address error ST Device status error FT Function time out a Type of operation (one of the following) R Read W Write nn Retry count; error is considered irrecoverable after the following number of retries. PE 1 AD 10 ST 64 FT 3 tttt Device status; implies there was an incomplete transfer if status does not indicate an error qqqq Function rejected addr Physical address at beginning of block www Word count of transfer q...q Good data which was transferred b...b Bad data which was transferred d...d State of data transferred is unknown	Dump error log dayfile to printer (refer to description of ERRLOG, xx. command), and make it available to the customer engineer and/or site analyst.	7EP 7MP
DQ...	Refer to description of corresponding message beginning with DI or EQ.		

<u>MESSAGE</u>	<u>SIGNIFICANCE</u>	<u>ACTION</u>	<u>ROUTINE</u>
DQxx, 2X PPU REQUIRED.	The equipment with EST ordinal xx requires 2X PPUs but 2X PPUs do not exist.	Enable 2X PPUs or redefine the device as a half track device.	STL BCL
DRIVER STACK OVERFLOW.	Space sufficient to allocate the required stack area was not available. An internal change to IAF is necessary.	Inform site analyst.	IAFEX
DROP IGNORED.	K-display message indicating that a K.DROP or K.DDROP command was attempted but could not be performed because of one of the following. - The task was in recall. - There was an outstanding time-sharing request which was denied by the time-sharing executive (TAF/TS only). - The command was attempted during the initial load of the task.	Reenter K.DROP or K.DDROP command. When recall operation, time-sharing request, or initial load is complete, the command will be accepted and the task aborted.	TAF
DSD WAIT MTR.	A software or hardware failure has occurred. If the system has stopped running, there is a communication failure with CPU and PP monitor.	Inform site analyst. If system processing has stopped, deadstart is necessary. If the system continues to run, possible causes (such as PP saturation) should be investigated.	DSD
DUAL AND TRACE FLAGS FOR FILE filename.	It is illegal to dual-record and trace the same file.	Correct error and reinitialize executive (TAF) or rerun job (BDMI).	TAF BDMI
DUAL RECORDED FILE filename NOT ATTACHED.	The user has neglected to attach file filename.	Batch data manager users must attach all data files.	TAF BDMI
DUMP npu DISABLED	Informative message indicating that a core dump of the NPU npu will not be taken during the next NPU load procedure. This message appears in response to the command DUMP,npu,OFF.	None.	NS
DUMP npu ENABLED	Informative message indicating that a core dump of the NPU npu will be taken during the next NPU load procedure. This message appears in response to the command DUMP,npu,ON.	None.	NS
DUMP FLAGS FOR ALL NPUS SET ON	Informative message indicating that core dumps for all NPUs have been automatically enabled. This message appears at network initiation when the previous network run terminated abnormally.	To disable a particular NPU dump, enter the command DUMP,npu,OFF. npu Name of NPU	NS

<u>MESSAGE</u>	<u>SIGNIFICANCE</u>	<u>ACTION</u>	<u>ROUTINE</u>
DUMP OF node/dmp COMPLETE	Informative message indicating that the dump of the specified node is complete. node Name of NPU/node id of NPU dmp Name of the dump	None.	NS
DUMP OR DROP.	Operator message indicating that export has detected an abnormal condition which will not allow continued operation.	Inform site analyst; recommended action is to dump Export field length (via DMP control statement entered under DIS control) and then drop EXPORTL (via DSD command n.STOP.).	ILS
DUMPS LOST	K-display message indicating that requests to dump the field length of the transaction facility have been ignored because the global task dump limit (GTDL) is not greater than zero.	Refer to the TAF K.DUMPLIM command; this command should be used only under the direction of the central site TAF systems analyst.	TAF
DUP NAME name.	The program or overlay name already exists on the disk.	Press the space bar to continue loading. name is not replaced with the program on the tape.	TDX
DUPLICATE BITS IN MASK.	Device mask for the family has duplicate bits set. This destroys the integrity of the permanent file system by creating an ambiguous mapping of user indexes.	Correct and enter GO, or enter GO to override. This is the only input accepted at this time.	MSI
DUPLICATE DATA BASE IN TCF - xx.	Active data base identifier, xx, in the TCF is not unique.	Fix TCF so that xx appears only once among active (ON) DMS statements.	TAF
DUPLICATE DN.	Device number specified is the same as that specified for another device in the family.	Correct and enter GO, or enter GO to override. This is the only input accepted at this time.	MSI
DUPLICATE NS NETON	A second copy of the Network Supervisor (NS) attempted to perform a NETON action.	Drop the duplicate NS job (refer to n.KILL command in section 3). If NS aborts, it automatically attempts to restart.	NS
DUPLICATE PN.	Another pack in the system has the same name.	Change the pack name or remove the other device from the system.	MSI

<u>MESSAGE</u>	<u>SIGNIFICANCE</u>	<u>ACTION</u>	<u>ROUTINE</u>
DURATION TIME TERMINATE.	Time-sharing subsystem has aborted in less than 60 seconds after initialization or last recovery.	Inform site analyst.	IAFEX TELEX
ECeeee,ann,s,addr,Ccccccc,Wwwwww. ECeeee,ann,s,Bbbb...b. ECeeee,ann,s,Gggg...g.	An error has been detected on ECS. The nature of the error is determined by examining each parameter in the message. eeee Error incident number a Type of operation (one of the following) R Read W Write nn Retry count s Error recovery status (one of the following) R Error has been recovered S Error has been recovered by single word transfers U Error has not been recovered addr ECS address of block transfer cccccc CM address of block transfer wwwwww Word count of block transfer bbb...b Bad data which was transferred ggg...g Good data which was transferred	Inform site analyst.	IMC
ECS ERROR.	An extended core storage (ECS) hardware error has occurred.	Inform site analyst and customer engineer.	SCE
ECS LABEL TRACK NOT FOUND.	Operator message indicating that CPUMTR preset routine was unable to find a valid label track in ECS. Recovery is impossible.	Inform site analyst. It is necessary to deadstart with INITIALIZE and PRESET.	CPUMTR RMS
ECS PE ON ROLLOUT.	An unrecovered ECS parity error occurred during the rollout of a job with user ECS assigned.	None.	IRO
ECS READ ERROR.	Self-explanatory.	Inform customer engineer.	TAF
ECS READ/WRITE PARITY ERRORS.	Operator message indicating that error exit was taken during execution of RE/WE instructions in CPUMTR preset. Recovery is impossible.	Inform customer engineer.	CPUMTR RMS
ECS TASK tasknam NOW MS RESIDENT.	Task tasknam could not be loaded into ECS because of insufficient storage. It is loaded into mass storage.	If task must be resident in ECS, more ECS space must be allocated for the TAF user name. Refer to the NOS Installation Handbook.	TAF

<u>MESSAGE</u>	<u>SIGNIFICANCE</u>	<u>ACTION</u>	<u>ROUTINE</u>
ECS WRITE PARITY ERROR ENCOUNTERED.	Self-explanatory.	Inform customer engineer.	TAF
EDT CARD NOT USED FOR CRM.	The xxJ file cannot contain an EDT statement for TAF CRM.	Remove the EDT statement from the xxJ file or inform site analyst.	TAF
EMPTY LOWER DRAWER.	K-display message indicating that the lower drawer of the cartridge storage unit should be emptied.	Remove all cartridges from the octapack on the lower drawer. Push the position switch to IN.	MSSEXEC
END xx,nn.	System dayfile message indicating that the operator ended BATCHIO equipment xx for nn copies.	None.	QAP
END OF DAT TRACK CHAIN.	An attempt to introduce a new shared device into the multiframe environment failed. The machine which preset ECS did not reserve enough tracks in the DAT chain. Configuration error status is set by CMS.	Redeadstart removing some shared equipment from the configuration or preset ECS to accommodate more shared devices.	CMS RMS
ENTRY FOUND IN EST.	An equipment was later found in the system tables after CVL initially replied to MALET that the equipment was not in the system tables.	Correct control statement parameters and reenter.	CVL
EQxx Annnn PF RECOVERY ERROR.	In the recovery of mass storage device xx, an unidentified preserved file or preserved file with a system sector error was encountered. xx EST ordinal of device being recovered nnnn First track of file	Supply dumps of dayfile and error log to site analyst.	REC CMS
EQxx Annnn Ttttt Sssss LINKAGE ERROR.	A length or linkage error was detected while recovering preserved files on equipment xx. nnnn First track of file tttt EOI track ssss EOI sector	To alter EOI of the file and proceed with recovery, enter n.GO. where n is the system control point number. To terminate recovery of the device, enter n.NOGO.	CMS REC
EQxx,BAD SYSTEM SECTOR.	An irrecoverable error occurred during the reading of the system sector of the print or punch file. xx EST ordinal of device.	Inform site analyst.	I10 XSP

<u>MESSAGE</u>	<u>SIGNIFICANCE</u>	<u>ACTION</u>	<u>ROUTINE</u>
EQxx BUSY ON ID=id.	An attempt has been made to initialize a shared device which is still being accessed by another machine. xx EST ordinal of device id Machine ID of mainframe on which device is still active	Clear initialize request or unload device on mainframe id. If the initialize request is cleared, CMS must be dropped from the control point.	IMS
EQxx,CHcc Adddd INCOMPLETE TRANSFER.	An incomplete data transfer was detected by a local batch equipment driver. EQ One of the following equipment types. CP 415 card punch CR 405 card reader LP Any line printer LR 580-12 line printer LS 580-16 line printer LT 580-20 line printer xx EST ordinal of local batch equipment cc Channel number dddd Octal byte count not transferred	Inform customer engineer.	QAP
EQxx,CHcc CONTROLLER HUNG BUSY.	The specified local batch controller did not drop BUSY status. EQ One of the following equipment types. CP 415 card punch CR 405 card reader LP Any line printer LR 580-12 line printer LS 580-16 line printer LT 580-20 line printer xx EST ordinal of local batch equipment cc Channel number	Inform customer engineer.	QAP
EQxx,CHcc, CONTROLLER RESERVED.	K-display message indicating that equipment xx could not be accessed because controller was reserved. xx EST ordinal of device cc Channel number	Refer to section 8 for possible action. Inform site analyst.	MREC
EQxx,CHcc Emmmm PFC ERROR.	Detected PFC error on the specified local batch equipment. EQ One of the following equipment types. LR 580-12 line printer LS 580-16 line printer LT 580-20 line printer xx EST ordinal of local batch equipment cc Channel number mmmm Maintenance status; bits 10 and 9 as follows. 01 Valid format code was set but is not in PFC buffer 10 Internal PFC parity error	Inform customer engineer.	QAP

<u>MESSAGE</u>	<u>SIGNIFICANCE</u>	<u>ACTION</u>	<u>ROUTINE</u>
EQxx,CHcc Fffff FUNCTION TIMEOUT.	<p>11 PFC load overflow</p> <p>No response (inactive) was received after a function code was issued to the specified local batch equipment (converter and equipment status unavailable).</p> <p>EQ One of the following equipment types.</p> <p>CP 415 card punch</p> <p>CR 405 card reader</p> <p>LP Any line printer</p> <p>LR 580-12 line printer</p> <p>LS 580-16 line printer</p> <p>LT 580-20 line printer</p> <p>xx EST ordinal of local batch equipment</p> <p>cc Channel number</p> <p>ffff Function code</p>	Inform customer engineer.	QAP ICD
EQxx,CHcc Fffff REJ Paaaa,Cbbbb,Emmmm.	<p>Function reject or transmission parity error was detected on the specified local batch equipment.</p> <p>EQ One of the following equipment types.</p> <p>CP 415 card punch</p> <p>CR 405 card reader</p> <p>LP Any line printer</p> <p>LR 580-12 line printer</p> <p>LS 580-16 line printer</p> <p>LT 580-20 line printer</p> <p>xx EST ordinal of local batch equipment</p> <p>cc Channel number</p> <p>ffff Function code</p> <p>aaaa Driver (ICD) address</p> <p>bbbb Converter status</p> <p>mmmm Equipment status</p>	Inform customer engineer.	QAP ICD
EQxx,CHcc, PRINT ERROR LIMIT EXCEEDED.	<p>Maximum number of consecutive print errors was detected on line printer xx.</p> <p>EQ One of the following equipment types.</p> <p>LP Any line printer</p> <p>LR 580-12 line printer</p> <p>LS 580-16 line printer</p> <p>LT 580-20 line printer</p> <p>xx EST ordinal of line printer</p> <p>cc Channel number</p>	Inform customer engineer.	ICD QAP
EQxx,CHcc RESERVED.	<p>The specified local batch equipment is reserved and cannot be connected on channel cc.</p> <p>EQ One of the following equipment types.</p> <p>CP 415 card punch</p> <p>CR 405 card reader</p> <p>LP Any line printer</p> <p>LR 580-12 line printer</p> <p>LS 580-16 line printer</p> <p>LT 580-20 line printer</p>	Inform customer engineer.	110

<u>MESSAGE</u>	<u>SIGNIFICANCE</u>	<u>ACTION</u>	<u>ROUTINE</u>
EQxx,CHcc TURNED OFF.	<p>xx EST ordinal of local batch equipment cc Channel number</p> <p>The specified local batch equipment was logically turned off (OFF status set in EST). This message is preceded in the error log by a message for the same equipment which specifies the failing condition.</p> <p>EQ One of the following equipment types. CP 415 card punch CR 405 card reader LP Any line printer LR 580-12 line printer LS 580-16 line printer LT 580-20 line printer</p> <p>xx EST ordinal of local batch equipment cc Channel number</p>	Inform customer engineer.	QAP
EQxx,CHECK PAPER ALIGNMENT.	<p>I-display message informing operator that during the processing of the V carriage control character, a nonstandard size PFC array was encountered.</p> <p>EQ One of the following equipment types. LR 580-12 line printer LS 580-16 line printer LT 580-20 line printer</p> <p>xx EST ordinal of local batch equipment</p>	<p>Check the paper alignment on the 580 line printer indicated and realign if necessary. Enter the command CONTINUExx. (refer to BATCHIO Equipment Commands in section 3) to complete processing of the job.</p>	ICD
EQxx,COMPARE ERROR.	Compare error was detected.	Inform customer engineer.	QAP
EQxx,DAF INTERLOCKS NOT CLEARED.	A permanent file catalog size error condition exists on device with EST ordinal xx causing interlocks in the system sectors of direct access files to not be cleared.	Inform site analyst.	IMR
EQxx nnnn DIRECT ACCESS FILE ERRORS.	Number of direct access files on mass storage device with EST ordinal xx that could not be recovered during mass storage device recovery (performed during deadstart or when a removable device is introduced into the system). The files in error are identified by LENGTH ERROR messages. In addition, the number of files in error (nnnn) should equal the number of LENGTH ERROR messages issued.	Inform site analyst; files should either be reloaded or redefined (refer to description of LENGTH ERROR message for additional information).	REC CMS
EQxx nnnn DIRECT ACCESS FILES RECOVERED.	Informative message indicating the number (nnnn) of direct access files that were successfully recovered on mass storage device with EST ordinal xx. Mass storage device recovery is performed during system	None.	REC CMS

<u>MESSAGE</u>	<u>SIGNIFICANCE</u>	<u>ACTION</u>	<u>ROUTINE</u>
EQxx EQyy CONFLICTING DN.	<p>deadstart or when a removable device is introduced into the system.</p> <p>Two devices in the same family have the same device number and the system library resides on one of them. xx and yy are the EST ordinals of these devices. Recovery is impossible.</p> <p>This message is preceded by the message RECOVERY, dtxx. which indicates the equipment that is in error.</p>	<p>Inform site analyst; recommended action is one of the following.</p> <ul style="list-style-type: none"> - Remove one of the specified devices and reeadstart. - Rereadstart and logically turn off one of the specified devices (via CMRDECK entry). 	RMS
EQxx EQyy CONFLICTING PN.	<p>Two auxiliary devices have the same pack name and the system library resides on one of them. xx and yy are the EST ordinals of these devices. Recovery is impossible.</p> <p>This message is preceded by the message RECOVERY, dtxx. which indicates the equipment that is in error.</p>	<p>Inform site analyst; recommended action is one of the following.</p> <ul style="list-style-type: none"> - Remove one of the specified devices and reeadstart. - Rereadstart and logically turn off one of the specified devices (via CMRDECK entry). 	RMS
EQxx EQyy CONFLICTING UM.	<p>Two devices in the same family have the same bits set in the device mask, and the system library resides on one of them. xx and yy are the EST ordinals of these devices. Recovery is impossible.</p> <p>This message is preceded by the message RECOVERY, dtxx. which indicates the equipment that is in error.</p>	<p>Inform site analyst; recommended action is one of the following.</p> <ul style="list-style-type: none"> - Remove one of the specified devices and reeadstart. - Rereadstart and logically turn off one of the specified devices (via CMRDECK entry). 	RMS
EQxx,FEED FAILURE.	<p>A card feed problem was detected.</p>	<p>Contact customer engineer.</p>	QAP
EQxx FLAWING INCOMPLETE.	<p>Flaw map could not be read during initialization. For multiunit 844 equipment, some flaws may not have been recorded.</p>	<p>Reformat 881 or 883 packs.</p>	IMS
EQxx nn FLAWS NOT PROCESSED, list.	<p>Informative message indicating the number of flaw entries not processed because the tracks specified (list) were in use.</p> <p>xx EST ordinal of device</p>	<p>Reenter list of tracks to be flawed at a later time.</p>	IMS

<u>MESSAGE</u>	<u>SIGNIFICANCE</u>	<u>ACTION</u>	<u>ROUTINE</u>
EQxx. HOLD.	Line printer xx is waiting. EQ One of the following equipment types. LP Any line printer LR 580-12 line printer LS 580-16 line printer LT 580-20 line printer xx EST ordinal of line printer	If desired, continue printing via DSD command CONTINUE (refer to section 3).	1CD
EQxx LOCAL AREA OVERFLOW.	An attempt to checkpoint a new local area has resulted in overflowing the local area sector. The local area sector is a sector within the label track containing information from the MST local area. Each entry in this area is associated with a unique machine ID. This message is caused by the attempted recovery of a device by machines using more than 37B different machine IDs. xx EST ordinal of device	Inform site analyst. Either one of the following actions should be performed. - In order to access the device, change the machine's ID (via deadstart) to one that already exists on the device - Initialize the device to clear the entire local area.	1CK
EQxx LOCAL AREA SECTOR ERROR.	An unrecoverable error occurred while trying to read the local area sector (the sector within the label track containing information from the MST local area). xx EST ordinal of device	Inform site analyst. Device must be initialized and the bad sector flawed.	IMS 1CK
EQxx LOCAL AREA SECTOR RESET.	A local area sector contained incorrect information and the entire sector is disregarded. xx EST ordinal of device	Inform site analyst.	IMS
EQxx LOCAL AREAS INITIALIZED.	Informative message indicating that the inactive local areas on the device were initialized. xx EST ordinal of device	None.	IMS
EQxx,MRT PROCESSED BUT NOT REWRITTEN.	An unrecoverable write error was encountered on the link device while attempting to zero out the MRT for device with EST ordinal xx. Processing continued.	Inform customer engineer; error should also be logged in error log.	1MR
EQxx. NO PAPER.	Line printer xx is out of paper. EQ One of the following equipment types. LP Any line printer LR 580-12 line printer LS 580-16 line printer LT 580-20 line printer xx EST ordinal of line printer	Correct paper condition.	1CD

<u>MESSAGE</u>	<u>SIGNIFICANCE</u>	<u>ACTION</u>	<u>ROUTINE</u>
EQxx. NOT READY.	Local batch equipment xx is not ready. EQ One of the following equipment types. CP 415 card punch CR 405 card reader LP Any line printer LR 580-12 line printer LS 580-16 line printer LT 580-20 line printer xx EST ordinal of local batch equipment	Ready the equipment.	1CD
EQxx. OFF.	Local batch equipment xx has been logically turned off. EQ One of the following equipment types. CP 415 card punch CR 405 card reader LP Any line printer LR 580-12 line printer LS 580-16 line printer LT 580-20 line printer xx EST ordinal of local batch equipment	If desired, equipment may be turned on via DSD command ON (refer to section 3).	1CD
EQ OR DN ILLEGAL.	Either the specified EST ordinal (EQ) is greater than 77B or does not define a mass storage device, or the device number specified (DN) is greater than 77B.	Correct and enter GO.	MSI
EQxx,PF CATALOG SIZE ERROR.	The size of the permanent file catalogs on device with EST ordinal xx is incorrect for the current system.	Inform site analyst.	REC CMS
EQxx PF INITIALIZE COMPLETE.	Informative message indicating the permanent file initialization operation completed successfully. xx EST ordinal of device	None.	IMS
EQxx nnnn PRESERVED FILE ERRORS.	Message indicating the number of preserved files encountered during mass storage device recovery which had system sector errors or could not be identified. Mass storage device recovery is performed during system deadstart or when a removable device is introduced into the system. xx EST ordinal of device nnnn Number of files in error	Inform site analyst; supply dumps of dayfile and error log. Files that were in error (or the entire device) should be reloaded.	REC CMS
EQxx,nnnn PRINT ERRORS.	Print errors detected on line printer xx. EQ One of the following equipment types. LP Any line printer LR 580-12 line printer LS 580-16 line printer LT 580-20 line printer	Inform customer engineer.	1CD QAP

<u>MESSAGE</u>	<u>SIGNIFICANCE</u>	<u>ACTION</u>	<u>ROUTINE</u>
EQxx REDEFINITION COMPLETE.	xx EST ordinal of line printer nnnn Octal number of print errors Informative message indicating that the redefinition procedure for equipment xx completed successfully.	None.	CONFIG
EQxx,RFER, TKtrac, ty, filenam.	An unrecoverable read error was encountered on the rollout file. xx EST ordinal of device trac Track number ty File type filenam Name of file	Inform site analyst.	IRI
EQxx, SSER, TKtrac, ty, filenam.	An unrecoverable error occurred while attempting to read or write system sector on device with EST ordinal xx. Processing continued. xx EST ordinal of device trac Track number ty File type filenam Name of file	Inform site analyst.	IRI IMR
EQxx,TKtrac, INVALID LOCAL FILE.	The MRT bit was set for track trac on device with EST ordinal xx but the track did not have a legal system sector for a local file. The track was not dropped.	Inform site analyst. The actual contents of the system sector at the specified address must be inspected to determine the error.	IMR
EQxx TRACK LIMIT.	A track limit occurred on device with EST ordinal xx during a checkpoint. Selected queued files or preserved files that reside on the device must be purged before retrying the checkpoint.	Inform site analyst. To purge queued files do the following. 1. Observe the DSD Q display to select desired files. 2. Purge the selected files using the DSD command PURGE,xxx. To purge permanent files do the following. 1. A PFCAT summary report may be used to select the desirable files. It may also be desirable to perform a PFDUMP (full or partial) for back-up before purging. 2. Purge the selected files; the purge after dump option of the PFDUMP may be used.	ICK

<u>MESSAGE</u>	<u>SIGNIFICANCE</u>	<u>ACTION</u>	<u>ROUTINE</u>
EQxx TRACK LIMIT.	There is insufficient space to allocate a catalog, permit, or indirect file chain needed to initialize device xx.	If attempting to initialize a device on-line, monitor the E,A. display and wait for tracks to become available. Then enter K.RERUN. If attempting to initialize a device during deadstart, redeadstart and check device usage.	MSI
EQxx nn TRACKS FLAWED.	Informative message indicating the number of tracks that were successfully flawed. xx EST ordinal of device	None.	IMS
EQxx TRKtrac SYSTEM SECTOR ERROR.	IMS could not read the system sector at this location while performing maintenance on direct access files. xx EST ordinal of device trac Track number of system sector	Inform site analyst.	IMS
EQxx,UNuu, CHECKING RESERVE.	Informative message indicating that controller and unit reservations are being processed for logical unit uu on equipment xx.	None.	IMR
EQxx,UNuu, UNIT RESERVED.	K-display message indicating that logical unit uu on equipment xx could not be accessed due to physical unit reservation.	Refer to section 8 for possible action. Inform site analyst.	MREC
EQxx -- VALIDATION ERROR ec.	An error was detected on equipment xx during mass storage table validation. ec Error code; may be any one or a sum of the following. 1 Error in track count 2 Error in preserved file count 4 Error in permits chain 10 Error in catalog chain 20 Error in indirect chain PP programs that attempt to access equipment xx must wait until the validation error is corrected and the device is revalidated.	Inform site analyst.	DSD 1CK
EQUIPMENT SIZE ERROR.	K-display message indicating that either the equipment from which to delete had no units, or the equipment to be added to already had eight units.	Correct K-display input and retry.	CONFIG

<u>MESSAGE</u>	<u>SIGNIFICANCE</u>	<u>ACTION</u>	<u>ROUTINE</u>
EQUIPMENT STATUS INCORRECT.	The equipment being redefined is not unloaded and the number of units cannot be changed.	Correct K display input and retry.	CONFIG
ERROR IN CHANNEL NUMBER.	Indicates one of the following: - if system has 10 PPs or less, channel number was not in the range of 0 to 13B. - if system has more than 10 PPs, channel number was not in the range of 0 to 13B or 20B to 33B.	Correct K display input and retry.	CONFIG
ERROR IN ENTRY, NUMBER TOO LARGE	The number entered in response to the CYBERLOG display is not within the range of specified numbers for that program step.	Reenter a number in the range of specified values.	CYBRLOG
ERROR IN ENTRY, ONLY A SINGLE DIGIT ALLOWED	Something other than a number was entered for a CYBERLOG entry.	Reenter a number in the range of specified values.	CYBRLOG
ERROR IN EQUIPMENT NUMBER.	Indicates one of the following: - Equipment is not a mass storage device. - Equipment is not a 844 or 885 disk drive.	Correct K display input and retry.	CONFIG
ERROR IN LOADING AAMI.	The loader encountered errors while loading the TAF CRM AAM interface (AAMI).	The site analyst should consult the CYBER Loader Reference Manual (listed in the preface).	TAF
ERROR IN LOADING HASH CODE filenam.	The loader encountered errors while loading the hashing routine code that is on file filenam.	The site analyst should consult the CYBER Loader Reference Manual (listed in the preface).	TAF
ERROR IN LOADING TOTAL.	The loader encountered errors while loading Total and the data base descriptor modules (DBMODs).	The site analyst should consult the CYBER Loader Reference Manual (listed in the preface).	TAF
ERROR IN READING TASKLIB-filenam.	Error occurred during transaction executive initialization or ECS-resident task loading. File specified as task library was incorrectly formatted; therefore, it could not be read or loaded into ECS correctly.	Inform site analyst.	TAF
ERROR IN SECOND PPS.	An error in the second peripheral processor subsystem (PPS) has occurred.	Inform site analyst and customer engineer.	SCE
ERROR IN UNIT LIST.	Indicates one of the following: - A unit number was duplicated in the unit list. - More than three units are specified for an 885 disk drive.	Correct K-display input and retry.	CONFIG

<u>MESSAGE</u>	<u>SIGNIFICANCE</u>	<u>ACTION</u>	<u>ROUTINE</u>
ERROR LOADING -DIO-.	The record on the deadstart file immediately following OSB is not DIO.	Select a different tape or disk from which to deadstart.	OSB
ERROR ON ACTIVE DEVICES.	Label checking has detected error on device with active files. Message indicates abnormal condition that should be corrected immediately (for example, wrong pack removed when interchanging devices).	Examine E,M display to determine type of error.	CMS
ERROR ON DEVICE WITH ACTIVE FILES.	This message is issued during level 1 or 2 recovery deadstart if label on mass storage device cannot be verified and active files are on the device. Recovery is impossible. This message is preceded by the message RECOVERY, dtxx. which indicates the equipment that is in error.	Attempt another deadstart with no recovery (level 0).	RMS
ERROR ON xxJ FILE ARGUMENTS.	The xxJ file contains statements in error, which causes the transaction subsystem to abort.	Examine xxJ file. Consult TAF data base administrator.	TAF
ERROR ON LINK DEVICE.	An unrecoverable error occurred while reading the link device.	Inform customer engineer; error should be logged in error log.	IMS ICK
ERROR ON LINK DEVICE.	An unrecoverable read error was encountered while reading the ECS label track.	Inform site analyst; deadstart may be required.	IRM
ERROR ON ROLLFILE - EXEC RESTARTING.	MSSEXEC terminated because an unrecoverable error occurred while reading the rollfile. MSSEXEC restarts automatically.	None.	MSSEXEC
EST/FNT LENGTHS CONFLICT, RECOVERY OF DEVICE IMPOSSIBLE.	Error was encountered during a recovery deadstart. This error occurred because the length of the FNT or EST of the system defined in CMRDECK conflicts with the system being recovered from disk.	Attempt another deadstart without recovery (level 0).	REC
EXEC IN SINGLE MAINFRAME MODE.	Informative message indicating that MSSEXEC is running in a single mainframe environment.	None.	EXINIT
EXEC MMF INITIALIZATION FAILED - - message.	MSSEXEC failed to establish communication with any of the slave machines in a multmainframe environment; message indicates the reason and can be one of the following: ALL SLAVES OMITTED ATTACH MTOS FAILED DEFINE MTOS FAILED MTOS FILE BUSY SETPFP PROBLEM.	Inform site analyst.	EXINIT

<u>MESSAGE</u>	<u>SIGNIFICANCE</u>	<u>ACTION</u>	<u>ROUTINE</u>
EXEC MMF INITIALIZATION OK.	Informative message indicating that MSSEEXEC is ready to run in a multiframe environment.	None.	EXINIT
EXEC - SLAVE i xxxx.	Informative message indicating that MSSEEXEC is ready to communicate with MSSSLV on mainframe i or that the status of MSSSLV on mainframe i has changed. The current status of MSSSLV is indicated by xxxx and can be IDLE, ACTIVE, or INACTIVE.	None.	EXINIT EXMAIN
EXEC - SLAVE i OMITTED - - message.	MSSEEXEC was unable to establish or maintain access to a communication file with MSSSLV on mainframe i; message indicates the reason and can be one of the following. NO STOM FILE STOM FILE ERROR STOM FILE LENGTH PROBLEM MSSEEXEC will continue to operate, but will not attempt to receive requests from MSSSLV on mainframe i.	If MSSSLV is to be run on mainframe i, and the message is NO STOM FILE or STOM FILE ERROR: idle MSSEEXEC, PURGE the STOM file, initiate MSSSLV, and then initiate MSSEEXEC. For STOM FILE LENGTH PROBLEM, PURGE the existing STOM file, and reinstall MSSEEXEC and MSSSLV using identical values for NUMRB, MAXSLV, and NUMSLV in common deck COMEIPR and for RBSIZE in common deck COMAMSS.	EXINIT EXMAIN
EXEC SMFMODE - ALL SLAVES OMITTED.	MSSEEXEC has lost access to all of the MSSSLVs and is now running in single mainframe mode.	Inform site analyst.	EXMAIN
EXPORT ABORT - NO MUX OR BAD MUX.	The Export driver was unable to obtain a satisfactory status response from an assigned multiplexer during initialization. Dayfile message.	Inform site analyst.	1LS
EXPORT OVL OVCS BC .LT. ZERO.	The buffer count for Export has become negative. Dayfile message.	Inform site analyst.	1LS
EXPORT RUNNING.	Informative message indicating that Export initialization has completed normally. Dayfile message.	None.	1LS
EXTRANEIOUS COMMAND PARAMETER	The command which was just entered has unnecessary trailing parameters.	Enter the correct command format.	CS
FAMILY MASK NOT EQUAL TO 377.	The device mask for the family does not equal 377B.	Correct and enter GO or enter GO to override. This is the only input accepted at this time.	MSI

<u>MESSAGE</u>	<u>SIGNIFICANCE</u>	<u>ACTION</u>	<u>ROUTINE</u>
FAMILY STILL ACTIVE.	An attempt was made via the ISF command to release from fast-attach status all files for a specific family but that family was still active. Dayfile message.	Check E. display for activity count. Wait for activity to equal zero or set idle status for the family.	SFM
FAST ATTACH FILES ON DEVICE.	An attempt was made to initialize a mass storage device on which one or more fast-attach files are currently active. This message also appears in the comment field of the system control point in the job status (B) display.	Inform site analyst; the fast-attach files will have to be released, via ISF function, before the device can be initialized. The recommended procedure is as follows. <ul style="list-style-type: none"> - Examine the FNT (H) display to determine the names of the fast-attach files on the device (typically, VALIDUZ, PROFILB, or RSXDId). - Release those files via ISF entries in the following format. X.ISF,R=filenam. If fast-attach files are to be reloaded after the device is initialized, those files must be initialized via the entry X.ISF.	IDS
FAST ATTACH SYSTEM SECTOR ERROR.	When entering or deleting a fast-attach file, SFM was unable to read the file's system sector. Dayfile message.	The fast-attach file should be copied to another area and the unreadable space flawed.	SFM
FATAL CIO ERROR STATUS.	A TAF CIO operation returned a fatal error status which aborted TAF.	Inform site analyst.	TAF
FATAL INITIALIZATION ERROR.	A fatal error occurred during initialization of MSSEXEC.	Examine the job dayfile for error messages.	EXMAIN
FATAL MAINFRAME ERROR.	One or more of the following has occurred. <ul style="list-style-type: none"> - CSU address parity error - CSU fault - PP stop on CM read error - PP stop on PP parity error - Double bit SECEDED error - LCME double bit SECEDED error (CYBER 176 only) 	Inform site analyst and customer engineer. (For further explanation and procedures, refer to S/C Register Error Detection, Appendix F.)	IMB

<u>MESSAGE</u>	<u>SIGNIFICANCE</u>	<u>ACTION</u>	<u>ROUTINE</u>
FCN CSaaaa DSbbbb.	Operator message indicating that a function reject error has occurred during an express deadstart dump. aaaa Channel converter status bbbb Controller status	Press carriage return to retry the dump operation.	EDD
FIELD LENGTH EXCEEDED FOR CMM.	TAF does not have enough field length to allocate the space potentially required by CMM.	Increase TAF initialization field length.	TAF
FIELD LENGTH EXCEEDED FOR LOCKS.	TAF does not have enough initialization field length for allocating lock tables.	Decrease the locks parameter on the CRM statement, increase the TAF initialization field length, or inform site analyst.	TAF
FIELD LENGTH EXCEEDED FOR RECORD.	TAF does not have enough field length to allocate the space for the record buffer.	Decrease the record size specified in the xxJ file or increase the TAF initialization field length.	TAF
FIELD LENGTH EXCEEDED FOR USERS.	TAF does not have enough initialization field length for allocating file control tables.	Decrease the users parameter on the CRM statement, increase the TAF initialization field length, or inform site analyst.	TAF
FILE BUSY PFN= filename UN= username.	Informative message indicating that MCS attempted to attach the named file. filename File name username User name	None.	MCS
FILE edt EMPTY.	Element descriptor table file edt is empty.	Correct error, reinitialize executive, and rerun.	TAF BDMI
FILE xxJ NOT FOUND.	Transaction subsystem aborts. Data base in TCF file has no xxJ file, or a PFM error occurred.	Consult TAF data base administrator or contact site analyst.	TAF
FILE NAME CONFLICT.	The input file name specified on the KTSMDP control statement is the same as the output file name specified.	Correct error and rerun.	KTSMDP
FILE NAME MUST BE 2-7 CHARACTERS.	The xxfni parameter on the CRM statement must be two to seven characters, the first two (xx) being the data base name.	Correct the xxfni parameter on the CRM statement or inform site analyst.	TAF

<u>MESSAGE</u>	<u>SIGNIFICANCE</u>	<u>ACTION</u>	<u>ROUTINE</u>
FILE hash NOT FOUND.	The indirect file named hash containing the binary code of the hashing routine was not found under the usernam parameter on the USER statement in the xxJ file or a PFM error occurred.	Ensure that file hash is saved under the usernam parameter or inform site analyst. Consult the CYBER Loader Reference Manual (listed in the preface).	TAF
FILE NOT FOUND.	User did not have a tape preassigned or the user-supplied mnemonic did not match the mnemonic of the preassigned tape.	Preassign a tape or correct control statement parameters and reenter.	CVL
FILE SPECIFIED AS EDT FILE IS NOT EDT FILE TYPE.	The file specified as the EDT is not an EDT.	Correct error and rerun, or inform site analyst.	TAF BDMI
FILE TCF EMPTY.	An empty TCF exists under the TAF user name.	Place the necessary information on TCF.	TAF
FILE TCF NOT FOUND.	The TCF was not found under the user name of the Transaction Facility.	Create a TCF file under the TAF user name.	TAF
FILE edt TOO LARGE.	Element descriptor table is too large to be read into memory.	Correct error and reinitialize executive (TAF), or rerun (BDMI).	TAF BDMI
FILE TYPE MUST BE IS OR DA.	The type parameter on the CRM statement must be either IS (indexed sequential) or DA (direct access).	Correct the type parameter on the CRM statement or inform site analyst.	TAF
FIRMWARE LOAD, PART NO. - 12345678.	Informative message indicating that magnetic tape controller controlware has been loaded.	None.	IMT
FL TOO LARGE- nnnnnnB,tasknam,tasklib.	The initial load field length, nnnnnnB, for task tasknam on task library tasklib exceeds the minimum size of the transient task area (potential space available to contain transient tasks). Thus a situation could arise in which it would not be possible to load the task.	Correct error.	TAF
FM OR PN MUST BE SPECIFIED.	Family or pack name must be entered to initialize device.	Enter the required family name or pack name, and then enter GO.	MSI
FORCED SHUTDOWN REQUESTED.	RBF has stopped communications with the network and is performing clean-up operations.	No action required. RBF will be dropped automatically when clean-up operations are complete.	RBF

<u>MESSAGE</u>	<u>SIGNIFICANCE</u>	<u>ACTION</u>	<u>ROUTINE</u>
FORMAT ERROR.	K-display message indicating that an error exists in the syntax of the command or the values of the parameters.	Correct the command or parameters and retry operation.	TAF PFLOAD STIMULA
FORMAT ERROR IN TERMINAL DESCRIPTION FILE.	Statements on the NETwid file are in error.	Run VALNET on NETwid. Correct indicated errors. Reinitialize transaction subsystem.	TAF
FORMAT ERROR IN THE NETWORK DESCRIPTION FILE.	During transaction executive initialization, one or more errors were found to exist in the network description file.	Inform site analyst.	TAF
FORMAT UNIT FUNCTION REJECTED.	An alternate deadstart to a 67x tape unit is impossible.	Redeadstart.	SAD
FROM termnam: message	A terminal user has sent a message to the local operator. termnam Name of terminal	Respond according to the message.	CS
FROM npu/ovl... message	An NPU overlay has sent a message to the network operator.	Respond according to the message.	NS
FROM npu/RES ... message	The resident code in an NPU (not an overlay) has sent an alarm message to the network operator.	Respond according to the message.	NS
FULL INITIALIZE REQUIRED.	Operator message indicating an error was encountered and a total initialize is required on the pending device.	Specify AL initialization option (total initialize) on the INITIALIZE command.	MSI
FUNC REJECT ON DISK.	One of the following occurred: - An illegal parameter was used when assigning the disk. - A hardware problem exists.	Check parameters used. If parameters are correct, inform site analyst.	TDX
FUNC REJECT ON TAPE.	One of the following occurred: - An illegal parameter was used when assigning the Magnetic Tape Subsystem, the tape controller, or the tape unit. - A hardware problem exists.	Check parameters used. If parameters are correct, inform site analyst.	TDX
FUNCTION REJECT, ifn AT addr.	Function was rejected (possible hardware problem).	Inform site analyst.	!MT
FWA .GE. LWA+1.	There is a logical error in the structure of the input file which implies that the first word address is greater than or equal to the last word address plus one.	Inform site analyst.	KTSDMP

<u>MESSAGE</u>	<u>SIGNIFICANCE</u>	<u>ACTION</u>	<u>ROUTINE</u>
GLOBAL FAST ATTACH LIMIT.	A request has been made to enter a file in global fast-attach mode and there is insufficient space in the FAT table. A maximum of 77B global fast-attach files can exist at one time. Dayfile message.	Inform site analyst; a sufficient number of files must be returned from fast-attach status, via the ISF function, to make room for the files being put into fast-attach status.	SFM
GLOBAL TASK DUMP LIMIT EXHAUSTED.	A task issued a K.DUMP request when the global task dump limit (GTDL) is zero. No dump of the transaction facility occurred. No dumps of the transaction facility will occur from tasks until the GTDL is set to a value greater than zero.	Refer to the TAF K.DUMPLIM command; this command should be used only under the direction of the central site TAF systems analyst.	TAF
GO ALREADY RECEIVED.	Informative message.	None.	MCS
GO RECEIVED - name	A GO command has been received by NS or CS. name Network name from the NCF if GO received by NS Host name from the LCF if GO received by CS	None.	NS CS
GO RECEIVED.	Informative message.	None.	MCS
GS=ssss.	A general status error has occurred. ssss Status (four octal digits)	Redeadstart, If message persists, inform site analyst.	CDX
HARDWARE PROBLEM. filenam FOR jobnam NOT STAGED.	The staging of file filenam for job jobnam was abandoned because an MSF hardware problem was detected.	Call customer engineer.	EXSTGE
HELLO, YOU ARE NOW THE type OPERATOR	Banner message informing the terminal user that he now has the indicated operator privileges. type Type of operator status NOP Network operator LOP Local operator NOPLOP Network and local operator	None.	CS
HLD xx.	System dayfile message indicating that the operator stopped printing on BATCHIO equipment xx.	None.	QAP
HOST OPERATOR NOW HAS type STATUS	Informative message sent to host operator only indicating that the console operator has network and/or local operator privileges. The terminal user has relinquished NOP/LOP status. type Type of operator status NOP Network operator	None.	CS

<u>MESSAGE</u>	<u>SIGNIFICANCE</u>	<u>ACTION</u>	<u>ROUTINE</u>
	LOP Local operator NOPLOP Network and local operator		
HOST UNAVAILABLE.	An NPU cannot contact the host computer. NOP/LOP privileges have returned to the system console operator.	Log in again when the system banner appears at the terminal.	CCP
HST NOT AVAILABLE.	NAM is not communicating with the 255x communications processors. Either NAM was not initialized or has since failed.	Initialize NAM if it was not initialized previously; inform site analyst if NAM was active but a malfunction occurred.	TAF
HUNG PP.	An illegal function has been attempted. The PP becomes hung because MTR does not clear the output register. Operator message.	The recommended procedure is as follows. 1. Perform a full dump to tape. 2. Attempt to redead-start the system. 3. Retain dump tape to be examined by the site analyst.	MTR
IAF ABNORMAL - xxx,nnnnnn.	Informative message indicating that IAF has encountered an abnormal situation. If sense switch 3 is set, IAF attempts to enter active users into the recovery state, abort, and then reload automatically. xxx IAF routine requesting the abort nnnnnn Contents of the B2 register (usually contains a terminal number)	Inform site analyst.	IAFEX
IAF INITIALIZATION ABORT.	IAF could not be initialized properly. An additional dayfile message describing this error in more detail precedes this message.	Inform site analyst.	IAFEX
IAF TERMINATE.	Informative message indicating that IAF was stopped and was not restarted. This message is issued when IAF is dropped (via l.STOP command).	None.	IAFEX
IDLE.	Informative message indicating that the BATCHIO subsystem is idle (no I/O buffers in use). This message appears at the BATCHIO control point on the DSD job status (B) display.	None.	IIO
IDLE DOWN STARTED	Shutdown procedures for the network have begun.	Applications should begin NETOFF operations. The network operator can stop any malfunctioning	NS

<u>MESSAGE</u>	<u>SIGNIFICANCE</u>	<u>ACTION</u>	<u>ROUTINE</u>
ILLEGAL ACCOUNT/FAMILY.	Dayfile message that may indicate that VALIDUS file is not present in the system or that the user has submitted an invalid user number or family name.	applications by entering the DISABLE, NETWORK command (refer to section 7). Examine the EST (H,A.) display to determine if the VALIDUS file is active in the system (VALIDUS is a fast-attach file). If VALIDUS is active, no operator action is necessary; assume an illegal user number or family name was entered. However, if VALIDUS is not active, it must be initialized (activated) via the console entry X.ISF.	ACCFAM
ILLEGAL COMMAND	Informative message indicating that the network/local operator entered an illegal command.	Enter correct command.	CS MCS
ILLEGAL DATA BASE IN xxJ FILE.	One of the statements in the xxJ file specifies an incorrect xx parameter and causes the transaction subsystem to abort.	Examine xxJ files. Consult the TAF data base administrator.	TAF
ILLEGAL DEVICE TYPE.	Operator message indicating that the device type specified on the CMRDECK entry was not found in the table of legal device types.	Reheadstart and correct the CMRDECK entry.	SET ICM
ILLEGAL ENTRY.	K-display message indicating that the processor could not recognize the specified utility option.	Correct and reenter K-display input.	QFSP MSI MREC
ILLEGAL ENTRY.	One of the following: - A key word was not found. - Too many digits were entered as a parameter. - A nondigit character was found in a parameter. - A character was found after the postradix. - An 8 or 9 was found with a B postradix.	Correct K display input and retry.	CONFIG
ILLEGAL EQUIPMENT.	K-display message indicating that the OP=R option was entered for a non-844 device.	Correct and reenter K-display input.	MREC

<u>MESSAGE</u>	<u>SIGNIFICANCE</u>	<u>ACTION</u>	<u>ROUTINE</u>
ILLEGAL FAMILY NAME.	Dayfile message indicating that the family name specified in the ISF entry is not defined in the running system.	Repeat ISF entry with correct family name.	ISF
ILLEGAL FILE NAME.	Dayfile message indicating that the file name specified in the ISF entry (file to be initialized) was not available to the system. Valid file names include VALIDUs, PROFILa, RSXDId, RSXVId, SYSPROC, and SYSJOB.	Repeat the ISF entry with the correct file name.	ISF
ILLEGAL IMS FUNCTION.	Illegal function detected in call to IMS (could be caused by hardware parity error or logic error in program).	Inform site analyst.	IMS
ILLEGAL LIBTASK ATTEMPT - filename, username.	The transaction executive validates all dynamic attempts to change the task library by comparing the user number of the list of the requester against data base user numbers. If it does not match, or if the library file is not attached by TAF, the transaction executive issues this dayfile message, where usernum is the user number of the illegal attempt.	Correct and reinitialize transaction executive.	TAF
ILLEGAL NUMBER FOR LOCKS.	The locks parameter on the CRM statement is in error. One of the following format conditions exists. <ul style="list-style-type: none"> - A nonnumeric character. - A character after a postradix of B or D. - An 8 or 9 with a postradix of B. 	Correct the locks parameter on the CRM statement or inform site analyst.	TAF
ILLEGAL NUMBER FOR USERS.	The users parameter on the CRM statement is in error. One of the following format conditions exists. <ul style="list-style-type: none"> - A nonnumeric character. - A character after a postradix of B or D. - An 8 or 9 with a postradix of B. 	Correct the users parameter on the CRM statement or inform site analyst.	TAF
ILLEGAL OPTION.	Nonfatal K-display message indicating that an illegal keyboard entry was made.	Reenter the correct option.	STIMULA MREC
ILLEGAL ORIGIN TYPE.	MREC was run from a nonsystem origin job.	Rerun from system origin.	MREC
ILLEGAL OVERLAY PARAMETER	The network operator entered an illegal overlay parameter. Valid parameters are LOAD, DATA, and DROP.	Correct parameter and reenter command.	NS
ILLEGAL SEPARATOR.	An = separator was found following a parameter value or command in the input string.	Correct K display input and retry.	CONFIG

<u>MESSAGE</u>	<u>SIGNIFICANCE</u>	<u>ACTION</u>	<u>ROUTINE</u>
ILLEGAL SLL REQUEST.	Dayfile message indicating an SLL with an undefined function code.	Inform site analyst.	SLL
ILLEGAL TERMINAL NAME.	A batch job submitted a transaction specifying a nonexistent terminal and/or user name.	Correct task or correct and reinitialize transaction executive with terminal and user name defined.	TAF
ILLEGAL TERMINAL REQUEST.	Informative message indicating that an unidentified request was encountered, the request was not from a terminal job, or auto recall was not requested by the calling job.	None.	TLX
ILLEGAL TIME ENTRY HOURS: 00 TO 99, MINUTES: 00 TO 59	The value for the hours and/or the minutes are not in the specified range for a CYBERLOG entry.	Reenter the value for hours and minutes in the specified range.	CYBRLOG
ILLEGAL TIME ENTRY PERIOD REQUIRED	The period preceding the minutes was not entered in an elapsed time or lost time entry in response to the CYBERLOG display.	Reenter the value for time with a period preceding the minutes.	CYBRLOG
ILLEGAL USER ACCESS.	The user tried to perform an operation for which he is not validated. Possible causes include attempts to <ul style="list-style-type: none"> - run a system origin job from nonsystem origin - access a restricted subsystem without proper validation - enter an invalid SRU value - use the V carriage control character without validation 	Ensure accuracy of control statement or determine proper validation requirements via LIMITS statement.	LFM MSI NETVAL QFSP RESEX IMA
ILLEGAL 1MR FUNCTION.	An illegal function was issued to 1MR.	Inform site analyst.	1MR
IMBEDDED BLANK IN PARAMETER VALUE	An imbedded blank was detected in the command parameter list.	Correct parameter list and reenter command.	CS
IMBEDDED PERIOD IN PARAMETER VALUE	An imbedded period was detected in the command parameter list.	Correct parameter list and reenter command.	CS
INCORRECT FORMAT FOR EQ ENTRY.	K-display message indicating that a syntax error was made when entering parameters for the EQ keyword.	Correct and reenter K-display input.	MREC
INCORRECT FORMAT FOR MID.	K-display message indicating the machine ID entered is either not two characters or not alphanumeric.	Correct and reenter K-display input.	MREC
INITIAL TASK NOT IN TASK LIBRARY DIRECTORY.	The task library file does not contain the initial task (ITASK).	Inform site analyst.	TAF

<u>MESSAGE</u>	<u>SIGNIFICANCE</u>	<u>ACTION</u>	<u>ROUTINE</u>
INITIALIZATION OPTIONS.	This message precedes messages indicating the values of the initial K-display options either during initialization or recovery.	None.	TAF
INITIALIZE BIT NOT SET ON EQxx.	Device with EST ordinal xx is available and has a good label but cannot be linked to another device unless initialize status is set.	One of the following. - Enter INITIALIZE command to set initialize status for device and then enter RERUN to update list (on K display) of devices with initialize status set. - Enter CLEAR to clear initialize status for current device.	MSI
INITIALIZE W/O PRESET OF LINK DEVICE ILLEGAL.	A full initialize was specified for the link device which, if allowed to continue, would destroy ECS resident multimainframe tables. These tables are assumed to be intact in the absence of a PRESET command.	Redeadstart without initializing the link device if other machines are operating in a multimainframe mode; otherwise, specify PRESET in conjunction with the INITIALIZE command.	SET
INPUT FILE EMPTY.	The NDL processor attempted to open the file specified for job input but could not find any recognizable information.	Check job structure or verify contents of the input file. Rerun the job.	NDLMAIN
INSUFFICIENT FIELD LENGTH.	The NDL processor requires additional central memory to completely process all input statements that cause table generation. Excessive use of the DEFINE statement can cause the processor to need additional table space.	Remove as many NDL DEFINE statements as possible from the input file or add an RFL statement to the control statement portion of the job. Rerun the job.	STORDEF STORNAM
INSUFFICIENT FL FOR DATA MANAGER.	The transaction executive requires more field length at initialization time than is available.	Correct error and reinitialize executive.	TAF
INSUFFICIENT MEMORY FOR CM RECOVERY.	During a level 3 recovery, not enough free memory (central memory not assigned to subsystem jobs) is available as is required for label MSTs. Recovery is impossible.	Redeadstart using a level 0 deadstart.	RMS
INTERNAL ERROR IN MSI.	MSI encountered an internal condition which could destroy permanent files.	Inform site analyst.	MSI

<u>MESSAGE</u>	<u>SIGNIFICANCE</u>	<u>ACTION</u>	<u>ROUTINE</u>
INTRODUCED UNIT IN USE.	A unit being introduced to an equipment is defined on another equipment.	Correct K display input and retry.	CONFIG
INVALID COMMAND PARAMETER	The network/local operator entered an invalid parameter.	Correct parameter and reenter command.	CS
INVALID CONTROL STATEMENT.	Arguments were entered on the control statement call to CONFIG.	Reenter control statement without arguments.	CONFIG
INVALID CONTROL STATEMENT OPTION.	The NDLP control statement used by the job contains a format or syntax error.	Correct the statement and rerun the job.	NDLMAIN
INVALID DATA BASE NAME ON DMS STATEMENT.	A data base name associated with TAF, CRM, or OTHER exceeds two characters.	Correct the DMS statement on TCF file.	TAF
INVALID PROGRAM NUMBER.	The CTI module has requested the loading of an undefined module.	Redeadstart. If the message persists, contact customer engineer.	DHE
INVALID TCF ENTRY.	A syntax error was detected on the TCF file. This could include one of the following: <ul style="list-style-type: none"> - The data manager identifier is not TAF, CRM, TOTAL or OTHER. - A data manager status declaration is not in the proper form; it must be ON or OFF. 	Correct error.	TAF
INVALID USER ACCESS.	CONFIG was called from a non system origin job or without mass storage subsystem priority.	Inform site analyst.	CONFIG
IO ERROR ec ON filenam.	A CIO error ec was encountered on file filenam.	Refer to the message following this message for the disposition of the file.	MCS
IO ERROR ec ON ROLLOUT.	Because of IO errors, the MCS subsystem could not roll out. cc CIO error code (refer to the NOS Reference Manual, volume 2)	None.	MCS
IPL NOT FOUND	The initial program loader in CTI was not found.	Redeadstart.	ICD
ISD ERROR, vvvvv. REPLY GO TO RETRY - DROP TO OFF DEVICE.	K-display message indicating that an input or output (vvvvv) belt malfunction occurred on the mass storage transport.	Verify that the cartridges are aligned correctly on the input or output belt and enter K.m.GO. If any cartridge is not aligned, enter K.m.DROP and call a	MSSEXEC

<u>MESSAGE</u>	<u>SIGNIFICANCE</u>	<u>ACTION</u>	<u>ROUTINE</u>
		customer engineer. m Message ordinal	
ISF COMPLETE.	Dayfile message indicating that ISF operation is complete.	None.	ISF
JOB RERUN.	Informative message indicating that the job was terminated and the input file requested.	None.	ICJ
JOB(S) HUNG.	Informative message indicating that time-sharing subsystem has encountered some time-sharing origin (TXOT) jobs at control points and is attempting to roll them out. This message is displayed only for a short period of time.	None.	IAFEX TELEX
JOBS HUNG IN SYSTEM.	Jobs of TXOT origin were found in the system during initialization. These jobs must be removed before IAF can be initialized.	Inform site analyst.	IAFEX
JOB(S) HUNG IN SYSTEM.	One or more jobs of multiterminal origin or TELEX origin were not cleared from the system queues before TELEX initialization. Normally, TELEX clears all jobs of these types when it is terminated.	Restart TELEX using DSD command TELEX (refer to section 3).	TELEX
JOURNAL TYPE DOES NOT MATCH xxJ FILE.	Journal file entries in the xxJ file do not match the files themselves. This causes the transaction subsystem to abort.	Consult TAF data base administrator. Examine xxJ file for the journal file entries.	TAF
K.CMB=nn. K.ECS=nnnK. K.MDM=n. K.MFL=nnnnnnB. K.REC=a. K.SCP=nn. K.TLF=a.	Values of the initial K-display options at either initialization or recovery.	None.	TAF
K.MAXFL,nnnnnnB.	The run-time K-display command K.MAXFL was entered with the indicated value.	None.	TAF
K.MAXFL REJECTED.	A value was entered which caused potential blocked tasks to be detected.	Reenter K.MAXFL with a larger value.	TAF
LABEL TRACK CONFLICT.	While attempting to initialize a device at deadstart time, it has been determined that the track reserved via CPUMTR is not the first available track in the TRT. Recovery is impossible.	Inform site analyst. The TRT (and possibly a dump of RMS) must be interrogated to determine the conflict. A level 0 deadstart may be necessary to allow deadstart initialization of the	RMS

<u>MESSAGE</u>	<u>SIGNIFICANCE</u>	<u>ACTION</u>	<u>ROUTINE</u>
LABELLED TAPE WAS PREASSIGNED.	User did not specify an unlabeled tape when using tape preassignment.	device. Specify an unlabeled tape in the control statement.	CVL
LCF ASSIGNED,PFN=filenam,UN=userid	Informative message indicating that the LCF has been attached successfully. This message is followed by the date and time from the LCF verification record. filenam Name of LCF userid User name under which the LCF is stored	None.	CS
LCF ERROR - ec	An error has been detected during processing of the LCF. ec Error code 1 Unrecognizable host record 2 Unrecognizable NPU record 3 Unrecognizable line key 4 Unrecognizable verification record	Assign another LCF.	CS
LCF NOT AVAILABLE(,PFN=filenam,UN=userid)	The LCF to be used by CS could not be attached. If PFN and UN are not shown, a default LCF was not specified by the installation. filenam Name of LCF userid User name under which LCF is stored	Assign another LCF.	CS
LCM SECEDED BIT ERROR - QUADRANT q, CSU x.	A large core memory (LCM) SECEDED parity error has occurred (CYBER 176 only). q Quadrant (0, 1, 2, or 3) x CSU number (0 or 1)	Inform site analyst and customer engineer. (For further explanation and procedures, refer to S/C Register Error Detection, Appendix F.)	SCE
LIBRARY DIRECTORY EMPTY - filenam.	The task library file indicated does not contain a directory.	Inform site analyst.	TAF
LIBRARY DIRECTORY ERROR - filenam.	The task library file indicated contains a nonrecognizable directory.	Inform site analyst.	TAF
LIBRARY DIRECTORY TOO LONG - filenam.	The directory record on the task library file indicated exceeded the maximum length allowed by the transaction executive (398 entries).	Inform site analyst.	TAF
LIBRARY TABLE ERROR.	Dayfile message indicating that an error was encountered while building the system library. Blank entry was not found in the library table or in the directory within the field length at the deadstart control point.	Attempt another deadstart. If the problem persists, inform site analyst.	SLL

<u>MESSAGE</u>	<u>SIGNIFICANCE</u>	<u>ACTION</u>	<u>ROUTINE</u>
LINE: name,status,port,ltype,npu	Line status message sent in response to a STATUS command, or when a significant change in status has occurred. name Name of line status Status of line DI Disabled EN Enabled AC Active DN Down port Port number ltype S1,S2,S3, and so on. Refer to the Network Definition Language Reference Manual. npu Name of associated NPU	No action required unless the disabling of an enabled, active, or down line, or the enabling of a disabled line is desired.	CS
LINE TOO LONG.	Operator attempted to enter a line over 50 characters long as input to a K or L display. DSD does not accept the entry.	Backspace and shorten entry to 50 characters or less.	DSD
LINK DEVICE CANNOT BE ALTERED.	Informative message indicating that an illegal attempt was made to change the characteristics of the link device using an on-line initialize.	None.	MSI
LINK DEVICE LABEL TRACK ERROR.	An attempt to locate a free track for link device label information within predetermined limits was unsuccessful, possibly because a large block of ECS was flawed initially.	Inform site analyst and/or remove need for flawing of the device.	SET
LINK DEVICE READ ERROR.	An unrecoverable error occurred while attempting to read the link device.	Inform site analyst. The error log should be examined for further error description. The only K-display entries allowed are K.RERUN. and K.STOP.	MREC
LINK DEVICE TABLE ERROR.	An error was encountered in link device tables which made further processing impossible.	Inform site analyst after stopping further system processing. The error log and link device tables must be examined to determine how to proceed.	IMR
LINK DEVICE WRITE ERROR.	An unrecoverable error occurred while attempting to write the link device.	Inform site analyst. The error log should be examined for further error description. The only K-display entries allowed are K.RERUN. and K.STOP.	MREC

<u>MESSAGE</u>	<u>SIGNIFICANCE</u>	<u>ACTION</u>	<u>ROUTINE</u>
LINK FAST ATTACH FILE NOT FOUND.	An attempt to fast-attach a file already in the fast-attach table (FAT) has been unsuccessful. The file is currently busy in a status other than fast-attach. Dayfile message.	Locate the job to which the desired file is attached and return the file. Retry the function (usually through ISF).	SFM
LLINK. name,status,RL=n,host/term	Logical link status message sent in response to a STATUS command, or when a significant change in status has occurred. name Name of logical link status Status of logical link DI Disabled EN Enabled AC Active DN Down n Regulation level currently in effect host Host node number term Terminal node number	No action required if response to STATUS command.	NS
LOAD FAILURE	A load of the NPU aborted. The load will be retried automatically.	None.	NS
LOAD MODULE mod MISSING - D/L ABORTED	The load file used to load the NPU contained unrecognizable data and the load (or dump) was aborted. The name of the load module (mod) specified in the NCF could not be found in the CCP load file. The NPU being loaded has been disabled.	Generate a new load file or correct the NCF before attempting to load the NPU. Reenable the NPU after assigning a new CCP file.	NS
LOADING Ccc,xxxx AUTOLOAD FAILURE, STyyyy.	Following the autoloading of controlware record xxxx to the buffer controller on channel cc, controller status indicated an error. yyyy Controller status. If status is 5020, the wrong controlware was loaded. If zero, the channel was disconnected without status being received. If not zero, a channel parity error or controlware checksum error occurred for the autoload.	Ensure the correct controlware is specified in the CMRDECK. To retry the autoload, type GO. If several retries continue to produce this message, check controlware record for validity. If the controlware record is known to be good, inform customer engineer to check the controller and channel.	STL
LOADING Ccc,xxxx TO CENTRAL MEMORY.	Informative status message indicating that controlware record xxxx is being loaded to central memory in preparation for autoloading the buffer controller on channel cc. If deadstart stops with this message displayed, there is insufficient central memory available to contain the controlware record rcdname.	If a level 3 deadstart was in progress, attempt another level of deadstart. If other than a level 3 deadstart was in progress, the controlware record xxxx is bad.	STL

<u>MESSAGE</u>	<u>SIGNIFICANCE</u>	<u>ACTION</u>	<u>ROUTINE</u>
LOADING Ccc,xxxx TO CONTROLLER.	<p>Informative status message indicating that controlware record xxxx is being autoloated to the buffer controller on channel cc. If deadstart stops with this message displayed, the autoloading program has hung due to one of the following conditions.</p> <ul style="list-style-type: none"> - Another machine has the controller reserved - An incorrect CMRDECK equipment definition has been entered - A controller or channel malfunction has occurred - The controlware record xxxx is bad 	If another machine has the controller reserved, the reservation can be cleared by deadstarting the other machine or master clearing the controller. If the CMRDECK and controlware record are known to be good, inform customer engineer to check the controller and channel.	STL
LOADING ECS tasknam.	Informative message. The transaction subsystem is loading task tasknam.	None.	TAF
LOGICAL ERROR n	<p>Informative message indicating NETVAL received a nonfatal unexpected supervisory message of type n (n is between 1 and 7). The supervisory message and the time of the error are written to the NETVAL internal file DBG.</p>	None.	NETVAL
LPxx,....	Refer to description of corresponding message beginning with EQ.		
LRxx,....	Refer to description of corresponding message beginning with EQ.		
LSxx,....	Refer to description of corresponding message beginning with EQ.		
LTxx,....	Refer to description of corresponding message beginning with EQ.		
MAGNET DROPPED DURING RECOVERY.	<p>Informative message indicating the routine MAGNET1 was dropped while attempting clean-up or recovery of the magnetic tape subsystem.</p>	None.	MAGNET
MAGNET TERMINATION/NO TAPE JOBS.	<p>Informative message indicating the magnetic tape subsystem was dropped or aborted with no tapes assigned.</p>	None.	MAGNET
MAINS POWER FAILURE.	<p>Bit 36 of the status/control register (bit 0 of the interlock register) is set, indicating a main power failure. This message is preceded in the error log by the letters SR hh.mm.ss. (CYBER 170 machine) or</p>	<p>Inform site analyst and customer engineer. (For further explanation and procedures, refer to S/C Register Error</p>	SCE

<u>MESSAGE</u>	<u>SIGNIFICANCE</u>	<u>ACTION</u>	<u>ROUTINE</u>
	IR hh.mm.ss. (CYBER 70 machine) where hh.mm.ss. is the time at which the condition was detected.	Detection, Appendix F.)	
MASS STORAGE TABLE OVERFLOW.	Operator message indicating that the computed address of the mass storage table (MST) is not less than 100000B and cannot be placed in byte 4 of an equipment status table (EST) entry.	Inform site analyst.	SET ICM
MAX FIELD LENGTH EXCEEDED, JOB ABORTED.	Operator message indicating that the field length requested by RBF, NS, or CS has exceeded the maximum field length allowed.	Inform site analyst.	RBF NS CS
MAX FL REACHED.	Informative message indicating that NIP has reached the maximum field length allowed by the installation. NIP attempts to continue processing.	No action is required immediately. If this message appears frequently, increase the maximum field length allowed for NIP.	NIP
MAXIMUM NUMBER MIDS ACTIVE.	The table in ECS resident which contains machine IDs of the mainframes which have been active is full. Only four machine IDs are allowed. Operator message. Recovery is impossible.	Redeadstart with the correct machine ID.	CPUMTR RMS
MCS DISABLED BY NETWORK.	MCS cannot NETON to NAM.	Enter the LOP command to enable MCS in the network.	MCS
MCS IDLE DOWN STARTED.	Informative message indicating that the CFO.IOLE command is being processed.	None.	MCS
MCS INITIATED INCORRECTLY - TRY N.MCS.	X.MCS was entered instead of n.MCS.	Enter n.MCS.	MCS
MCS NETON COMPLETE.	Informative message.	None.	MCS
MCS REPRIEVE.	A fatal error was encountered by MCS.	Inform site analyst.	MCS
MCS SHUTDOWN COMPLETE.	Informative message.	None.	MCS
MEMORY OVERFLOW DURING INITIALIZATION.	TAF aborted because its field length for initialization was insufficient.	Inform site analyst. IFL= in deck TAF should be increased. Increasing the central memory field length parameter on the RFL control statement in the TAF initialization procedure file (fff) does not correct this problem.	TAF

<u>MESSAGE</u>	<u>SIGNIFICANCE</u>	<u>ACTION</u>	<u>ROUTINE</u>
MESSAGE FROM NPU npu/ov1 TRUNCATED	The message to the network operator from the overlay ov1 was truncated at 50 characters. npu Name of NPU containing overlay ov1 3-character identifier of overlay	None.	NS
MESSAGE SENT TO npu MAY BE LOST	The message sent to NPU npu may have been lost.	Reenter the message.	CS
MESSAGE STATUS TABLE OVERFLOW.	Space sufficient to allocate the required table was not available. An internal change to IAF is necessary.	Inform site analyst.	IAFEX
MFL TOO LARGE - nnnnnnB,tasknam,tasklib.	The MFL (initial field length plus expandable field length) of the non-CM resident task (tasknam) on task library (tasklib) exceeds the minimum size of the transient task area (potential space available to contain transient tasks). Thus a situation could arise in which it would not be possible to complete processing of this task.	Reduce the task FL or EF, or increase the TAF FL.	TAF
MID CURRENTLY ACTIVE.	ECS resident indicates that the machine ID specified in the CMRDECK is in use by another mainframe. Operator message. Recovery is impossible.	Change machine ID.	CPUMTR RMS
MID NOT SPECIFIED.	K-display message indicating that the machine ID of the machine on which to perform recovery processing was not entered.	Enter machine ID and type K.GO.	MREC
MID SPECIFIED NOT DOWN.	K-display message indicating that the machine with the specified machine ID was not determined to be down.	Correct machine ID and reenter or type K.STOP.	MREC
MID SPECIFIED NOT FOUND.	K-display message indicating that the machine with the specified machine ID was not found in the multimainframe complex.	Correct machine ID and reenter.	MREC
MID UNDEFINED IN ECS.	CPUMTR preset routine failed to find a copy of low core MMFL word in ECS resident. This message implies that machine ID has changed and/or MMFL link tables have been destroyed. Operator message. Recovery is impossible.	Change machine ID or perform a level 0 deadstart.	CPUMTR RMS
MINIMUM TAF MFL NEEDED = nnnnnnB.	Potentially blocked tasks were detected at one of the following times: - TAF initialization - Attempted task library update - Attempt to change TAF maximum FL via K.MAXFL command.	Correct error.	TAF

<u>MESSAGE</u>	<u>SIGNIFICANCE</u>	<u>ACTION</u>	<u>ROUTINE</u>
	The above operation did not complete normally. The maximum FL of TAF must be at least nnnnnnB. If nnnnnnB exceeds the largest field length possible for TAF (377700B), then other corrective action is needed.		
MISSING AIP ENTRY POINT.	No entry point for a required AIP subroutine was returned by the loader.	Inform site analyst.	IAFEX
MISSING CARTRIDGE. filenam FOR jobnam NOT FOUND ON MSS.	The staging of file filenam for job jobnam was abandoned because a cartridge was missing.	When the cartridge is located, a site analyst should run ASLABEL to restore it to its proper cubicle. (Refer to section 3 of the NOS System Maintenance Reference Manual.)	EXSTGE
MISSING HEADER WORD ON xxJ FILE.	The first statement on the xxJ file is in error, causing the transaction subsystem to abort.	Examine xxJ files for header xxJ. Consult the TAF data base administrator.	TAF
MMF DEVICE ACCESS ERROR.	Verification of this machine's access to a given mass storage device failed during a level 3 recovery. Possible causes are the following. - The CMR copy of the MST has been destroyed (specifically, the DAT index in MDGL). - MREC was inadvertently run on another mainframe. Recovery is impossible. This message is preceded by the message RECOVERY, dtxx. which indicates the equipment that is in error.	Perform a level 0 deadstart.	RMS
MNEMONIC/DEVICE CODE INCOMPATIBLE.	User requested an equipment found in the system tables, but the user-supplied mnemonic or device code did not match the equipment's mnemonic or device code.	Correct control statement parameters and reenter.	CVL
MORE THAN 4 TAPE CHANNELS.	More than four channels are currently defined in the system for magnetic tape equipment.	Inform site analyst.	1MT
MOVE PACK FROM UNIT xx TO UNIT yy AND SPIN UP.	Operator message indicating that pack can be moved.	Move physical pack and activate unit xx.	1RM

<u>MESSAGE</u>	<u>SIGNIFICANCE</u>	<u>ACTION</u>	<u>ROUTINE</u>
MREC ABNORMAL TERMINATION.	An error condition occurred which caused MREC to abort.	Inform site analyst.	MREC
MSA DEFINED ON TWO CHANNELS.	MSSEXEC has encountered an MSA that is defined on more than one channel.	Inform site analyst.	MSSEXEC
MSER, EQxx, CATALOG CHAIN.	During mass storage table validation, an error was encountered in the catalog chain on equipment xx. The error was caused by one or more of the following. <ul style="list-style-type: none"> - Label track was not linked to first catalog track. - Number of catalog tracks was not a power of 2. - Catalog chain was not reserved. - Length of catalog chain was incorrect. - Catalog chain was non-contiguous. 	Inform site analyst.	CMS DSD ICK
MSER, EQxx, INDIRECT CHAIN.	The first track of the indirect chain on equipment xx is not reserved or set as a preserved file in the TRT.	Inform site analyst.	CMS DSD ICK
MSER, EQxx, PERMITS CHAIN.	The first track of the permits chain on equipment xx is not reserved or set as a preserved file in the TRT.	Inform site analyst.	CMS DSD ICK
MSER, EQxx PF COUNT.	During mass storage table validation, the number of preserved files indicated in the TRT for equipment xx did not match the number in word ACGL of the MST.	Inform site analyst.	CMS DSD ICK
MSER, EQxx, TRACK COUNT.	During mass storage table validation, the number of available tracks (word TDGL in the MST) for equipment xx was found to be incorrect.	Inform site analyst.	CMS DSD ICK
MSF CATALOG CHAIN LINKAGE BAD. filenam STAGING ERROR, JOB=jobnam, FM=family, UI=userindex, CSU=id, MST=n, VSN=vsn, ASA=addr, STRM=s.	A linkage error was encountered on the MSF catalog.	A site analyst should run ASVAL to report on the problem and take appropriate corrective action. (Refer to section 3 of the NOS System Maintenance Reference Manual.)	EXSTGE
MSF CATALOG NOT ONLINE. filenam FOR jobnam NOT STAGED.	The staging of file filenam for job jobnam was abandoned because the MSF catalog was not on line. This condition exists when a removable family is mounted after MSSEXEC was initiated or when an I/O error occurred on the MSF catalog.	A site analyst should ensure that the MSF catalog is on line and recover from the I/O error, if necessary. Then restart MSSEXEC.	MSSEXEC

<u>MESSAGE</u>	<u>SIGNIFICANCE</u>	<u>ACTION</u>	<u>ROUTINE</u>
MSF HARDWARE PROBLEM. filenam FOR jobnam NOT STAGED.	The staging of file filenam for job jobnam was abandoned because an MSF hardware problem was detected.	Call customer engineer.	EXSTGE
MSI ABORTED INITIALIZE MAY NOT BE COMPLETE.	Initialization of mass storage device did not complete due to hardware/software failure.	Inform site analyst.	MSI
MSID CONFLICT WITH SENSE DATA. EST ORDINAL = xx. MSA MSID = y. UNIT MSID = z.	A conflict between the device MSID recorded in the EST of an MSS device and the sense information returned by MSSDRVR has been detected.	Inform site analyst.	MSSEXEC
MSSEXEC TERMINATING.	Informative message indicating that termination is in progress. The next line gives the reason for termination.	None.	EXMAIN
MST ERROR-ENTER GO OR DROP.	MST has detected an irrecoverable READ error.	Enter N.GO or N.DROP command for the control point.	MST
MST INITIALIZATION ABANDONED. CSU x, MST y, EST ORDINAL=zz.	The initialization of an MST has been abandoned.	Inform site analyst.	MSSEXEC
MST INITIALIZATION COMPLETE. CSU x, MST y, EST ORDINAL=zz.	The initialization of an MST has been completed.	None.	MSSEXEC
MT,Ccc,Eec,Hhhhhhhh,B.C.RESTART.	Magnetic tape controller controlware restarted.	None.	1MT
MT,Ccc,Eec,Hhhhhhhh,BAD ERASE.	Error detected after an erase was attempted to recover a write error.	Inform site analyst.	1MT
MT,Ccc,Eec,Hhhhhhhh,BID RECOVERY-x.	A single block mispositioning error was recovered by block ID recovery. If x is B, the error was caused by backspacing the tape too far; if x is F, the tape was not backspaced far enough.	None.	1MT
MT,Ccc,Eec,Hhhhhhhh,BLOCK TOO LARGE.	Data block is at least one byte longer than length bbbb shown in third line of message.	None.	1MT
MT,Ccc,Eec,Hhhhhhhh,BUSY.	Unit was still busy after 1 second.	Inform customer engineer.	1MT
MT,Ccc,Eec,Hhhhhhhh,CHANNEL ILL.	Channel is not accepting function for status requests properly.	Inform customer engineer.	1MT
MT,Ccc,Eec,Hhhhhhhh,CON.REJ.	Connect reject; unable to connect to the unit.	Inform site analyst.	1MT

<u>MESSAGE</u>	<u>SIGNIFICANCE</u>	<u>ACTION</u>	<u>ROUTINE</u>
MT,Ccc,Eec,Hhhhhhhh,CON REJ. MDI.	Connect reject; unable to connect to unit because of marginal detection indication (thermal warning). Unit turned off.	Inform customer engineer.	1MT
MT,Ccc,Eec,Hhhhhhhh,CON.REJ.OFF.	Connect reject; unable to connect to unit. Unit turned off.	Inform site analyst.	1MT
MT,Ccc,Eec,Hhhhhhhh,Fnff,Pyyyy.	Function ff was rejected by the controller; yyyy is the address in 1MT where the function was initiated.	Inform site analyst.	1MT
MT,Ccc,Eec,Hhhhhhhh,Lbbbb,Bnnnnn.	The length (bbbb) and block number (nnnnn) read from trailer bytes in block did not match the actual length or the block number read; given in previous message line.	None.	1MT
MT,Ccc,Eec,Hhhhhhhh,LOAD CHECK.	Load sequence failed on the unit.	Push CLEAR button and reload tape or contact site analyst.	1MT
MT,Ccc,Eec,Hhhhhhhh,MARGINAL DOWN.	Indicates controller failure. Channel has been logically turned off and maintenance is required.	Inform customer engineer.	1MT
MT,Ccc,Eec,Hhhhhhhh,MARGINAL OFF.	Unit has been logically turned off because of read/write failure. This occurred when a special function to check the read/write path to a unit failed during initial label scan. Maintenance is required.	Inform customer engineer.	1MT
MT,Ccc,Eec,Hhhhhhhh,NO EOP.	No end-of-operation detected from unit within 1 second.	Inform customer engineer.	1MT
MT,Ccc,Eec,Hhhhhhhh,NOISE.	A noise block was skipped on the tape.	None.	1MT
MT,Ccc,Eec,Hhhhhhhh,NOT READY.	Tape unit dropped ready status.	Make unit ready.	1MT
MT,Ccc,Eec,Hhhhhhhh,ON THE FLY.	Error was corrected as the data was read.	None.	1MT
MT,Ccc,Eec,Hhhhhhhh,POSITION LOST.	The last good block written cannot be found during write recovery.	None.	1MT
MT,Ccc,Eec,Hhhhhhhh,RECOVERED.	Previously reported error has been successfully recovered.	None.	1MT
MT,Ccc,Eec,Hhhhhhhh,STATUS.	Error type cannot be determined so actual controller status is returned.	Inform site analyst.	1MT
MT,Ccc,Eec,Hhhhhhhh,WRONG PARITY.	Tape was written in parity opposite that being read.	None.	1MT

MESSAGE

MT,Ccc-e-uu,vsn,rw,xx,Ss,GSgggggggg.
 MT,Ccc,Dddd...d.
 MT,Ccc,Uuu...u,Ttttt.
 MT,Ccc,Fff,Iii,Bnnnnnn,Lbbbb,Pppppppp.
 MT,Ccc,Eec,Hhhhhhhh,type.
 or
 MT,Ccc-e-uu,vsn,rw,xx,Ss,GSgggggggg.
 MT,Ccc,Dddd...d.
 MT,Ccc,Fff,Iii,Bnnnnnn,Lbbbb,Pppppppp.
 MT,Ccc,Eec,Hhhhhhhh,type.

SIGNIFICANCE

Four or five-line message describing a magnetic tape hardware malfunction on a 66x or 67x tape unit. Message as illustrated indicates 7-track, model 667 or 677 unit. If NT appears in place of MT, message indicates 9-track, model 669 or 679 unit. Message is issued to error log and dayfile.

The first line of each message provides the following information.

cc-e-uu Channel, equipment (tape controller), and physical unit number of tape unit on which error was encountered.
 vsn Volume serial number associated with tape on the specified unit.
 rw Read (RD) or write (WR) operation; any operation not involving an actual read or write is listed as a read.
 xx EST ordinal of the unit on which the tape was written. This is provided only for labeled tapes generated under NOS; otherwise, the field is blank.
 s Channel status.
 gggggggg General status of magnetic tape unit. Last byte is block ID.

The MT,Ccc,Dddd...d line of the message provides the following information.

cc Channel number; the channel number is repeated to allow the analyst to associate this message with the first message if errors are occurring on more than one tape channel at the same time.
 ddd...d Detailed status of magnetic tape unit.

The MT,Ccc,Uuu...u,Ttttt line of the message provides the following information.

cc Channel number; repeated to associate this message with the previous messages.
 uu...u Unit status of the magnetic tape unit.
 tttt Third byte of the tape unit format parameters (refer to the magnetic tape subsystem reference manual for

ACTION

Refer to the separate listing of the last line message (MT,...,type.) for the appropriate action.

ROUTINE

1MT

MESSAGESIGNIFICANCEACTIONROUTINE

descriptions of unit format parameter fields).

The MT,Ccc,Fff,...,Pppppppp line of the message provides the following information.

cc Channel number; repeated to associate this message with the previous messages.
 ff Software function on which the error occurred.
 ii Error iteration; number of times error has been encountered on this unit without successful recovery.
 nnnnnn Block number on which error occurred.
 bbbb Length of block on which error occurred in octal bytes.
 ppppppp lMT internal error parameters.

The last line of each message provides the following information.

cc Channel number; repeated to associate this message with the previous messages.
 ec Octal error code value.
 hhhhhhhh Parameters passed to the tape unit for the format function (refer to the tape drive's hardware reference manual for descriptions of the unit format parameter fields).
 type Additional description of the error. Refer to individual listing of the last line message.

MTxx,Ccc, TURNED OFF.

A 7-track magnetic tape unit xx has been logically turned off due to function reject. If NT appears in place of MT, the message

Inform customer engineer.

lMT

indicates a 9-track tape unit.

xx EST ordinal of magnetic tape unit
 cc Channel number

MTxx, CAN'T ACCESS DATA.

Tape mounted on 7-track magnetic tape unit with EST ordinal xx has label information that does not allow the user access to data on that tape. If NT appears in place of MT, the message indicates a 9-track tape unit.

Mount correct tape or drop the job (refer to n.DROP command).

DSD

<u>MESSAGE</u>	<u>SIGNIFICANCE</u>	<u>ACTION</u>	<u>ROUTINE</u>
MTxx, NEEDS LABEL.	Tape mounted on 7-track magnetic tape unit with EST ordinal xx is unlabeled and the job requires a labeled tape. On labeled multireel files, all subsequent reels must be labeled. If NT appears in place of MT, the message indicates a 9-track tape unit. For a 9-track tape unit, this message can mean that a subsequent reel was mounted on the same unit as the previous reel, and it is labeled in the wrong conversion mode.	Mount correct tape.	DSD
MTxx, RING CONFLICT.	Ring status for 7-track tape mounted on magnetic tape unit with EST ordinal xx conflicts with ring status requested by the job. If NT appears in place of MT, message indicates a 9-track tape unit.	Correct ring status (insert or remove write ring) and remount tape.	DSD
MT STAT ERR.	The status from the tape controller is not correct.	Press the space bar to skip to the next program on tape.	TDX
MTxx, WRONG VSN.	Tape mounted on 7-track magnetic tape unit with EST ordinal xx does not have the volume serial number (VSN) requested by the job. If NT appears in place of MT, the message indicates a 9-track tape unit.	Mount tape with correct VSN as shown on the resource mounting preview (E,P.) display.	DSD
MTS FIRMWARE NOT FOUND.	Magnetic tape controller controlware is not in the system.	Inform site analyst.	IMT
MUX TABLE OVERFLOW.	Space sufficient to allocate the required table was not available. An internal change to the time-sharing executive is necessary.	Inform site analyst.	IAFEX TELEX
NAM ERROR - ILLEGAL ABH.	The application block header (ABH) sent to TAF by NAM is unrecognizable.	Inform site analyst.	TAF
NAM ERROR - ILLOGICAL ABT.	The application block type (ABT) sent to TAF by NAM is unrecognizable.	Inform site analyst and refer to the NAM Reference Manual.	TAF
NAM FUNCTION NOT FOUND.	TAF received a supervisory message from NAM which had an unrecognizable primary or secondary function code.	Perform a dump of TAF and NAM or inform site analyst.	TAF
NAM INITIATED INCORRECTLY - TRY N.NAM.	The operator attempted to initiate the network with the command X.NAM which is incorrect.	Initiate the network with the n.NAM command (refer to section 3).	NIP
NAM LOGICAL ERROR.	NAM sent TAF a message out of order or an unrecognizable message.	Inform site analyst.	TAF

<u>MESSAGE</u>	<u>SIGNIFICANCE</u>	<u>ACTION</u>	<u>ROUTINE</u>
NAM NOT AVAILABLE.	Informative message indicating that TAF is currently at a control point but NAM is not. Transactions can be initiated from batch only.	Bring NAM to a control point, if desired.	TAF
NAM PHYSICAL ERROR EC=ec.	NAM has detected a physical error indicated by error code ec.	Refer to the NAM Reference Manual for the meaning of this error code.	TAF
NAM REJECT.	During login processing, NAM rejected the terminal.	Inform site analyst.	TAF
NAM VERSION 1.1 LEVEL nnnn.	Informative message indicating that NIP has initialized successfully and is ready to process applications (including the supervisors). nnnn Current integration or PSR level	None.	NIP
NC IS NOT A POWER OF 2.	The number of catalog tracks specified must be a power of two.	Correct and enter GO.	MSI
NCF ASSIGNED,PFN=filenam,UN=userid	Informative message indicating that the NCF has been attached successfully. This message is followed by the date and time from the NCF verification record. filenam Name of NCF userid User name under which the NCF is stored	None.	NS
NCF ERROR - ec	An error has been detected during processing of the NCF. ec Error code 1 No verification record is present 2 The NPU record which was expected is missing 3 The host record which was expected is missing 4 The network record which was expected is missing 5 No NCF is present with which to build tables	Assign another NCF file.	NS
NCF NOT AVAILABLE(,PFN=filenam,UN=userid)	The NCF to be used by NS could not be attached. If PFN and UN are not shown, a default NCF was not specified by the installation. filenam Name of NCF userid User name under which NCF is stored	Assign another NCF file.	NS

<u>MESSAGE</u>	<u>SIGNIFICANCE</u>	<u>ACTION</u>	<u>ROUTINE</u>
NDL COMPLETE.	The NDL processor has finished all possible work on its input and ended its execution.	None.	NDLMAIN
NEED AT LEAST xx SUBCONTROL POINTS.	There are more CM resident tasks defined than subcontrol points. If non-CM resident tasks exist, there must be at least one more subcontrol point than there are CM resident tasks.	Reinitialize the transaction executive and assign more subcontrol points, or reduce the number of CM resident tasks.	TAF
NETOFF COMPLETE.	Informative message indicating that TAF is no longer communicating with NAM. NAM initiated shutdown procedures prior to loss of communications.	When NAM is available, the central site console operator command K.NAMON can be used to resume communications between TAF and NAM.	TAF
NETON ACCEPTED.	Informative message indicating that RBF entered the network successfully.	None.	RBF
NETON COMPLETE.	Informative message indicating that TAF is communicating with NAM.	None.	TAF
NETVAL NETON REJECTED.	Dayfile and operator message indicating that NAM is either not running or has not yet been initialized.	Perform one of the following. - Initiate NAM if it is not running. - Wait for initialization to complete. - Drop NVF.	NETVAL
NETwid NETWORK FILE ERROR.	An error was detected during processing of the NETwid file. This could be due to a hardware error or a file description entry error.	Verify the file using the VALNET utility (refer to NOS System Maintenance Reference Manual).	IAFEX TELEX
NETWORK ACTIVITY TABLE OVERFLOW.	Space sufficient to allocate the required table was not available. An internal change to IAF is necessary.	Inform site analyst.	IAFEX
NETWORK CARDS IGNORED.	A communications multiplexer defined in the NETWORK file was not found.	Inform site analyst.	TELEX
NETWORK DESCRIPTION FILE NOT FOUND.	A NETwid and/or NCTFid file is not present under the system user index for terminal communications.	Inform site analyst.	TAF
NETWORK FILE NOT FOUND.	A network description file was not found under the system user index.	Refer to the NOS Installation Handbook for instructions on use of network description file.	IAFEX TELEX

<u>MESSAGE</u>	<u>SIGNIFICANCE</u>	<u>ACTION</u>	<u>ROUTINE</u>
NETWORK SHUT DOWN DETECTED.	Self-explanatory.	None.	TAF
NIP FATAL ERROR PROC = name.	NIP has detected a fatal error and will abort after taking a dump. This message usually indicates an internal problem within NIP or the operating system. name First 4 characters of the NIP procedure from which the message was issued	Supply dumps to site analyst.	NIP
NIP RECEIVED BAD BSN.	Informative message indicating that the block sequence number that NAM expected and what it actually received were different. If compiled with DEBUG on, NIP aborts; otherwise, NIP continues.	None.	NIP
NIP/SCP ERROR RC=ec JOBID=jobid.	Informative message indicating that NIP has received an error response with code ec from the operating system as the result of a system control point call. NIP takes a dump; if DEBUG is on and the error was fatal, NIP aborts. Fatal error codes usually indicate an internal problem within NIP or the operating system. ec Error code which caused response 41 Invalid job identifier; fatal. 42 Bad NIP address; fatal. 43 Application passed bad address to NIP; fatal for application. 44 Application rolled out; nonfatal. 45 Specified application is not found in system; nonfatal. 57 Long term connection already exists between NIP and application; fatal. 60 Long term connection request rejected; fatal. 61 Long term connection does not exist between NIP and application; fatal. 62 Number of words transferred between subsystem and application is over allowed limit; fatal. 63 Short term connection does not exist between NIP and application; fatal or nonfatal. 64 NIP is not established with	Supply dumps to site analyst.	NIP

<u>MESSAGE</u>	<u>SIGNIFICANCE</u>	<u>ACTION</u>	<u>ROUTINE</u>
	application; fatal. 65 NIP attempted to set illegal error flag; fatal. 66 NIP attempted to set illegal dayfile processing flag; fatal.		
	jobid Job identifier passed to NIP from the operating system		
NIP SHUTDOWN COMPLETE.	Informative message issued during network shutdown procedures after all the supervisors have terminated. NIP will terminate normally.	None.	NIP
NIP UNABLE TO FIND FAILED APP jobid.	Informative message indicating the operating system informed NIP that an application failed but NIP is unable to locate the application specified. NIP assumes the application is not on the network or has already terminated. jobid Job identifier passed to NIP from the operating system	None.	NIP
NM=1fn.	File 1fn is not found on deadstart device.	Redeadstart. If message persists, inform site analyst.	CDX
NO ACCOUNT/USER CARD IN xxJ FILE.	The ACCOUNT or USER statement in the xxJ file is not present, causing the transaction subsystem to abort.	Add ACCOUNT or USER statement in xxJ file. Consult the TAF data base administrator.	TAF
NO BC LOAD ON PREASSIGN.	User requested to load tape controlware when using tape preassignment.	Correct control statement parameters and reenter.	CVL
NO CRAS TERMINAL DEFINED.	Informative message indicating that no CRAS terminal is defined in the terminal validation file.	None.	TAF
NO DATA BASE ID FOR DATA MANAGER.	At least one data base identifier must be specified on each active (ON) DMS statement.	Add data base identifier to DMS statement(s) or specify status as OFF.	TAF
NO DATA BASE NAME IN xxJ FOR TOTAL.	Self-explanatory.	Add data base name to xxJ file.	TAF
NO EQUIPMENT.	No communications multiplexer has been defined in the equipment status table (EST).	Inform site analyst.	1TD

<u>MESSAGE</u>	<u>SIGNIFICANCE</u>	<u>ACTION</u>	<u>ROUTINE</u>
NO EQUIPMENT AVAILABLE.	BATCHIO manager determined that no equipment (card reader, card punch, and/or line printer) is defined in system.	Inform site analyst; system must be dead-started in order to define equipment in EST.	IIO
NO EXCEEDS 200B TRACKS.	The number of catalog tracks specified for device exceeds the limit allowed.	Correct and enter GO.	MSI
NO INITIALIZE REQUESTS SET FOR MSI.	MSI was called by some means other than the INITIALIZE command (for example, X.MSI.), and initialize status is not currently set for any mass storage devices.	None.	MSI
NO JOBS IN SYSTEM.	Informative message indicating that the time-sharing subsystem has successfully deactivated all terminal-originated activities that were in the system.	None.	IAFEX TELEX
NO LINES CONFIGURED ON THIS NPU	The NPU specified in the status message immediately preceding this message has no configured lines. This message may be given in reponse to a request for status of all lines or all terminals on the network or a specific NPU.	None.	CS
NO LINK DEVICE DEFINED.	Operator message indicating that a link device (ECS) was not identified in CMRDECK during an attempt to deadstart into a multimainframe environment.	Redeadstart and identify the link device with LINK=xx. command.	SET
NO OVERLAY LOADED/ACTIVE	The network operator tried to send data to an overlay or terminate an overlay when there were none active.	None.	NS
NO SHARED DEVICES FOR THIS MACHINE.	The machine on which MREC is being run is not in multimainframe mode; therefore, it cannot access any devices on an inoperative machine.	None.	MREC
NO SYSTEM DEVICE DEFINED.	Operator message indicating that the mass storage device on which the system is to be loaded has not been defined.	Define the system device with the SYSTEM=n. command or redeadstart and specify a system device with bits 0 through 5 of word 14 on the deadstart panel.	SET ICM
NO TAPE EQUIPMENT.	There is no magnetic tape equipment currently defined in the system.	Inform site analyst.	IMT

<u>MESSAGE</u>	<u>SIGNIFICANCE</u>	<u>ACTION</u>	<u>ROUTINE</u>
NO TERMINALS CONFIGURED ON THIS LINE	The line specified in the status message immediately preceding this message has no configured terminals. This message may be given in response to a request for status of a single terminal or all terminals connected to a line, an NPU, or the network.	None.	CS
NO TERMINALS CONNECTED TO THIS APPL	Informative message given in response to a request for status of all terminals connected to an application. There are no terminals connected to the application.	None.	CS
NO TERMINALS DEFINED.	A terminal count of zero was determined during initialization.	Verify the network description file using the VALNET utility (refer to Installation Handbook). Assume any stimulated or multiplexer devices to be used are on in the EST.	IAFEX TELEX
NO 667x MULTIPLEXER.	Either the multiplexer defined in the equipment status table (EST) failed to respond to initialization status check, or no multiplexer is on channel.	Inform site analyst or customer engineer.	1TD
NONSHARED DEVICE ACTIVE IN DAT.	A nonshared device accessed by another mainframe (as determined by MID/machine index) is described in the device access table with the same family name and device number as the device being recovered. Recovery is impossible. Preceded by message RECOVERY,dtxx, which indicates the equipment in error.	Redeadstart with correct configuration for equipment in error.	RMS CMS
NOP/NIP NOT ALLOWED TO LOAD D/L OVERLAY	The network operator attempted to load the dump/load overlay (overlay name DLO) into an NPU. Only the Network Supervisor program (NS) is allowed to do this.	None.	NS
NOT ALL EQUIPMENT SERVICEABLE.	Number of local batch devices defined in the system (card readers, card punches, and line printers) exceeds maximum of 24B allowed.	Inform site analyst.	110
NOT AUXILIARY PACK.	An attempt was made to define a nonauxiliary device as a private pack.	Correct and enter GO.	MSI
NOT SYSTEM ORIGIN JOB	Dayfile message indicating that an attempt was made to initiate CYBERLOG from a job other than a system origin job. The job aborts.	None.	CYBRLOG

<u>MESSAGE</u>	<u>SIGNIFICANCE</u>	<u>ACTION</u>	<u>ROUTINE</u>
NP GREATER THAN 8.	Number of packs specified for multispindle device cannot exceed eight.	Enter correct number of packs and then enter GO.	MSI
NP NOT ALLOWED.	The NP parameter (number of packs) was specified and the device to be initialized is not a pack type device.	Correct and enter GO.	MSI
NPU: npu,status,node	NPU status message sent in response to a STATUS command, or when a significant change in status has occurred. npu Name of NPU status Status of NPU DI Disabled EN Enabled AC Active DN Down node Node number	No action required if response to STATUS command. Check dayfile for subsequent messages which might indicate a change in status.	NS
NPU npu/O/L SEQ. PREEMPTED FOR DLO	Because of a remote NPU failure, the load of a diagnostic overlay was terminated so a dump/load overlay could be loaded.	None. The diagnostic overlay can be loaded after the NPU is loaded.	NS
NPU npu - OVDAT/DATA/SM ERROR INVALID PORT=prt OR SUBPORT=spt	NS received a dump/load sequence supervisory message concerning a connection which is not being used for dumping or loading. A possible cause for this is an improperly built CCP file. npu Name of NPU prt 3-character identifier of port spt 3-character identifier of subport	Verify CCP file.	NS
NPU npu/OVERLAY ovl LOADED	The overlay has been loaded in the NPU. npu Name of the NPU ovl 3-character identifier of overlay	None.	NS
NPU npu/OVERLAY ovl NOT LOADED, RC=ec	An attempt to load an overlay was unsuccessful. npu Name of the NPU ovl 3-character identifier of overlay ec Error code 1 Checksum error on load detected 2 Unrecognizable overlay ID 3 NPU disabled 4 Priority overlay active 5 NPU off 6 Overlay active 7 Overlay load in progress 8 Load pre-empted by dump/load 9 NPU failed during load 10 Time for NPU response expired	None.	NS

<u>MESSAGE</u>	<u>SIGNIFICANCE</u>	<u>ACTION</u>	<u>ROUTINE</u>
NPU npu/OVERLAY TERMINATED	An overlay in the specified NPU was terminated because of the failure or reload of a remote NPU.	None.	NS
NPU npu/OVERLAY ovl TERMINATED	The network operator terminated the overlay. npu Name of the NPU ovl 3-character identifier of overlay	None.	NS
NPU RECOVERED	NS has recovered this NPU.	None.	NS
NPU RECOVERY IN PROGRESS	NS is recovering the NPU but is currently waiting for response from NAM.	None.	NS
NPU UNAVAILABLE	The NPU is not physically available because of an NPU failure or a coupler failure. In the case of a remote NPU, a trunk may have failed or all other physical paths to the host may be inoperative (that is, all NPUs local to the remote NPU have failed or all trunks to the remote NPU are inoperative or disabled).	Wait for NPU to reload. In the case of a remote NPU, enable a disabled trunk.	NS
NS CODE LEV=yyy, NCF CODE LEV=xxx	Informative message indicating that the code level xxx at which the NCF was created is not the same as the present code level yyy of NS.	Rerun NDLP to create new NCF.	NS
NT....	Refer to description of MT.... series of messages.		
NTxx,Ccc, 200 IPS GCR UNIT ON 1X PPS.	A 679 magnetic tape unit capable of 6250 cpi is configured on a system with 1X PPU speed. 6250 cpi operations may not be valid. xx EST ordinal of tape unit cc Tape unit channel	Inform site analyst.	1MT
NTxx DENSITY MISMATCH.	The tape mounted on magnetic tape unit xx has a density which cannot be read by this particular unit. An input tape of 800 cpi is mounted on a 1600/6250 cpi unit, or an input tape of 6250 cpi is mounted on an 800/1600 cpi unit.	Remount the tape on a tape unit capable of reading the density, or, if tape is to be written instead of read, remount with write ring in.	RESEX
NTxx DRIVE CONFLICT.	A tape with 1600 cpi density is mounted on magnetic tape unit xx but actual assignment of the tape to unit xx would result in a resource deadlock for the job.	Unload the tape and mount it on a unit with opposite density (that is, if the tape is on an 800/1600 cpi unit, mount it on a 1600/6250 cpi unit).	RESEX

<u>MESSAGE</u>	<u>SIGNIFICANCE</u>	<u>ACTION</u>	<u>ROUTINE</u>
NULL DESCRIPTION FILE.	Self-explanatory.	Create a description file (NETwid, SIMfid, or NCTFid where id is the machine identifier).	TAF
NVF NETOFF, NAM NOT PRESENT.	NVF attempted to interface with NAM when NAM was not running and therefore NVF terminated.	None.	NETVAL
NVF NETON REJECTED BY NAM.	NVF's attempt to interface with NAM was rejected even though NAM was initialized and network shutdown was not in progress.	Enter ENABLE, NVF. If this does not work, drop the network and inform the site analyst.	NETVAL
NW01 node,ecpn code.	An error has been detected on the network. node Node number of the equipment with the error. ec Error code. pn Port number. code Hexadecimal code for error messages produced for this message.	Refer to the Communications Control Program Reference Manual for documentation of the error message.	NS
NW01,hhhh,FFcc sss.	Error log message indicating that the interface between PIP and the NPU/coupler is not working properly. hhhh Coupler node cc One of the following error codes. 1 Channel empty too long or inactive 2 Channel active too long after function 3 Channel full after output 4 (Reserved) 5 Coupler did not put status on channel 6 Error retry on input transmission 7 Channel full after activate on channel 8 Channel inactive after output 9 Channel full before function tried A Read interrupted by disconnect B Waited for NPU status change too long C Incorrect coupler status after write D NPU dead E Inbound message too long F Abnormal coupler status register contents (sss = 12-bit register contents	Inform site analyst.	PIP NS

<u>MESSAGE</u>	<u>SIGNIFICANCE</u>	<u>ACTION</u>	<u>ROUTINE</u>
	<p>in hexadecimal code). 11 NPU load memory compare error. sss Contents of 12-bit register if cc=F. Otherwise 000.</p>		
OBSOLETE MSF CATALOG ONLINE. filenam FOR jobnam NOT STAGED.	The staging of file filenam for job jobnam was abandoned because an obsolete MSF catalog was used.	Recover the current copy of the MSF catalog. A site analyst should run ASVAL to analyze the MSF catalog and the PFC entries (refer to section 3 of the NOS System Maintenance Reference Manual).	EXSTGE
OFF TASK tasknam-LIBRARY libnam.	Task tasknam in task library libnam could not be loaded from ECS or recovered and loaded from mass storage. Task was turned off. Transactions using tasks will abort.	Inform site analyst. Library must be recreated.	TAF
ON LINE xx. LOG IN XX. ACTIVE xx.	Informative message indicating activity at EXPORTLS control point. This message appears at the EXPORTLS control point on the DSD job status (B) display.	None.	DSD
ONLY 0-9,*NEXT*,*END*, OR *CYB*, ALLOWED	A format error was made for an entry on the editing display in response to the CYBERLOG display.	Reenter the digit or command in the correct format.	CYBRLOG
OPERATOR DROP.	Informative message indicating that the operator dropped the job.	None.	DSD 1AJ
OPERATOR IDLE DOWN.	The operator dropped TAF.	None.	TAF
OPERATOR IDLE OF EXEC.	Informative message indicating that the operator has idled MSS.	None.	EXMAIN
OPERATOR KILL.	Informative message indicating that operator killed job. (Refer to KILL command, section 3.)	None.	DSD
OPERATOR STOP.	Informative message indicating that the operator has stopped TAF.	None.	TAF
OSB NOT FOUND ON TAPE.	The deadstart tape does not contain the operating system.	Verify that the operating system is on the deadstart tape and redeadstart. If message persists, inform site analyst.	EBL

<u>MESSAGE</u>	<u>SIGNIFICANCE</u>	<u>ACTION</u>	<u>ROUTINE</u>
OUTPUT DISCARDED	The terminal user entered one of the user break keys, which discarded messages queued for the network or local operator terminal.	None.	CS
OUTPUT FILE BAD.	System sector of output file is in error; file is purged.	None.	REC
OVERLAY ovl BEING LOADED - TRY LATER	The network operator entered an OVERLAY, LOAD command while an overlay was being loaded. ovl 3-character identifier of overlay being loaded	Reenter the command at a later time.	NS
OVERLAY DATA EXCEEDS 22 CHARACTERS	The network operator entered data for an overlay which exceeded 22 characters.	Correct data and reenter command.	NS
OVERLAY ID ERROR - FIRST CHARACTER INVALID	The network operator entered an overlay name which was not in the range A through O.	Correct overlay name and reenter command.	NS
OVERLAY ID ERROR - INVALID CHARACTER	The network operator entered an overlay name containing a character which was not in the range A through 9.	Correct overlay name and reenter command.	NS
OVERLAY ID ERROR-3 CHARACTER NAME REQUIRED	The network operator entered an overlay name which was not exactly 3 characters.	Correct overlay name and reenter command.	NS
OVERLAY LOAD ACTIVITY - TRY LATER	The network operator entered an OVERLAY command while an overlay was being loaded into the NPU.	Reenter the command at a later time.	NS
OVERLAY ovl LOADED - MUST DROP FIRST	The network operator tried to load an overlay without terminating the previous overlay. ovl 3-character identifier of overlay currently loaded	Drop the current overlay (refer to OVERLAY,DROP command in section 7) and reenter the OVERLAY,LOAD command.	NS
PARAMETER VALUE EXCEEDS 7 CHARACTERS	No parameter values except data strings in the OVERLAY and MSG commands can be more than 7 characters in length.	Correct parameter and reenter the command.	CS
PARITY ERROR ON DATA RCVD FROM EXT CHANNEL.	A parity error was detected on data received from an external channel.	Inform site analyst and customer engineer.	SCE
PARITY ERROR ON DATA XMTD FROM EXTERNAL PP.	A parity error was detected on data transmitted from a PP.	Inform site analyst and customer engineer.	SCE
PERIOD REQUIRED	A comment entry on the editing display for CYBERLOG did not terminate with a period.	Enter a period.	CYBRLOG
PF LENGTH ERROR userin filename.	Interlock data in system sector of queued file indicates that the last sector of the file (specified by TRT) was not an EOI sector.	Inform site analyst. On a level 3 recovery, the system sets error idle status for the	REC

<u>MESSAGE</u>	<u>SIGNIFICANCE</u>	<u>ACTION</u>	<u>ROUTINE</u>
	userin User index of file in error filename Name of file on which error was encountered	device. On a level 0 recovery, enter n.DROP to set error idle status for the device. Enter n.GO to continue recovery.	
PF LINKAGE ERROR.	Operator message indicating that an error was encountered while recovering a preserved file during a level 0 deadstart. Preceded by message RECOVERY,dtxx, which indicates the equipment in error. dt Device type xx EST ordinal	Redeadstart and initialize device. Preserved files on device are lost, and must be re-loaded.	RMS
PFC RELOAD ERROR. pfn FOR jobname NOT FOUND ON MSF. REPLY GO TO CONTINUE	K-display message indicating that the PFC entry for a file being staged from MSF to disk did not correspond to the file data on MSF. A probable cause of this system error is the use of obsolete permanent file dump tapes for reloading a device or a set of permanent files. pfn Permanent file name jobname Job name	Ensure that obsolete dump tapes were not used and if they were, take appropriate action. Enter K.m.GO to clear the message. m Message ordinal	EXSTGE
PFM ERROR ec ON filename	An error was detected on the file by the permanent file manager. ec Error code. Refer to the NOS Reference Manual, volume 2 for PFM error codes. filename Type of file on which error was detected (such as NCF, LCF, CCP, and so on).	For file types NCF, LCF, and CCP, this message is followed by the message type NOT AVAILABLE where type is CCP, LCF, or NCF. Refer to that message for appropriate action.	NS CS NVE
PFM ERROR ec PFN= filename UN= usernam.	MCS could not attach indicated file. ec PFM error code filename File name usernam User name	Refer to the NOS Reference Manual, volume 2 for a list of the error codes.	MCS
PIP - BUFFER CHAIN ERROR.	PIP has detected errors in the outbound buffer chain in NIP's field length. This message ususally indicates a buffer management error in NIP. If DEBUG is defined at assembly time, PIP hangs the PP; otherwise, PIP aborts NAM.	Supply dumps to site analyst.	PIP
PIP - CM ADDRESS OUT OF RANGE.	PIP has detected a CM address with a field length that is too large. If DEBUG is defined as assembly time, PIP hangs the PP; otherwise, PIP aborts NAM.	Supply dumps to site analyst.	PIP

<u>MESSAGE</u>	<u>SIGNIFICANCE</u>	<u>ACTION</u>	<u>ROUTINE</u>
PIP - FET IN PTR EXCEEDS LIMIT PTR.	PIP has detected the IN pointer exceeding the LIMIT pointer in the NPU's input FET. This message appears if PIP is assembled with DEBUG defined. PIP hangs the PP.	Supply dumps to site analyst.	PIP
PIP - INVALID ACT.	PIP has detected an invalid application character type value in a downline block. If DEBUG is defined at assembly time, PIP hangs the PP; otherwise PIP aborts NAM.	Supply dumps to site analyst.	PIP
PIP - MESSAGE EXCEEDS BUFFER SIZE.	PIP cannot transfer an upline message to NIP's inbound buffer because the message is too large for NIP's current inbound buffer. This message usually indicates a PIP error in upline transmission and appears only if PIP is assembled with DEBUG defined. PIP hangs the PP.	Supply dumps to site analyst.	PIP
PIP - MESSAGE EXCEEDS MAX LENGTH.	PIP has detected an upline block that is larger than 2043 characters. If DEBUG is defined at assembly time, PIP hangs the PP; otherwise, PIP aborts NAM.	Supply dumps to site analyst.	PIP
PIP - NPU FET ERROR.	PIP cannot locate an NPU FET in NIP's field length. This message usually indicates a NIP error in building the NPU FET. If DEBUG is defined at assembly time, PIP hangs the PP; otherwise, PIP aborts NAM.	Supply dumps to site analyst.	PIP
POINTER ERROR - RECOVERY IMPOSSIBLE.	The time-sharing subsystem has encountered incorrect internal pointers during recovery. These pointers could be the terminal table pointer or the pot pointer. Recovery terminates and reloading is attempted.	Restart the time-sharing subsystem.	IAFEX TELEX
POOL FILE - filename NOT FOUND IN EDT.	The pool file xxERPF contains a record for file filename not defined in the EDT for data base xx. A CRAT entry is not made for the record for this file.	Inform site analyst.	BDMI TAF
POSSIBLE BLOCKAGE AMONG CM RESIDENT TASKS.	The sum of the maximum field lengths (MFLs) for the CM resident tasks exceeds the minimum size of the total task area (potential space available to contain tasks). Thus one or more CM resident tasks could be blocked from completing.	Correct error.	TAF
POSSIBLE SPR ABORT CONDITION.	IAF attempted to increase the number of pot link table (PLT) entries beyond the maximum number of pots allowed. This is caused by a request for more pots than are available.	Inform site analyst.	IAFEX

<u>MESSAGE</u>	<u>SIGNIFICANCE</u>	<u>ACTION</u>	<u>ROUTINE</u>
POT LINK TABLE OVERFLOW.	Space sufficient to allocate the required table was not available. An internal change to the time-sharing executive is necessary.	Inform site analyst.	IAFEX TELEX
POTENTIALLY BLOCKED TASKS DETECTED.	During TAF initialization, potentially blocked tasks were detected. Preceding error messages contain additional details.	Correct error.	TAF
POWER DOWN.	Bits 36 and 37 of the status/control register are set, indicating detection of a power failure and abnormal environmental condition. This message is preceded in the error log by the characters SR hh.mm.ss. where hh.mm.ss is the time at which the condition was detected.	Inform site analyst and customer engineer. (For further explanation and procedures, refer to S/C Register Error Detection, appendix F.)	IMB
POWER DOWN. REPLY GO TO RETRY - DROP TO OFF DEVICE.	K-display message indicating that the cartridge storage unit or mass storage transport (as indicated in line 1 of message) is defined as available in the EST, but the power is turned off.	Verify that the device has the power turned on and enter K.m.GO. If the device is not to be used, enter K.m.DROP. m Message ordinal	MSSEXEC
POWER/ENVIRONMENT NORMAL.	Bits 36 and 37 of the status/control register (bit 0 of the interlock register) are clear after one or both were set. This message is preceded in the error log by the letters SR hh.mm.ss (CYBER 170 machine) or IR hh.mm.ss. (CYBER 70 machine) where hh.mm.ss is the time at which the condition was detected.	Inform site analyst and customer engineer. (For further explanation and procedures, refer to S/C Register Error Detection, appendix F.)	IMB
POWER FAILURE.	Bit 36 of the status/control register (bit 0 of the interlock register) is set, indicating a main power failure. This message is preceded in the error log by the letters SR hh.mm.ss. (CYBER 170 machine) or IR hh.mm.ss. (CYBER 70 machine) where hh.mm.ss. is the time at which the condition was detected.	Inform site analyst and customer engineer. (For further explanation and procedures, refer to S/C Register Error Detection, appendix F.)	IMB
PP BUSY.	PP is currently busy and has not been able to respond to the request.	If message persists, contact site analyst.	DSD
PP HUNG.	One or more PPUs have attempted to perform an illegal operation. The PP becomes hung because CPUMTR does not clear the output register. Operator message.	The recommended procedure is as follows. 1. Perform an express deadstart dump. 2. Attempt level 3 deadstart; if not successful, try level 0. 3. Retain dump tape for site analyst.	CPUMTR

<u>MESSAGE</u>	<u>SIGNIFICANCE</u>	<u>ACTION</u>	<u>ROUTINE</u>
PP pp STOPPED ON PARITY ERROR - PPM.	Peripheral processor pp has stopped because of a memory parity error.	Inform site analyst and customer engineer. (For further explanation and procedures, refer to S/C Register Error Detection, Appendix F.)	SCE
PPU ERROR.	A hardware error was detected in a PPU.	Inform site analyst and customer engineer.	SCE
PRESET NOT ALLOWED.	This is not the first machine being deadstarted in a multimainframe environment and the PRESET command is not needed.	Attempt another deadstart without entering the PRESET command.	RMS
PRIMARY LINK RESET ON PORT nn.	An irrecoverable line error has occurred on port nn serviced by the CCP X.25 Terminal Interface Program. Following the error CCP automatically performed a link reset. The reset can cause packet level errors to occur. Repeated occurrences of this message may indicate software problems or poor transmission characteristics of the line.	None.	CCP
PRIOR ENABLES/DISABLES IGNORED	A new NCF or LCF has been assigned and certain ENABLE/DISABLE commands are ignored. For a new NCF, ENABLE/DISABLE commands for NPUs and logical links are ignored. For a new LCF, ENABLE/DISABLE commands for lines and applications are ignored.	Reenter the desired ENABLE/DISABLE commands.	NS CS
PROCESSING COMPLETE.	Informative message.	None.	MREC
PUT DEVICE ON LINE. RESPOND GO TO RETRY - DROP TO OFF DEVICE.	K-display message indicating that the cartridge storage unit or mass storage transport (as indicated in line 1 message) is off line.	Verify that the device is on line and enter K.m.GO. If the device is not to be used, enter K.m.DROP. m Message ordinal	MSSEXEC
PUT FAILURE, X=x, Y=y. RESPOND GO TO ACKNOWLEDGE.	K-display message indicating that the cartridge storage unit was unable to place the cartridge into cubicle X=x, Y=y because of a hardware error. The cartridge was placed in the lower I/O drawer. x X coordinate of the cubicle (0-57) y Y coordinate of the cubicle (0-36)	Enter K.m.GO to clear the message. Run ASLABEL to restore the cartridge to the cartridge storage unit (refer to the NOS System Maintenance Reference Manual). m Message ordinal	MSSEXEC

<u>MESSAGE</u>	<u>SIGNIFICANCE</u>	<u>ACTION</u>	<u>ROUTINE</u>
QAC ILLEGAL REQUEST.	One of the following conditions has occurred. Dayfile message. <ul style="list-style-type: none"> - QAC was called by a control point which did not have priority greater than MXPS. - Parameter block was not in the field length. - Complete bit was not cleared on the call. - Function code was invalid. - Parameter block was less than seven words long. 	Inform site analyst immediately to determine which condition caused the error.	QAC
QF LENGTH ERROR filename.	Interlock data in system sector of queued file indicates that the last sector of the file (specified by TRT) was not an EOI sector. filename Name of file on which error was encountered	Inform site analyst. On a level 3 recovery, the system sets error idle status for the device. On a level 0 recovery, enter n.DROP to set error idle status for the device. Enter n.GO to continue recovery.	REC
RANDOM ADDRESS ERROR.	Dayfile message indicating that an error was encountered while building the system library. The random address is not on file.	Attempt another deadstart. If the error persists and the system has worked previously, call a customer engineer and test memory and RMS.	SLL
RBF DISK ERROR, CANNOT REDUCE SIZE.	Because of a disk error, RBF cannot perform periodic field length reduction. RBF processing is unaffected, but CM usage is higher than normal.	To lower CM usage by RBF, idle down RBF and restart.	RBF
RBF ENDED.	Informative message indicating that RBF has terminated.	None.	RBF
RBF NOT ENABLED.	RBF attempted to enter the network but was rejected because it was disabled by the local operator.	Enable RBF and retry the operation.	RBF
RBF NOT STARTED PROPERLY, USE N.RBF.	An attempt was made to initiate RBF incorrectly, such as with an X.RBF command.	Initiate RBF with the n.RBF command (refer to section 3). The copy of RBF started incorrectly is dropped automatically.	RBF
READ PYRAMID PARITY ERROR.	A parity error was detected in a read pyramid.	Inform site analyst and customer engineer.	SCE

<u>MESSAGE</u>	<u>SIGNIFICANCE</u>	<u>ACTION</u>	<u>ROUTINE</u>
REASSIGN ADL.	Informative message.	Enter n.CFO.ADL command.	MCS
RECORD NOT FOUND.	Error was encountered during the building of the system library. An attempt was made to place a nonexistent routine on an alternate system device. Deadstart processing halts when this error is detected.	Attempt another deadstart. If the error persists, inform the site analyst.	SYSEDIT
RECOVERING EQxx Annnn.	Informative message indicating that direct access files on the specified logical track of mass storage device xx are being recovered. xx EST ordinal of device nnnn Logical track number	None.	REC
RECOVERING PF EQxx, TRKnnnn.	Informative message indicating that preserved files on the specified logical track of device xx are being recovered. xx EST ordinal of device nnnn Logical track number	None.	IMR
RECOVERY, dtxx.	Informative message indicating mass storage device being recovered during system deadstart. dt Device type xx EST ordinal of device	None.	RMS
RECOVERY COMPLETE.	Informative message indicating that a level 3 recovery deadstart was successful and the magnetic tape subsystem was recovered.	None.	MAGNET
RECOVERY COMPLETE.	Informative message issued during deadstart; indicates end of REC processing and start of system loading, or recovery, depending upon level of deadstart selected.	None.	REC
RECOVERY COMPLETE.	The transaction executive or time-sharing subsystem has successfully completed recovery.	None.	TAFNAM2 TAFTS2 IAFEX TELEX
RECOVERY FILE LENGTH/ERROR.	The length of the memory file exceeds one track.	Inform site analyst. The file length variable in ISF must be reset.	ITA
RECOVERY FILE NOT FOUND.	While attempting to attach the SALVxx file, the time-sharing executive received a status indicating the file was not found.	Ensure that ISF was run for the default family. If so, inform site analyst.	IAFEX TELEX
RECOVERY IMPOSSIBLE.	The magnetic tape subsystem was dropped or aborted, or a level 3 recovery deadstart was not successful.	Call magnetic tape subsystem to a control point if desired. Previous tape	MAGNET

<u>MESSAGE</u>	<u>SIGNIFICANCE</u>	<u>ACTION</u>	<u>ROUTINE</u>
RECOVERY IN PROGRESS.	Informative message indicating that the routine MAGNET1 is performing clean-up or recovery procedures for the magnetic tape subsystem.	assignments are not recovered. - Retry with correct terminal number. - None. - None.	MAGNET
RECOVERY IN PROGRESS.	The time-sharing subsystem or the transaction executive has begun recovery procedures due to an abort or termination condition.	None.	TAFNAM2 TAFTS2 IAFEX TELEX
RECOVERY, WAITING MMF DEADSTART IN PROGRESS.	The device access table in ECS resident is currently interlocked by another machine, indicating that machine is deadstarting.	Verify that another machine is deadstarting. If not, inform site analyst.	RMS
REENTRY TABLE OVERFLOW.	Space sufficient to allocate the required table was not available. An internal change to the time-sharing executive is necessary.	Inform site analyst.	IAFEX TELEX
REMOVABLE DEVICE CONFLICT.	Removable/nonremovable status of a shared device as specified in the CMRDECK conflicts with the status determined by the mainframe which originally recovered the device. If detected by CMS, configuration error status is set. Recovery is impossible.	Retry after determining the correct removable/nonremovable status.	CMS RMS
REP xx,nn.	System dayfile message indicating that the operator requested BATCHIO equipment xx to repeat the current file nn times.	None.	QAP
REPORTR-BAD DM PARAMETER NO DUMP ASSUMED.	A value other than Y or N was specified for DM parameter. N is assumed.	None.	REPORTR
REPORTR-BAD INPUT FILE PROGRAM ABORTED.	A wrong input file was given to REPORTR.	Correct problem and retry.	REPORTR
REPORTR-COMPLETED.	Informative message indicating a successful run.	None.	REPORTR
REPORTR-CONTROL CARD ERROR, PROGRAM ABORTED.	Unrecognized keyword in control statement was detected.	Correct error and rerun.	REPORTR
REPORTR-DUMP TIME INTERVAL ERROR, PROGRAM ABORTED.	D1 is less than D2.	Correct error and rerun.	REPORTR
REPORTR-EMPTY INPUT FILE, PROGRAM ABORTED.	Input file was not found.	Correct problem and retry.	REPORTR

<u>MESSAGE</u>	<u>SIGNIFICANCE</u>	<u>ACTION</u>	<u>ROUTINE</u>
REPORTR-ILLEGAL NUMBER ON CONTROL CARD.	Alphabetic character was detected in a field where a numeric value was expected.	Correct problem and retry.	REPORTR
REPORTR-INVALID REPORT NUMBER, PROGRAM ABORTED.	Report number greater than 7 or less than 1 was specified on control statement.	Correct error and rerun.	REPORTR
REPORTR-ZERO TIME RECORD NOT FOUND.	Either a bad or an incomplete STIM run occurred.	Rerun STIM and/or inform site analyst.	REPORTR
REQUEST filename, eq.	Job is requesting that equipment type eq be assigned to file filename. Operator message.	Assign equipment to control point.	LFM
REQUEST DISPLAY. xxx.	Program xxx is waiting for the display to be assigned. This message appears in the comment field of the control point at which the program is active on the job status (B) display. xxx 026 File editor DIS Job display routine name Program name	Enter DSD command n.ASSIGN,xx. n Control point number requesting assignment EST ordinal of the display console xx	DIS 026
REQUEST *I* DISPLAY.	B-display message informing the operator that BATCHIO has detected an abnormal condition on an assigned unit record device.	Check the status field of the I display for more specific information. The message remains on the B display until the condition is corrected.	ICD QAP
REQUEST *K* DISPLAY.	The K display is requested at the specified control point. This message appears in the comment field of a control point on the job status (B) display.	Enter command K,n. n Control point number	PFS QFSP MSI MODVAL PROFILE MREC
REQUESTED ECS NOT AVAILABLE.	The amount of ECS requested was not available in a contiguous block.	Reinitialize with less ECS requested.	TAF
RERUN NOT POSSIBLE.	The job cannot be rerun because of one of the following. - Job is time-sharing origin. - No input file is found for the job. - An error occurred in reading or writing the input file system sector. - Rerun status is disabled.	None.	IDS
RMS FULL.	The program name table is full or all available tracks are used on the disk.	Use a different disk.	TDX

<u>MESSAGE</u>	<u>SIGNIFICANCE</u>	<u>ACTION</u>	<u>ROUTINE</u>
RMS STAT ERR.	The status from the disk is not correct.	Use a different disk.	TDX
ROLLIN FILE BAD.	A job could not be rolled in correctly.	Inform site analyst. Check error log dayfile for the job that was aborted and the location of the bad rollin file.	IRI
ROLLOUT FILE BAD.	Detected system sector on a rollout file which did not meet one of the following conditions. - Linkage bytes must be 377 and 77 - File type must be ROFT (rollout) - Job origin must be TXOT	Inform site analyst.	ITA
RRN xx,nn.	System dayfile message indicating that the operator requested termination of BATCHIO equipment xx and reentered the job in the correct queue with a queue priority of nn00.	None.	QAP
SCANNING RESOURCE DEMAND FILE.	Informative message indicating the routine MAGNET1 is attempting clean-up procedures on the resource demand file.	None.	MAGNET
SECONDARY LINK RESET ON PORT nn.	An irrecoverable line error has occured on port nn serviced by the CCP X.25 Terminal Interface Program. Following the error CCP automatically performed a link reset. The reset can cause packet level errors to occur. Repeated occurrences of this message may indicate software problems or poor transmission characteristics of the line.	None.	CCP
SECURE MEMORY, DUMP DISABLED.	The user attempted to dump memory protected by the system, or entered DMD or DMP after a CCL statement or from a terminal.	Refer to Security Control in section 3 and the DMD and DMP statements in the NOS Reference Manual, volume 1. To obtain memory dumps from a time- sharing job, include the DMD or DMP statement in a procedure or in an ENTER statement. A DMD statement can be included only in a batch job.	1AJ
SECURITY VIOLATION APP jobid.	Informative message indicating that NIP has detected a security violation (for example, an application attempting to perform operations reserved for a supervisor or privileged application. jobid Job identifier passed to NIP	None.	NIP

<u>MESSAGE</u>	<u>SIGNIFICANCE</u>	<u>ACTION</u>	<u>ROUTINE</u>
	from the operating system.		
SFM FAMILY STILL ACTIVE.	An attempt was made to release fast attach files for a family which was still in use.	Enter DSD command IDLE (refer to section 3) to prevent new jobs from being scheduled to that family while allowing the operations in progress to complete.	SFM
SFM - UNRECOVERABLE LINK DEVICE ERROR.	An unrecoverable error was encountered while trying to process an SFM request involving DAT or FAT tables on the link device. Dayfile message.	The error information logged in the error log should be referred to a customer engineer. If the error cannot be fixed, the area in error should be flawed before attempting to proceed. A level 0 deadstart may be necessary.	SFM
SHARED DEVICE ACTIVE IN DAT.	A shared device is described in the device access table with the same family name and device number as the nonshared device being recovered. Recovery is impossible. Preceded by message RECOVERY,dtxx, which indicates the equipment in error.	Redeadstart with correct configuration for equipment in error.	RMS CMS
SHUTDOWN IMMINENT.	Bit 37 of the status/control register is set, indicating an abnormal environmental condition has been detected. When entered in the error log, the message is preceded by SR. Operator and error log message.	Inform site analyst and customer engineer. (For further information and procedures, refer to S/C Register Error Detection, appendix F.)	1MB SCE
SHUTTLE ERROR. REPLY GO TO RETRY - DROP TO OFF DEVICE.	K-display mssage indicating that there is a shuttle malfunction in the mass storage transport.	Verify that all cartridges are aligned correctly in the shuttle and enter K.m.GO. If one or more is not aligned, enter K.m.DROP and call a customer engineer. m Message ordinal	MSSEXEC
SIMFid NETWORK FILE ERROR.	An error was detected during processing of the SIMFid file. This could be due to a hardware error or a file description entry error.	Verify the file using the VALNET utility (refer to Installation Handbook).	IAFEX TELEX

<u>MESSAGE</u>	<u>SIGNIFICANCE</u>	<u>ACTION</u>	<u>ROUTINE</u>
SKF xx,nn.	System dayfile message indicating that the operator requested a skip forward of nn logical files on the print file on BATCHIO equipment xx.	None.	QAP
SKP xx,nn.	System dayfile message indicating that the operator requested a skip forward of nn sectors (PRUs) on the print file on BATCHIO equipment xx.	None.	QAP
SKR xx,nn.	System dayfile message indicating that the operator requested a skip forward of nn logical records on the print file on BATCHIO equipment xx.	None.	QAP
SLAVE MODE - LOADING MSSSLV.	The slave mainframe mode has been detected and the slave EXEC is being loaded.	None.	EXMAIN
SLVi ACTIVE, EXEC xxxx.	Informative message indicating the current status of MSSEEXEC according to MSSSLV on mainframe i.	None.	MSSSLV
SLVi - ERROR TERMINATION (1).	While MSSSLV on mainframe i was reading the master-to-slave communications file MTOSPFN, an I/O error occurred which prevented further MSSSLV processing.	Purge file MTOSPFN and reinitialize MSSEEXEC and all MSSSLV programs.	MSSSLV
SLVi - IDLED DOWN.	Informative message indicating that MSSSLV on mainframe i terminated normally in response to an operator n.IDLE command.	None.	MSSSLV
SLVi STOMNO1 xxxx.	MSSSLV on mainframe i attempted to establish access to the slave-to-master communication file STOMNO1. The status of this attempt is indicated by xxxx, which can be one of the following. OK ATTACH PROBLEM BUSY DEFINE PROBLEM	If xxxx is not OK, analyze error and try again. Ensure that the link device is configured as a direct access permanent file device.	MSSSLV
SPIN DOWN UNIT xx.	Unit xx should be deactivated prior to a physical pack switch.	Deactivate unit xx.	IRM
SR, nnnn LCME MEMORY CORRECTIONS.	Gives the number of SECDED single-bit error corrections that have occurred during the last hour (or since the last deadstart if less than an hour has elapsed). This message is issued at the beginning of each hour. The maximum value of nnnn which will appear is 7777B although more than 7777B errors may have occurred.	None.	1MB

<u>MESSAGE</u>	<u>SIGNIFICANCE</u>	<u>ACTION</u>	<u>ROUTINE</u>
SR, nnnn SINGLE MEMORY CORRECTIONS.	Informative message indicating the number of SECEDED single-bit error corrections that have occurred during the last hour (or since last deadstart if less than an hour has elapsed). This message is issued at the beginning of each hour. The maximum value of nnnn which will appear is 7777B although more than 7777B errors may have occurred.	None.	1MB
SR-m-2 yyyy yyyy yyyy yyyy yyyy. SR-m-1 yyyy yyyy yyyy yyyy yyyy yyyy. SR-m-0 yyyy yyyy yyyy yyyy yyyy yyyy.	A status/control register error has been detected. Error log message. m Channel register 0 Channel 16 register 1 Channel 36 register (if 20 PPU's are being used; in this case the contents of both registers are given) yyy...yyy Contents in octal of words 16 through 0 as specified below. SR-m-2 words 16-12 (bits 203-144) SR-m-1 words 11-6 (bits 143-72) SR-m-0 words 5-0 (bits 71-0)	Inform customer engineer.	1MB
STxx, FNff, FUNCTION TIMEOUT.	Dayfile and error log message indicating that the driver (1ED) issued a function to the multiplexer and did not receive an inactive signal within four major cycles. This error causes the subsystem to abort. xx EST ordinal of multiplexer ff Function	Inform customer engineer.	1ED
STxx, INCOMPLETE TRANSFER.	Dayfile and error log message indicating that the driver (1ED) was unable to transfer the expected amount of data during an input or output operation. This error causes the subsystem to abort. xx EST ordinal of multiplexer	Inform customer engineer.	1ED
STAGING DELAY, DISK FULL. FM=famname, UI=userin. REPLY GO TO CONTINUE	K-display message indicating that there is not enough space on the disk during an attempt to stage a file for user index userin on family famname from MSF to disk. The stage attempt repeats after a delay, allowing you time to free enough space for the file to be copied to disk.	Contact a site analyst to run the ASMOVE utility to make disk space available. Enter K.m.GO to clear the message. m Message ordinal	EXSTGE
STRING TOO LONG.	CFO command contains a string longer than seven characters.	Reenter the command.	MCS
SUBSYSTEM ABORTED.	The user job was connected (either long term connection or wait response set) to a subsystem which aborted.	Retry later.	1AJ

<u>MESSAGE</u>	<u>SIGNIFICANCE</u>	<u>ACTION</u>	<u>ROUTINE</u>
SUP xx.	System dayfile message indicating that the operator requested automatic printer carriage control suppression on BATCHIO equipment xx.	None.	QAP
SUPERVISION ALARM -- CS,RC=routine, case,state	The communications supervisor (CS) has detected an unusual but nonfatal network condition. routine Name of routine that detected the error case 2-digit internal case number (decimal) state 2-digit internal state number (decimal)	None.	CS
SUPERVISION ERROR -- CS,RC=routine, case,state	The communications supervisor (CS) has detected an internal program error. If DEBUG was defined on the NAM program library during installation, an error exit is taken and processing aborts. If DEBUG was not defined during installation, a core dump is taken and processing continues. routine Name of routine that detected the error case 2-digit internal case number (decimal) state 2-digit internal state number (decimal)	Submit dumps to site analyst for further action. If DEBUG was defined, restart NAM to continue.	CS
SUPERVISION ERROR -- NS,RC=ec	The network supervisor (NS) has detected an internal program error. ec Error code 1-15 Logical error received by NS 16 Illegal destination node 17 Wrong process sent message 18 Cannot create logical link 19 Illegal PFC/SFC received 20 Dump index full	None. If NS aborts, it automatically restarts.	NS
SUPIO ERROR ec ON file	A SUPIO (supervision program I/O) error has been detected on file. ec Error code 0001 Write parity error; data transferred 0002 Unrecognizable write address; data transferred 0003 Unrecognizable write, detail status error; data transferred 0011 Buffer full on coded file 0013 Buffer full on binary file 0021 Operation complete on coded file 0023 Operation complete on binary file	If the message LCF NOT AVAILABLE follows, an I/O error occurred on LCF during initialization. If the message SUPERVISION ERROR-CS follows, an I/O error occurred on LCF after the GO command was issued. Refer to those messages for the appropriate action. A new NCF or LCF can be assigned before GO is	NS CS

MESSAGESIGNIFICANCEACTIONROUTINE

0031	End-of-file on coded file	issued but cannot be re-assigned afterward. A new CCP can be assigned before or after GO is issued.	
0033	End-of-file on binary file		
0070	Not a SUPIO file		
0071	Duplicate record ID		
0072	Index pointers in FET are unrecognizable		
0073	Index area too small		
0074	Random request on sequential file		
0075	Sequential request on random file		
0076	Rewrite longer than previous record		
0077	Rewrite on nonexistent record		
1031	End-of-information on coded file		
1033	End-of-information on binary file		
4001	Write parity error; data not transferred		
4002	Unrecognizable write address error; data not transferred		
4003	Unrecognizable write, detail status error; data not transferred		
4007	Track limit		

file Type of file on which error was detected (NCF, LCF, or CCP).

SYSTEM ACTIVITY PROHIBITS LIBRARY CHANGE.

Dayfile message indicating that an error occurred because the job at control point 1 cannot be moved in order to perform the SYSEdit.

Inform site analyst; the recommended action is one of the following.

- Drop activity at control point 1
- Reduce size of CMR resident to allow building of tables within the allocated field length.

SLL

SYSTEM BUILT WITH LIBDCKn.
or
SYSTEM BUILT WITH LIBDCKn. (UNDEFINED)

Informative message following a level 0 (initial) or level 2 (recovery) deadstart to indicate the LIBDECK with which the system was generated. The second form of the message is issued if the specified deck was not found. This can seriously affect system performance because often used routines which normally reside in CM or the alternate system device (ASD) must be accessed from the system disk instead.

Redeadstart if necessary to rebuild system using a known LIBDECK.

SYSEdit

n LIBDECK number

<u>MESSAGE</u>	<u>SIGNIFICANCE</u>	<u>ACTION</u>	<u>ROUTINE</u>
SYSTEM CHECKPOINT ABORT.	A subsystem has aborted due to a CHECK POINT SYSTEM request initiated by the operator.	Retry the checkpoint.	ICK
SYSTEM FILE DESTROYED.	Dayfile message indicating that the system sector of the system file is bad.	Inform site analyst; rereadstart is necessary.	SLL
SYSTEM FILE FORMAT ERROR.	Operator message indicating that text defined by deadstart parameters (or in CMRDECK) does not exist on the deadstart tape. This message may be issued during the initialization phase of deadstart.	Inform site analyst; deadstart information must be redefined in CMRDECK.	SYSEEDIT
SYSTEM FILE PARITY ERROR.	The system cannot be recovered from disk because of a disk parity error.	Attempt another deadstart without recovery (level 0).	REC
SYSTEM FILE RESERVED.	Dayfile message indicating that the system file is currently in use, possibly by another copy of SYSEEDIT.	Wait until SYSEEDIT activity has completed and retry.	SLL
SYSTEM LIBRARY CHANGE ILLEGAL.	Informative dayfile message indicating that the caller does not have permission to modify the system.	None.	SLL
SYSTEM TABLE FILE DESTROYED. RECOVERY OF DEVICE IMPOSSIBLE.	Error was encountered during a recovery deadstart. The system file being recovered from disk was destroyed; recovery is impossible.	Attempt another deadstart without recovery (level 0).	REC
SYSTEM TAPE PARITY ERROR.	Parity error occurred while reading the deadstart tape.	Perform one of the following. <ul style="list-style-type: none"> - To continue, type GO (information transferred may not be valid). - Rereadstart and specify a different tape density, or use another tape unit or a different deadstart tape. Ensure that the deadstart tape is an unlabeled I-mode tape, and that the tape unit on which it is mounted is the correct type (7 or 9-track). 	DIO

<u>MESSAGE</u>	<u>SIGNIFICANCE</u>	<u>ACTION</u>	<u>ROUTINE</u>
SYSTEM TOO BIG FOR MASS STORAGE.	Error encountered during the building of the system library. Storage required not available on mass storage device specified for system library. Preserved files on the system device may cause insufficient local file space to be available. If multiple copies of the system are specified, these preserved files may prevent allocation of matching track chains.	Attempt another deadstart using a larger system mass storage device or use a deadstart tape that generates a smaller system library. Ensure deadstart sector is initialized by releasing CMSE space if it is not to be present on system devices.	SLL
TAF DATA MANAGER SUCCESSFULLY LOADED.	Self-explanatory.	None.	TAF
TAF FIELD LENGTH DUMP RELEASED.	A dump of the transaction facility has occurred. The dump has been routed to a printer with an ID of zero.	The output may contain secure information and should be given to the central site TAF systems analyst only. A header page follows the banner page for identification.	TAF
TAF INTERNAL ERROR.	TAF has found internal data to be inconsistent.	Perform a dump of TAF or inform site analyst.	TAF
TAF NETON COMPLETE.	TAF is connected to the network.	None.	TAF
TAF NOT CALLED BY DSD.	The transaction subsystem aborts if initiated in any way other than DSD command.	None.	TAF
TAFnnn TERMINATE.	Informative message indicating that the transaction subsystem was dropped via DSD command 2.STOP. (refer to section 3) and was not restarted. nnn NAM if TAF interfaces with NAM. TS if TAF interfaces with TELEX.	None.	TAFNAM2 TAFTS2
TAFNAM/TAFTS TERMINATE.	Transaction subsystem has terminated.	None.	TAF
TAPES ASSIGNED AT MAGNET TERMINATION.	The magnetic tape subsystem was dropped or aborted while tapes were assigned. These tape assignments are lost and associated user jobs will abort if subsequent I/O is attempted.	Rerun jobs which abort following attempted I/O. (Only jobs with lost tapes will be affected).	MAGNET
TASK LIBRARY DIRECTORY EMPTY - libnam.	The file specified as the task library contains no recognizable directory. TAF aborts.	Inform site analyst. Task library libnam must be corrected and TAF reinitialized.	TAF

<u>MESSAGE</u>	<u>SIGNIFICANCE</u>	<u>ACTION</u>	<u>ROUTINE</u>
TASK LIBRARY DIRECTORY ERROR - libnam.	Task library libnam contains no recognizable directory. TAF aborts.	Inform site analyst. Task library must be corrected.	TAF
TASK LIBRARY DIRECTORY TOO LONG - libnam.	The directory record on task library libnam exceeded the maximum length allowed by the transaction executive (170 files). TAF aborts.	Inform site analyst. Size of task library libnam must be reduced and TAF reassembled.	TAF
TASK NOT VALIDATED FOR REQUEST.	One of the following actions has occurred. <ul style="list-style-type: none"> - The terminal operator initiated a transaction which tried to perform an action associated with a data base for which the terminal was not validated. - A NEWTRAN request was issued by a task not in the system task library (TASKLIB). 	Perform the appropriate action. <ul style="list-style-type: none"> - Inform site analyst; transaction must be reinitialized. Set up the terminal name in the network file to use the data base. The system data base (SY) may be used. - Put the task on TASKLIB. 	MSABT
TCR I/O FATAL ERROR.	NVF cannot initialize the TCR file. NVF aborts.	Inform site analyst.	NVF
TELEX ABNORMAL - xxx,nnnnn.	Informative message indicating that TELEX has encountered an abnormal situation. If sense switch 3 is set, TELEX attempts to enter active users into the recovery state, abort, and then reload automatically. xxx TELEX routine requesting the abort nnnnnn Contents of the B2 register (usually contains a terminal number)	None.	TELEX
TELEX BUSY.	K-display message indicating an attempt to send a request to the time-sharing executive was denied.	Retry operation.	TAF
TELEX INITIALIZATION ABORT.	TELEX could not be initialized properly. An additional dayfile message describing the error in more detail should precede this message.	Restart TELEX using DSD command TELEX (refer to section 3).	TELEX
TELEX TERMINATE.	Informative message indicating that TELEX was stopped and was not restarted. This message is issued when TELEX is dropped (via l.STOP. command).	None.	TELEX

<u>MESSAGE</u>	<u>SIGNIFICANCE</u>	<u>ACTION</u>	<u>ROUTINE</u>
TERM. name,status,dt/tc,caddr/taddr,appl	Terminal status message sent in response to a STATUS command, or when a significant change in status has occurred. name Name of terminal status Status of terminal DI Disabled EN Enabled AC Active DN Down dt Device type tc Terminal class caddr Cluster address. Refer to the Network Definition Language Reference Manual. taddr Terminal Address. For HASP multi-leaving terminals, this is the stream number. For X.25 circuits (permanent and switched), this is the logical channel number. appl Name of application to which terminal is connected	No action required unless the disabling of an enabled, active, or down terminal, or the enabling of a disabled terminal is desired.	CS
TERMINAL termid Ccc Ee Pp MALFUNCTION.	Terminal failed to answer poll. termid Terminal identifier cc Multiplexer channel number e Equipment number p Port number	Inform customer engineer. This message may be indicative of hardware failure.	TAF
TERMINAL termid Ccc Ee Pp UP.	Terminal is operative after previously failing to answer. termid Terminal identifier cc Multiplexer channel number e Equipment number p Port number	Inform customer engineer. This message may be indicative of hardware failure.	TAF
TERMINAL nnn. JOB LOST.	Informative message indicating that an abnormal situation has occurred during time-sharing subsystem recovery. An attempt is made to terminate a job from the system because the active user logged in at terminal nnn cannot locate the job. Recovery continues, but that user will be unable to recover.	None.	IAFEX TELEX
TERMINAL TABLE OVERFLOW.	Space sufficient to allocate the required table was not available. An internal change to the time-sharing executive is necessary.	Inform site analyst.	IAFEX TELEX

<u>MESSAGE</u>	<u>SIGNIFICANCE</u>	<u>ACTION</u>	<u>ROUTINE</u>
TERMINALS MISSING IN NETWORK FILE.	A valid network file was found but no transaction terminals were defined in it. If TAF interfacing with TELEX is being used, TELEX was not reinitialized to recognize the same network file that TAF was using.	Ensure that the network file is under the proper name; if it is, inform site analyst. If TAF interfacing with NAM is being used, the network file is NCTFid. If TAF interfacing with TELEX is being used, the network file is NETwid if TAF/TS can attach it; otherwise, TAF/TS uses SIMFid. For the TELEX interface, reinitialize TELEX and TAF. For the NAM interface, reinitialize TAF.	TAF
TEST MODE, NETWORK NOT USED.	Informative message indicating that MCS was started in global test mode.	None.	MCS
TOO MANY CRAT FILE ENTRIES.	There are too many error records on the xxERPF file.	Inform site analyst. The bad areas on disk should be flawed and the data base reloaded.	TAF
TOO MANY DATA BASE NAMES.	The number of data base names associated with one data manager via DMS statements exceeds the value of MAXDB.	Decrease the number of data base names associated with the data manager.	TAF
TOO MANY FILES IN TOTAL DATA BASE.	Self-explanatory.	Reduce the number of entries in the TCF file or increase TMAXFIL.	TAF
TOO MANY JOURNAL FILES IN xxJ FILE.	More than three journal files per data base were specified, causing the transaction subsystem to abort.	Examine xxJ file for xxJOR entries. Consult the TAF data base administrator.	TAF
TOO MANY PORTS.	More than 512 ports have been defined in the multiplexer entries of the equipment status table (EST).	Inform site analyst.	1TD
TOO MANY TERMINALS.	The total number of terminals defined in the EST and/or the network description files exceeds the maximum defined by the assembly variable MAXTT.	Reduce the number of devices in the EST which are on; verify the network description file using the VALNET utility (refer to the NOS Installation Handbook).	IAFEX TELEX

<u>MESSAGE</u>	<u>SIGNIFICANCE</u>	<u>ACTION</u>	<u>ROUTINE</u>
TOTAL DATA MANAGER SUCCESSFULLY LOADED.	Self-explanatory.	None.	TAF
TOTAL DID NOT RECOVER PROPERLY. STATUS IS yyyy.	An error status yyyy was returned on a Total FINAL call. Refer to Diagnostics in the Total Reference Manual for yyyy.	Correct error and reinitialize transaction executive.	TAF TAFNAM2 TAFTS2
TRACK BUFFER FULL.	Operator message indicating too many reserved track entries in CMRDECK. No more entries will be accepted.	Inform site analyst.	SET
TRACK LIMIT.	All mass storage devices available for temporary files are full. CIO cannot finish processing until space is available on one of the devices. Operator message.	Inform site analyst.	CIO DSP
TRACK LIMIT. EQxx.	Mass storage device with EST ordinal xx has no allocatable tracks left. CIO cannot finish processing until space is available. Operator message.	Inform site analyst.	CIO
TRN - ABNORMAL.	A TAF-originated task could not be scheduled because of a lack of communication blocks or ITASK queue was full. An attempt to schedule the task will be made at a later time.	Inform site analyst.	TAF
TRT LENGTH ERROR.	Operator message indicating that an error was encountered while reading the track reservation table (TRT) during a level 0 deadstart. Preceded by message RECOVERY, dtxx, which indicates the equipment in error. dt Device type xx EST ordinal	Redeadstart and initialize device. Preserved files on device are lost, and must be reloaded.	RMS
TRUNK. name,status,node/port,remote/port	Trunk status message sent in response to a STATUS command, or when a significant change in status has occurred. name Name of trunk; UNKNOWN implies the trunk is disabled and the NOP is being informed of the change in status. status Status of trunk DI Disabled EN Enabled AC Active DN Down node Node number port Port number remote Remote node number	No action required if response to STATUS command. Check dayfile for subsequent messages which might indicate a change in status.	NS

<u>MESSAGE</u>	<u>SIGNIFICANCE</u>	<u>ACTION</u>	<u>ROUTINE</u>
TTxx, FNff, FUNCTION TIMEOUT.	The driver routine (1TD) issued a function to the multiplexer and did not receive an inactive signal within four major cycles. This error causes the subsystem to abort. xx EST ordinal of multiplexer ff Function	Inform customer engineer.	1TD
TT OPTION REQUIRES USER NUMBER.	When updating a task library on-line (TT option is specified on LIBTASK statement), the user number must be specified prior to the LIBTASK statement so the library associated with that user number can be found.	Specify user number via USER or ACCOUNT statement before LIBTASK statement and rerun job.	LIBTASK
TT77, PNnnnn, FILES LOST.	The user on port number nnnn has performed a recovery operation. However, some of the user's files were not able to be verified. Items such as system sectors, EOI sectors, and so on are checked for validation.	Inform site analyst. This occurrence may have incorrectly left equipment assigned or file busy. A level 0 deadstart may be necessary.	1TA
TVF ATTEMPTING NETON.	Informative message indicating that TVF has been called and is attempting to enter the network.	None.	TVF
TVF ERRMSG, ABT=nn, ADR=addr, TEXT=aaaa, TERMINAL=termnam.	TVF has received a message with out-of-range values or erroneous values. nn Application block type from message header addr Addressing information from message header aaaa First 4 characters of text termnam Terminal name associated with the message	None.	TVF
TVF NETON SUCCESSFUL.	Informative message indicating that TVF has successfully entered the network.	None.	TVF
TVF RC=ec, ABT=nn, ADR=addr, TEXT=aaaa, TERMINAL=termnam.	TVF has received ERR/LGL/SM (TVF probably issued an erroneous message). ec Error code from ERR/LGL/SM nn Application block type from message header addr Addressing information from header of message that caused ERR/LGL/SM aaaa First 4 characters of text of message that caused ERR/LGL/SM termnam Terminal name associated with addr	None.	TVF

<u>MESSAGE</u>	<u>SIGNIFICANCE</u>	<u>ACTION</u>	<u>ROUTINE</u>
TWO CONTROLLER TYPES ON SAME CHANNEL.	EST entries indicate a conflict in tape channels and controller types. Only one tape controller type is allowed per channel.	Inform site analyst.	1MT
TY NOT ALLOWED.	Value specified for TY parameter was not valid (legal values are F or X).	Correct and enter GO.	MSI
UN MUST BE SPECIFIED.	Auxiliary device is defined as private. Thus, user number must be specified or the device must be redefined as public.	Specify user number or enter UN=NULL to indicate that private device is being made public.	MSI
UN=usernum NOT VALID ON FM=family.	User number usernum on the specified family is not valid. The user number and family may not be defined or are incorrect in xxJ file.	Inform site analyst.	TAF
UNnn, SERVO TIMING = xxxx, RANGE 325 TO 345.	Unit with EST ordinal nn had servo timing check of xxxx. If the timing check was within the specified range, 1RM proceeds with the reconfiguration process. If the timing check was not in the specified range, 1RM rechecks the timing every 15 seconds until the timing check is in the correct range or the run is aborted.	None.	1RM
UNABLE TO ACTION COMMAND AT THIS TIME	The network/local operator command entered was valid but could not be processed because a network element required for completion of the command had some other activity in progress.	Wait for the activity to complete (approximately 15 seconds) and reenter the command.	NS CS
UNABLE TO ATTACH NAM BINARIES.	The NAMAIP direct file could not be attached under the transaction subsystem user number.	Inform site analyst.	TAF
UNABLE TO ATTACH TOTAL BINARIES.	File of Total binaries is not under the user index of the transaction subsystem or a PFM error occurred.	Correct error and reinitialize transaction executive or contact site analyst.	TAF
UNABLE TO ATTACH TOTAL DBMOD BINARIES.	One or more of the DBMOD files listed on the TOTAL DMS control statement in the TCF file could not be attached under the user index of the transaction subsystem or a PFM error occurred.	Correct error and reinitialize transaction executive or contact site analyst.	TAF
UNIT xx CHyy LABEL READ ERROR.	A mass storage read error was encountered while attempting to verify the pack label.	Enter RECHECK on all machines to continue the replacement of the physical packs, or ABORT to end the reconfiguration.	1RM

<u>MESSAGE</u>	<u>SIGNIFICANCE</u>	<u>ACTION</u>	<u>ROUTINE</u>
UNIT xx CHyy LABEL VERIFICATION ERROR.	The label being verified did not match the expected values.	In single mainframe mode, or if all machines in multimainframe mode received the message, deactivate the replacement unit and ensure that the correct pack has been mounted. If the correct pack was mounted, or if not all machines in multimainframe mode received the message, enter RECHECK on all machines to continue the replacement of physical packs, or ABORT to end the reconfiguration.	IRM
UNKNOWN FILE FORMAT.	There is a logical error in the structure of the input file. It does not conform to the established format rules.	None.	KTSMP
USER ECS DISABLED.	Jobs that assign user ECS are no longer being scheduled because of unrecovered ECS errors.	Reenable user ECS scheduling after ECS errors have been corrected.	IMB
USER ECS IMPROPERLY ALLOCATED.	The amount of ECS specified on the CMRDECK entry UEC does not match the amount defined previously in the system sector of the user ECS chain.	Redeadstart and correct the UEC entry.	REC
USER ECS SYSTEM SECTOR ERROR.	The system sector of the user ECS chain is in error and cannot be read.	Deadstart and initialize ECS to reallocate the ECS area.	REC
USER VALIDATION DENIED.	A job containing the CEVAL macro was submitted improperly. Either the job must be system origin, or the user must have system origin privileges and submit the job while the system is in engineering mode.	Submit job from the console or, if the user has system origin privileges, set engineering mode (refer to ENGR command in section 3) and resubmit job.	CVL
VEJ - BUFFER ARGUMENT ERROR.	Dayfile message indicating that FET buffer pointers are invalid. (FWA<LWA<FL) or TID (terminal id) with complement address was not within the field length.	If issued to a subsystem (such as BATCHIO or RBF), inform site analyst immediately to determine which condition caused the error.	VEJ

<u>MESSAGE</u>	<u>SIGNIFICANCE</u>	<u>ACTION</u>	<u>ROUTINE</u>
VEJ - ILLEGAL REQUEST.	Dayfile message indicating that one of the following conditions has occurred. <ul style="list-style-type: none"> - VEJ was called by a control point which did not have priority greater than MXPS. - The FET address was out of range. - A job without SSJ= privileges attempted to specify a system sector address in the RA+1 call. - The system sector buffer was not within the field length. - A nonmass storage device request was made. 	If issued to a subsystem (such as BATCHIO or RBF), inform site analyst immediately to determine which condition caused the error.	VEJ
WAIT DEMAND FILE ATTACH.	The MAGNET1 routine is waiting for the resource demand file to become available so clean-up processing can be done.	If the message is displayed for an extended period of time, drop the job which has the demand file attached, or drop the magnetic tape subsystem.	MAGNET
WAIT FNT SPACE.	OBF (begin file routine) is waiting for a free entry in the file name table (FNT). Operator message.	Inform site analyst; it may be necessary to drop a file that is not currently being used (or an active job) to provide additional FNT/FST space. Use QREC to dequeue queued files.	OBF
WAIT LOG OFF(S) COMPLETE.	Informative message indicating that time-sharing subsystem is entering active users into the recovery file or logging them out.	None.	IAFEX TELEX
WAIT 1MT COMPLETE.	Informative message indicating the routine MAGNET1 is waiting for 1MT to complete before attempting clean-up or recovery procedures on the magnetic tape subsystem.	None.	MAGNET
WAITING FOR CFO.GO.	MCS processing is suspended until you enter the n.CFO.GO command.	Enter n.CFO.GO command.	MCS
WAITING FOR DEMAND FILE.	RESEX detected a terminal interrupt and is waiting to attach the demand file for clean-up processing. This message should not normally appear; it indicates several attempts to attach the demand file have already been made. If the operator drops the job at this point, the preview data in the demand file is not cleared and the E,P display continues to show the VSN request associated with the job until the user logs off or issues a sub-	Inform site analyst. If problem persists, drop the job.	RESEX

<u>MESSAGE</u>	<u>SIGNIFICANCE</u>	<u>ACTION</u>	<u>ROUTINE</u>
WAITING FOR xxxI INTERLOCK.	sequent request for tape or pack. 1MR is waiting for flag register interlock xxxI. xxx One of the following. DAT Device access table interlock FAT Fast attach table interlock	None.	1MR
WAITING FOR NETWORK.	NAM was not active when MCS tried to NETON.	Bring NAM up.	MCS
WAITING FOR READY UNIT xx.	RESEX is waiting for the tape unit with EST ordinal xx to become ready.	Ensure that correct tape is mounted and ready unit.	RESEX
WAITING FOR STORAGE.	Console message indicating that the buffer space required by the card reader is currently unavailable to Export/Import at the central site. The READ command is held active until storage is available.	The user must wait for storage to become available, or if the message persists, enter END,CR to abort the job currently being read from the card reader.	1LS
WAITING - RECOVERY INTERLOCK.	Informative message. In order to recover a device on-line, it is necessary to load the device access table out of ECS. However, the flag register interlock is currently unavailable, possibly because another machine is deadstarting.	None.	CMS
WRT CSaaaa DSbbbb.	Operator message indicating that a write error occurred during an express deadstart dump. aaaa Channel converter status bbbb Controller status	Press carriage return to retry the dump operation.	EDD
XSP - ARG. ERROR.	The call block for an XSP request contained a CM address that was out of range. This condition should never occur. Dayfile message.	Inform site analyst.	XSP
XSP - WAIT DISK FULL.	XSP is waiting for disk space to become available for a remote job initialization. Operator message.	Storage space on system device should be made available.	XSP
1CJ ARGUMENT ERROR.	An incorrect parameter was passed in a call to 1CJ.	Inform site analyst.	1CJ
1DD ABT.	This message is displayed when one of the following conditions occurs. - Unrecoverable write error on a dayfile dump. - No mass storage space available on which to write the dayfile. - Enough dayfile messages (usually error	The system should be idled (refer to IDLE command) immediately and the appropriate step taken as follows. - Correct write errors.	1DD

<u>MESSAGE</u>	<u>SIGNIFICANCE</u>	<u>ACTION</u>	<u>ROUTINE</u>
	log) were generated during the deadstart process to necessitate a dump of the buffer. However, the deadstart process had not advanced far enough to properly dump the buffer.	<ul style="list-style-type: none"> - Free space on the full device. - During deadstart, this message usually indicates a bad pack or disk drive. Use another pack or take the drive offline. 	
	In each of the above cases, the buffer is set empty. A portion of the dayfile is lost and messages may be incomplete. Operator message.		
1LS ABT (INT) AT P=x.	Informative message indicating that Export/Import has aborted during initialization. Operator message. x Internal address at which 1LS detected an abort condition.	Inform site analyst.	1LS
1LS MODE1 FROM PP AT P=x.	PP detected a mode 1 error in the Export executive. This message is followed by the DUMP OR DROP message. Dayfile message. x P register address	Refer to description of DUMP OR DROP message.	1LS
1MR ERROR FLAG TERMINATION.	An error flag was set at 1MR's control point.	None.	1MR
1MT PROBABLY LOST.	Informative message indicating the routine MAGNET was dropped while waiting for 1MT to complete.	None.	MAGNET
1RM INVALID REQUEST.	Illegal function code or status word address out of range.	Inform site analyst.	1RM
1RM INVALID USER ACCESS.	Calling job does not have mass storage subsystem queue priority.	Inform site analyst.	1RM
200UT BATCH DEVICES STILL CONFIGURED	The local operator attempted to disable a 200 user terminal console that still had batch devices configured.	Disable the batch devices (refer to the DISABLE command in section 7) and then disable the console. If commands to disable the batch devices have already been entered, allow time for the action to complete.	CS
200UT CONSOLE NOT CONFIGURED	The local operator attempted to enable a 200 user terminal batch device while the console was disabled.	Enable the 200 user terminal console (refer to the ENABLE command in section 7) and then enable the batch devices.	CS

<u>MESSAGE</u>	<u>SIGNIFICANCE</u>	<u>ACTION</u>	<u>ROUTINE</u>
667x MALFUNCTION.	Either a function was not accepted or no multiplexer is on the channel.	Inform customer engineer.	ITD
comment *CYB,* +35 CHARACTERS+*.*	A comment entry on the editing display for CYBERLOG is more than 35 characters.	Reenter the comment in 35 characters or less.	CYBRLOG
name ALREADY DISABLED	The operator attempted to disable an element (name) which was already disabled.	None.	NS CS
name ALREADY ENABLED	The operator attempted to enable an element (name) which was already enabled.	None.	NS CS
name AREADY CONFIGURED AT SAME ADDRESS	The local operator attempted to enable a line or terminal while another line or terminal was already enabled at the same hardware address. name Name of line or terminal currently at the hardware address	If desired, disable element specified in message. When that action is complete, reenter original command.	CS
n.nnn AVERAGE ACTIVE SUBCONTROL POINTS.	Average number of simultaneously active subcontrol points when TAF is not rolled out. An active subcontrol point is one which is in recall, is waiting to use the CPU, or is currently assigned the CPU. The sampling rate is once per second.	None.	TAF
n.nnn AVERAGE OUTSTANDING CDCS REQUESTS.	Average number of outstanding (uncompleted) SSC requests per second. The sampling rate is once per second.	None.	TAF
nn BUFFERS ACTIVE.	Informative message indicating the number of buffers currently in use by BATCHIO. This message appears at the BATCHIO control point on the DSD job status (E) display.	None.	IIO
name DISABLED	The local operator attempted to enable or disable a terminal when the associated line was disabled, or attempted to send a message to a disabled terminal. name Name of disabled element	Enable the disabled element (refer to the ENABLE command in section 7) and reenter the command.	CS
divname-mmm ERROR AND nn WARNING MESSAGES ISSUED.	If mmm is not zero, the indicated number of fatal diagnostic message errors are described in the error summary listing produced by the NDL processor as part of the listing output file. A nonzero value for mmm indicates that any configuration file created by the job from the named division does not contain a verification record. If nn is not zero, the indicated number of nonfatal diagnostic message errors are described in the error summary listing. A nonzero value for nn does not affect the verification record of any network	Correct the NDL statements input and rerun the job if mmm is not zero.	DAYYES NDLLIST

<u>MESSAGE</u>	<u>SIGNIFICANCE</u>	<u>ACTION</u>	<u>ROUTINE</u>
	definition file created by the job.		
npu HAS MESSAGE OUTSTANDING	The local operator attempted to send a message to terminals on an NPU before a previous message had been completed. npu Name of NPU to which message was sent	Allow time for the previous message to be sent to all terminals and then reenter the new message.	CS
term HAS type STATUS	Informative message sent only to the host console operator indicating that the user at the specified terminal has special operator status. The console operator has whatever privileges are not currently held by this or another terminal user. termnam Terminal name type Type of operator privileges NOP Network operator LOP Local operator NOPLP Network and local operator	None.	CS
termnam HUNG BY NVF	The operator attempted to enable or disable terminal termnam for which NVF refused a logical connection request. The terminal will remain inaccessible until the line fails or is disabled.	The local operator can disable and then reenable the line but this action could disconnect users at valid terminals on the line. If all terminals on a line reach this inaccessible state, the line is automatically disconnected (dial-up) or disabled (hard-wired).	CS
name IN RECOVERY	The local operator attempted to enable or disable a line or terminal on an NPU whose configuration is currently being recovered. This message may also be given in response to status requests during recovery. If name is that of an NPU, the list of line status messages preceding this message will be incomplete. If name is that of a line, the list of terminal status messages preceding this message will be incomplete.	Enter command at a later time.	CS
name INOPERATIVE	The local operator attempted to send a message to a terminal (name) that is currently inoperative.	Wait for the terminal status message (TERM name,...) indicating the terminal is operational and reenter the command.	CS

<u>MESSAGE</u>	<u>SIGNIFICANCE</u>	<u>ACTION</u>	<u>ROUTINE</u>
ss INPUT CARD ERROR ec	<p>An error was detected while processing default file directives on the file INPUT. This message is followed by a card image of the directive found to be in error. The default being defined by the directive is ignored.</p> <p>ss Supervisor job containing the directive in error (CS or NS)</p> <p>ec Error code</p> <ol style="list-style-type: none"> 1 Illegal command 2 TSB request rejected 3 Extra command parameter 4 Invalid parameter 5 Input record greater than 50 characters 6 Imbedded period 7 Imbedded blank 8 Parameter greater than 7 characters 9 Duplicate NCF input card (NS only) 10 No PFN on input card 11 Duplicate LCF input card (CS only) 12 Duplicate CCP input card (NS only) 13 Maximum number of input cards exceeded 10 (NS only) 	The NS or CS job initiated by the NAM procedure file at initialization must be corrected.	NS CS
npu IS NOT NPU NAME	The network operator entered a NOP overlay command containing an invalid NPU name (npu).	Correct NPU name and reenter the command.	NS
n.nnn K CPU SCANS.	Informative message indicating the number of CPU scans ILS has completed since initialization. Dayfile message.	None.	ILS
n.nnn K INPUT CYCLES.	Informative message indicating the number of input cycles that Export has completed. Dayfile message.	None.	ILS
n.nnn K OUTPUT CYCLES.	Informative message indicating the number of output cycles that Export has completed. Dayfile message.	None.	ILS
n.nnn KILO CDCS REQUEST REJECTS FOR BUSY.	Total number of SSC rejects for busy when less than seven outstanding CDCS SSC requests existed at the time of the current request.	None.	TAF
n.nnn KILO CDCS REQUEST REJECTS FOR MAXR.	Total number of SSC attempts when there were seven (MAXR) outstanding CDCS SSC requests.	None.	TAF

<u>MESSAGE</u>	<u>SIGNIFICANCE</u>	<u>ACTION</u>	<u>ROUTINE</u>
n.nnn KILO CDCS REQUESTS FROM TASKS.	Total number of CDCS SSC requests issued by tasks. The number does not include terminate requests which are blocked by TAF.	None.	TAF
n.nnn KILO TRANSACTION ABORTS.	Upon transaction termination, this message indicates how many transaction tasks have aborted.	Data base administrator may have to correct data base to account for transactions.	TAFNAM2 TAFTS2
n.nnn KILO TRANSACTIONS PROCESSED.	Self-explanatory.	None.	TAFNAM2 TAFTS2
name LOST PRIOR CONFIGURATION INFO	The NPU specified has failed or was reloaded during recovery. Recovered configuration information is disregarded and CS will configure the NPU from the LCF.	Reenter any desired ENABLE or DISABLE commands.	CS
name MESSAGE SENT	Informative message indicating that the message entered by the local operator has been sent to the specified element which may be a terminal or an NPU.	None.	CS
n.nnn MS. DRIVER MAX. CYCLE.	Informative message indicating length of the longest driver service cycle in milliseconds. Dayfile message.	None	ILS
name NETOFF IMMINENT	The local operator attempted to issue an IDLE command for an application (name) which is already in the process of terminating.	None.	CS
divnam-NO ERRORS ENCOUNTERED.	A properly verified network and/or local configuration file has been created or listed from the indicated division by the NDL processor.	None.	DAYNNO NDLLIST
name NOT ACTIVE	The network or local operator attempted to reference an inactive element (name).	Wait for the desired element to become active and reenter the command.	NS CS
xxx NOT FOUND ON DEVICE. ENTER ALTERNATE DEVICE LOCATION.	The deadstart file does not contain the operating system or the DDS module. xxx Significance DSB DDS module OSB Operating system	Entry of alternate device location is not supported for NOS. Install the operating system or DDS module on the device and redeadstart.	EBL
xxx NOT IN PP LIB.	Dayfile message indicating that PP package xxx was not found in PP libraries.	Ensure that the correct PP package name was specified.	SFP

<u>MESSAGE</u>	<u>SIGNIFICANCE</u>	<u>ACTION</u>	<u>ROUTINE</u>
xxx NOT IN PP LIB. CALLED BY yyy.	Dayfile message indicating that PP package xxx, which was called by package yyy, was not found in the PP libraries.	Ensure that the correct PP package name was specified or inform site analyst.	SFP
xxxxxx NOT INITIALIZED BY TOTAL. STATUS IS yyyy.	An error was encountered on the Total data base.	Regenerate Total data base. Refer to Total Reference Manual for status.	TAF
appl NOT NETTED ON	The local operator attempted to issue an IDLE command for an application (appl) which was inactive.	None.	CS
name NOT RECOGNIZED	The network or local operator attempted to reference an element (name) which could not be recognized.	Enter valid element name.	NS CS
eq xx, OUTPUT LOST.	An unrecoverable write error has been encountered. The output file for the job has been discarded. eq Equipment type of device xx EST ordinal of device	Inform site analyst. Either a new flaw should be added to the device or the problem causing the write error should be corrected.	1CJ
ovlnam OVERLAY LOAD ERROR.	The MCS overlay could not be loaded so MCS aborted. ovlnam Overlay name	Inform site analyst.	MCS
nnnn PER CENT CPU USAGE.	Summary message indicating CPU usage by the transaction subsystem.	None.	TAFNAM2 TAFTS2
nnnnnn.nnn PERCENT CPU UTILIZATION.	Summary message indicating CPU utilization by the magnetic tape subsystem.	None.	MAGNET
nn TAPE FILES RECOVERED.	Informative message indicating the number of tape assignments (nn) recovered by a level 3 recovery deadstart.	None.	MAGNET1
nnn TASKS NOT LOADED INTO ECS.	An insufficient amount of ECS was available to load all tasks. The nnn field is the number of tasks not loaded.	Check ECS requested and reinitialize with more ECS if appropriate.	TAF
npu UNABLE TO ACTION MSG	The operator issued a command to send a message to all terminals on NPU npu but the NPU had an activity currently in progress.	Wait for activity to complete (approximately 15 seconds) and reenter the command.	CS

Address

The location of a word in memory. The location is designated by number or symbolic name.

Auxiliary Device

A mass storage device that is not part of a permanent file family. Auxiliary devices can contain direct or indirect access permanent files.

Breakpoint

A point where a program can be interrupted by a monitor routine to permit analysis or debugging.

Buffer

An intermediate storage area used when transmitting data between central memory and an I/O device.

Channel Number

The number of the data channel on which a peripheral device controller can be accessed.

Coldstart

A procedure used to deadstart if the tape or disk controller has not yet been loaded with controlware or the controlware is not running.

Common Testing and Initialization (CTI)

A common deadstart process that resides on the deadstart file and the maintenance system library.

Communications Supervisor (CS)

A program that coordinates the network-oriented activities of one host computer and of the lines and terminals logically linked to it.

Control Point Number

The number of the control point to which a job is assigned, while the job resides in central memory. The actual number of control points is an installation parameter. Before the job can execute, each central processor program must be assigned to a control point. Control points zero and n (the last control point) contain system parameters and pointers, and perform system functions.

Controller

A hardware device that connects channels to peripheral devices. For example, a tape controller might connect up to eight tape units to one channel.

Controlware

A special type of software that resides in a peripheral controller. The controlware defines the functional characteristics of the controller.

CYBERLOG

The program initiated after deadstart that requests data about the event that caused the need for a new deadstart.

Data Channel

One of the nine to 24 channels (12-bit) by which information passes between the peripheral processors and peripheral devices.

Dayfile

A chronological file, maintained on a mass storage device, which forms a permanent accounting and job history file. Dayfile messages are generated by your action or by the system when control statements are processed or other significant action occurs. A portion of the most recent system dayfile is displayed at the console; a copy of the job dayfile is printed with the output for each job.

Deadstart

The process of initializing the system by loading the operating system library programs and any of the product set from magnetic tape or disk. Deadstart recovery is reinitialization after system failure.

Deadstart Sequencing

The execution of a selected set of commands before normal system job scheduling is enabled.

Default Value

A fixed value supplied by the system for a missing parameter.

Direct Access File

A permanent file that is accessed and modified directly without making a temporary copy.

DIS (Job Display)

A system peripheral processor program similar to system display (DSD) that provides communication between a job in central memory and the operator at the console, and permits you to control execution of the program through the console keyboard.

Displays

Two console screens or a split screen used to display system and job information, operator messages, and contents of central memory. Through the console keyboard, you can control the operation of the system. The displays are identified by alphabetic characters. You can request various displays; some used frequently are: job status (B), system files (H), and dayfile messages (A).

Downline

The direction of output flow, from host computer to terminal.

DSD (System Display)

The operating system program that provides communication between you and the system by accepting control information typed on the console keyboard and by displaying to you information pertinent to all jobs known to the system. DSD is permanently assigned to PP1.

ECS

An extended core storage containing 60-bit words. ECS has a large amount of storage and fast transfer rates. It can also be used as if it were a disk for functions such as high speed system loading or rolling out user jobs. The acronym ECS refers to all forms of extended memory unless otherwise noted. For details refer to the preface.

EST Ordinal

The number designating the position of an entry within the equipment status table established at each installation. Devices are identified in operator commands by these ordinals, ranging from 1 to 77 octal. The EST ordinal is sometimes referred to as equipment number.

Family Name

A designation that the installation may give to a group of permanent file devices.

Field Length

The area in central memory allocated to a particular job; the only part of central memory that a job can directly access.

First Level Peripheral Processor (FLPP)

The processor that is connected directly to the CYBER 170 Model 176 mainframe and operates synchronously with the mainframe.

Forms Code

An attribute of output files and output devices. The user can specify special forms required for output; you can mount the special forms and use the FORMxx,fc command to let the system process the user's output.

Indirect Access File

A permanent file that is accessed and modified by making changes to a temporary copy of the file, which can be substituted for the contents of the permanent file.

Local Batch Job

A job submitted at the central computer site through a card reader.

Local Operator (LOP)

The administrative operator who manages the communication elements of the network within the computer system by communicating with the communications supervisor in the host computer. The local operator is an administrative operator within the network and need not be the host computer's operating system operator.

Mass Storage Device

An ECS or disk unit which has defined logical attributes such as family, file residency, and so on.

Monitor

The routines residing in central memory (CPUMTR) and PP0 (MTR) which control all system activities.

Multimainframe System

A network of physically and logically connected NOS computer systems.

Multispindle Device

A logical mass storage device which includes two to eight disk units.

Multiterminal Job

A job which does one specific task for many terminals while being scheduled into the system only once.

Network

An interconnected set of network processing units, hosts, and terminals.

Network Operator (NOP)

The administrative operator who manages the hardware, linkages, and other network elements of the data communication network by communicating with the network supervisor in a host computer. The network operator can also be a local operator, but might not be the operating system operator for the host computer.

Network Processing

The collection of hardware and software that switches buffers, and transmits data between terminals and host computers.

Network Supervisor (NS)

The program that coordinates all of the NPUs in the communication network.

Output File

The system-defined file which contains all the output from job processing. It is also known as a print file.

Parity

In writing data, an extra bit is either set or cleared in each byte so that every byte has either an odd number of bits set (odd parity) or an even number of bits set (even parity). Parity is checked when reading the data for error detection and possible recovery.

Peripheral Processor (PP)

The hardware unit that performs input and output through the data channels. They also perform many system management tasks, such as scheduling.

Permanent File

A mass storage file cataloged by the system so that its location and identification are always known to the system. Permanent files cannot be destroyed accidentally during normal operation (including deadstart), and they are protected by the system from unauthorized access according to privacy controls specified when they are created.

Physical Record Unit (PRU)

The amount of information transmitted by a single physical operation of a specified device. The size of a PRU depends on the device, as follows:

<u>Device</u>	<u>Size in Number of 60-Bit Words</u>
Mass storage	64
Tape in I format or in SI format with binary data	512
Tape in other format	Size varies†

A PRU that has less than the previously listed words is called a short PRU; a PRU that has no user data is called a zero-length PRU.

Procedure File

A file containing control language and/or control statements that can be saved and used again.

Pseudo A Register

A software register used by DSD to function channels and to manipulate peripheral hardware devices from the operator's console.

Remote Batch Job

A job submitted from a remote batch terminal.

Remote NPU

A network processing unit linked indirectly to a host computer through other network processing units.

Rollout

The act of removing a job from central memory before execution is complete so memory can be assigned to another job. A rolled out job loses its control point assignment.

Rollout File

A file containing a job that is temporarily removed from central memory.

Sector

A sector is the same as a PRU. Refer to Physical Record Unit.

Step Mode

A protected or debugging mode for the operating system monitor. The keyboard spacebar must be pressed to process each PP request.

System Job

A job brought to a control point by the operator.

System Library

The collection of tables and object language programs residing in central memory or on mass storage which are necessary for running the operating system and its product set.

System Origin Job

A job entered at the system console.

Time-Sharing Job

A job initiated from a terminal.

Timed/Event Rollout File

A file containing a job that is temporarily removed from central memory. It is rolled back into central memory only when a specified event (such as a file is no longer busy) or a specified time period has elapsed.

Trunk

The communication line connecting two network processing units.

Unit Number

The setting of a hardware device. Used when more than one hardware unit can be connected to a controller.

Upline

The direction of input flow from terminal to host computer.

Warmstart

A procedure used to deadstart if the tape or disk controller is loaded and the controlware is running.

† Refer to the NOS Reference Manual, Volume 2, for the PRU sizes of tapes in other formats.

All on-line peripheral equipment runs under the control of NOS. To determine the EST ordinal and current status (ON or OFF) of a device, examine the EST display. A device must be logically ON before it can be used by NOS. Refer to the description of the ON command in section 3 to logically turn on a device.

405 CARD READER OPERATION

Once the MAIN POWER switch on the card reader is lighted, load and start the reader as follows:

1. Set guide edge of input feed hopper and output stacker for length of card. Narrow half of each tray may be removed, turned end-for-end, and reassembled as necessary.
2. Load cards into hopper, placing column 1 at right as cards face entrance of read station.
3. Check input wall of secondary and main output stackers. If standard cards are used, hinged card-stopping blocks should be positioned to form a flush surface at each input wall. If short cards are used, hinged block assemblies must be pivoted to protrude from wall surfaces of each stacker.
4. At feed hopper, set card-stopping pin to protrude from faceplate if short cards are used; turn pin in clockwise direction to form flush wall if long cards are used.
5. If short cards are to be read, press 51 COLUMN switch until it lights.
6. To check operation:
 - a. If MAN is not lighted on AUTO/MAN switch, press switch to place equipment in manual mode.
 - b. If STOP is not lighted on RUN/STOP switch, press switch so that STOP lights.
 - c. Press MOTOR POWER switch. Light should turn on and input hopper should begin vibrating.
 - d. Press READY switch until it lights.
 - e. Press SINGLE PICK switch to cause first card to be read and transferred to output stacker. No light exists. If card does not move properly, check read station for an obstruction.
 - f. Press MOTOR POWER to stop vibrators and replace card in input hopper.
7. To allow cards to be read:
 - a. Press RUN/STOP so that RUN lights, if necessary.
 - b. Press AUTO/MAN so that AUTO lights.
 - c. Press MOTOR POWER so that it lights.
 - d. Press RELOAD MEMORY. It does not light.
 - e. Press READY until it lights.

The switches and indicators on the reader (figure D-1) are explained in the following paragraph. They differ slightly depending upon the type of controller (3649 or 3447). The controllers are an integral part of the card reader equipment.

MAIN POWER

Controls all primary power and turns on the photocell light source. It is lighted when power is on. It must be on before subsequent operations are effective.

MOTOR POWER

Controls power to the drive motors, the vacuum-pressure system, and the hopper-stacker vibrators. It must be on before the READY status is effective. It is lighted when on.

AUTO/MAN

Selects manual or program controlled modes of operation. The switch must be in the AUTO position when the reader is to be controlled by the system. Change switch position to MAN to disable system control and allow you to cycle cards manually.

(Used With 3649 Controller)

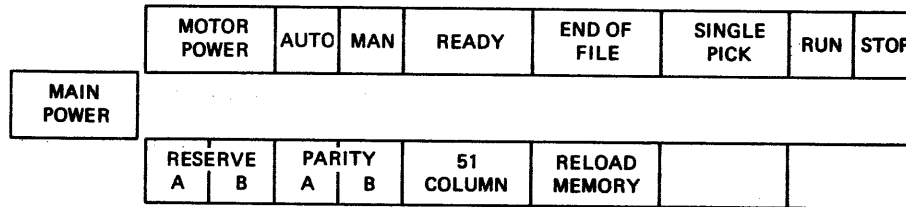

(Used With 3447 Controller)

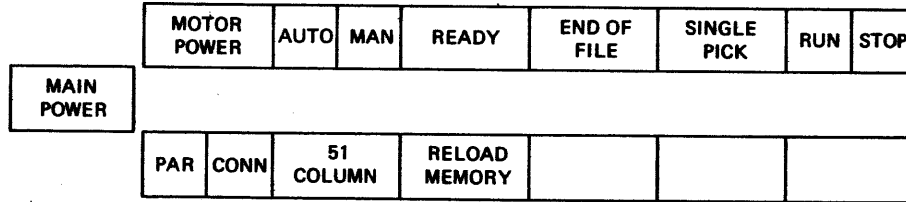

Figure D-1. Card Reader Switches

READY

The switch lights to indicate the ready condition. When the switch is pressed, the first card is read into buffer memory. Thereafter, the reader is under system control. If the input hopper is empty, error conditions exist on the device, the output stacker is not closed or it is full, a not ready condition exists.

END OF FILE

Causes the reader to generate an end-of-file status bit after the last card in the input tray is read. It lights when set. If the last card in the input tray is not the last card in the file being read into the system, this switch should be off. Currently not used by NOS. Included for compatibility with previous systems.

SINGLE PICK

Cycles a single card through the reader when the AUTO/MAN switch is in MAN position. It does not light.

RUN/STOP

The card feed may be controlled manually when the AUTO/MAN switch is in MAN position. The set side is lighted.

RESERVE A/B (3649 Controller only)

One side lights as one of the two converters attached to the controller reserves reader access.

PARITY A/B (3649 Controller only)

This light appears only when a parity error occurs during the transmission of a connect or function code. An error message will appear on the console screen.

PAR/CONN (3447 Controller only)

Similar to the RESERVE and PARITY switches of the 3649 Controller in that one side lights for a parity error and the other when the reader is connected to the controller channel.

51 COLUMN

Allows short (51-column) cards to be read. It is lighted when set.

RELOAD MEMORY

Feeds data from a new card into card reader memory buffer when pressed, providing AUTO/MAN is in AUTO. It does not light. It should be pressed prior to each READY.

Inside the right front door are several lights that indicate malfunction. If FEED/FAIL is lighted, a card is not acceptable or a card jam exists. Lifting the read station panel will expose the card guides. The PRE-READ and COMPARE lights indicate that the pre-read and read stations do not interpret a card identically. If the card reader stops during operation, examine the BATCHIO (I) display to determine the action to take. The action can involve rereading one or several cards. If the card reader stops at the end of a batch job, check the I display to ensure that there were no errors on the last card.

415 CARD PUNCH OPERATION

The 415-30 card punch contains the 3446 controller in the same cabinet. The controller for the 415 card punch, 3644 or 3446, is in a separate cabinet. It has the equipment number switch that establishes the equipment number for the punch in the EST display. With the exception of the lights mentioned in the following paragraph, controller switches are the responsibility of the customer engineer.

Once the MAIN POWER and MOTOR POWER switches on the card punch are lighted, operation is initiated as follows:

1. Place cards face down in input hopper with row 9 toward rear.
2. Check that chip box and output stacker are not full.
3. Advance two cards into the punch and read stations by pressing the SINGLE PICK switch twice.
4. Check the controller equipment. If either the NOT READY or FAIL TO FEED light is on, cards have not advanced into the punch and read stations.

The card punch is then ready for operation.

Switches on the card punch (figure D-2) have the following functions.

MAIN POWER	MOTOR POWER
FEED	STOP
SINGLE PICK	READY
INTERLOCK	TEMP

Figure D-2. 415 Card Punch Switches

MAIN POWER

This switch applies power to the cooling fans and the power supplies. It is lighted when power is on.

MOTOR POWER

This switch applies power to the punch motor. It is lighted when power is on.

FEED

This indicator lights when a card jam exists. A message CPU NOT READY appears at the console. Call a customer engineer to remove the jammed card.

STOP

This switch causes the punch to become not ready. It lights when pressed to stop system control.

SINGLE PICK

This switch advances cards one station in the input hopper-punch-read-output cycle. It lights until the advance is complete.

READY

This switch clears punch logic and puts it in automatic mode for system control. It lights when the punch is in a ready condition. If it does not light when pressed, conditions such as feed failure and full output stack should be examined and corrected.

TEMPERATURE

If this light is on, the temperature of the punch exceeds operation requirements. Consult a customer engineer.

INTERLOCK

This switch lights if the head panel, hood panel, or right door is open. All should be closed during operation.

STACKER FULL

This switch lights when the output stacker is filled. It resets automatically when cards are removed from the stacker.

A toggle switch at the top of the output stacker automatically turns off the card punch when the stacker is full. Reset the switch when cards are removed from the stacker.

580 LINE PRINTER OPERATION

The 580 line printer includes both the printer and controller in one cabinet. Operator manual controls on the back duplicate three switches on the front to facilitate removing paper. Figure D-3 shows configuration of the 580 Line Printer switches.

POWER OFF	6 LINE	8 LINE	PAGE EJECT	STOP
--------------	-----------	-----------	---------------	------

POWER ON	ERROR OVERRIDE	LAMP TEST	START
-------------	-------------------	-----------	-------

FILL IMAGE	CONT PWR	CONN	TRANS PAR	PRINT ERROR	MEMORY BUSY
---------------	-------------	------	--------------	----------------	----------------

DC POWER	IMAGE PARITY	SYNC CHECK	HAMMER CHECK
THERMAL	BUFFER PARITY	COMPARE CHECK	PAPER CHECK

Figure D-3. 580 Line Printer Switches

When the POWER ON switch is lighted indicating power to the printer, control operation with the following switches.

POWER OFF

Turns off power supply.

6	8
LINE	LINE

Pressing alternates between 6 and 8 line-per-inch spacing. One-half of the indicator is illuminated, depending on which spacing mode has been selected.

PAGE EJECT

Under manual control, advances paper to top of form as determined by format loop control.

STOP

Stops printer control.

LAMP TEST

Pressing causes all lamp indicators on the control panels to light.

START

Readies printer (lighted when selected).

The remaining indicators light when the condition specified has occurred.

FORMAT (CARRIAGE CONTROL) TAPE LOADING

1. Press the POWER HOOD switch to raise hood.
2. Loosen the tape spool and slide it toward the drive hub.
3. Place the format tape on the drive hub and in the space between the reader and the lamp housing. The coincidence lines on the format tape must be aligned with the scribe lines on the drive hub and the arrows on the tape must point toward the back of the printer.
4. Place the format tape over the tape spool, slide the tape spool down the slot until there is 1/8-inch slack in the format tape loop.
5. Tighten the tape spool.

Standard format tape configurations for the 580 Line Printer are given in appendix A.

PAPER LOADING

To load paper into the 580 printer:

1. Press POWER HOOD switch on left side of cabinet to raise hood.
2. Remove old paper supply with PAGE EJECT switch.

3. Open front printer gate.
4. Open pressure plate on upper and lower left and right tractors.
5. Raise paper vertically from supply box and place into upper and lower paper tractors. Ensure that header page will always be an inner page (that is, page is visible when output is laid flat) by placing inner fold at front edge of printer's paper bail assembly. Close all four pressure plates.
6. Close front panel securely.
7. Press PAGE EJECT four times and manually feed the forms over the paper bail and into the stacker exit rollers.
8. In back of printer, press PLATFORM DOWN switch to lower forms platform.
9. Press PAGE EJECT to observe that forms fold properly and are correctly aligned.
10. Press PLATFORM UP switch and observe that forms fold and fit properly as platform rises.

To load forms of a different width or thickness:

1. Move tractors to approximate position by loosening the tractor locking knob and sliding tractors until aligned. Tighten locking knob.
2. Place forms in upper left paper tractor and close tractor door.
3. Place forms in lower left paper tractor and close tractor door.
4. Place forms in upper right paper tractor and close tractor door.
5. Place forms in lower right paper tractor and close tractor door.
6. Slide the two right tractors to adjust the horizontal paper tension. Forms should not buckle (too loose) and the tractor pins should not deform the holes (too tight). Tighten the tractor locking knobs on the right hand tractors.
7. Close the forms alignment scale against the paper. The scale indicates print column location and the top of the ribbon shield indicates the bottom of the next line of print.
8. Adjust the horizontal position control to align the forms with the proper print columns.
9. Place the forms lock control in the manual position and adjust the manual forms advance control to align forms vertically to the top of forms position.
10. Place the forms lock control in the auto position, reattach the forms alignment scale to the print gate, and the print gate to the print head.
11. Press PAGE EJECT three times and manually feed the forms over the paper bail and into the stacker exit rollers.

12. In back of printer, press PLATFORM DOWN switch to lower forms platform.
13. Press PAGE EJECT to observe that forms fold as originally folded, that multipart forms do not separate, and that the forms are properly aligned to the forms scales.

RIBBON CHANGE

1. Press the POWER HOOD switch on left side of cabinet to raise hood.
 2. Press POWER OFF switch.
 3. Unlatch print gate and swing away from the print head.
 4. Unlatch ribbon cover and swing away from the print gate.
 5. Unlatch line finder and swing away from the print gate.
 6. Grasp the ribbon rolls with the left hand on the upper roll and the right hand on the lower roll.
 7. Push the rolls toward the hinged end of the print gate; lift the upper roll up and off the spool and the lower roll down and off the spool.
 8. Pass the left hand over, behind, and then under the print gate and remove the ribbon.
 9. After the new ribbon is unwrapped, grasp one roll in the left hand and the other roll in the right hand.
 10. Approaching print gate from the latch end, hold right hand in front of lower ribbon spools. Pass ribbon roll in left hand under, behind, and over the print gate bringing it to the upper ribbon spools.
 11. Press ribbon roll in left hand against the upper ribbon spool on the hinged end of the print gate and press the roll in right hand against lower ribbon spool.
 12. Ease the ribbon rolls into place against the ribbon spools on the latch end of the print gate ensuring that the drive keys on the ribbon spools fit into the slots in the ribbon rolls.
 13. Rotate upper ribbon roll to take up slack.
 14. Latch linefinder and ribbon cover to print gate and close print gate.
 15. Press POWER ON switch.
3. Press POWER HOOD switch on left side of cabinet to raise hood.
 4. Open front printer gate.
 5. Open pressure plate on upper and lower left and right tractors.
 6. Raise paper vertically from supply box and place into upper and lower paper tractors. Close all four pressure plates.
 7. Close front panel securely.
 8. Align paper to top of form by pressing the PAGE EJECT switch, causing the paper to advance to subsequent 6/8 LPI coincidence points as required. Paper thus positioned will be at top of form when the system loads a PFC array before a job is printed.
 9. Close the forms alignment scale against the paper. The scale indicates print column location and the top of the ribbon shield indicates the bottom of the next line of print.
 10. Adjust the horizontal position control to align the forms with the proper print columns.
 11. Place the forms lock control in the manual position and adjust the manual forms advance control to align forms vertically to the top of forms position.
 12. Place the forms lock control in the auto position, relatch the forms alignment scale to the print gate, and the print gate to the print head.
 13. Press START switch.

NOTE

This initialization procedure assumes that the first code loaded into the PFC buffer will be top of forms (format level 1).

BATCHIO loads the PFC buffers at the start of each print file. Prior to loading a PFC array, pressing the PAGE EJECT switch advances the paper to the next 6/8 LPI coincident point. After a PFC array has been loaded into the printer, pressing PAGE EJECT causes an entire form to be ejected.

MAGNETIC TAPE UNITS

NOS supports unit models 667 and 677 for 1/2-inch, 7-track magnetic tape and models 669 and 679 for 1/2-inch, 9-track tape.

All models show a unit number at the top of the cabinet (right side of the controls on a 667 or 669 unit, left side of the controls on a 677 or 679 unit) which ranges from 0 to 17 and is used to identify the unit. The unit number of a 667 or 669 tape unit is set using the select switch labeled UNIT NO/HOLD REL located beside the unit number display. Each unit that is on should have a unique number but once

580 LINE PRINTER PROGRAMMABLE FORMAT CONTROL INITIALIZATION

1. Press POWER ON switch.
2. Press PAGE EJECT switch. The printer controller advances to the next 6/8 lines per inch (LPI) coincident point. The tractors physically advance accordingly.

this switch is set, it can be ignored during operation. It is not possible to change unit numbers on 677 or 679 tape units.

CAUTION

Do not change unit numbers on 667 or 669 tape units when the magnetic tape subsystem is being used.

The system and the operator identify a unit by its EST ordinal as shown in the E display. Installations usually configure the system so the last digit of an ordinal for a tape drive is the same as the unit select switch setting, making it easier to equate the two.

On-line operation of tape units is controlled and synchronized with system demands by an associated tape control unit. Power up and autothread/autoload operations are facilitated by front panel controls and indicators located at the top front of the tape unit. Controls for 667/669 and 677/679 tape units differ slightly as described in the following two sections.

If a magnetic tape unit is currently assigned to a job, it cannot be unloaded. Examine the tape status (E,T.) display to determine if the magnetic tape unit is currently assigned to a job. If it is not, entering the UNLOAD command causes the tape to unload. Refer to the description of UNLOAD in section 3.

667 AND 669 TAPE UNITS

The functions of the switches and indicators on the 667/669 tape unit (figure D-4) are described below. Switches with alternate actions are described in terms of (1) first and (2) second action.

POWER

(1) Activates power circuits, places tape unit in a power-up status, and lights indicator. (2) Deactivates power circuits, places tape unit in a power-down status, and turns off indicator light.

LOAD REWIND

(1) Initiates load operation (reel-to-reel contact, thread and set loops). (2) When unit is off-line, initiates rewind to loadpoint operation.

UNLOAD/WINDOW DOWN

Initiates unload operation by rewinding leader length onto right reel.

READY

Places tape unit under system control via tape control unit. Light indicates unit is in ready status awaiting system activity. Light extinguishes when a fault condition is detected.

CLEAR/WINDOW UP

When tape unit is on-line, negates READY condition and stops tape motion. When unit is off-line, stops tape motion and clears fault condition. Light comes on when loop fault is detected.

NOTE

Do not use this control during system operation.

SELECT

No switch function. Light comes on when tape unit is selected by tape control unit.

LOAD POINT

No switch function. Illuminates when loadpoint marker or end of tape marker is detected, depending upon tape motion direction.

LOAD FAULT

No switch function. Indicates a fault occurred during load procedure.

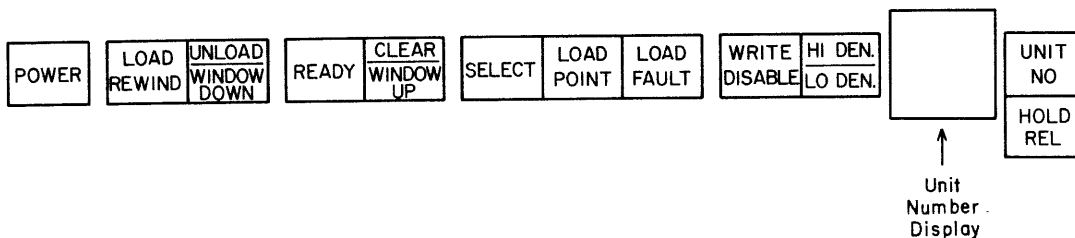

Figure D-4. 667/669 Tape Unit Operator Control Panel

WRITE DISABLE

No switch function. Illuminated, it indicates the absence of a write enable ring in the right tape reel. Disables the write circuitry and conditions the tape unit to accept only read functions.

HI DEN/LO DEN

No switch function. HI DEN illuminates in phase mode for 9-track tapes or in 800 bpi NRZI mode for 7-track tapes. LO DEN illuminates in 800 bpi NRZI mode for either 9- or 7-track tapes or for 556 bpi NRZI mode for 7-track tapes.

Unit Number Display

Shows tape unit number in octal numbers, 00 to 17.

UNIT NO/HOLD REL

Two-position rocker switch used to assign tape unit number. Pressing UNIT NO causes that portion of the switch to light, indicating that a hold status is being sent to the tape controller unit. Numbers shown on the unit number display advance until UNIT NO is released. Pressing HOLD REL removes the hold status on the tape unit; the indicator light turns off.

677 AND 679 TAPE UNITS

The functions of the switches and indicators on the 677/679 tape unit (figure D-5) are described below. Switches with alternate actions are described in terms of (1) first and (2) second action.

POWER ON/OFF

(1) Activates power circuits, places tape unit in power-up status, and lights indicator. (2) Deactivates power circuits, places tape unit in a power-down status, and turns off indicator light.

LOAD/REWIND

(1) Initiates load operation (reel-to-reel contact, thread and set loops). (2) When unit is loaded but not ready, initiates rewind to loadpoint operation.

START/READY

Places tape unit under system control via tape control unit. Light indicates unit is in ready status awaiting system activity. Light extinguishes when a fault condition is detected.

REWIND UNLOAD

If the unit is loaded but not ready, the tape is rewound to BOT and the tape unit is unloaded. If present, the cartridge closes. The reel latch and window open.

If the unit is not loaded or a fault has been detected, the window lowers.

CLEAR/WINDOW UP

When tape unit is on-line, negates READY condition and stops tape motion. If window is down, it is raised. Load check is reset if applicable.

NOTE

Do not use this control during system operation.

POWER FAULT/LOAD FAULT

No switch function. Indicates a power fault occurred or a fault occurred during the load procedure.

SELECT

No switch function. Light comes on when tape unit is selected by tape control unit.

BOT/EOT

No switch function. Illuminates when loadpoint marker or end of tape marker is detected, depending upon tape motion direction.

WRITE DISABLE

No switch function. Illuminated, it indicates the absence of a write enable ring in the right tape reel. Disables the write circuitry and conditions the tape unit to accept only read functions.

TAPE UNIT OPERATION

All tape units can handle cartridge-contained tape reels or standard 10-1/2-inch supply reels. Smaller noncartridge reels can be used, but they must be threaded manually. The take-up reel on left side is a vacuum hub assembly permanently attached to the tape unit.

When a load sequence is initiated, the cartridge-contained tape reel programs the tape unit to thread tape and load loops into the vacuum columns automatically. Internal delays control the timing of the load/thread operation. If a fault is detected during a load attempt or if a successful load is not achieved, one automatic retry is executed. At the expiration of the automatic load attempt, the tape unit automatically stops and lowers the power window. When standard reels are used, the automatic retry is inhibited and operator action is required.

The power window of the tape unit is activated by control logic circuits and is raised or lowered in response to LOAD and UNLOAD commands initiated by you. Initially, when the POWER switch is pressed, the window lowers, allowing access to the tape deck. An interlock protection switch prevents power window operation when the front access door is open.

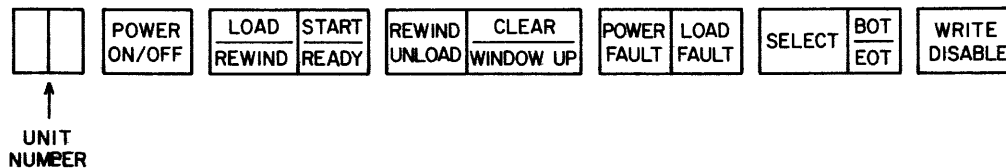

Figure D-5. 677/679 Tape Unit Operator Control Panel

Prior to operating the tape unit, review thoroughly the description of control switches and indicators. The following operating instructions apply to all 667/669 and 677/679 tape units unless specifically noted.

REEL INSTALLATION

Standard (Noncartridge) Reel

1. Power up unit by pressing POWER switch. POWER light illuminates and the window lowers.
2. Install write-enable ring within inner surface cutout of reel if write operation is to be performed. The write-enable ring is to be installed only if a write operation is to be performed. Valuable data stored on the tape must be protected by removing the write ring when read only operation is to be performed.
3. Place reel into right hub. Ensure that reel is fully seated against hub face.
4. Manually rotate reel hub clockwise until several inches of tape leader extend along inner surface of tape chute.

Cartridge-Loaded Reel

1. Perform steps 1 and 2 as for standard reel.
2. Orient cartridge reel on hub so that locating notches in cartridge retainer and chute assembly align with keys on outer rim of cartridge. Ensure that actuator rod fits into recess of cartridge latch.

3. Press cartridge into place on hub; seat firmly against hub face.

LOAD/THREAD

Operator action, such as pressing LOAD/REWIND switch, initiates a load/thread operation. The cartridge actuator rotates clockwise until the cartridge is brought to the full open position. Observe the following points for either cartridge or standard reels.

1. Tape proceeds along tape feed path and enters the left vacuum reel enclosure.
2. Left reel rotates clockwise until load point marker is detected. Reel motion then ceases.
3. Tape is drawn immediately into loop columns and drops below AR and AL sensors.
4. Motion stops when load point marker is correctly positioned.

READY STATUS

At completion of load/thread sequence, the tape unit is placed in ready status if the READY (667/669) or START READY (677/679) switch on the front panel of the tape unit has been pressed. The indicator illuminates, followed by the SELECT light, indicating receipt of an on-line callup by the system.

REWIND

The LOAD/REWIND switch rewinds a tape to load point when the tape unit is off-line. It is not necessary to use this switch during normal operation, since the operating system controls tape movements.

UNLOAD AND REEL REMOVAL

The REWIND/UNLOAD switch rewinds and unloads a tape when the tape unit is off-line. It is not necessary to use this switch during normal operation, since the operating system controls tape movements. The operator command UNLOAD,xx, logically unloads a tape that is physically loaded but not in use.

After unload is initiated, the tape rewinds at high speed until the load point marker is detected. A downshift to normal operating speed occurs at load point detection. The leader length unwinds completely from the left onto the right reel and simultaneously, the cartridge closes and the power window lowers. The automatic hub, if applicable, releases the right tape reel for removal from the tape deck area.

EMERGENCY STOP

Operator action of the CLEAR switch terminates the operation in progress. Switch activation is effective in either off-line or on-line mode. Pressing the CLEAR switch one time, while in rewind mode, causes the unit to down shift to normal tape speed; 200, 150, or 100 inches per second. A second activation terminates the rewind operation and causes the tape movement to stop.

REFLECTIVE MARKERS

The load point and end-of-tape markers are placed near the beginning and end of the tape to enable sensing of the usable portion of the tape by the photocells. Adhesive material on one side of reflective material secures the markers to the tape. Vaporized aluminum deposited on the material creates a highly reflective surface.

The markers, approximately 1.2 inches long and 0.2 inch wide, are placed on the uncoated side of the tape. The uncoated side is the underside of the tape when mounted on the tape deck. The end-of-tape marker is placed on the edge of the tape nearest the tape deck; the load point is placed on the outer edge of the tape. The 667/669 tape unit is capable of loading tapes with load point markers located up to 40 feet from the beginning of the tape. The 677/679 tape unit is capable of loading tapes with load point markers located up to 26 feet from the beginning of the tape. Recommended distance is 10 to 18 feet.

844 DISK STORAGE UNIT OPERATION

To ready an 881 or 883 disk pack on the 844 Disk Storage Unit:

1. Press the main cover latch and lift the main cover of the unit. Remove the base of the pack container so that the pack is held only by its cover.
2. Using its cover as a handle, place the disk pack slowly over the spindle until it engages the spindle drive unit. Turn the disk pack cover clockwise to a full stop position. At this point, the cover is released from the pack and can be lifted off.

† This switch is used for maintenance only.

3. Close the main cover making sure that it latches. If the cover is not securely latched, the dust cover interlock remains open and prevents power application.
4. Press the START switch to apply power to the unit. When the disk pack is at operating speed, the READY indicator lights. The disk storage unit is now ready for operation.

Before unloading an 881 or 883 disk pack from the 844 Disk Storage Unit, examine the mass storage status (E,M.) display. A disk pack can be physically unloaded only if the global unload status (N) is displayed on all machines accessing the disk pack. Refer to the description of UNLOAD in section 3.

To unload:

1. Press START switch to turn off indicator light and stop unit.
2. When disk pack has stopped spinning, press main cover latch and lift main cover.
3. Place a disk pack cover over loaded disk pack so that it engages spindle. Turn counterclockwise until spindle clicks, and lift cover and disk pack from unit. Replace base of pack container.

885 DISK STORAGE UNIT OPERATION

The functions of the switches and indicators on the 885 Disk Storage Unit (figure D-6) are described as follows. Switches with alternate actions are described in terms of (1) first and (2) second action.

CHAN I ENABLE
or
CHAN II ENABLE

(1) Enables communication between drive and controller attached to associated drive channel; lights indicator. (2) Disables communication between drive and controller attached to associated drive channel; turns off indicator light.

I
RSVD
or
II
RSVD

No switch function. Lights when controller reserves associated drive channel.

SYST
MAINT †

(1) Enables fault checking and manual seek tests; lights indicator. (2) Disables fault checking and manual seek tests; turns off indicator light.

SELECT
& RSVD

No switch function. Lights when reserved drive channel is active.

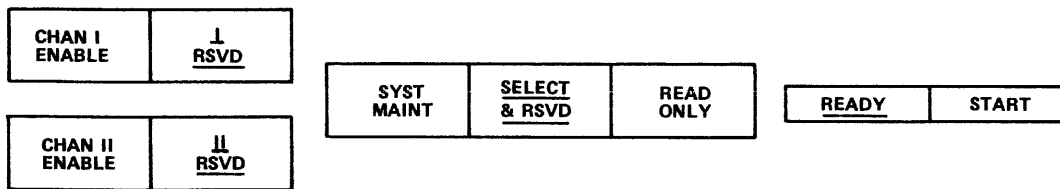

Figure D-6. 885 Disk Storage Unit Switches and Indicators

READ ONLY

(1) Disables write logic within drive and lights indicator. (2) Enables write logic within drive and turns indicator light off.

READY

No switch function. Lights when disk pack reaches operating speed and drive is on track.

START

(1) Applies power to drive motor and lights indicator. (2) Removes power from drive motor and turns indicator light off.

For additional information, refer to the 7155 Disk Storage Subsystem Customer Troubleshooting Guide.

DISPLAY CONSOLE (CYBER 170 SERIES) OPERATION

The console panel (figure D-7) contains the DEAD START button and controls affecting the appearance of displayed information.

The following controls allow the operator to change the characteristics of displayed characters.

CENTERING

Varies horizontal and vertical position of display.

FOCUS

Changes clarity in center areas of display.

INTENSITY

Varies brightness of display.

Located on the lower-right side of the console keyboard is the PRESENTATION CONTROL rocker switch. It is labeled LEFT, RIGHT, and MAINTENANCE to allow the operator to specify a single left screen display (LEFT), a single right screen display (RIGHT), or the normal setting, a split screen display containing a left and a right display (MAINTENANCE).

6612 DUAL SCREEN DISPLAY CONSOLE (CYBER 70 AND 6000 SERIES) OPERATION

Controls on a panel below the display screens (figure D-8) allow you to change the characteristics of displayed characters.

Controls to the left affect both screens:

GAIN

Varies width (HORIZ) or height (VERT) or area of display.

CENTERING

Varies horizontal and vertical position of display.

The sets of three knobs affect the right and left screens individually.

INTEN

Varies brightness of display.

FOCUS

Changes clarity in center areas of display.

ASTIG

Changes clarity at edges of display.

PROCEDURES TO INITIALIZE REMOTE 255x NETWORK PROCESSING UNIT (NPU)

The remote 255x network processing unit (NPU) is downline loaded from the local 255x NPU with the communications control program (CCP) operating system. Use the following procedure:

1. Place system autostart module-cassette (SAM-C) containing system autostart module-program (SAM-P) in cassette deck.
2. Press MASTER clear switch.
3. Set REMOTE/LOCAL switch to REMOTE.

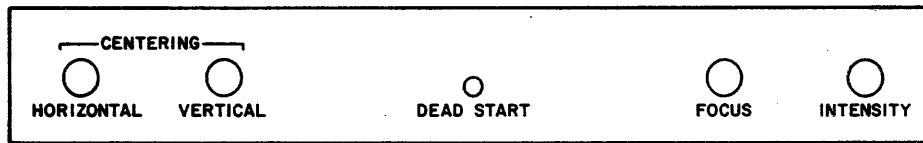

Figure D-7. Console Panel

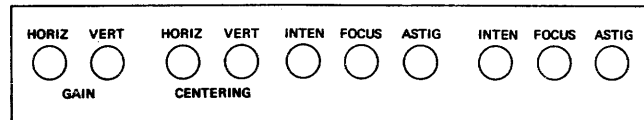

Figure D-8. Display Controls

4. Press CASSETTE REWIND switch.
5. Press DEADSTART button.

After a short timeout, the remote NPU reads the cassette and begins the loading process.

Do not remove the SAM-P cassette. It must remain in place and enabled to automatically dump and reload the NPU in case of a failure. Power to the cassette deck is turned off when the remote NPU is not operating.

MASS STORAGE FACILITY

The mass storage facility (MSF) includes mass storage adapter (MSA), mass storage transport (MST), and cartridge storage unit (CSU) hardware components. Operation of MSF proceeds under computer control, but your action is required to add cartridges to or remove cartridges from the CSU. Figure D-9 illustrates a CSU, and figure D-10 illustrates an input/output drawer.

ADDING CARTRIDGES

To add cartridges to the CSU, perform the following steps:

1. Press the OUT portion of the position switch of the input (upper I/O) drawer. When the drawer OUT indicator lights, unlock and open the door.

2. Insert individual cartridges into the correct slots of the input drawer or remove the empty octapack and insert a new octapack that contains the desired cartridges. To remove the octapack, press down on the release lever located directly under the octapack and pull on the bottom portion of the octapack. When a cartridge is properly aligned, it can be placed easily into its slot. Ensure that it is pushed in as far as it can go.
3. Close and lock the door. Press the IN portion of the position switch of the input drawer. The drawer cannot be moved in unless the door is shut securely. When the drawer IN indicator lights, the inserted cartridges can be accessed under computer control.

REMOVING CARTRIDGES

1. Press the OUT portion of the position switch of the output (lower I/O) drawer. When the drawer OUT indicator light, unlock and open the door.
2. Remove the cartridges individually or remove the octapack (refer to the procedure described under adding cartridges). Insert an empty octapack.
3. Close and lock the door. Press the IN portion of the position switch of the output drawer.

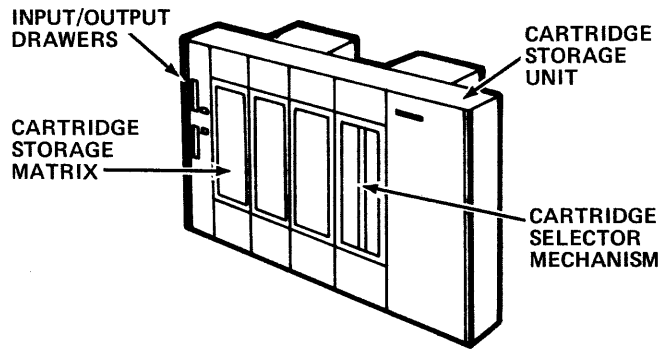

Figure D-9. Cartridge Storage Unit

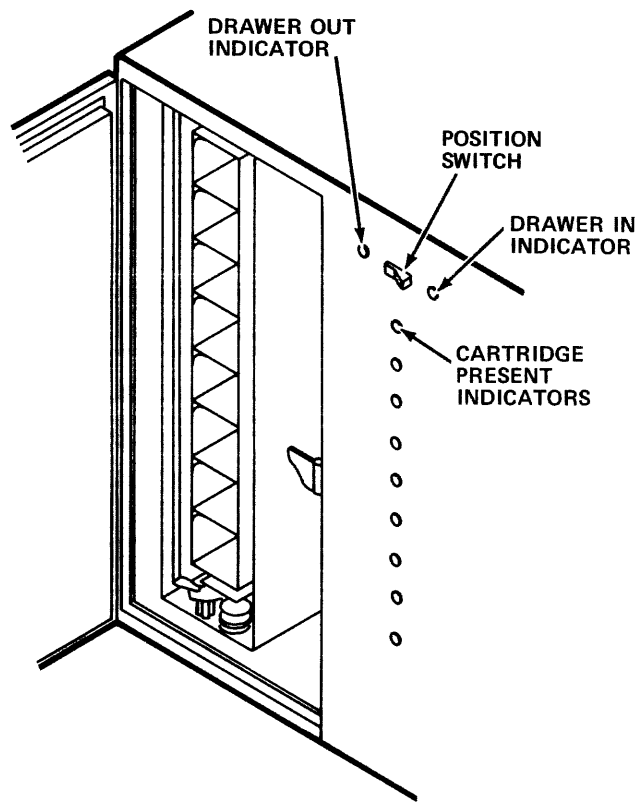

Figure D-10. Input/Output Drawer

This appendix gives rules and recommendations to follow in operating a multmainframe system.

- Do not mount packs with duplicate labels.
- Ensure that shared removable devices are mounted on an active machine before deadstarting a second machine that will be accessing these devices. Check the E,M display on the active machine to determine if the devices are mounted. None can have global unload (N) status set.
- Physically dismount a device only if the global unload (N) status is displayed on the E,M display for that device.
- If a level 3 recovery deadstart is required, press the DEADSTART switch but do not begin recovery until all remaining active machines display the message

MACHINE DOWN

at the respective system control points.

- If a level 3 recovery deadstart is not possible, or if you attempted a level 3 deadstart and were not successful, MREC must be run on all machines sharing disks with the down machine, followed by a level 0 deadstart on the down machine.
- If you are deadstarting the first machine (no machine is currently operating), you must use the PRESET CMRDECK entry (refer to the Installation Handbook for a description of PRESET).
- Once the MREC utility has been run for an inoperative machine, do not run any recovery deadstart (other than level 0 deadstart).

Refer to the NOS System Maintenance Reference Manual for more detailed information on multmainframe operation.

After the system is loaded, NOS monitors certain bits of the CYBER 170 Series status/control (S/C) register and the CYBER 70 Series interlock register to detect abnormal conditions and possible fatal errors. When one or more bits are set in the S/C register, the system automatically takes steps to prevent further damage to the system and attempts to preserve the system in a state as near as possible to that before the condition was detected.

POWER AND ENVIRONMENTAL FAILURE

Bit 36 of the S/C register and bit 0 of the interlock register indicate a main power supply failure. Bit 37 of the S/C register (no comparable interlock register bit exists) indicates an unusual, potentially damaging environmental condition. When one or more of the warning bits are set, from 2 seconds to 2 minutes of processing time remain to prepare the system for a power loss.

POWER FAILURE

If the main power source supplying the computer system is lost for more than one-half cycle (8.3 milliseconds for 60 Hz; 10.0 milliseconds for 50 Hz), the system automatically sets bit 36 of the S/C register (bit 0 of the interlock register on a CYBER 70 Series machine). The CPU and other equipment powered by 400 Hz remains available for processing approximately 2 seconds. However, all peripheral equipment powered directly from the main power supply will probably fail.

When the S/C register bit 36 (interlock register bit 0) is set, the system immediately assumes step mode (refer to STEP command, section 3).[†] The message

POWER FAILURE

appears at the system control point on the job status (B) display.

ABNORMAL ENVIRONMENTAL CONDITIONS

If the system detects an environmental condition which could lead to removal of power, it automatically sets bit 37 of the S/C register (no comparable interlock register bit exists). Bit 37 is set in any of the following situations.

- The main power source supplying the system has been lost for at least 100 milliseconds; power will probably not return to normal within the time required.
- An environmental condition (including dew point and chassis temperature warnings) is abnormal and approaching an emergency power shutdown.

- An environmental condition is about to cause execution of a controlled shutdown.
- A critical system device is down due to environmental conditions. This indication exists only if the system has monitoring provisions for the device.

If bit 37 is set but bit 36 is not, the system immediately initiates a system checkpoint. The message

SHUTDOWN IMMINENT.

appears at the system control point on the job status (B) display. This message and the contents of the S/C register are entered in the error log dayfile. When the checkpoint is complete, the system assumes step mode.

BITS 36 AND 37 SET

If a power failure and abnormal environmental condition is detected, it is possible to have bits 36 and 37 set at the same time. This could happen if an unusual environmental condition was found (bit 37 set) and was not remedied within the required time (approximately 2 minutes). Upon removal of power, a power failure (bit 36 set) would be detected. With bits 36 and 37 set, the system immediately assumes step mode. The message

POWER DOWN.

appears at the system control point on the job status (B) display. It is unlikely that recovery is possible; deadstart is necessary.

CLEARING ABNORMAL CONDITIONS

When bit 36 and/or bit 37 of the S/C register (bit 0 of the interlock register) have been set and cleared, the message

POWER/ENVIRONMENT NORMAL.

appears at the system control point on the job status (B) display. Ensure that all equipment is ready. With the approval of a site analyst, enter the following commands.

```
99.
UNSTEP.
99.
```

At this point, messages indicating the time of the power failure or power shutdown, the contents of the S/C register, and the time of the return to normal condition are entered in the error log. Processing may then be restarted.

[†]Actually, the system steps on monitor function 44 (drop PP). This allows current I/O requests, including device checkpoints in progress, to complete.

FATAL MAINFRAME ERRORS

A fatal mainframe error is a hardware error which will usually cause a serious system malfunction and disrupt current user job processing. Many of these errors are reported in the S/C registers of a CYBER 170 Series mainframe. The steps taken by the system upon detection of a fatal mainframe error depend on the type of error which was found.

Fatal errors can be divided into two groups, general errors and specific job errors. The system sets one or more bits in the S/C registers when an error is detected. Check these registers to determine the type of error.†

For a model 176 mainframe, the system sets S/C register bits when a general error is detected. There is no way to determine a specific job error. One or more of the following bits can be set.

S/C register bits set for general errors:

3/183,†† 4, 11/196,†† 14, 15, 16, 17, 18, 19, 20, 21, 22, or 23

For a model 171, 172, 173, 174, 175, 720, 730, 740, 750, or 760 mainframe, the following bits can be set for each error group.

S/C register bits set for general errors:

0, 1, 2, 3/183,††† 8, 9, 14, 15, 16, 17, 18, 19, 20, 21, 22, or 23

S/C register bits set for specific job errors:

3/183††† or 5

If the error detected is a specific job error, the system takes the following steps.

1. The system is checkpointed.

2. The job containing the error is aborted without exit processing or a dump.
3. The contents of the S/C register is entered in the error log.

The following action is the same regardless of the type of error detected. The system assumes step mode†††† and the message:

FATAL MAINFRAME ERROR

appears at the system control point on the job status (B) display.

OPERATOR ACTION FOR FATAL MAINFRAME ERRORS

When the system displays the fatal mainframe error message you should:

1. Perform a level 3 recovery deadstart to display the S/C register display. For each S/C register bit set, a descriptive message appears on the screen. The system clears each fatal error bit automatically when you activate the deadstart switch.
2. Determine the type of error (refer to the errors and corresponding bits listed previously).
3. If desired, reconfigure central memory. Refer to appendix J.
4. If the error is of a general type, perform a level 0 initial deadstart.

If the error is of a specific job type, perform a level 1 recovery deadstart. The system resumes operation from the point of malfunction. If the level 1 recovery deadstart fails, perform a level 0 initial deadstart.

† Some of these bits may not be active on your mainframe. Refer to the appropriate hardware reference manual for detailed information.

†† The system detected a fatal error only if both bits are set.

††† The system detected a fatal error only if both bits are set. The error is a specific job error if the system completed a checkpoint.

†††† Actually, the system steps on monitor function 44 (drop PP). This allows current I/O requests, including device checkpoints in progress to complete.

Because the method used to terminate system operations is dependent upon requirements of your site, the actual procedure for shutdown may differ among sites. The following procedure is an example and suggests guidelines for orderly termination of processing. Do not confuse this procedure with the shutdown procedures performed in preparation for a recovery deadstart (refer to Preparing for Recovery Deadstart in section 2).

1. Use the DSD job status (B) display to monitor control point activity.
2. If the time-sharing subsystem is active at control point 1, provide advance notice of shutdown time to active time-sharing users by entering the DSD command WARN. For example:

```
WARN,SYSTEM SHUTDOWN AT 1500,
PLEASE LOG-OFF.
```

If NAM is active at a control point, provide advance notice of shutdown time to active users by entering the n.CFO command. For example:

```
n.CFO.MS,ALL,SYSTEM SHUTDOWN AT
1500, PLEASE LOG-OFF.
```

n Control point number of NAM.

3. Prevent new time-sharing users from logging into the system by entering the following DSD command.

```
SERVICE,TX,NJ0.
```

The NJ parameter, which specifies the number of active lines allowed for time-sharing origin (TX) jobs, is set to zero (NJ0).

4. If the time-sharing subsystem is active at control point 1, examine the time-sharing status (T) display to determine if there are still active users. To send a message to an active user, enter the DIAL command. For example:

```
DIAL,15,SYSTEM CLOSED,CALL X492 IF
MORE TIME NEEDED.
```

This message is sent to terminal 15 following output data, if any.

When there are no longer active time-sharing users indicated on the T display, drop the time-sharing subsystem by typing:

```
1.IDLE.
```

5. Drop NAM if active at a control point by typing:

```
n.CFO.DISABLE,NE
```

n Control point number of NAM.

6. Drop TAF if active at a control point by typing:

```
n.IDLE.
```

n Control point number of TAF.

7. If MSS is active at a control point and if jobs that need files to be staged from MSS are to be aborted, type:

```
DISABLE,FILE STAGING.
```

Drop MSS by typing:

```
n.IDLE.
```

n Control point number of MSS.

MSS becomes idle after it has completed all stage requests currently in process. Examine the output drawer for any cartridges and save them for subsequent recovery processing (refer to the NOS System Maintenance Reference Manual).

8. Drop EXP (Export/Import subsystem) if it is currently assigned to a control point by typing:

```
n.IDLE.
```

n Control point number to which EXP is assigned.

If transmission to a remote batch terminal is terminated by dropping EXP, the file being transmitted is rewound and placed back in the output queue. All other files currently scheduled for transmission to remote batch terminals are returned to the output queue.

9. Drop BATCHIO by typing:

```
n.IDLE.
```

n Control point number of BATCHIO.

BATCHIO will drop after it completes processing of all active devices. Files currently being printed or punched, as well as cards currently being read, will complete. No new files will be printed or punched.

10. Prevent any new jobs in the input queue from being scheduled to a control point by dumping the input queue. This is accomplished through use of the QDUMP system utility (refer to the NOS System Maintenance Reference Manual). Doing this allows jobs currently scheduled to control points to run to completion. In addition, jobs in the rollout queue will be scheduled back to a control point and allowed to complete.
11. Monitor control point activity on the B display. Wait for all jobs to run to completion and then dump the output queues (print and punch queues). This is also accomplished through use of the QDUMP system utility (refer to the NOS System Maintenance Reference Manual).
12. If permanent files are to be dumped, bring up BATCHIO to print output reports by entering the following DSD command.

n.IO.

n Control point number you wish to assign to BATCHIO.

Refer to the description of the PFDUMP permanent file utility in the NOS System Maintenance Reference Manual for procedures to dump permanent files.

13. Drop BATCHIO again by typing:

n.IDLE.

n Control point number of BATCHIO.

14. Terminate dayfiles and retain as direct access permanent files. This is accomplished through use of the DFTERM system utility (refer to the NOS System Maintenance Reference Manual). This preserves dayfile information held in the central memory buffers.
15. If the system is not to be used after shutdown, proceed to step 16. However, if the system is to be used for reasons other than normal NOS processing, perform the following steps.

- a. Examine the mass storage status (E,M.) display to determine if status code C (checkpoint requested) is set for any mass storage device. Wait until the checkpoint operation has completed before proceeding (C status cleared).
 - b. Dismount the deadstart tape (if currently mounted), and activate the deadstart switch. The display screens should become blank indicating that the system hardware is idle. The system is now ready for other use.
 - c. Prevent subsequent users of the system from accessing mass storage permanent file devices. This is accomplished by dismounting disk packs (844 only) or making the devices unavailable (not ready) for system access.
16. If the system is not to be used after NOS operations have ended, enter the following DSD commands.

DISABLE,BATCHIO.

DISABLE,CDCS.

DISABLE,IAF.†

DISABLE,MAGNET.

DISABLE,NAM.

DISABLE,RBF.††

DISABLE,TAF.

DISABLE,MCS.

DISABLE,MSS.

MAINTENANCE.

Doing this disables all subsystems and allows maintenance tests to run while the system is not being used. It is recommended that the display screen intensity be turned down before leaving the system.

† Enter the command DISABLE,TELEX. if TELEX rather than IAF was enabled.

†† Enter the command DISABLE,EI200. if EI200 rather than RBF was enabled.

PP CONFIGURATION

H

Table H-1 shows the channels that are not connected to an active PP for the 6000 Series, CYBER 71, 72, 73, 74, and CYBER 170 Series for the various PP configurations. A dash in the table indicates a PP-system configuration that is not possible.

channels 0 through 13 (octal) and 20 through 33 (octal) are available. Channel 0 is connected to an inactive PP. The other channels shown in table H-1 are not connected to a PP.

For 7, 8, 9, and 10 PP configurations, channels 0 through 13 (octal) are available. For 14, 17, and 20 PP configurations,

TABLE H-1. CHANNELS THAT ARE NOT CONNECTED TO AN ACTIVE PP

System	PP Configuration						
	7	8	9	10	14	17	20
6200	0, 5, 6, 7, 12, 13	0, 6, 7, 12, 13	0, 7, 12, 13	0, 12, 13	0, 3, 6, 7, 12, 13, 23, 26, 27, 32, 33	0, 12, 13, 23, 26, 27, 32, 33	-
6400	0, 5, 6, 7, 12, 13	0, 6, 7, 12, 13	0, 7, 12, 13	0, 12, 13	0, 3, 6, 7, 12, 13, 23, 26, 27, 32, 33	0, 12, 13, 23, 26, 27, 32, 33	0, 12, 13, 32, 33
6500, 6600, 6700	-	-	-	0, 12, 13	0, 3, 6, 7, 12, 13, 23, 26, 27, 32, 33	0, 12, 13, 23, 26, 27, 32, 33	0, 12, 13, 32, 33
CYBER 71, 72, 73, 74	-	-	-	0, 12, 13	0, 3, 6, 7, 12, 13, 23, 26, 27, 32, 33	0, 12, 13, 23, 26, 27, 32, 33	0, 12, 13, 32, 33
CYBER 170 Series	-	-	-	0, 12, 13	0, 12, 13, 24, 25, 26, 27, 30, 31, 32, 33	0, 12, 13, 27, 30, 31, 32, 33	0, 12, 13, 32, 33

The normal procedure for terminating the network is to enter the NOP commands IDLE, NETWORK or DISABLE, NETWORK (refer to section 7). However, there may be times when a network program fails or the entire network fails. When this happens, there is a flashing tape request on the B display for a 7-track labeled tape to be used for network dumps.† You can assign the tape by using the ASSIGN command or select other dump options by setting sense switches 1 through 4. Your entry must be in the following format:

n.ONSWx

- n Control point number to which NAM is assigned.
- x Sense switch number.

Following are options available and the action you must take to implement them.

Print network dumps

Enter n.ONSW1. and terminate the tape request (by DROP command).

Copy network dumps to 7-track labeled tape and print them

Enter n.ONSW2. and assign a 7-track labeled tape.

Copy network dumps to 9-track labeled tape

Enter n.ONSW3. and terminate the tape request for a 7-track tape. The system reissues a tape request for a 9-track labeled tape. Assign a 9-track labeled tape.

Do not print network dumps

Enter n.ONSW4. The system sets the output file to ID 67B. The network dumps are not printed until a printer has this ID. This allows the use of the QDUMP utility to collect the network dumps on tape (refer to the System Maintenance Reference Manual). Sense switch 4 is effective only if sense switch 1 or 2 is also set.

If there are no 7-track tape units available (no MT device types in EST) when you enter n.ONSW2, the system issues a request for a 9-track labeled tape as if you entered n.ONSW3. If there are no 9-track tape units available (no NT device types in EST) when you enter n.ONSW3, the system prints network dumps as if you entered n.ONSW1.

Once set, the sense switches can be turned off again by entering n.OFFSWx. (n is the control point number of NAM and x is the sense switch number). Sense switch 1 has precedence over sense switches 2 and 3. The default is to

copy network dumps to a 7-track labeled tape but not to print them (no sense switch is turned on).

NOTE

The sense switches are off by default and should be turned on or off only when there is a flashing tape request on the B display after a network program fails or the entire network fails. If the sense switches are turned on or off at any other time, the results are unpredictable.

If a noncritical network program (NS, RBF, or TVF) fails, the sense switch settings affect only the failing program. If the entire network fails, the sense switch settings affect all network programs except IAF and TAF.

If an irrecoverable tape parity error occurs, the tape request is reissued and you can assign a new tape or use any of the dump options described previously.

If the terminal verification facility (TVF) or NS fails, the system automatically restarts them after they are dumped to tape or printed. However, if there is no GO statement in the NS input record, you must enter the following command to initiate NS.

n.CFO.GO.

- n Control point number of NAM.

Because TVF is started only when the network is initiated, do not disable TVF.

When the NPU or the network fails, the contents of the NPU are automatically dumped and reloaded. To prevent the NPU from being dumped, enter the following command after every load of the NPU.

DUMP,npu,OFF.

- npu Name assigned to NPU.

If the previous network had terminated normally, a tape request appears on the B display after the NPU is dumped to copy the dump to tape. Again, you can assign a tape or use any of the dump options described previously.

After a level 3 deadstart recovery, the network procedure files terminate without printing anything.

You can bring the network back up after it fails without waiting for all the network dumps to be copied to tape or printed. This can be done when the flashing tape request appears on the B display.

†These procedures for copying network dumps to tape do not apply to IAF or TAF.

For most systems there are two types of reconfiguration possible; software reconfiguration using CTI, and hardware reconfiguration using the deadstart panel switches on the mainframe. The type of problem that has occurred determines which reconfiguration, if any, is possible. For information on software reconfiguration refer to the *H* display in section 2. Hardware reconfiguration information is contained in this appendix.

When you have a hardware problem, you may want to change the system so that you can continue running. This can be done by reconfiguring the peripheral processors (PPs) and, on CYBER 170 Series computer systems, central memory. For most systems, you can turn PPs off or on (using CTI) and change the location of PP0 and other PPs. Refer to PP Reconfiguration which follows for more information. You can also decrease the amount of central memory, making a particular part of the memory inactive. Refer to CM Reconfiguration for CYBER 170 Series, later in this appendix, for more information.

PP RECONFIGURATION

The system associates a number with each PP. These numbers are displayed at the bottom of all DSD displays shown on the right screen and range from 0 to 11g and from 20g to 31g. For a given configuration, the system always associates the same number with each PP. This number is called the logical PP number.

Within the hardware, PPs are grouped for orderly processing of PP instructions. Each group is called a barrel and has 4, 7, or 10 PPs. Contact site personnel for more information on barrels.

For the standard configuration, set the barrel switch to the first barrel and the PP switches (when present) to the first PP within the first barrel. Normally, when the system is running, the deadstart panel is set to the standard PP configuration. When you reconfigure, the logical numbers for all PPs change. For example, on a 20-PP system if you reconfigure so that PP0 is the PP that was associated with 20g in the standard configuration, the shift shown in figure J-1 occurs.

Standard PP Configuration

First Barrel		Second Barrel	
0	0	20	20
1	1	21	21
2	2	22	22
3	3	23	23
4	4	24	24
5	5	25	25
6	6	26	26
7	7	27	27
10	10	30	30
11	11	31	31

Reconfiguration - PP0 is the PP that was PP20

First Barrel		Second Barrel	
0	20	20	0
1	21	21	1
2	22	22	2
3	23	23	3
4	24	24	4
5	25	25	5
6	26	26	6
7	27	27	7
10	30	30	10
11	31	31	11

The numbers on the left are the logical numbers associated with the PPs when you use the standard PP configuration. The numbers on the right are the actual numbers the system associates with each PP.

Figure J-1. Sample Reconfiguration

In the new configuration, the PP previously associated with the number 20_g is now PP0. To get the reconfigured logical PP number assignments, exchange the numbers on the right of the first barrel in the first diagram of figure J-1 with the numbers on the right of the second barrel. This exchange is shown in the second diagram of figure J-1.

TURNING OFF PPS

You cannot turn off the hardware for PPs. Using CTI, you can logically turn off PPs refer to the hardware reconfiguration (*H*) display in section 2 .

PP0, 1, 2, 3, and 10 must be on and functioning in order to deadstart. If one or more of these PPs are not functioning, you can reconfigure the PPs so that the system does not associate the bad PP with the logical PP numbers 0, 1, 2, 3, or 10_g. Then you can deadstart and turn off the bad PP. For example, on a 20-PP system under the standard PP configuration, if PP2 is not functioning you can reconfigure the PPs so that PP20 becomes PP0 (refer to figure J-2). The bad PP is now numbered 2_g. You can turn off PP22 and continue operating.

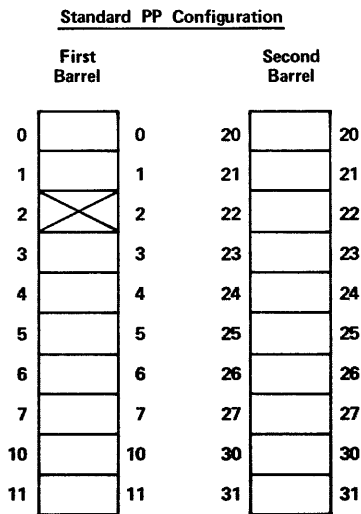

Reconfiguration – PP0 is the PP that was PP20

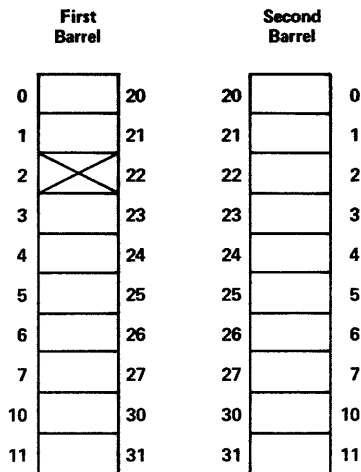

✕ marks the bad PP.
Standard PP numbers on the left.
Actual PP numbers on the right.

CYBER 70/6000 SERIES PP RECONFIGURATION

You can reconfigure the CYBER 70/6000 Series Computer Systems that have 14, 17, or 20 PPs (refer to table J-1). Use the deadstart panel switch labeled PPU-A to reconfigure PPs. For the standard PP configuration, the switch is in the up (0-11) position. Put the switch in the down (20-31) position to reconfigure the PPs. This shifts the logical PP numbers so that the system associates PP0 with the PP that is PP20 in the standard PP configuration (refer to figure J-1). Using the PPU-A switch is the only way you can reconfigure the CYBER 70/6000 Series computer systems.

CYBER 170 SERIES PP RECONFIGURATION

For a CYBER 170 Series computer system with 20 PPs, the most common way to reconfigure PPs is to use the deadstart panel switch labeled PPS-1 PPS-0 (refer to table J-1). The 1 on the switch indicates the second barrel; the 0 indicates the first barrel. For the standard PP configuration, the switch is in the down (PPS-0) position. To reconfigure, put it in the up (PPS-1) position. This shifts the logical PP numbers so that the system associates PP0 with the PP that is PP20 in the standard configuration (refer to figure J-1).

To reconfigure a CYBER 170 Series computer system with 10, 14, or 17 PPs, you must shift the logical PP numbers within barrel 0. You can do this using the PP MEMORY SELECT switches on the deadstart panel (refer to figure J-3).

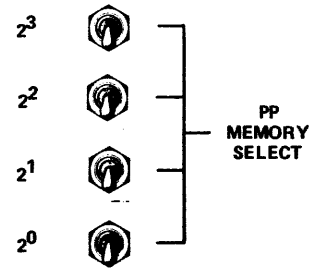
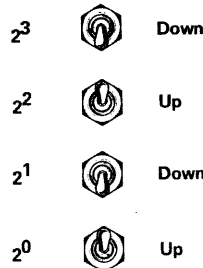

Figure J-3. PP MEMORY SELECT Switches

Choose the standard PP configuration number where you want to locate PP0. Set this number (using binary) on the PP MEMORY SELECT switches. For example, if you choose the number 5, you would set the switches as follows:



● Figure J-2. Sample Reconfiguration for Bad PP

TABLE J-1. DEADSTART PP RECONFIGURATION

The following information appears in each box within the table:			
<ol style="list-style-type: none"> 1. The possibility of reconfiguration - possible or not possible. 2. The name of the switch on the deadstart panel used for reconfiguration. 3. The shift of PP0 that occurs when you reconfigure using the barrel switch. (PP0→PP20) means the system assigns PP0 to the PP that was PP20 in the standard PP configuration.) 			
Number of PPs	CYBER Mainframes		
	6000	70	170 †
10	<ol style="list-style-type: none"> 1. Not possible 	<ol style="list-style-type: none"> 1. Not possible 	<ol style="list-style-type: none"> 1. Possible 2. PP MEMORY SELECT switch
14	<ol style="list-style-type: none"> 1. Possible 2. PPU-A switch 3. PP0→PP20 	<ol style="list-style-type: none"> 1. Possible 2. PPU-A switch 3. PP0→PP20 	<ol style="list-style-type: none"> 1. Possible 2. PP MEMORY SELECT switch
17	<ol style="list-style-type: none"> 1. Possible 2. PPU-A switch 3. PP0→PP20 	<ol style="list-style-type: none"> 1. Possible 2. PPU-A switch 3. PP0→PP20 	<ol style="list-style-type: none"> 1. Possible 2. PP MEMORY SELECT switch
20	<ol style="list-style-type: none"> 1. Possible 2. PPU-A switch 3. PP0→PP20 	<ol style="list-style-type: none"> 1. Possible 2. PPU-A switch 3. PP0→PP20 	<ol style="list-style-type: none"> 1. Possible 2. PPS-1 PPS-0 switch †† 3. PP0→PP20

†For information on how to set PP MEMORY SELECT switches, refer to CYBER 170 Series PP Reconfiguration later in this appendix.
††Reconfiguration of this configuration is also possible by using the PP MEMORY SELECT switch.

Standard PP Configuration for Barrel 0

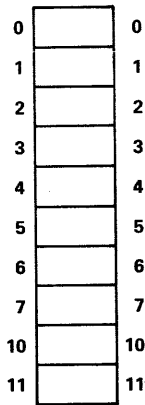

Standard PP Configuration

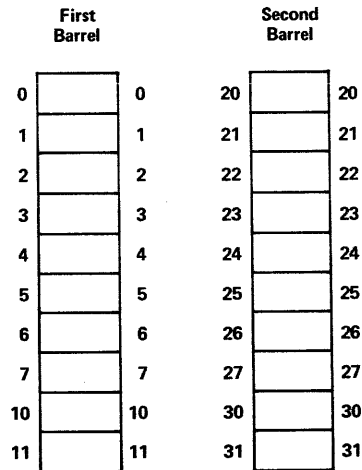

Reconfiguration for Barrel 0

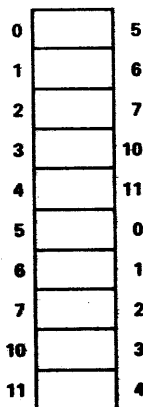

Standard numbers on the left.
Actual numbers on the right.

Figure J-4. Reconfiguration of Barrel 0 for CYBER 170 Series

This causes the actual numbers of the PPs in the first diagram to shift five positions downward, the bottom number shifting to the top at each step.

After reconfiguration, each PP in barrel 0 has a new logical number. You can set the PP MEMORY SELECT switches to a number from 0 (setting 0000) to 11g (setting 1001). If you set the switches to any other number, no reconfiguration takes place.

You can also reconfigure CYBER 170 Series computer systems that have 20 PPs by shifting logical numbers using the PP MEMORY SELECT switches. Set these switches as described in the previous paragraphs. On a 20-PP system when the PP MEMORY SELECT switches are set to 3, the shift shown in figure J-5 occurs.

Reconfiguration — PP0 is the PP that was PP3

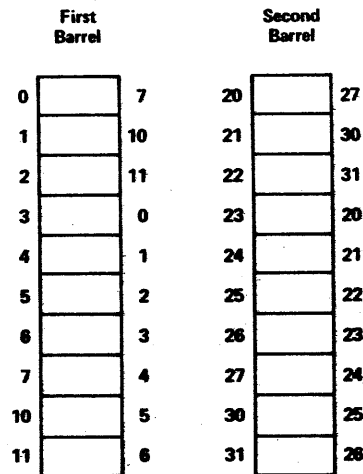

Standard PP numbers on the left.
Actual PP numbers on the right.

Figure J-5. Sample Reconfiguration Using the PP MEMORY SELECT Switches for CYBER 170 Series Only

CM RECONFIGURATION FOR CYBER 170 SERIES

This section is for the CYBER 170 Series computer systems only. CM hardware reconfiguration cannot be done on 6000 Series or CYBER 70 Series computer systems. For CM software reconfiguration, refer to the *H* display in section 2.

This documentation is valid for reconfiguring central memory down one step only. Any reconfiguration of more than one step down is not recommended.

When it is determined that central memory reconfiguration is desirable, you need to know the following information to reconfigure.

- The CYBER 170 model number.
- The normal total memory size.
- The quadrant number and CSU number (if applicable) of the defective section of memory (usually found in an S/C register error message at deadstart).

To reconfigure central memory, use the following procedure:

1. Locate the CM configuration switches on the mainframe.
2. Locate the correct table for your CPU model (refer to tables J-2 through J-5).
3. Select from that table the correct grouping by locating the normal size of central memory from the CM Before Reconfiguration column.
4. Locate the correct line within the grouping by selecting the quadrant number (and CSU number if applicable) associated with the defective section of memory.
5. Determine the switch number order for the CM configuration switches (refer to figures J-6 and J-7).
6. Compare the settings of the CM configuration switches on your mainframe to the settings shown in the Normal Setting Switch Number column of the line identified in step 4.
7. If the CM configuration switches are as shown in the Normal Setting Switch Number column, reset them to the setting shown in the Reconfiguration Setting Switch Number column and deadstart. If the CM configuration switches are not in the normal setting before the attempt to reconfigure, additional reconfiguration is not recommended.

TABLE J-2. CM RECONFIGURATION FOR CYBER 170 SERIES
MODELS 171, 172, 173, AND 174

CPU Model	CM Before Reconfiguration	Quadrant	CSU	Normal Setting†	Reconfiguration Setting†	CM After Reconfiguration	
				Switch Number	Switch Number		
				1 2 3 4 5 6 7	1 2 3 4 5 6 7		
171 through 174	262K	3	1	0 0 0 0 0 0 0	0 0 0 1 0 0 0	196K	
		2	1	0 0 0 0 0 0 0	0 0 0 1 0 0 1		
		1	1	0 0 0 0 0 0 0	0 0 0 1 0 1 0		
		0	1	0 0 0 0 0 0 0	0 0 0 1 0 1 1		
		3	0	0 0 0 0 0 0 0	0 0 0 1 1 0 0		
		2	0	0 0 0 0 0 0 0	0 0 0 1 1 0 1		
		1	0	0 0 0 0 0 0 0	0 0 0 1 1 1 0		
		0	0	0 0 0 0 0 0 0	0 0 0 1 1 1 1		
	196K	1	1	0 0 0 1 0 0 0	1 0 0 0 0 1 0	131K	
		0	1	0 0 0 1 0 0 0	1 0 0 0 0 1 1		
		3	0	0 0 0 1 0 0 0	1 0 0 0 1 0 0		
		2	0	0 0 0 1 0 0 0	1 0 0 0 1 0 1		
		1	0	0 0 0 1 0 0 0	1 0 0 0 1 1 0		
	0	0	0 0 0 1 0 0 0	1 0 0 0 1 1 1			
	131K	3	0	1 0 0 0 0 0 0	1 0 0 1 1 0 0	98K	
		2	0	1 0 0 0 0 0 0	1 0 0 1 1 0 1		
		1	0	1 0 0 0 0 0 0	1 0 0 1 1 1 0		
		0	0	1 0 0 0 0 0 0	1 0 0 1 1 1 1		
	98K	2	0	1 0 0 1 0 0 0	1 1 0 0 1 0 1	65K	
		1	0	1 0 0 1 0 0 0	1 1 0 0 1 1 0		
		0	0	1 0 0 1 0 0 0	1 1 0 0 1 1 1		
	65K	1	0	1 1 0 0 0 0 0	1 1 1 0 1 1 0	49K	
		0	0	1 1 0 0 0 0 0	1 1 1 0 1 1 1		
	49K	1	0	1 1 0 1 0 0 0	1 1 1 0 1 1 0	32K	
		0	0	1 1 0 1 0 0 0	1 1 1 0 1 1 1		
	32K		No reconfiguration possible				

† 1 means up, 0 means down.

TABLE J-3. CM RECONFIGURATION FOR CYBER 170 SERIES MODEL 175

CPU Model	CM Before Reconfiguration	Quadrant	CSU	Normal Setting† Switch Number				Reconfiguration Setting† Switch Number				CM After Reconfiguration
				S ₀	S ₁	S ₂	S ₃	S ₀	S ₁	S ₂	S ₃	
175	262K	3	1	1	1	1	1	1	1	1	0	196K
		2	1	1	1	1	1	1	1	0	1	
		1	1	1	1	1	1	0	1	1	1	
		0	1	1	1	1	1	0	1	1	1	
		3	0	1	1	1	1	1	1	1	0	
		2	0	1	1	1	1	1	1	0	1	
		1	0	1	1	1	1	1	0	1	1	
	0	0	1	1	1	1	1	0	1	1	1	
	196K	2	1	1	1	1	0	1	1	0	0	131K
		1	1	1	1	1	0	1	0	1	0	
		0	1	1	1	1	0	0	1	1	0	
		2	0	1	1	1	0	1	1	0	0	
		1	0	1	1	1	0	1	0	1	0	
	0	0	1	1	1	0	0	0	1	1	0	
	131K	1	1	1	1	0	0	1	0	0	0	98K
		0	1	1	1	0	0	0	1	0	0	
		1	0	1	1	0	0	1	0	0	0	
		0	0	1	1	0	0	0	1	0	0	
	98K	1	1	1	1	0	0	1	0	0	0	65K
		0	1	1	1	0	0	Not possible				
1		0	1	1	0	0	1	0	0	0		
0		0	1	1	0	0	Not possible					
65K	No reconfiguration possible											

†1 means up, 0 means down.

TABLE J-4. CM RECONFIGURATION FOR CYBER 170 SERIES MODELS 176, 740, 750, AND 760

CPU Model	CM Before Reconfiguration	Quadrant	Normal Setting† Switch Number				Reconfiguration Setting† Switch Number				CM After Reconfiguration
			S ₀	S ₁	S ₂	S ₃	S ₀	S ₁	S ₂	S ₃	
176, 740, 750, 760	262K	3	1	1	1	1	1	1	1	0	196K
		2	1	1	1	1	1	1	0	1	
		1	1	1	1	1	1	1	0	1	
	0	1	1	1	1	1	0	1	1	1	
	196K	2	1	1	1	0	1	1	0	0	131K
		1	1	1	1	0	1	0	1	0	
		0	1	1	1	0	0	1	1	0	
	131K	1	1	1	0	0	1	0	0	0	65K
		0	1	1	0	0	0	1	0	0	

†1 means up, 0 means down.

TABLE J-5. CM RECONFIGURATION FOR CYBER 170 SERIES MODELS 720 AND 730

CPU Model	CM Before Reconfiguration	Quadrant	Normal Setting†					Reconfiguration Setting†					CM After Reconfiguration
			Switch Number					Switch Number					
			1	2	3	4	5	1	2	3	4	5	
720 and 730	262K	3	0	0	0	0	0	0	0	0	1	0	196K
		2	0	0	0	0	0	0	0	1	0	0	
		1	0	0	0	0	0	0	1	0	0	0	
		0	0	0	0	0	0	1	0	0	0	0	
196K	131K	2	0	0	0	1	0	0	0	1	1	0	131K
		1	0	0	0	1	0	0	1	0	1	0	
		0	0	0	0	1	0	1	0	0	1	0	
131K	65K	1	0	0	1	1	0	0	1	1	1	0	65K
		0	0	0	1	1	0	1	0	1	1	0	
98K	65K	1	0	0	1	1	1	0	0	1	1	1	65K
		0	No reconfiguration possible										

† 1 means up, 0 means down.

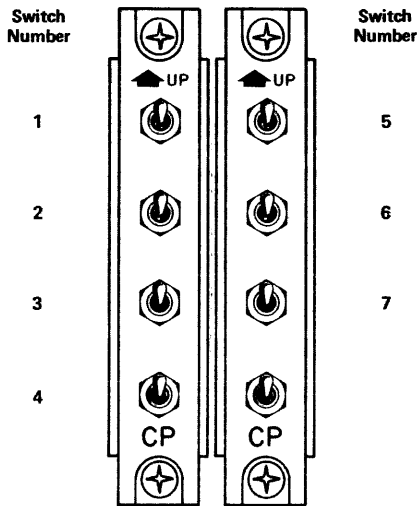

Figure J-6. Switch Numbering Scheme for CYBER 170 Series Models 171, 172, 173, 174, 720, and 730

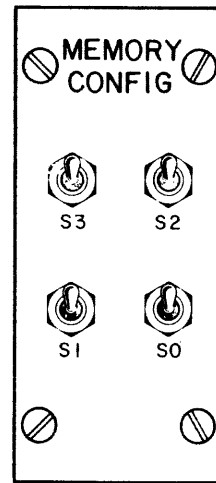

Figure J-7. Switch Numbering Scheme for CYBER 170 Series Models 175, 176, 740, 750, and 760

INDEX

- A command 4-2
- A display (DIS) 5-2
- A display, dayfile (DSD) 4-4,5,6
- A display, resetting 4-2
- A register set command 5-10
- A,ACCOUNT command 4-2
- Abnormal environmental conditions 3-26,27; F-1
- ABORT. 6-5
- Absolute vs relative settings 5-7
- ACCOUNT command 3-2; 4-3
- Account dayfile display 4-5
- ACCOUNT, disable/enable processing 3-23
- Account validation, disable/enable 3-24
- ACN command 3-29
- Activate channel 3-29
- Add unit on-line 6-1
- Advancing the left screen display 1-3,4; 5-7,8
- A,ERROR LOG command 2-29; 4-2
- Aging by priority, enable/disable 3-23
- Allocation of temporary files 3-13
- Alternating display control 1-3; 5-1,7,8
- Alternate deadstart 2-22
- ASSIGN command 3-10
- Assigning
 - Equipment to control point 3-10
 - Identifiers 3-2
 - Job files to mass storage 3-8
 - VSN to tape 3-10,11
- Assigning identifier to
 - Card punch 3-2
 - Card reader 3-2
 - Line printer 3-2
 - Queue file 3-2
- Asterisk to alternate display 1-3; 5-1,7
- AUTO command 2-28; 3-22
- AUTO MODE selection key 5-7
- AUTOLOAD entry 2-26
- Automatic
 - Assignment of subsystems 2-29; 3-19
 - Control statement processing 5-1,10
 - Label checking, mass storage 2-14; 3-14,23
 - Printer carriage control suppression 3-19
 - Rollout of jobs, disable/enable 3-23
 - System deadstart 2-14
 - Tape assignment 3-10,11

- B display, job status (DIS) 5-1,3
- B display, job status (DSD) 4-1,7,8
- B register set command 5-8
- Backspace on print file 3-18
- Backspace (BKSP) key 1-4; 5-8
- Batch job, queue priorities 3-4
- Batch jobs, service limits 3-4,5
- BATCHIO commands 3-18
- BATCHIO (I) display 3-18; 4-24,25
- BATCHIO operations
 - End operation 3-18
 - Repeat operation 3-19
 - Rerun job 3-19
 - Suppress AUTO carriage control 3-19
- BATCHIO subsystem
 - Activating 3-20,23
 - Control point 2-29
 - Deactivating 3-23
- Binary maintenance log dayfile 3-1

- BKP command 5-9
- BKPA command 5-9
- BKSP command 3-18
- BKSP (backspace) key 1-4; 5-8
- BKSPF command 3-18
- BKSPRU command 3-18
- Blank keys, use of 1-4; 5-7
- Blank screen selection 5-1
- BLITZ command 3-27
- Breakpoint command 5-9
- Breakpoint keys 5-7
- Buffer display (DIS) 5-1

- C display (DIS) 5-1
- C display (DSD) 4-1,8,9,10
- CALL command 5-9
- Card punch operations 4-13; D-3
- Card reader coldstart 2-2,4,5
- Card reader operation, 405 D-1
- Cards, loading D-1
- Carriage return (CR) key 1-4; 5-7,8
- CCP command 7-1
- CDC command 3-19
- CDCS subsystem 3-19,23
- CEJ/MEJ option 2-3,4,18,19
- Central exchange jump/monitor exchange jump 2-3, 4,18,19
- Central memory buffer display 5-1
- Central memory, change contents 3-27; 5-10,11
- Central memory (CM)
 - Display 5-4
 - Field length 5-9
 - Reconfiguration J-4
 - Size 2-18,19
 - Table build 2-13
 - Time slice 3-5,6
- Central processor request 5-11
- Central processing unit (CPU) 2-17
- Central programmable (K and L) displays 4-24
- CFO command 3-9; 7-1
- Chain removable devices (packs) 2-39; 3-14
- Channel
 - Activate 3-13,29
 - Deactivate 3-13,29
 - Drop 3-29
 - Master clear 3-29
 - No active PP H-1
 - Output function code to 3-29
- Channel control commands 3-28
- Character set A-1
- CHECK POINT SYSTEM command 2-14,36,37; 3-24
- Check status/control register 2-15,16
- Checking labels, mass storage 2-14; 3-14
- Checkpoint job 3-3,24
- CKP command 3-3
- CLEAR 6-5
- Clearing
 - Auto control statement processing 5-8,9,10
 - Current keyboard entry 1-1; 5-8
 - Current VSN 3-12
 - Global unload 3-12
 - Local unload 3-12
 - MSAL entry 3-8,13
 - Pause bit for job 3-10
 - Step mode 3-26,27

- Warning message 3-10
- Cluster address 7-5
- CMAP switch setting 2-3
- CMRDECK
 - Flaw entries 6-7
 - Modification 2-25
 - Selection 2-10,11,19
- CMRINST 2-25
- Coldstart
 - Controlware 2-1,2,3
 - Deadstart panel settings 2-3,4,5,6
 - Definition C-1
 - Disk controller 2-2
 - From card reader 2-2,5
 - From disk unit 2-3,6
 - From tape unit 2-2,5
 - Procedures 2-1
 - Tape Controller 2-1
- Commands, DIS 5-8,9,10,11
- Commands, DSD
 - BATCHIO Equipment 3-18
 - Channel control 3-28
 - Dayfile 3-1; 4-2,3
 - Entry of 1-1,2
 - Job processing control 3-2
 - Memory entry 3-27
 - Peripheral equipment control 3-10
 - Restricted entry of 3-25,26,27
 - Subsystem control 3-19
 - System control 3-22
 - Transaction subsystem 3-29
- COMMENT command 3-9
- Common Testing and Initialization (CTI)
 - CTI displays 2-10,14
 - Definition C-1
 - Loading CTI 2-6
 - Procedure 2-1
- Communications area display 4-30,31
- Communications supervisor 7-1
- Configuration of system 1-1
- Configuration, mass storage display 4-13,15
- Configuration, PP H-1
- Configure removable devices 3-14
- Console
 - Keyboard illustration 1-2
 - Keyboard locking 3-25
 - Keyboard unlocking 3-25
 - Messages B-1
 - Operations (DIS) 5-7
 - Operations (DSD) 3-1
 - Screen control D-10
- CONTINUE command 3-18
- Control
 - Channel 3-28
 - Job processing 3-2
 - Keys (console) 1-3,4; 5-7
 - Peripheral equipment 3-10
 - Subsystem 3-19
 - System 3-22
- Control point
 - Assigning equipment to 3-10
 - Assigning programs/utilities 3-25
 - Assignment for subsystems 2-28; 3-19
 - Automatic assignment 2-28
 - Clear pause bit 3-10
 - Dropping 3-9,22,27
 - File name table 5-1
 - Idling 3-24
 - Setting sense switches 3-10,19,20,21,22
 - Status (J) display 4-24,26
- Control statement display 5-2
- Control statement entry command 5-1,9
- Control word 4-35

- Controller reservations 8-4
- Controlware 2-1,2,3; C-1
- CP command 3-2
- CPU
 - INPUT MODE 5-9
 - Job switch interval 3-7
 - Priority 3-3,4
 - Program exit mode 5-9
 - Recall period 3-7
 - Status 2-17
 - Time slice 3-4
 - Turning off or on 2-19
- CR (carriage return) key, use of 1-4; 2-15; 5-7,8
- CR command 3-2
- Create multispindle device (pack) 3-14,17
- CS 7-1; C-1
- CTI
 - Displays 2-10,14
 - Loading 2-6
 - Procedure 2-1
- CYBERLOG displays 2-29

- D display (DIS) 5-1
- D display (DSD) 4-1,8,9
- Data storage display (DIS) 5-1,4
- DATE command 3-26
- Date entry 2-28
- DAYFILE command 3-2
- Dayfile commands 3-1; 4-2,3
- Dayfile, comments entered 3-9
- Dayfile (A) displays 4-2; 5-1,2
- Dayfile messages 4-2,3
- DCH command 3-29
- DCN command 3-29
- DCP command 5-9
- DDP v; 4-13,14
- DDS 2-1,8
- Deactivate channel 3-29
- Deadstart
 - Alternate 2-22
 - Automatic 2-14
 - CMRDECK
 - Modification 2-25
 - Selection 2-8,12
 - Coldstart 2-1
 - CTI
 - Loading 2-6
 - Options 2-14
 - Procedure 2-1
 - Definition C-1
 - DDS
 - Display 2-18
 - Loading 2-7
 - Equipment 2-3,4
 - Error processing 2-37
 - Express deadstart dump (EDD) 2-23
 - File 2-1
 - Hardware reconfiguration (*H*) display 2-18
 - Mass storage 2-1,8
 - Initial options (*A*) display 2-7,14
 - Initialization 2-26
 - IPRDECK modification 2-27
 - Keyboard entries 2-14
 - For H display 2-19,20
 - For P display 2-21
 - Level 2-12,35,36,37
 - Maintenance 2-14
 - Memory Check 2-15
 - Offline maintenance (*M*) display 2-15
 - Operator intervention (*O*) display 2-17
 - Panel parameters (*P*) display 2-18

Panel settings 2-4,5,6,11
 Parameters 2-12
 Coldstart 2-4
 Warmstart 2-11
 PP reconfiguration J-3
 Procedure choices 2-14
 Recovery 2-35
 Sequencing 2-27; C-1
 System procedures 2-14
 Tape 2-1
 Turning CPU off or on 2-19
 Using 66x tape unit 2-1,2,4,5,12
 Using 67x tape unit 2-1,12
 Using 844 or 885 disk unit 2-2,5
 Utilities (*U*) display 2-7,22
 Warmstart 2-8
 Word 13 2-12
 Deadstart Diagnostic Sequencer (DDS) 2-17
 Loading DDS 2-7
 D display 2-17
 Deadstart error processing 2-37
 DEADSTART PROGRAM switches 2-3
 Deadstart sequencing 2-28
 DEBUG command 3-26
 Decrementing the left screen display 1-3; 5-7
 DELAY command 3-7
 Delay parameters, changing 3-7
 Delete keyboard entry 1-4; 5-8
 Delete unit on-line 6-1
 Device assignment, automatic 3-10,11,12
 Device definition options 3-15,16
 Device recovery 2-38
 Diagnostics B-1
 DIAL command 3-10
 DIRECT CPU INPUT mode 5-10
 Directory (Z) display (DIS) 5-1,6
 Directory (Z) display (DSD) 4-40
 DIS
 Command 3-25; 5-1,8,9,10
 Displays 5-1
 Keys, special 5-7,8
 Operation 1-1; 5-1
 DISABLE command 3-22; 7-3
 Disk deadstart 2-2,3,5,6
 Disk operation D-9
 Dismounting removable packs, errors 3-12
 DISPLAY command 4-27
 Display
 Code character set A-1
 Console 1-1; D-10
 Key (right blank), use of 1-4; 5-7
 Screen headers (DIS) 5-2,3
 Screen headers (DSD) 4-2,4,7
 Selection (DIS) 5-8
 Selection (DSD) 4-1,2
 Distributive data path v; 4-13,14
 DOWN command 3-13
 Drop central processor 5-9
 DROP command 3-9; 5-9
 Dropping
 A channel 3-29
 A control point 3-9
 A subsystem 3-22,23,24; G-1
 All control points 3-27
 DSD
 Commands 3-1
 Displays 4-1
 Operation 1-1; 3-1
 Special characters 1-3,4
 DUMP command 7-3
 Dumping
 Account dayfile 3-2
 Deadstart 2-23
 Error log dayfile 2-29; 3-2
 Permanent files G-2
 System dayfile 3-2
 E displays (DSD)
 Configuration (E,C.) 4-13,15
 EST (E,A. or E,.) 4-13,14
 Mass storage status (E,M.) 4-16,18
 Preview (E,P.) 4-17,19
 Tape status (E,T.) 4-17,21
 E,T command 4-17
 ECS
 Accessible to user 3-24
 Change contents 3-28; 5-10,11
 Definition C-2
 Field length, maximum 3-6
 Field length, set 5-9
 Storage display (DIS) 5-1
 Storage display (DSD) 4-8
 EDD 2-12,23
 Edit CYBERLOG displays 2-34
 ELS command 5-9
 ENABLE command 3-22
 ENAi command 5-9
 ENBi command 5-9
 END command 3-18; 6-5,6
 End current BATCHIO operation 3-18
 End-of-operation shutdown G-1
 ENEM command 5-9
 ENFL command 5-9
 ENFLE command 5-9
 Engineering mode 3-26
 ENGR command 3-26
 ENID command 3-2
 ENP command 5-9
 ENPR command 3-3; 5-9
 ENQP command 3-3
 ENS command 5-9
 ENTER command 5-9
 Enter message in
 Dayfile 3-9
 Job's field length 3-9
 Entering data to K display 3-29
 ENTL command 3-3; 5-9
 Entry of commands (DIS) 5-9
 Entry of commands (DSD) 1-1,2,3
 Environmental failure 3-26,27; F-1
 ENXi command 5-9
 Equal sign to toggle memory mode 1-3; 4-9; 5-7
 Equipment
 Assign to control point 3-10
 Configuration 1-1; 2-1
 Status table (EST) 2-27; 4-13
 Status table display 4-14
 Erase (left blank) key, use of 1-4; 5-8
 ERR command 5-9
 ERRLOG command 3-2
 Error detection F-1
 Errors, fatal mainframe F-2
 Error flag set command 5-9
 Error log dayfile 2-29; 3-2; 4-2,3,6
 Error messages B-1
 Error processing during deadstart 2-37
 Error status bits 2-15
 EST 2-27
 EST display 4-14
 EVICT command 3-8
 Exchange package display 5-3
 Exit mode set command 5-9
 Export/Import Status (R) display 4-32,34
 EXP command 3-19

EXP (Export/Import) subsystem
 Activating 3-19,23
 Control point 2-29
 Deactivating 3-23; G-1
 Express deadstart dump (EDD) 2-12,23
 Extended core storage (ECS) v; C-2

F display (DIS) 5-1,4
 F display (DSD) 4-8,9,11
 Fast attach file 3-14; 4-22
 Fatal mainframe errors F-2
 FCN command 3-29
 Field length, maximum 3-5
 Field length set command 5-9
 File (N) display 4-27
 File Editor 5-10
 File, fast attach 3-14; 4-22
 File identifier 4-22
 File name table (FNT) 2-27
 File name table display (DIS) 5-1
 File name table display (DSD) 4-22,23
 FILE STAGING, disable/enable processing 3-23
 File type 4-22
 Files at control point 4-22,27; 5-1,2,3
 Flaw tracks on mass storage device 3-14,16,17; 6-7
 FLAW utility 6-7
 FNC command 3-29
 FNT 2-27
 FNT display 4-22,23; 5-1
 FORM command 3-2
 FORMAT command 3-13
 Format pending bit 3-13
 Format tape
 Loading D-4
 Tables A-6,7
 Forms code 3-2; 4-24; C-2
 Function code output to channel 3-29

G display (DIS) 5-1,4,5
 G display (DSD) 4-8,9
 Global unload 3-12; 4-16; 8-1; E-1
 GO command 2-27; 3-10; 5-9; 6-5,6; 7-1
 GRENADE entry 2-26

H display (DIS) 5-1
 H display, file name table (DSD) 4-22
 Hardware reconfiguration (*H*) display 2-19,20
 Header message, change 3-10
 Headers, display screen (DSD) 4-2,4,7
 HOLD command 5-9

I display (BATCHIO) 4-24,25
 IAF command 3-20
 IAF subsystem
 Activating 3-20,23
 Deactivating 3-23; G-1
 IAN command 3-29
 ID, assigning
 Card punch 3-2
 Card reader 3-2
 Line printer 3-2
 IDLE command 3-24; 7-3,5
 n.IDLE command 3-22
 IDLEFAMILY command 3-24
 IGNORE 6-5
 Inhibit auto printer carriage control 3-19

Inhibit job scheduling 3-24
 Initial deadstart 2-12,36
 Initial options (*A*) display 2-7,14
 Initialization level 2-25; 3-13,14
 INITIALIZE command 2-26; 3-13
 INITIALIZE entry 2-26
 INITIALIZE, flaw recovery 3-17; 6-7
 Initialize status 3-13
 Initializing mass storage devices 2-8,26; 3-13
 Initializing system 2-28
 Initiating job processing 2-28
 Input queue, purge 3-9
 Input to pseudo A register 3-29
 INSTALL entry 2-27
 Interlock register 2-15,16; F-1
 Interlock word 4-36
 Interval, delay
 CPU job switch 3-7
 CPU recall 3-7
 Job scheduler 3-7
 PP auto recall 3-7
 IO command 3-20
 IPD entry 2-27
 IPRDECK modification 2-27
 IPRINST instruction display 2-27
 ISF command 2-28

J display, control point status (DSD) 4-24,26
 Job

 Central memory field length 3-5
 Checkpoint 3-3
 Class 3-4
 ECS field length 3-6
 Files, assign to mass storage 3-8
 Loading a 3-2
 Maximum number 3-5
 Origin 3-4
 Processing control commands 3-2
 Queue (Q) display 4-32,33
 Queue, priorities of 3-4
 Rerunning a 3-4
 Rolling in a 3-3
 Rolling out a 3-3
 Scheduler interval 3-7
 Scheduling a 3-3
 Status display 4-7,8; 5-1,3
 Switch, CPU 3-7
 Time limit 3-3; 5-9

K command 3-25
 K display, central programmable (DSD) 4-24
 K display for
 FLAW utility 6-8,9
 INITIALIZE command 3-15
 RBF utility 3-34
 MREC command 8-1
 REDEFINE command 6-2
 Keyboard, console
 Entries 1-2,3,4; 2-14
 Entries, clearing 1-4; 5-8
 Entry of commands 1-1; 5-7,8,9,10
 Illustration 1-2
 Locking 3-25
 Messages 1-2; 5-8
 Unlocking 3-25
 KILL command 3-9

L command 3-25

L display, central programmable display (DSD) 4-24
 Label checking, mass storage 2-14,35; 3-14
 Label validation 2-14,35
 Labeled tape, automatic assignment 3-10,11,12
 LCF command 7-1
 LDC command 3-29
 Left blank (erase) key 1-4; 5-8
 Left parenthesis key, use of 1-3; 5-7
 Levels of system deadstart
 Level 0 (initial) 2-13,37
 Level 1 recovery 2-13,36
 Level 2 recovery 2-13,37
 Level 3 recovery 2-14,36
 Limit, time 3-3; 5-9
 Limits, service 3-4
 Line printer operation, 580 D-3
 Link removable packs 3-14
 LOAD command 3-2
 Load Deadstart Diagnostic Sequencer 2-1,7
 Load pseudo A register 3-29
 Loading a job 3-2
 Loading paper, 580 printer D-4
 Loading tape D-7,8
 Local batch jobs
 Queue priorities 3-4
 Service limits 3-4
 Local configuration file 7-1
 Local operator (LOP) 7-1; C-2
 Local operator commands 7-1,4
 Local unload 3-12; 4-16
 LOCK command 3-25
 Logging of DSD commands 3-1,26,27
 Logically turn equipment off 3-13
 Logically turn equipment on 3-13
 Login, preventing G-1
 Loss of power 3-26,27; F-1
 LP command 3-2
 LR command 3-2
 LS command 3-2
 LT command 3-2

M command 5-9
 M display (DIS) 5-1
 M display (DSD) 4-8,12
 Machine identification 8-1,2
 Machine recovery utility (MREC) 2-36,42; 8-1
 MAGNET command 3-20
 MAGNET subsystem
 Activating 3-20,23
 Control point 2-29
 Dropping 3-23
 Magnetic tape controller 2-1,2,4
 Magnetic tape, loading D-8
 Magnetic tape status (E,T.) display 4-17,21
 Magnetic tape unit operation D-7
 Magnetic tape units
 667/669 D-6
 677/679 D-7
 Magnetic tape, unloading 3-12; D-9
 Mainframe errors F-2
 Mainframe Reconfiguration J-1
 MAINTENANCE command 2-28; 3-22
 Maintenance deadstart 2-13
 Managed table pointer 5-7
 Mask bits 3-17
 Mass storage configuration (E,C.) display 4-13,15
 Mass storage device initialization
 During deadstart 2-26
 During normal operation 3-13
 Mass storage device operation, 844 disk D-9
 Mass storage device recovery 2-38

Mass storage status (E,M.) display 4-16,18
 Mass storage subsystem refer to MSS
 Mass storage validation 2-35; 3-13,23
 Mass storage utilities 6-1
 Master clear channel 3-29
 Maximum field length 3-5
 Maximum number of permanent files 3-6
 Maximum number of time-sharing origin jobs 3-5
 Maximum size (PRUs) of
 All indirect access files 3-6
 Individual direct access files 3-6,7
 Individual indirect access file 3-6
 MCH command 3-29
 MCS command 3-20
 MCS subsystem 3-20,23
 Memory confidence test 2-15
 Memory check displays 2-16
 Memory displays (DIS) 5-1,4,5,10
 Memory displays (DSD) 4-8 through 4-12
 Memory entry commands 3-1,27; 5-10,11
 MESSAGE command 3-10
 Messages, operator B-1
 Messages, operator to terminal user 3-10
 Minus (-) key, use of 1-3; 5-7
 MNPS, released value of 3-3
 Mode, DEBUG 3-26
 Mode, step 3-26,27
 MODE switch setting 2-3
 Modifying system 3-26
 Monitor function step mode 3-26
 Monitor functions (Y) display 4-39; 5-1
 Monitoring of deadstart 2-14
 MOUNT command 3-12
 Mounting multispindle packs 3-14
 MREC 2-36,42; 8-1
 MS VALIDATION option 2-35; 3-23
 MSAL command 3-8,13
 MSF operation D-11
 MSG command 7-5
 MSS command 3-20
 MSS, disable/enable processing 3-23
 MSS MASTER, disable/enable processing 3-23
 MSS subsystem
 Activating 3-20,23
 Control point 2-29
 Dropping 3-23
 K display 3-33
 Multimainframe considerations 2-36,42; 8-1; E-1
 Multispindle devices (packs)
 Configuring 3-14,16; 6-1
 Definition C-2
 Mounting 3-13
 Multiterminal jobs
 Queue priorities 3-4
 Service limits 3-4
 MXPS, released value of 3-3

N command 5-10
 N display
 DIS 5-1
 File displays 4-27
 NAM command 3-20,23
 NAM initialization commands 7-1
 NCF command 7-1
 Network
 Definition C-2
 Element status codes 7-2
 Idle 7-3
 Terminate 7-3
 Network access method 3-20,23; 7-1
 Network configuration file 7-1
 Network messages B-1

Network operator (NOP) 7-1,2; C-2
 Network operator commands 7-2,3,4
 Network supervisor 3-4; 7-1
 Network validation facility 7-1
 NEXT command 2-8,27; 6-5
 NEXT control point 2-29
 Next statement command 5-10
 NPU 7-1
 NS 7-1; C-3
 Number of permanent files, maximum 3-6
 Number of time-sharing jobs, maximum 3-5
 NVF 7-1

O displays (DSD)

Subcontrol point status (O,SU.) 4-30
 Task library directories (O,TA.) 4-27,28
 Transaction terminal status (O,TR.) 4-27,29
 OAN command 3-29
 OFF command 3-1,13
 Offline maintenance (*M*) display 2-15
 OFFSW command 3-10; 5-10
 ON command 3-1,13
 On-line
 Reconfiguration 3-13; 6-1
 Track reservation 6-7
 ONSW command 3-10; 5-10
 Operation under DIS 5-1
 Operation under DSD 3-1
 Operator intervention (*O*) display 2-17
 Operator messages B-1
 Options display deadstart 2-7,15
 Original priority 3-4
 Output contents of pseudo A register 3-29
 Output function code to channel 3-29
 Output queue, purge 3-9
 Output zero function code 3-29
 OVERLAY command 7-3
 Overlay processing, syntax (disable/enable) 3-27
 OVERRIDE command 3-9
 O26 command 5-10

P display 4-30,31

P register set command 5-8
 Panel parameters (*P*) display 2-18,20
 Paper loading, 580 printer D-4
 Parenthesis (left/right) keys, use of 1-3; 5-7
 Pause bit, clear 3-10
 Period to initiate automatic processing 5-7,10
 Peripheral equipment
 Control commands 3-10
 Monitoring displays 3-12; 4-13,16,17,20
 Operation D-1
 System configuration 1-1
 Peripheral processor units (PPUs) 1-1; 2-15,16
 Permanent files
 Definition C-3
 Dumping G-2
 Maximum number 3-6
 Maximum size (PRUs) 3-6
 PF VALIDATION option 2-35; 3-23
 PFC initialization D-5
 Plus (+) key, use of 1-3; 5-7
 Power failure 3-25,26,27; F-1
 PP call commands 5-11
 PP communications area (P) display 4-30,31
 PP 1-1; C-3
 PP auto recall interval 3-7
 PP reconfiguration J-1,2,3
 PP register contents 4-30
 Preserved file verification 3-23

PRESET command 2-37; E-1
 Preview display, resource mounting 4-17,19
 PRESENTATION CONTROL switch 1-1
 Print files
 Dumping 3-2
 Purging 3-9
 Printer carriage control, suppress 3-19
 Priority aging (enable/disable) 3-23
 Priority, CPU 3-4
 Priority, queue 3-4
 Priority set command 5-9
 Procedure to initialize mass storage device
 2-26; 3-13
 Program entry command 5-9
 Program exit mode 5-9
 Program storage (G) display 5-1
 Programmable format control D-5
 PRUs maximum number for
 All indirect access files 3-6
 Individual direct access files 3-6
 Individual indirect access file 3-6
 Pseudo A register
 Input to 3-29
 Load 3-29
 Output from 3-29
 Punch queue, purge 3-9
 PURGE command 3-8
 PURGEALL command 3-9

Q display, job queues 4-32,33

QPROTECT option 2-35
 QUEUE command 3-4
 Queue display 4-32,33
 Queue files purging 3-8,9
 Queue priority 3-4; 4-35
 Queue type 3-4
 Quick hold key 5-7

R display, export/import status 4-32

RBF command 3-19
 RBF K display 3-34
 RCP command 5-10
 RCS command 5-7,10
 Read next control statement 5-10
 Read next statement and stop 5-10
 Recable unit on-line 6-1
 RECHECK 6-4
 Reconfiguration, on-line 6-1
 Reconfiguration, central memory J-4
 Reconfiguration commands 2-19; 6-5
 Reconfiguration, mainframe J-1
 Reconfiguration parameters 2-19; 6-4
 Reconfiguration, PP J-1,2,3
 Reconfigure removable devices 3-14; 6-1
 Recovery, deadstart 2-14,35
 Recovery, mass storage 2-13,14,38
 Recovery state, TELEX 3-21
 REDEFINE command 6-2
 Reel installation D-8
 Reflective markers D-9
 RELOAD command 7-3
 Reenter job in queue 3-3,4
 Release equipment on channel 3-29
 Release reservation of channel 3-29
 Remote batch facility 3-20,23
 Remote batch jobs
 Queue priorities 3-4
 Service limits 3-4
 Remote NPU initialization D-10
 Removable devices, configuring 3-14; 6-1

- Removable mass storage, unloading 3-12
- Removable packs 3-23
- Remove device from system, logically 3-12
- REPEAT command 3-19
- Repeat current BATCHIO operation 3-19
- REPEAT ENTRY mode 1-4; 5-7,8
- Replace unit on-line 6-1
- REQUEST tape unit 3-10,11
- RERUN command 3-4,19; 6-5
- Reservations, MREC unit and controller 8-4
- Reserve (flaw) tracks on mass storage device 3-14,15; 6-7
- RESET 6-5
- Resetting the A display 4-2
- Resource mounting preview (E,P) display 4-17,19
- Restart program command 3-4,19
- Restricted command entry 3-25
- Resume printing 3-18
- Resume processing after pause 3-10
- Ribbon replacement D-5
- Right blank (display) key, use of 1-4; 5-7
- Right parenthesis key, use of 1-3; 5-7
- Right screen display valid (DIS) 5-2,8
- RNS command 5-10
- Rolled-out file status 4-22,32
- ROLLIN command 3-3
- Rollout, automatic (disable/enable) 3-23
- ROLLOUT command 3-3; 5-10
- Rollout queue, purge 3-9
- RSS command 5-10
- RTK flaw entry 6-7,8

- S display, system control information 4-35,37
- S/C register 2-15; F-1
- SCRATCH command 3-11
- Scratch tapes, assigning 3-11
- SCS command 5-10
- SECEDED errors 2-15; F-1
- Secondary USER cards 3-24
- Secure system memory 3-3
- Sector C-3
- Sense switches
 - Turn off 3-10; 5-10
 - Turn on 3-10; 5-10
- Sense switches for BATCHIO 3-20
- Sense switches for EXPORT/IMPORT 3-19
- Sense switches for IAF 3-20,21
- Sense switches for time-sharing subsystem 3-21
- Sense switches for transaction subsystem 3-22
- SERVICE command 3-4; G-1
- Service limits 3-4; 4-35
- Service limits in IPRDECK 3-7
- SET command 1-4; 4-2; 5-8
- Set register command 5-9
- Setting, deadstart panel 2-3
- Setting debug mode 3-26
- Setting, step mode 3-26,27
- Sequencing, deadstart 2-28
- Shutdown imminent F-1
- Shutdown procedures G-1
- Single bit errors 2-15
- Single error correction/double error detection 2-15
- Size, maximum PRUs for
 - All indirect access files 3-6
 - Individual direct access files 3-6,7
 - Individual indirect access file 3-6
- SKIP command 3-19
- Skip forward on print file 3-19
- SKIPF command 3-19
- Slash (virgule) key, use of 1-4; 5-7
- Special characters 1-3,4; 5-7

- Status
 - Codes 4-16,22
 - Console/system, modification 4-36
 - Control point 4-24
 - CPU 4-8
 - Equipment, 4-13 through 4-21
 - Export/Import 4-32
 - File 4-22
 - Status codes for network elements 7-2
 - Ring, magnetic tape 4-17
 - Rolled-out file 4-22,32
 - Tape unit 4-20
 - Time-sharing terminal 4-36
- Status codes for network elements 7-2
- STATUS command 7-3,4,5
- Status/control register 2-15; F-1
- STEP command 3-26
- Step mode 3-26; C-3
- STK flaw entry 6-6
- STOP command 3-19,22
- Stop printing 3-19
- Storage (C,D,F,G,M) displays 4-8 through 4-12
- Subcontrol point status (O,SU.) display 4-30
- Subsystem, assignment to control point 2-27; 3-19
- Subsystem control commands 3-19
- Subsystem, disable/enable 3-22,23,24
- Subsystem idling 3-22
- Subsystems available
 - BATCHIO 3-20
 - CDC 3-19
 - EXP (Export/Import) 3-19
 - IAF 3-20
 - MAGNET 3-20
 - MCS 3-20
 - NAM 3-20
 - RBF 3-20
 - Time-sharing 3-21
 - Transaction 3-22
- Suppress auto printer carriage control 3-19
- SUPPRESS command 3-19
- SUSPEND 6-5,6
- Switch unit on-line 6-3
- Switches, sense 3-10,19,20,21,22
- Syntax overlay processing (disable/enable) 3-27
- System configuration 1-1
- System control commands 3-22
- System control information (S) display 4-35,37
- System control point 2-29
- System date, changing 3-26
- System dayfile
 - Display 4-2,3,4
 - Dumping 3-2
- System deadstart 2-14
- SYSTEM entry (refer to NOS Installation Handbook)
- System file name table display 4-22,23; 5-1
- System idling 3-24
- System initialization 2-28
- System jobs, service limits 3-4
- System modification 3-26
- System origin jobs, queue priorities 3-4
- System program/utility selection 3-25
- System status word 4-35
- System time, changing 3-26

- T command 5-10
- T display (DIS) 5-1
- T display, time-sharing status (DSD) 4-36,38
- TAF command 3-22
- Tape, loading D-7,8
- Tape status (E,T.) display 4-17,21
- Tape unit coldstart 2-1,2

- Tape unit operation
 - 667/669 tape unit D-6
 - 677/679 tape unit D-7
- Tape, unloading 3-12; D-9
- Tape/disk controller 2-1,2,3,4,5,6
- Task library directories (O,TA.) display 4-27,28
- TELEX command 3-21
- TELEX control point 3-21
- TELEX subsystem
 - Activating 3-21,24
 - Deactivating 3-24
- TEMP command 3-13
- Temporary mass storage files 3-13
- Terminal
 - Clear message entered 3-10
 - Send message to 3-10
- Terminal address 7-4,5
- Terminate BATCHIO operation 3-18
- Terminate job scheduling 3-24
- Terminate subsystem 3-22
- Terminate system operations G-1
- Text display 5-1
- Text in central memory 5-1
- TIME comand 3-26
- Time entry 2-28
- Time limit command 3-3; 5-9
- Time-sharing control point 3-21
- Time-sharing jobs
 - Queue priorities 3-4
 - Recovery 3-21
 - Service limits 3-4
- Time-sharing status (T) display 4-36,38
- Time slice
 - Central memory 3-5
 - CPU 3-4
- Timed/event rollout queue 3-9; 4-22,23,32
- Track reservation 3-14; 6-6
- Track reservation table (TRT) 2-27; 6-9
- TRAIN command 3-18
- Transaction status (O) displays 4-27
- Transaction subsystem
 - Activating 3-22,24
 - Commands 3-29
 - Control point 2-29
 - Deactivating 3-24; G-1
 - Displays 3-30; 4-27
- Transaction terminal status (O,TR.) display 4-27,29
- TRT 2-27; 6-9
- TTK flaw entry 6-7
- Turning off PPs J-2

- U command 5-10
- U display (DIS) 5-1
- UCC command 5-10
- Unlabeled tape, assignment to job 3-10
- UNLOAD command 3-12
- Unload, global 3-12; 4-16; 8-1; E-1
- Unloading a removable mass storage device 3-12

- Unloading tape 3-12; D-9
- Unloading, 844 disk D-9
- UNLOCK command 3-25
- UNSTEP command 3-27
- UP command 3-13
- User recovery time-sharing 3-21
- User validation (disable/enable) 3-24
- Utility/system program selection 3-25
- Unit reservations 8-4
- User accessible ECS 3-24
- USER ECS option 3-24
- Utilities (*U*) display 2-7,22

- V command 5-10
- V display (DIS) 5-1
- VALIDATE command 3-13
- Validation of ACCOUNT statement (enable/disable) 3-23
- Validation of mass storage files 2-35
- Validation of mass storage labels 2-14
- Validation of mass storage tables 3-13
- VALIDUs file 3-24; 4-35
- Volume serial number (VSN)
 - Assign to tape 3-10,11
 - Clear 3-12
 - Definition 4-17
- VSN (volume serial number) command 3-10,11,12

- Warmstart 2-8; C-3
 - Deadstart panel settings 2-11
 - Procedures 2-8
- WARN command 3-10
- Word 13 2-12

- X command 5-10
- X.ISF command 2-28
- X.name command 3-25
- X register set command 5-9

- Y display (DIS) 5-1
- Y display, monitor functions (DSD) 4-39

- Z display, directory (DIS) 5-6
- Z display, directory (DSD) 4-40
- Zero function code output to channel 3-29

- 51 COLUMN switch D-2
- 99 command 3-1,27

COMMENT SHEET

MANUAL TITLE: CDC NOS Version 1 Operator's Guide

PUBLICATION NO.: 60435600

REVISION: M

NAME: _____

COMPANY: _____

STREET ADDRESS: _____

CITY: _____ STATE: _____ ZIP CODE: _____

This form is not intended to be used as an order blank. Control Data Corporation welcomes your evaluation of this manual. Please indicate any errors, suggested additions or deletions, or general comments below (please include page number references).

Please Reply

No Reply Necessary

CUT ALONG LINE

PRINTED IN U.S.A.

AA3419 REV 1/80

NO POSTAGE STAMP NECESSARY IF MAILED IN U.S.A.

FOLD ON DOTTED LINES AND TAPE. POSTAL REGULATIONS PROHIBIT THE USE OF STAPLES.

FOLD

FOLD



NO POSTAGE
NECESSARY
IF MAILED
IN THE
UNITED STATES

BUSINESS REPLY MAIL
FIRST CLASS PERMIT NO. 8241 MINNEAPOLIS, MINN.

POSTAGE WILL BE PAID BY

CONTROL DATA CORPORATION

Publications and Graphics Division
ARH219
4201 North Lexington Avenue
Saint Paul, Minnesota 55112



CUT ALONG LINE

FOLD

FOLD

DSD DISPLAY INDEX

<u>Letter Designation</u>	<u>Display</u>	<u>Page</u>
A.,	System Dayfile	4-4
A,ACCOUNT FILE.	Account Dayfile	4-5
A,ERROR LOG.	Error Log Dayfile	4-6
B.	Job Status	4-7
C.	Central Memory	4-10
D.	Central Memory	4-8
E.,	Equipment Status Table (EST)	4-14
E,A.	Equipment Status Table (EST)	4-14
E,C.	Mass Storage Configuration	4-15
E,M.	Mass Storage Status	4-18
E,P.	Resource Mounting Preview	4-19
E,T.	Tape Status	4-21
F.	Central Memory	4-11
G.	Central Memory	4-8
H.	File Name Table (FNT)	4-23
I.	BATCHIO Status	4-25
J.	Control Point Status	4-26
K.	CPU Programmable	4-24
L.	CPU Programmable	4-24
M.	ECS Memory	4-12
N.	File	4-27
O,TA.	Task Library Directories	4-28
O,TR.	Transaction Terminal Status	4-29
O,SU.	Subcontrol Point Status	4-30
P.	PP Communications Area	4-31
Q.	Queue Status	4-33
R.	Export/Import Status	4-34
S.	System Control Information	4-37
T.	Time-sharing Status	4-38
Y.	Monitor Functions	4-39
Z.	Display Directory	4-40



CONTROL DATA CORPORATION