

3000

SERIES

PERIPHERAL EQUIPMENT

REFERENCE MANUAL

VOLUME 1

CONTROL DATA
CORPORATION

RECORD of REVISIONS

REVISION	NOTES
A (12-30-65)	Publication Change Order CA 12209 adds Section D (3127-A) to Part I, Volume 1, and Section A (3436-A/3637-A) to Part V, Volume 1. This change order does not affect any Product Designation. Page iii changed.
B (5-12-66)	Publication Change Order 13374 adds Section D (3458-A) to Part III, Volume 1. This change order does not affect any Product Designation. Pages iii and v changed.
C (6-17-66)	Publication Change Order 13951. Part II, Volume 1, Equipment sections revised. Sections A (3446-A/3644-A) and B (3245-A) revised. Sections C and D (3248-A/3447-A/3649-A) combined and Section D (3142 Card Reader Controller) added. This change order does not affect any Product Designation. This printing obsoletes Part II Card Equipment (Sections A, B, C, D, and Z) only, which are replaced with Rev. Packet C.
D (11-10-66)	Publication Change Order 15140. Card Equipment, Section D (3142) pages D-13, D-14, and Z-5 revised. Visual Recording Equipment, Section D (3458-A) pages D-36 and D-37 revised. This change order incorporates Field Change Order 14742.
E (1-13-67)	Publication Change Order 15567 adds Section B (363X-A) to Part V, Volume 1 (Mass Storage Equipment section).
F (3-9-67)	Publication Change Order 15982. Additions and corrections to Section D (3458-A) Part III, Volume 1. Pages D-iii through D-57 revised.
G (5-6-67)	Publication Change Order 16355. No Product Designation change. The following pages were revised: Frontispiece in Section A (3436-A/3637-A) Part V and page C-3, Section C (3293-A) Part III. Section C (3234-A) pages C-iii thru C-68 were added to Part V. This printing obsoletes Pub. No. 60167800 (3234 Mass Storage Subsystem Reference Manual) which is incorporated in this manual.
H (7-1-67)	Publication Change Order 16618 Section E (3128-A/B) added to Part I, Volume 1. At this printing the Peripheral Equipment Reference Manual becomes two volumes: Vol. I (Parts I and II). Vol. 2 (Parts III through VI).
J, K (10-3-67)	Publication Change Order 17017, Vol. 1, Part II, Section C (3248-A/3447-A/3649-A) page C-7 revised. Vol. 2, Part V, Section A (3436-A/3637-A) revised. This printing obsoletes Pub. No. 60114300 (3436-A/3637-A Drum Storage Controller). Publication Change Order 17265. Volume 1, Part I, Section F (Magnetic Tape Controller) pages F-1 through F-16 added.
L (11-8-67)	Publication Change Order 17840. Volume 2, Part III, Section E (3254-A Line Printer), pages E-1 through E-18 added. This printing obsoletes Pub. No. 60182300, Rev 01 (3254-A/B Line Printer Reference Manual).
M (1-15-68)	Publication Change Order 18273. Volume 2, Part V, Section C (3234-A). Pages C-7, C-10 and C-36 revised.

FORM CA230 REV. 1-67

Pub No. 60108800
 © 1965, 1966, 1967, 1968
 by Control Data Corporation
 Printed in United States of America

Address comments concerning this manual to:

Control Data Corporation
 Technical Publications Department
 4201 North Lexington Avenue
 St. Paul, Minnesota 55112

or use Comment Sheet in the back of this manual.

GENERAL CONTENTS

- VOLUME 1 PART I. MAGNETIC TAPE EQUIPMENT
- A. 362X-A/B Magnetic Tape Controllers
 - B. 342X-A Magnetic Tape Controller
 - C. 3228-A/3229-A Magnetic Tape Controllers
 - D. 3127-A Magnetic Tape Controller
 - E. 3128-A/B Magnetic Tape Controller
 - F. 3121-A/B Magnetic Tape Controller
 - Z. Supplementary Information, Magnetic Tape Equipment
- PART II. CARD EQUIPMENT
- A. 3446-A/3644-A Card Punch Controllers
 - B. 3245-A Card Punch Controller
 - C. 3248-A/3447-A/3649-A Card Reader Controllers
 - D. 3142-A Card Reader Controller
 - Z. Supplementary Information, Card Equipment
- VOLUME 2 PART III. VISUAL RECORDING EQUIPMENT
- A. 3256-A/3659-A Line Printer Controllers
 - B. 3692-A Program Controlled Input/Output Typewriter
 - C. 3293-A Incremental Plotter
 - D. 3458-A Printer Controller
 - E. 3254-A Line Printer
- PART IV. PAPER TAPE EQUIPMENT
- A. 3691-A/B Paper Tape Reader/Punch
- PART V. MASS STORAGE EQUIPMENT
- A. 3436/3637 Drum Storage Controllers
 - B. 363X-A Disk File Controller
 - C. 3234-A Mass Storage Controller
- PART VI. INTERFACE EQUIPMENT
- A. 3681-A Data Channel Converter
 - B. 3682-A Satellite Coupler

SECTION A

362X-A/B MAGNETIC TAPE CONTROLLERS

CONTENTS

Functional Description	A-1	Equipment Parity Checking	A-10
Tape Unit Designation	A-2	Codes	A-11
Assembly/Disassembly	A-2	Connect Code	A-13
Data Transmission	A-3	Function Codes	A-13
BCD/Binary Modes	A-3	Status Codes	A-17
1604 Mode	A-3	Switches and Indicators	A-19
Record/File Formats	A-4	Operation and Programming	A-21
Transfer Rates	A-4	Clearing the Controller	A-21
Connect	A-4	Reverse Read (607 Tape Units Only)	A-22
Function	A-6	Programming Example	A-23
Interrupts	A-7	Programming Considerations	A-25
Status	A-8	Suppress Assembly/Disassembly	A-25
Parity Checking	A-8	Lost Data	A-25
Transmission Parity Checking	A-8		

FIGURES

A-1 Typical Configuration	A-1	A-2 362X Equipment Number Switch and Indicator Panel	A-19
---------------------------	-----	--	------

TABLES

A-1 Connect, Function, and Status Codes	A-12
---	------

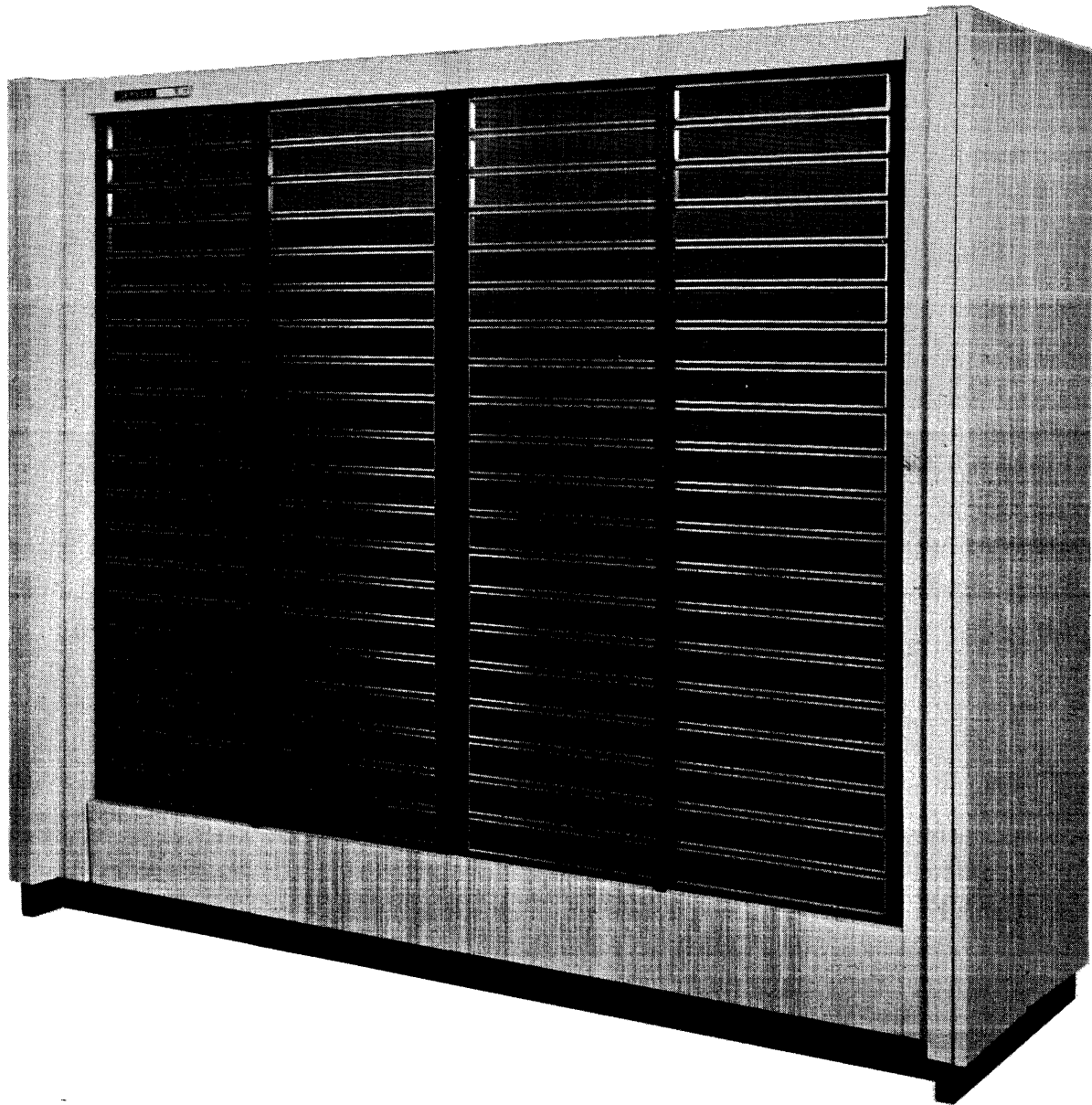

362X MAGNETIC TAPE CONTROLLER

362X-A/B MAGNETIC TAPE CONTROLLERS

The CONTROL DATA* 362X Magnetic Tape Controllers facilitate high-speed transfer of data between CONTROL DATA 606 and/or 607 Magnetic Tape Transports** and standard 3000 Series data channels. These controllers may be used in any 3000 Series system. (See Figure A-1.)

This section describes the disassembly of data received from the data channel and the assembly of data received from the tape unit. It also describes the Connect, Function, and Status codes and provides pertinent programming information.

FUNCTIONAL DESCRIPTION

The 362X Controller consists of as many as four read/write controls. Each control may be physically attached to one 3000 Series data channel. Each channel, through its associated control, can communicate with any attached tape unit, providing the tape unit is not in use or reserved by another channel. All channels may communicate with their logically connected tape units simultaneously.

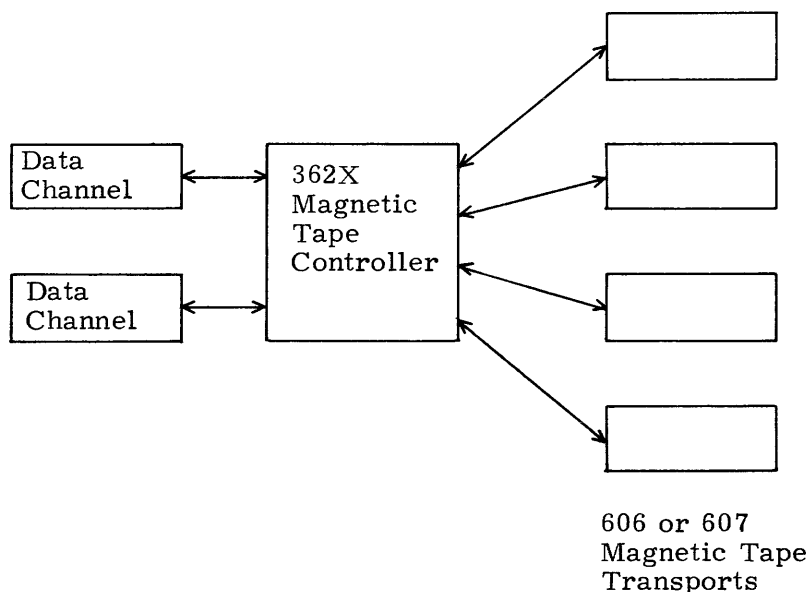

Figure A-1. Typical Configuration

*Registered trademark of Control Data Corporation

**The program must be adapted if 606 and 607 Tape Units are mixed.

Data channels serving the controller need not be associated with the same central processor.

The 362X Controller is available with the following options:

- 3622 Two read/write controls to control one to sixteen 606/607 Magnetic Tape Transports.
- 3623 Four read/write controls to control one to eight 606/607 Magnetic Tape Transports.
- 3624 Four read/write controls to control one to sixteen 606/607 Magnetic Tape Transports.
- 3625 Three read/write controls to control one to eight 606/607 Magnetic Tape Transports.
- 3626 Three read/write controls to control one to sixteen 606/607 Magnetic Tape Transports.

TAPE UNIT DESIGNATION

The attached tape units may be divided into two banks, 0 and 1. However, if eight or fewer units are attached, they generally belong to bank 0.*

Each tape unit in a particular bank must have a unique numerical designation, 0 - 7.** Tape units in bank 0 are referred to as units 0X and those in bank 1 as units 1X. When the numerical designation of a unit is changed, any existing connection and/or reservation is cleared.

ASSEMBLY/DISASSEMBLY

During Write operations, a control receives data from its data channel in 12-bit bytes (i.e., 12 bits of data are received simultaneously on 12 data lines). A tape unit, however, can handle only one 6-bit character at a time. The control, therefore, must disassemble each byte into two characters. The character comprised of the upper 6 bits is transmitted to the tape unit first, followed by the lower 6 bits.

*Depends on system configuration

**The numerical designation (X) is determined by the Unit Select switch. This switch is located on the tape unit.

This disassembly is automatically suppressed when a 3100/3200 Character Output instruction (OUTC or OTAC) is executed. In this case, only the lower 6 bits of the data byte are transmitted to the tape unit. The controller ignores the upper 6 bits of the byte.

During Read operations, the tape unit transmits 6-bit characters to the control. The control assembles two successive characters into a single byte for transmission to the data channel. The first character received comprises the upper 6 bits of the byte, and the next character comprises the lower 6 bits.

This assembly is automatically suppressed when a 3100/3200 Character Input instruction (INPC or INAC) is executed. In this case, each character received from the tape unit is transmitted to the data channel as the lower 6 bits of the byte. The upper 6 bits are zeros.

DATA TRANSMISSION

BCD/Binary Modes

Data may be written on or read from tape in either BCD (binary coded decimal) or Binary mode. Data is processed in Binary mode following a clearing operation or the selection of Binary mode. It is processed as BCD following the selection of BCD mode. A code of all zeros is considered illegal if the controller is in BCD and 1604 mode.

1604 Mode*

Normally, during a Write operation in BCD mode, the controller automatically changes any character of all "0's" and writes it as 12_8 on tape. When reading a 12_8 from tape in BCD mode, the controller changes it to a character of all "0's". If bit 4** is a "1", bit 5 is complemented during Read and Write operations (bit 4 remains unchanged). This process converts internal BCD codes to external BCD codes when writing and vice versa for reading.

If the computer is running in 1604 mode, the conversion from internal BCD to external BCD does not apply during a Write operation. Similarly, the conversion from external BCD to internal BCD does not apply during a Read operation.

*3600/3800 systems only

**Bit 0 is the rightmost bit of the character to be written on tape.

Record/File Formats

The data written on tape as the result of a single Output instruction constitutes a record. If 3100/3200 Character Output instructions are used, a record may be as short as a single character. Adjacent records are separated by a record gap.

A file consists of one or more records. Its length is determined by the programmer. Adjacent files are separated by a file mark which a tape unit writes in response to a function code (Write File Mark).

An End of Record signal is sent to the data channel during a Read operation when a tape unit detects a record gap or a file mark. This signal may be used to terminate a Read.* The Read operation also terminates when the specified number of words or characters has been read.

Transfer Rates

Read or Write operations may be performed with 607 Tape Units at any one of three densities: 200 characters/inch, 33 microseconds/frame; 556 characters/inch, 12 microseconds/frame; 800 characters/inch, 8 microseconds/frame. With 606 Tape Units, only low density (200 characters/inch) and high density (556 characters/inch) are available.

The programmer should determine or select density and binary or BCD formats prior to a Read or Write operation.

CONNECT

A control must be connected to its data channel before it can respond to either a Select/Function instruction or an Input/Output instruction. The connection is accomplished by the Connect instruction; the Connect code (N0UU) is the lower 12 bits of this instruction. The N portion of the code must contain the equipment number of the read/write control. The UU portion of the code designates one of the sixteen possible tape units (00 - 17g). Each control examines every Connect code transmitted from its attached data channel. A Reply signal, ** indicating a connect, is returned to the data channel from a control if:

*In 3100/3200 systems, the End of Record signal always terminates a Read.
In 3400/3600/3800 systems, this use of the signal is optional.

**A Reply signal tells the central processor to process the next instruction.

- 1) The requested tape unit (UU) is not connected to or reserved by the other data channel,
- 2) The N portion of the Connect code matches the setting of the Equipment Number switch on the read/write control,
- 3) The UU portion of the Connect code matches the bank designation and setting of the Unit Select switch on an unreserved tape unit, and
- 4) A transmission parity error is not detected.

If the requested tape unit is connected to or reserved by another data channel or if a Read/Write operation is still in progress, a Reject signal* is returned to the data channel requesting the connect. Equipment status is also made available to that data channel so that the cause for the reject may be determined.

If the N portion of the Connect code does not match the setting of the Equipment Number switch, neither a Reject nor a Reply is returned to the channel from the control. Equipment status is not made available to the channel. If the control is already connected, it automatically disconnects. The tape unit connected through the control does remain reserved for that channel until released, cleared, or given a new unit number. If neither a Reply nor a Reject is returned to the data channel from any of its attached equipments within 100 microseconds, the central processor generates an Internal Reject.

If the UU portion of the Connect code does not match the setting of any Unit Select switch, a Reject signal is returned to the data channel.

If a parity error is detected in a Connect code, the device does not connect** and neither a Reply nor a Reject is returned to the data channel. Instead, the Parity Error indicator of each equipment detecting the error lights. In this equipment, a red indicator in the Equipment Number switch lights. These parity error conditions must be cleared by either a Channel Clear or a Master Clear prior to a new connect attempt.

Tape units physically attached to the 362X Controller may be unconnected and unreserved, connected to a data channel, or reserved by a data channel.

*A Reject signal tells the central processor to read the next instruction at the reject jump address contained in the Connect instruction.

**If the device is connected, it automatically disconnects.

Unconnected and unreserved units may be connected by any channel serving the controller. Once a channel is connected to a particular unit (i. e. , a communication path is established), that unit remains reserved for that channel even though the channel disconnects the unit by connecting (or attempting to connect) to another unit or equipment. Once a unit is reserved by a channel, no other channel has access to the unit. Since it is possible for one channel to reserve all tape units, care must be taken to release those units not essential to the current program. If more than one channel attempts to connect simultaneously, a scanner determines the channel to be connected.

FUNCTION

Function codes are used to prepare a connected control and/or unit for an Input/Output operation. (They have no effect on unconnected controls or units.) They comprise the lower 12 bits of a Select/Function* instruction and are transmitted to the control on the 12 data lines. Table A-1 is a complete list of function codes. A detailed description of each code follows the table.

There are three classifications of codes: operating, ** nonoperating, and interrupts. Operating codes cause tape motion. They include Rewind, Rewind Unload, Backspace, Search Forward/Backward to File Mark, Write File Mark, and Skip Bad Spot. Nonoperating codes include Release, Binary, Coded, Densities, Clear, and Set and Clear Reverse Read.

The control accepts operating codes only when the tape is completely at rest. Thus, operating codes are not accepted during a Read or a Write operation or when an accepted operating code is being executed. Likewise, a new Read or Write operation cannot be initiated while an operating code is being executed.

Nonoperating codes are accepted prior to a Read or Write operation, following the conclusion of a Write, and following the receipt of an End of Record signal during a Read. Thus, they are accepted even though an operating code is being executed.

Interrupt codes are never rejected.

*Function in 3400/3600/3800 systems, Select in 3100/3200 systems

**Operating codes cause the control to become Busy.

A control examines only one code at a time. First, it checks for parity errors. If none are found, it returns a Reply if the requested function can be performed* or a Reject if it cannot be performed. Interrupt codes always cause a Reply signal to be returned to the channel.

If a parity error is detected, the requested function is not performed, a Parity Error signal is returned to the data channel, and a red indicator in the Equipment Number switch lights. Since neither a Reply nor a Reject is returned to the data channel, the central processor generates an Internal Reject after a wait of 100 microseconds.

These parity error indications must be cleared by either a Channel Clear or a Master Clear. The equipment must then be reconnected before a new function code is examined by the controller.

INTERRUPTS

Interrupts provide a means for attaining optimum utilization of a system's capabilities. Basically, the system interrupts (halts) the main program and initiates an interrupt processing program** when an Interrupt signal is detected by the processor.

The 362X Tape Unit can be programmed to send an Interrupt signal to the processor when any one of the conditions specified by the three interrupts*** occurs.

A Select Interrupt code permits the controller to consider as a group**** several of the operating conditions which may occur in an attached unit. If a specific interrupt has been selected and if at least one of the conditions specified by it occurs in the connected unit, the controller sends an Interrupt signal to the processor. If the interrupt system in the processor has been set to recognize the interrupt, the main program is interrupted and control is transferred to a specific program address. Status sensing and followup operations may follow. If desired, control may be returned to the main program by an appropriate Jump instruction located at the close of the interrupt processing program.

*Certain illegal function codes cause a Reply to be returned. However, in these cases no action follows.

**See the system reference manual for the addresses pertinent to interrupt processing.

***See description of function codes following Table A-1 for a list of these conditions.

****See description of function codes following Table A-1 for a breakdown of the three possible groups.

If the processor's interrupt system has not been enabled, it is still possible to sense for these conditions via Sense Status and Copy Status instructions written into the main program.

Regardless of which of the above actions is followed, the Interrupt signal remains up until cleared by reselecting the interrupt, selecting release, or master clearing the system. The Interrupt signal is transmitted on the equipment's interrupt line via the data channel currently connected to or reserving the equipment.

The eight-position (0-7) Equipment Number switch determines the number of the line on which the Interrupt signal is transmitted. For example, if the Equipment Number switch is set at 5, all Interrupt signals coming from this control are transmitted on interrupt line 5. Since each equipment attached to a data channel has a unique equipment number, each uses a different interrupt line. A Channel Product Register Jump instruction* or a Copy Status instruction** can identify the equipment sending the Interrupt signal by inspecting the interrupt lines.

STATUS

Status codes permit the monitoring of several control/unit operating conditions. These codes are made available to the data channel over 12 status lines following a connect or a rejected connect attempt. Sense Status and Copy Status instructions make these codes available to the central processor.

See Table A-1 for a complete list of these codes. If two or more conditions exist simultaneously, the Status Response code is the sum of the individual codes. A detailed description of each code follows the table.

PARITY CHECKING

Transmission Parity Checking

Connect codes, function codes, and data are transmitted between the data channel and the controller in odd parity (i. e., the number of "1" bits transmitted must be odd).

*3600/3800 systems

**3100/3200/3400 systems

If the number of "1" bits in a data byte is even, a "1" is transmitted on the parity line to make the total number of "1" bits odd.* If the number of "1" bits in the data byte is odd, a "1" is not transmitted on the parity line.

A transmission parity error exists if the total number of "1" bits transmitted on the 12 data lines plus the parity line is even, indicating that a bit has been lost or picked up.

Parity Error in a Connect Code: If a parity error is detected in a Connect code, the device does not connect** and neither a Reject nor a Reply is returned to the data channel. Instead, a red indicator in the Equipment Number switch of each equipment detecting the error lights. These parity error conditions must be cleared by either a Channel Clear or a Master Clear prior to a new connect attempt.

Parity Error in a Function Code: If a parity error is detected, the requested functions are not performed, a Parity Error signal is returned to the data channel, and a red indicator in the Equipment Number switch lights. Since neither a Reply nor a Reject is returned to the data channel, the central processor generates an Internal Reject after a wait of 100 microseconds. These parity error indications must be cleared by a Channel Clear or a Master Clear.*** The equipment must then be reconnected before a new function code can be examined by the controller.

Parity Error in Output Data: If a transmission parity error is detected by the control during a Write operation, the control lights a red indicator in its Equipment Number switch and sends both a Reply and a Parity Error signal to the data channel. The data is written on tape. All operations continue**** unless appropriate programming steps have been taken to sense the Parity Error signal and to rewrite the data. These parity error indications must be cleared by either a Channel Clear or a Master Clear. The equipment must then be reconnected and the appropriate functions reselected prior to the new output.

*Do not confuse this line with the parity error line.

**If the device is connected, it automatically disconnects.

***Though operations may continue normally, the validity of a new function code and/or data prior to a Master Clear or Channel Clear is questionable.

****The validity of the data received from this point until a Channel Clear or Master Clear is questionable.

Parity Errors in Input Data: Transmission parity errors may be detected by the data channel on data received from the equipment. If a parity error is detected, a parity error bit in the data channel is set and a Parity Error indicator on either the channel or console lights. The faulty data is entered into either core storage or the A register. All operations continue* unless appropriate programming steps have been taken to sense for the set bit and reread the data. These parity error indications may be cleared by a Channel Clear or a Master Clear issued by any 3000 Series system and by a new Read or Write from a 3100/3200 system. Following a Channel Clear or a Master Clear, the equipment must be reconnected and the appropriate functions reselected prior to a new input.

Input/Output Parity Error Bit in the Data Channel: The input/output parity error bit is set whenever a transmission parity error is detected. If the error is detected by the equipment, the bit is set by the Parity Error signal.

In 3400/3600/3800 systems, an Interrupt signal may be generated when this bit sets. If the interrupt system has not been set to detect the setting of this bit, the bit may be sensed to detect parity error conditions.

In 3100/3200 systems, this bit must be sensed if transmission parity error conditions are to be detected by the central processor.

Refer to the appropriate system reference manual for more information on the input/output parity error bit.

Equipment Parity Checking

Each character, whether BCD or binary, transmitted between a control and a unit is checked for correct parity. For BCD characters, correct parity is even, and for binary characters it is odd. During a Write operation, the control adds the correct parity bit to each character and relays it to the tape unit. Approximately 2 milliseconds after writing, a vertical parity error check is made. This time interval is used to check-read the tape and transmit the data back to the control. At the conclusion of a record, a record check character is written. This character is used for longitudinal parity checking. During a Read, vertical and longitudinal parity checks are made by the control when the appropriate data is received.

*The validity of the data received from this point until the indicators are cleared is questionable.

Both vertical and longitudinal parity errors are considered equipment parity errors.

Vertical Parity Error Checking: A vertical (transverse) parity error exists when the number of "1" bits on the six data lines plus the parity line is not correct. The number of "1" bits must be odd for binary data and even for BCD data.

If a vertical parity error is detected, the Vertical Parity Error indicator on the control lights and a Parity Error signal is placed on the appropriate status line. These parity error indications may be cleared by a new Read, Write, Channel Clear, or Master Clear. If desired, this condition may cause an Abnormal End of Operation interrupt.

Longitudinal Parity Error Checking: Longitudinally (lengthwise), the tape is divided into seven tracks. Six of these are used to store data, and the seventh holds the vertical parity bits. When a record is written onto or read from tape, the total number of "1" bits in each track must be even. If the number of "1" bits in any track of a record is odd, a "1" is written in that track as a part of the record check character. During a Read operation, longitudinal parity error exists if the record check character is not as anticipated.

If a longitudinal parity error is detected, the appropriate Longitudinal Parity Error indicator(s) remains lighted,* and a Parity Error signal is placed on the appropriate status line. These parity error indications may be cleared by a new Read, Write, Channel Clear, or Master Clear. If desired, this condition may cause an Abnormal End of Operation interrupt.

CODES

All connections and operations are controlled by 12-bit Connect and function codes in conjunction with the appropriate Connect or Select/Function instruction. Status codes are constantly available while the equipment is connected. In all discussions of codes, bit 0 is in the rightmost position (see Table A-1).

*These indicators may flash on and off during normal operation. Such flashings are to be ignored.

TABLE A-1. CONNECT, FUNCTION,
AND STATUS CODES

CONNECT	
Connect Tape Unit	N0UU*
FUNCTION	
Release	0000
Binary	0001
Coded	0002
556 BPI	0003
200 BPI	0004
Clear	0005
800 BPI**	0006
Rewind	0010
Rewind Unload	0011
Backspace	0012
Search Forward to File Mark	0013
Search Backward to File Mark	0014
Write File Mark	0015
Skip Bad Spot	0016
Clear Reverse Read**	0040
Set Reverse Read***	0041
Select Interrupt on Ready and Not Busy	0020
Release Interrupt on Ready and Not Busy	0021
Select Interrupt on End of Operation	0022
Release Interrupt on End of Operation	0023
Select Interrupt on Abnormal End of Operation	0024
Release Interrupt on Abnormal End of Operation	0025
STATUS	
Ready	XXX1
Channel and/or Read/Write Control and/or Unit Busy	XXX2
Write Enable	XXX4
File Mark	XX1X

*N = equipment number of read/write controls, UU = bank designation and unit number of a specific tape unit

**607 Tape Units only

***If a Backspace operation is executed when Reverse Read is set, tape is moved in a forward direction. 607 Tape Units only

TABLE A-1. CONNECT, FUNCTION,
AND STATUS CODES (Cont'd)

STATUS (Cont'd)	
Load Point	XX2X
End of Tape	XX4X
Density ("1" in bit 6 indicates 556 BPI, "0" in bits 6 and 7 indicates 200 BPI)	X1XX
Density ("1" in bit 7 indicates 800 BPI)	X2XX
Lost Data	X4XX
End of Operation	1XXX
Vertical or Longitudinal Parity Error	2XXX
Reserved (by other channel)	4XXX

CONNECT CODE

Connect Tape Unit (N0UU)

This code connects the desired unit. N is the equipment number of the read/write control. UU is bank designation and unit number of a specific tape unit.

FUNCTION CODES

Release (0000)

This code clears both the existing unit connection and the channel reserve for the unit. It does not clear reserve logic on any other tape units reserved by that data channel.

Binary (0001)

This code causes all data to be written/read in binary notation.

Coded (0002)

This code causes all data to be written/read in BCD notation.

556 BPI (0003)

This code causes all data to be written/read at 556 bits per inch density.

200 BPI (0004)

This code causes all data to be written/read at 200 bits per inch density.

Clear (0005)

This code clears all tape unit reservations made by the data channel as well as the existing unit connection. It permits other channels to gain access to these units.

*800 BPI (0006)**

This code causes all information to be written/read at 800 bits per inch density.

Rewind (0010)

This code rewinds tape at high speed (400 inches per second) to load point. It has no effect when the tape is at load point.

Rewind Unload (0011)

This code rewinds tape at high speed to load point. It then rewinds tape slowly until all of the tape is on the supply reel. All further operations with this tape unit are locked out until the tape is manually reloaded.

Backspace (0012)

This code backspaces the tape one record or until load point is detected. If the tape is at load point and if fewer than two records precede the load point, it unloads the tape. If Reverse Read is selected, * a Backspace selection initiates forward tape motion.

*607 Tape Units only

Search Forward to File Mark (0013)

This code advances the tape until a file mark is detected. If no file marks are detected, tape motion continues until all the tape is on the takeup reel.

Search Backward to File Mark (0014)

This code backspaces tape until a file mark or load point is detected. If the tape is at load point, it backspaces the tape until either a file mark is detected or the tape is unloaded.

Write File Mark (0015)

This code advances the tape at least 6 inches, then writes a 17_8 file mark followed by a 17_8 check character. Both are written in even vertical parity. This file mark is used with both BCD and Binary modes. Writing a file mark does not affect the selected format.

Skip Bad Spot (0016)

This code erases at least 4 inches of tape. Vertical and longitudinal parity checks are made to insure complete erasure.

*Clear Reverse Read (0040)**

This code clears the condition set by the Set Reverse Read code.

*Set Reverse Read (0041)**

This code must precede a Reverse Read operation (see Reverse Read section).

Select Interrupt on Ready and Not Busy (0020)

This code causes the controller to send an Interrupt signal to the processor when the tape unit is in a Ready and Not Busy condition (i. e., when power is applied, the unit is under computer control, and all tape motion has ceased). Once up, the Interrupt signal can be cleared by selecting release (0021) or by clearing the control.

*607 Tape Units only

Release Interrupt on Ready and Not Busy (0021)

This code clears an Interrupt on Ready and Not Busy selection and the Ready and Not Busy Interrupt signal if it is up.

Select Interrupt on End of Operation (0022)

This code causes the controller to send the Interrupt signal to the processor when the data channel terminates a Read or Write operation, when a tape unit senses the end of a record during a Read operation, or upon completion of an operating function. Once up, the Interrupt signal remains up until cleared by reselecting the interrupt (0022), selecting release (0023), or clearing the control.

During a chaining operation, * interrupt does not occur until the data channel is Not Busy (i. e., until the last record has been written/read in the chaining operation).

Release Interrupt on End of Operation (0023)

This code clears the Interrupt on End of Operation selection and the End of Operation Interrupt signal if it is up.

Select Interrupt on Abnormal End of Operation (0024)

This code causes the controller to send an Interrupt signal to the processor after an abnormal condition occurs. These abnormal conditions are End of Tape, File Mark, ** Load Point, **Vertical Parity Error, Longitudinal Parity Error, Lost Data, parity error during a Skip Bad Spot operation, and connected tape unit becoming Not Ready.

In all but the last case, the interrupt occurs when one or more of these conditions are encountered and when an end of record check character is written/read by the tape unit. In the case of interrupt on connected tape unit becoming Not Ready, interrupt occurs immediately when the connected tape unit goes from a Ready to a Not Ready condition (e. g., if the power is turned off on the tape unit). Interrupt on connected tape unit becoming Not Ready does not occur during a Connect operation or when a Release code (0000) is executed.

*3400/3600/3800 systems only

**Common to Interrupt on End of Operation and Interrupt on Abnormal End of Operation

A new Read/Write operation cannot start until the Interrupt signal is cleared. Once up, the Interrupt signal can be cleared by reselecting the interrupt (0024), selecting release (0025) or a Master Clear.

Release Interrupt on Abnormal End of Operation (0025)

This code clears an Interrupt on Abnormal End of Operation selection and the Abnormal End of Operation Interrupt signal if it is up.

STATUS CODES

Ready (XXX1)

Bit 0 is set when the tape unit is in a Ready condition (i. e. , power is applied and the Ready switch is lighted). (The tape controller can operate the unit.)

Channel and/or Read/Write Control and/or Unit Busy (XXX2)

If the tape unit is Ready, bit 1 is set when the channel is transmitting or receiving data during an Input/Output operation. It is also set if the unit is Ready and tape motion is initiated by an operating function code. In these two cases, it remains set until 5 milliseconds after tape motion stops. Bit 1 is cleared approximately 5 milliseconds after either detection of lost data or an Abnormal End of Operation Interrupt signal and cannot be reset until these conditions cease to exist. Bit 1 cannot be set if bit 0 is clear.

Write Enable (XXX4)

Bit 2 is set when the file protection ring is on the tape reel. When this ring is present it is possible to read from and write on the tape. When this ring is absent it is possible to read from but not write on the tape.

File Mark (XX1X)

Bit 3 is set whenever a file mark is read.* It remains set until a new operating function, a Read/Write operation, or a clearing operation is initiated or until a new unit is connected or the same unit is reconnected.

*If a file mark is detected during a Search Backward to File Mark and this is followed by a Read forward, the file mark is the first record read.

Load Point (XX2X)

Bit 4 is set when the tape is at load point. It is cleared when the tape moves off the load point.

End of Tape (XX4X)

Bit 5 is set when the end of tape marker is detected. It is cleared when the end of tape marker is sensed during Rewind or Reverse Read.*

Density (X1XX)

Density (X2XX)

	<u>Bit 7</u>	<u>Bit 6</u>
200 BPI	0	0
556 BPI	0	1
800 BPI	1	0

Lost Data (X4XX)

Bit 8 is set when the control determines that data may have been lost in transmission. Tape motion stops when bit 8 is set and cannot be restarted until this bit is cleared by a new Connect or function code or a Master Clear (see Programming Considerations).

When operating from a 160/160-A Computer via a 3681 Data Channel Converter, lost data is also detected if the read or write selection in the 3681 Converter is not cleared immediately after a Read or Write operation is completed. As long as a Write signal is present and the Data signal is not present at the required time, the controller assumes that the data transmission loss has occurred and a Lost Data signal is sent. If the Read signal is present but data is not being accepted by the channel, lost data also occurs. It is, therefore, necessary to clear the read or write selection in the 3681 Converter immediately after a Read or Write operation is completed to prevent the Lost Data signal from being sent abnormally. If the Lost Data signal is present, it must be cleared if Read or Write operations are to continue.

*Reverse Read is possible with 607 Tape Units only.

End of Operation (1XXX)

Bit 9 is set when the data terminates a Read or Write operation, when a tape unit senses the end of a record during a Read operation, or upon completion of an operating function. It remains up until a new Read/Write operation, operating function, or clearing operation is initiated.

Vertical or Longitudinal Parity Error (2XXX)

Bit 10 is set following detection of either a vertical or longitudinal parity error or reading a file mark while in Binary mode. It is cleared by a new Read, Write, or clearing operation. If this bit is set during a chaining operation, * it cannot be cleared until chaining operation terminates.

Reserved (by other channel) (4XXX)

Bit 11 is set when a channel attempts to connect to a reserved unit. It is cleared by issuing a Release or Clear code or clearing the equipment.

SWITCHES AND INDICATORS

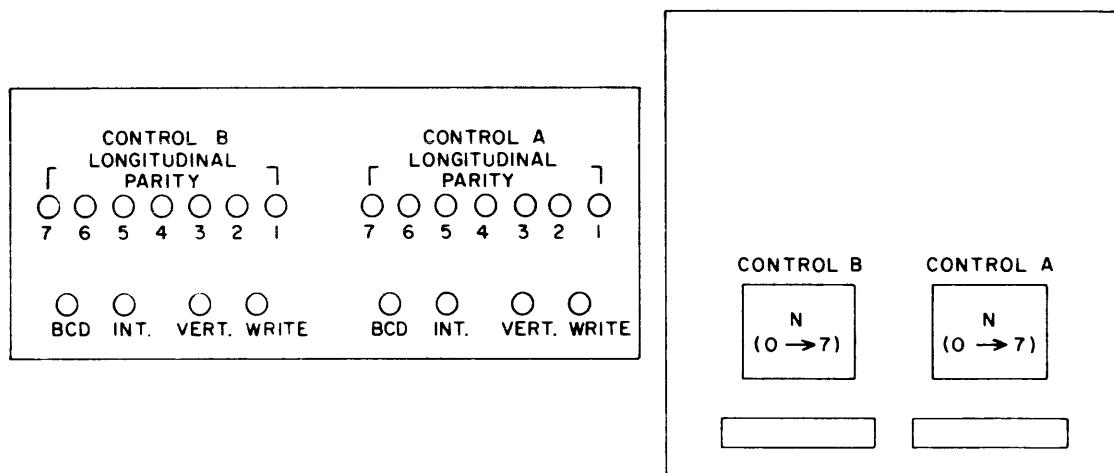

Figure A-2. 362X Equipment Number Switch and Indicator Panel**

EQUIPMENT NUMBER SWITCH

An eight-position Equipment Number switch is associated with each control. The setting of this switch (0 - 7) designates the control and corresponds to the N portion of

*3400/3600/3800 systems only
**Located on the 362X Controller logic chassis

the Connect code. It also determines the number of the interrupt transmission line that the equipment uses.

When a control is connected to a tape unit, a white indicator in the switch lights. This indicator also lights when a connection cannot be made because the tape unit is reserved by another channel.

If a transmission parity error occurs during a Connect, Function, Read, or Write operation, a red indicator in the Equipment Number switch lights.

LONGITUDINAL PARITY INDICATORS

Seven LONGITUDINAL PARITY indicators are associated with each control. At the end of an operation involving longitudinal parity checking, none of these indicators should remain lighted. If one or more remains lighted, a longitudinal parity error has occurred. The indicators remain lighted until a new record is begun.

WRITE INDICATOR

The WRITE indicator is lighted during Write and Write File Mark operations. The WRITE indicator is cleared on termination of the Write operation.

VERT. (VERTICAL) PARITY INDICATOR

A Vertical Parity Error indicator lights if a vertical parity error is detected during a Read or Write operation. This indicator is lighted until cleared by a new Read, Write, Channel Clear, or Master Clear.

INT. (INTERRUPT) INDICATOR

This indicator lights when an interrupt occurs. This indicator remains lighted until the Interrupt signal drops.

BCD INDICATOR

This indicator lights when BCD mode is selected or a file mark is being written on tape.

OPERATION AND PROGRAMMING

CLEARING THE CONTROLLER

Prior to the initial use of the tape controller, the system should be cleared. There are five possible ways of clearing the controller:

1) Clear Channel* (100 microseconds)

This instruction:

- a) Clears all activity in the data channel.
- b) Clears the present connection control N may have with a tape unit.
- c) Releases all tapes (i. e., clears reserve logic) which control N may have reserved.
- d) Performs a Master Clear on control N read, write, and function logic. No status signals are available to the data channel after executing this instruction.

2) Clear (0005) (2 microseconds)

This function code:

- a) Clears the present connection control N may have with a tape unit. Control N remains connected in the sense that status signals are still available for the data channel.
- b) Releases all tape units control N may have reserved.

3) Release (0000)

This function code clears only the connection and the reservation for the connected tape unit. It does not clear the reservations for any other tape units.

4) Power On Master Clear

When power is applied to the 362X Controller, all tape units connected and reserved by all controls are cleared. Logic in all controls is also cleared. No status signals are available to the data channel after power is applied.

5) External Master Clear

This clears all tape units connected and reserved by all controls. It also clears the logic in all controls. No status signals are available to the data channel after executing this operation.

*See the individual processor instructions.

The Clear and Release codes can only be used after a control is connected to a tape unit.

All clear operations (except the Release code) place the 362X Controller in binary format.

REVERSE READ (607 TAPE UNITS ONLY)

The 362X Controller can read information in a reverse direction from tape. Six-bit frames are read from tape, assembled into 12-bit bytes, * and sent to the data channel. When a word is read in a reverse direction from tape and entered into storage, it is identical to the word which was initially written on the tape from storage. There is no change made in the final order of the bits during a Reverse Read operation.

To initiate a Reverse Read operation (assuming format, etc, have already been selected and all tape motion has stopped), a 362X Controller must first receive function code 0041 (Set Reverse Read). When the Read instruction is executed in the processor, the Reverse Read operation begins (i. e., data is available to the data channel). A Reverse Assembly signal is sent to the data channel from the 362X Controller to indicate that the 12-bit bytes should be assembled into a word in reverse order.

Data transfer continues until the word count in the control word equals zero** or until $m^1 = m^2$.*** Tape motion continues in a reverse direction and stops at the gap between the current record and the record check character of the next record (unless chaining or nonstop read has been selected).

Vertical and longitudinal parity checking occur as in a normal Read operation, except if the first frame read is a record check character, no vertical parity check is made on that character. Vertical parity checking is performed on the remaining frames.

If a Reverse Read is attempted from load point, there is no tape motion. The Read operation hangs up.

Parity errors and interrupts may be handled as if the operation were a normal Read. An End of Record signal is returned to the data channel when a record gap is reached. Chaining and nonstop Read operations are also handled as during normal Read.

*This assembly may be suppressed. See Assembly/Disassembly.

**3400/3600/3800 systems

***3100/3200 systems

Function code 0040 (Clear Reverse Read) should be issued when the Reverse Read operation terminates.

PROGRAMMING EXAMPLE*

Start program at address 10000.

<u>Storage Address</u>	<u>Contents of Address</u>	
10000	745-----00-----	CLEAR CHANNEL (Channel 0, Comm. Mod. 0)
10001	7402000000--4000	CONNECT Channel 0 Comm. Mod. 0 to Tape 00
10002	7411----00-----	COPY STATUS on Tape 00, Load in B ¹
10003	BIT SENSE	Sense bit 2 of Status code in B ¹ for Write Enable
10004	76000000	HALT
10005	BIT SENSE	Sense bit 0 of Status code in B ¹ for Ready
10006	76000000	HALT
10007	7411000400--0002	SET BCD MODE
10010	7411000400--0003	SET 556 BPI
10011	74310004000030000	WRITE (Contains control word address)
10012	745-----01-----	CLEAR CHANNEL (Channel 1, Comm. Mod. 01)
10013	7402000001--5013	CONNECT Channel 1 Comm. Mod. 0 to Tape 13
10014	74431---01-----	COPY STATUS on Tape 13, Load in B ³
10015	BIT SENSE	Sense bit 0 of Status code in B ³ for Ready
10016	76000000	HALT
10017	7411001601--0002	SET BCD MODE
10020	7411001601--0003	SET 556 BPI
10021	7421001601030001	READ (Contains control word address)

Continue with main program. Tapes 00 and 13 remain connected.

20000	76000000	HALT
30000	10000100--000100	CONTROL WORD (Write operation)
30001	10000300--000200	CONTROL WORD (Read operation)
30004	7413000400--0010	REWIND Tape 00
30005	7413000501--0010	REWIND Tape 13
30006	76000000	HALT (End of Program)

*3600 system

Sixty-four (100g) words are stored in storage module 0 at locations 00100-00177. Write them on tape 0, bank 0 (556 BPI BCD). Tape 00 is at load point. Also, a record of 300g words is stored on tape 13 (556 BPI BCD). Store the record in storage module 0, starting at location 00200. Tape 13 is also at load point. Rewind both tapes to load point sometime after the Write and Read operations are complete. Halt the program if any of the above operations cannot be executed.

Do a console Master Clear. This clears all registers needed in this example. The program starts at address 10000 with a 48-bit Clear Channel instruction. This clears all equipment connected to communication module 0, data channel 0. The Connect instruction (address 10001) connects tape unit 00 to communication module 0, data channel 0. (The switch on control A on the tape controller is set to accept equipment 4.) The Copy Status instruction (address 10002) loads the 12-bit Status code into B¹. A Bit Sense instruction (address 10003) senses bit 2 of the Status code for a Write Enable. (If this signal is not present when attempting a Write operation, the protective ring is not present on the tape reel.) Another Bit Sense instruction (address 10005) senses bit 0 of the Status code for a Ready signal. The program halts if either a Write Enable or a Ready signal is not present.

The two Function instructions (addresses 10007 and 10010) set the control A logic in the tape controller to BCD mode and 556 BPI. When the computer executes the Write instruction (address 10011), it sends the 18-bit control word address to the communication module. The 3602 reads the 48-bit control word from address 30000 and initiates output from storage module 0 to tape 00.

The main program continues at address 10012 when the control word address has been transmitted to the communication module. The same procedure as above follows for tape 13, except that the operation is a Read from tape 13 on data channel 1, and there is no need to sense for a Write Enable. The Set BCD Mode instruction is necessary since the Clear Channel instruction has set control C logic in the tape controller to the Binary mode. The control C switch on the 362X Controller is set to accept equipment 5.

When the computer reaches address 10021, it executes the Read instruction and sends the 18-bit control word address to the communication module. Then the communication module begins the Read operation, and the main program continues.

When the program reaches address 30004, it sends the 12-bit Rewind instruction (0010) to tape 00. If tape 00 is Busy (indicated by a Reject signal in this case), the program halts at this step and executes a reject jump to address 30004. When the Reply is returned (indicating tape 00 is in a Rewind condition), the program continues at address

30005. When the instruction to rewind tape 13 is completed, the program stops at address 30006.

PROGRAMMING CONSIDERATIONS

Suppress Assembly/Disassembly

If data is to be assembled from a tape that was recorded in Suppress Assembly/Disassembly mode, * assembly difficulties may be encountered. The problem is that in Suppress Assembly/Disassembly mode, an odd number of frames may be written on the tape. If this occurs and the tape is read forward, the controller automatically fills in bits 0 through 5 of the last input byte with "0's". If an odd number of frames are written and a Reverse Read is attempted, the inverted assembly is one frame out of order, and bits 6 through 11 of the last data channel word are filled in with "0's".

Lost Data

The Lost Data condition occurs in two cases:

- 1) When the data channel cannot supply or accept data at the rate required by the tape unit due to competition from other devices for access to storage.
- 2) When certain malfunctions occur in the data channel.

A Lost Data condition causes data transfer to stop, stops tape motion (at the next record gap), and sets the lost data status bit. A new Read or Write operation cannot begin until the Lost Data condition is cleared by a Master Clear, Clear Channel instruction, or new Connect or Function operation. In most cases, the Lost Data condition leaves the data channel active (i. e., the Read or Write operation remains uncompleted). Thus, a new Connect or Function operation cannot be initiated until the channel active condition is cleared by a Master Clear, Clear Channel instruction, or Stop Channel Activity function code. **

* 3100/3200 system

** 3600/3800 systems only

SECTION B

342X-A MAGNETIC TAPE CONTROLLERS

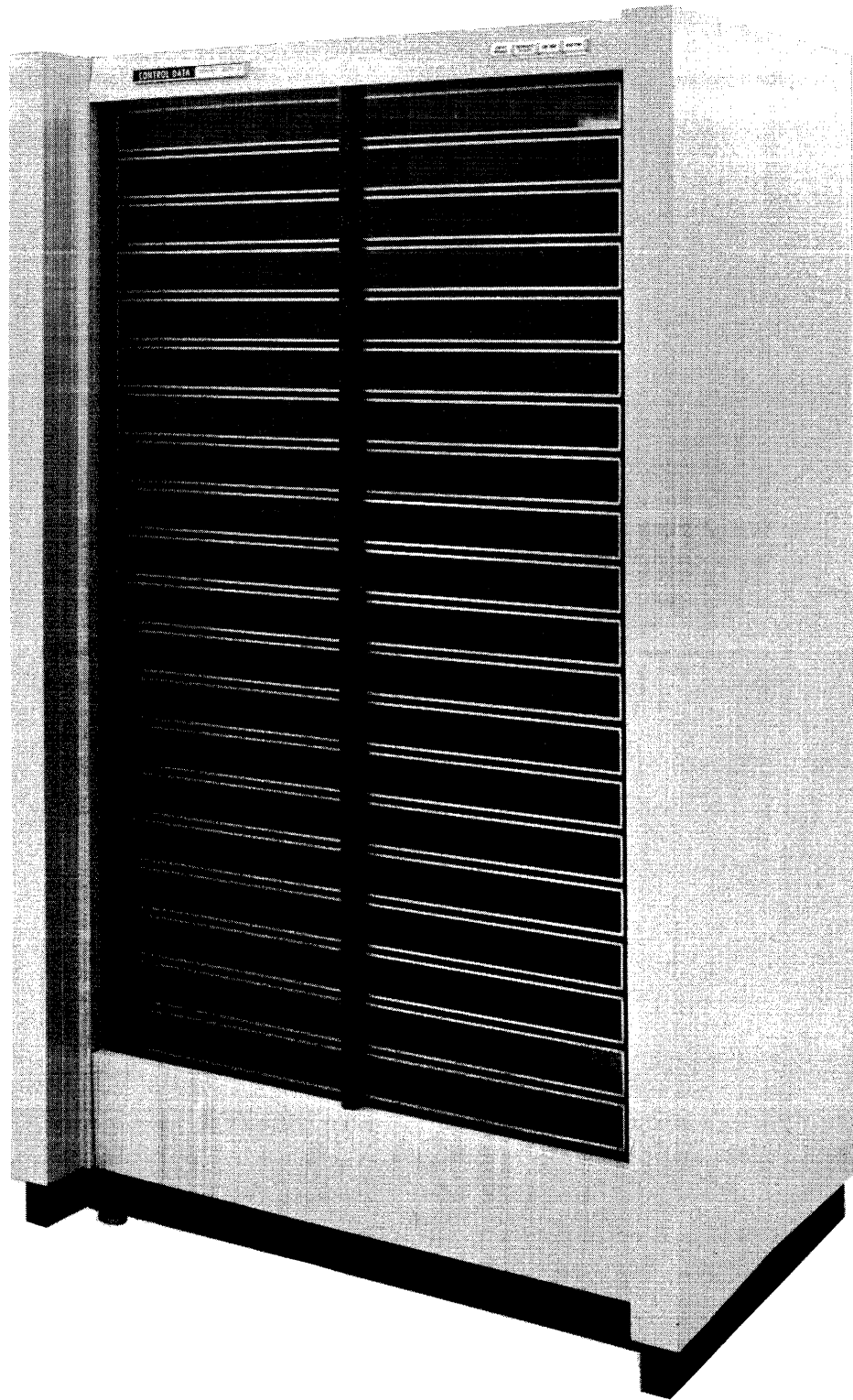

342X MAGNETIC TAPE CONTROLLER

342X-A MAGNETIC TAPE CONTROLLERS

The CONTROL DATA* 342X Magnetic Tape Controllers facilitate high-speed transfer of data between CONTROL DATA 603 and 604 or 606 and 607 Magnetic Tape Transports and standard 3000 Series data channels.** These controllers may be used in any 3000 Series system. (See Figure B-1.)

This section describes the disassembly of data received from the data channel and the assembly of data received from the tape unit. It also describes the Connect, Function, and Status codes and provides pertinent programming information.

FUNCTIONAL DESCRIPTION

The 342X Controller consists of two read/write controls. Each control may be physically attached to one 3000 Series data channel. Each channel, through its associated control, can communicate with any attached tape unit, providing the tape unit is not in use or reserved by the other channel. Both channels may communicate with their respective logically connected tape units simultaneously.

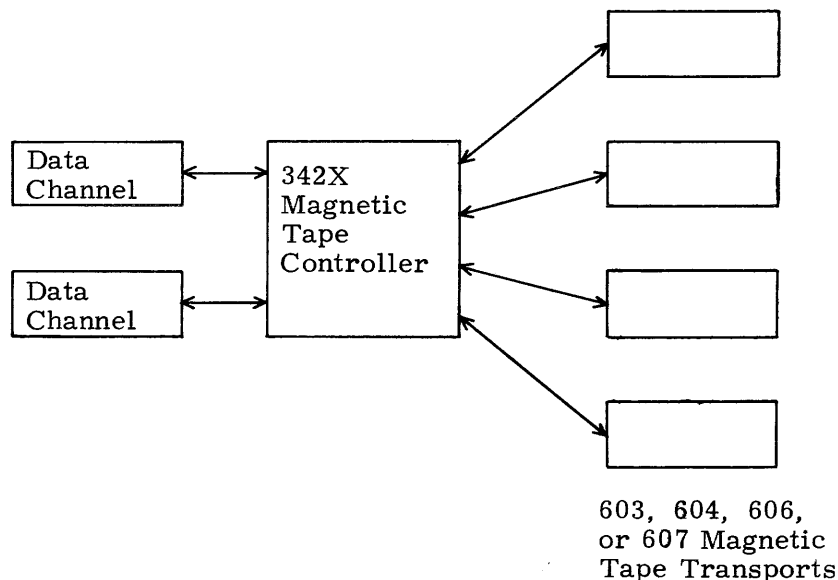

Figure B-1. Typical Configuration

* Registered trademark of Control Data Corporation

** The program must be adapted if 603 and 604 Tape Units are mixed or if 606 and 607 Tape Units are mixed. 603/604 Tape Units may not be mixed with 606/607 Tape Units.

Data channels serving the 342X Controller need not be associated with the same central processor.

The 342X is available with the following options:

- 3421 Two read/write controls to control one to four magnetic tape transports.
- 3422 Two read/write controls to control one to six magnetic tape transports.
- 3423 Two read/write controls to control one to eight magnetic tape transports.

TAPE UNIT DESIGNATION

Each tape unit may have either a unique numerical designation (0 - 7) or be in a Standby condition. These are determined by a Unit Select switch.* The unit cannot be connected when it is on STANDBY. When the numerical designation of a unit is changed, any existing connection and/or reservation is cleared.

ASSEMBLY/DISASSEMBLY

During Write operations, each control receives data from its data channel in 12-bit bytes (i. e., 12 bits of data are received simultaneously on 12 data lines). A tape unit, however, can handle only one 6-bit character at a time. The control, therefore, must disassemble each byte into two characters. The character comprised of the upper 6 bits is transmitted to the tape unit first, followed by the lower 6 bits.

This disassembly is automatically suppressed when a 3100/3200 Character Output instruction (OUTC or OTAC) is executed. In this case, only the lower 6 bits of the data byte are transmitted to the tape unit. The controller ignores the upper 6 bits of the byte.

During Read operations, the tape unit transmits 6-bit characters to the control. The control assembles two successive characters into a single byte for transmission to the data channel. The first character received comprises the upper 6 bits of the byte, and the next character comprises the lower six bits.

This assembly is automatically suppressed when a 3100/3200 Character Input instruction (INPC or INAC) is executed. In this case, each character received from the tape unit is transmitted to the data channel as the lower 6 bits of the byte. The upper 6 bits are zeros.

* This switch is located on the tape unit.

DATA TRANSMISSION

BCD/Binary Modes

Data may be written or read from tape in either BCD (binary coded decimal) or Binary mode. Data is processed in Binary mode following a clearing operation or the selection of Binary mode. It is processed as BCD following the selection of BCD mode. A code of all zeros is considered illegal if the controller is in BCD and 1604 mode.

1604 Mode*

Normally, during a Write operation in BCD mode, the controller automatically changes any character of all "0's" and writes it as 12_8 on tape. When reading a 12_8 from tape in BCD mode, the controller changes it to a character of all "0's". If bit 4** is a "1", bit 5 is complemented during Read and Write operations (bit 4 remains unchanged). This process converts internal BCD codes to external BCD codes when writing and vice versa for reading.

If the computer is running in 1604 mode, the conversion from internal BCD to external BCD does not apply during a Write operation. Similarly, the conversion from external BCD to internal BCD does not apply during a Read operation.

Record/File Formats

The data written on tape as the result of a single Output instruction constitutes a record. If 3100/3200 Character Output instructions are used, a record may be as short as a single character. Adjacent records are separated by a record gap.

A file consists of one or more records. Its length is determined by the programmer. Adjacent files are separated by a file mark which a tape unit writes in response to a function code (Write File Mark).

An End of Record signal is sent to the data channel during a Read operation when a tape unit detects a record gap or a file mark. This signal may be used to terminate a Read.*** The Read operation also terminates when the specified number of words or characters has been read.

* 3600/3800 systems only

** Bit 0 is the rightmost bit of the character to be written on tape.

*** In 3100/3200 systems, the End of Record signal always terminates a Read. In 3400/3600/3800 systems, the use of this signal is optional.

Transfer Rates

Read or Write operations may be performed with 607 Tape Units at any one of three densities: 200 characters/inch, 33 microseconds/frame; 556 characters/inch, 12 microseconds/frame; 800 characters/inch, 8 microseconds/frame. With 606 Tape Units, only low density (200 characters/inch) and high density (556 characters/inch) are available.

The transfer rate of the 604 Tape Unit is one half that of the 607 Tape Unit, and the rate of the 603 Tape Unit is one half that of the 606 Tape Unit.

Density and parity (binary or BCD) formats should be selected or determined prior to a Read or Write operation.

CONNECT

A control must be connected to its data channel before it can respond to either a Select/Function instruction or an Input/Output instruction. The connection is accomplished by the Connect instruction; the Connect code (N00U) is the lower 12 bits of this instruction. The N portion of the code must contain the equipment number of the read/write control. The U portion of the code designates a specific tape unit. Each control examines every Connect code transmitted from its attached data channel. A Reply signal, * indicating a connect, is returned to the data channel from a control if:

- 1) The requested tape unit (U) is Not Busy or is not reserved by the other data channel,
- 2) The N portion of the Connect code matches the setting of the Equipment Number switch on the read/write control,
- 3) The U portion of the Connect code matches the setting of the Unit Select switch on an unreserved tape unit, and
- 4) A transmission parity error is not detected.

If the requested tape unit is Busy or is reserved by another data channel, a Reject signal** is returned to the data channel requesting the connect. Equipment status is also made available to that data channel so that the cause for the reject may be determined.

* A Reply signal tells the central processor to process the next instruction.

** A Reject signal tells the central processor to read the next instruction at the reject jump address contained in the Connect instruction.

If the N portion of the Connect code does not match the setting of the Equipment Number switch, neither a Reject nor a Reply is returned to the channel from the control. Equipment status is not made available to the channel. If the control is already connected, it automatically disconnects. The unit connected through the control does remain reserved for that channel until released, cleared, or given a new unit number. If neither a Reply nor a Reject is returned to the data channel from any of its attached equipments within 100 microseconds, the central processor generates an Internal Reject.

If the U portion of the Connect code does not match the setting of any Unit Select switch, a Reject signal is returned to the data channel.

If a parity error is detected in a Connect code, the device does not connect* and neither a Reject nor a Reply is returned to the data channel. Instead, the Parity Error indicator of each equipment detecting the error lights. In this equipment, a red indicator in the Equipment Number switch lights. These parity error conditions must be cleared by either a Channel Clear or a Master Clear prior to a new connect attempt.

Tape units physically attached to the 342X Controller may be unconnected and unreserved, connected to a data channel, or reserved by a data channel.

Unconnected and unreserved units may be connected by any channel serving the controller. Once a channel is connected to a particular unit (i. e., a communication path is established), that unit remains reserved for that channel even though the channel disconnects the unit by connecting (or attempting to connect) to another unit or equipment. Once a unit is reserved by a channel, no other channel has access to the unit. Since it is possible for one channel to reserve all tape units, care must be taken to release those units not essential to the current program. If more than one channel attempts to connect simultaneously, a scanner determines the channel to be connected.

FUNCTION

Function codes are used to prepare a connected control and/or unit for an Input/Output operation. (They have no effect on unconnected controls or units.) They comprise the lower 12 bits of a Select/Function** instruction and are transmitted to the control on the 12 data lines. Table B-1 is a complete list of function codes. A detailed description of each code follows the table.

* If the device is connected, it automatically disconnects.

** Select in 3100/3200 systems, Function in 3400/3600/3800 systems.

There are three classifications of codes: operating, * nonoperating, and interrupts. Operating codes cause tape motion. They include Rewind, Rewind Unload, Backspace, Search Forward/Backward to File Mark, Write File Mark, and Skip Bad Spot. Nonoperating codes include Release, Binary, Coded, Densities, Clear, and Set and Clear Reverse Read.

The control accepts operating codes only when the tape is completely at rest. Thus, operating codes are not accepted during a Read or a Write operation or while an operating code is being executed. Likewise, a new Read or Write operation cannot be initiated while an operating code is being executed.

Nonoperating codes are accepted prior to a Read or Write operation, following the conclusion of a Write, and following the receipt of an End of Record signal during a Read. Thus, they are accepted even though an operating code is being executed.

Interrupt codes are never rejected.

A control examines only one code at a time. First, it checks for parity errors. If none are found, it returns a Reply if the requested function can be performed** or a Reject if it cannot be performed. Interrupt codes always cause a Reply to be returned to the channel.

If a parity error is detected, the requested function is not performed, a Parity Error signal is returned to the data channel, and a red indicator in the Equipment Number switch lights. Since neither a Reply nor a Reject is returned to the data channel, the central processor generates an Internal Reject after a wait of 100 microseconds.

These parity error indications must be cleared by either a Channel Clear or a Master Clear. The equipment must then be reconnected before a new function code is examined by the controller.

INTERRUPTS

Interrupts provide a means for attaining optimum utilization of a system's capabilities. Basically, the system interrupts (halts) the main program and initiates an interrupt processing program*** when an Interrupt signal is detected by the processor.

* Operating codes cause the control to become Busy.

** Certain illegal function codes cause a Reply to be returned. However, in these cases no action follows.

*** See the system reference manual for addresses pertinent to interrupt processing.

The 342X Tape Unit can be programmed to send an Interrupt signal to the processor when any one of the conditions specified by the three Interrupts* occurs.

A Select Interrupt code permits the controller to consider as a group** several of the operating conditions which may occur in an attached unit. If a specific interrupt has been selected and if at least one of the conditions specified by it occurs in the connected unit, the controller sends an Interrupt signal to the processor. If the interrupt system in the processor has been set to recognize the interrupt, the main program is interrupted and control is transferred to a specific program address. Status sensing and followup operations may follow. If desired, control may be returned to the main program by a Jump instruction located at the close of the interrupt processing program.

If the processor's interrupt system has not been enabled, it is still possible to sense for these conditions via Sense Status and Copy Status instructions written into the main program.

Regardless of which of the above actions is followed, the Interrupt signal remains up until cleared by reselecting the interrupt, selecting release, or master clearing the system. The Interrupt signal is transmitted on the equipment's interrupt line via the data channel currently connected to or reserving the equipment.

The eight-position (0-7) Equipment Number switch determines the number of the line on which the Interrupt signal is transmitted. For example, if the Equipment Number switch is set to 5, all Interrupt signals coming from this control are transmitted on interrupt line 5. Since each equipment attached to a data channel has a unique equipment number, each uses a different interrupt line. A Channel Product Register Jump instruction*** or a Copy Status instruction**** can identify the equipment sending the Interrupt signal by inspecting the interrupt lines.

STATUS

Status codes permit the monitoring of several control/unit operating conditions. These codes are made available to the data channel over 12 status lines following a connect or a rejected connect attempt. Sense Status and Copy Status instructions make these codes available to the central processor.

* See explanation of function codes following Table B-1 for a list of these conditions.

** See description of function codes following Table B-1 for a breakdown of the three possible groups.

*** 3600/3800 systems

**** 3100/3200/3400 systems

See Table B-1 for a complete list of these codes. If two or more conditions exist simultaneously, the Status Response code is the sum of the individual codes. A detailed description of each code follows the table.

PARITY CHECKING

Transmission Parity Checking

Connect codes, function codes, and data are transmitted between the data channel and the controller in odd parity (i. e., the number of "1" bits transmitted must be odd). If the number of "1" bits in a data byte is even, a "1" is transmitted on the parity line to make the total number of "1" bits odd.* If the number of "1" bits in the data byte is odd, a "1" is not transmitted on the parity line.

A transmission parity error exists if the total number of "1" bits transmitted on the 12 data lines plus the parity line is even, indicating that a bit has been lost or picked up.

Parity Error in a Connect Code: If a parity error is detected in a Connect code, the device does not connect** and neither a Reject nor a Reply is returned to the data channel. Instead, a red indicator in the Equipment Number switch of each equipment detecting the error lights. These parity error conditions must be cleared by either a Channel Clear or a Master Clear prior to a new connect attempt.

Parity Error in a Function Code: If a parity error is detected, the requested function is not performed, a Parity Error signal is returned to the data channel, and a red indicator in the Equipment Number switch lights. Since neither a Reject nor a Reply is returned to the data channel, the central processor generates an Internal Reject after a wait of 100 microseconds. These parity error indications must be cleared by a Channel Clear or a Master Clear.*** The equipment must then be reconnected before a new function code can be examined by the controller.

* Do not confuse this line with the parity error line.

** If the device is connected, it automatically disconnects.

*** Though operations may continue normally, the validity of a new function code and/or data prior to a Master Clear or Channel Clear is questionable.

Parity Error in Output Data: If a transmission parity error is detected by the control during a Write operation, the control lights a red indicator in its Equipment Number switch and sends both a Reply and a Parity Error signal to the data channel. The data is written on tape. All operations continue* unless appropriate programming steps have been taken to sense for the Parity Error signal and rewrite the data. These parity error indications must be cleared by either a Channel Clear or a Master Clear. The equipment must then be reconnected and the appropriate functions reselected prior to the new output.

Parity Errors in Input Data: Transmission parity errors may be detected by the data channel on data received from the equipment. If a parity error is detected, a parity error bit in the data channel is set and a Parity Error indicator on either the channel or console lights. The faulty data is entered into either core storage or the A register. All operations continue** unless appropriate programming steps have been taken to sense for the set bit and reread the data. These parity error indications may be cleared by a Channel Clear or a Master Clear issued by any 3000 Series system and by a new Read or Write from a 3100/3200 system. Following a Channel Clear or a Master Clear, the equipment must be reconnected and the appropriate functions reselected prior to a new input.

Input/Output Parity Error Bit in the Data Channel: The input/output parity error bit is set whenever a transmission parity error is detected. If the error is detected by the external equipment, the bit is set by the Parity Error signal.

In 3400/3600/3800 systems, if the interrupt system is active, an Interrupt signal is generated when this bit sets. If the interrupt system has not been set to detect the setting of this bit, the bit may be sensed to detect parity error conditions.

In 3100/3200 systems, the bit must be sensed if transmission parity error conditions are to be detected by the central processor.

Refer to the appropriate system reference manual for more information on the input/output parity error bit.

* The validity of the data received from this point until a Channel Clear or Master Clear is questionable.

** The validity of the data received from this point until the indicators are cleared is questionable.

Equipment Parity Checking

Each character, whether BCD or binary, transmitted between a control and a unit is checked for correct parity. For BCD characters, correct parity is even, and for binary characters, it is odd. During a Write operation, the control adds the correct parity bit to each character and relays it to the tape unit. Approximately 2 or 3 milliseconds* after writing, a vertical parity error check is made. This time interval is used to check-read the tape and transmit the data back to the control. At the conclusion of a record, a record check character is written. This character is used for longitudinal parity checking. During a Read, vertical and longitudinal parity checks are made by the control when the appropriate data is received.

Both vertical and longitudinal parity errors are considered equipment parity errors.

Vertical Parity Error Checking: A vertical (transverse) parity error exists when the number of "1" bits on the six data lines plus the parity line is not correct. The number of "1" bits must be odd for binary data and even for BCD data.

If a vertical parity error is detected, the Vertical Parity Error indicator on the control lights and a Parity Error signal is placed on the appropriate status line. These parity error indications may be cleared by a new Read, Write, Channel Clear, or Master Clear. If selected, this condition may cause an Abnormal End of Operation interrupt.

Longitudinal Parity Error Checking: Longitudinally (lengthwise), the tape is divided into seven tracks. Six of these are used to store data, and the seventh holds the vertical parity bits. When a record is written on or read from tape, the total number of "1" bits in each track must be even. If the number of "1" bits in any track of a record is odd, a "1" is written in that track as a part of the record check character. During a Read operation, a longitudinal parity error exists if the record check character is not as anticipated.

If a longitudinal parity error is detected, the appropriate Longitudinal Parity Error indicator(s) remains lighted,** and a Parity Error signal is placed on the appropriate status line. These parity error indications may be cleared by a new Read, Write, Channel Clear, or Master Clear. If desired, this condition may cause an Abnormal End of Operation interrupt.

* Two milliseconds for 606/607 Tape Units, 3 milliseconds for 603/604 Tape Units

** These indicators may flash on and off during normal operations. Such flashings are to be ignored.

CODES

All connections and operations are controlled by 12-bit Connect and function codes in conjunction with the appropriate Connect or Select/Function instruction. Status codes are constantly available while the equipment is connected. In all discussions of codes, bit 0 is in the rightmost position (see Table B-1).

TABLE B-1. CONNECT, FUNCTION, AND STATUS CODES

CONNECT	
Connect Tape Unit	N00U*
FUNCTION	
Release	0000
Binary	0001
Coded	0002
556 BPI	0003
200 BPI	0004
Clear	0005
800 BPI**	0006
Rewind	0010
Rewind Unload	0011
Backspace	0012
Search Forward to File Mark	0013
Search Backward to File Mark	0014
Write File Mark	0015
Skip Bad Spot	0016
Clear Reverse Read**	0040
Set Reverse Read***	0041
Select Interrupt on Ready and Not Busy	0020
Release Interrupt on Ready and Not Busy	0021
Select Interrupt on End of Operation	0022
Release Interrupt on End of Operation	0023

* N = equipment number of read/write control, U = unit number of a specific tape unit.

** 604 and 607 Tape Units only

*** If a Backspace operation is executed when Reverse Read is set, tape is moved in a forward direction. 604 and 607 Tape Units only

TABLE B-1. CONNECT, FUNCTION, AND STATUS CODES (Cont'd)

FUNCTION (Cont'd)	
Select Interrupt on Abnormal End of Operation	0024
Release Interrupt on Abnormal End of Operation	0025
STATUS	
Ready	XXX1
Channel and/or Read/Write Control and/or Unit Busy	XXX2
Write Enable	XXX4
File Mark	XX1X
Load Point	XX2X
End of Tape	XX4X
Density ("1" in bit 6 indicates 556 BPI, "0" in bits 6 and 7 indicates 200 BPI)	X1XX
Density ("1" in bit 7 indicates 800 BPI)	X2XX
Lost Data	X4XX
End of Operation	1XXX
Vertical or Longitudinal Parity Error	2XXX
Reserved (by other channel)	4XXX

CONNECT CODE

Connect Tape Unit (N00U)

This code connects the desired unit. N is the equipment number of the read/write control. U is the unit number of a specific tape unit.

FUNCTION CODES

Release (0000)

This code clears both the existing unit connection and the channel reserve for the unit. It does not clear reserve logic on any other tape units reserved by that data channel.

Binary (0001)

This code causes all data to be written/read in binary notation.

Coded (0002)

This code causes all data to be written/read in BCD notation.

556 BPI (0003)

This code causes all data to be written/read at 556 bits per inch density.

200 BPI (0004)

This code causes all data to be written/read at 200 bits per inch density.

Clear (0005)

This code clears all tape unit reservations made by the data channel as well as the existing unit connection. It permits other channels to gain access to these units.

*800 BPI (0006)**

This code causes all information to be written/read at 800 bits per inch density.

Rewind (0010)

This code rewinds tape at high speed (400 inches per second) to load point. It has no effect when the tape is at load point.

Rewind Unload (0011)

This code rewinds tape at high speed to load point. It then rewinds tape slowly until all of the tape is on the supply reel. All further operations with this tape unit are locked out until the tape is manually reloaded.

Backspace (0012)

This code backsplaces the tape one record or until load point is detected. If the tape is at load point and if fewer than two records precede the load point, it unloads the tape. If Reverse Read is selected, * a Backspace selection initiates forward tape motion.

* 604 and 607 Tape Units only

Search Forward to File Mark (0013)

This code advances the tape until a file mark is detected. If no file marks are detected, tape motion continues until all the tape is on the takeup reel.

Search Backward to File Mark (0014)

This code backspaces tape until a file mark or load point is detected. If the tape is at load point, it backspaces the tape until either a file mark is detected or the tape is unloaded.

Write File Mark (0015)

This code advances the tape at least 6 inches, then writes a 17_8 file mark followed by a 17_8 check character. Both are written in even vertical parity. This file mark is used with both BCD and Binary modes. Writing a file mark does not affect the selected format.

Skip Bad Spot (0016)

This code erases at least 4 inches of tape. Vertical and longitudinal parity checks are made to insure complete erasure.

*Clear Reverse Read (0040)**

This code clears the condition set by the Set Reverse Read code.

*Set Reverse Read (0041)**

This code must precede a Reverse Read operation (see Reverse Read section).

Select Interrupt on Ready and Not Busy (0020)

This code causes the controller to send an Interrupt signal to the processor when the tape unit is in a Ready and Not Busy condition (i. e., when power is applied, the unit is under computer control, and all tape motion has ceased). Once up, the Interrupt signal can be cleared by selecting release (0021) or by clearing the control.

* 604 and 607 Tape Units only

Release Interrupt on Ready and Not Busy (0021)

This code clears an Interrupt on Ready and Not Busy selection and the Interrupt signal if it is up.

Select Interrupt on End of Operation (0022)

This code causes the controller to send the Interrupt signal to the processor when the data channel terminates a Read or Write operation, when a tape unit senses the end of a record during a Read operation, or upon completion of an operating function. Once up, the Interrupt signal remains up until cleared by reselecting the interrupt (0022), selecting release (0023), or clearing the control.

During a chaining operation, * interrupt does not occur until the data channel is Not Busy (i. e. , until the last record has been written/read in the chaining operation).

Release Interrupt on End of Operation (0023)

This code clears an Interrupt on End of Operation selection and the Interrupt signal if it is up.

Select Interrupt on Abnormal End of Operation (0024)

This code causes the controller to send an Interrupt signal to the processor after an abnormal condition occurs. These abnormal conditions are End of Tape, File Mark,** Load Point,** Vertical Parity Error, Longitudinal Parity Error, Lost Data, parity error during a Skip Bad Spot operation, and connected tape unit becoming Not Ready.

In all but the last case, the interrupt occurs when one or more of these conditions are encountered and when an end of record check character is written/read by the tape unit. In the case of interrupt on connected tape unit becoming Not Ready, interrupt occurs immediately when the connected tape unit goes from a Ready to a Not Ready condition (e. g. , if the power is turned off on the tape unit). Interrupt on connected tape unit becoming Not Ready does not occur during a Connect operation or when a Release code (0000) is executed.

* 3400/3600/3800 systems only

** Common to Interrupt on End of Operation and Interrupt on Abnormal End of Operation

A new Read/Write operation cannot start until the Interrupt signal is cleared. Once up, the Interrupt signal can be cleared by reselecting the interrupt (0024), selecting release (0025), or a Master Clear.

Release Interrupt on Abnormal End of Operation (0025)

This code clears an Interrupt on Abnormal End of Operation selection and the Interrupt signal if it is up.

STATUS CODES

Ready (XXX1)

Bit 0 is set when the tape unit is in a Ready condition (i. e., power is applied and the Ready switch is lighted). (The tape controller can operate the unit.)

Channel and/or Read/Write Control and/or Unit Busy (XXX2)

If the tape unit is Ready, bit 1 is set when the channel is transmitting or receiving data during an Input/Output operation. It is also set if the unit is Ready and tape motion is initiated by an operating function code. In these two cases, it remains set until 5 milliseconds after tape motion stops. Bit 1 is cleared approximately 5 milliseconds after either detection of lost data or an Abnormal End of Operation Interrupt signal and cannot be reset until these conditions cease to exist. Bit 1 cannot be set if bit 0 is clear.

Write Enable (XXX4)

Bit 2 is set when the file protection ring is on the tape reel. When this ring is present it is possible to read from and write on the tape. When this ring is absent it is possible to read from but not write on the tape.

File Mark (XX1X)

Bit 3 is set whenever a file mark is read.* It remains set until a new operating function, a Read/Write operation, or a clearing operation is initiated or until a new unit is connected or the same unit is reconnected.

* If a file mark is detected during a Search Backward to File Mark and this is followed by a Read forward, the file mark is the first record read.

Load Point (XX2X)

Bit 4 is set when the tape is at load point. It is cleared when the tape moves off the load point.

End of Tape (XX4X)

Bit 5 is set when the end of tape marker is detected. It is cleared when the end of tape marker is sensed during Rewind or Reverse Read.*

Density (X1XX)

Density (X2XX)

	<u>Bit 7</u>	<u>Bit 6</u>
200 BPI	0	0
556 BPI	0	1
800 BPI	1	0

Lost Data (X4XX)

Bit 8 is set when the control determines that data may have been lost in transmission. Tape motion stops when bit 8 is set and cannot be restarted until this bit is cleared by a new Connect or function code or a Master Clear (see Programming Considerations).

When operating from a 160/160-A Computer via a 3681 Data Channel Converter, lost data is also detected if the read or write selection in the 3681 Converter is not cleared immediately after a Read or Write operation is completed. As long as a Write signal is present and the Data signal is not present at the required time, the controller assumes that a data transmission loss has occurred and a Lost Data signal is sent. If the Read signal is present but data is not being accepted by the channel, lost data also occurs. It is, therefore, necessary to clear the read or write selection in the 3681 Converter immediately after a Read or Write operation is completed to prevent the Lost Data signal from being sent abnormally. If the Lost Data signal is present, it must be cleared if Read or Write operations are to continue.

* Reverse Read is possible with 604 and 607 Tape Units only.

End of Operation (1XXX)

Bit 9 is set when the data terminates a Read or Write operation, when a tape unit senses the end of a record during a Read operation, or upon completion of an operating function. It remains up until a new Read/Write operation, operating function, or clearing operation is initiated.

Vertical or Longitudinal Parity Error (2XXX)

Bit 10 is set following detection of either a vertical or longitudinal parity error or reading a file mark while in Binary mode. It is cleared by initiating a new Read, Write, or clearing operation. If this bit is set during a chaining operation* due to detection of a vertical parity error or due to detection of a longitudinal parity error, it cannot be cleared until the chaining operation terminates.

Reserved (by other channel) (4XXX)

Bit 11 is set when a channel attempts to connect to a reserved unit. It is cleared by issuing a Release or Clear code or clearing the equipment.

* 3400/3600/3800 systems only

SWITCHES AND INDICATORS

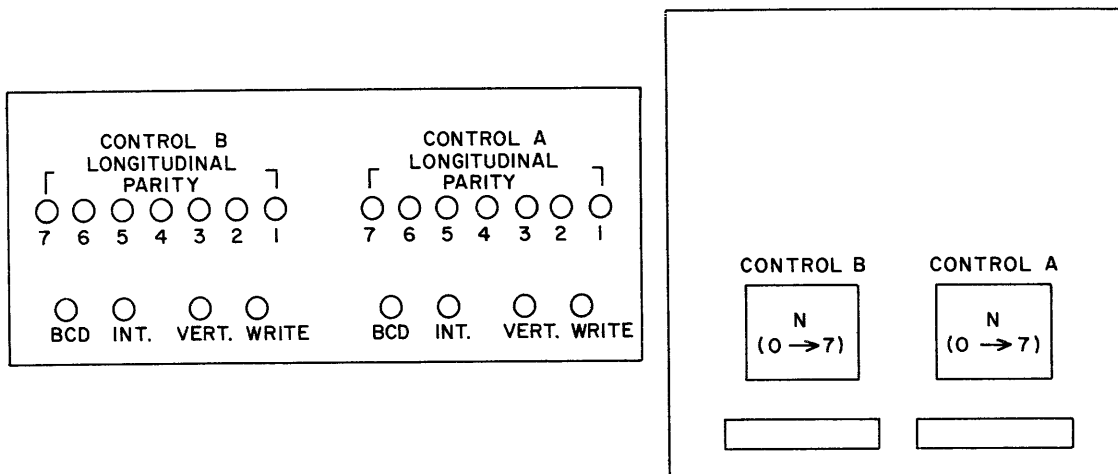

Figure B-2. 342X Equipment Number Switch and Indicator Panel*

EQUIPMENT NUMBER SWITCH

An eight-position Equipment Number switch is associated with each read/write control. The setting of this switch (0 - 7) designates the control and corresponds to the N portion of the Connect code. It also determines the number of the interrupt transmission line that the equipment uses.

When a control is connected to a tape unit, a white indicator in the switch lights. This indicator also lights when a connection cannot be made because the tape unit is reserved by another channel.

If a transmission parity error is detected during a Connect, Function, Read, or Write operation, a red indicator in the Equipment Number switch lights.

LONGITUDINAL PARITY INDICATORS

Seven LONGITUDINAL PARITY indicators are associated with each control. At the end of an operation involving longitudinal parity checking, none of these indicators should remain lighted. If one or more remains lighted, a longitudinal parity error has occurred. The indicators remain lighted until a new record is begun.

* Located on the 342X Controller logic chassis

WRITE INDICATOR

The WRITE indicator lights during Write and Write File Mark operations. The WRITE indicator is cleared on termination of the Write operation.

VERT. (VERTICAL) PARITY INDICATOR

A Vertical Parity Error indicator lights if a vertical parity error is detected during a Read or Write operation. This indicator remains lighted until cleared by a new Read, Write, Channel Clear, or Master Clear.

INT. (INTERRUPT) INDICATOR

This indicator lights when an interrupt occurs. This indicator remains lighted until the Interrupt signal drops.

BCD INDICATOR

This indicator lights when BCD mode is selected or a file mark is being written on tape.

OPERATION AND PROGRAMMING

CLEARING THE CONTROLLER

Prior to the initial use of the tape controller, the system should be cleared. There are five possible ways of clearing the controller:

1) Clear Channel* (100 microseconds)

This instruction:

- a) Clears all activity in the data channel.
- b) Clears the present connection control N may have with a tape unit.
- c) Releases all tapes (i. e., clears reserve logic) which control N may have reserved.
- d) Performs a Master Clear on control N read, write, and function logic. No status signals are available to the data channel after executing this instruction.

* See the individual processor instructions.

2) Clear (0005) (2 microseconds)

This function code:

- a) Clears the present connection control N may have with a tape unit. Control N remains connected in the sense that status signals are still available for the data channel.
- b) Releases all tape units control N may have reserved.

3) Release (0000)

This function code clears only the connection and the reservation for the connected tape unit. It does not clear the reservations for any other tape units.

4) Power On Master Clear

When power is applied to the 342X Controller, all tape units connected and reserved by all controls are cleared. Logic in all controls is also cleared. No status signals are available to the data channel after power is applied.

5) External Master Clear

This clears all tape units connected and reserved by all controls. It also clears the logic in all controls. No status signals are available to the data channel after executing this operation.

The Clear and Release codes can only be used after a control is connected to a tape unit.

All clear operations (except the Release code) place the 342X Controller in binary format.

REVERSE READ (604 AND 607 TAPE UNITS ONLY)

The 342X Controller can read information in a reverse direction from tape. Six-bit frames are read from tape, assembled into 12-bit bytes, * and sent to the data channel. When a word is read in a reverse direction from tape and entered into storage, it is identical to the word which was initially written on the tape from storage. There is no change made in the final order of the bits during a Reverse Read operation.

To initiate a Reverse Read operation (assuming format, etc, have already been selected and all tape motion has stopped), a 342X Controller must first receive function code 0041 (Set Reverse Read). When the Read instruction is executed in the processor, the

* This assembly may be suppressed. See Assembly/Disassembly.

Reverse Read operation begins (i. e. , data is available to the data channel). A Reverse Assembly signal is sent to the data channel from the 342X Controller to indicate that the 12-bit bytes should be assembled into a word in reverse order.

Data transfer continues until the word count in the control word equals zero* or until $m^1 = m^2$.** Tape motion continues in a reverse direction and stops at the gap between the current record and the record check character of the next record (unless chaining or nonstop read has been selected).

Vertical and longitudinal parity checking occur as in a normal Read operation, except if the first frame read is a record check character, no vertical parity check is made on that character. Vertical parity checking is performed on the remaining frames.

If a Reverse Read is attempted from load point, there is no tape motion. The Read operation hangs up.

Parity errors and interrupts may be handled as if the operation were a normal Read. An End of Record signal is returned to the data channel when a record gap is reached. Chaining and nonstop Read operations are also handled as if the operation were a normal Read.

Function code 0040 (Clear Reverse Read) should be issued when the Reverse Read operation terminates.

PROGRAMMING EXAMPLE***

Start program at address 10000.

<u>Storage Address</u>	<u>Contents of Address</u>	
10000	745-----00-----	CLEAR CHANNEL (Channel 0, Comm. Mod. 0)
10001	7402000000--4000	CONNECT Channel 0. Comm. Mod. 0 to Tape 0
10002	7411-----00-----	COPY STATUS on Tape 0, Load in B ¹
10003	BIT SENSE	Sense bit 2 of Status code in B ¹ for Write Enable
10004	76000000	HALT
10005	BIT SENSE	Sense bit 0 of Status code in B ¹ for Ready
10006	76000000	HALT

* 3400/3600/3800 systems

** 3100/3200 systems

*** 3600 system

PROGRAMMING EXAMPLE (Cont'd)

<u>Storage Address</u>	<u>Contents of Address</u>	
10007	7411000400--0002	SET BCD MODE
10010	7411000400--0003	SET 556 BPI
10011	74310004000030000	WRITE (Contains control word address)
10012	745-----01-----	CLEAR CHANNEL (Channel 1, Comm. Mod. 01)
10013	7402000001--5003	CONNECT Channel 1 Comm. Mod. 0 to Tape 3
10014	74431---01-----	COPY STATUS on Tape 3, Load in B ³
10015	BIT SENSE	Sense bit 0 of Status code in B ³ for Ready
10016	76000000	HALT
10017	7411001601--0002	SET BCD MODE
10020	7411001601--0003	SET 556 BPI
10021	7421001601030001	READ (Contains control word address)
Continue with main program. Tapes 0 and 3 remain connected.		
20000	76000000	HALT
30000	10000100--000100	CONTROL WORD (Write operation)
30001	10000300--000200	CONTROL WORD (Read operation)
30004	7413000400-0010	REWIND Tape 0
30005	7413000501--0010	REWIND Tape 3
30006	76000000	HALT (End of Program)

Sixty-four (100₈) words are stored in storage module 0 at locations 00100-00177. Write them on tape 0, bank 0 (556 BPI BCD). Tape 0 is at load point. Also, a record of 300₈ words is stored on tape 3 (556 BPI BCD). Store the record in storage module 0, starting at location 00200. Tape 3 is also at load point. Rewind both tapes to load point sometime after the Write and Read operations are complete. Halt the program if any of the above operations cannot be executed.

Do a console Master Clear. This clears all registers needed in this example. The program starts at address 10000 with a 48-bit Clear Channel instruction. This clears all equipment connected to communication module 0, data channel 0. The Connect instruction (address 10001) connects tape unit 0 to communication module 0, data channel 0. (The switch on control A on the tape controller is set to accept equipment 4.) The Copy Status instruction (address 10002) loads the 12-bit Status code into B¹. A Bit Sense instruction (address 10003) senses bit 2 of the Status code for a Write Enable. (If this signal is not present when attempting a Write operation, the protective ring is not present on the tape reel.) Another Bit Sense instruction (address 10005) senses bit 0 of the Status code for a Ready signal. The program halts if either a Write Enable or Ready signal is not present.

The two Function instructions (addresses 10007 and 10010) set the control A logic in the tape controller to BCD mode and 556 BPI. When the computer executes the Write instruction (address 10011), it sends the 18-bit control word address to the communication module. The 3602 reads the 48-bit control word from address 30000 and initiates output from storage module 0 to tape 0.

The main program continues at address 10012 when the control word address has been transmitted to the communication module. The same procedure as above follows for tape 3, except that the operation is a Read from tape 3 on data channel 1, and there is no need to sense for a Write Enable. The Set BCD Mode instruction is necessary since the Clear Channel instruction set control B logic in the tape controller to the Binary mode. The control B switch on the 342X controller is set to accept equipment 5.

When the computer reaches address 10021, it executes the Read instruction and sends the 18-bit control word address to the communication module. Then the communication module begins the Read operation, and the main program continues.

When the program reaches address 30004, it sends the 12-bit Rewind instruction (0010) to tape 0. If tape 0 is Busy (indicated by a Reject signal in this case), the program halts at this step and executes a reject jump to address 30004. When the Reply is returned (indicating tape 0 is in a Rewind condition), the program continues at address 30005. When the instruction to rewind tape 3 is completed, the program stops at address 30006.

PROGRAMMING CONSIDERATIONS

Suppress Assembly/Disassembly

If data is to be assembled from a tape that was recorded in Suppress Assembly/Disassembly mode, * assembly difficulties may be encountered. The problem is that in Suppress Assembly/Disassembly mode, an odd number of frames may be written on the tape. If this occurs and the tape is read forward, the controller automatically fills in bits 0 through 5 of the last input byte with "0's". If an odd number of frames are written and a Reverse Read is attempted, the inverted assembly is one frame out of order, and bits 6 through 11 of the last data channel word are filled in with "0's".

* 3100/3200 system

Lost Data

The Lost Data condition occurs in two cases:

- 1) When the data channel cannot supply or accept data at the rate required by the tape unit due to competition from other devices for access to storage.
- 2) When certain malfunctions occur in the data channel.

A Lost Data condition causes data transfer to stop, stops tape motion (at the next record gap), and sets the lost data status bit. A new Read or Write operation cannot begin until the Lost Data condition is cleared by a Master Clear, Clear Channel instruction, or new Connect or Function operation. In most cases, the Lost Data condition leaves the data channel active (i. e., the Read or Write operation remains uncompleted). Thus, a new Connect or Function operation cannot be initiated until the channel active condition is cleared by a Master Clear, Clear Channel instruction, or Stop Channel Activity function code.*

* 3600/3800 systems only

SECTION C

3228-A/3229-A MAGNETIC TAPE CONTROLLERS

CONTENTS

Functional Description	C-1	Transmission Parity Checking	C-8
Tape Unit Designation	C-2	Equipment Parity Checking	C-9
Assembly/Disassembly	C-2	Codes	C-11
Data Transmission	C-3	Connect Code	C-12
BCD/Binary Modes	C-3	Function Codes	C-12
1604 Mode	C-3	Status Codes	C-16
Record/File Formats	C-3	Switches and Indicators	C-18
Transfer Rates	C-4	Operation and Programming	C-19
Connect	C-4	Clearing the Controller	C-19
Function	C-5	Reverse Read (604 and 607 Tape Units Only)	C-20
Interrupts	C-6	Programming Considerations	C-21
Status	C-7	Suppress Assembly/ Disassembly	C-21
Parity Checking	C-8	Lost Data	C-22

FIGURES

C-1	Typical Configuration	C-1	C-2	322X Equipment Number Switch and Indicator Panel	C-18
-----	-----------------------	-----	-----	---	------

TABLES

C-1	Connect, Function, and Status Codes	C-11
-----	--	------

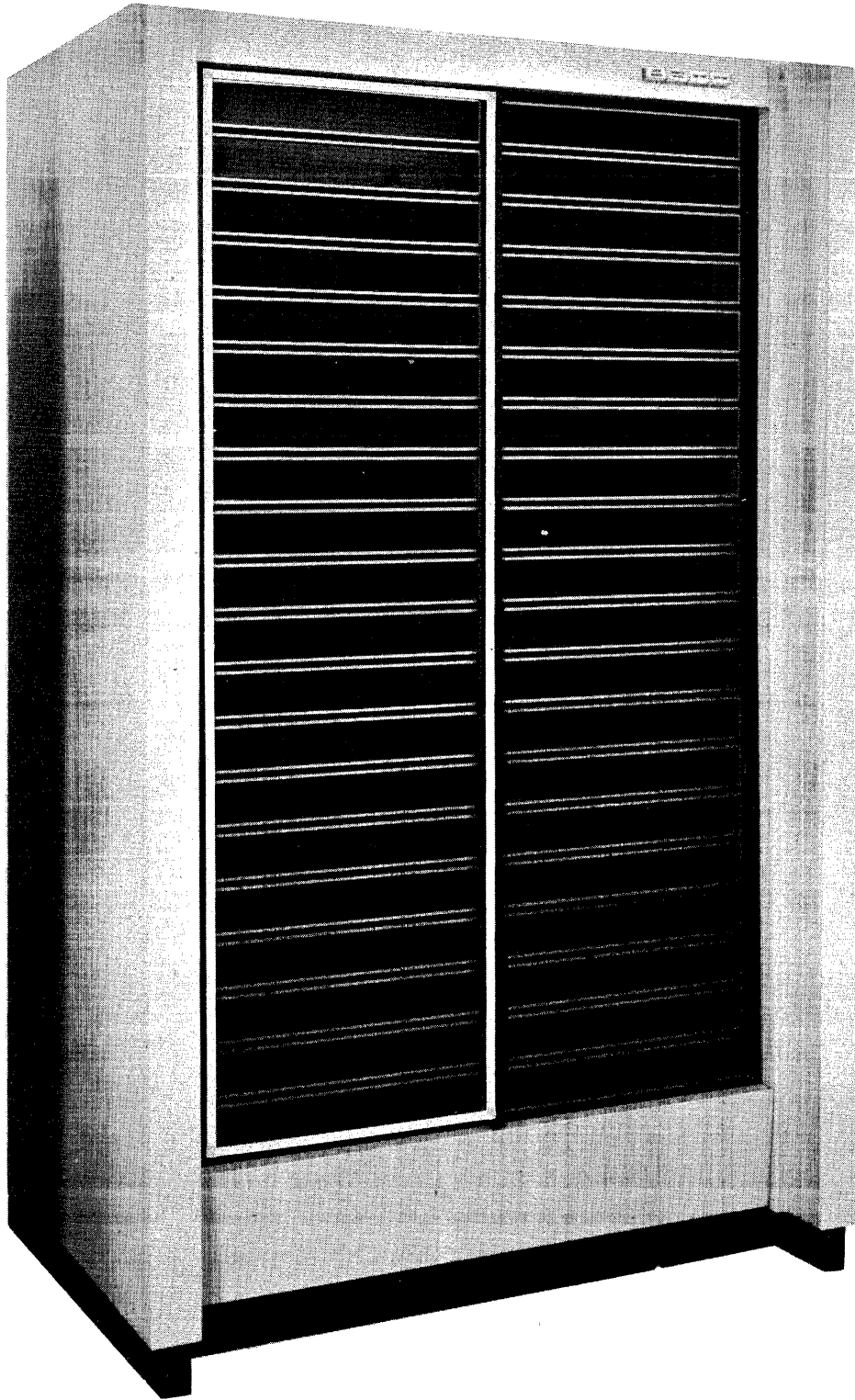

322X MAGNETIC TAPE CONTROLLER

3228-A/3229-A MAGNETIC TAPE CONTROLLERS

The CONTROL DATA* 3228/3229 Magnetic Tape Controllers facilitate high-speed transfer of data between CONTROL DATA 603 and 604 or 606 and 607 Magnetic Tape Transports and a standard 3000 Series data channel. These controllers may be used in any 3000 Series system. (See Figure C-1.)

This section describes the disassembly of data received from the data channel and the assembly of data received from a tape unit. It also describes the Connect, Function, and Status codes and provides pertinent programming information.

FUNCTIONAL DESCRIPTION

The 322X Controller has one read/write control. The control may be physically attached to one 3000 Series data channel. This channel, through its control, can communicate with any attached tape unit.

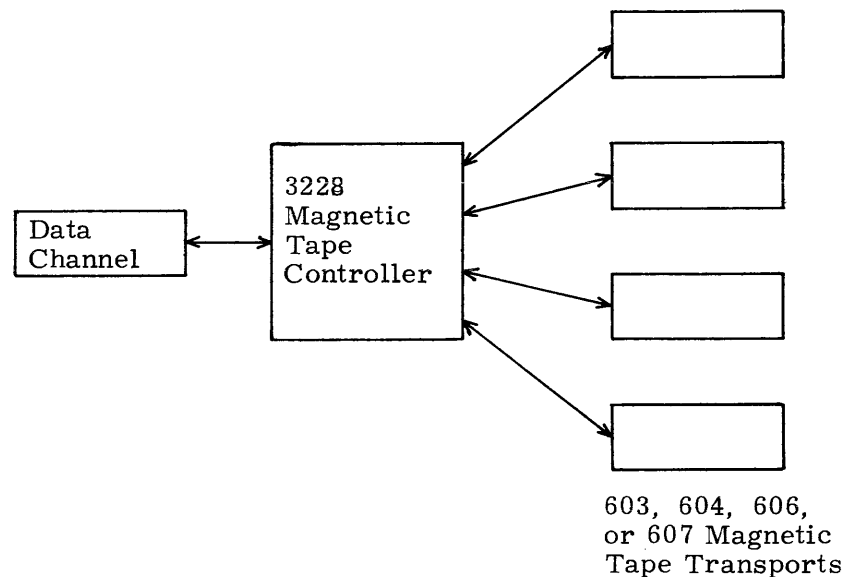

Figure C-1. Typical Configuration

*Registered trademark of Control Data Corporation

**The program must be adapted if 603 and 604 Tape Units are mixed or if 606 and 607 Tape Units are mixed. 603/604 Tape Units may not be mixed with 606/607 Tape Units.

The 3228 Controller can control one to four magnetic tape transports (tape units); the 3229 Controller can control one to eight tape units.

TAPE UNIT DESIGNATION

Each tape unit must have a unique numerical designation (0 - 7) that is determined by a Unit Select switch.* When the numerical designation of a unit is changed, any existing connection and/or reservation is cleared.

ASSEMBLY/DISASSEMBLY

During Write operations, each control receives data from its data channel in 12-bit bytes (i. e., 12 bits of data are received simultaneously on 12 data lines). A tape unit, however, can handle only one 6-bit character at a time. The control, therefore, must disassemble each byte into two characters. The character comprised of the upper 6 bits is transmitted to the tape unit first, followed by the lower 6 bits.

This disassembly is automatically suppressed when a 3100/3200 Character Output instruction (OUTC or OTAC) is executed. In this case, only the lower 6 bits of the data byte are transmitted to the tape unit. The controller ignores the upper 6 bits of the byte.

During Read operations, the tape unit transmits 6-bit characters to the control. The control assembles two successive characters into a single byte for transmission to the data channel. The first character received comprises the upper 6 bits of the byte, and the next character comprises the lower 6 bits.

This assembly is automatically suppressed when a 3100/3200 Character Input instruction (INPC or INAC) is executed. In this case, each character received from the tape unit is transmitted to the data channel as the lower 6 bits of the byte. The upper 6 bits are all zeros.

*Located on the tape unit

DATA TRANSMISSION

BCD/Binary Modes

Data may be written on or read from tape in either BCD (binary coded decimal) or Binary mode. Data is processed in Binary mode following a clearing operation or the selection of Binary mode. It is processed as BCD following the selection of BCD mode. A code of all zeros is considered illegal if the controller is in BCD and the computer is operating in 1604 mode.

1604 Mode*

Normally, during a Write operation in BCD mode, the controller automatically changes any character of all "0's" and writes it as 12_8 on tape. When reading a 12_8 from tape in BCD mode, the controller changes it to a character of all "0's". If bit 4** is a 1, bit 5 is complemented during Read and Write operations (bit 4 remains unchanged). This process converts internal BCD codes to external BCD codes when writing and vice versa for reading.

If the computer is running in 1604 mode, the conversion from internal BCD to external BCD does not apply during a Write operation. Similarly, the conversion from external BCD to internal BCD does not apply during a Read operation.

Record/File Formats

The data written on tape as the result of a single Output instruction constitutes a record. If 3100/3200 Character Output instructions are used, a record may be as short as a single character. Adjacent records are separated by a record gap.

A file consists of one or more records. Its length is determined by the programmer. Adjacent files are separated by a file mark which a tape unit writes in response to a function code (Write File Mark).

*3600/3800 systems only

**Bit 0 is the right most bit of the character to be written on tape.

An End of Record signal is sent to the data channel during a Read operation when a tape unit detects a record gap or a file mark. This signal may be used to terminate a Read.* The Read operation also terminates when the specified number of words or characters has been read.

Transfer Rates

Read or Write operations may be performed with 607 Tape Units at any one of three densities: 200 characters/inch, 33 microseconds/frame; 556 characters/inch, 12 microseconds/frame; 800 characters/inch, 8 microseconds/frame. With 606 Tape Units only low density (200 characters/inch) and high density (556 characters/inch) are available.

The transfer rate of the 604 Tape Unit is one half that of the 607 Tape Unit, and the rate of the 603 Tape Unit is one half that of the 606 Tape Unit.

The programmer should determine or select density and binary or BCD formats prior to a Read or Write operation.

CONNECT

A control must be connected to its data channel before it can respond to either a Select/Function instruction or an Input/Output instruction. The connection is accomplished by the Connect instruction; the Connect code (N00U) is the lower 12 bits of this instruction. The N portion of the code must contain the equipment number of the controller. The U portion of the code designates one of the eight possible tape units. Each control examines every Connect code transmitted from its attached data channel. A Reply signal, ** indicating a connect, is returned to the data channel from a control if:

- 1) The N portion of the Connect code matches the setting of the Equipment Number switch on the read/write control,
- 2) The U portion of the Connect code matches the setting of the Unit Select switch on an unreserved tape unit, and
- 3) A transmission parity error is not detected.

*In 3100/3200 systems, the End of Record signal always terminates a Read.
In 3400/3600/3800 systems, this use of the signal is optional.

**A Reply signal tells the central processor to process the next instruction.

If the N portion of the Connect code does not match the setting of the Equipment Number switch, neither a Reject nor a Reply is returned to the channel from the control. Equipment status is not made available to the channel. If the control is already connected, it automatically disconnects. If neither a Reply nor a Reject is returned to the data channel from any of its attached equipments within 100 microseconds, the central processor generates an Internal Reject.

If the U portion of the Connect code does not match the setting of any Unit Select switch a Reject signal* is returned to the data channel.

If a parity error is detected in a Connect code, the device does not connect** and neither a Reject nor a Reply is returned to the data channel. Instead, the Parity Error indicator of each equipment detecting the error lights. In this equipment, a red indicator in the Equipment Number switch lights. These parity error conditions must be cleared by either a Channel Clear or a Master Clear prior to a new connect attempt.

FUNCTION

Function codes are used to prepare a connected control and/or unit for an Input/Output operation. (They have no effect on unconnected controls or units.) They comprise the lower 12 bits of a Select/Function*** instruction and are transmitted to the control on the 12 data lines. Table C-1 is a complete list of function codes. A detailed description of each code follows the table.

There are three classifications of codes: operating**** nonoperating, and interrupts. Operating codes cause tape motion. They include Rewind, Rewind Unload, Backspace, Search Forward/Backward to File Mark, Write File Mark, and Skip Bad Spot. Nonoperating codes include Release, Binary, Coded, Densities, Clear, and Set and Clear Reverse Read.

The control accepts operating codes only when the tape is completely at rest. Thus, operating codes are not accepted during a Read or a Write operation or while an operating code is being executed. Likewise, a new Read or Write operation cannot be initiated while an operating code is being executed.

*A Reject signal tells the central processor to read the next instruction at the reject jump address contained in the Connect instruction.

**If the device is connected, it automatically disconnects.

***Select in 3100/3200 systems, Function in 3400/3600/3800 systems

****Operating codes cause the control to become Busy.

Nonoperating codes are accepted prior to a Read or Write operation, following the conclusion of a Write, and following the receipt of an End of Record signal during a Read. Thus, they are accepted even though an operating code is being executed.

Interrupt codes are never rejected.

A control examines only one code at a time. First, it checks for parity errors. If none are found, it returns a Reply if the requested function can be performed* or a Reject if it cannot be performed. Interrupt codes always cause a Reply to be returned to the channel.

If a parity error is detected, the requested function is not performed, a Parity Error signal is returned to the data channel, and a red indicator in the Equipment Number switch lights. Since neither a Reply nor a Reject is returned to the data channel, the central processor generates an Internal Reject after a wait of 100 microseconds.

These parity error indications must be cleared by either a Channel Clear or a Master Clear. The equipment must then be reconnected before a new function code is examined by the controller.

INTERRUPTS

Interrupts provide a means for attaining optimum utilization of a system's capabilities. Basically, the system interrupts (halts) the main program and initiates an interrupt processing program** when an Interrupt signal is detected by the processor.

The 322X Tape Unit can be programmed to send an Interrupt signal to the processor when any one of the conditions specified by the three Interrupts*** occurs.

A Select Interrupt code permits the controller to consider as a group**** several of the operating conditions which may occur in an attached unit. If a specific interrupt has been selected and if at least one of the conditions specified by it occurs in the connected unit, the controller sends an Interrupt signal to the processor. If the interrupt system

*Certain illegal Function codes cause a Reply to be returned. However, in these cases no action follows.

**See the system reference manual for the addresses pertinent to interrupt processing.

***See explanation of function codes following Table C-1 for a list of these conditions.

****See description of function codes following Table C-1 for a breakdown of the three possible groups.

in the processor has been set to recognize the interrupt, the main program is interrupted and control is transferred to a specific program address. Status sensing and followup operations may follow. If desired, control may be returned to the main program by an appropriate Jump instruction located at the close of the interrupt processing program.

If the processor's interrupt system has not been enabled, it is still possible to sense for these conditions via Sense Status and Copy Status instructions written into the main program.

Regardless of which of the above actions is followed, the Interrupt signal remains up until cleared by reselecting the interrupt, selecting release, or master clearing the system. The Interrupt signal is transmitted on the equipment's interrupt line via the data channel, whether or not the channel is currently serving the equipment.

The eight-position (0-7) Equipment Number switch determines the number of the line on which the Interrupt signal is transmitted. For example, if the Equipment Number switch is set at 5, all Interrupt signals coming from this control are transmitted on interrupt line 5. Since each equipment attached to a data channel has a unique equipment number, each uses a different interrupt line. A Channel Product Register Jump instruction* or a Copy Status instruction** can identify the equipment sending the Interrupt signal by inspecting the interrupt lines.

STATUS

Status codes permit the monitoring of several control/unit operating conditions. These codes are made available to the data channel over 12 status lines following a connect or a rejected connect attempt. Sense Status and Copy Status instructions make these codes available to the central processor.

See Table C-1 for a complete list of these codes. If two or more conditions exist simultaneously, the Status Response code is the sum of the individual codes. A detailed description of each code follows the table.

*3600/3800 systems

**3100/3200/3400 systems

PARITY CHECKING

Transmission Parity Checking

Connect codes, function codes, and data are transmitted between the data channel and the controller in odd parity (i. e., the number of "1" bits transmitted must be odd). If the number of "1" bits in a data byte is even, a "1" is transmitted on the parity line to make the total number of "1" bits odd.* If the number of "1" bits in the data byte is odd, the "1" is not transmitted on the parity line.

A transmission parity error exists if the total number of "1" bits transmitted on the 12 data lines plus the parity line is even, indicating that a bit has been lost or picked up.

Parity Error in a Connect Code: If a parity error is detected in a Connect code, the device does not connect** and neither a Reject nor a Reply is returned to the data channel. Instead, the red indicator in its Equipment Number switch of each equipment detecting the error lights. These parity error conditions must be cleared by either a Channel Clear or a Master Clear prior to a new connect attempt.

Parity Error in a Function Code: If a parity error is detected, the requested function is not performed, a Parity Error signal is returned to the data channel, and a red indicator in the Equipment Number switch lights. Since neither a Reject nor a Reply is returned to the data channel, the central processor generates an Internal Reject after a wait of 100 microseconds. These parity error indications must be cleared by a Channel Clear or a Master Clear.*** The equipment must then be reconnected before a new function code can be examined by the controller.

Parity Error in Output Data: If a transmission parity error is detected during a Write operation, the control lights a red indicator in its Equipment Number switch and sends both a Reply and a Parity Error signal to the data channel. The data is written on tape. All operations continue**** unless appropriate programming steps have been taken to

*Do not confuse this line with the parity error line.

**If the device is connected, it automatically disconnects.

***Though operations may continue normally, the validity of a new function code and/or data prior to a Master Clear or Channel Clear is questionable.

****The validity of the data received from this point until a Channel Clear or Master Clear is questionable.

sense for a Parity Error signal and rewrite the data. These parity error indications must be cleared by either a Channel Clear or a Master Clear. The equipment must then be reconnected and the appropriate functions reselected prior to the new output.

Parity Errors in Input Data: Transmission parity errors may be detected by the data channel on data received from the equipment. If a parity error is detected, a parity error bit in the data channel is set and a Parity Error indicator on either the channel or console lights. The faulty data is entered into either core storage or the A register. All operations continue* unless appropriate programming steps have been taken to sense for the set bit and reread the data. These parity error indications may be cleared by a Channel Clear or a Master Clear issued by any 3000 Series system and by a new Read or Write from a 3100/3200 system. Following a Channel Clear or a Master Clear, the equipment must be reconnected and the appropriate functions reselected prior to a new input.

Input/Output Parity Error Bit in the Data Channel: The input/output parity error bit is set whenever a transmission parity error is detected. If the error is detected by the external equipment, the bit is set by the Parity Error signal.

In 3400/3600/3800 systems, if the interrupt system is active, an Interrupt signal is generated when this bit sets. If the interrupt system has not been set to detect the setting of this bit, the bit may be sensed to detect parity error conditions.

In 3100/3200 systems, the bit must be sensed if transmission parity error conditions are to be detected by the central processor.

Refer to the appropriate system reference manual for more information on the input/output parity error bit.

Equipment Parity Checking

Each character, whether BCD or Binary, transmitted between a control and a unit is checked for correct parity. For BCD characters, correct parity is even, and for Binary characters, it is odd. During a Write operation, the control adds the correct

*The validity of the data received from this point until the indicators are cleared is questionable.

parity bit to each character and relays it to the tape unit. Approximately 2 or 3 milliseconds* after writing, a vertical parity error check is made. This time interval is used to check-read the tape and transmit the data back to the control. At the conclusion of a record, a record check character is written.

This character is used for longitudinal parity checking. During a Read, vertical and longitudinal parity checks are made by the control when the appropriate data is received.

Both vertical and longitudinal parity errors are considered equipment parity errors.

Vertical Parity Error Checking: A vertical (transverse) parity error exists when the number of "1" bits on the six data lines plus the parity line is not correct. The number of "1" bits must be odd for binary data and even for BCD data.

If a vertical parity error is detected, the Vertical Parity Error indicator on the control lights and a Parity Error signal is placed on the appropriate status line. These parity error indications may be cleared by a new Read, Write, Channel Clear, or Master Clear. If desired, this condition may cause an Abnormal End of Operation interrupt.

Longitudinal Parity Error Checking: Longitudinally (lengthwise), the tape is divided into seven tracks. Six of these are used to store data, and the seventh holds the vertical parity bits. When a record is written on or read from tape, the total number of "1" bits in each track must be even. If the number of "1" bits in any track of a record is odd, a "1" is written in that track as a part of the record check character. During a Read operation, a longitudinal parity error exists if the record check character is not as anticipated.

If a longitudinal parity error is detected, the appropriate Longitudinal Parity Error indicator(s) remains lighted,** and a Parity Error signal is placed on the appropriate status line. These parity error indications may be cleared by a new Read, Write, Channel Clear, or Master Clear. If desired, this condition may cause an Abnormal End of Operation interrupt.

*Two milliseconds for 606/607 Tape Units, 3 milliseconds for 603/604 Tape Units

**These indicators may flash on and off during normal operations. Such flashings are to be ignored.

CODES

All connections and operations are controlled by 12-bit Connect and function codes in conjunction with the appropriate Connect or Select/Function instruction. Status codes are constantly available while the equipment is connected. In all discussions of codes, bit 0 is in the rightmost position (see Table C-1).

TABLE C-1. CONNECT, FUNCTION,
AND STATUS CODES

CONNECT	
Connect Tape Unit	N00U*
FUNCTION	
Release	0000
Binary	0001
Coded	0002
556 BPI	0003
200 BPI	0004
Clear	0005
800 BPI**	0006
Rewind	0010
Rewind Unload	0011
Backspace	0012
Search Forward to File Mark	0013
Search Backward to File Mark	0014
Write File Mark	0015
Skip Bad Spot	0016
Clear Reverse Read**	0040
Set Reverse Read***	0041
Select Interrupt on Ready and Not Busy	0020
Release Interrupt on Ready and Not Busy	0021
Select Interrupt on End of Operation	0022
Release Interrupt on End of Operation	0023
Select Interrupt on Abnormal End of Operation	0024
Release Interrupt on Abnormal End of Operation	0025

*N=equipment number of read/write control, U=unit number of a specific tape unit

**604 and 607 Tape Units only

***If a Backspace operation is executed when Reverse Read is set, tape is moved in a forward direction. 604 and 607 Tape Units only

TABLE C-1. CONNECT, FUNCTION,
AND STATUS CODES (Cont'd)

STATUS	
Ready	XXX1
Channel and/or Read/Write Control and/or Unit Busy	XXX2
Write Enable	XXX4
File Mark	XX1X
Load Point	XX2X
End of Tape	XX4X
Density ("1" in bit 6 indicates 556 BPI, "0" in bits 6 and 7 indicates 200 BPI)	X1XX
Density ("1" in bit 7 indicates 800 BPI)	X2XX
Lost Data	X4XX
End of Operation	1XXX
Vertical or Longitudinal Parity Error	2XXX

CONNECT CODE

Connect Tape Unit (N00U)

This code connects the desired unit. N is the equipment number of the read/write control. U is the unit number of a specific tape unit.

FUNCTION CODES

Release (0000)

This code clears the existing unit connection.

Binary (0001)

This code causes all data to be written/read in binary notation.

Coded (0002)

This code causes all data to be written/read in BCD notation.

556 BPI (0003)

This code causes all data to be written/read at 556 bits per inch density.

200 BPI (0004)

This code causes all data to be written/read at 200 bits per inch density.

Clear (0005)

This code clears the existing unit connection.

*800 BPI (0006)**

This code causes all information to be written/read at 800 bits per inch density.

Rewind (0010)

This code rewinds tape at high speed (400 inches per second) to load point. It has no effect when the tape is at load point.

Rewind Unload (0011)

This code rewinds tape at high speed to load point. It then rewinds tape slowly until all of the tape is on the supply reel. All further operations with this tape unit are locked out until the tape is manually reloaded.

Backspace (0012)

This code backspaces the tape one record or until load point is detected. If the tape is at load point and if fewer than two records precede the load point, it unloads the tape. If Reverse Read is selected, * a Backspace selection initiates forward tape motion.

Search Forward to File Mark (0013)

This code advances the tape until a file mark is detected. If no file marks are detected, tape motion continues until all the tape is on the takeup reel.

*604 and 607 Tape Units only

Search Backward to File Mark (0014)

This code backspaces tape until a file mark or load point is detected. If the tape is at load point, it backspaces the tape until either a file mark is detected or the tape is unloaded.

Write File Mark (0015)

This code advances the tape at least 6 inches, then writes a 17_8 file mark followed by a 17_8 check character. Both are written in even vertical parity. This file mark is used with both BCD and Binary modes. Writing a file mark does not affect the selected format.

Skip Bad Spot (0016)

This code erases at least 4 inches of tape. Vertical and longitudinal parity checks are made to insure complete erasure.

*Clear Reverse Read (0040)**

This code clears the condition set by the Set Reverse Read code.

*Set Reverse Read (0041)**

This code must precede a Reverse Read operation (see Reverse Read section).

Select Interrupt on Ready and Not Busy (0020)

This code causes the controller to send an Interrupt signal to the processor when the tape unit is in a Ready and Not Busy condition (i.e., when power is applied, the unit is under computer control, and all tape motion has ceased). Once up, the Interrupt signal can be cleared by selecting release (0021) or by clearing the control.

Release Interrupt on Ready and Not Busy (0021)

This code clears an Interrupt on Ready and Not Busy selection and the Ready and Not Busy Interrupt signal if it is up.

*604 and 607 Tape Units only

Select Interrupt on End of Operation (0022)

This code causes the controller to send the Interrupt signal to the processor when the data channel terminates a Read or Write operation, when a tape unit senses the end of a record during a Read operation, or upon completion of an operating function. Once up, the Interrupt signal remains up until cleared by reselecting the interrupt (0022), selecting release (0023), or clearing the control.

During a chaining operation, * interrupt does not occur until the data channel is Not Busy (i. e., until the last record has been written/read in the chaining operation).

Release Interrupt on End of Operation (0023)

This code clears an Interrupt on End of Operation selection and the End of Operation Interrupt signal if it is up.

Select Interrupt on Abnormal End of Operation (0024)

This code causes the controller to send an Interrupt signal to the processor after an abnormal condition occurs. These abnormal conditions are End of Tape, File Mark, ** Load Point,** Vertical Parity Error, Longitudinal Parity Error, Lost Data, parity error during a Skip Bad Spot operation, and connected tape unit becoming Not Ready.

In all but the last case, the interrupt occurs when one or more of these conditions are encountered and when an end of record check character is written/read by the tape unit. In the case of interrupt on connected tape unit becoming Not Ready, interrupt occurs immediately when the connected tape unit goes from a Ready to a Not Ready condition (e. g., if the power is turned off on the tape unit). Interrupt on connected tape unit becoming Not Ready does not occur during a Connect operation or when a Release code (0000) is executed.

A new Read/Write operation cannot start until the Interrupt signal is cleared. Once up, the Interrupt signal can be cleared by reselecting the interrupt (0024), selecting release (0025), or a Master Clear.

*3400/3600/3800 systems only

**Common to Interrupt on End of Operation and Interrupt on Abnormal End of Operation

Release Interrupt on Abnormal End of Operation (0025)

This code clears an Interrupt on Abnormal End of Operation selection and the Abnormal End of Operation Interrupt signal if it is up.

STATUS CODES

Ready (XXX1)

Bit 0 is set when the tape unit is in a Ready condition (i. e., power is applied and the ready switch is lighted). (The tape controller can operate the unit.)

Channel and/or Read/Write Control and/or Unit Busy (XXX2)

If the tape unit is Ready, bit 1 is set when the channel is transmitting or receiving data during an Input/Output operation. It is also set if the unit is Ready and tape motion is initiated by an operating function code. In these two cases, it remains set until 5 milliseconds after tape motion stops. Bit 1 is cleared approximately 5 milliseconds after either detection of lost data or an Abnormal End of Operation Interrupt signal and cannot be reset until these conditions cease to exist. Bit 1 cannot be set if bit 0 is clear.

Write Enable (XXX4)

Bit 2 is set when the file protection ring is on the tape reel. When this ring is present, it is possible to read from and write on the tape. When this ring is absent, it is possible to read from but not write on the tape.

File Mark (XX1X)

Bit 3 is set whenever a file mark is read.* It remains set until a new operating function, a Read/Write operation, or a clearing operation is initiated or until a new unit is connected or the same unit is reconnected.

Load Point (XX2X)

Bit 4 is set when the tape is at load point. It is cleared when the tape moves off the load point.

*If a file mark is detected during a Search Backward to File Mark and this is followed by a Read forward, the file mark is the first record read.

End of Tape (XX4X)

Bit 5 is set when the end of tape marker is detected. It is cleared when the end of tape marker is sensed during Rewind or Reverse Read.*

Density (X1XX)

Density (X2XX)

	<u>Bit 7</u>	<u>Bit 6</u>
200 BPI	0	0
556 BPI	0	1
800 BPI	1	0

Lost Data (X4XX)

Bit 8 is set when the control determines that data may have been lost in transmission. Tape motion stops when bit 8 is set and cannot be restarted until this bit has been cleared by a new Connect or function code or Master Clear (see Programming Considerations).

When operating from a 160/160-A Computer via a 3681 Data Channel Converter, lost data is also detected if the read or write selection in the 3681 Converter is not cleared immediately after a Read or Write operation is completed. As long as a Write signal is present and the Data signal is not present at the required time, the controller assumes that a data transmission loss has occurred and a Lost Data signal is sent. If the Read signal is present but data is not being accepted by the channel, lost data also occurs. It is, therefore, necessary to clear the read or write selection in the 3681 Converter immediately after a Read or Write operation is completed to prevent the Lost Data signal from being sent abnormally. If the Lost Data signal is present, it must be cleared if Read or Write operations are to continue.

End of Operation (1XXX)

Bit 9 is set when the data terminates a Read or Write operation, when a tape unit senses the end of a record during a Read operation, or upon completion of an operating function. It remains up until a new Read/Write operation, operating function, or clearing operation is initiated.

*Reverse Read is possible with 604 and 607 Tape Units only.

Vertical or Longitudinal Parity Error (2XXX)

Bit 10 is set following detection of either a vertical or longitudinal parity error or reading a file mark while in Binary mode. It is cleared by initiating a new Read, Write, or clearing operation. If this bit is set during a chaining operation* due to detection of a vertical parity error or due to detection of a longitudinal parity error, it cannot be cleared until the chaining operation terminates.

SWITCHES AND INDICATORS

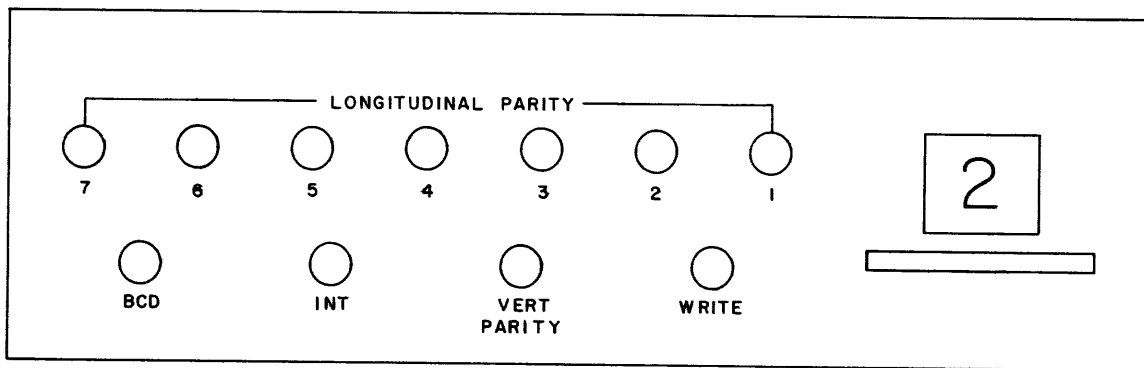

Figure C-2. 322X Equipment Number Switch and Indicator Panel**

EQUIPMENT NUMBER SWITCH

An eight-position Equipment Number switch is associated with each read/write control. The setting of this switch (0 - 7) designates the control and corresponds to the N portion of the Connect code. It also determines the number of the interrupt transmission line that the equipment uses.

When a control is connected to a tape unit, a white indicator in the switch lights.

If a transmission parity error is detected during a Connect, Function, Read, or Write operation, a red indicator in the Equipment Number switch lights.

*3400/3600/3800 systems only

**Located on the 322X Controller logic chassis

LONGITUDINAL PARITY INDICATORS

Seven LONGITUDINAL PARITY indicators are associated with each control. At the end of an operation involving longitudinal parity checking, none of these indicators should remain lighted. If one or more remains lighted, a longitudinal parity error has occurred. The indicators remain lighted until a new record is begun.

WRITE INDICATOR

The WRITE indicator lights during Write and Write File Mark operations. The WRITE indicator is cleared on termination of the Write operation.

VERT (VERTICAL) PARITY INDICATOR

A Vertical Parity Error indicator lights if a vertical parity error is detected during a Read or Write operation. This indicator remains lighted until cleared by a new Read, Write, Channel Clear, or Master Clear.

INT (INTERRUPT) INDICATOR

This indicator lights when an interrupt occurs. This indicator remains lighted until the Interrupt signal drops.

BCD INDICATOR

This indicator lights when BCD mode is selected or a file mark is being written on tape.

OPERATION AND PROGRAMMING

CLEARING THE CONTROLLER

Prior to the initial use of the tape controller, the system should be cleared. There are five possible ways of clearing the controller:

- 1) Clear Channel* (100 microseconds)
This instruction:
 - a) Clears all activity in the data channel.

*See the individual processor instructions

- b) Clears the present connection control N may have with a tape unit.
 - c) Performs a Master Clear on control N read, write, and function logic. No status signals are available to the data channel after executing this instruction.
- 2) Clear (0005) (2 microseconds)
This function code clears the present connection control N may have with a tape unit. Control N remains connected in the sense that status signals are still available for the data channel.
 - 3) Release (0000)
This function code clears the connection for the connected tape unit.
 - 4) Power On Master Clear
When power is applied to the 322X Controller, all tape units are cleared. Logic in all controls is also cleared. No status signals are available to the data channel after power is applied.
 - 5) External Master Clear
This clears all tape units. It also clears the logic in all controls. No status signals are available to the data channel after executing this operation.

The Clear and Release codes can only be used after a control is connected to a tape unit.

All clear operations (except the Release code) place the 322X Controller in binary format.

REVERSE READ (604 AND 607 TAPE UNITS ONLY)

The 322X Controller can read information in a reverse direction from tape. Six-bit frames are read from tape, assembled into 12-bit bytes, * and sent to the data channel. When a word is read in a reverse direction from tape and entered into storage, it is identical to the word which was initially written on the tape from storage. There is no change made in the final order of the bits during a Reverse Read operation.

To initiate a Reverse Read operation (assuming format, etc, have already been selected and all tape motion has stopped), a 322X Controller must first receive Function code 0041 (Set Reverse Read). When the Read instruction is executed in the processor, the Reverse Read operation begins (i. e., data is available to the data channel). A Reverse Assembly signal is sent to the data channel from the 322X Controller to indicate that the 12-bit bytes should be assembled into a word in reverse order.

*This assembly may be suppressed. See Assembly/Disassembly.

Data transfer continues until the word count in the control word equals zero* or until $m^1 = m^2$.** Tape motion continues in a reverse direction and stops at the gap between the current record and the record check character of the next record (unless chaining or nonstop read has been selected).

Vertical and longitudinal parity checking occur as in a normal Read operation, except if the first frame read is a record check character, no vertical parity check is made on that character. Vertical parity checking is performed on the remaining frames.

If a Reverse Read is attempted from load point, there is no tape motion. The Read operation hangs up.

Parity errors and interrupts may be handled as if the operation were a normal Read. An End of Record signal is returned to the data channel when a record gap is reached. Chaining and nonstop Read operations are also handled as if the operation were a normal Read.

Function code 0040 (Clear Reverse Read) should be issued when the Reverse Read operation terminates.

PROGRAMMING CONSIDERATIONS

Suppress Assembly/Disassembly

If data is to be assembled from a tape that was recorded in Suppress Assembly/Disassembly mode, ** assembly difficulties may be encountered. The problem is that in Suppress Assembly/Disassembly mode, an odd number of frames may be written on the tape. If this occurs and the tape is read forward, the controller automatically fills in bits 0 through 5 of the last input byte with "0's". If an odd number of frames are written and a Reverse Read is attempted, the inverted assembly is one frame out of order, and bits 6 through 11 of the last data channel word are filled in with "0's".

*3400/3600/3800 systems

**3100/3200 systems

Lost Data

The Lost Data condition occurs in two cases:

- 1) When the data channel cannot supply or accept data at the rate required by the tape unit due to competition from other devices for access to storage.
- 2) When certain malfunctions occur in the data channel.

A Lost Data condition causes data transfer to stop, stops tape motion (at the next record gap), and sets the lost data status bit. A new Read or Write operation cannot begin until the Lost Data condition is cleared by a Master Clear, Clear Channel instruction, or new Connect or Function operation. In most cases, the Lost Data condition leaves the data channel active (i. e., the Read or Write operation remains uncompleted). Thus, a new Connect or Function operation cannot be initiated until the channel active condition is cleared by a Master Clear, Clear Channel instruction, or Stop Channel Activity function code.*

* 3600/3800 systems only

SECTION D

3127-A MAGNETIC TAPE CONTROLLER

CONTENTS

Functional Description	D-1	Connect Code	D-12
System Relationships	D-1	Function Codes	D-12
Tape Unit Designation	D-2	Status Codes	D-16
Assembly/Disassembly	D-2	Switches and Indicators	D-18
Data Transmission	D-2	Operation and Programming	D-21
BCD/Binary Modes	D-2	Clearing the Controller	D-21
BCD Code Conversion	D-3	Reverse Read	D-22
Record/File Formats	D-3	Programming Considerations	D-23
Transfer Rates	D-4	Suppress Assembly/ Disassembly	D-23
Connect	D-4	Lost Data	D-23
Function	D-5	Nonstop Operation	D-24
Interrupts	D-6	601 and 602 Tape Unit Operation	D-24
Status	D-7	Application of Power	D-24
Parity Checking	D-7	Tape Load Procedure	D-25
Transmission Parity Checking	D-7	Tape Unload Procedure	D-26
Equipment Parity Checking	D-9		
Codes	D-10		

FIGURES

D-1 Typical Configuration	D-1	D-3 602 Control Panel	D-18
D-2 601 Control Panel	D-18	D-4 Tape Position After Load Operation	D-26

TABLES

D-1 Connect, Function, and Status Codes	D-11
--	------

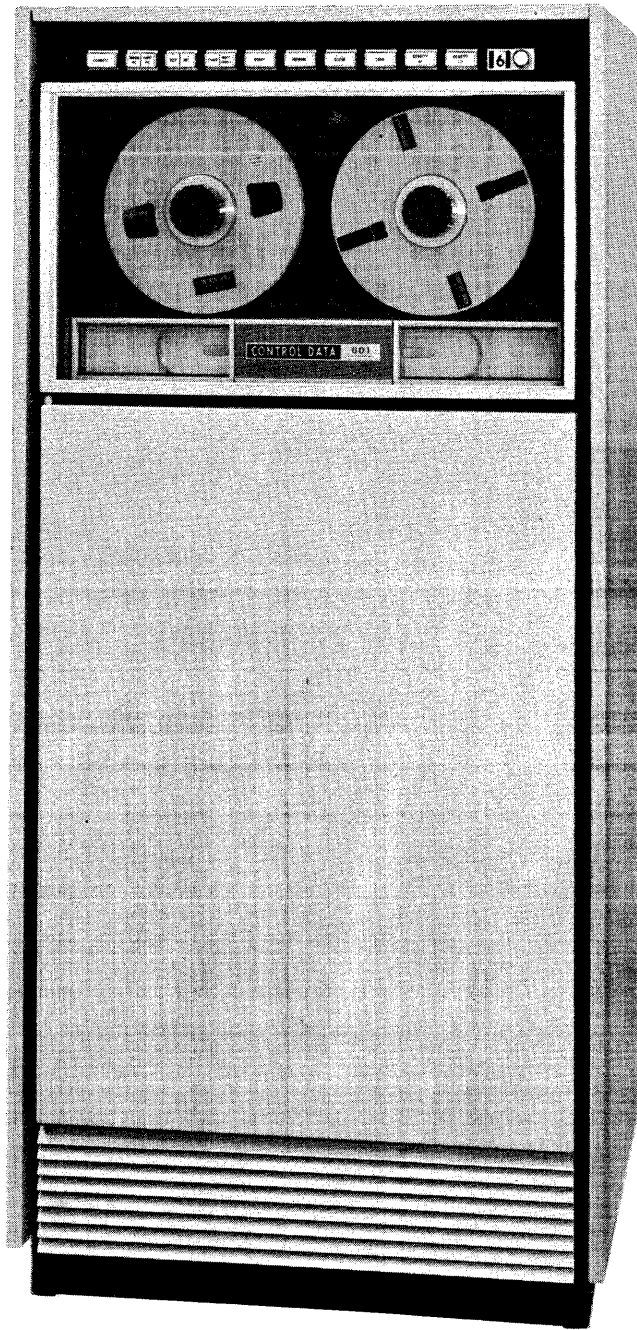

3127 MAGNETIC TAPE CONTROLLER

SECTION D

3127-A MAGNETIC TAPE CONTROLLER

This section describes a magnetic tape system consisting of a CONTROL DATA* 3127 Magnetic Tape Controller and CONTROL DATA 601 and 602 Magnetic Tape Transports.** It includes relevant system specifications, programming procedures, and manual operating instructions. See Section Z for tape format information.

FUNCTIONAL DESCRIPTION

SYSTEM RELATIONSHIPS

A typical system configuration is shown in Figure D-1. This 3127 Controller, which is mounted in the rear of one of the attached tape units, has one read/write control. The control may be physically attached to one standard 3000 Series data channel and to up to eight tape units. However, only one tape unit can be used at any one time (see Connect).

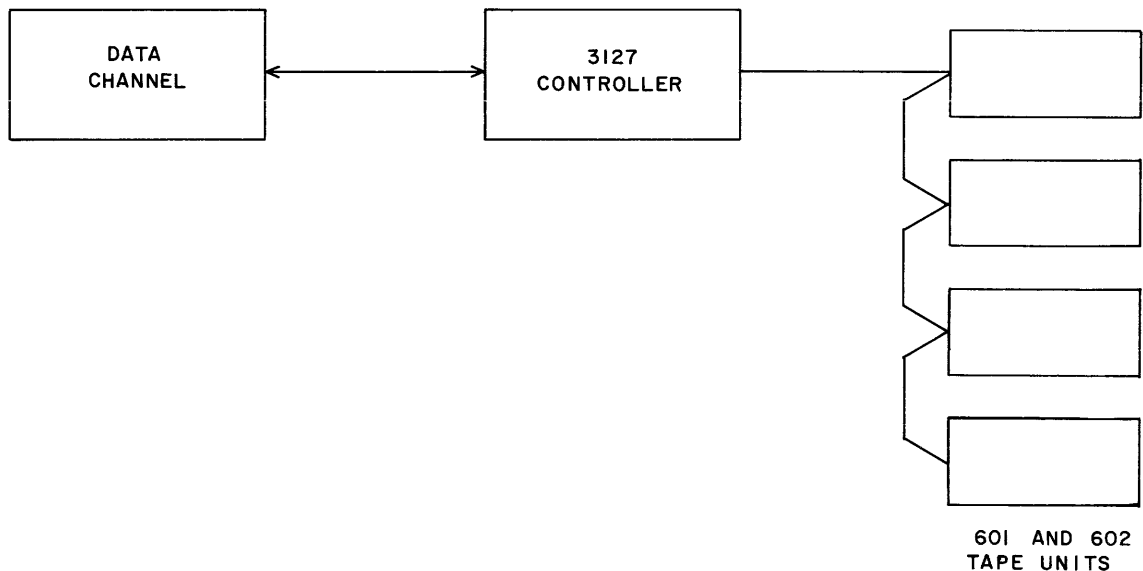

Figure D-1. Typical Configuration

*Registered trademark of Control Data Corporation
**The program must be adapted if 601 and 602 Tape units are mixed.

TAPE UNIT DESIGNATION

Each tape unit must have a unique numerical designation (0-7) that is determined by a Unit Select switch.* When the numerical designation of a unit is changed, any existing connection is cleared.

ASSEMBLY/DISASSEMBLY

During Write operations, each control receives data from its data channel in 12-bit bytes (i.e., 12 bits of data are received simultaneously on 12 data lines). A tape unit, however, can handle only one 6-bit character at a time. The control, therefore, must disassemble each byte into two characters. The character comprised of the upper 6 bits is transmitted to the tape unit first, followed by the lower 6 bits.

This disassembly is automatically suppressed when a 3100/3200 Character Output instruction (OUTC or OTAC**) is executed. In this case, only the lower 6 bits of the data byte are transmitted to the tape unit. The controller ignores the upper 6 bits of the byte.

During Read operations, the tape unit transmits 6-bit characters to the control. The control assembles two successive characters into a single byte for transmission to the data channel. The first character received comprises the upper 6 bits of the byte, and the next character comprises the lower 6 bits.

This assembly is automatically suppressed when a 3100/3200 Character Input instruction (INPC or INAC**) is executed. In this case, each character received from the tape unit is transmitted to the data channel as the lower 6 bits of the byte. The upper 6 bits are all zeros.

DATA TRANSMISSION

BCD/Binary Modes

Data may be written on or read from tape in either BCD (binary coded decimal) or Binary mode. BCD uses even parity and binary uses odd parity (see Vertical Parity Checking). Data is processed in Binary mode following a clearing operation or the

*Located on the top front of the tape unit.

**Applicable to OTAC and INAC only when the 3127 Controller is used with a 24-bit data channel.

selection of Binary mode. It is processed as BCD following the selection of BCD mode. A code of all zeros is considered illegal if the controller is in BCD and the computer is operating in 1604 mode.

BCD Code Conversion

Normally, during a Write operation in BCD mode, the controller automatically changes any character of all "0's" and writes it as 12_8 on tape. When reading a 12_8 from tape in BCD mode, the controller changes it to a character of all "0's". If bit 4* is a "1", bit 5 is complemented during Read and Write operations (bit 4 remains unchanged). This process converts internal BCD codes to external BCD codes when writing and vice versa for reading.

When 3600 or 3800 systems operate in 1604 mode, they can transmit or receive external BCD codes directly. In this case, a Negate BCD Conversion signal generated by the computer disables the automatic BCD conversion in the 3127 Controller. Thus, if the computer is running in 1604 mode, ** the conversion from internal BCD to external BCD does not occur during a Write operation. Similarly, the conversion from external BCD to internal BCD does not occur during a Read operation.

Record/File Formats

The data written on tape as the result of a single Output instruction constitutes a record. If 3100/3200 Character Output instructions are used, a record may be as short as a single character. The controller automatically inserts a record gap at the end of each record.

A file consists of one or more records. Its length is determined by the programmer. Adjacent files are separated by a file mark which a tape unit writes in response to a function code (Write File Mark).

The controller sends an End of Record signal to the data channel during a Read operation when a tape unit detects a record gap or a file mark. This signal may be used to terminate a Read.*** The Read operation also terminates when the number of words or characters specified in the Input (Read) instruction has been read.

*Bit 0 is the rightmost bit of the tape character.

**3600/3800 systems only

***In 3100/3200 systems, the End of Record signal always terminates a Read.
In 3400/3600/3800 systems, this use of the signal is optional.

Transfer Rates

Read or Write operations may be performed with 602 Tape Units at any one of three densities: 200 characters/inch, 132 microseconds/frame; 556 characters/inch, 48 microseconds/frame; 800 characters/inch, 32 microseconds/frame. With 601 Tape Units only low density (200 characters/inch) and high density (556 characters/inch) are available.

The transfer rate of the 601 Tape Unit is 7.5K and 20.85K characters per second, and the rate of the 602 Tape Unit is 7.5K, 20.85K, and 30K characters per second.

The programmer should determine or manually select density and binary or BCD formats prior to a Read or Write operation.

CONNECT

The control must be connected to its data channel before it can respond to either a Select/Function instruction or an Input/Output instruction. The connection is accomplished by the Connect instruction; the Connect code (N00U) is the lower 12 bits of this instruction. The N portion of the code must contain the equipment number of the controller. The U portion of the code designates one of the eight possible tape units. Each control examines every Connect code transmitted from its attached data channel. A Reply signal, * indicating a connect, is returned to the data channel from a control if:

- 1) The N portion of the Connect code matches the setting of the Equipment Number switch on the controller, and
- 2) A transmission parity error is not detected.

If the N portion of the Connect code does not match the setting of the Equipment Number switch, neither a Reply nor a Reject is returned to the channel from the control. Equipment status is not made available to the channel. If the control is already connected, it automatically disconnects. If neither a Reply nor a Reject is returned to the data channel from any of its attached equipments within 100 microseconds, the central processor generates an Internal Reject.

If a parity error is detected in a Connect code, the device does not connect** and neither a Reply nor a Reject is returned to the channel. Instead, the Parity Error

*A Reply signal tells the central processor to process the next instruction.

**If the device is connected, it automatically disconnects.

indicators on all equipments attached to the data channel light. These parity error indications must be cleared by either a Clear Channel instruction or a Master Clear prior to a new Connect attempt.

Equipment status should be checked following a connect. If the equipment is not Ready, it may be that the Ready switch is not lighted or that the unit is not physically present. Pressing the Ready switch or redesignating the unit to match the U portion of the Connect code should remedy the situation. This check is unique to the 3127 Tape Controller.

FUNCTION

Function codes are used to prepare a connected control and/or unit for an Input/Output operation. (They have no effect on unconnected controls or units.) They comprise the lower 12 bits of a Select/Function* instruction and are transmitted to the control on the 12 data lines. Table D-1 is a complete list of function codes. A detailed description of each code follows the table.

There are three classifications of codes: operating,** nonoperating, and interrupt select. Operating codes cause tape motion. They include Rewind, Rewind Unload, Backspace, Search Forward/Backward to File Mark, Write File Mark, and Skip Bad Spot. Nonoperating codes include Release, Binary, Coded, Densities, Clear, and Set and Clear Reverse Read. Interrupt select codes select various conditions which cause the controller to interrupt the central processor.

The controller accepts operating codes only when the tape is completely at rest. Thus, operating codes are not accepted during a Read or a Write operation or while an operating code is being executed. Likewise, a new Read or Write operation cannot be initiated while an operating code is being executed.

Nonoperating codes are accepted at any time. Thus, they are accepted even though an operating code is being executed.

Interrupt codes are accepted at any time.

*Select in 3100/3200 systems, Function is 3400/3600/3800 systems

**Operating codes cause the control to become Busy

The controller examines each code as it is received. It returns a Reply signal to the processor if:

- 1) A transmission parity error is not detected, and
- 2) The requested function can be performed immediately, or
- 3) A code not listed in Table D-1 is transmitted to the controller.

If a transmission parity error is detected, the function is not performed. Since neither a Reply nor a Reject signal is returned to the processor, it generates an Internal Reject signal. Parity error indications must be cleared by either a Clear Channel instruction or by a Master Clear. The equipment must then be reconnected before a new function code is examined by the controller.

If the requested function cannot be performed immediately, a Reject signal is returned to the processor.

If an unlisted code is transmitted to the control, no action takes place even though a Reply is returned to the processor.

INTERRUPTS

Interrupts provide a means for attaining optimum utilization of a system's capabilities. Basically, the system interrupts (halts) the main program and initiates an interrupt processing program* when an Interrupt signal is detected by the processor.

A 3127 Controller can be programmed to send an Interrupt signal to the processor when it is Ready and Not Busy, at the end of an operation, or at the abnormal end of an operation.

A Select Interrupt code permits the controller to consider as a group** several of the operating conditions which may occur in an attached unit. If a specific interrupt has been selected and if at least one of the conditions specified by it occurs in the connected unit, the controller sends an Interrupt signal to the processor. If the interrupt system in the processor has been set to recognize the interrupt, the main program is interrupted and control is transferred to a specific program address. Status sensing and follow-up operations may follow. If desired, control may be returned to the main program by an appropriate Jump instruction located at the close of the interrupt processing program.

*See the system reference manual for the addresses pertinent to interrupt processing.

**See description of function codes following Table D-1 for the conditions of each of the three possible groups.

If the processor's interrupt system has not been enabled, it is still possible to sense for these conditions via Sense Status and Copy Status instructions written into the main program.

Regardless of which of the above actions is followed, the Interrupt signal remains up until cleared by reselecting the interrupt, selecting release, or master clearing the system. The Interrupt signal is transmitted on the equipment's interrupt line via the data channel, whether or not the channel is currently serving the equipment.

The eight-position (0-7) Equipment Number switch determines the number of the line on which the Interrupt signal is transmitted. For example, if the Equipment Number switch is set at 5, all Interrupt signals coming from this control are transmitted on interrupt line 5. Since each equipment attached to a data channel has a unique equipment number, each uses a different interrupt line. A Channel Product Register Jump instruction* or a Copy Status instruction** can identify the equipment sending the Interrupt signal by inspecting the interrupt lines.

STATUS

Status codes permit monitoring several control/unit operating conditions. These codes, with the exception of File Mark and End of Tape, are available to the channel over 12 status lines while the controller is connected. (Note: status is not available following a rejected connect attempt.) Sense Status and Copy Status instructions make these codes available to the central processor. The file mark and end of tape status bits are always cleared by a connect. This clearing is unique to the 3127 Controller.

See Table D-1 for a complete list of these codes. If two or more conditions exist simultaneously, the Status Response code is the sum of the individual codes. A detailed description of each code follows the table.

PARITY CHECKING

Transmission Parity Checking

Connect codes, function codes, and data are transmitted between the data channel and the controller in odd parity (i. e., the number of "1" bits transmitted must be odd). If

*3600/3800 systems

**3100/3200/3400 systems

the number of "1" bits in a data byte is even, a "1" is transmitted on the parity line to make the total number of "1" bits odd.* If the number of "1" bits in the data byte is odd, the "1" is not transmitted on the parity line.

A transmission parity error exists if the total number of "1" bits transmitted on the 12 data lines plus the parity line is even, indicating that a bit has been lost or picked up.

Parity Error in a Connect Code: If a parity error is detected in a Connect code, the device does not connect** and neither a Reply nor a Reject is returned to the data channel. Instead, the Transmission Parity Error indicators on all devices attached to the data channel light. These parity error conditions must be cleared by either a Clear Channel instruction or a Master Clear prior to a new connect attempt. If neither a Reply nor a Reject is returned, the processor generates an Internal Reject after 100 microseconds.

Parity Error in a Function Code: If a parity error is detected, the requested function is not performed, a Parity Error signal is returned to the data channel, and the Transmission Parity Error indicator lights. If neither a Reject nor a Reply is returned to the data channel, the central processor generates an Internal Reject after a wait of 100 microseconds. These parity error indications must be cleared by either a Clear Channel instruction or a Master Clear.*** The equipment must then be reconnected before a new function code can be examined by the controller.

Parity Error in Output Data: If a transmission parity error is detected during a Write operation, the controller lights the Transmission Parity Error indicator and sends both a Reply and a Parity Error signal to the data channel. The data is written on tape. All operations continue**** unless appropriate programming steps have been taken to sense for a Parity Error signal and rewrite the data. These parity error indications must be cleared by either a Clear Channel instruction or a Master Clear. The equipment must then be reconnected and the appropriate functions reselected prior to the new output.

*Do not confuse this line with the parity error line.

**If the device is connected, it automatically disconnects.

***Though operations may continue normally, the validity of a new function code and/or data prior to a Master Clear or Clear Channel instruction is questionable.

****The validity of the data received from this point until a Clear Channel instruction or a Master Clear is questionable.

Parity Errors in Input Data: Transmission parity errors may be detected by the data channel on data received from the equipment. If a parity error is detected, a parity error bit in the data channel is set, and a Parity Error indicator on either the channel or console lights. The faulty data is entered into either core storage or the A register. All operations continue* unless appropriate programming steps have been taken to sense for the set bit and reread the data. These parity error indications may be cleared by a Clear Channel instruction or a Master Clear issued by any 3000 Series system and by a new read or write from a 3100/3200 system. Following a Clear Channel instruction or a Master Clear, the equipment must be reconnected and the appropriate functions reselected prior to a new input.

Input/Output Parity Error Bit in the Data Channel: The input/output parity error bit is set whenever a transmission parity error is detected. If the error is detected by the external equipment, the bit is set by the Parity Error signal.

In 3400/3600/3800 systems, if the interrupt system is active, an Interrupt signal is generated when this bit sets. If the interrupt system has not been set to detect the setting of this bit, the bit may be sensed by a Copy Status instruction (3600/3800) or a Copy Interrupt Status instruction (3400).

In 3100/3200 systems, the bit must be sensed by a Sense Internal Status instruction if transmission parity error conditions are to be detected by the central processor.

Refer to the appropriate system reference manual for more information on the input/output parity error bit.

Equipment Parity Checking

Each character, whether BCD or Binary, transmitted between a control and a unit is checked for correct parity. For BCD characters, correct parity is even, and for Binary characters, it is odd. During a Write operation, the control adds the correct parity bit to each character and relays it to the tape unit. Approximately 8 or 9 milliseconds after writing, a vertical parity error check is made. This time interval is used to check-read the tape and transmit the data back to the control.

*The validity of the data received from this point until the indicators are cleared is questionable.

At the conclusion of a record, a record check character is written. This character is used for longitudinal parity checking. During a Read, vertical and longitudinal parity checks are made by the control when the appropriate data is received.

Both vertical and longitudinal parity errors are considered equipment parity errors.

Vertical Parity Error Checking: A vertical (transverse) parity error exists when the number of "1" bits on the six data lines plus the parity line is not correct. The number of "1" bits must be odd for binary data and even for BCD data.

If a vertical parity error is detected, the Parity Error indicator on the control lights and a parity error status bit is set. These parity error indications may be cleared by a new Read, Write, Clear Channel instruction, or Master Clear. This condition causes an interrupt if the Abnormal End of Operation interrupt is selected.

Longitudinal Parity Error Checking: Longitudinally (lengthwise), the tape is divided into seven tracks. Six of these are used to store data, and the seventh holds the vertical parity bits. When a record is written on tape, the controller adds a check character at the end of the record to make the total number of "1" bits in each track even. If the number of "1" bits in any track of a record is odd, a "1" is written in that track as a part of the record check character. During a Read operation, the controller forms the check character independently and compares it with the original check character written on tape. If the two check characters do not agree, data has been lost during the Read operation.

If a longitudinal parity error is detected, the Parity Error indicator lights and a parity error status bit is set. These parity error indications are cleared by a new Read, Write, Clear Channel instruction, or Master Clear. If desired, this condition may cause an Abnormal End of Operation interrupt.

CODES

All connections and operations are controlled by 12-bit Connect and function codes in conjunction with the appropriate Connect or Select/Function instruction. Status codes are constantly available while the equipment is connected. In all discussions of codes, bit 0 is in the rightmost position (see Table D-1).

TABLE D-1. CONNECT, FUNCTION,
AND STATUS CODES

CONNECT	
Connect Tape Unit	N00U*
FUNCTION	
Release	0000
Binary	0001
Coded	0002
556 BPI	0003
200 BPI	0004
Clear	0005
800 BPI**	0006
Rewind	0010
Rewind Unload	0011
Backspace	0012
Search Forward to File Mark	0013
Search Backward to File Mark	0014
Write File Mark	0015
Skip Bad Spot	0016
Select Interrupt on Ready and Not Busy	0020
Release Interrupt on Ready and Not Busy	0021
Select Interrupt on End of Operation	0022
Release Interrupt on End of Operation	0023
Select Interrupt on Abnormal End of Operation	0024
Release Interrupt on Abnormal End of Operation	0025
Clear Reverse Read**	0040
Set Reverse Read***	0041

*N = equipment number of read/write control, U = unit number of a specific tape unit

**602 Tape Units only

***If a Backspace operation is executed when Reverse Read is set, tape is moved in a forward direction. 602 Tape Units only

TABLE D-1. CONNECT, FUNCTION,
AND STATUS CODES (Cont'd)

STATUS	
Ready	XXX1
Channel and/or Read/Write Control and/or Unit Busy	XXX2
Write Enable	XXX4
File Mark	XX1X
Load Point	XX2X
End of Tape	XX4X
Density ('1' in bit 6 indicates 556 BPI, '0' in bits 6 and 7 indicates 200 BPI)	X1XX
Density ('1' in bit 7 indicates 800 BPI)	X2XX
Lost Data	X4XX
End of Operation	1XXX
Vertical or Longitudinal Parity Error	2XXX

CONNECT CODE

Connect Tape Unit (N00U)

This code connects the desired unit. N is the equipment number of the read/write control. U is the unit number of a specific tape unit.

FUNCTION CODES

Release (0000)

This code clears the existing unit connection.

Binary (0001)

This code causes all data to be written/read in binary notation.

Coded (0002)

This code causes all data to be written/read in BCD notation.

556 BPI (0003)

This code causes all data to be written/read at 556 bits per inch density.

200 BPI (0004)

This code causes all data to be written/read at 200 bits per inch density.

Clear (0005)

This code clears the existing unit connection.

800 BPI (0006)*

This code causes all information to be written/read at 800 bits per inch density.

Rewind (0010)

This code rewinds tape at high speed (400 inches per second) to load point. It has no effect when the tape is at load point.

Rewind Unload (0011)

This code rewinds the tape at high speed to load point and clears the Ready condition. The remainder of this process must be completed manually.

Backspace (0012)

This code backspaces the tape one record or until load point is detected. If the tape is at load point and if fewer than two frames precede the load point, it unloads the tape. If Reverse Read is selected, * a Backspace selection moves the tape forward one record.

Search Forward to File Mark (0013)

This code advances the tape until a file mark is detected. If no file marks are detected, tape motion continues until all the tape is on the takeup reel.

*602 Tape Units only

Search Backward to File Mark (0014)

This code backspaces tape until a file mark or load point is detected. If the tape is at load point, it backspaces the tape until either a file mark is detected or the tape is unloaded.

Write File Mark (0015)

This code advances the tape about 6 inches, then writes a 17_8 file mark followed by a 17_8 check character. Both are written in even vertical parity. This file mark is used with both BCD and Binary modes. Writing a file mark does not affect the selected format (BCD or binary).

Skip Bad Spot (0016)

This code erases at least 4 inches of tape. Vertical and longitudinal parity checks are made to insure complete erasure.

Select Interrupt on Ready and Not Busy (0020)

This code conditions the controller to send an Interrupt signal to the processor when the tape unit is in a Ready and Not Busy condition (i. e., when power is applied, the unit is under computer control, and all tape motion has ceased). Once up, the Interrupt signal can be cleared by selecting release (0021) or by clearing the control.

Release Interrupt on Ready and Not Busy (0021)

This code clears an Interrupt on Ready and Not Busy selection and the Interrupt signal if it is up.

Select Interrupt on End of Operation (0022)

This code conditions the controller to send the Interrupt signal to the processor when the data channel terminates a Read or Write operation, when a tape unit senses the end of a record during a Read operation, or upon completion of an operating function. Once up, the Interrupt signal remains up until cleared by reselecting the interrupt (0022), selecting release (0023), or clearing the control.

During a chaining operation, * interrupt does not occur until the data channel is Not Busy (i. e., until the last record has been written/read in the chaining operation).

Release Interrupt on End of Operation (0023)

This code clears an Interrupt on End of Operation selection and the Interrupt signal if it is up.

Select Interrupt on Abnormal End of Operation (0024)

This code conditions the controller to send an Interrupt signal to the processor after an abnormal condition occurs. These abnormal conditions are End of Tape, File Mark, ** Load Point, ** Vertical Parity Error, Longitudinal Parity Error, Lost Data, parity error during a Skip Bad Spot operation, and connected tape unit becoming Not Ready.

In all but the last case, the interrupt occurs when one or more of these conditions are encountered and when an end of record check character is written/read by the tape unit. In the case of interrupt on connected tape unit becoming Not Ready, interrupt occurs immediately when the connected tape unit goes from a Ready to a Not Ready condition (e. g., if the power is turned off on the tape unit). Interrupt on connected tape unit becoming Not Ready does not occur during a Connect operation or when a Release code (0000) is executed.

A new Read/Write operation cannot start until the Interrupt signal is cleared. Once up, the Interrupt signal can be cleared by reselecting the interrupt (0024), selecting release (0025), or a Master Clear.

Release Interrupt on Abnormal End of Operation (0025)

This code clears an Interrupt on Abnormal End of Operation selection and the Interrupt signal if it is up.

*Clear Reverse Read (0040)****

This code clears the condition set by the Set Reverse Read code.

*3400/3600/3800 systems only

**Common to Interrupt on End of Operation and Interrupt on Abnormal End of Operation

***602 Tape Units only

*Set Reverse Read (0041)**

This code must precede a Reverse Read operation (see Reverse Read section).

STATUS CODES

Ready (XXX1)

Bit 0 is set when the tape unit is in a Ready condition (i. e., power is applied and the Ready switch is lighted; the tape controller can operate the unit). If the unit is Not Ready, ensure that the connected unit is physically present and that the Ready switch is lighted (see Connect).

Channel and/or Read/Write Control and/or Unit Busy (XXX2)

If the tape unit is Ready, bit 1 is set when the channel is transmitting or receiving data during an Input/Output operation. It is also set if the unit is Ready and tape motion is initiated by an operating function code. In these two cases, it remains set until 5 milliseconds after tape motion stops. Bit 1 is cleared approximately 5 milliseconds after either detection of lost data or an Abnormal End of Operation Interrupt signal and cannot be reset until these conditions cease to exist. Bit 1 cannot be set if bit 0 is clear.

Write Enable (XXX4)

Bit 2 is set when the file protection ring is on the tape reel. When this ring is present, it is possible to read from and write on the tape. When this ring is absent, it is possible to read from but not write on the tape.

File Mark (XX1X)

Bit 3 is set whenever a file mark is read.** It remains set until a new operating function, a Read/Write operation, or a clearing operation is initiated or, and this is unique to the 3127, until a new unit is connected or the same unit is reconnected.

*602 Tape Units only

**If a file mark is detected during a Search Backward to File Mark and this is followed by a Read forward, the file mark is the first record read.

Load Point (XX2X)

Bit 4 is set when the tape is at load point. It is cleared when the tape moves off the load point.

End of Tape (XX4X)

Bit 5 is set when an end of tape marker is detected. It is cleared when the end of tape marker is sensed during a Rewind or a Reverse Read,* or, and this is unique to the 3127, by a new Connect.

Density (X1XX)

Density (X2XX)

	<u>Bit 7</u>	<u>Bit 6</u>
200 BPI	0	0
556 BPI	0	1
800 BPI	1	0

Lost Data (X4XX)

Bit 8 is set when the data channel cannot transmit or accept data at the rate required by the tape unit. Tape motion stops when bit 8 is set and cannot be restarted until this bit has been cleared by a new Connect or function code or Master Clear (see Programming Considerations).

When operating from a 160/160-A Computer via a 3681 Data Channel Converter, lost data is also detected if the read or write selection in the 3681 Converter is not cleared immediately after a Read or Write operation is completed. As long as a Write signal is present and the Data signal is not present at the required time, the controller assumes that a data transmission loss has occurred and a Lost Data signal is sent. If the Read signal is present but data is not being accepted by the channel, lost data also occurs. If is, therefore, necessary to clear the read or write selection in the 3681 Converter immediately after a Read or Write operation is completed to prevent the Lost Data signal from being sent abnormally. If the Lost Data signal is present, it must be cleared if Read or Write operations are to continue.

*Reverse Read is possible with 602 Tape Units only.

End of Operation (1XXX)

Bit 9 is set when the data channel terminates a Read or Write operation, when a tape unit senses the end of a record during a Read operation, or upon completion of an operating function. It remains up until a new Read/Write operation, operating function, or clearing operation is initiated.

Vertical or Longitudinal Parity Error (2XXX)

Bit 10 is set following detection of either a vertical or longitudinal parity error while reading or writing or reading a file mark while in Binary mode. It is cleared by initiating a new Read, Write, or clearing operation. If this bit is set during a chaining operation due to detection of a vertical parity error or due to detection of a longitudinal parity error, it cannot be cleared until the chaining operation terminates.

SWITCHES AND INDICATORS

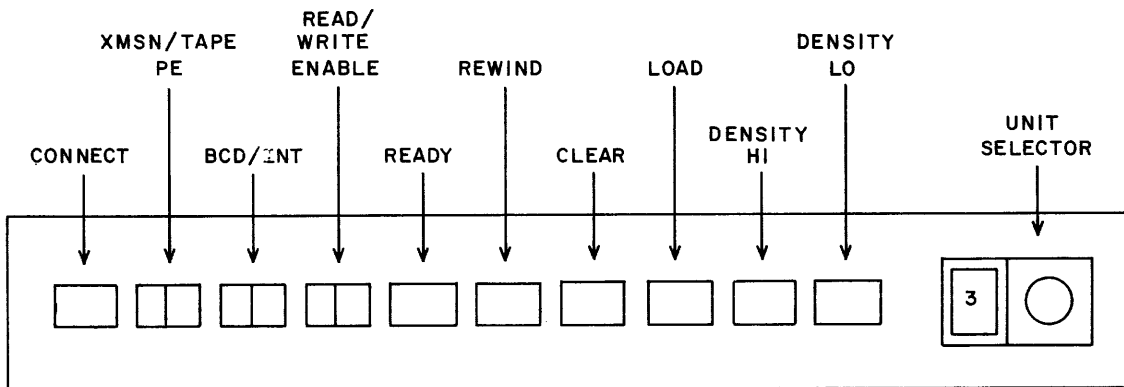

Figure D-2. 601 Control Panel*

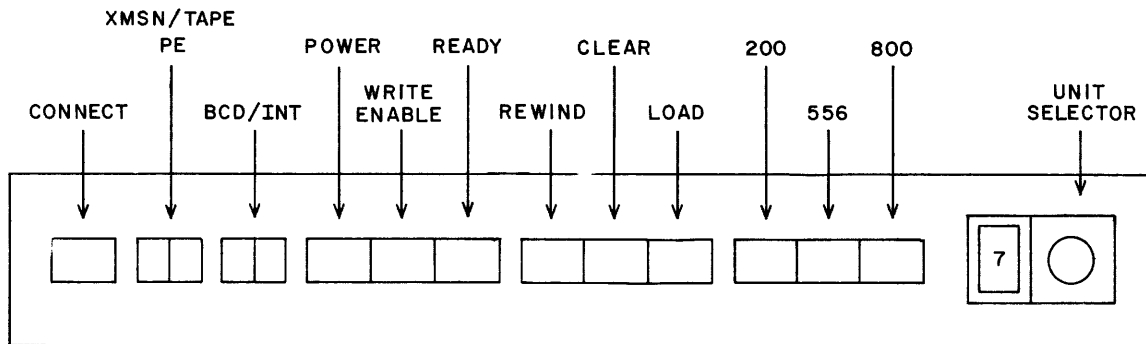

Figure D-3. 602 Control Panel*

*The three switches located on the left are only on the unit containing the 3127 Controller.

EQUIPMENT NUMBER SWITCH

An eight-position Equipment Number switch is associated with each read/write control. The setting of this switch (0-7) designates the control and corresponds to the N portion of the Connect code. It also determines the number of the interrupt transmission line that the equipment uses. It is located on the logic chassis.

CONNECT INDICATOR

The CONNECT indicator is lighted when the controller is connected to the data channel.

XMSN PE (TRANSMISSION PARITY ERROR) INDICATOR

The XMSN PE indicator is lighted when a transmission parity error is detected. It remains lighted until cleared by a Clear Channel instruction or a Master Clear.

TAPE PE INDICATOR

The TAPE PE indicator is lighted when an equipment parity error is detected. It remains lighted until cleared by a new Read, Write, Clear Channel instruction, or Master Clear.

INT (INTERRUPT) INDICATOR

This indicator lights when an interrupt occurs. This indicator remains lighted until the Interrupt signal drops.

BCD INDICATOR

This indicator lights when BCD mode is selected or a file mark is being written on tape.

MANUAL CONTROLS

601 Unit Selector Switch

An eight-position switch is mounted on each 601 Tape Unit. The setting of this switch (0-7) designates the unit. The unit is in a Standby mode until placed in the Ready mode.

602 Unit Selector Switch

An eight-position switch is mounted on each 602 Tape Unit. The setting of this switch (0-7) designates the unit. The unit is in a Standby mode until placed in the Ready mode.

POWER Switch/Indicator

This switch turns off tape power. It is lighted when power is on.

REWIND Switch/Indicator

This switch rewinds the tape to load point. It is lighted during this operation.

WRITE ENABLE Indicator

This indicator is lighted when the file protection ring is in place on the tape reel.

LOAD Switch/Indicator

This switch moves tape forward to load point. It is lighted when the tape is at load point.

READY Switch/Indicator

This switch places the unit under processor control. It is lighted while the unit is under processor control.

CLEAR Switch/Indicator

This switch master clears the tape unit. It places the unit under manual control. It is lighted when the unit is under manual control.

DENSITY LO* Switch/Indicator

This switch selects low density. It is lighted when low density is selected.

*601 Tape Units

DENSITY HI* Switch/Indicator

This switch selects high density. It is lighted when high density is selected.

200** Switch/Indicator

This switch selects 200 bits per inch density. It is lighted when this density is selected.

556** Switch/Indicator

This switch selects 556 bits per inch density. It is lighted when this density is selected.

800** Switch/Indicator

This switch selects 800 bits per inch density. It is lighted when this density is selected.

OPERATION AND PROGRAMMING

CLEARING THE CONTROLLER

Prior to the initial use of the tape controller, the system should be cleared. There are five possible ways of clearing the controller:

1) Clear Channel*** (100 microseconds)

This instruction:

- a) Clears all activity in the data channel.
- b) Clears the present connection control N may have with a tape unit.
- c) Performs a Master Clear on control N read, write, and function logic. No status signals are available to the data channel after executing this instruction.

*601 Tape Units

**602 Tape Units

***See the individual processor instructions.

- 2) Clear (0005) (2 microseconds)
This function code clears the present connection control N may have with a tape unit. Control N remains connected in the sense that status signals are still available for the data channel.
- 3) Release (0000)
This function code clears the connection for the connected tape unit.
- 4) Power On Master Clear
When power is applied to the 3127 Controller, all tape units are cleared. Logic in all controls is also cleared. No status signals are available to the data channel after power is applied.
- 5) External Master Clear
This clears all tape units. It also clears the logic in all controls. No status signals are available to the data channel after executing this operation.

The Clear and Release codes can only be used after a control is connected to a tape unit.

All clear operations (except the Release code) place the 3127 Controller in binary format.

REVERSE READ*

The 602 Tape Units can read data while the tape is moving in a reverse direction. Thus, the last character written on the tape will be the first one read. If the Set Reverse Read function code (0041) is sent to the control and a Read operation is initiated, the control assembles the characters received in reverse order. Thus, the 12-bit bytes sent to the data channel are identical to those originally sent to the tape unit.

When the control is used in a 3400, 3600, or 3800 system, the data channel assembles the bytes in reverse order and stores the assembled word in core. When used in a 3100 or 3200 system, a Reverse Read instruction must be used to accomplish the same results.

Vertical and longitudinal parity checking occur as in a normal Read operation, except if the first frame read is a record check character, no vertical parity check is made on that character. Vertical parity checking is performed on the remaining frames.

*602 Tape Units only

If a Reverse Read is attempted from load point, there is no tape motion. The Read operation hangs up.

Parity errors and interrupts may be handled as if the operation were a normal Read. An End of Record signal is returned to the data channel when a record gap is reached. Chaining and nonstop Read operations are also handled as if the operation were a normal Read.

Function code 0040 (Clear Reverse Read) should be issued when the Reverse Read operation terminates.

PROGRAMMING CONSIDERATIONS

Suppress Assembly/Disassembly

If data is to be assembled from a tape that was recorded in Suppress Assembly/Disassembly mode, * assembly difficulties may be encountered. The problem is that in Suppress Assembly/Disassembly mode, an odd number of frames may be written on the tape. If this occurs and the tape is read forward, the controller automatically fills in bits 0 through 5 of the last input byte with "0's". If an odd number of frames are written and a Reverse Read is attempted, the inverted assembly is one frame out of order, and bits 6 through 11 of the last data channel word are filled in with "0's".

Lost Data

The Lost Data condition occurs in two cases:

- 1) When the data channel cannot supply or accept data at the rate required by the tape unit due to competition from other devices for access to storage.
- 2) When certain malfunctions occur in the data channel.

A Lost Data condition causes data transfer to stop, stops tape motion (at the next record gap), and sets the lost data status bit. A new Read or Write operation cannot begin until the Lost Data condition is cleared by a Master Clear, Clear Channel instruction, or new Connect or function operation. In most cases, the Lost Data condition leaves the data channel active (i. e., the Read or Write operation remains uncompleted).

*3100/3200 systems

Thus, a new Connect or Function operation cannot be initiated until the Channel Active condition is cleared by a Master Clear, Clear Channel instruction, or Stop Channel Activity function code.*

Nonstop Operation

If a new Read signal is returned to the control within 2 milliseconds after an interrupt, an End of Operation signal is transmitted and the Read operation is nonstop. If the time exceeds 2 milliseconds, tape motion stops and restarts.

601 AND 602 TAPE UNIT OPERATION

This section contains general information which the operator must understand before undertaking any magnetic tape operations. Additional information for CONTROL DATA 601 Tape Units is contained in Pub. No. 40815300; for 602 Tape Units, Pub. No. 40815500.

Application of Power

- 1) Open lower door at front of cabinet.
- 2) Place the Main Power circuit breaker (at power supply) in ON position. The Main Power indicator should light.
- 3) Place the remaining circuit breakers (at power supply) to the ON position.
- 4) Press the Power switch at the maintenance panel (lower front) to the ON position for approximately two seconds, then release.
- 5) Observe the POWER indicator at the control panel (upper front). If it is not lighted, repeat the procedure. If it still fails to light, notify maintenance personnel.
- 6) Close lower front door.

The Power switch at the upper control panel is used only to remove power from the unit. Once this switch is pressed, steps 4, 5, and 6 must be repeated to restore primary power.

*3600/3800 systems only

Tape Load Procedure

- 1) Open the reel door.
- 2) Remove the supply reel from the plastic tape reel container, handling it by the center hole and edges only. Do not squeeze the sides together. Keep the tape container closed at all times to prevent contamination.
- 3) Check the file protection ring on the back of the supply reel. If the tape is not to be written on, the ring should be removed, if the tape is to be written on, make sure the ring is in place. Use care while removing the file protection ring. The ring should never be removed while the tape is loaded in the loop boxes.
- 4) Mount the supply reel on the left hub. To insure proper reel alignment, push the reel firmly against the hub stop before tightening the hub knob. The WRITE ENABLE indicator should light when a reel with a ring is mounted.
- 5) Open the central door which covers the read/write heads and capstan assembly.
- 6) Pull sufficient tape from the supply reel to reach the take-up reel. Thread the tape under the left load arm roller, between the members of the pinch roller assembly, under the lower roller of the right loop box, inside the upper idler roller, and to the inside of the take-up reel (see Figure D-4). Allow sufficient tape slack to wind two or three turns of tape on the take-up reel.
- 7) Rotate the take-up reel with a finger in the recessed finger hole on its front surface. Never rotate a reel with a finger in the cut-out, as it may nick or curl the guiding edge of the tape.
- 8) Set the Unit Selector switch to one of eight positions (0-7) to assign a logical program selection number. This number must correspond to the tape unit addressed by the program.
- 9) Close the central (head cover) door.
- 10) Press the LOAD switch on the upper control panel. This causes the LOAD indicator to light, the tape to load into the vacuum loop boxes, and the tape load arms to move down, thus positioning the tape over the read/write heads and onto the tape guide rollers. The tape stops upon sensing load point.

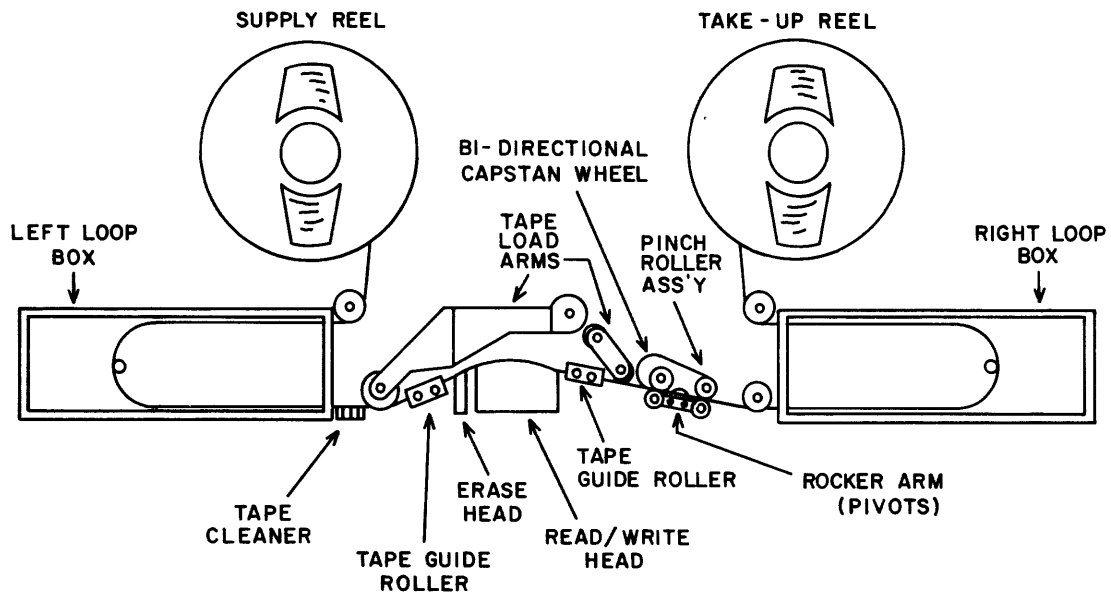

- 11) Select the desired density by pressing the DENSITY HI or DENSITY LO* switch on the upper control panel. The appropriate indicator should light.
- 12) To place the tape unit under computer control, press the READY switch on the upper control panel. The READY indicator should light.
- 13) Close the reel door. If the tape unit fails to function as described, notify maintenance personnel.

Tape Unload Procedure

- 1) Press the REWIND switch on the control panel. This draws the tape from the take-up reel onto the supply reel. Tape motion stops when the load point marker is sensed.
- 2) Press the REWIND switch while at load point. This causes the vacuum to be dropped from the loop boxes and the tape load arms to rise, thus disengaging the tape.
- 3) Open the reel door. The operator must now complete the tape unload process by manually winding the remaining tape onto the supply reel.

*200, 556, or 800 on 602 Tape Units

SECTION E

3128-A/B MAGNETIC TAPE CONTROLLERS

CONTENTS

Functional Description	E-1	Function Codes	E-8
System Relationships	E-1	Status Codes	E-11
Tape Unit Designation	E-2	Switch and Indicators	E-13
Assembly/Disassembly	E-2	Equipment Number Switch	E-13
Data Transmission	E-2	Connect Indicator	E-13
BCD/Binary Modes	E-2	XMSN PE (Transmission Parity Error) Indicator	E-14
BCD Code Conversion	E-3	TAPE PE Indicator	E-14
Connect	E-3	INT (Interrupt) Indicator	E-14
Record/File Formats	E-3	BCD Indicator	E-14
Transfer Rates	E-4	Operation and Programming	E-14
Function	E-4	Clearing the Controller	E-14
Parity Checking	E-4	Reverse Read	E-15
Transmission Parity Checking	E-4	Programming Considerations	E-16
Equipment Parity Checking	E-6	Suppress Assembly/ Disassembly	E-16
Codes	E-7	Lost Data	E-16
Connect Code	E-8	Nonstop Operation	E-17

FIGURES

E-1 Typical System Configuration	E-1	E-2 3128 Magnetic Tape Controller Indicator	E-13
----------------------------------	-----	--	------

TABLES

E-1 Connect, Function, and Status Codes	E-7
--	-----

3128-A/B MAGNETIC TAPE CONTROLLERS

This section contains reference information for the CONTROL DATA[®] 3128-A/B Magnetic Tape Controller. The two models covered are identical except for input power requirements. The 3128-A requires 60-hertz power and the 3128-B requires 50-hertz power.

FUNCTIONAL DESCRIPTION

SYSTEM RELATIONSHIPS

The single-channel 3128 Magnetic Tape Controller controls the flow of data between a 3000 Series Computer System and as many as eight CONTROL DATA[®] 608 Magnetic Tape Transports (one at a time). The controller communicates with the computer through a 3X06 Communication channel or a 3681 Data Channel Converter. Figure E-1 shows a typical configuration using this controller.

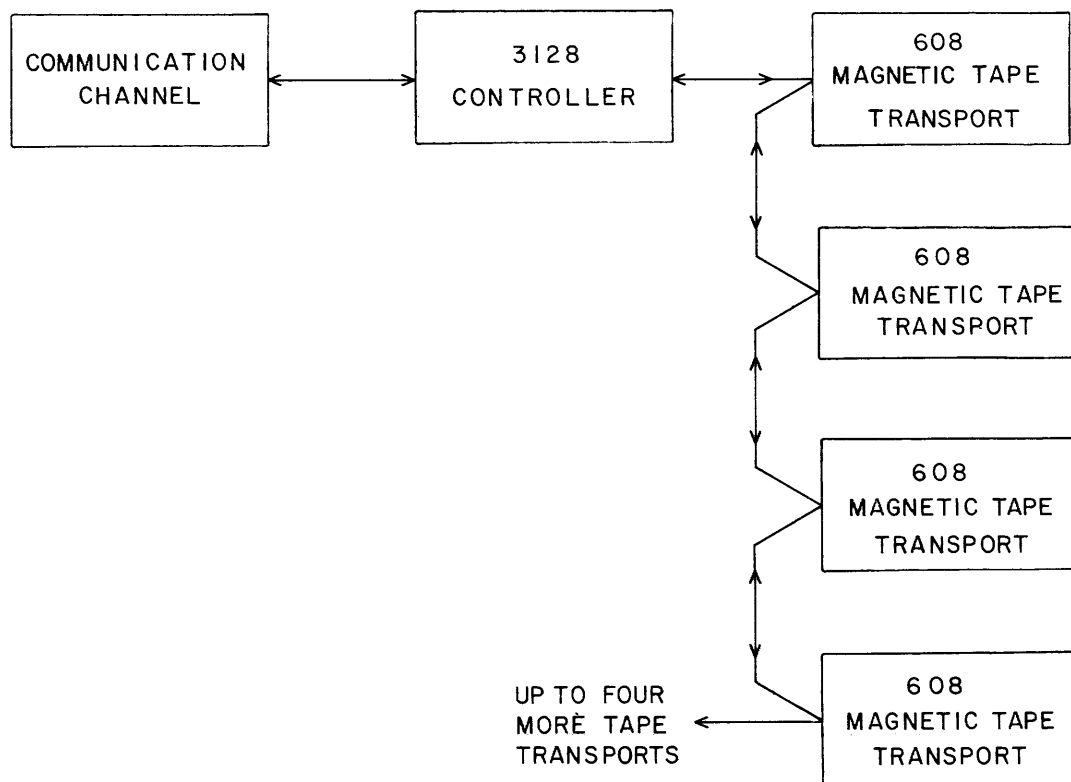

Figure E-1. Typical System Configuration

TAPE UNIT DESIGNATION

The controller recognizes tape units by the numerical designations displayed on the front of the tape units. A designation can be changed by means of a knob on the designation display. If a designation display is at STANDBY, that tape unit is inactivated and cannot be contacted by the controller.

ASSEMBLY/DISASSEMBLY

During Read operations, data is sent from the tape unit to the controller in characters of 6 bits each. Two successive 6-bit characters are normally assembled by the controller into a 12-bit byte for transmission to the communication channel. This assembly procedure can be suppressed so that the data is transmitted to the communication channel in unassembled 6-bit characters. A Character Input instruction (INPC or INAC* in 3100/3200 computer language) accomplishes the suppression.

During Write operations, the 12-bit bytes received by the controller from the communication channel are disassembled into 6-bit characters for transmission to the tape unit. This disassembly procedure can be suppressed so that only the lower 6 bits of the 12-bit byte are transmitted to the tape unit. A Character Output instruction (OUTC or OTAC* in 3100/3200 computer language) accomplishes the suppression.

DATA TRANSMISSION

BCD/Binary Modes

Data may be controlled in either BCD (binary coded decimal) mode or Binary mode. Binary mode is used following a clearing operation or the selection of Binary mode. BCD mode must be selected. BCD mode uses even parity and Binary mode uses odd parity. An all zero code is illegal if the controller is operating in BCD mode and the computer is operating in 1604 mode.

*INAC and OTAC are effective only when the controller is operated with a 24-bit data channel.

BCD Code Conversion

The BCD code used by the computer (internal) differs from the BCD code (external) used by the tape unit. The controller converts internal BCD to external BCD for a Write operation and converts external BCD to internal BCD for a Read operation. The 3600 and 3800 Computer Systems can operate internally with external BCD by means of a 1604 mode. When the 1604 mode is being used, the computer develops a Negate BCD Conversion signal for the controller.

CONNECT

If the controller is Ready and Not Busy, it will connect with the communication channel upon receipt of a valid Connect code. When a Connect code is accepted, the controller sends a Reply signal to the communication channel. If the controller is not ready for operation (Ready indicator not lighted) upon receipt of the Connect code, a Reject signal is sent to the communication channel. An invalid Connect code or a parity error in the code will also prevent a connection.

To be valid, a Connect code must carry the proper controller unit designation and a proper tape unit designator. The lower 12 bits of the code carry these designators. In a Connect Tape Unit code N00U, the bits represented by N contain the controller designator and the bits represented by the U contain the tape unit designator.

If a parity error (indicated by lighted PARITY ERROR indicators) has prevented connection, a Clear Channel instruction or a Master Clear must be performed before another attempt to connect is made.

Record/File Formats

A record consists of the data produced by a single output instruction. To mark the end of a record, the controller automatically inserts a record gap after each record.

A file consists of any number of records as determined by the program. To mark the end of a file, a File Mark code must be programmed.

When a record gap or file mark is detected during a Read operation, the controller sends an End of Record signal to the communication channel.

Transfer Rates

This controller can transfer data at rates of either 7,500 characters per second (200 BPI density), 20,850 characters per second (556 BPI density), or 30,000 characters per second (800 BPI density). Time used per frame is 132 microseconds at 200 BPI, 48 microseconds at 556 BPI, and 32 microseconds at 800 BPI.

FUNCTION

After the connect has been accomplished, the computer operates the controller non-read or write operations by means of function code instructions.

The three general classes of function codes are: tape motion, nonoperating, and interrupt. A tape motion code, such as Rewind or Search to Forward File Mark, causes the controller to command tape motion. A nonoperating code, such as Format or Density causes a change in the mode or condition of controller operation. An Interrupt code, such as Interrupt on Ready or Interrupt on End of Operation, selects a condition which will cause the controller to send an Interrupt signal to the communication channel. Table E-1 contains a complete list of the function codes and the text following the table describes the codes. The controller examines each function code it receives. If the code is legitimate and has proper parity, the controller accepts the code, returns a Reply signal, and if a tape motion operation is not being performed, starts the operation. If there is a parity error in the code, the controller will reject the code and return a Parity Error signal. While a tape motion function is in operation, the controller will reject any tape motion function codes and will reply with a Reject signal.

Nonoperating function codes are accepted at any time but are stored until the start of the next tape motion operation. Interrupt select function codes are accepted at any time and become operative the next time the selected interrupt conditions occur.

PARITY CHECKING

Transmission Parity Checking

Connect codes, function codes, and data are received from and transmitted to the communication channel in bytes with odd parity, that is, with an odd number of "1" bits. Any byte received with an even number of bits is therefore considered erroneous.

Parity Error in a Connect Code: If a parity error is detected, there is no connect. Neither a Reply nor a Réject signal is returned to the communication channel but the Parity Error indicators on the controller and tape unit light. This condition must be cleared by the controlling computer before the controller and its tape unit can be connected.

Parity Error in a Function Code: If a parity error is detected, the function command is ignored, a Parity Error signal is returned to the communication channel, and the Transmission Parity Error indicator lights. This condition must be cleared by the controlling computer and a connect must be accomplished before the controller will accept another Function code. The controller may continue to operate after detecting the parity error, but it is good practice to stop the operation and to perform a clearing operation because information received subsequent to the error detection is not reliable.

Parity Errors in Output Data: If a parity error is detected in the data being supplied for a Write operation, the controller transmission Parity Error indicator will light and Reply and Parity Error signals will be sent to the communication channel. If the program has not been set up to sense parity errors, the data will continue to be written. Because data received subsequent to a parity error is not reliable, it is good practice to execute a Clear and a new connect before continuing operation.

Parity Errors in Input Data: If a parity error is detected by the communication channel during a Read operation, the communication channel or computer system console Parity Error indicator will light. The Read operation will continue to enter information into storage unless provision has been made for sensing the error and interrupting the operation. The parity error indications can be cleared by a Clear Channel or a Master Clear instruction. In a 3100 or 3200 Series Computer a new Read or Write instruction will also clear the error condition. After a clearing operation, the controller and tape unit must be reconnected.

Input/Output Parity Error Bit in the Communication Channel: Whenever the controller detects a parity error, the tape Parity Error FF sets. The condition of this FF sets the input/output parity error bit in the communication channel. This condition can be used to interrupt the computer system operation. In a 3400, 3600, or 3800 Series Computer, an interrupt occurs if the interrupt system is active. In a 3100 or 3200 Series Computer, instructions must be issued to sense the parity error and to cause an interrupt.

For detailed information on the input/output parity error bit, refer to the appropriate computer system reference manual.

Equipment Parity Checking

A parity checking Read operation follows approximately 8 or 9 milliseconds after every Write operation. The information being read is parity checked by the controller to confirm that the information on the tape is an accurate recording. The controller also checks parity during independent Read operations to confirm that no information has been lost since the recording was made.

As part of the Write operation, the controller establishes the proper parity. Vertical parity is established by adding a parity "1" bit to every character which does not have the appropriate number of "1" bits. All Binary characters are written with an odd number of "1" bits (odd parity) and all BCD characters are written with an even number of "1" bits (even parity). Longitudinal parity, which is always even parity, is established by writing a parity character at the end of each record. The parity character contains a "1" bit in every track which does not otherwise have an even number of "1" bits.

Vertical Parity Error Checking: Vertical parity refers to the number of "1" bits in a single frame (a transverse row of bit positions) of recorded information. Six tracks are used for recording information and a seventh track is used for parity bits. An odd number of bits is written for Binary characters and an even number of bits is written for BCD characters. If an improper number of bits is detected during a Read operation, a parity error exists.

When a vertical parity error is detected, the controller Parity Error indicator lights and the Tape Parity Error FF is set. This condition can be programmed to cause an Abnormal End of Operation interrupt. A new Read, Write, Clear Channel, or Master Clear is required to clear the error condition.

Longitudinal Parity Error Checking: Longitudinal parity refers to the number of "1" bits in each tape track of a record. At the end of each record, a frame of longitudinal parity bits is written. Because longitudinal parity is always even, the total number of bits in each track is made even during a Write operation. If an odd number of bits is detected during a Read operation, a parity error exists.

When a longitudinal parity error is detected, the controller Parity Error indicator lights and the Tape Parity Error FF is set. This condition can be programmed to cause an Abnormal End of Operation interrupt. A new Read, Write, Clear Channel, or Master Clear is required to clear the error condition.

CODES

Table E-1 lists the numerical codes for all connect, function, and status codes which are usable with this controller. In the discussion of bit positions, the bits are numbered from right to left so bit "0" refers to the bit at the extreme right. An "X" is used in place of a numerical character which is determined by some other factor than that being described.

TABLE E-1. CONNECT, FUNCTION, AND STATUS CODES

CONNECT CODE	
Connect Tape Unit	N00U*
FUNCTION CODES	
Release Connected Unit	0000
Binary Format Select	0001
BCD Format Select	0002
556 BPI Density Select	0003
200 BPI Density Select	0004
Clear	0005
800 BPI Density Select	0006
Rewind	0010
Rewind Unload	0011
Backspace	0012
Search Forward to File Mark	0013
Search Backward to File Mark	0014
Write File Mark	0015
Skip Bad Spot	0016
Select Interrupt on Ready and Not Busy	0020
Release Interrupt on Ready and Not Busy	0021
Select Interrupt on End of Operation	0022
Release Interrupt on End of Operation	0023
Select Interrupt on Abnormal End of Operation	0024
Release Interrupt on Abnormal End of Operation	0025
Clear Reverse Read	0040
Set Reverse Read**	0041
<p>*"N" represents the numerical designator for the controller and "U" represents the designator of a tape unit.</p> <p>**The tape will move forward if a Backspace operation is executed with this function code in operation.</p>	

TABLE E-1. (Cont'd)

STATUS CODES	
Ready	XXX1
Channel, Controller, or Tape Unit Busy	XXX2
Write Enable	XXX4
File Mark Detected	XX1X
Load Point Detected	XX2X
End of Tape Detected	XX4X
200 BPI Density	"0" in bits 6 and 7
556 BPI Density	"1" in bit 6
800 BPI Density	"1" in bit 7
Lost Data	X4XX
End of Operation	1XXX
Vertical or Longitudinal Parity Error	2XXX

CONNECT CODE

Connect Tape Unit (N00U)

This code connects the desired unit. N is the equipment number of the controller. U is the unit number of a specific tape unit.

FUNCTION CODES

Release Connected Unit (0000)

This code clears the existing unit connection.

Binary Format Select (0001)

This code causes all data to be written/read in binary format.

Coded (0002)

This code causes all data to be written/read in BCD format.

556 BPI Density Select (0003)

This code causes all data to be written/read at 556 bits per inch density.

200 BPI Density Select (0004)

This code causes all data to be written/read at 200 bits per inch density.

Clear (0005)

This code clears the existing unit connection.

800 BPI Density Select (0006)

This code causes all information to be written/read at 800 bits per inch density.

Rewind (0010)

This code rewinds tape at high speed (400 inches per second) to load point. It has no effect when the tape is at load point.

Rewind Unload (0011)

This code rewinds the tape at high speed to load point and clears the Ready condition. The remainder of this process must be completed manually.

Backspace (0012)

This code backspaces the tape one record or until load point is detected. If the tape is at load point and if fewer than two frames precede the load point, it unloads the tape. If Reverse Read is selected, a Backspace selection moves the tape forward one record.

Search Forward to File Mark (0013)

This code advances the tape until a file mark is detected. If no file marks are detected, tape motion continues until all the tape is on the takeup reel.

Search Backward to File Mark (0014)

This code backspaces tape until a file mark or load point is detected. If the tape is at load point, it backspaces the tape until either a file mark is detected or the tape is unloaded.

Write File Mark (0015)

This code advances the tape about 6 inches, then writes a 17_8 file mark followed by a 17_8 check character. Both are written in even vertical parity. This file mark is used with both BCD and Binary modes. Writing a file mark does not affect the selected format (BCD or binary).

Skip Bad Spot (0016)

This code erases at least 4 inches of tape. Vertical and longitudinal parity checks are made to insure complete erasure.

Select Interrupt on Ready and Not Busy (0020)

This code conditions the controller to send an Interrupt signal to the processor when the tape unit is in a Ready and Not Busy condition, (that is, when power is applied, the unit is under computer control and all tape motion has ceased). Once up, the Interrupt signal can be cleared by selecting release (0021) or by clearing the control.

Release Interrupt on Ready and Not Busy (0021)

This code clears an Interrupt on Ready and Not Busy selection and the Interrupt signal if it is up.

Select Interrupt on End of Operation (0022)

This code conditions the controller to send the Interrupt signal to the processor when the data channel terminates a Read or Write operation, when a tape unit senses the end of a record during a Read operation, or upon completion of an operating function. Once up, the Interrupt signal remains up until cleared by reselecting the interrupt (0022), selecting release (0023), or clearing the control.

During a chaining operation (3400, 3600, 3800 only) interrupt does not occur until the data channel is Not Busy (i. e., until the last record has been written/read in the chaining operation).

Release Interrupt on End of Operation (0023)

This code clears an Interrupt on End of Operation selection and the Interrupt signal if it is up.

Select Interrupt on Abnormal End of Operation (0024)

This code conditions the controller to send an Interrupt signal to the processor after an abnormal condition occurs. These abnormal conditions are End of Tape, File Mark, Load Point, Vertical Parity Error, Longitudinal Parity Error, Lost Data, Parity Error during a Skip Bad Spot operation and connected tape unit becoming Not Ready.

In all but the last case, the interrupt occurs when one or more of these conditions are encountered and when an end of record check character is written/read by the tape unit. In the case of interrupt on connected tape unit becoming Not Ready, interrupt occurs

immediately when the connected tape unit goes from a Ready to a Not Ready condition (e.g., if the power is turned off on the tape unit). Interrupt on connected tape unit becoming Not Ready does not occur during a Connect operation or when a Release code (0000) is executed.

A new Read/Write operation cannot start until the Interrupt signal is cleared. Once up, the Interrupt signal can be cleared by reselecting the interrupt (0024), selecting release (0025), or a Master Clear.

Release Interrupt on Abnormal End of Operation (0025)

This code clears an Interrupt on Abnormal End of Operation selection and the Interrupt signal if it is up.

Clear Reverse Read (0040)

This code clears the condition set by the Set Reverse Read code.

Set Reverse Read (0041)

This code must precede a Reverse Read operation (see Reverse Read section).

STATUS CODES

Ready (XXX1)

Bit 0 is set when the tape unit is in a Ready condition (i.e., power is applied and the Ready switch is lighted; the tape controller can operate the unit). If the unit is Not Ready, check to see that the connected unit is physically present and that the Ready switch is lighted (see Connect).

Channel, Controller, or Tape Unit Busy (XXX2)

If the tape unit is Ready, bit 1 sets when the channel is transmitting or receiving data during an Input/Output operation. Bit 1 is also set if the unit is Ready and tape motion is initiated by an operating function code. In these two cases, bit 1 remains set until 5 milliseconds after tape motion stops, and is cleared approximately 5 milliseconds after detection of lost data or an Abnormal End of Operation Interrupt signal. Bit 1 cannot be reset until these conditions cease to exist and cannot be set if bit 0 is clear.

Write Enable (XXX4)

Bit 2 sets when the file protection ring is on the tape reel. When this ring is present, it is possible to read from and write on the tape. When this ring is absent, it is possible to read from but not to write on the tape.

File Mark (XXIX)

Bit 3 sets whenever a file mark is read.* It remains set until an operating function, a Read/Write operation, a clearing operation, or a connect has been accomplished.

Load Point Detected (XX2X)

Bit 4 sets when the tape is at load point. It is cleared when the tape moves off the load point.

End of Tape Detected (XX4X)

Bit 5 sets when an end of tape marker is detected. It is cleared when the end of tape marker is sensed during a Rewind, a Reverse Read, or when a new correct is accomplished.

Density (X1XX) (X2XX)

	<u>Bit 7</u>	<u>Bit 6</u>
200 BPI Density	0	0
556 BPI Density	0	1
800 BPI Density	1	0

Lost Data (X4XX)

Bit 8 sets when the communication channel cannot transmit or accept data at the rate required by the tape unit. Tape motion stops when bit 8 is set and cannot be restarted until this bit has been cleared by a new Connect, function code, or Master Clear (see Programming Considerations).

When operating from a 160/160-A Computer via a 3681 Data Channel Converter, lost data is also detected if the read or write signal in the Converter is not cleared immediately after a Read or Write operation is completed. With a Write signal present and the Data signal not present at the required time, the controller assumes that a data transmission loss has occurred and sends a Lost Data signal. If the Read signal is

*If a file mark detected during a Search Backward to File Mark is followed by a Read forward, the file mark is the first record to be read.

present but data is not being accepted by the channel, lost data also occurs. It is, therefore, necessary to clear the read or write selection in the Converter immediately after a Read or Write operation has been completed to prevent the Lost Data signal from being sent abnormally. If the Lost Data signal is present, it must be cleared before Read or Write operations can continue.

End of Operation (1XXX)

Bit 9 sets when the data channel terminates a Read or Write operation, when a tape unit senses the end of a record during a Read operation, or when an operating function finishes. It remains up until a new Read/Write operation, operating function, or clearing operation is initiated.

Vertical or Longitudinal Parity Error (2XXX)

Bit 10 sets at the detection of a vertical or longitudinal parity error during Read, Write, or Read File Mark operations while in Binary mode. Bit 10 is cleared by a Read, Write, or Clearing operation. If this bit is set during a chaining operation it cannot be cleared until the chaining operation terminates.

SWITCH AND INDICATORS

EQUIPMENT NUMBER SWITCH

The equipment number switch is an eight-position switch/indicator which is mounted on the rear of the logic chassis inside the cabinet. The setting of this switch/indicator is the designator by which the communication channel recognizes the controller.

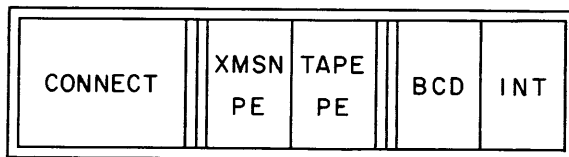

Figure E-2. 3128 Magnetic Tape Controller Indicator

CONNECT INDICATOR

The CONNECT indicator lights when the controller is connected to the communication channel.

XMSN PE (TRANSMISSION PARITY ERROR) INDICATOR

The XMSN PE indicator lights when a transmission parity error is detected. It remains lighted until cleared by a Clear Channel instruction or a Master Clear.

TAPE PE INDICATOR

The TAPE PE indicator lights when an equipment parity error is detected. It remains lighted until cleared by a new Read, Write, Clear Channel instruction, or a Master Clear.

INT (INTERRUPT) INDICATOR

This indicator lights when an interrupt occurs and remains lighted until the Interrupt signal drops.

BCD INDICATOR

This indicator lights when BCD mode is selected or a file mark is being written on tape.

OPERATION AND PROGRAMMING

CLEARING THE CONTROLLER

Prior to the initial use of the tape controller, the system should be cleared. There are five ways of clearing the controller:

- 1) Clear Channel (100 microseconds)

This instruction:

- a) Clears all activity in the communication channel.
- b) Disconnects controller from tape unit.
- c) Performs a Master Clear on read, write, and function logic. No status signals are available to the communication channel after executing this instruction.

- 2) Clear (0005) (2 microseconds)
Disconnects controller from tape unit but leaves controller connected with communication channel for status reporting.
- 3) Release (0000)
Disconnects controller from tape unit.
- 4) Power On Master Clear
When power is applied to the Controller, all tape units are cleared. Logic in all controls is also cleared. No status signals are available to the communication channel after power is applied.
- 5) External Master Clear
This clears all tape units. It also clears the logic. No status signals are available to the data channel after executing this operation.

NOTE

Clear operations, with the exception of Release, will leave the controller in Binary format mode.

REVERSE READ

During Reverse Read the last character written on the tape will be the first one read. If the Set Reverse Read function code (0041) is sent to the controller and a Read operation is initiated, the controller assembles the characters in reverse order. Thus, the 12-bit bytes sent to the communication channel are identical to those originally sent to the tape unit.

When the controller is used with a 3400, 3600, or 3800 Computer System, the communication channel assembles the bytes in reverse order and stores the assembled word in core memory. When used in a 3100 or 3200 system, a Reverse Read instruction must be used to accomplish the same results.

Vertical and longitudinal parity checking occur as in a normal Read operation, except that if the first frame read is a record check character, no vertical parity check is made on that character. Vertical parity checking is performed on the remaining frames.

If a Reverse Read is attempted from load point, there is no tape motion. The Read operation hangs up.

Parity errors and interrupts may be handled as if the operation were a normal Read. An End of Record signal is returned to the communication channel when a record gap is reached. Chaining and nonstop Read operations may also be handled as if the operation were a normal Read.

Function code 0040 (Clear Reverse Read) should be issued when the Reverse Read operation terminates.

PROGRAMMING CONSIDERATIONS

Suppress Assembly/Disassembly

If data assembly is attempted from a tape that was recorded in Suppress Assembly/Disassembly mode,* assembly difficulties may be encountered. In Suppress Assembly/Disassembly mode, an odd number of frames may have been written on the tape. If this has occurred and the tape is read forward, the controller automatically fills in bits 0 through 5 of the last input byte with "0's". If an odd number of frames has been written and a Reverse Read is attempted, the inverted assembly will be one frame out of order, and bits 6 through 11 of the last data channel word will be filled with with "0's".

Lost Data

The Lost Data condition occurs in two cases:

- 1) When the data channel cannot supply or accept data at the rate required by the tape unit due to competition from other devices for access to storage.
- 2) When certain malfunctions occur in the communication channel.

A Lost Data condition causes data transfer to stop, stops tape motion (at the next record gap), and sets the lost data status bit. A new Read or Write operation cannot begin until the Lost Data condition has been cleared by a Master Clear, Clear Channel instruction, or new Connect or function operation. In most cases, the Lost Data condition leaves the data channel active (that is, the Read or Write operation remains uncompleted). Thus, a new Connect or Function operation cannot be initiated until the Channel Active condition has been cleared by a Master Clear, Clear Channel instruction, or Stop Channel Activity function code.*

* 3100/3200 systems

Nonstop Operation

If a new Read signal is returned to the control within 2 milliseconds after an interrupt, an End of Operation signal is transmitted and the Read operation is nonstop. If the time exceeds 2 milliseconds, tape motion stops and restarts.

SECTION F

3121-A/B MAGNETIC TAPE CONTROLLER

CONTENTS

Functional Description	F-1	Programming	F-11
Tape Unit Designation	F-2	Interrupts	F-11
Data Transmission	F-2	Parity Checking	F-12
Record/File Formats	F-2	Transmission Parity	
Transfer Rates	F-2	Checking	F-12
Codes	F-3	Equipment Parity Error	
Connect Code	F-4	Checking	F-14
Bits 0-2 (U)	F-5	Manual Operation	F-15
Bits 2-8	F-5	Switches and Indicators	F-15
Bits 9-11 (N)	F-5	Equipment Number Switch	F-15
Function Codes	F-5	Interrupt Indicator	F-15
Status Codes	F-8	Connect Indicator	F-15
		XMSN TAPE PE Indicator	F-15
		Clearing the Controller	F-15

FIGURES

F-1 Typical Configuration	F-1	F-2 Connect Code Format	F-4
---------------------------	-----	-------------------------	-----

TABLES

F-1 Connect, Function, and Status Codes	F-3
---	-----

3121 -A/B MAGNETIC TAPE CONTROLLER

The CONTROL DATA® 3121-A/B Magnetic Tape Controller controls one or two CDC® 609 Magnetic Tape Transports and communicates with any CDC® 3000 Series Data Channel. The 3121-A/B is mounted in a separate cabinet. The 3121-A uses a 60-hertz power supply and the 3121-B uses a 50-hertz power supply. The controllers are otherwise identical.

FUNCTIONAL DESCRIPTION

The controller synchronizes the character mode transmission of 8-bit words between the data channel and the tape units. No BCD conversion is used and the controller allows forward reading only. As the data passes through the controller, an odd parity bit is generated and passed along with the data frame to the tape unit to be written. The frequency of data recording is 800 bpi. As each frame passes through the controller, a cyclic redundancy character (CRC) is developed; the final version of which is recorded at the end of the data. A longitudinal check character is written following the CRC. During a Read operation, the entire 9 bits (8 data bits plus 1 parity) is transferred to the data channel. The CRC can also be read by the data channel to allow the computer to perform error correction. Longitudinal parity is also checked during Read and Write operations.

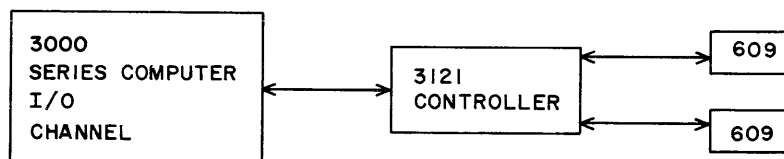

Figure F-1. Typical Configuration

TAPE UNIT DESIGNATION

Located on the tape unit is a unit select switch which is used to select the unique numerical designation of 0 or 1. When the numerical designation of a tape unit is changed, any existing connection is cleared.

DATA TRANSMISSION

Record/File Formats

The data written on tape as the result of a single output instruction constitutes a record. If 3100/3300 character output instructions are used, a record gap followed by a single character may be attained. Each record is followed by a three-frame gap, the cyclic redundancy character, another three-frame gap, and the longitudinal check character. No CRC character is written for a tape mark. The longitudinal check character is written 8 character times after the tape mark. Adjacent records are separated by a 0.6-inch record gap.

The length of a file consisting of one or more records is determined by the programmer. Adjacent files are separated by a tape mark written in response to the Write Tape Mark function code.

An End of Record signal is sent to the data channel during a Read operation when a tape unit detects a record gap. This signal may be used to terminate a Read. The Read operation also terminates when the specified number of words or characters has been read.

Transfer Rates

Read or Write operations are performed with 609 Tape Transports at a fixed density of 800 characters per inch, 33 microseconds per frame.

CODES

All connections and operations are controlled by 12-bit Connect and Function codes in conjunction with the appropriate Connect or Select/Function instruction. (See Table F-1.) Status codes are constantly available while the equipment is connected. In all discussions of codes, bit "0" is in the rightmost position.

TABLE F-1. CONNECT, FUNCTION, AND STATUS CODES

CONNECT	
Connect	N00U*
FUNCTION	
Release	0000
Clear	0005
Rewind	0010
Rewind Unload	0011
Backspace	0012
Write Tape Mark	0015
Select Interrupt on Ready and Not Busy	0020
Release Interrupt on Ready and Not Busy	0021
Select Interrupt on End of Operation	0022
Release Interrupt on End of Operation	0023
Select Interrupt on Abnormal End of Operation	0024
Release Interrupt on Abnormal End of Operation	0025
STATUS	
Ready	XXX1
Channel and/or Read/Write Control and/or Unit Busy	XXX2
Write Enable	XXX4
Tape Mark	XX1X
Load Point	XX2X
End of Tape	XX4X
Density**	X2XX
Lost Data	X4XX
End of Operation	1XXX
Vertical Parity Error, Longitudinal Parity Error, or CRC Error During Read	2XXX
*N = Equipment number (controller) U = Tape unit **("1" in bit 7 indicates 800 bpi)	

CONNECT CODE

A controller must be connected to the data channel before it can respond to either a Select/Function instruction or an I/O instruction. The connection is accomplished by the Connect instruction; the Connect code (N00U) being the lower 12 bits of this instruction.

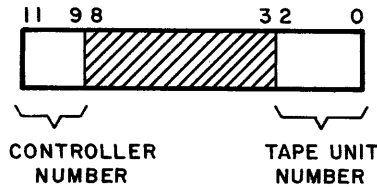

Figure F-2. Connect Code Format

The controller examines every connect code transmitted by the data channel and returns a Reply signal* indicating a connect if all of the following conditions are met.

1. The requested unit (U) is not Busy.
2. The N portion of the Connect code matches the setting of the Equipment Number switch on the controller.
3. The U portion of the Connect code matches the setting of the Unit Select switch on the tape unit.
4. A transmission parity error is not detected.

If the requested tape unit is Busy, a Reject signal which tells the central processor to read the next instruction at the reject jump address is returned to the data channel. Equipment status is available to that data channel to determine the cause of the Reject.

If the N portion of the Connect code does not match the setting of the Equipment Number switch, neither a Reject nor a Reply is returned to the data channel. Equipment status is not made available and the controller automatically disconnects. If a Reply or Reject is not returned to the data channel from any of the attached equipments within 100 microseconds, the central processor generates an internal Reject

If a transmission parity error is detected in a Connect code, the device does not connect and neither a Reject nor a Reply is returned to the data channel. Instead, the controller XMSN PE (parity error) indicator lights. The Error condition may be cleared by either a Channel Clear or a Master Clear. Transmission Parity Error condition is cleared automatically at the beginning of each Connect attempt.

*A Reply signal tells the central processor to process the next instruction.

Bits 0-2 (U)

The U portion of the code designates a specific tape unit.

Bits 2-8

Unused

Bits 9-11 (N)

The N portion of the code contains the equipment number of the controller. The number designating the controller is either 0 or 1 and is changed by the Equipment Number switch located in the controller cabinet.

FUNCTION CODES

Function codes are used to prepare a connected controller and tape unit for an I/O operation and have no effect on non-connected controllers or tape units. The codes are located in the lower 12 bits of a Select/Function instruction and are transmitted to the controller on 12 data lines. (See Table F-1 for a complete list of function codes.)

The three classifications of codes are operating, non-operating, and interrupt. Operating codes Rewind, Rewind Unload, Backspace, Read, Write, and Write Tape Mark, cause tape motion and also cause the controller to become Busy. Non-operating codes include Format Selection, Clear, and Release.

The controller accepts operating codes only when the tape is motionless. Thus, operating codes are not accepted during a Read or a Write operation, or while another operating code is being executed. Likewise, a new Read or Write operation cannot be initiated while an operating code is being executed.

Non-operating codes are accepted prior to a Read or Write operation, following the conclusion of a Write, and following the receipt of an End of Record signal during a Read. Thus, they are accepted even though an operating code is being executed.

Interrupt codes can be selected at any time. The controller examines one code at a time, checking first for parity errors. If none are found, it returns a Reply if the requested function can be performed* or a Reject if it cannot be performed. Interrupt codes always cause a Reply to be returned to the data channel.

If a parity error is detected, the requested function will not be performed, a Parity Error signal is returned to the data channel, and the XMSN Parity Error indicator lights. Since a Reply or a Reject is not returned to the data channel, the central processor generates an internal reject after a wait of 100 microseconds.

The Parity Error condition may be cleared by a Master Clear. The equipment must then be reconnected before a new function code will be examined by the controller. A reconnect attempt will automatically clear the previous Transmission Parity Error indication.

Release (0000)

This code clears the unit connection.

Clear (0005)

This code clears all tape units.

Rewind (0010)

This code rewinds the tape to load point. It has no effect when the tape is at load point.

Rewind Unload (0011)

This code rewinds the tape to load point and the tape unit Ready condition drops. All further operations with this tape unit require placing the tape unit in a Ready condition manually.

Backspace (0012)

This code backspaces the tape one record or until load point is detected. If the tape is at load point with fewer than two records preceding the load point, the tape will unload.

*Certain illegal function codes will cause a Reply to be returned. However, in these cases no action will follow.

Write Tape Mark (0015)

This code advances the tape at least 6 inches and then writes a 23₈ tape mark followed by a 23₈ check character.

Select Interrupt on Ready and Not Busy (0020)

This code causes the controller to send an Interrupt signal to the processor when the tape unit is in a Ready and Not Busy condition, that is, when power is applied, the unit is under computer control and all tape motion has ceased. Once up, the Interrupt signal can be cleared by selecting Release Interrupt on Ready and Not Busy or by clearing the controller.

Release Interrupt on Ready and Not Busy (0021)

This code clears an Interrupt on Ready and Not Busy selection and the Interrupt signal if it is up.

Select Interrupt on End of Operation (0022)

This code causes the controller to send an Interrupt signal to the processor approximately 200 microseconds after the last data character is read by a tape unit, or load point has been detected during a rewind operation. Once up, the Interrupt signal can be cleared by selecting any interrupt, any release, or the Master Clear.

During a chaining operation (3600/3800 Systems only), an interrupt does not occur until the data channel is Not Busy, that is, until the last record has been written or read in the chaining operation.

Release Interrupt on End of Operation (0023)

This code clears an Interrupt on End of Operation selection and the Interrupt signal if it is up.

Select Interrupt on Abnormal End of Operation (0024)

This code causes the controller to send an Interrupt signal to the processor after an abnormal condition occurs. These abnormal conditions are End of Tape, Tape Mark*,

*Common to Interrupt on End of Operation and Interrupt on Abnormal End of Operation.

Load Point*, Vertical Parity Error, Longitudinal Parity Error, Lost Data, and the connected tape unit becoming Not Ready.

In the case of interrupt on the connected tape unit becoming Not Ready, the interrupt occurs immediately when the connected tape unit goes from a Ready to a Not Ready condition, that is, if the power is turned off on the tape unit). This interrupt does not occur during a Connect operation, or when a Release code (0000) is executed. In all other abnormal conditions listed, the interrupt occurs when one or more of the conditions is encountered and when an End of Operation is detected.

A new Read or Write operation cannot start until the Interrupt signal is cleared. Once up, the Interrupt signal can be cleared by reselecting any interrupt or selecting any release, or a Master Clear.

Release Interrupt on Abnormal End of Operation (0025)

This code clears an Interrupt on Abnormal End of Operation selection and the Interrupt signal if it is up.

STATUS CODES

Status codes permit the monitoring of several controller and tape unit operating conditions. These codes are made available to the data channel on 12 status lines following a connect or a rejected connect attempt. Sense Status and Copy Status instructions make these codes available to the central processor.

See Table F-1 for a complete list of these codes. If two or more status conditions exist simultaneously, the Status Response is the sum of the individual codes.

Ready (XXX1)

Bit 0 is set when the tape unit is in a Ready condition, that is, power is applied and the READY indicator lights. (The controller can operate the tape unit.) Bit 0 is not set when manual control of the unit is possible.

*Common to Interrupt on End of Operation and Interrupt on Abnormal End of Operation.

Channel and/or Read/Write Control and/or Unit Busy (XXX2)

If the tape unit is Ready, bit 1 is set when the channel is transmitting or receiving data during an I/O operation. It is also set if the unit is ready and tape motion is initiated by an operating function code. In these two cases it will remain set until 5 milliseconds after tape motion stops. Bit 1 is cleared approximately 5 milliseconds after either detection of Lost Data or an Abnormal End of Operation Interrupt signal occurs and it cannot be reset until these conditions cease to exist. Bit 1 cannot be set if the tape is not ready (bit 0 is clear).

Write Enable (XXX4)

Bit 2 is set when the file protection ring is on the tape reel. It is possible to read from or write on the tape when the ring is present. Without the ring it is possible to read from but not to write on the tape.

Tape Mark (XX1X)

Bit 3 is set whenever a tape mark is read, including readback during a Write.

Load Point (XX2X)

Bit 4 is set when the tape is set at load point. It is cleared when the tape moves off load point.

End of Tape (XX4X)

Bit 5 is set when the End of Tape marker is detected. It is cleared when a reverse is initiated, the Ready drops, or the tape unit is otherwise deselected.

Density (X2XX)

This code is not applicable for the 609 Tape Transport because it operates only at a density of 800 bpi. However, the controller may be selected at 200 bpi with a 0 in bit 7 instead of 1. If this is done, parity errors will occur.

Lost Data (X4XX)

Bit 8 is set when the controller determines that data may have been lost in transmission. Tape motion stops when bit 8 is set and cannot be restarted until this bit has been cleared by a new Connect or function code.

When operating from a 160/160-A Computer via a CONTROL DATA® 3681 Data Channel converter, lost data is also detected if the Read or Write selects in the 3681 are not cleared immediately after a Read or Write operation is completed. As long as a Write signal is present and the Data signal is not present at the required time, the controller assumes that a data transmission loss has occurred and a Lost Data signal is sent. If the Read signal is present, but data is not being accepted by the channel, a Lost Data status also occurs. The Read or Write select in the 3681 must be cleared immediately after a Read or Write operation is completed to prevent the Lost Data signal from being sent abnormally. If the Lost Data signal is present, it must be cleared if Read or Write operations are to continue.

End of Operation (1XXX)

Bit 9 is set approximately 5 milliseconds after the completion of an operating function or when an End of Record signal is generated. It is cleared by initiating a new operating function, Read/Write operation, or a Master Clear.

Vertical or Longitudinal Parity Error , or CRC Error During Read (2XXX)

Bit 10 is set following detection of either a Vertical or Longitudinal Parity Error, or detection of a CRC Error During Read. It is cleared by initiating a new Read, Write, or a Master Clear. If this bit is set during a chaining operation (on 3600/3800 Systems only) due to detection of a Vertical or Longitudinal Parity Error, it cannot be cleared until the chaining operation terminates.

PROGRAMMING

INTERRUPTS

Interrupts provide a method of attaining optimum utilization of a system's capabilities. Basically, the system halts the main program and initiates an interrupt processing program when an Interrupt signal is detected by the processor. (See the system reference manual for additional information on processing interrupts.)

The controller can be programmed to send an Interrupt signal to the processor when any one of the conditions specified by the three interrupts occurs.*

Select/Interrupt codes permit the controller to consider as a group the operating conditions which may occur in an attached unit. If a specific interrupt has been selected and at least one of the conditions specified by it occurs in the connected unit, the controller sends an Interrupt signal to the processor. If the interrupt system in the processor has been enabled to recognize the interrupt, the main program is interrupted and control is transferred to a specific program address. Status sensing and follow-up operations may follow. If desired, control may be returned to the main program by a jump instruction located at the end of the interrupt processing program.

If the processor's interrupt system has not been enabled, it is still possible to sense for these conditions via sense status and copy status instructions written into the main program.

Regardless of which of the preceding actions is followed, the Interrupt signal will remain up until cleared by reselecting any interrupt or selecting a Clear Interrupt or a Master Clear. The Interrupt signal is transmitted on the equipment interrupt line via the data channel currently connected to the equipment, whether or not the channel is currently servicing the equipment.

*See description of function codes.

The setting of the Equipment Number switch determines the number of the line that transmits Interrupt signals. For example, if the Equipment Number switch is set to 5, all Interrupt signals coming from this controller are transmitted on interrupt line 5. Since each equipment attached to a data channel has a unique equipment number, each uses a different interrupt line. A Channel Product Register Jump instruction* or a Copy Status instruction** can identify the equipment sending the Interrupt signal by inspection of the interrupt lines.

PARITY CHECKING

Transmission Parity Checking

Connect codes, function codes, and data are transmitted between the data channel and the controller in odd parity, that is, the number of "1" bits transmitted must be odd. If the number of "1" bits in a data byte is even, a "1" is transmitted on the parity line*. If the number of "1" bits in the data byte is odd, the "1" is not transmitted on the parity line.

A Transmission Parity Error exists if the total number of "1" bits transmitted on the 12 data lines plus the parity line is even, indicating that a bit has been lost or picked up in error. The various types of transmission parity errors are listed below:

1. Parity Error in a Connect Code: If a parity error is detected in a Connect code, the device does not connect** and a Reject or a Reply is not returned to the data channel. Instead, the error lights the XMSN Parity Error indicator. These Parity Error conditions may be cleared by either a Channel Clear or a Master Clear. A new connect attempt will also clear a previous Transmission Parity Error indication.
2. Parity Error in a Function Code: If a parity error is detected, the requested functions will not be performed. A parity error signal is returned to the data channel and the XMSN Parity Error indicator lights. Since a Reject or a Reply is not returned to the data channel the central processor generates an internal Reject after a wait of 100 microseconds. The Parity Error condition may be

*3600/3800 Systems
**3100/3300 Systems

cleared by a Master Clear*. The equipment must then be reconnected before a new function code can be examined by the controller. A reconnect will automatically clear the transmission parity error indication.

3. Parity Error in Output Data: If a transmission parity error is detected during a Write operation the XMSN Parity Error indicator lights. Both a Reply and a Parity Error signal are sent to the data channel and the data will be written on tape. The validity of the data received from this point until the conditions are cleared by a Channel Clear or Master Clear is questionable. All operations will continue unless appropriate programming steps have been taken to clear the parity error and rewrite the data. The equipment must then be reconnected and the appropriate functions reselected prior to the new output.
4. Parity Errors in Input Data: Transmission parity errors may be detected by the data channel on data received from the equipment. If a parity error is detected, a parity error bit in the data channel is set and a parity error indicator on either the channel or the console lights. The faulty data will be entered into either storage or the 'A' register. The validity of the data received from this point until the indicators are cleared is questionable. All operations will continue unless appropriate programming steps have been taken to clear the parity error and reread the data. These parity error conditions are cleared by a Channel Clear or a Master Clear issued by any 3000 Series System.
5. Input/Output Parity Error Bit in the Data Channel: The input/output parity error bit is set whenever a transmission parity error is detected. If the error is detected by the external equipment the bit is set by the parity error signal.

If the interrupt system is active, in 3600/3800 Systems, an interrupt signal is generated when this bit sets. If the interrupt system has not been enabled to detect this bit, the bit may be sensed to detect parity error conditions.

In 3100/3300 Systems the bit must be sensed if transmission parity error conditions are to be detected by the central processor.

Refer to the appropriate system reference manual for more information on the input/output parity error bit.

*Though operations may continue normally, the validity of a new function code and/or data prior to a Master Clear, Channel Clear, or reconnect is questionable.

Equipment Parity Error Checking

Each character transmitted between the controller and the tape unit is checked for correct parity. During a Write operation the controller adds the correct parity bit to each character and relays it to the tape unit. Approximately 4 or 5 milliseconds after writing, a vertical parity error check is made. This time interval is used to check-read the tape and transmit the data back to the controller. At the conclusion of a record, a record check character is written following the CRC character. This character is used for longitudinal parity checking. During a Read or Write, vertical and longitudinal parity checks are made by the controller.

Both Vertical and Longitudinal Parity Errors are considered equipment parity errors.

1. Vertical Parity Error Checking: A Vertical (Transverse) Parity Error exists when the number of "1" bits on the six data lines plus the parity line is not odd.

If a Vertical Parity Error is detected, the TAPE Parity Error indicator on the controller lights and a Parity Error signal is placed on the appropriate status line. The parity error condition may be cleared by a new Read, Write, Channel Clear, or a Master Clear. If selected, this condition will cause an Abnormal End of Operation Interrupt.

2. Longitudinal Parity Error Checking: The tape is divided into nine longitudinal (lengthwise) tracks. Eight of the tracks are used to store data while the ninth holds the vertical parity bits. When a record is read from tape, the total number of "1's" in each track must be even. If the number of "1" bits in any track of a record is odd, a "1" will be written in that track as a part of the record check character. During a Read operation, Longitudinal Parity Error exists if the record check character is not as anticipated.

If a Longitudinal Parity Error is detected, the TAPE Parity Error indicator remains on and a Parity Error signal is placed on the appropriate status line. This parity error condition may be cleared by a new Read, Write, Channel Clear, or a Master Clear. If selected, this condition will cause an Interrupt on Abnormal End of Operation.

MANUAL OPERATION

SWITCHES AND INDICATORS

Equipment Number Switch

The setting of the two-position Equipment Number switch designates the controller and corresponds to the N portion of the Connect code. The switch setting also determines the interrupt transmission line number used by the equipment.

INTERRUPT Indicator

This indicator lights when an interrupt occurs and remains on until the Interrupt signal drops.

CONNECT Indicator

This indicator lights when the controller is connected.

XMSN/TAPE PE Indicator

If a Transmission Parity Error is detected during a Connect, Select/Function, Read, or Write operation, the XMSN portion of this indicator lights.

The indicator remains on until the parity error is cleared by a Channel Clear, a Master Clear, or a reconnect. The TAPE portion of this indicator lights if a Vertical or Longitudinal Parity Error is detected. The indicator remains on until a Channel Clear or Master Clear is selected or a new motion function is initiated.

CLEARING THE CONTROLLER

Prior to the initial use of the controller, the system should be cleared. There are five possible ways of clearing the controller:

1. Clear Channel*
 - a. This signal (100 microseconds) clears all activity in the data channel.
 - b. Clears the present connection the controller may have with a tape unit.
 - c. Performs a Master Clear on the controller Read, Write, and function logic.

No status signals are available to the data channel after execution of this instruction.

2. Clear (0005)

This function code clears the present connection the controller may have with a tape unit. The Clear is 2 microseconds. The controller remains connected in the sense that status signals are still available for the data channel.

3. Release (0000)

This function code clears the connection for the connected tape unit.

4. Power On Master Clear

When power is applied to the controller, all tape units connected are cleared. Logic in the controller is also cleared. No status signals are available to the data channel after power is applied, until appropriate connect is made.

5. External Master Clear

This clears all tape units connected. It also clears the logic in the controller. No status signals are available to the data channel after executing this operation.

The Clear and Release codes can only be used after a controller is connected to a tape unit.

*See the individual processor instructions.

SECTION Z

SUPPLEMENTARY INFORMATION
MAGNETIC TAPE EQUIPMENT

CONTENTS

Tape Recording Characteristics	Z-1	Application of Power	Z-4
Tape Format	Z-1	Tape Load Procedure	Z-5
Reflective Spots	Z-2	Tape Unload Procedure	Z-6
File Protection Rings	Z-3	Special Instructions	Z-6
603/604/606/607 Operating Instructions	Z-4	Manual Controls	Z-7

FIGURES

Z-1 Bit Assignments on Tape	Z-2	Z-5 603/606 Operator's Control Panel	Z-8
Z-2 Physical Layout of Tape	Z-3		
Z-3 File Protection Ring	Z-4	Z-6 604/607 Operator's Control Panel	Z-8
Z-4 Tape Load and Unload Mechanics	Z-5		

SUPPLEMENTARY INFORMATION

MAGNETIC TAPE EQUIPMENT

The section contains information common to several Control Data magnetic tape units. It includes:

- 1) Tape format.
- 2) Operating instructions for CONTROL DATA 603, 604, 606, and 607 Tape Units.
- 3) Manual controls for 603, 604, 606, and 607 Tape Units.

TAPE RECORDING CHARACTERISTICS

TAPE FORMAT

Magnetic tape provides a high-speed, nonvolatile storage medium for recording information. The tape has a plastic base, coated on one side with a magnetic oxide which consists of minute particles of iron oxide mixed with a binding agent.

Information is read (detected) or written (stored) by passing oxide side of the tape over read/write heads. Information is written on or read from independent tracks on the tape by seven recording heads placed vertically across the tape.

A nonreturn-to-zero (change-on-ones) recording scheme is used. In this system, magnetic particles on the tape are aligned in either the positive or negative direction. A binary "1" is recorded by reversing the alignment (polarity); no polarity reversal results in recording a "0". Thus, each track of the tape is fully magnetized, and the polarity is reversed as each "1" bit is recorded.

A line of tape data consists of a 6-bit character and a parity (check) bit. Tracks 0 through 5 specify the character; track 6 holds the parity bit (Figure Z-1).

In Control Data systems, data is recorded in binary or binary coded decimal (BCD) format. Tape is binary if data is recorded as it is represented in core storage. In BCD format, digits, characters, and special symbols are represented in core storage by 6-bit binary numbers.

The formats also differ in selection of parity bits. In binary format, the parity bit is chosen so that the total number of "1" bits in any line is odd. In BCD format, the total number of "1" bits is even. The format is selected by the controller.

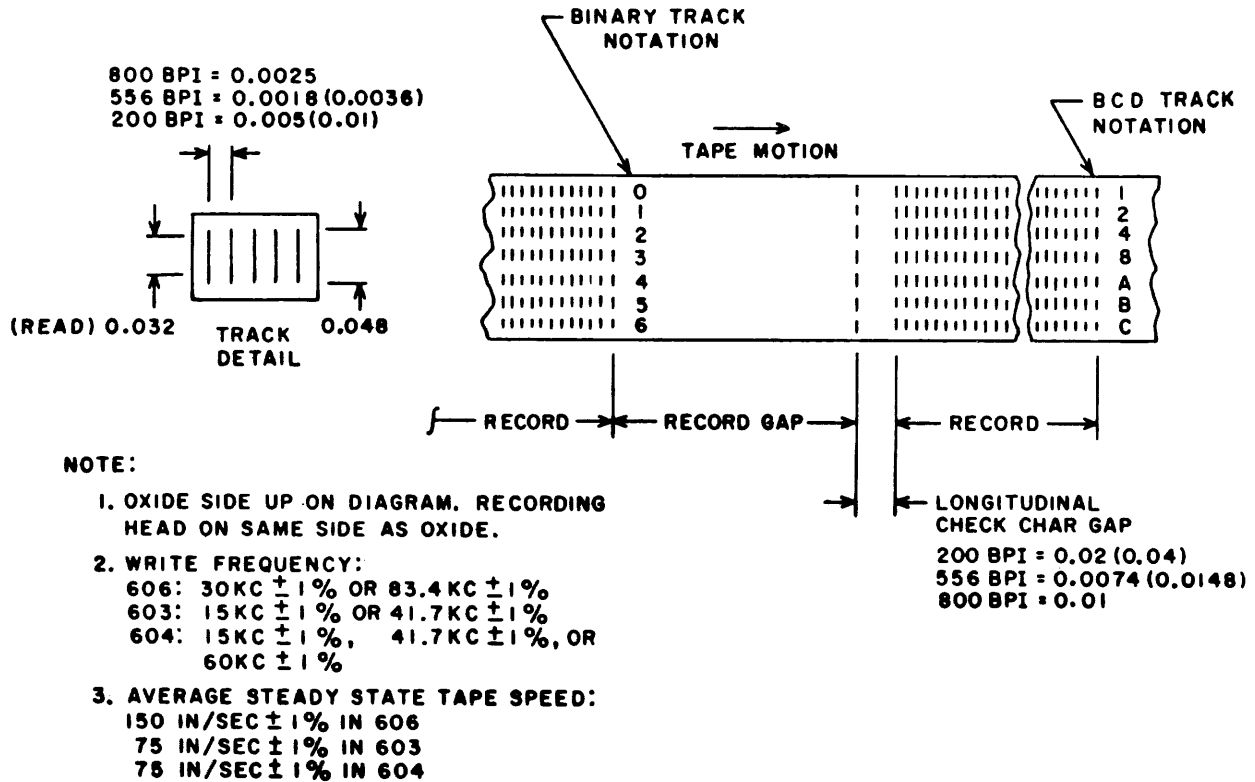

Figure Z-1. Bit Assignments on Tape

Recorded data on the tape is arranged in groups called records and files. A minimum of one line of information constitutes a record. Adjacent records are separated by a 3/4-inch unrecorded area (record gap). A longitudinal parity bit is recorded in coded* format at the end of each record; the number of "1's" in each record track is made even.

A file consists of a group of records. Adjacent files are separated by recording an end of file mark 6 inches from the last record in the file. The file mark consists of an octal 17 (BCD) and its check character.

REFLECTIVE SPOTS

Reflective spots are placed on the tape to determine the beginning and end of the usable portion of the magnetic tape. The reflective spots are plastic, one inch long by 3/16 inch wide, coated on one side with adhesive strips and on the other with vaporized aluminum. They are placed on the base or uncoated side of the tape and detected by photosensing circuits.

* The word "coded" is often used instead of BCD.

The load point marker must be placed at least 10 feet from the beginning of the tape on the supply reel (Figure Z-2). This marker is placed with its one-inch dimension parallel to and not more than 1/32 inch from the edge of the tape nearest the operator when the file reel is mounted.

The end of tape marker should be placed not less than 18 feet from the end of the tape attached to the takeup reel hub. The marker is placed with its one-inch dimension parallel to and not more than 1/32 inch from the edge of the tape nearest the tape unit (when reel is mounted).

Markers are applied while the reel is removed from the tape unit and must be properly aligned and firmly attached to the tape. Use care to avoid dust accumulation on the tape while attaching markers.

FILE PROTECTION RINGS

The back of the file reel has a slot near the hub which accepts a plastic file protection ring (Figure Z-3). Writing on a tape is possible only when the reel contains this ring, but the tape may be read with or without the ring. Presence of a ring on a reel of tape is signaled by the overhead lights which turn on immediately after the tape load procedure is executed. The lights remain on until the ring is removed or the tape unit is placed in the unload status. The ring should be removed from the file reel after writing to avoid loss of records through accidental rewriting.

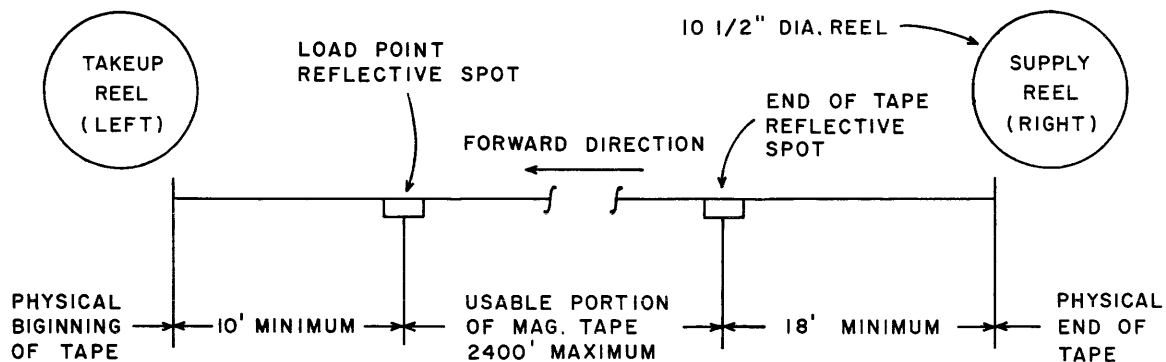

Figure Z-2. Physical Layout of Tape

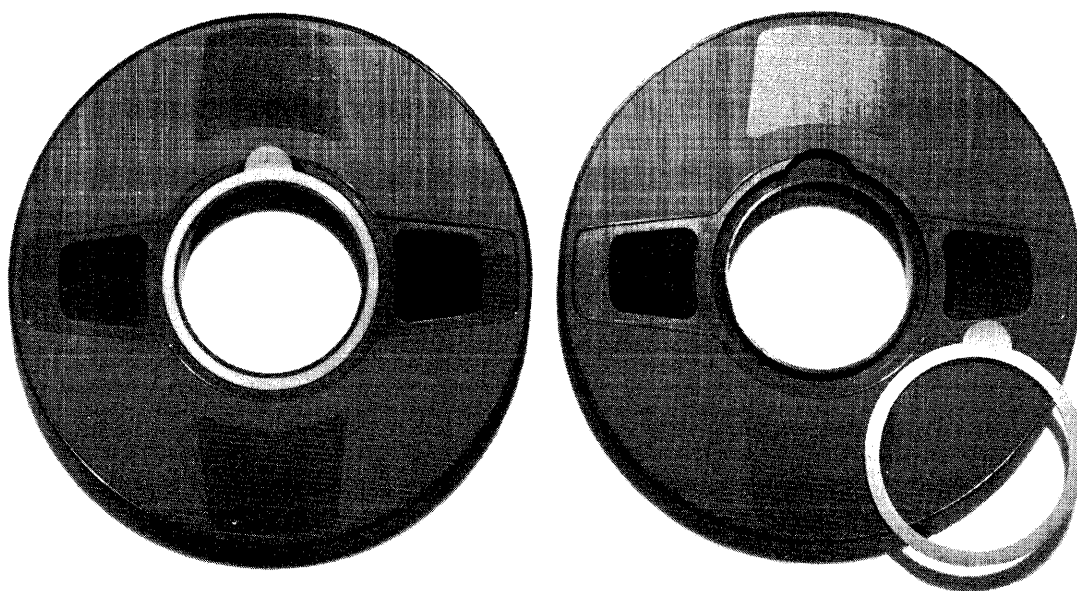

Figure Z-3. File Protection Ring

603 / 604 / 606 / 607 OPERATING INSTRUCTIONS

APPLICATION OF POWER

To initially energize the tape unit:

- 1) Open doors at back of cabinet.
- 2) Push the two-line circuit breakers (on power supply) to the up position. The neon indicator should light.
- 3) Push the two-reel power circuit breakers (on power supply) to the up position.
- 4) Hold the Power On switch on the maintenance panel for about 2 seconds. The pump motor should start.
- 5) The POWER indicator on the operator's control panel should light. If not, repeat the procedure.
- 6) Close the back doors.

The POWER switch on the operator's control panel is used only to remove power from the unit. Once this switch is pushed, the above procedure must be repeated in order to apply power to the unit.

TAPE LOAD PROCEDURE

- 1) Slide front door down to lowest position (Figure Z-4).
- 2) Check that supply reel has been file-protected as necessary.
- 3) Mount reel on supply reel hub and tighten hub knob.
- 4) Make sure that tape load arms are in up position.
- 5) Pull tape from supply reel to reach takeup reel. Thread tape on the outside of the supply tape load arm, over the head assembly, around the outside of the takeup load arm, and over the top of the takeup reel. Release tape and spin the takeup reel hub two or three times.
- 6) Slide tape under head assembly.
- 7) Snap tape load arms down.
- 8) Set Unit Select switch (0-7 or STANDBY) to desired program selection number.
- 9) Press CLEAR switch.
- 10) Press LOAD switch. Tape drops in columns, moves forward, and stops on load point marker. LOAD indicator lights. If tape continues moving forward for more than 3 or 4 seconds, either no load point marker was placed on the tape or the operator manually wound the marker onto the takeup reel during step 5.

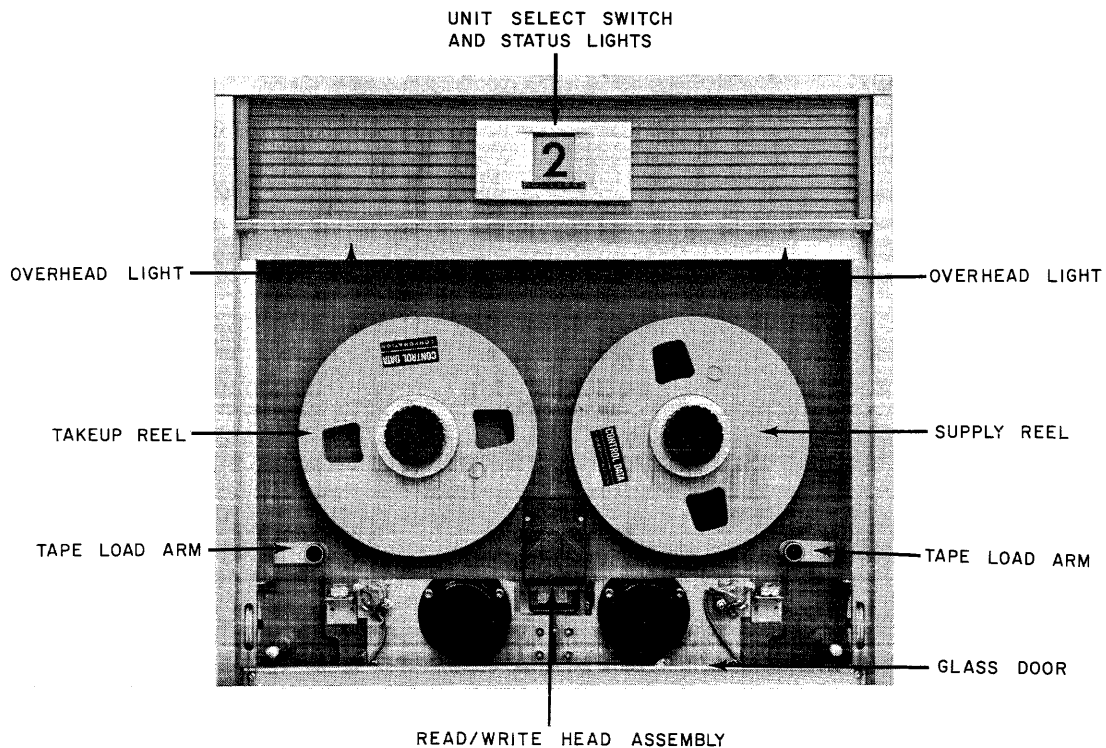

Figure Z-4. Tape Load and Unload Mechanics

- 11) If the unit is to be controlled by the controller, press the READY switch. If it is to be manually operated and the READY switch has been pushed, push the CLEAR switch.
- 12) Push up door.

If the supply reel contains a file protection ring, the overhead lights should be on, indicating that a Write operation may be performed.

TAPE UNLOAD PROCEDURE

- 1) Press CLEAR switch.
- 2) Press UNLOAD switch. All tape is automatically drawn from the takeup reel and wound on the supply reel. The UNLOAD indicator lights.
- 3) Slide down front door.
- 4) Loosen supply reel hub knob and remove supply reel.
- 5) Check if reel needs to be file-protected and if it is labeled adequately prior to storage.

SPECIAL INSTRUCTIONS

To simulate an Unload condition without removing all tape from the takeup reel, simultaneously push the CLEAR and UNLOAD switches. The Unload condition is simulated, but tape does not move. To place the unit in operational status, remove all tape from the vacuum columns by revolving the takeup reel clockwise and the supply reel counterclockwise. Snap the tape load arms down and push the LOAD switch. The tape moves forward and stops on the nearest load point marker. The LOAD indicator lights.

If all tape is unwound from the supply reel:

- 1) Snap the tape load arms up, if necessary.
- 2) Guide tape around the tape load arms, over the head assembly, and wrap approximately 10 turns around the supply reel.
- 3) Slide tape under head assembly.
- 4) Push the LOAD switch.
- 5) As soon as the FORWARD indicator lights, push the CLEAR switch and then the REVERSE switch. Tape will rewind on the nearest load point marker.

The following information is applicable when a number of load point or end of tape markers are used on a single tape:

To move forward from a reflective marker and stop at nearest end of tape marker, push the FORWARD switch.

To move forward off a reflective marker and stop at nearest load point or end of tape marker, push the FORWARD and then the LOAD switch. The LOAD indicator lights if motion stops at load point marker.

To reverse from a reflective marker and stop at nearest load point marker, push the UNLOAD, CLEAR, and REVERSE switches in that order.

Tape motion may be stopped at any time by pushing the CLEAR switch. An Unload operation may be performed by pushing the UNLOAD switch.

MANUAL CONTROLS

The manual controls (Figures Z-5 and Z-6) are effective when the CLEAR switch is lighted. The indicators, however, reflect both manual- and processor-imposed operating conditions.

UNIT SELECT SWITCH

A 10-position switch is mounted on each tape unit. The setting of this switch (0-7 or STANDBY) either designates the control or places it in a Standby condition. Units in a Standby condition cannot be connected to and, hence, used by the processor.

A white indicator in this switch is lighted while the unit is connected to a data channel. A red indicator is lighted while the unit is reserved by a data channel.

POWER SWITCH/INDICATOR

This switch turns off tape unit power. It is lighted when power is on.

FORWARD SWITCH/INDICATOR

This switch moves the tape forward. Motion stops when the end of tape marker is sensed or the CLEAR switch is pushed. It is lighted during this operation.

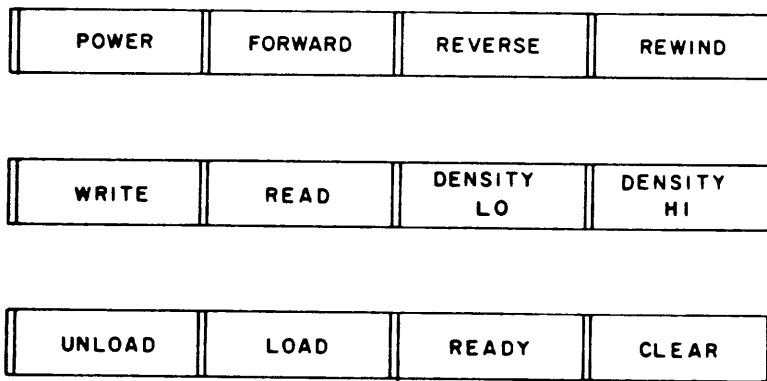

Figure Z-5. 603/606 Operator's Control Panel

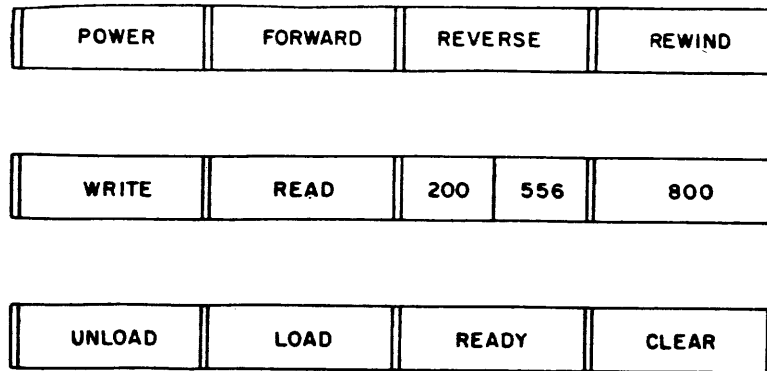

Figure Z-6. 604/607 Operator's Control Panel

REVERSE SWITCH/INDICATOR

This switch rewinds the tape. Motion stops when the load point marker is sensed or the CLEAR switch is pushed. It is lighted during this operation.

REWIND SWITCH/INDICATOR

This switch rewinds the tape to load point. It is lighted during this operation.

WRITE INDICATOR

This indicator is lighted during a Write or Write File Mark operation.

READ INDICATOR

This indicator is lighted during a Read operation.

DENSITY LO* SWITCH/INDICATOR

This switch selects low density. It is lighted if low density is selected.

DENSITY HI* SWITCH/INDICATOR

This switch selects high density. It is lighted if high density is selected.

200/556** SWITCH/INDICATOR

This alternate-action switch selects either 200 or 556 bits per inch density. The selected side is lighted.

800** SWITCH/INDICATOR

This switch selects 800 bits per inch density. It is lighted if 800 bits per inch is selected.

UNLOAD SWITCH/INDICATOR

This switch moves all the tape to the supply reel. It is lighted when the tape unit is in unload status.

LOAD SWITCH/INDICATOR

This switch moves tape forward to load point. It is lighted when the tape is at load point.

READY SWITCH/INDICATOR

This switch places the unit under processor control. It is lighted while the unit is under processor control.

CLEAR SWITCH/INDICATOR

This switch master clears the tape unit. It places the unit under manual control. It is lighted when the unit is under manual control.

* 603/606 Tape units

** 604/607 Tape units

SECTION A

3446-A/3644-A CARD PUNCH CONTROLLERS

CONTENTS

Functional Description	A-2	Codes	A-6
Card Format	A-2	Connect Code	A-7
Buffer Memory	A-2	Function Codes	A-8
Punching Cards	A-3	Status Codes	A-11
Suppress Disassembly Mode	A-3	Programming Considerations	A-13
Card Check-Read	A-4	Programming Procedure	A-13
Last Card Check	A-4	Timing	A-13
Sorting	A-4	Manual Operation	A-14
Parity	A-4	Switches and Indicators	A-14
Parity Error in Connect Code	A-5	Card Punch Switches and Indicators	A-14
Parity Error in Function Code	A-5	Controller Switches and Indicators	A-14
Parity Error During Write Operation	A-5	Operating Procedure	A-15
Interrupt	A-5		
Programming	A-6		

FIGURES

A-1 Typical Configurations	A-1	A-2 Controller Switches and Indicators	A-14
----------------------------	-----	--	------

TABLES

A-1 System Specifications	A-2	A-2 Connect, Function, and Status Codes	A-7
---------------------------	-----	---	-----

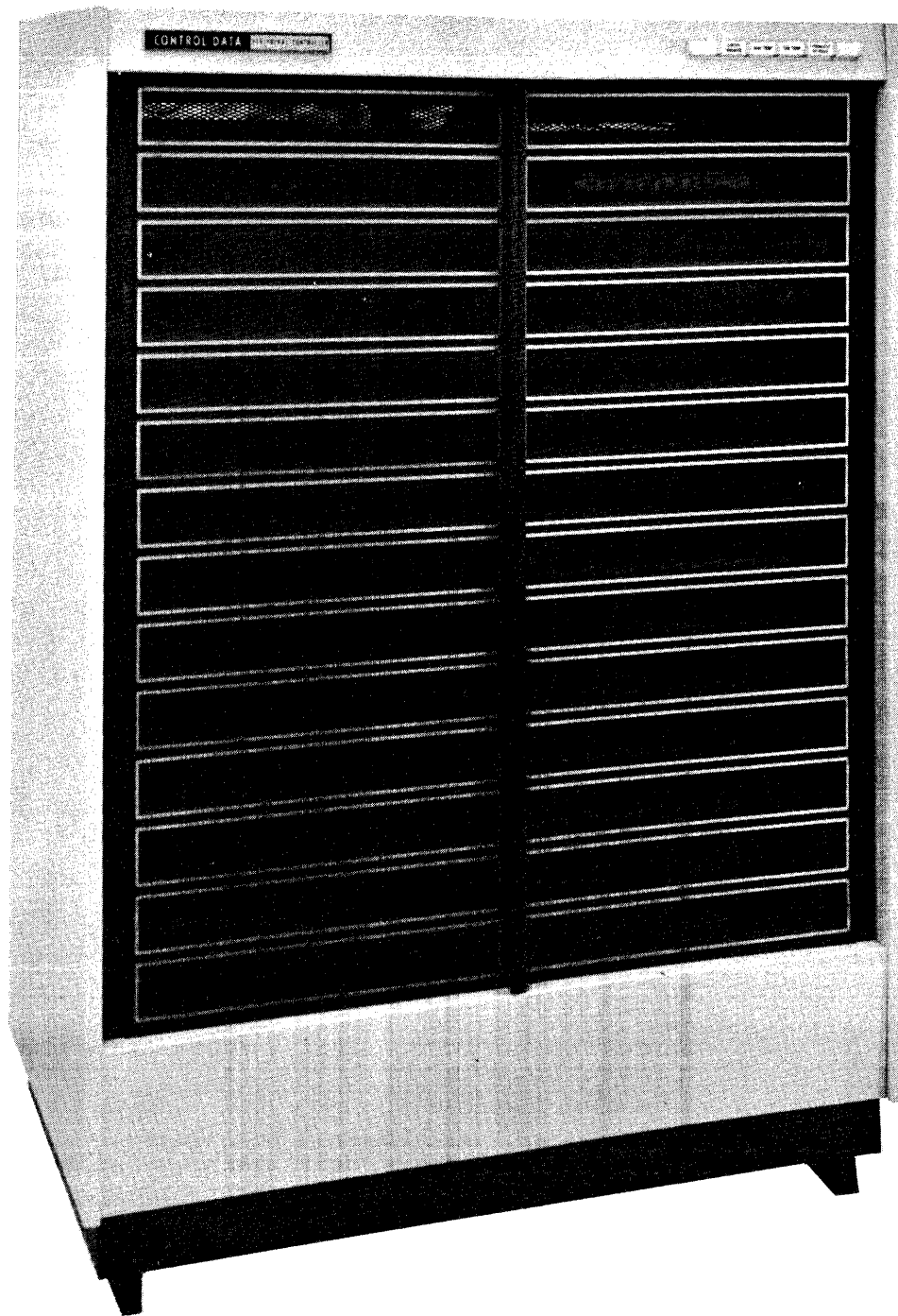

3644 CARD PUNCH CONTROLLER

3446-A/3644-A CARD PUNCH CONTROLLERS

This section describes a card punch system consisting of a CONTROL DATA* 3446 or 3644 Card Punch Controller and a CONTROL DATA 415 or an IBM 523 Card Punch. These systems operate with any 3000 Series data channel. Figure A-1 shows typical system configurations. Table A-1 lists the specifications for systems using either punch.

The controller occupies a cabinet separate from the basic card punch.

The two controllers are similar except that the 3644 Controller is a two-channel device, and the 3446 Controller is a single channel device. The 3446 is assigned a unique equipment number (0-7) to distinguish it from other equipments attached to the data channel while the 3644 has two equipment number settings, one for each channel which may reserve the device. Reserve logic prevents both data channels from communicating simultaneously with the 3644 Controller.

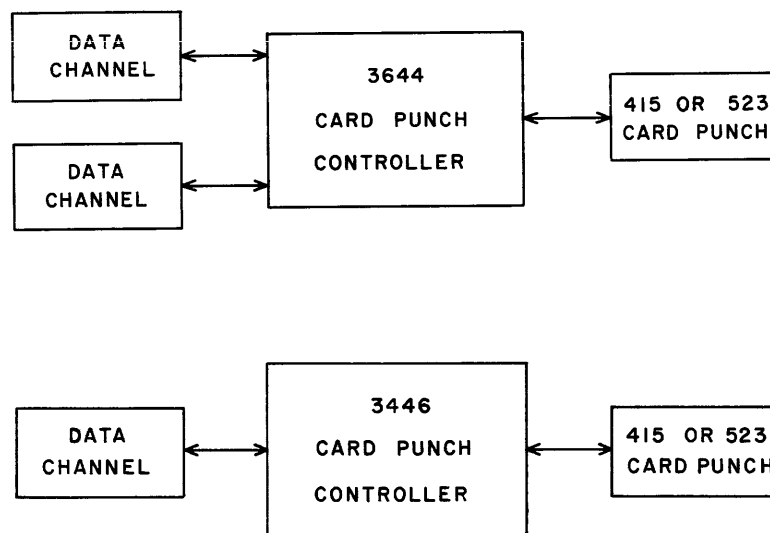

Figure A-1. Typical Configurations

*Registered trademark of Control Data Corporation

TABLE A-1. SYSTEM SPECIFICATIONS

	CONTROL DATA 415 Punch	IBM 523 Punch
Processing Speed	250 cards/minute	100 cards/minute
Input Hopper Capacity	1, 200 cards	725 cards
Stacker Capacity	1, 500 cards	725 cards
Type of Cards	80-column only	80-column only
Data Transfer Rate: Buffer memory in controller permits high-speed transfer from data channel, 2, 560 microseconds per 80-column card.		

FUNCTIONAL DESCRIPTION

CARD FORMAT

The card punch system can handle 80-column cards only. Cards can be punched in either Hollerith or binary format. Section Z, Punch Card Format and Codes, describes the card.

BUFFER MEMORY

The controller contains a buffer memory that holds 80 12-bit words, one card image. This memory permits the data channel to transfer at a very rapid rate the bytes necessary to punch one card. The information is then read-out at the relatively slow rate required by the punch. When the actual punching takes place, the data channel need not be connected to the punch system and may be used to serve some other device.

The memory can be fully loaded in 2.2 milliseconds for a Hollerith card (40 bytes) or in 2.5 milliseconds for a binary card (80 bytes). The time required to punch a card is:

- 1) 240 milliseconds for the 415 Punch.
- 2) 600 milliseconds for the 523 Punch.

PUNCHING CARDS

The card punch system is controlled by a data channel. It punches cards only as long as the data channel transmits data bytes in response to a Write (Output) instruction.

The controller forms a card image in a buffer memory from a series of 12-bit data bytes. A card is punched after the card image is formed. The controller forms the card image on a column-by-column basis. Normally, the controller performs a BCD (binary coded decimal) to Hollerith conversion. The controller interprets each 12-bit byte as two 6-bit internal BCD codes. It converts each of these codes to a Hollerith code. (Table Z-1, Section Z, lists the two sets of corresponding codes.) Thus, in the first byte, the upper 6 bits are translated into a Hollerith code which is punched in column 1 of the card. The lower 6 bits are also translated into a Hollerith code which is punched in column 2 of the card. The second byte is translated into two Hollerith codes that are punched in columns 3 and 4. Forty 12-bit bytes are required to fill an 80-column card.

When the Negate BCD to Hollerith mode selected by a function code is in effect, each byte is punched directly in a separate card column. There is no code conversion. Bit 11 of each byte is punched in the top row (row 12) and bit 0 is punched in the bottom row (row 9). Eighty 12-bit bytes are required to fill a card.

The number of data bytes transferred by a single Write instruction may be fewer, the exact number, or more than required to fill one card. When fewer bytes than 40 (BCD) or 80 (binary) are sent to the punch, a card is punched when the data channel terminates the Write operation. If a single Write operation transfers more bytes than can be punched on a card, a second card is punched when the first is filled.

SUPPRESS DISASSEMBLY MODE

The controller automatically enters the Suppress Disassembly mode in response to either of the following 6-bit Output instructions:*

- 1) Character Addressed Output from Storage (OUTC) in which H (bit 18) = 0.
- 2) Output, Character from A (OTAC).

When this mode is in effect, the controller does not disassemble each 12-bit byte into two BCD codes. Instead, the controller accepts only the lower 6 bits of each byte and

* 3100/3200/3300 systems only

converts this code to a corresponding Hollerith code. The above instructions initiate Output operations in which the upper 6 bits of each data byte are all zeros. Thus, no information is lost when the controller discards the upper 6 bits.

CARD CHECK-READ

The card punches have a check-read station located behind the punch station. After a card is punched, it is read and checked for errors while the next card is being punched. As a card image is formed in buffer memory, a count of "1's" is accumulated. This count is stored by the controller. When the card is check-read, a total hole count is prepared and this count is compared with the original count. If the two counts do not agree, an error exists in the card. This condition causes the controller to send an Interrupt signal if the Abnormal End of Operation interrupt is selected. A status line also indicates a comparison error.

LAST CARD CHECK

Normally, a card is check-read only when the next card is punched. When punch operations end, the last card punched does not advance through the check-read station. A function code is available to initiate a check-read cycle for the last card.

SORTING*

A special function code (Select Offset Stacker) offsets a card slightly as it enters the stacker. The code must be issued for each card to be offset within 60 milliseconds after the card is check-read.

PARITY

All information exchanged between the data channel and controller is checked for parity.

* Available on CONTROL DATA 415 Punch only

Parity Error in Connect Code

The controller checks a Connect code sent from the data channel for correct parity. If a parity error is present, the controller does not connect, and Parity Error indicators on all equipments cabled to the data channel light. A Clear Channel instruction or Master Clear should be executed to clear the Parity Error indicators before another operation is executed.

Parity Error in Function Code

The controller checks each function code sent from the data channel for proper parity. If a parity error occurs in a function code, a Parity Error indicator on the controller lights, and the controller sends a Parity Error signal to the data channel. The controller does not execute the function. The Parity Error signal sets the input/output parity error bit in the data channel. This signal should be cleared by a Clear Channel instruction or Master Clear before another operation is initiated.

Parity Error During Write Operation

During Write operations, the controller checks each data byte sent from the data channel for correct parity. If a parity error occurs, the Parity Error indicator on the controller lights, and the controller sends a Parity Error signal to the data channel. This signal sets the input/output parity error bit in the data channel. If the data channel does not terminate the Write operation, the card punch uses the faulty data. The Parity Error signal should be cleared by a Clear Channel instruction or Master Clear.

INTERRUPT

An interrupt feature enables the card punch system to notify the processor when it is ready to begin an operation or when it has completed an operation. Thus, the main program can proceed with minimum regard for card punching operations. Interrupts also allow the punch to notify the central processor when it requires service.

If a specific interrupt has been selected and if the condition(s) specified by it occurs, the controller sends an Interrupt signal to the processor.

If the interrupt system in the processor has been set to recognize the interrupt, the main program is interrupted and control is transferred to a specific program address. If the processor's interrupt system has not been enabled, it is still possible to sense for these conditions via Sense Status and Copy Status instructions written into the main program.

Regardless of which of the above actions is followed, the Interrupt signal remains up until cleared. This clearing may be accomplished by selecting the appropriate interrupt or release (002X), issuing the Release and Disconnect or Clear Function code (0000, 0005) using the Clear Channel instruction or a manual Master Clear. All except reselecting the interrupt will also clear the interrupt selection.

The card punch system transmits the Interrupt signal to the data channel on one of eight interrupt lines. The setting of the eight-position Equipment Number switch on the controller determines which line is used. For example if the switch is set to 4, the Interrupt signal goes out on line 4. Since each equipment attached to the data channel is assigned a unique equipment number, each uses a different interrupt line. A Channel Product Register Jump instruction* or Copy Status instruction** can identify which of several equipments attached to a data channel sends an interrupt by inspecting the eight interrupt lines.

Refer to the appropriate system reference manual for interrupt processing details.

PROGRAMMING

CODES

Table A-2 lists all the codes applicable to the 3644/3446 Controllers. A detailed explanation of each code follows the table.

* 3600/3800 systems

** 3100/3200/3300/3400 systems

TABLE A-2. CONNECT, FUNCTION, AND STATUS CODES

CONNECT	
Connect Punch	N000*
FUNCTION	
Release and Disconnect	0000
Negate BCD to Hollerith Conversion	0001
Release Negate BCD to Hollerith Conversion	0002
Select Offset Stacker**	0003
Check Last Card	0004
Clear	0005
Select Interrupt on Ready and Not Busy	0020
Release Interrupt on Ready and Not Busy	0021
Select Interrupt on End of Operation	0022
Release Interrupt on End of Operation	0023
Select Interrupt on Abnormal End of Operation	0024
Release Interrupt on Abnormal End of Operation	0025
STATUS	
Ready	XXX1
Busy	XXX2
Fail to Feed	X1XX
Interrupt on Ready and Not Busy	X2XX
Interrupt on End of Operation	X4XX
Interrupt on Abnormal End of Operation	1XXX
Compare Error	2XXX
Reserved (by other channel) (3644 only)	4XXX

Connect Code

The card punch system must be connected to a data channel before it responds to a function code or Write operation. A Connect code (N000), the lower 12 bits of the Connect instruction, connects the punch system to the data channel issuing the code. The N portion of the code must match the setting of the eight-position Equipment Number switch. (On the 3644 Controller, there are two Equipment Number switches, one for each channel.) When the controller connects, it returns a Reply signal that permits the central processor to execute the next instruction.

* N = equipment number of controller

** CONTROL DATA 415 Card Punch only

A Connect code that does not match the Equipment Number switch setting disconnects the controller if previously connected.

The two-channel 3644 Controller contains a channel reservation feature that prevents interference between the two data channels. When the 3644 Controller connects, the reservation is established for the connecting data channel. This reservation remains in effect even if the data channel disconnects the 3644 Controller by connecting another device. A reservation can be cleared only by a Master Clear, Clear Channel instruction, or a Release and Disconnect function code (0000) issued by the data channel having the reservation.

The 3644 Controller generates a Reject signal if a data channel attempts to connect it while reserved by the other data channel. This signal causes the central processor to jump to the reject jump address contained in the Connect instruction.

Even though a Connect operation results in a Reject, the 3644 Controller enables status information to the rejected data channel so that the reason for the reject can be determined.

The 3446 Controller is a single-channel controller and thus does not contain a reservation feature.

If for some reason a controller fails to return either a Reply or Reject, the central processor generates an Internal Reject after 100 microseconds. This signal acts the same as a Reject from an external device.

Connect Punch (N000)

This code connects the punch system to a data channel. The N portion of the code must match the setting of the Equipment Number switch.

Function Codes

Function codes set up or release various operating conditions in the punch system. Table A-2 lists all the Function codes applicable to the 3446/3644. A function code is the lower 12 bits of a Function instruction. When the central processor executes a Function instruction, the selected data channel sends the function code to all attached devices, but only the connected device responds.

The punch system accepts certain function codes only when it is Not Busy. If one of these codes arrives during a Busy period, the controller returns a Reject signal to the data channel. This signal causes the central processor to jump to the reject jump address contained in the Function instruction.

Any codes not listed in Table A-2 are do-nothing codes. The controller returns a Reply in response to such codes, but no action follows.

Release and Disconnect (0000)

This code disconnects the controller and clears the channel reservation. All interrupt selections and Negate BCD to Hollerith selections are cleared. The controller recognizes and replies to this function whether it is Busy or Not Busy.

Negate BCD to Hollerith Conversion (0001)

This code suppresses the normal internal BCD to Hollerith conversion so that data bytes can be punched directly on a card. Each byte is punched in a separate column. The controller rejects this code when Busy.

Release Negate BCD to Hollerith Conversion (0002)

This code returns the controller to the normal internal BCD to Hollerith Conversion mode. The controller rejects this code when Busy.

*Select Offset Stacker (0003)**

This code offsets a card by 3/8 inch in the output stacker of the CONTROL DATA 415 Card Punch. If the selection is to be effective (i. e., offset the card just read), it must be issued within 60 milliseconds after the controller becomes Not Busy. If it is not issued within 60 milliseconds, the card may be only partially offset or not offset at all. A separate function code must be issued for each card to be offset. The function is rejected if the controller is Busy.

Check Last Card (0004)

After the data channel has sent out data for the last card and the card has been punched, the card is positioned at the postpunch read station. The Check Last Card code advances the punch one cycle and performs the total hole count check on the last card. Also, in case of a feed failure, this code should be used to check the last card prior to manual intervention. The controller rejects this code when Busy.

* Control Data 415 Card Punch only

Clear (0005)

A Clear code removes any interrupt selection or interrupt condition and re-establishes the BCD to Hollerith mode of operation. It does not release a reservation or connection. The controller rejects this code when Busy.

Select Interrupt on Ready and Not Busy (0020)

This code conditions the punch system to send an Interrupt signal when it is idle and ready to begin an operation. The controller is Ready when:

- 1) Cards are present in the input hopper, prepunch, punch, and postpunch stations, and
- 2) The chip box and stacker are not full

The controller becomes Not Busy after a card is punched only if the data channel has terminated the Output operation. The controller accepts this code whether it is Busy or Not Busy.

Release Interrupt on Ready and Not Busy (0021)

This code inhibits interrupt on Ready and Not Busy. It also clears the Interrupt signal when caused by the Read and Not Busy condition. The controller accepts this code whether Busy or Not Busy.

Select Interrupt on End of Operation (0022)

This code conditions the punch system to send an Interrupt signal at the end of a card punch cycle if one of the following occurs:

- 1) The data channel terminates the Write operation,
- 2) The punch system becomes Not Ready, or
- 3) A comparison error.

The controller rejects this code when Busy.

Release Interrupt on End of Operation (0023)

This code inhibits Interrupt on End of Operation. It also clears the Interrupt signal when caused by an end of operation. The controller rejects this code when Busy.

Select Interrupt on Abnormal End of Operation (0024)

This code conditions the punch system to send an Interrupt signal at the end of a punch cycle if any of the following conditions occur:

- 1) Feed failure,
- 2) Stacker full,
- 3) Input hopper empty,
- 4) Chip box full, or
- 5) Comparison error.

Any of the above conditions cause the controller to become Not Ready. Thus, this interrupt may occur concurrently with Interrupt on End of Operation. The controller rejects this code when Busy. The interrupt causing conditions must be corrected before punch operations can resume.

Release Interrupt on Abnormal End of Operation (0025)

This code inhibits Interrupt on End of Operation. It also clears the Interrupt signal when caused by an abnormal condition.

Status Codes

Various operating conditions in the punch system are indicated by signals on the twelve status lines. Each line is 1 bit of a standard 12-bit status response. The punch system uses only 8 of these bits. Each status bit is assigned an octal code corresponding to its position in the 12-bit status response. If two or more conditions exist simultaneously, the Status Response code is the sum of the individual codes. This information can be sensed by means of the Copy Status and Sense Status instructions whenever the reader system is connected.

Three of the status lines indicate the three conditions that can cause the controller to send an Interrupt signal. Thus, the status feature can be used to identify the cause of an interrupt.

Ready (XXX1)—Bit 0

The ready status bit indicates that the punch system can proceed with a Punch operation. The punch is Ready when:

- 1) Cards are present in the input hopper, prepunch, punch, and postpunch stations,
- 2) The stacker is not full, and
- 3) The chip box is not full.

Once Ready, the punch remains Ready until one of the above conditions is not met. If a Not Ready condition arises during a Punch operation, the status bit drops only at the end of the punch cycle.

If the punch STOP switch is pressed, the punch becomes Not Ready at the end of the current punch cycle. The punch becomes Ready again when the RESET or READY switch is pressed.

Busy (XXX2)—Bit 1

The punch system becomes Busy when the data channel initiates a Write operation to load the buffer memory. After the Write operation terminates, the punch remains Busy until the card cycle is complete.

A Check Last Card function code also causes the punch system to become Busy while the hole count check is completed.

Fail to Feed (X1XX)—Bit 6

A feed failure indicates that when a punch cycle was initiated, a card did not feed from the hopper into the prepunch station.

Interrupt on Ready and Not Busy (X2XX)—Bit 7

This bit indicates that Interrupt on Ready and Not Busy (code 0020) was selected and that this condition now exists.

Interrupt on End of Operation (X4XX)—Bit 8

This bit indicates that Interrupt on End of Operation (code 0022) was selected and that this condition now exists.

Interrupt on Abnormal End of Operation (1XXX)—Bit 9

This bit indicates that Interrupt on Abnormal End of Operation (code 0024) was selected and that this condition now exists.

Compare Error (2XXX)—Bit 10

This bit indicates that the card punched on the previous cycle did not have total hole count equal to the "1" count. The bit remains up until another code is issued to the controller.

Reserved (by other channel) (4XXX)—Bit 11

This bit indicates that the punch is reserved by the other channel (3644 Controller only).

PROGRAMMING CONSIDERATIONS

Programming Procedure

A typical order of steps in programming the punch system is:

- 1) Clear (external Master Clear or Clear Channel instruction).
- 2) Connect.
- 3) Function (select interrupts or Negate BCD to Hollerith mode).
- 4) Initiate Write operation. Normally, a separate Write operation is initiated for each card.
- 5) Copy status when interrupt occurs to determine reason for end of operation.
- 6) Function (check last card after all cards have been punched).
- 7) Function (Release and Disconnect).

Timing

Table A-1, System Specifications, indicates the maximum rates for the two punches. Regardless of the punch being used, fully loading the buffer memory requires 2,200 microseconds for Hollerith punching and 2,560 microseconds for binary punching. To maintain maximum punching rates, the data channel must initiate a new Write operation for the next card shortly after the punch system becomes Not Busy. When the 415 Punch is used, the new Write must be started within 24 milliseconds for full-speed operation.

With the 523 Punch, the new Write must start within 15 milliseconds after the system becomes Not Busy to maintain maximum rate.

When the 415 Punch is used, the punch system becomes Not Busy about 238 milliseconds after the buffer memory is loaded. If the 523 Punch is used, the system becomes Not Busy approximately 598 milliseconds after the memory is loaded.

MANUAL OPERATION

SWITCHES AND INDICATORS

Card Punch Switches and Indicators

Refer to Section Z for a description of switches and indicators on the CONTROL DATA 415 Punch and the IBM 523 Punch.

Controller Switches and Indicators

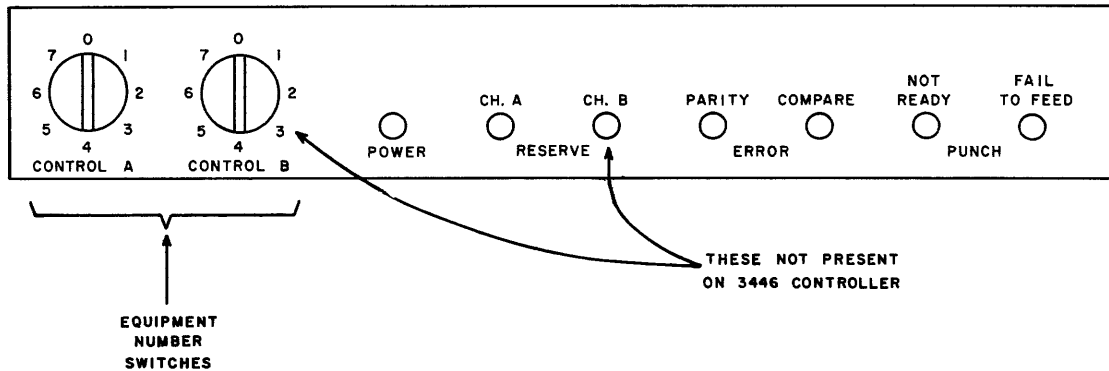

Figure A-2. Controller Switches and Indicators

Equipment Number Switches: On the 3446 Controller, there is one Equipment Number switch; on the 3644 Controller, there are two, one for each connect-reserve control. This eight-position switch (0-7) determines the equipment number (corresponds to upper 3 bits of Connect code) of a controller. It also determines on which of eight interrupt lines the controller sends an Interrupt signal.

RESERVE Indicators: These indicators (CH. A/CH. B) indicate the channel reserving the punch. They light following a connect and are turned off by a release, a channel clear, or a Master Clear. On the single-channel 3446 Controller, there is only one RESERVE indicator.

PARITY ERROR Indicator: This indicator indicates a parity error in the transmission of a Connect or function code from the data channel to the controller. It is turned off by a Clear Channel instruction or a Master Clear.

COMPARE ERROR Indicator: This indicator shows that the controller sensed a difference between the prepunch bit count and postpunch hole count during the comparison check. The indicator is turned off by any function code.

PUNCH NOT READY Indicator: This indicator indicates the punch is not in operable condition due to one of the following conditions:

- 1) Cards not present in hopper, prepunch, punch, or postpunch stations,
- 2) Stacker full,
- 3) Chip box full, or
- 4) Feed failure.

PUNCH FAIL TO FEED Indicator: This indicator indicates a card failed to feed from the hopper to the prepunch station. It causes a punch Not Ready condition. It is turned off by manually advancing cards from the hopper.

OPERATING PROCEDURE

To prepare the punch for operation:

- 1) Turn punch On.
 - a. On the 415 Punch, two power switches are located on switch panel.
 - b. On the 523 Punch, the power switch is located on end panel.
- 2) Place cards face down in hopper with row 9 facing the direction of card feed.
- 3) Check to see that the chip box and stacker are not full.
- 4) Advance cards into prepunch and postpunch stations.
 - a. On the 415 Punch, press SINGLE PICK switch twice.

- b.** On the 523 Punch, press START switch twice.
- 5) Master Clear from computer.
- 6) The NOT READY and FAIL TO FEED indicators on the controller should not be lighted.
- 7) The punch is now ready for an operation under program control.

SECTION B

3245-A CARD PUNCH CONTROLLER

CONTENTS

Functional Description	B-1	Codes	B-6
Card Format	B-1	Connect Code	B-7
Punching Cards	B-2	Function Codes	B-7
Card Check-Read	B-2	Status Codes	B-9
Sorting	B-4	Programming Considerations	B-10
Parity	B-4	Programming Procedure	B-10
Parity Error in Connect Code	B-4	Manual Operation	B-11
Parity Error in Function Code	B-4	Switches and Indicators	B-11
Parity Error During Write Operation	B-4	Card Punch Switches and Indicators	B-11
Parity Error During Check-Read Operation	B-5	Controller Switch and Indicators	B-11
Interrupt	B-5	Operating Procedure	B-12
Programming	B-6		

FIGURES

B-1 Typical Configuration	B-1	Assembled Row Patterns	B-3
B-2 Order of Assembly of Data Bytes	B-3		

TABLES

B-1 System Specifications	B-1	B-2 Connect, Function and Status Codes	B-6
---------------------------	-----	--	-----

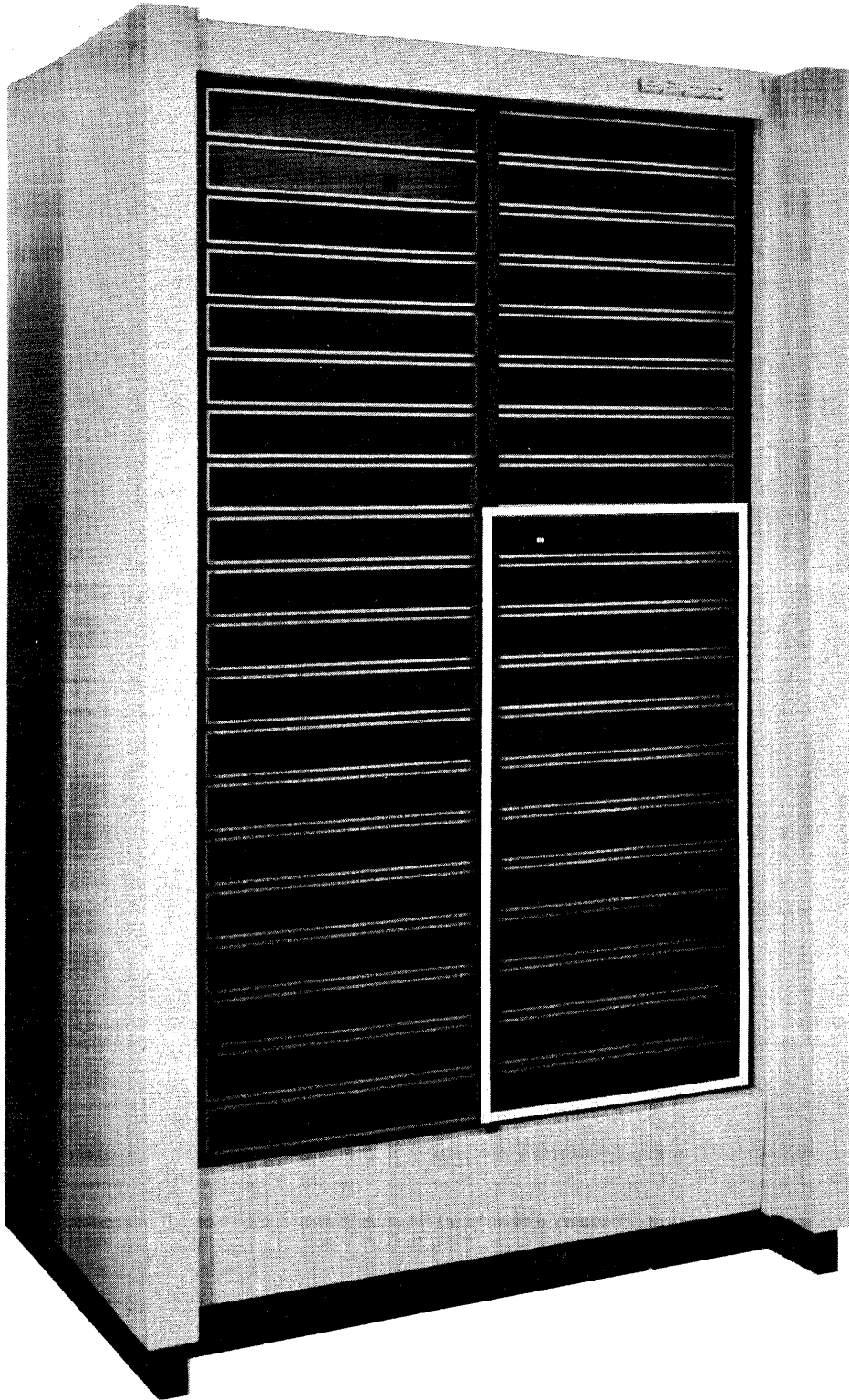

3245 CARD PUNCH CONTROLLER

3245-A CARD PUNCH CONTROLLER

This section describes a card punch system consisting of a CONTROL DATA* 3245 Card Punch Controller and a CONTROL DATA 415 Card Punch or IBM 523 Card Punch. The punch system can operate with any standard 3000 Series data channel. Figure B-1 shows a typical configuration. Table B-1 lists specifications.

The controller occupies a cabinet separate from the basic card punch.

This section describes data formats, explains the function of the punch and controller, and presents programming and operating instructions.

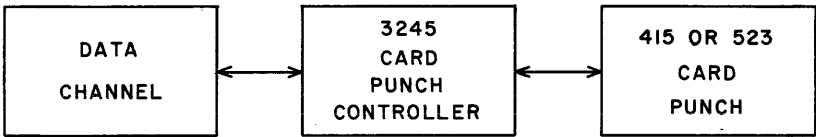

Figure B-1. Typical Configuration

TABLE B-1. SYSTEM SPECIFICATIONS

	CONTROL DATA 415 Punch	IBM 523 Punch
Processing Speed	250 cards/minute	100 cards/minute
Input Hopper Capacity	1, 200 cards	725 cards
Stacker Capacity	1, 500 cards	725 cards
Type of Cards	80-column only	80-column only

FUNCTIONAL DESCRIPTION

CARD FORMAT

The 3245 card punch systems can handle 80-column cards only. Cards can be punched in either Hollerith or binary format. Section Z, Punched Card Format and Codes, describes the card.

* Registered trademark of Control Data Corporation

PUNCHING CARDS

The card punch system is controlled by the data channel. It punches cards only when the data channel transmits a series of data bytes in response to a Write (Output) instruction.

A card punch cycle starts when the data channel initiates a Write operation. A cycle punches one card on a row-by-row basis from bottom to top, that is, row 9 first, row 12 last. During the punch cycle, the data channel must provide the data necessary to punch each row.

The 3245 Card Punch Controller assembles a series of data bytes into card row patterns. The data channel must deliver 8 12-bit bytes for each of the 12 80-column rows on a card. The controller uses only the lower 10 bits of each byte; the upper 2 bits are discarded.

Figures B-2 and B-3 show how 8 bytes are assembled to form a card row pattern. Byte 1 is punched in columns 1 through 10, bit 9 as column 1, bit 0 as column 10. This sequence is followed for the remaining bytes of that card row, byte 8 being punched in columns 71 through 80.

When a row pattern has been assembled, it is punched in the card. The controller then is ready to assemble the next row pattern.

There are 8 bytes per row and 12 rows per card. Thus, a total of 96 bytes are required to punch a card.

CARD CHECK-READ

A check-read feature permits the computer to read in information from a card for checking purposes after it has been punched. The checking must be done within the computer under program control.

The punch system check-reads each card on a row-by-row basis while the following card is being punched. Immediately after a punch row pattern is assembled, the corresponding row in the previous card can be read-in to the data channel. To punch and check-read cards, the data channel must first write 8 bytes to punch a row and then immediately read 8 bytes to read-in the corresponding row from the previous card. This sequence is repeated for each of the 12 rows. The punch cycle proceeds more slowly than the data channel so that there is sufficient time for the data channel to alternately write 8 bytes and then read 8 bytes for each row.

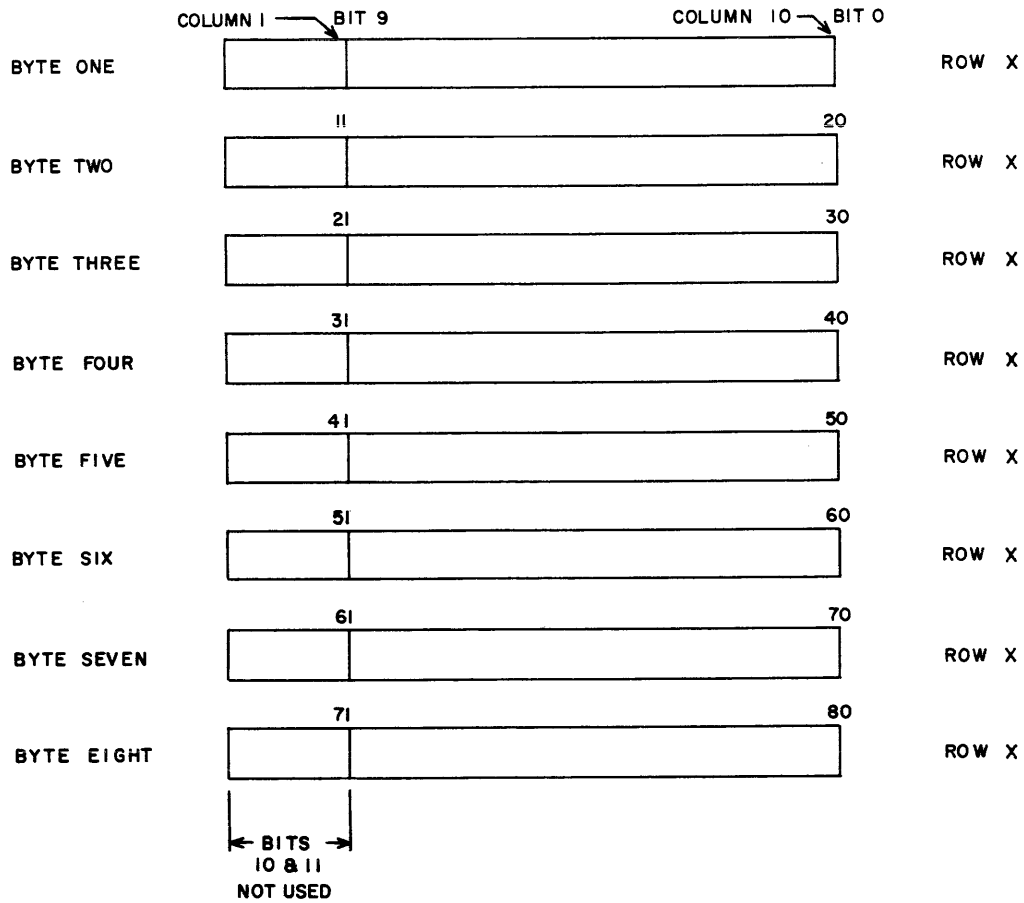

Bytes 1 through 8 indicate the assembly order for each row. Numbering on the figures is correct when cards are placed face down in the machine with row 9 facing in the direction of card feed.

Each byte is 12 bits long; bits 10 and 11 are not used.

Figure B-2. Order of Assembly of Data Bytes

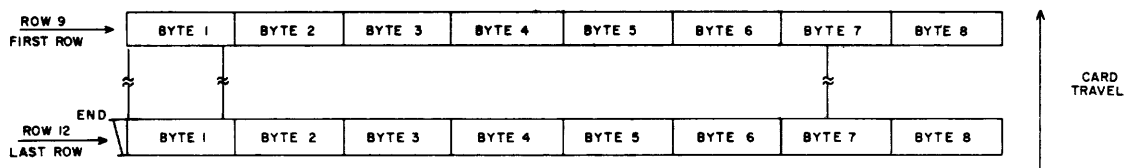

There are 8 bytes per row and 12 rows per card. Each byte contains 10 bits of information for a total of 960 bits per card (96 bytes).

Figure B-3. Assembled Row Patterns

Disassembly order during read-in is the same as assembly order during punching. That is, byte 1 contains columns 1 through 10, byte 2 contains columns 11 through 20, etc. The upper 2 bits of each input byte are always zero.

If the programmer does not wish to check-read, he simply omits the read-in portion of the operation.

SORTING*

A special function code (Select Offset Stacket) offsets a card slightly before it enters the stacker. The code must be issued for each card to be offset. To be effective, the code must arrive within 59 milliseconds after the card cycle is finished.

PARITY

All information exchanged between the data channel and controller is checked for parity.

Parity Error in Connect Code

The controller checks a Connect code sent from the data channel for correct parity. If a parity error is present, the controller does not connect, and Parity Error indicators on all equipments cabled to the data channel light. A Clear Channel instruction or Master Clear should be executed to clear the Parity Error indicators before another operation is executed.

Parity Error in Function Code

The controller checks each function code sent from the data channel for proper parity. If a parity error occurs in a function code, a Parity Error indicator on the controller lights, and the controller sends a Parity Error signal to the data channel. The controller does not execute the function. The Parity Error signal sets the input/output parity bit in the data channel. This signal should be cleared by a Clear Channel instruction or Master Clear before another operation is initiated.

Parity Error during Write Operation

During Write operations, the controller checks each data byte sent from the data channel for correct parity. If a parity error occurs, the Parity Error indicator on the controller sends a Parity Error signal to the data channel. This signal sets the input/output parity error bit in the data channel. If the data channel does not terminate the Write operation, the card punch uses the faulty data.

* CONTROL DATA 415 Punch only

The Parity Error signal should be cleared by a Clear Channel instruction or Master Clear.

Parity Error During Check-Read Operation

During check-read operation, the data channel checks each data byte sent from the controller for correct parity. If a parity error occurs, the input/output parity error bit in the data channel is set.

INTERRUPT

An interrupt feature enables the card punch system to notify the processor when it has completed an operation or when it can start a new operation. Thus, the main program can proceed with minimum regard for card punching operations. The punch notifies the central processor when it requires service.

The desired interrupts are selected and released by function codes (002X). When one of the selected interrupt conditions occurs, the controller sends an Interrupt signal via the data channel to the central processor. If the interrupt system in the central processor is set to recognize an input/output Interrupt signal, the main program halts. Usually, the processor executes a short program to service the punch system and then resumes the main program. If the processor's interrupt system has not been enabled, it is still possible to sense for these conditions via Sense Status and Copy Status instructions written into the main program.

Regardless of which of the above actions is followed, the Interrupt signal remains on the line until cleared by reselection of the interrupt condition (function code), release of the interrupt condition (function code), a Master Clear, or a Clear Channel instruction. All except reselecting the interrupt will also clear the selection.

The card punch system transmits the Interrupt signal to the data channel on one of eight interrupt lines. The setting of the eight-position Equipment Number switch on the controller determines which line is used. For example, if the switch is set to 4, the Interrupt signal goes out on line 4. A Channel Product Register Jump instruction* or Copy Status instruction** can identify which of several equipments attached to a data channel sends an interrupt by inspecting the eight interrupt lines.

Refer to the appropriate system reference manual for interrupt processing details.

* 3600/3800 systems
** 3100/3200/3300/3400 systems

PROGRAMMING

CODES

All connections and operations are controlled by 12-bit Connect and Function codes in conjunction with an appropriate Connect or Function instruction. When the Connect or Function is executed, a Reply signal is returned to the computer. This signal allows the computer to read the next programmed instruction. If the function cannot be executed, a Reject signal is returned to the computer. If neither a Reply nor a Reject signal is returned within 100 μ sec the channel generates an Internal Reject. Either reject instructs the computer to read the next instruction at the reject jump address specified by the instruction currently being executed.

Table B-2 lists all the codes applicable to the 3245 Controller. A detailed description of each code follows the table.

TABLE B-2. CONNECT, FUNCTION, AND STATUS CODES

CONNECT	
Connect Punch	N000*
FUNCTION	
Select Offset Stacker (Control Data 415 Punch only)	0003
Clear	0005
Select Interrupt on Ready and Not Busy	0020
Release Interrupt on Ready and Not Busy	0021
Select Interrupt on End of Operation	0022
Release Interrupt on End of Operation	0023
Select Interrupt on Abnormal End of Operation	0024
Release Interrupt on Abnormal End of Operation	0025
STATUS	
Ready	XXX1
Busy	XXX2
Fail to Feed	X1XX
Interrupt on Ready and Not Busy	X2XX
Interrupt on End of Operation	X4XX
Interrupt on Abnormal End of Operation	1XXX

* N = equipment number of controller

Connect Code

The card punch system must be connected to a data channel before it responds to a function code or a Read or Write operation.

Connect Punch (N000)

This code is the lower 12 bits of the Connect instruction and connects the punch system to the data channel. The N portion of the code must match the setting of the Equipment Number switch.

Each controller examines every Connect code received from its attached data channel. A Reply signal is returned to the data channel from a controller if:

- 1) A transmission parity error is not detected, and
- 2) The N portion of the Connect code matches the setting of an Equipment Number switch.

The controller does not connect and neither a Reply nor a Reject signal is returned to the data channel from the controller if:

- 1) A parity error is detected in the Connect code, or
- 2) The N portion of the code does not match the equipment setting of the controller.

In either case, if already connected, the controller disconnects. If no other equipment returns a Reply signal the computer generates an Internal Reject after 100 microseconds. This reject acts the same as one from a peripheral equipment.

Function Codes

Function codes set up or release various operating conditions in the punch system. Table B-1 lists all the Function codes applicable to the 3245 Controller. All codes not listed are do-nothing codes. The controller returns a Reply in response to such codes, but no action follows.

A function code is the lower 12 bits of a Function instruction. When the central processor executes a Function instruction, the selected data channel sends the function code to all attached devices, but only the connected device responds.

The punch system accepts function codes only when it is Not Busy. If a code arrives during a Busy period, the controller returns a Reject signal to the data channel. This

signal causes the central processor to jump to the reject jump address contained in the Function instruction. If, for any reason, the connected controller fails to return either a Reply or Reject the central processor generates an Internal Reject after 100 microseconds.

*Select Offset Stacker (0003)**

This code offsets the card which was check-read during the previous cycle. The card is offset while in the post-read position before entering the stacker. The code must be issued for each card to be offset within 59 milliseconds after the punch becomes Not Busy.

Clear (0005)

This code releases any interrupt selection and clears the Interrupt signal if present.

Select Interrupt on Ready and Not Busy (0020)

This code conditions the punch system to send an Interrupt signal when it is idle and ready to begin an operation. The controller is Ready when:

- 1) Cards are present in the input hopper, prepunch, punch, and postpunch stations,
- 2) The stacker is not full, and
- 3) The chip box is not full.

The controller becomes Not Busy after a card is punched only if the data channel has terminated the Output/Input operation.

Release Interrupt on Ready and Not Busy (0021)

This code inhibits Interrupt on Ready and Not Busy. It also clears the Interrupt signal when caused by the Read and Not Busy condition.

Select Interrupt on End of Operation (0022)

This code conditions the punch system to send an Interrupt signal at the end of a punch cycle if the data channel has terminated the Output/Input operation or if the punch becomes Not Ready at the end of a punch cycle even though the data channel remains active.

Release Interrupt on End of Operation (0023)

This code inhibits Interrupt on End of Operation. It also clears the Interrupt signal when caused by an End of Operation.

*CONTROL DATA 415 Punch only

Select Interrupt on Abnormal End of Operation (0024)

This code conditions the punch system to send an Interrupt signal at the end of a punch cycle if any of the following conditions occur:

- 1) Feed failure.
- 2) Stacker full.
- 3) Input hopper empty.
- 4) Chip box full.

Any of the above conditions cause the punch to become Not Ready and must be corrected before punch operations can resume.

Release Interrupt on Abnormal End of Operation (0025)

This code inhibits Interrupt on End of Operation. It also clears the Interrupt signal when caused by an abnormal condition.

Status Codes

Various operating conditions of the punch system are indicated by signals on six of the twelve status lines. Each line is 1 bit of a standard 12-bit status response. The punch system uses only 6 of these bits. This information is available to the channel during the entire time the reader is connected and can be sensed by the Copy Status and Sense Status instructions.

Each status bit is assigned an octal code corresponding to its position in the 12-bit status response. Table B-1 lists the status codes. If two or more conditions exist simultaneously, the Status Response code is the sum of the individual codes.

Three of the status lines indicate the three conditions that can cause the controller to send an Interrupt signal. Thus, the status feature can be used to identify the cause of an interrupt.

Ready (XXX1)—Bit 0

The ready status bit indicates that the punch system can proceed with a Punch operation. The punch is Ready when:

- 1) Cards are present in the input hopper, prepunch, punch and postpunch stations,
- 2) The stacker is not full, and
- 3) The chip box is not full.

Once Ready, the punch remains Ready until one of the above conditions ceases to exist. If a Not Ready condition arises during a Punch operation, the status bit drops only at the end of the punch cycle.

If the punch STOP switch is pressed, the punch becomes Not Ready at the end of the current punch cycle. The punch becomes Ready again when the RESET or READY switch is pressed.

Busy (XXX2)—Bit 1

The punch system becomes Busy when the data channel initiates a Write operation. It remains Busy until the data channel terminates the Output/Input operation and the punch cycle is completed.

Fail to Feed (X1XX)—Bit 6

A feed failure indicates that, when a punch cycle was initiated, a card did not feed from the hopper into the prepunch station.

Interrupt on Ready and Not Busy (X2XX)—Bit 7

This bit indicates that Interrupt on Ready and Not Busy (0020) was selected and that this condition now exists.

Interrupt on End of Operation (X4XX)—Bit 8

This bit indicates that Interrupt on End of Operation (0022) was selected and that this condition now exists.

Interrupt on Abnormal End of Operation (1XXX)—Bit 9

This bit indicates that Interrupt on Abnormal End of Operation (0024) was selected and that this condition now exists.

PROGRAMMING CONSIDERATIONS

Programming Procedure

A typical order of steps in programming the punch system is:

- 1) Clear (external Master Clear or Clear Channel instruction),
- 2) Connect,

- 3) Function (select interrupts),
- 4) Initiate Write and check-read operations, and
- 5) Copy status when interrupt occurs to determine reason for end of operation.

MANUAL OPERATION

SWITCHES AND INDICATORS

Card Punch Switches and Indicators

Refer to Section Z for descriptions of the switches and indicators on the CONTROL DATA 415 Punch and the IBM 523 Punch.

Controller Switch and Indicators

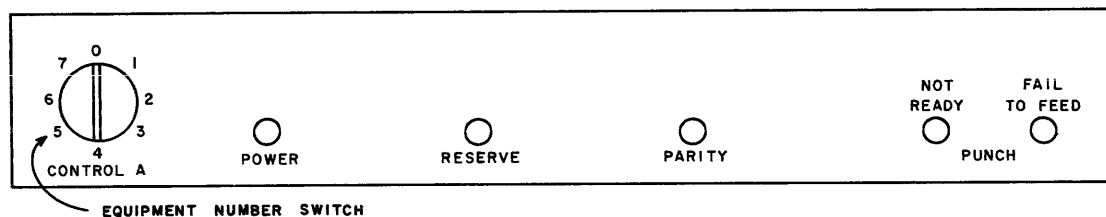

Figure B-4. Controller Switch and Indicators

Equipment Number Switch: This eight-position switch designates the equipment number (corresponds to upper 3 bits of Connect code) of the controller. It also determines on which one of eight interrupt lines the controller sends the Interrupt signal.

POWER Indicator: This indicator indicates that dc voltage is applied to logic.

RESERVE Indicator: This indicator indicates that the unit has been connected to the data channel.

PARITY Indicator: This indicator indicates a parity error in the transmission of a Connect or a Function code from the data channel to the controller. It is turned off by a Master Clear or Clear Channel instruction.

PUNCH NOT READY Indicator: This indicator indicates a Not Ready condition in the punch, such as stacker full, hopper empty, chip box full, etc.

PUNCH FAIL TO FEED Indicator: This indicator indicates a card failed to feed from hopper to prepunch station; this also causes a punch Not Ready condition. It is turned off by manually advancing cards from hopper.

OPERATING PROCEDURE

To prepare the card punch system for use:

- 1) Turn punch on.
 - a) On 415 Punch, two Power switches are located on switch panel.
 - b) On 523 Punch, the Power switch is located on end panel.
- 2) Place cards face down in hopper with row 9 facing the direction of card feed.
- 3) Check to see that the chip box and stacker are not full.
- 4) Advance cards into prepunch and postpunch stations.
 - a) On 415 Punch, press SINGLE PICK switch twice
 - b) On 523 Punch, press START switch twice.
- 5) Master Clear from computer.
- 6) The NOT READY and FAIL TO FEED indicators on the controller should not be lighted.
- 7) The punch is now ready for an operation under program control.

SECTION C

3248 -A/3447 -A/3649-A CARD READER CONTROLLERS

CONTENTS

Functional Description	C-2	Programming	C-7
System Relationship	C-2	Codes	C-7
Card Format	C-2	Connect Code	C-8
Read Operation	C-3	Function Codes	C-9
Suppress Assembly Mode	C-3	Status Codes	C-12
Buffer Memory (3649 and 3447 Controller only)	C-4	Programming Considerations	C-14
Input to A (3649 Controller only)	C-4	Programming Procedure	C-14
Sorting	C-5	Card Cycle Timing for 3649 and 3447	C-15
Parity	C-5	Card Cycle Timing for 3248	C-16
Parity Error in a Connect Code	C-5	Manual Operation	C-17
Parity Error in a Function Code	C-5	Switches and Indicators	C-17
Parity Errors in Input Data	C-6	Switches and Indicators on 405 Card Readers	C-17
Interrupt	C-6	Switches and Indicators on Controller	C-20
		Operating Procedure	C-21

FIGURES

C-1	Typical Configurations	C-1	C-6	Card Reader Switches and Indicators (Used with 3248 Controller)	C-18
C-2	Card Cycle Timing (3649 and 3447)	C-15			
C-3	Card Cycle Timing (3248)	C-16	C-7	3447/3649 Controller Switches and Indicators	C-20
C-4	Card Reader Switches and Indicators (Used with 3649 Controller)	C-17	C-8	3248 Controller Switches and Indicators	C-20
C-5	Card Reader Switches and Indicators (Used with 3447 Controller)	C-18			

TABLES

C-1	System Specifications	C-1	C-2	Connect, Function, and Status Codes	C-7
-----	-----------------------	-----	-----	--	-----

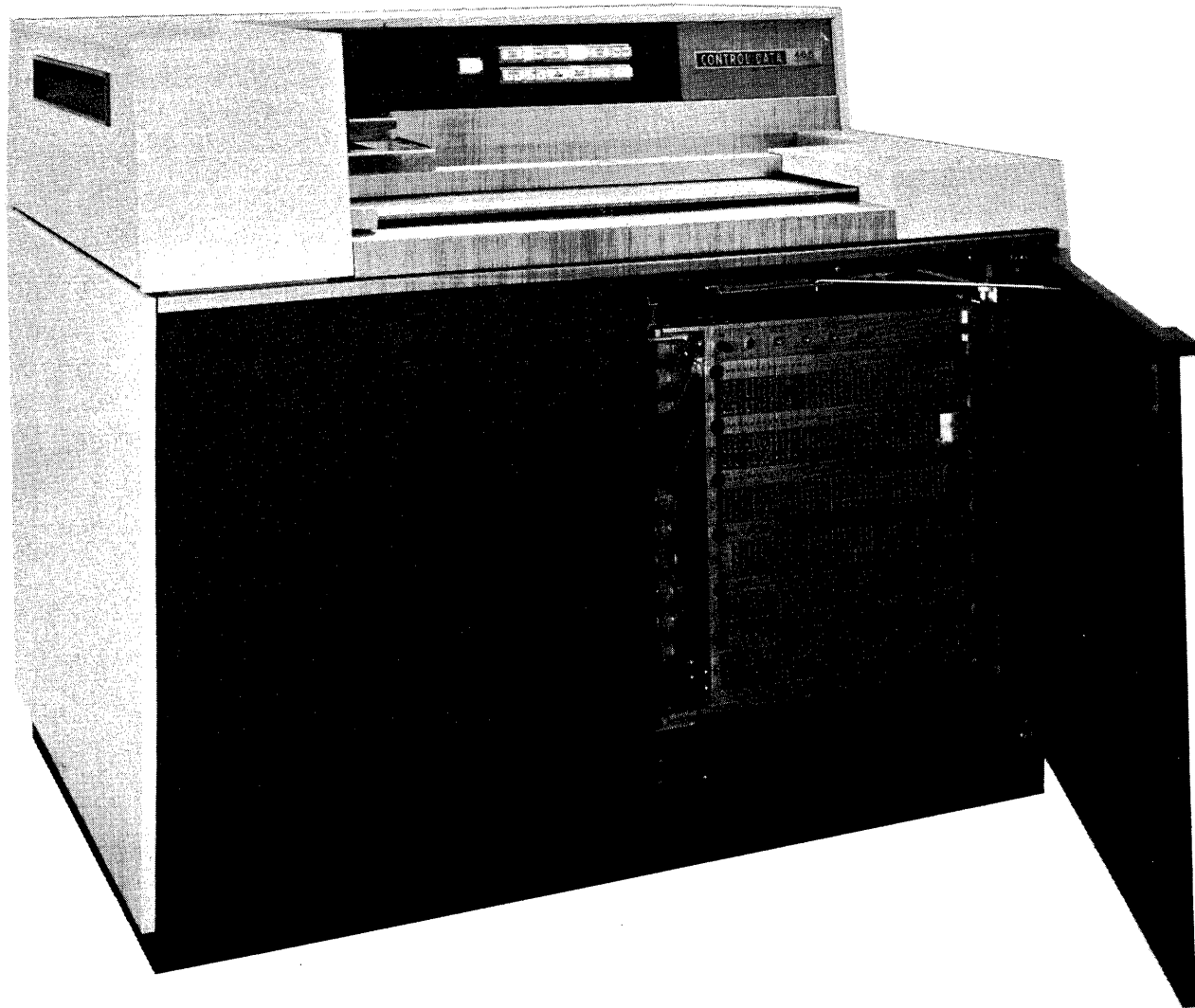

3649 CARD READER CONTROLLER

3248-A/3447-A/3649-A CARD READER CONTROLLERS

This section describes card reader systems consisting of a CONTROL DATA* 405 Card Reader controlled by a CONTROL DATA 3248, 3447, or 3649 Card Reader Controller. These systems operate with any 3000 Series data channel. Figure C-1 shows typical system configurations. Table C-1 gives system specifications.

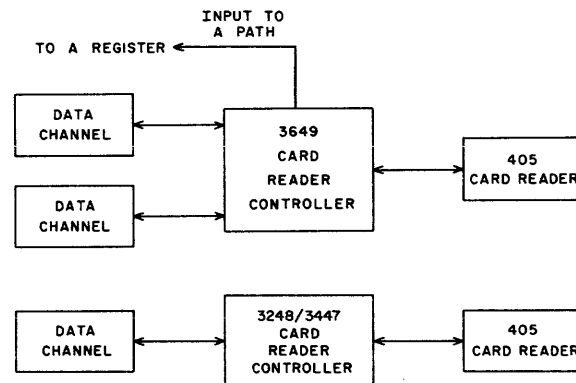

Figure C-1. Typical Configurations

TABLE C-1. SYSTEM SPECIFICATIONS

Reading Rate	1,200 80-column cards per minute 1,600 51-column cards per minute
Input Tray	4,000 - card capacity
Receiving Trays	4,000-card primary receiving tray 240-card secondary receiving tray
Data Transfer Rate:	Buffer memory in the 3447 and 3649 controllers permits high-speed transfer to data channel: 390 microseconds/80-column card

The controllers supplement basic reader logic and are mounted in the 405 Reader cabinet. The three controllers are similar; however, there are three major differences:

- 1) The 3649 Controller is a two-channel device; the 3447 and 3248 Controllers are single-channel devices.
- 2) The 3649 provides an Input to A path directly to the A register in the central processor. The 3447 and 3248 do not provide this feature.
- 3) The 3649 and 3447 provide a buffer memory. The 3248 does not.

This section presents data formats, the function of the controller, programming information, and operating instructions.

*Registered trademark of Control Data Corporation

FUNCTIONAL DESCRIPTION

SYSTEM RELATIONSHIP

The 3649, 3447, and 3248 Controllers perform control and data conversion functions necessary to operate a 405 Card Reader into a 3000 Series data channel.

The 3649 Controller contains two connect-reserve controls and can be connected by cables to two data channels. Reserve logic in each controller prevents both data channels from communicating simultaneously with the 3649 Controller. An equipment number is assigned to each connect-reserve control.

The 3447 and 3248 Controllers are single-channel controllers and are connected by cables to only one data channel. They are assigned a unique equipment number (0-7) to distinguish them from other equipments attached to the data channel.

CARD FORMAT

The 405 Card Reader controlled by the 3649, 3447, or 3248 handles either 80 or 51 column cards. Section Z, Punched Card Format and Codes, describes the card.

The 3649, 3447 and 3248 Controllers treat data received from the reader as being in either Hollerith or binary format. Provided the card is not a binary card the controller treats data received from the reader as being in Hollerith format following:

- 1) A manual Master Clear,
- 2) A Clear Channel instruction,
- 3) A Clear function code, or
- 4) A Release and Disconnect function code (3649 and 3447 only).

Thus, the controller converts each 12-bit code received into one 6-bit BCD code.* Then, unless in Suppress Assembly mode, the controller assembles two 6-bit BCD codes into one 12-bit word and transmits it to the data channel. The code received from an odd numbered column is placed in the upper 6-bit positions and that received from an even numbered column is placed in the lower 6-bit positions. When a 51-column card is read, the lower 6 bits of the last input byte (byte 26) contain all zeros.

NOTE

The controller does not distinguish between legal (listed) Hollerith codes and illegal ones. It supplies a listed BCD code for each Hollerith

*Table Z-1, Section Z lists the Hollerith codes and corresponding BCD codes. Any combination of bits not shown is an illegal Hollerith code.

code received. This BCD code, however, may not have meaning. There is no alarm or indication that an illegal code has been processed.

A card with punches in rows 7 and 9 of column one is a binary card. The controller treats the data on this card as binary data, that is, each 12-bit column is transmitted without translation directly to the data channel. The top row (row 12) is the upper bit in the byte; the bottom row (row 9) corresponds to bit 0.

A card with punches in rows 7 and 8 of column one is a File card. It may be used to indicate the last card in a deck and/or it may be used to send an Interrupt signal to the computer (see Interrupt on Abnormal End of Operation function code).

The 3649, 3447, and 3248 Controllers also treat data received from the reader as being binary if issued a Negate Hollerith to BCD Conversion function code. This code allows 7 and 8 punches in column one to be treated as binary data but does not allow them to be recognized as indicating a file card.

READ OPERATION

The card reader system is controlled by the data channel. Card motion begins when the data channel requests data in response to a Read (Input) instruction. A card is then read on a column-by-column basis beginning with column 1. When the data channel terminates the Read operation, card motion stops as soon as the last card read is in the receiving tray. If a Read operation terminates when only a portion of a card has been read, this card continues through the read station and data on the unread portion of the card is lost. The next Read operation reads the next card.

Each card is a record of data. After each card is read, the controller sends an End of Record signal to the data channel. This signal in some cases, causes the data channel to terminate the Read operation*.

SUPPRESS ASSEMBLY MODE**

The controller automatically enters Suppress Assembly mode in response to either of the following 6-bit input instructions

- 1) Character Addressed Input to Storage (INPC) in which H (bit 18) = 0.
- 2) Input, Character to A (INAC).

* In 3100/3200/3300 systems, the End of Record signal always terminates a Read operation. In 3400/3600/3800 systems, this use is optional.

** Applicable in 3100/3200/3300 systems only.

When this mode is in effect the controller does not pack two BCD codes into each byte. Instead, it places each BCD code into the lower 6 bits of a separate 12-bit byte. The upper 6 bits of each byte contain all zeros.

Six-bit input is not permitted if the Negate Hollerith to BCD mode is in effect or if a binary card is read. In either of these cases, the controller generates an Interrupt signal if Interrupt on Abnormal End of Operation has been selected.

BUFFER MEMORY (3649 and 3447 Controllers only)

The 3649 and 3447 controllers contain a buffer memory that holds one card image of 80 12-bit words. The reader enters data from each card into memory at a relatively slow rate (50 milliseconds/80-column card). After a complete card has been entered, the data channel can read the information from memory at a rapid rate (maximum rate: 390 microseconds/80-column card). The reader automatically enters another card into memory after the data channel has read-out the first card. During the 50-millisecond period required to reload the buffer memory, the data channel can be used to service some other device.

Card motion stops if the data channel does not unload the buffer memory within 1.5 milliseconds after the buffer is loaded.

If a Read operation unloads only a portion of memory and then terminates, the next card immediately enters memory.

INPUT TO A (3649 CONTROLLER ONLY)*

The Card Mode switch on the computer console selects the reader for Input to A.

During Input to A operations, the 3649 Controller transmits 12-bit bytes to the A register in the central processor via a direct path. A data channel is not used. Each time the computer executes an Input to A instruction, the controller sends one 12-bit byte to lower 12 bits of the A register. A 12-bit byte consists of one card column in binary form. There is no Hollerith to BCD conversion.

As long as the reader remains selected for Input to A, a new card enters into the buffer memory only after the previous card has been completely read by the computer. However, if the reader is deselected when a card is only partly read, a new card immediately enters the buffer memory.

*Only the 3600/3800 systems have a direct Input to A path.

Input to A operations cannot proceed if the controller is connected to or reserved by a data channel. In this case, the controller does not respond to an Input to A instruction, and the program stops.

SORTING

A special function code (Set Gate Card) permits a limited Sorting operation. As cards are read, they normally flow to the primary stacker. Each time the Set Gate Card code is received, the reader diverts the current card to the secondary stacker.

PARITY

Connect codes, function codes, and data are transmitted between the data channel and the controller in odd parity (i. e., the number of "1" bits transmitted must be odd). If the number of "1" bits in a data byte is even, a "1" is transmitted on the parity line to make the total number of "1" bits odd*. If the number of "1" bits in the data byte is odd, a "0" is transmitted on the parity line.

Parity is checked when information is transmitted on the 12 data lines and the parity line. If the total number of "1" bits on these 13 lines is even, a transmission parity error has occurred indicating that a bit has been lost or picked up.

Parity Error in a Connect Code

If a parity error is detected in a Connect code, the device does not connect** and neither a Reject nor a Reply is returned to the data channel. Instead, the Parity Error indicator lights. These parity error conditions must be cleared by either a Clear Channel instruction or a manual Master Clear prior to a new connect attempt.

Parity Error in a Function Code

If a parity error is detected, the requested functions are not performed, a Parity Error signal is returned to the data channel, and the Parity Error indicator lights. Since neither a Reject nor a Reply is returned to the data channel, the data channel generates

* Do not confuse this line with the parity error line.

** If the device is connected, it automatically disconnects.

an Internal Reject after a delay of 100 microseconds. These Parity Error indicators must be cleared by a Clear Channel instruction or a manual Master Clear*. The equipment must then be reconnected before a new function code can be examined by the controller.

Parity Errors in Input Data

Transmission parity errors may be detected by the data channel on data received from the equipment during a Read operation. If a parity error is detected, a Parity Error signal is returned to the data channel and a Parity Error indicator on either the channel or console is lighted. (The faulty data is entered into either core storage or the A register.)

INTERRUPT

An interrupt feature enables the card reader system to notify the processor when it can start an operation, when it has completed an operation, or when an abnormal condition makes further operation impossible. Thus, the main program can proceed with minimum regard for card reading operations. The reader notifies the central processor when it requires service.

The desired interrupts are selected by function codes. When one of the selected interrupt conditions occurs, the controller sends an Interrupt signal via the data channel to the central processor. If the interrupt system in the central processor is set to recognize an input/output Interrupt signal, the main program halts. Usually, the processor executes a short program to service the card reader and then resumes the main program.

If the processor's interrupt system has not been enabled, it is still possible to sense for these conditions via Sense Status and Copy Status instructions written into the main program.

Regardless of which the above actions is followed, the Interrupt signal remains on the line until cleared by reselection of the interrupt condition (function code), release of the interrupt condition (function code), selection of the Release and Disconnect function code**, a Clear Channel instruction, or a manual Master Clear. All except reselecting the interrupt will also clear the interrupt selection.

* Though operations may continue normally, the validity of a new function and/or data prior to a Master Clear or Clear Channel is questionable.

** 3447/3649 only

The card reader system transmits the Interrupt signal to the data channel on one of eight interrupt lines. The setting of the eight-position Equipment Number switch on the controller determines which line is used. For example, if the switch is set to 4, the Interrupt signal goes out on line 4. A Channel Product Register Jump instruction* or Copy Status instruction** can identify which of several equipments attached to a data channel sends an interrupt by inspecting the eight interrupt lines.

Refer to the appropriate system reference manual for interrupt processing details.

PROGRAMMING

CODES

All connections and operations are controlled by 12-bit Connect and Function codes in conjunction with an appropriate Connect or Function instruction. When the Connect or the Function is executed, a Reply signal is returned to the computer. This signal allows the computer to read the next programmed instruction. If the Connect or the Function cannot be executed immediately, a Reject signal is returned to the computer. This signal instructs the computer to read the next instruction at the reject jump address specified by the instruction currently being executed.

Table C-2 lists all the codes applicable to the 3649, 3447, and 3248 Controllers. A detailed description of each code follows the table.

TABLE C-2. CONNECT, FUNCTION, AND STATUS CODES

CONNECT	
Connect Reader	N000†
FUNCTION	
Release and Disconnect (3447, 3649 only)	0000
Negate Hollerith to Internal BCD Conversion	0001
Release Negate Hollerith to Internal BCD Conversion	0002
Set Gate Card	0004
Clear	0005
Select Interrupt on Ready and Not Busy	0020
Release Interrupt on Ready and Not Busy	0021

* 3600/3800 systems
 ** 3100/3200/3300/3400 systems
 † N = equipment number of controller

TABLE C-2. CONNECT, FUNCTION
AND STATUS CODES (Cont'd)

FUNCTION (Cont'd)	
Select Interrupt on End of Operation	0022
Release Interrupt on End of Operation	0023
Select Interrupt on Abnormal End of Operation	0024
Release Interrupt on Abnormal End of Operation	0025
STATUS	
Ready	XXX1
Busy	XXX2
Binary Card	XXX4
File Card	XX1X
Fail to Feed or Stacker Full or Jam	XX2X
Input Tray Empty	XX4X
End of File	X1XX
Interrupt on Ready and Not Busy	X2XX
Interrupt on End of Operation	X4XX
Interrupt on Abnormal End of Operation	1XXX
Read Compare or Preread Error	2XXX
Reserved (by other channel) (3649 only)	4XXX

Connect Code

The card reader system must be connected to a data channel before it responds to a function code or an Input operation.

Connect Reader (N000)

This code is the lower 12 bits of the Connect instruction. The N portion of the code specifies the controller equipment number.

Each controller examines every Connect code received from its attached data channel. The controller connects and returns a Reply signal to the data channel if:

- 1) A transmission parity error is not detected, and
- 2) The N portion of the Connect code matches the setting of its Equipment Number switch.

The controller does not connect and neither a Reply nor a Reject signal is returned to the data channel from the controller if:

- 1) A parity error is detected in the Connect code, or
- 2) The N portion of the code does not match the equipment setting of the controller.

In either case, if already connected, the controller will disconnect. If no other equipment returns a Reply signal the channel generates an Internal Reject after 100 microseconds. This reject acts the same as one from a peripheral equipment.

The 3649 Controller contains a channel reservation feature that prevents interference between the two data channels. When the 3649 Controller connects, a reservation is established for the connecting data channel. This reservation remains in effect even if the data channel disconnects the 3649 Controller by connecting another device. A reservation can be cleared only by a Master Clear, Clear Channel instruction, or Release and Disconnect function code (0000) sent from the reserving channel.

If a data channel attempts to connect the 3649 Controller while it is reserved by the other data channel, the 3649 Controller generates a Reject signal. This signal causes the central processor to jump to the reject jump address contained in the Connect instruction. Even though a Connect operation results in a reject, the 3649 Controller enables status information to the rejected data channel so that the reason for the Reject can be determined.

Function Codes

Function codes set up or clear various operating conditions in the reader system. Table C-2 lists all the Function codes applicable to the 3649, 3447, and 3248 Controllers. All codes not listed are do-nothing codes. The controller returns a Reply in response to such codes, but no action follows.

A function code is the lower 12 bits of a Function instruction. When the central processor executes a Function instruction, the selected data channel sends the function code to all attached devices, but only the connected device responds.

The 3447 controller responds to all function codes by returning a Reply signal. The 3649 and 3248 Controllers cannot accept certain function codes when Busy. If a 3649 or 3248 accepts a code, it returns a Reply signal. If the 3649 or 3248 cannot accept a code because it is busy when the code arrives, it returns a Reject signal to the data channel. If

for any reason a controller fails to return either a Reply or a Reject, the channel generates an internal Reject after 100 microseconds.

Release and Disconnect (0000)

This code disconnects the controller and clears the channel reservation. All interrupt selections and the Negate BCD to Hollerith selection are cleared. When Busy, the 3649 Controller rejects this code. The 3447 Controller accepts this code at any time. This code does not exist in the 3248.

Negate Hollerith to Internal BCD Conversion (0001)

Release Negate Hollerith to Internal BCD Conversion (0002)

Normally, the controller performs a Hollerith to Internal BCD conversion on all cards except those cards flagged as binary by punches in rows 7 and 9 in column 1. Code 0001 eliminates this conversion so that all cards are treated as binary cards. Code 0002 returns the controller to the normal Hollerith to Internal BCD mode.

Set Gate Card (0004)

The Set Gate Card code allows the reader to do a limited Card Sorting operation. The selected cards are directed to the secondary stacker. The code must be given for each card that is to be gated and must arrive within 1.5 milliseconds after the last column of the selected card has been read.

Clear (0005)

The clear code clears any interrupt selection, Interrupt signal, or negate condition. It does not release a reservation or connection.

Select Interrupt on Ready and Not Busy (0020)

The Select Interrupt on Ready and Not Busy code conditions the 3447 or 3649 to send an Interrupt signal whenever data is available in the buffer memory for input and the data channel has not initiated a Read operation. It conditions the 3248 to send an Interrupt signal when it is idle and ready to begin an operation. The 3248 is ready as long as

cards are in the input tray, the primary and secondary stackers are not full, and no abnormal conditions exist. The reader becomes Not Busy after a card is read if the data channel terminates the Read operation.

Release Interrupt on Ready and Not Busy (0021)

The Release Interrupt on Ready and Not Busy code inhibits interrupt on Ready and Not Busy. It also clears the Interrupt signal when caused by the Ready and Not Busy condition.

Select Interrupt on End of Operation (0022)

The Select Interrupt on End of Operation code conditions the reader system to send an Interrupt signal whenever:

- 1) The data channel terminates a Read operation, and
- 2) The reader system becomes Not Ready.

Release Interrupt on End of Operation (0023)

The Release Interrupt on End of Operation code inhibits Interrupt on End of Operation. It also clears the Interrupt signal when caused by an end of operation.

Select Interrupt on Abnormal End of Operation (0024)

The Select Interrupt on Abnormal End of Operation code conditions the reader system to send an Interrupt signal when one of the following conditions occurs:

- 1) Stacker full or jammed,
- 2) Input tray empty,
- 3) Feed failure,
- 4) Illegal Suppress Assembly (6-bit input) operation,
- 5) Compare or preread error (malfunctions),
- 6) The AUTO/MAN switch is changed to the MAN position, or
- 7) A file card (punches in rows 7 and 8 in column 1) is read.

Any of the first six conditions disable the device and cause the reader to become Not Ready. Thus, if Interrupt on End of Operation has been selected it may occur along with Interrupt on Abnormal End of Operation. These conditions must be corrected before Read operations can resume.

Release Interrupt on Abnormal End of Operation (0025)

This code inhibits Interrupt on Abnormal End of Operation. It also clears the Interrupt signal when caused by an abnormal condition.

Status Codes

Various operating conditions of the reader system are indicated to the data channel on the 12 status lines. Each line is 1 bit of a 12-bit quantity. The information is available to the channel during the entire time the reader is connected and can be sensed by the Copy and Sense Status instructions. If two or more conditions exist simultaneously, the Status Response code is the sum of the individual codes. Table C-2 lists the status conditions.

Three of the status lines indicate the three conditions that can cause the controller to send an Interrupt signal. Thus, the status feature can be used to identify the condition causing the interrupt.

Ready (XXX1)—Bit 0

The 3447/3649 reader systems become Ready when the first card has been loaded into memory and remain ready throughout Read operations. The 3248 reader system becomes Ready when it is prepared to read cards under program control, i. e., the input tray contains cards, the stacker is not full, and the AUTO/MAN switch is in the AUTO position. Any of the following conditions cause the 3248, 3447, or 3649 to become Not Ready (status bit becomes "0"):

- 1) Stacker full or jammed,
- 2) Input tray empty,
- 3) Illegal Suppress Assembly (6-bit input) operation,
- 4) Compare or preread error,
- 5) The AUTO/MAN switch is changed to the MAN position, or
- 6) Feed failure.

These conditions also cause Interrupt on End of Operation and Interrupt on Abnormal End of Operation if selected.

Busy (XXX2)—Bit 1

The 3447/3649 Reader systems are busy:

- 1) Whenever a card is being entered into buffer memory, or
- 2) The data channel is reading data from the buffer memory.

The 3248 Reader system is busy:

- 1) Whenever a card is passing through the read station, or
- 2) The data channel is reading data from the reader system.

Binary (XXX4)—Bit 2

The presence of punches in rows 7 and 9 in column 1 on a card flags a binary card. The read station senses information in this column when reading the card. For the 3447/3649, bit 2 is present after memory is loaded and the binary card is read. For the 3248 this status bit becomes "1" when column 1 is read and remains up until one milli-second before the next card is read. The Negate Hollerith to BCD Conversion Function code also sets this bit.

File Card (XX1X)—Bit 3

This condition exists when a card containing a punch in rows 7 and 8 of column 1 of a Hollerith card is detected. This code is not generated when the Negate Hollerith to BCD mode is in effect. The file card status bit is cleared by Negate Hollerith to Internal BCD Conversion (Function code 0001), Clear (Function code 0005), or reinitiating a Read operation. The controller also generates an Abnormal End of Operation interrupt after reading a file card if this interrupt condition has been selected.

Fail to Feed or Stacker Full or Jam (XX2X)—Bit 4

Input Tray Empty (XX4X)—Bit 5

These status conditions are abnormal conditions and are self-explanatory.

End of File (X1XX)—Bit 6

This status bit becomes "1" when the input tray is empty (and buffer memory unloaded for 3649 and 3447) if the END OF FILE switch is on. When the input tray does not contain the last card of a file, the switch should be off to inhibit this status bit.

Interrupt on Ready and Not Busy (X2XX)—Bit 7

This bit indicates that Interrupt on Ready and Not Busy was selected and that this condition now exists.

Interrupt on End of Operation (X4XX)—Bit 8

This bit indicates that Interrupt on End of Operation was selected and that this condition now exists.

Interrupt on Abnormal End of Operation (1XXX)—Bit 9

This bit indicates that Interrupt on Abnormal End of Operation was selected and that one of the abnormal conditions now exists.

Read Compare or Preread Error (2XXX)—Bit 10

Bit 10 indicates that either a comparison error was detected during the transfer of card information to memory or a read amplifier was not functioning properly prior to reading the information from the card to memory.

Reserved (by other channel) (4XXX)—Bit 11

This code indicates that the reader is reserved by the other channel (3649 Controller only).

PROGRAMMING CONSIDERATIONS

Programming Procedure

A typical order of steps in programming the reader system is:

- 1) Clear (by external Master Clear or Clear Channel instruction),
- 2) Connect,
- 3) Function (select interrupts and operating mode) ,
- 4) Initiate Read operation, and
- 5) Copy Status when End of Operation interrupt occurs to determine reason for end of operation.

Card Cycle Timing for 3649 and 3447

Figure C-2 shows the timing for one card cycle with the 3649 or 3447. The data channel must be connected to the reader system only while the contents of the buffer memory is read in. As soon as the data channel has unloaded buffer memory, the reader automatically enters the next card into memory. During the advance and load periods the data channel can disconnect from the reader system to service some other device.

After a card has been entered into memory, the data channel must complete reading in this data within 1.5 milliseconds or card motion stops. Unloading the memory requires a minimum of 384 microseconds for 80-column cards and 245 microseconds for 51-column cards.

When a card has been loaded into memory, the reader system becomes Not Busy if the data channel does not begin a Read operation. In this case, the controller generates an interrupt if Interrupt on Ready and Not Busy has been selected.

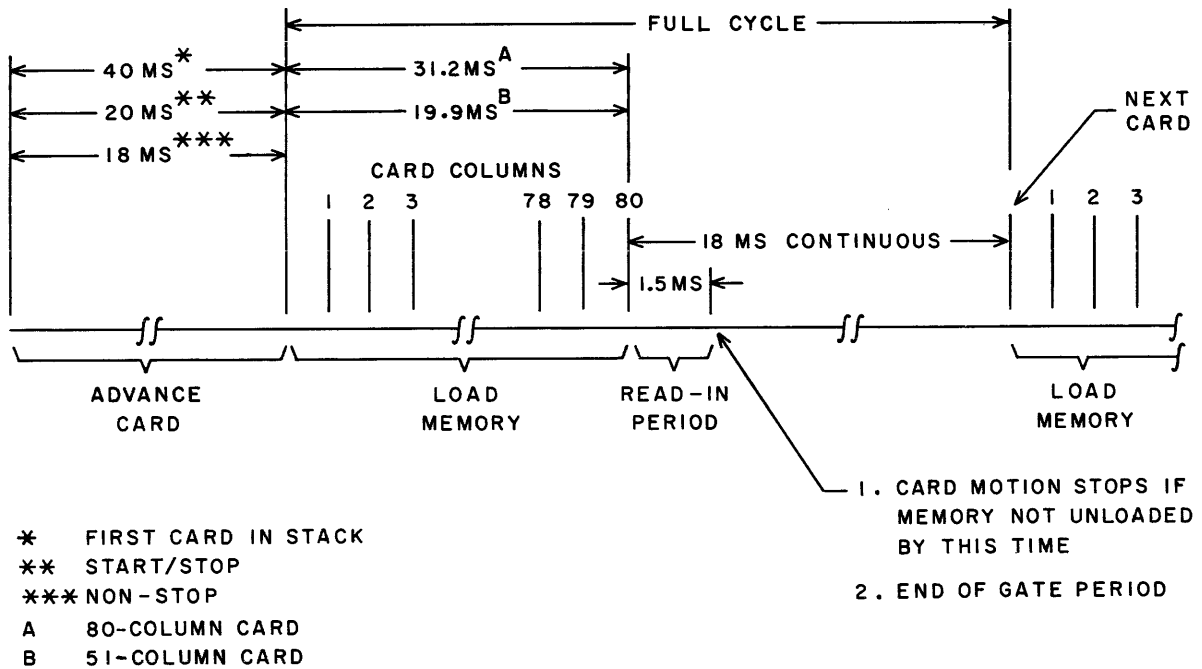

Figure C-2. Card Cycle Timing (3649 and 3447)

The two 3100 and 3200 Input to A instructions INAC (Input Character to A) and INAW (Input Word to A) have limited use for the 3447 and 3649 Controllers. These instructions transfer a single byte or character to the A register via a data channel and thus constitute a single-byte Read operation. The reader system loads a new card into memory each time a Read operation terminates. Therefore, the above instructions read only the first one or two columns on a card. A new card is entered into memory after one of these instructions is executed.

Card Cycle Timing for 3248

Figure C-3 shows timing for one card cycle. The diagram shows that after a card is read a period of 1.5 milliseconds is available in which the data channel can be used to service another device. Card motion stops, however, if the program does not initiate a new Input operation from the reader by the end of this period.

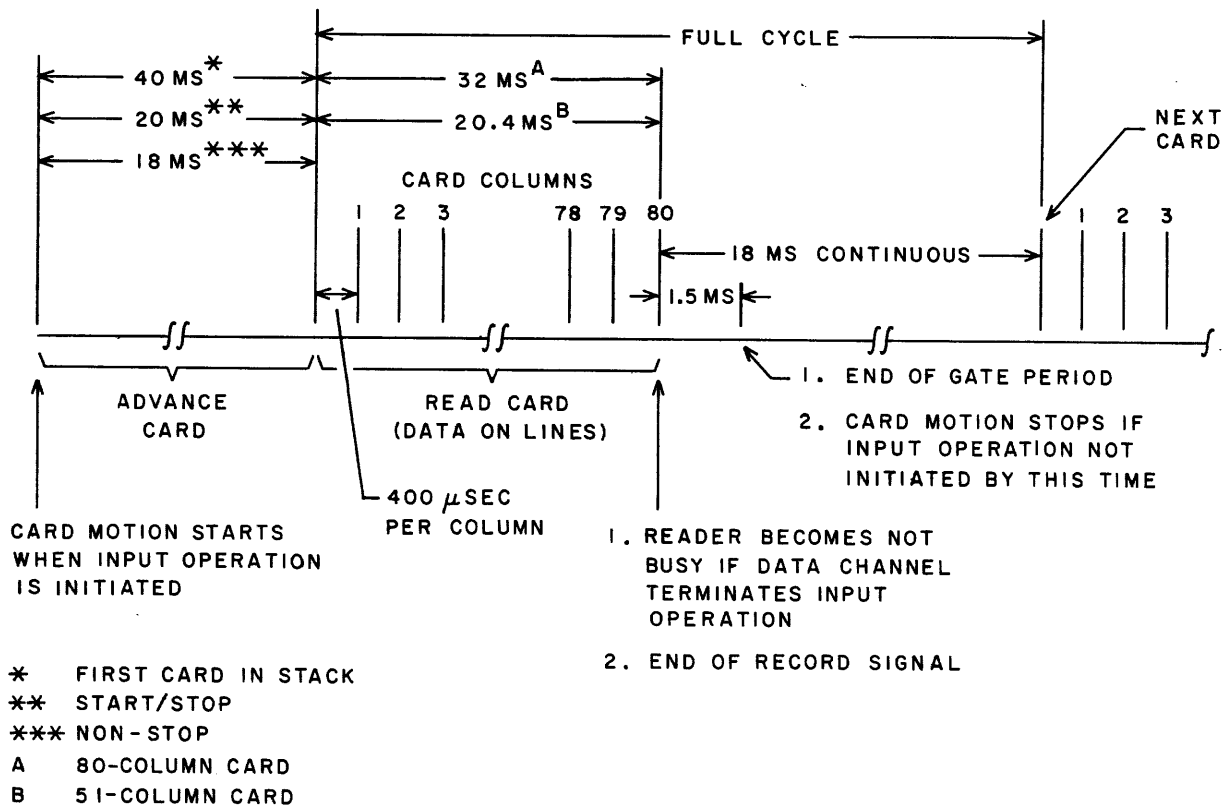

Figure C-3. Card Cycle Timing (3248)

The diagram also indicates when the reader system becomes Not Busy and when it sends an End of Record signal to the data channel.

The Input Word to A instruction (INAW)* transfers a single 12-byte from an external device to the A register. A series of these instructions can be used to read cards. The timing diagram shows the rate at which INAW instructions must be executed to read in each card column. If Hollerith cards are read, an input is required for each two card columns or every 800 microseconds. When binary cards are read, an input is required for each card column or every 400 microseconds.

The Input Character to A instruction (INAC)* transfers a single 6-bit byte from an external device to the A register. A series of these instructions can also be used to read cards. An input is required for each card column or every 400 microseconds. Only Hollerith cards may be used. (See Suppress Assembly Mode.)

MANUAL OPERATION

SWITCHES AND INDICATORS

Switches and Indicators on 405 Card Readers

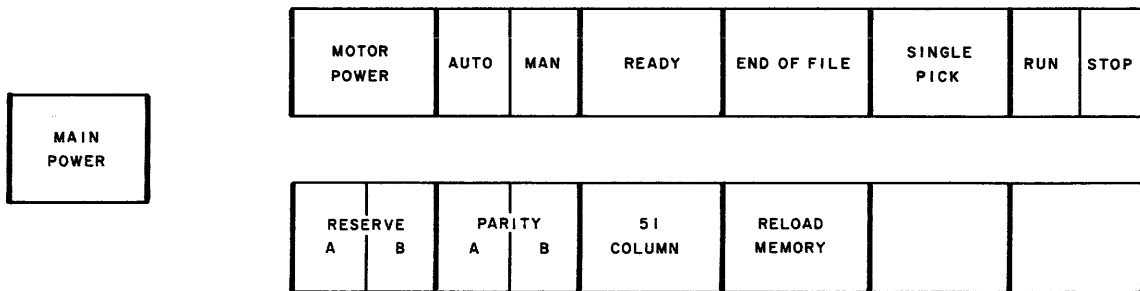

Figure C-4. Card Reader Switches and Indicators (Used With 3649 Controller)

* 3100/3200/3300 Systems only

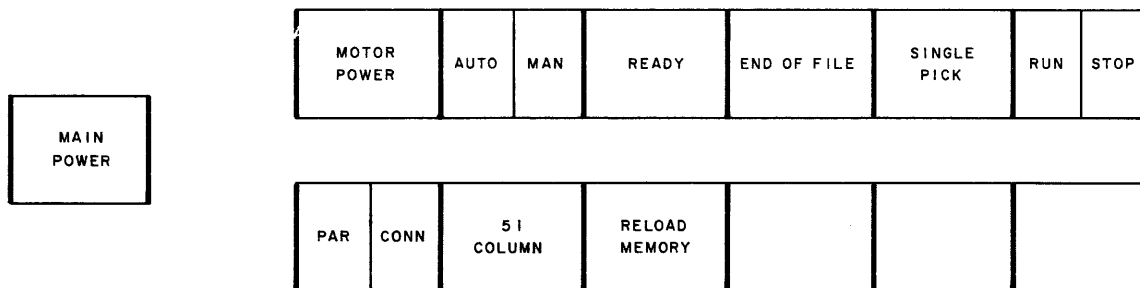

Figure C-5. Card Reader Switches and Indicators (Used With 3447 Controller)

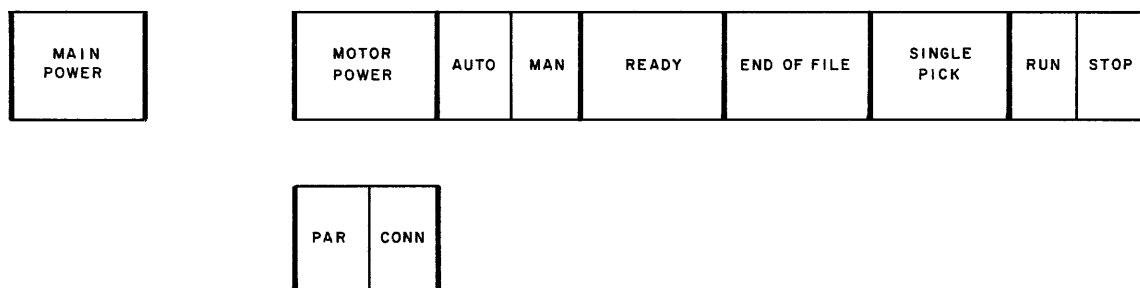

Figure C-6. Card Reader Switches and Indicators (Used With 3248 Controller)

MAIN POWER Switch/Indicator: MAIN POWER controls all primary power and turns on the photocell light source. It is lighted when power is on.

MOTOR POWER Switch/Indicator: The MOTOR POWER switch controls power to the drive motors, the vacuum-pressure system, and the hopper-stacker vibrators. It is lighted when power is on.

AUTO/MAN Switch/Indicator: This two-position switch selects manual - or program-controlled modes of operation. Changing switch position to MAN drops the ready status bit. The switch must be in the AUTO position when the reader system is used for computer input operations.

READY Switch/Indicator: The READY switch makes the reader READY if:

- 1) Input tray is not empty,
- 2) No error conditions exist in the unit, and
- 3) Primary and secondary stackers are not full.

The switch lights to indicate the Ready condition. When the switch is pressed the first card is read into buffer memory for the 3649 and 3447. Thereafter, the reader system is under program control.

END OF FILE Switch/Indicator: Pressing the END OF FILE switch enables the reader system to generate an end of file status bit after the last card in the input tray is read. It is lighted when selected.

SINGLE PICK Switch: The SINGLE PICK switch allows a single card to be cycled through the reader when the AUTO/MAN switch is in the MAN position. It does not light.

RUN/STOP Switch/Indicator: The RUN/STOP switch allows manual control of card feed when the AUTO/MAN switch is in the MAN position. The selected side is lighted.

RESERVE A/B Indicator (3649 only): The RESERVE A/B indicator lights if either of the associated data channels is reserving the read station. The side corresponding to the reserving channel is lighted.

PARITY A/B Indicator (3649 only): The PARITY A/B indicator indicates the channel on which a parity error occurred during the transmission of a Connect or Function code.

PAR/CONN Indicator (3447 and 3248 only): If the PAR side is lighted it indicates a transmission parity error has occurred in a Connect or Function code. If the CONN side is lighted, it indicates that the reader system is connected to the data channel.

51 COLUMN Switch/Indicator (3447 and 3649 only): Pressing the 51 COLUMN switch allows reading short (51-column) cards. It is lighted when set for 51-column card reading.

RELOAD MEMORY Switch (3447 and 3649 only): Pressing the RELOAD MEMORY switch feeds data from a new card into memory when the AUTO/MAN switch is in the AUTO position. It does not light.

Switches and Indicators on Controller

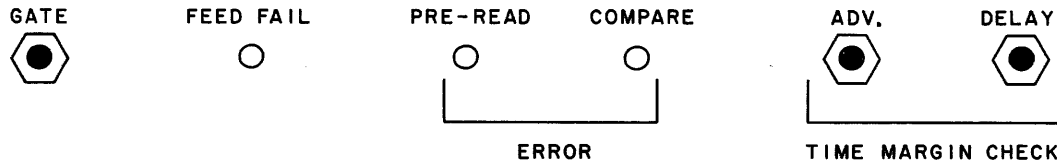

Figure C-7. 3447/3649 Controller Switches and Indicators

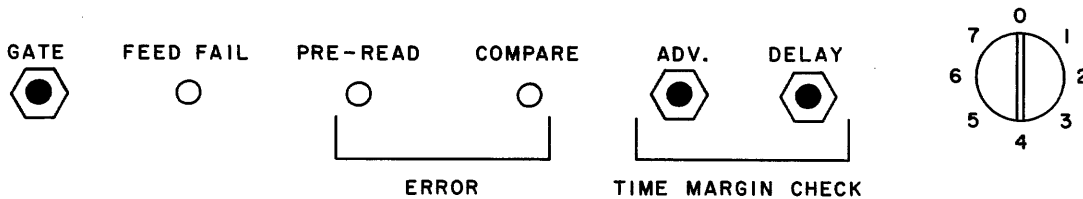

Figure C-8. 3248 Controller Switches and Indicators

Equipment Number Switch: This eight-position switch (0-7) determines the equipment number (corresponds to the upper 3 bits of Connect code) of the reader. It also determines on which one of the eight interrupt lines the interrupt signal is sent. This switch is located on the logic panel which is mounted on the back side of the 405 Card Reader cabinet for the 3447 and 3649. The 3649 Controller has two Equipment Number switches, one for each connect-reserve control.

GATE Switch: This switch is for use by maintenance personnel only.

FEED FAIL Indicator: This indicator indicates a feed failure.

PRE-READ ERROR Indicator: This indicator indicates an error in photocell logic. If the cards have not been mutilated, call maintenance personnel for a read circuitry check-out.

COMPARE ERROR Indicator: This indicator indicates the read and checkout stations each gave a different "hole" count. Reread the card.

TIME MARGIN CHECK Switches: These two switches are for use by maintenance personnel only.

OPERATING PROCEDURE

The following steps are necessary to prepare the reader system for use:

- 1) Turn Equipment Number switch to desired position,
- 2) Place cards in input tray (refer to Section Z for card load procedure),
- 3) Press MAIN POWER switch On,
- 4) Press MOTOR POWER switch On,
- 5) Press AUTO/MAN switch to AUTO,
- 6) Press END OF FILE switch Off unless the hopper load is a complete file,
- 7) Press READY switch, *
- 8) Issue Master Clear from the computer, and
- 9) The READY switch should be lighted, indicating the controller is now Ready.

CAUTION

Cards may not be removed from the secondary stacker while the card reader is operating. With care, cards may be added to the input tray or removed from the primary stacker during operation.

* For 3447 and 3649 one card feeds through reader to initially load buffer memory.

SECTION D

3142 CARD READER CONTROLLER

CONTENTS

Functional Description	D-1	Codes	D-5
System Relationship	D-1	Connect Code	D-6
Card Format	D-2	Function Codes	D-7
Read Operation	D-3	Status Codes	D-9
Suppress Assembly Mode	D-3	Programming Considerations	D-12
Parity Checking	D-3	Programming Procedure	D-12
Parity Error in a Connect Code	D-4	Timing	D-12
Parity Error in a Function Code	D-4	Manual Operation	D-12
Parity Errors in Input Data	D-4	Switches and Indicators	D-12
Interrupts	D-4	Switches and Indicators on NCR EM-D2(PE)	D-12
Programming	D-5	Switches and Indicators on 3142 Controller	D-14
		Operating Procedure	D-15

FIGURES

D-1	Typical Configuration	D-1	D-3	NCR EM-D2(PE) Card Reader	
D-2	Timing	D-12		Switches and Indicators	D-12
			D-4	3142 Controller Indicators	D-14

TABLES

D-1	System Specifications	D-1	D-2	Connect, Function and Status Codes	D-6
-----	-----------------------	-----	-----	------------------------------------	-----

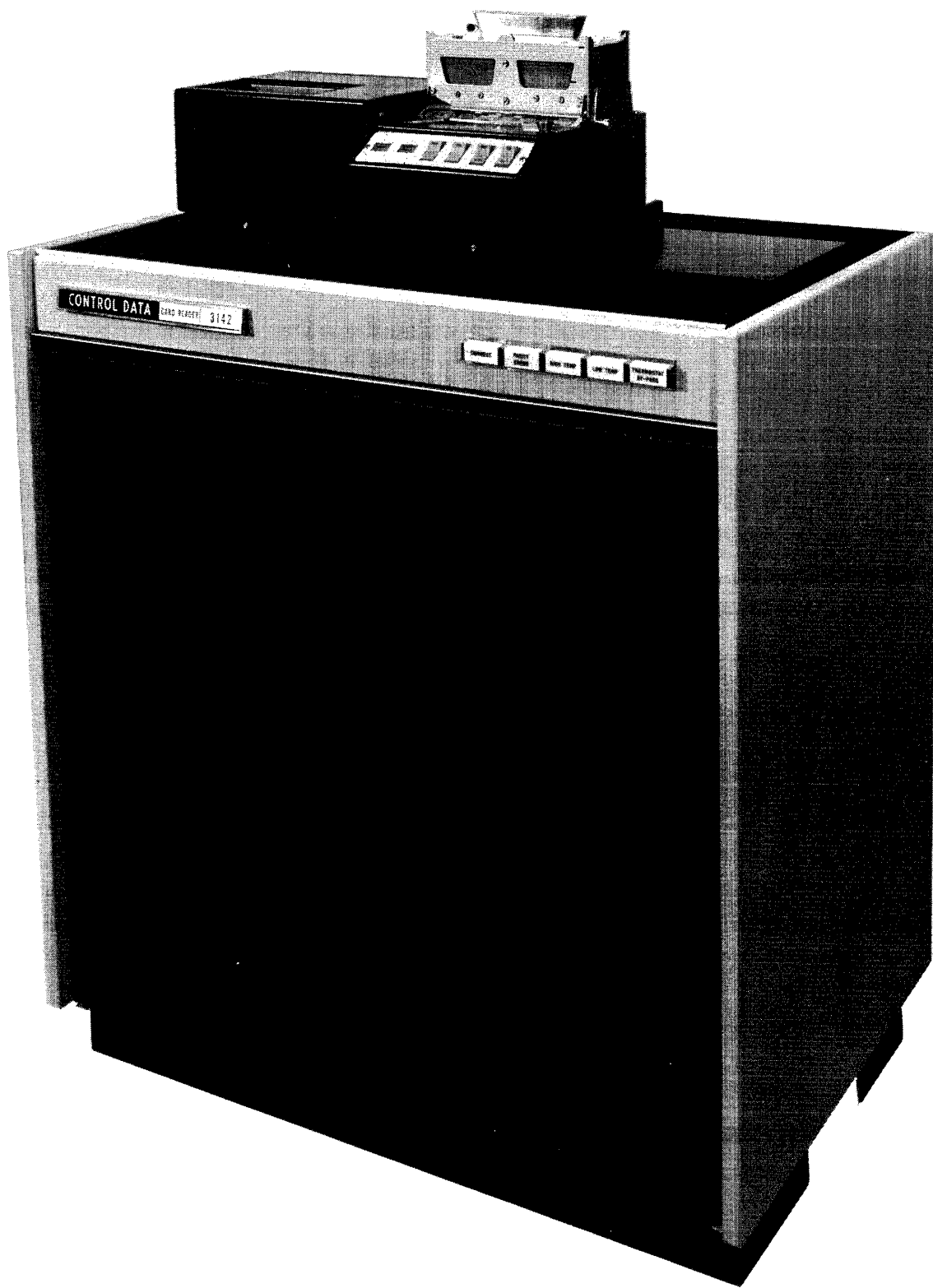

3142 CARD READER

3142 CARD READER CONTROLLER

This section describes a card reader system consisting of a CONTROL DATA* 3142 Card Reader Controller and a National Cash Register EM-D2 (PE) Punched Card Reader. It presents data formats, the function of the controller, programming information, and operating instructions. The 3142 system can be used with any standard 3000 Series Data channel.

Figure D-1 shows a typical system configuration and Table D-1 lists the system specifications.

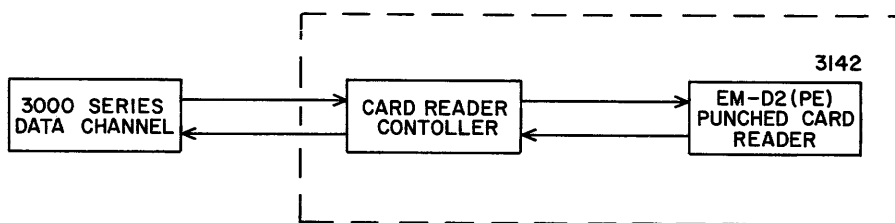

Figure D-1. Typical Configuration

TABLE D-1. SYSTEM SPECIFICATIONS

	NCR EM-D2 (PE) READER
Reading Rate	100 80-column cards per minute
Input Tray Capacity	400 cards
Receiving Tray Capacity	400 cards
Data Transfer Rate	600 milliseconds per card

FUNCTIONAL DESCRIPTION

SYSTEM RELATIONSHIP

The 3142 Controller performs the control and data conversion functions necessary to operate a National Cash Register EM-D2 (PE) Punched Card Reader under control of a 3000 Series Data Channel.

* Registered trademark of Control Data Corporation

CARD FORMAT

The National Cash Register EM-D2 (PE) Punched Card Reader handles 80 12-bit column cards. Section Z, Punched Card Format and Codes, describes the card.

The 3142 Controller treats data received from the reader as being in either Hollerith or binary format. Provided the card is not a binary card the controller will treat data received from the reader as being in Hollerith format following:

- 1) A manual Master Clear,
- 2) A Clear Channel instruction,
- 3) A Release and Disconnect Function Code, or
- 4) A Clear Function code.

Thus, the controller converts each 12-bit code received into one 6-bit BCD code. Then, unless in Suppress Assembly mode, the controller assembles two 6-bit BCD codes into one 12-bit word and transmits it to the data channel. The code received from an odd numbered column is placed in the upper 6-bit positions and that received from an even numbered column is placed in the lower 6-bit positions. Table Z-1, Section Z lists the Hollerith codes and corresponding BCD codes.

NOTE

The controller does not distinguish between legal (listed) Hollerith codes and illegal ones. It supplies a listed BCD code for each Hollerith code received. This BCD code, however, may not have meaning.

A card with punches in rows 7 and 9 of column one is a binary card. The controller treats the data on this card as binary data, that is, each 12-bit column is transmitted without translation directly to the data channel. The top row (row 12) is the upper bit in the byte; the bottom row (row 9) corresponds to bit 0.

A card with punches in rows 7 and 8 of column one is a File card. It may be used to indicate the last card in a deck and/or it may be used to send an Interrupt signal to the computer (see Interrupt on Abnormal End of Operation Function code).

The 3142 Controller also treats data received from the reader as being binary if it is issued a Negate Hollerith to BCD Conversion Function code. This code allows 7 and 8 punches in column one to be treated as binary data but does not allow them to be recognized as indicating a file card.

Regardless of which of the above actions is followed, the Interrupt signal remains up until cleared. This clearing may be accomplished by reselecting the interrupt, using the proper Release code (002X), issuing the Release and Disconnect code (0000), using the Clear Channel instruction, or a manual Master Clear. All except reselecting the interrupt will also clear the selection.

The Interrupt signal is transmitted on the equipment's interrupt line via the data channel connected to the equipment. The eight-position (0-7) Equipment Number switch determines the number of the line on which the Interrupt signal is transmitted. For example, if the Equipment Number switch is set at 5, all Interrupt signals coming from this controller are transmitted on interrupt line 5. Since each equipment attached to a data channel has a unique equipment number, each uses a different interrupt line. A Channel Product Register Jump instruction* or a Copy Status instruction** can identify the equipment sending the Interrupt signal by inspecting the interrupt lines.

All operations continue † unless appropriate programming steps have been taken to sense for the set bit and reread the data. In 3400/3600/3800 systems, the interrupt system may be set to generate an interrupt signal when this bit sets. If the interrupt system has not been set, the bit may be sensed to detect parity error conditions. In 3100/3200/3300 systems, the bit must be sensed if transmission parity error conditions are to be detected by the central processor. Refer to the appropriate system reference manuals for more information on the input/output parity error bit.

PROGRAMMING

CODES

All connections and operations are controlled by 12-bit Connect and Function codes in conjunction with an appropriate Connect or Function instruction. When the Connect or Function is executed, a Reply signal is returned to the computer. This signal allows the computer to read the next programmed instruction. If the Function cannot be executed, a Reject signal is returned to the computer. If the Connect or Function is not executed within 100 usec, the channel generates an Internal Reject. Either Reject signal instructs the computer to read the next instruction at the reject address specified by the instruction currently being executed.

* 3600/3800 systems

** 3100/3200/3300/3400 systems

† The validity of the data received from this point until the indicators are cleared is questionable.

Table D-2 lists all codes applicable to the 3142 Controller. In the detailed descriptions which follow, bit 0 is always the rightmost position.

TABLE D-2. CONNECT, FUNCTION, AND STATUS CODES

CONNECT	
Connect Reader	N000*
FUNCTION	
Release and Disconnect	0000
Negate Hollerith to Internal BCD Conversion	0001
Release Negate Hollerith to Internal BCD Conversion	0002
Clear	0005
Select Interrupt on Ready and Not Busy	0020
Release Interrupt on Ready and Not Busy	0021
Select Interrupt on End of Operation	0022
Release Interrupt on End of Operation	0023
Select Interrupt on Abnormal End of Operation	0024
Release Interrupt on Abnormal End of Operation	0025
STATUS	
Ready	XXX1
Busy	XXX2
Binary Card	XXX4
File Card	XX1X
Read Station Empty	XX2X
Reader Power Off	XX4X
Manual	X1XX
Interrupt on Ready and Not Busy	X2XX
Interrupt on End of Operation	X4XX
Interrupt on Abnormal End of Operation	1XXX

Connect Code

The 3142 Card Reader system must be connected before it can respond to a Function instruction. The connection is accomplished by the Connect instruction.

* N = equipment number of controller

Connect Reader (N000)

This code is the lower 12 bits of the Connect instruction. The N portion of the code specifies the controller's equipment number.

Each controller examines every Connect code received from its attached data channel. A Reply signal is returned to the data channel from a controller if:

- 1) A transmission parity error is not detected, and
- 2) The N portion of the Connect code matches the setting of an Equipment Number switch.

The controller does not connect and neither a Reply nor a Reject signal is returned to the data channel from the controller if:

- 1) A parity error is detected in the Connect code, or
- 2) The N portion of the code does not match the equipment setting of the controller.

In either case, if already connected, the controller disconnects. If no other equipment returns a Reply signal the computer generates an Internal Reject after 100 microseconds. This reject acts the same as one from a peripheral equipment.

Function Codes

Function codes set up or clear various operating conditions in the reader system. Table D-2 lists all the Function codes applicable to the 3142 Controller. All codes not listed are do-nothing codes. The controller returns a Reply in response to such codes, but no action follows.

A function code is the lower 12 bits of a Function instruction. When the central processor executes a Function instruction, the selected data channel sends the function code to all attached devices, but only the connected device responds.

The reader system accepts a function code and returns a Reply only when Not Busy. If the system is Busy when a code arrives, it returns a Reject signal to the data channel. If for any reason the controller fails to return either a Reply or Reject the computer generates an Internal Reject after 100 microseconds.

Release and Disconnect (0000)

The Release and Disconnect code clears the existing connection, all existing function

selections and status indications.

Negate Hollerith to Internal BCD Conversion (0001)

The Negate Hollerith to Internal BCD Conversion code causes the controller to process the data received from the reader in Binary mode.

Release Negate Hollerith to Internal BCD Conversion (0002)

The Release Negate Hollerith to Internal BCD Conversion code restores the normal Hollerith to Internal BCD Conversion mode.

Clear (0005)

The Clear code clears interrupt selections and an existing Interrupt signal. It restores the controller to Hollerith from Internal BCD Conversion mode.

Select Interrupt on Ready and Not Busy (0020)

This code causes the controller to send an Interrupt signal to the processor when the reader becomes Ready and Not Busy, that is, the following conditions exist:

- 1) Cards are in the input tray,
- 2) The hopper weight is in place,
- 3) Power is applied,
- 4) The READY indicator is lighted,
- 5) A Read is not in progress, and
- 6) The leading edge of a card has just entered the read station after the channel has become Not Busy.

Release Interrupt on Ready and Not Busy (0021)

This code clears an Interrupt on Ready and Not Busy selection and the Interrupt signal if it is up.

Select Interrupt on End of Operation (0022)

This code causes the controller to send an Interrupt signal to the processor when the Input operation is complete or when the controller becomes Not Ready under either nor-

mal or abnormal conditions.

Release Interrupt on End of Operation (0023)

This code clears an Interrupt on End of Operation selection. It also clears the Interrupt signal when caused by an end of operation.

Select Interrupt on Abnormal End of Operation (0024)

This code conditions the reader system to send an Interrupt signal when one of the following conditions occurs:

- 1) Reader power off,
- 2) Read station empty,
- 3) Illegal Suppress Assembly (6-bit input) operation, or
- 4) A file card (punches in rows 7 and 8 of column 1) is read.

Any of the first three conditions disables the device. The condition must be corrected before Read operations can resume. The Interrupt signal remains on the line until cleared by reselection of the interrupt (code 0024), release of the interrupt (code 0025), Clear (code 0005), Master Clear, or Clear Channel instruction.

Any of the first three conditions causes the reader system to become Not Ready. Thus, Interrupt on End of Operation may occur along with Interrupt on Abnormal End of Operation.

Release Interrupt on Abnormal End of Operation (0025)

This code clears interrupt on Abnormal End of Operation selection. It also clears the Interrupt signal when caused by an abnormal condition.

Status Codes

Various operating conditions of the reader system are indicated by signals on 10 of the status lines (the upper two are not used). Each line is 1 bit of a 12-bit binary quantity. The information is available to the channel during the entire time the reader is connected. If two or more conditions exist simultaneously, the Status Response code is the sum of the individual codes. This information can be sensed by means of the Copy Status and Sense Status instructions whenever the reader system is connected. Table D-2 lists the

status conditions.

Three of the status lines indicate the three conditions that can cause the controller to send the Interrupt signal. Thus, the status feature can be used to identify the condition causing an interrupt.

Ready (XXX1)—Bit 0

The reader system becomes Ready when it is prepared to read cards under program control. That is, the input tray contains cards, the hopper weight is in place, reader power is on, and a card is properly registered. Any of the following conditions causes the reader to become Not Ready (status bit becomes "0").

- 1) Read station empty,
- 2) Illegal Suppress Assembly (6-bit input) operation, or
- 3) Reader power off.

These conditions also cause Interrupt on End of Operation and Interrupt on Abnormal End of Operation if selected.

Busy (XXX2)—Bit 1

The reader system is Busy whenever the channel is Busy, the controller is connected, and an abnormal condition does not exist. The system becomes Not Busy when one or more of the following conditions exist:

- 1) No card flow and the channel becomes Not Busy,
- 2) The leading edge of a card enters the read station after the channel has become Not Busy, i. e. , even if the channel becomes Not Busy before a card has been read, the system remains Busy until the leading edge of the following card enters the read station, or
- 3) The system is not ready.

Binary Card (XXX4)—Bit 2

The presence of punches in rows 7 and 9 in column 1 flags a binary card. The status bit becomes "1" when column 1 is read and remains up until the first column of a not binary card is read.

File Card (XX1X)—Bit 3

This condition exists when the controller is in normal operating mode (Negate Hollerith to BCD not selected) and a Hollerith card containing punches in rows 7 and 8 of column 1 is detected.

The file card status bit is cleared by Clear (0005), Release and Disconnect (0000), a Master Clear, or the leading edge of the next card. The controller also generates an Abnormal End of Operation interrupt after detecting a file card if this interrupt condition has been selected.

Read Station Empty (XX2X)—Bit 4

This bit indicates that there is no card in the read station. This may be due to an empty hopper, a feed failure, or an operator error.

Reader Power Off (XX4X)—Bit 5

This bit indicates that reader power is off.

Manual (X1XX)—Bit 6

This bit indicates that the reader is under manual control.

Interrupt on Ready and Not Busy (X2XX)—Bit 7

Bit 7 is set if Interrupt on Ready and Not Busy is selected and the system becomes Ready and Not Busy. This bit will not set until a Reply has been sent after selecting Interrupt on Ready and Not Busy. This status bit is cleared when the Interrupt signal is cleared.

Interrupt on End of Operation (X4XX)—Bit 8

Bit 8 is set if Interrupt on End of Operation is selected and an operation ends either normally or abnormally. It is cleared when the Interrupt signal is cleared.

Interrupt on Abnormal End of Operation (1XXX)—Bit 9

Bit 9 is set if Interrupt on Abnormal End of Operation is selected and an operation ends

abnormally. It is cleared when the Interrupt signal is cleared.

PROGRAMMING CONSIDERATIONS

Programming Procedure

A typical order of steps in programming the reader system is:

- 1) Clear (by external Master Clear or Clear Channel instruction),
- 2) Connect,
- 3) Function (select interrupts and operating mode),
- 4) Initiate Read operation, and
- 5) Copy Status when End of Operation interrupt occurs to determine reason for end of operation.

Timing

Figure D-2 shows a breakdown of the time required to process a card.

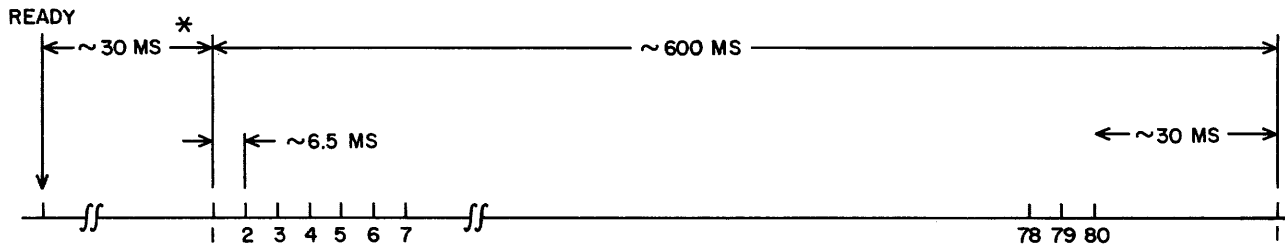

Figure D-2. Timing

MANUAL OPERATION

SWITCHES AND INDICATORS

Switches and Indicators on NCR EM-D2 (PE)

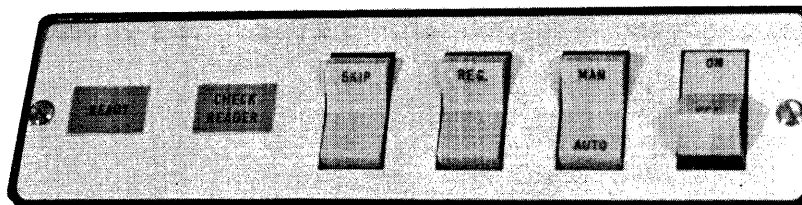

Figure D-3. NCR EM-D2 (PE) Card Reader Switches and Indicators

* Added for first card in a stack and for each card under "Start/Stop" operation.

READY Indicator:

The READY indicator is lighted when the reader is Ready (i. e. , a card is registered, the hopper weight is in place, and power is On).

CHECK READER Indicator:

The CHECK READER indicator is lighted when one of the following conditions occur: no card is in the read station, the reader is in Manual mode, or the hopper weight is not in place. The Reader may be Ready while in Manual mode but will become Not Ready after the registered card is read.

SKIP Switch:

The SKIP switch advances a card in the read station to the output tray. If the reader is in Auto mode, it advances a card from the input tray to the read station.

REG (REGISTER) Switch:

The REGISTER switch advances a card from the input tray to the read station if in Auto mode and enables the insertion of a single card by placing it on the read table if in Manual mode.

AUTO/MAN Switch:

The two-position AUTO/MAN switch selects Reader mode. In Auto mode the reader advances and reads cards in response to a Read (Input) instruction from the computer. In Manual mode the reader will not advance cards from the input tray. This enables the insertion of a single card by placing it on the read table and pressing the REGISTER switch.

ON/OFF Switch:

The ON/OFF switch controls power to the reader only.

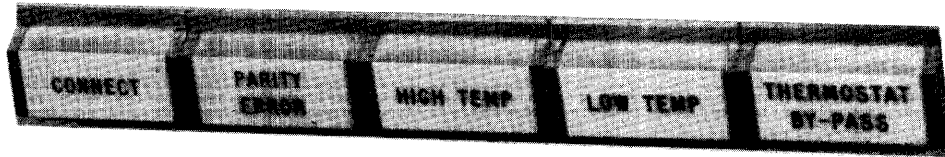

2004

Figure D-4. 3142 Controller Indicators

Equipment Number Switch:

An eight-position Equipment Number switch is located on the controller logic chassis. The setting of this switch (0-7) designates the controller and corresponds to the N portion of the Connect code. It also determines the number of the interrupt transmission line used by this equipment.

CONNECT Indicator:

This indicator is lighted when the controller is connected to the data channel as a result of a Connect instruction. It is located on the cabinet front.

PARITY ERROR Indicator:

This indicator is lighted when the controller detects a parity error in a Connect code, a Function code, or in data received from the data channel. It is turned Off by a manual Master Clear or a Channel Clear instruction. It is located on the cabinet front.

HIGH TEMP Indicator:

This indicator is lighted if the temperature of the air emerging from the top of the controller cabinet exceeds 110°. The supply of power to the equipment is cut off except to the fan and the indicator light.

LOW TEMP Indicator:

This indicator is lighted if the temperature of the air entering the bottom of the controller cabinet exceeds 80°.

THERMOSTAT BYPASS Indicator:

This indicator is lighted when the automatic temperature protect system has been disabled by operating the switch inside the cabinet. In this state there is no HIGH TEMP Indicator, automatic power drop, or thermal protection.

CAUTION

The 3142 should be operated in this state only long enough to finish the immediate operation and with full realization of the above effects.

OPERATING PROCEDURE

For directions on loading the NCR EM-D2 (PE) Card Reader, see Section Z, National Cash Register EM-D2 (PE) Punched Card Reader Loading Procedures.

The following steps are necessary to prepare the reader system for use:

- 1) Turn Equipment Number switch to desired position,
- 2) Place card(s) in input tray (steps 1-4, NCR Card Reader Loading Procedure)
- 3) Press MAIN POWER switch On,
- 4) Press card reader ON/OFF switch to On position,
- 5) Press AUTO/MAN switch to auto position, and
- 6) Press REG (REGISTER) switch to transport one card.

SECTION Z

**SUPPLEMENTARY INFORMATION
CARD EQUIPMENT**

CONTENTS

Punched Card Format and Codes	Z-1	National Cash Register EM-D2(PE) Punched Card Reader	Z-6
405 Card Reader Loading Procedures	Z-3		
3142 Card Handling and Loading Information	Z-5	415 Card Punch Switches and Indicators	Z-9
Card Care	Z-5	523 Card Punch Switches and Indicators	Z-10

FIGURES

Z-1 Punched Card Format	Z-3	Z-5 Transferring Aligned Deck to Reader Hopper	Z-7
Z-2 Card Trays Set for 80-Column Cards	Z-4	Z-6 Removal of Card from Read Station	Z-8
Z-3 Card Trays Set for 51-Column Cards	Z-4	Z-7 415 Punch Switches and Indicators	Z-9
Z-4 3142 Card Reader	Z-6	Z-8 523 Punch Switches and Indicators	Z-10

TABLES

Z-1 BCD/Hollerith Card Codes	Z-2
------------------------------	-----

SUPPLEMENTARY INFORMATION CARD EQUIPMENT

This section contains information common to several of the card handling equipments.

This includes:

- 1) BCD/Hollerith codes.
- 2) Card format.
- 3) CONTROL DATA* 405 Card Reader loading procedure.
- 4) CONTROL DATA 3142 Card Reader card handling and loading information.
- 5) CONTROL DATA 415 Punch switches and indicators.
- 6) IBM 523 Punch switches and indicators.

PUNCHED CARD FORMAT AND CODES

A punched card contains either 51 or 80 12-bit columns arranged as in Figure Z-1. A punch in any bit position is a logical "1". Cards may be either Hollerith or binary format. In Hollerith format, each column contains a combination of punches that specifies one alphanumeric character. (Table Z-1 lists the Hollerith codes.) In binary format, each card column is a 12-bit binary quantity.

* Registered trademark of Control Data Corporation

TABLE Z-1. BCD/HOLLERITH CARD CODES

Internal BCD Code	Char	Hollerith Code	Internal BCD Code	Char	Hollerith Code
00	0	0	40	(minus) -	11
01	1	1	41	J	11, 1
02	2	2	42	K	11, 2
03	3	3	43	L	11, 3
04	4	4	44	M	11, 4
05	5	5	45	N	11, 5
06	6	6	46	O	11, 6
07	7	7	47	P	11, 7
10	8	8	50	Q	11, 8
11	9	9	51	R	11, 9
12		8, 2	52	-0	11, 0
13	=	8, 3	53	\$	11, 8, 3
14	(dash) -	8, 4	54	*	11, 8, 4
15		8, 5	55		11, 8, 5
16		8, 6	56		11, 8, 6
17		8, 7	57		11, 8, 7
20	+	12	60	(Space)	Blank
21	A	12, 1	61	/	0, 1
22	B	12, 2	62	S	0, 2
23	C	12, 3	63	T	0, 3
24	D	12, 4	64	U	0, 4
25	E	12, 5	65	V	0, 5
26	F	12, 6	66	W	0, 6
27	G	12, 7	67	X	0, 7
30	H	12, 8	70	Y	0, 8
31	I	12, 9	71	Z	0, 9
32	+0	12, 0	72		0, 8, 2
33	.	12, 8, 3	73	,	0, 8, 3
34)	12, 8, 4	74	(0, 8, 4
35		12, 8, 5	75		0, 8, 5
36		12, 8, 6	76		0, 8, 6
37		12, 8, 7	77		0, 8, 7

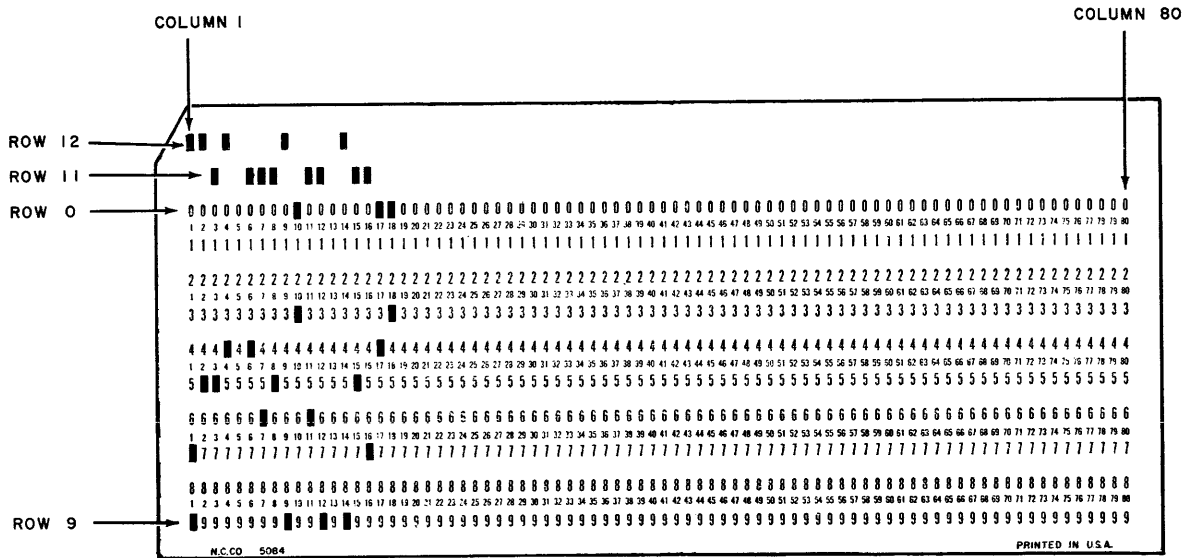

Figure Z-1. Punched Card Format

405 CARD READER LOADING PROCEDURES

- 1) Set guide edge of supply tray and receiving tray for length of card being used. Narrow half of each tray may be removed, turned end-for-end and reassembled as necessary.
- 2) Load cards into supply tray, placing column 1 at right as cards face entrance of read station.
- 3) Check input wall of secondary and main receiving trays if 80-column (long) cards are used. Hinged card-stopping blocks should be positioned so that a flush surface is formed at each input wall (Figure Z-2). The hinged block assemblies must be pivoted to protrude from the wall surfaces of each receiving tray if 51-column (short) cards are to be used (Figure Z-3).
- 4) At input tray, set card-stopping pin to protrude from the face plate if short cards are to be used; turn pin clockwise to form flush wall if long cards are being used (Figures Z-2 and Z-3).
- 5) Place equipment in manual mode of operation by pressing AUTO/MAN switch (MAN indicator on).

- 6) STOP indicator (controller panel) should be on; if not, press RUN/STOP switch (controller panel).
- 7) Press MOTOR POWER switch (controller panel); indicator should light.
- 8) Press READY switch (controller panel).
- 9) Press SINGLE PICK switch (operator panel) to initiate transport of single card from supply tray to receiving tray. If difficulty is experienced in performing this operation (failure to pick single card), check input throat for possible obstruction.
- 10) Remove card from receiving tray or secondary bin and replace in supply tray.
- 11) Press AUTO/MAN switch to return unit to Auto mode.

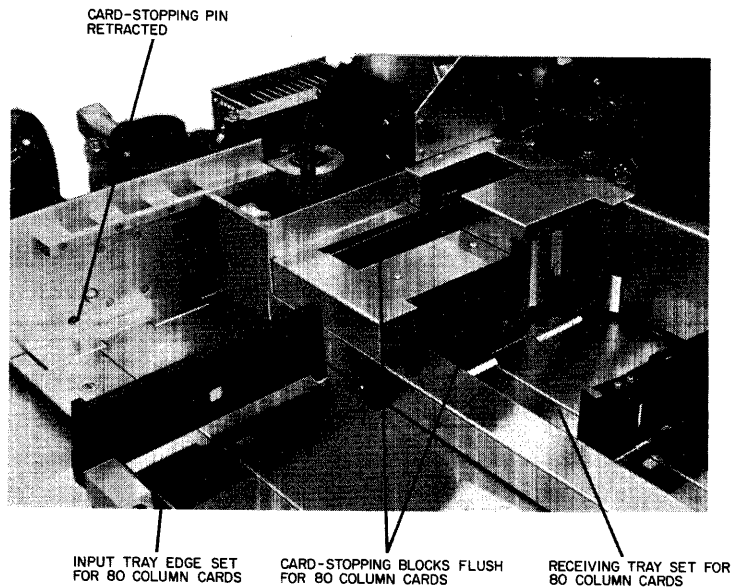

Figure Z-2. Card Trays Set for 80-Column Cards

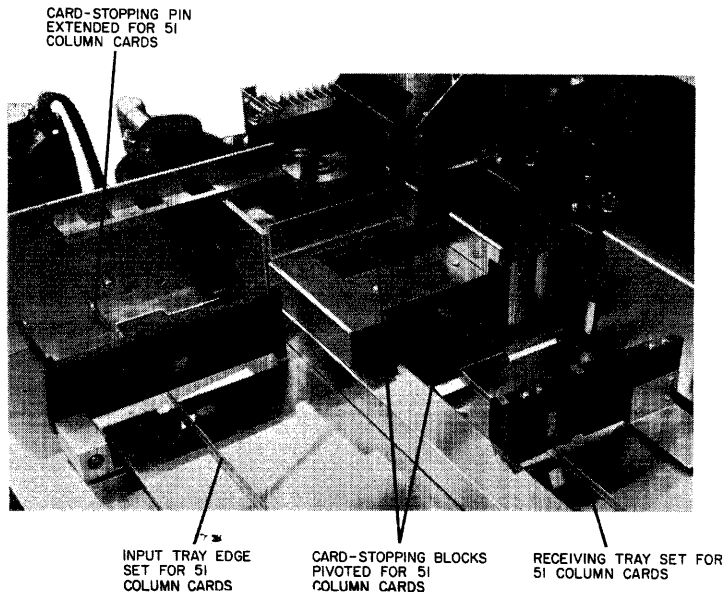

Figure Z-3. Card Trays Set for 51-Column Cards

3142 CARD HANDLING AND LOADING INFORMATION

To obtain maximum efficiency from the 3142 Card Reader, care in card handling and loading is necessary. The user who familiarizes himself with the following instructions before operating the 3142 is far less likely to damage the reader or to encounter reading difficulties.

CARD CARE

No extraordinary care is required of card decks to be run through the 3142. However, of course, best machine feeding results from perfectly flat cards. If the cards exhibit slight distortion, the operator can generally eliminate the distortion by gently binding the cards back and forth a few times.

More severe distortion is usually caused by incorrect storage procedures. Cards should be stored so they cannot bind or buckle - either firmly packed into a box or a drawer with an adjustable divider. Occasionally it may be necessary to control storage area humidity in order to prevent permanent warping of cards.

Mechanical damage to cards also causes feeding problems. Any practice which damages the edge, surface, or contour of the card should be avoided. Use of paper clips, staples, rubber bands, etc., mars the card and may cause machine feeding difficulties.

NATIONAL CASH REGISTER EM-D2 (PE) PUNCHED CARD READER

Use Figure Z-4 to locate the parts of the 3142 card reader that are referred to on the following pages.

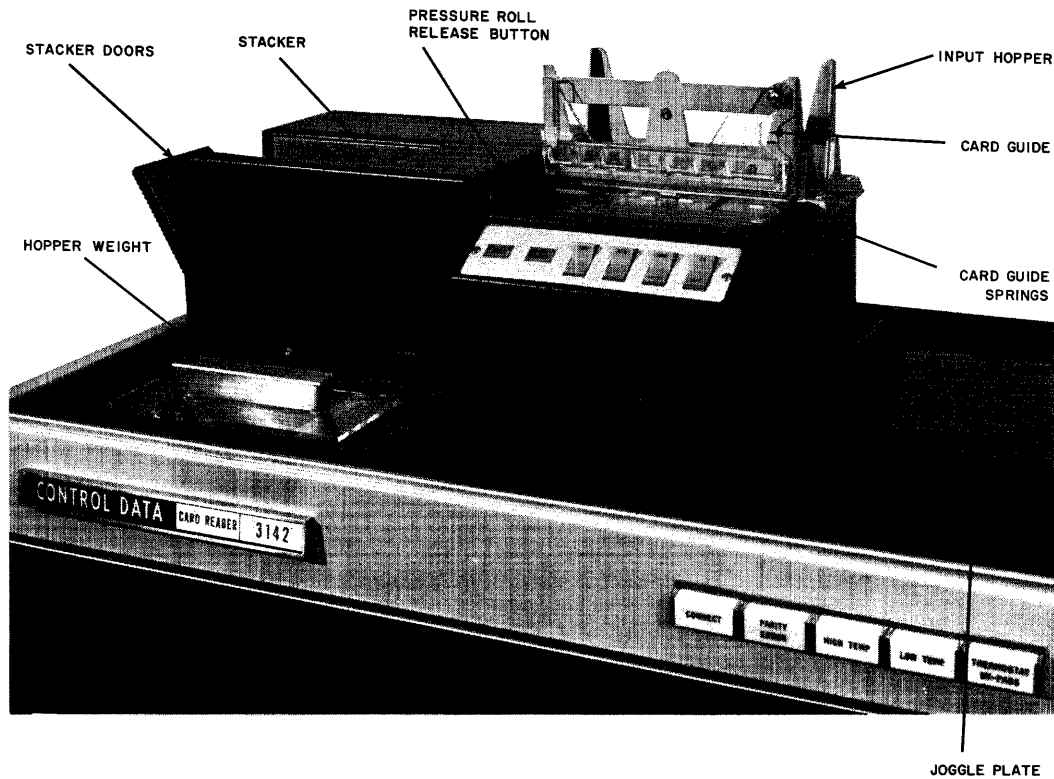
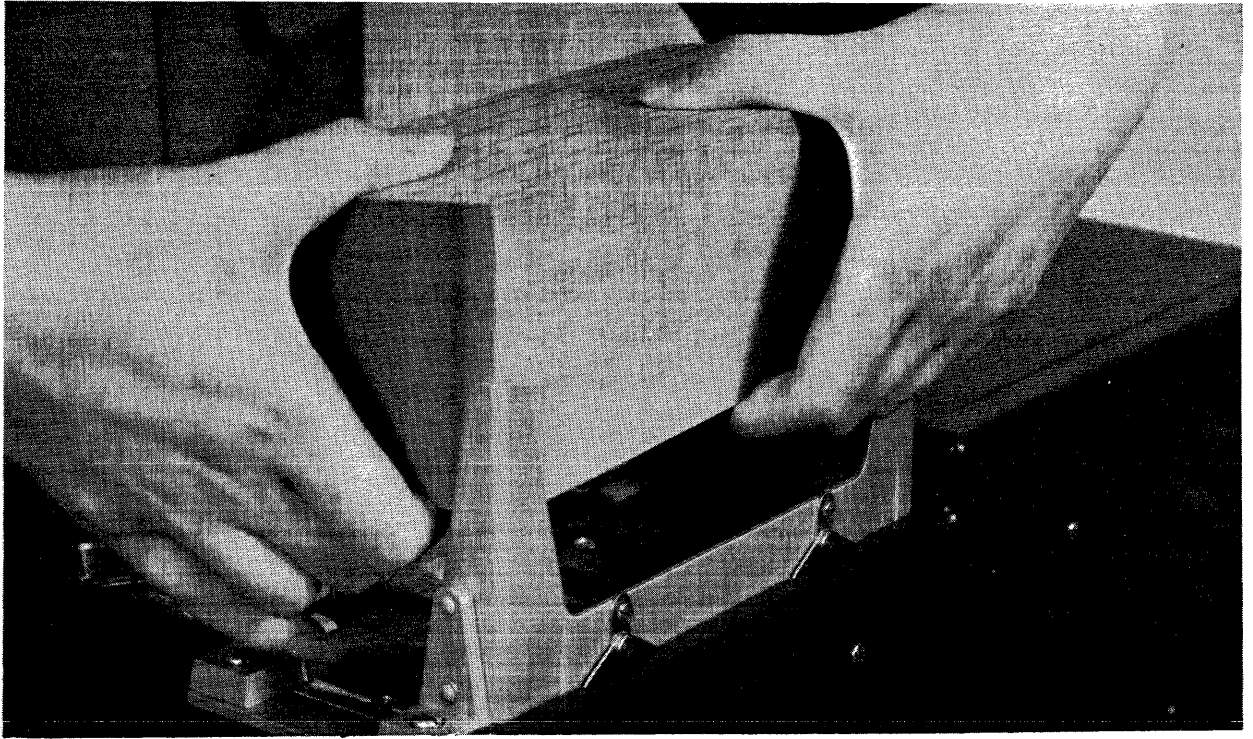

Figure Z-4. 3142 Card Reader

Reader Loading

- 1) Align the cards on the joggle plate by gentle tapping. If the card edges do not align easily, do not damage the edges by banging the deck against the plate. Instead, lightly fan the deck and try again.
- 2) Using both hands as shown in Figure Z-5, transfer the squared deck to the reader hopper without destroying the alignment. The proper card position is face down with the nine edge (bottom) toward the rear of the reader.



2001

Figure Z-5. Transferring Aligned Deck to Reader Hopper

- 3) Replace the hopper weight.
- 4) Check that the plastic card guide on the reader table is down.
- 5) Depress the REG key once.

Jam Removal

To remove a card caught in the hopper throat area:

- 1) Protect fingers by turning reader power off or depressing the MAN switch. Either operation prevents feed knife motion.
- 2) Pull the card gently toward the front of the machine. This prevents bending the card guide springs.

CAUTION

Some models of the reader have four fragile card guide springs in the hopper throat area. These are shown in Figure Z-4. Care must be exercised to prevent damage to these springs.

To remove a card caught in the read station actuate the pressure roll release button as shown in Figure Z-6.

PRESSURE ROLL RELEASE BUTTON

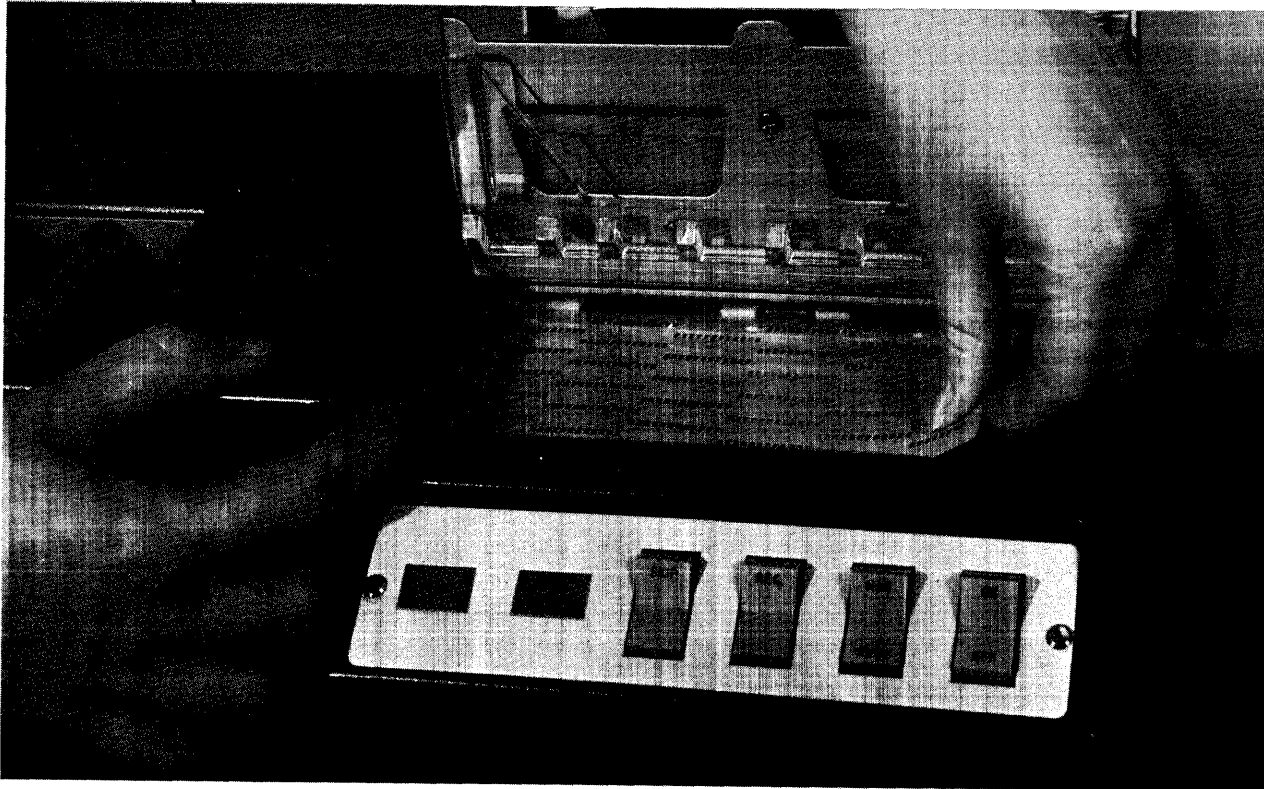

2003

Figure Z-6. Removal of Card from Read Station

Reader Unloading

- 1) Open the stacker door at the left end of the card reader, and
- 2) Pull the deck out through the door.

415 CARD PUNCH SWITCHES AND INDICATORS

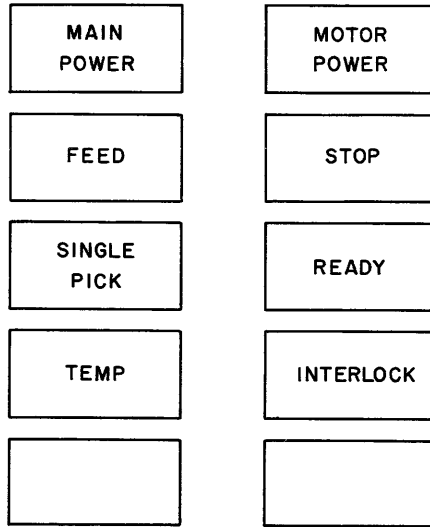

Figure Z-7. 415 Punch Switches and Indicators

MAIN POWER SWITCH

This switch applies power to the cooling fans and the power supplies. It is lighted when power is on.

MOTOR POWER SWITCH

This switch applies power to the punch motor. It is lighted when power is on.

FEED INDICATOR

This indicator is lighted when a card jam exists.

STOP SWITCH

This switch causes the punch to become Not Ready. It is lighted when the punch is in a Not Ready condition.

SINGLE PICK SWITCH

This switch advances cards one cycle. It is lighted until the advance has been completed.

READY SWITCH

This switch clears punch logic and puts the punch in Automatic mode. It is lighted when punch is in Ready condition.

TEMPERATURE INDICATOR

This indicator is lighted whenever the card punch temperature exceeds 100° F.

INTERLOCK INDICATOR

This indicator is lighted when the head panel, hood panel, or right door is open.

523 CARD PUNCH SWITCHES AND INDICATORS

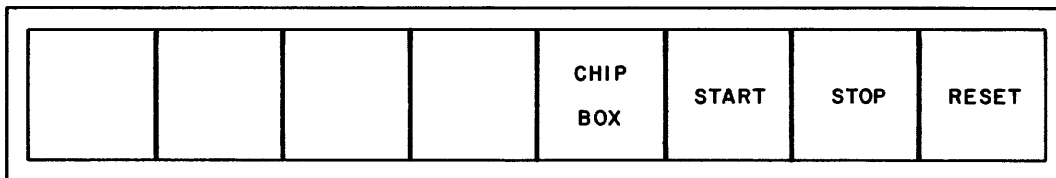

Figure Z-8. 523 Punch Switches and Indicators

OFF/ON SWITCH

This switch applies power to the punch. It is located on the end panel on the right.

START SWITCH

This momentary-contact switch causes the cards to advance one cycle. From an initial load, pressing this switch twice advances cards into all stations. At the end of the operation, pressing switch twice unloads punched cards.

STOP SWITCH

This switch causes the punch to become Not Ready.

RESET SWITCH

This switch causes the punch to become Ready following a reload or unload. It does not advance the cards.

CHIP BOX INDICATOR

This indicator is lighted whenever the chip box is full.

COMMENT SHEET

MANUAL TITLE CONTROL DATA 3000 SERIES PERIPHERAL EQUIPMENT
Reference Manual, Volume 1

PUBLICATION NO. 60108800 REVISION _____

FROM: NAME: _____
BUSINESS
ADDRESS: _____

COMMENTS:

This form is not intended to be used as an order blank. Your evaluation of this manual will be welcomed by Control Data Corporation. Any errors, suggested additions or deletions, or general comments may be made below. Please include page number references and fill in publication revision level as shown by the last entry on the Record of Revision page at the front of the manual. Customer engineers are urged to use the TAR.

CUT ALONG LINE

FORM CA231 REV. 1-67

NO POSTAGE STAMP NECESSARY IF MAILED IN U. S. A.
FOLD ON DOTTED LINES AND STAPLE

STAPLE

STAPLE

FOLD

FOLD

FIRST CLASS
PERMIT NO. 8241
MINNEAPOLIS, MINN.

BUSINESS REPLY MAIL
NO POSTAGE STAMP NECESSARY IF MAILED IN U.S.A.

POSTAGE WILL BE PAID BY
CONTROL DATA CORPORATION
8100 34TH AVENUE SOUTH
MINNEAPOLIS, MINNESOTA 55440

ATTN: TECHNICAL PUBLICATIONS DEPT.
PLANT TWO

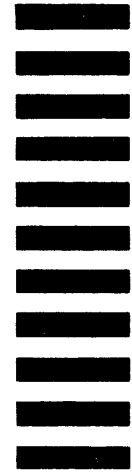

CUT ALONG LINE

FOLD

FOLD



CORPORATE HEADQUARTERS, 8100 34th AVE. SO., MINNEAPOLIS, MINN. 55440
SALES OFFICES AND SERVICE CENTERS IN MAJOR CITIES THROUGHOUT THE WORLD

LITHO IN U.S.A.