

Avatar.

*MacMainFrame™ Series  
Macintosh-to-Mainframe Link*

*Coax Workstation  
Installation Guide*

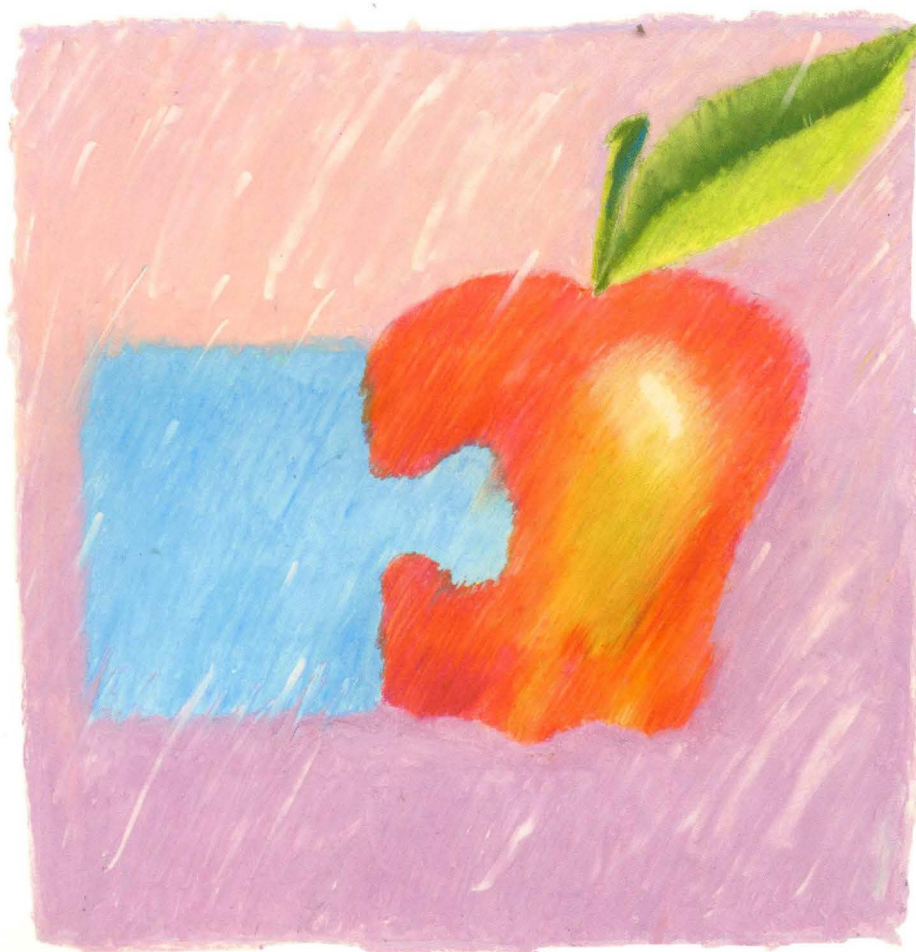

# *MacMainFrame™ Series*

---

*Macintosh to Mainframe Link*

**Coax  
Workstation**

**Installation Guide**

**Avatar.**

65-2500-101

**Copyright © 1990**

Avatar Corporation  
65 South Street  
Hopkinton, MA 01748  
(508) 435-3000

**All Rights Reserved**

The information contained herein is the property of Avatar Corporation. It shall not be reproduced, disclosed, or used in whole or in part without written permission of Avatar Corporation.

MacMainFrame and EasyKeys are trademarks of Avatar Corporation.

Fiber Optic System is a trademark of Du Pont Electronics.

IBM PC, CICS, TSO, CMS, and IND\$FILE are trademarks of International Business Machines Corporation.

MacLinkPlus is a trademark of Dataviz Corporation.

Microsoft is a registered trademark, and Excel is a trademark of Microsoft Corporation.

PageMaker is a registered trademark of Aldus Corporation.

PhoneNet is a trademark of Farallon Computing Inc.

VAX is a trademark of Digital Equipment Corporation.

The following are trademarks of Apple Computer, Incorporated:

AppleTalk

EtherTalk

HyperCard

HyperTalk

Macintosh

Macintosh II

Macintosh IICx

Macintosh IIfx

Macintosh SE

Macintosh SE/30

MacTerminal

MacWorkstation

MultiFinder

TokenTalk

**WARNING:** This equipment generates, uses, and can radiate radio frequency energy; and if not installed and used in accordance with the instruction manual, may cause interference to radio communications. It has been tested and found to comply with the limits for a Class A computing device pursuant to Subpart J, Part 15 of FCC Rules, which are designed to provide reasonable protection against such interference when operated in a commercial environment. Operation of this equipment in a residential area is likely to cause interference; in which case the user must correct the interference at his/her own expense.

**WARNING:** This equipment is a Class A digital apparatus which complies with the Radio Interference Regulations, CRC c. 1374.

MacMainFrame Series  
Part # 65-2500-101-AA

Printed in the United States of America

# Table of Contents

<b>Preface</b> .....	<b>v</b>
Audience.....	v
How To Use This Book.....	v
<b>Chapter 1 — What You Need First</b> .....	<b>1</b>
Experience.....	1
Hardware .....	3
Software.....	5
Network Requirements .....	6
External Cables .....	6
<b>Chapter 2 — Installing the Hardware</b> .....	<b>7</b>
Introduction .....	7
Hardware Installation — Macintosh SE Machines .....	9
Hardware Installation — Macintosh SE/30 Machines .....	17
Hardware Installation — Macintosh II Family .....	25
Attaching the External Cable .....	29
Connecting the Workstation to the IBM Host.....	31
<b>Chapter 3 — Installing the Workstation Software</b> .....	<b>33</b>
Introduction .....	33
1. Check Your MMF Workstation components.....	34
2. Open the Workstation diskettes.....	35
3. Drag files to the System folder.....	36
4. Install the Workstation application.....	38
5. Go to the Control Panel.....	39
6. Go to the Avatar Control Panel.....	40
7. Check the lock panel.....	41
8. Select the Coax driver.....	42
9. Go to the LU panel.....	43
10. Go to the language panel.....	45
11. Check the lock panel.....	46
12. Close the Control Panel.....	46
13. Restart your Macintosh.....	47
14. Run the MMF Checker Application .....	49
Software Installation Done .....	50

<b>Appendix A — Key to MMF Workstation's Icons .....</b>	<b>51</b>
System Icons.....	51
Application Icons.....	53
<b>Appendix B — The Avatar Lock Panel.....</b>	<b>55</b>
Introduction.....	55
To Set The First Password.....	57
To Open the Lock .....	58
To Change the Password.....	59
When You Forget Your Password.....	59
<b>Appendix C — The DX Unit .....</b>	<b>61</b>
Introduction.....	61
Unpacking the DX Unit.....	62
Installing the DX Unit — Summary .....	63
Installing the DX Unit — LOCALLY.....	64
Installing the DX Unit — REMOTELY .....	72
Configuring the DX Unit.....	81
Software for the DX Unit .....	88
Using the DX Unit.....	88
<b>Index.....</b>	<b>91</b>

# Preface

This manual shows you how to install Avatar's MacMainFrame Series Coax Workstation on your Apple™ Macintosh computer.

This book also describes how to install MacMainFrame Coax Workstation as both a **CUT** (Control Unit Terminal) terminal and **DFT** (Distributed Function Terminal) terminal.

## Audience

This book is for people who set up MacMainFrame Workstation machines and who administer MacMainFrame networks.

## How To Use This Book

If you've never used MacMainFrame Workstation before, follow the chapters in order.

If you have used MacMainFrame Workstation before, turn to the section you need and follow the instructions there.

- Chapter 1 — What you need first
- Chapter 2 — Hardware Installation
- Chapter 3 — Software Installation
- Appendix A — Key to Icons
- Appendix B — Using the Avatar Lock Panel
- Appendix C — The DX Unit
- Index

## **Related Documents**

The MacMainFrame Series *Coax/SDLC/Token-Ring Workstation User Guide*

The MacMainFrame Series *Graphics Option User Guide*

## **For More Help**

Contact Avatar Customer Support: 1-800-282-8276

InCanada: 1-800-235-8276

# Chapter 1

## What You Need First

### Experience

To install MacMainFrame Coax Workstation, you should be familiar with basic Macintosh operations — pull-down menus, dialog boxes, using the mouse, and so on.

A working knowledge of the IBM operating environments with which you will be connecting is also helpful.

**Terminology:** For convenience, we'll refer to any MacMainFrame Series Workstation as a MMF Workstation hereafter.



---

The diagram below shows a typical MMF Coax Workstation setup:

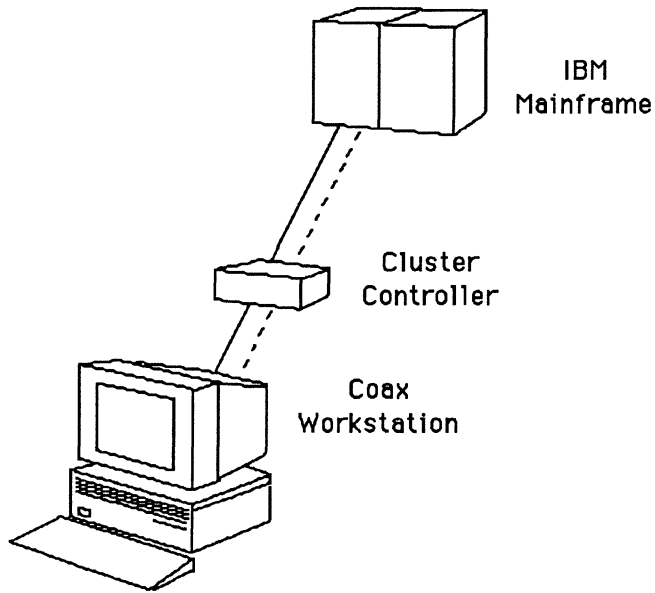

---

## Hardware

Your Macintosh must be one of the following to operate as a MMF Coax Workstation:

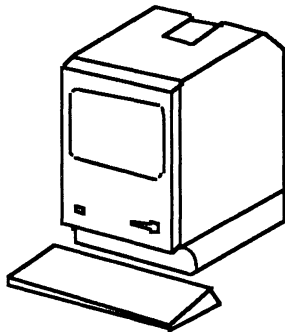

Macintosh Plus

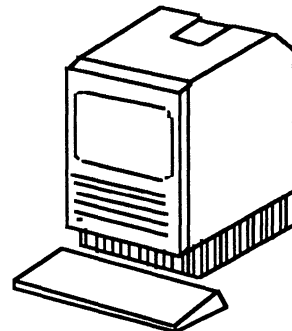

Macintosh SE,  
Macintosh SE/30

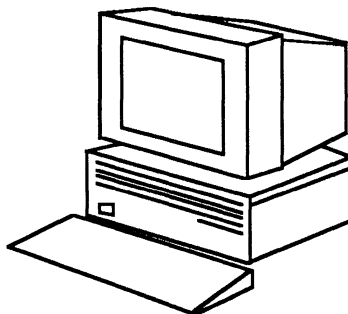

Macintosh II Family

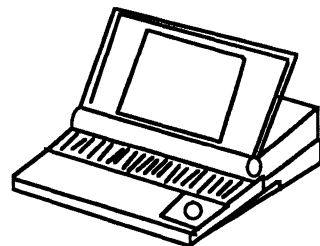

Macintosh Portable

**NOTE:** To use MMF Coax Workstation as a DFT (a multisession terminal), your Macintosh must be either an SE, an SE/30, or a Macintosh II.

## For Multisession Terminals

If you're running MMF **DFT** (multisession) Coax workstation, your Macintosh must have a free expansion slot in its chassis in order to install the MMF Workstation hardware.

- 
- The single slot on the SE or SE/30 must be free.
  - One of the slots on the Macintosh II must be free.

NOTE: For more information on the differences between CUT (single-session) and DFT (multisession) terminals, see the MacMainFrame Series *Coax/SDLC/Token-Ring Workstation User Guide*.

## For Single-Session Terminals

- ✓ CUT You can also run your MMF Coax Workstation as a MMF CUT (single-session) Coax Workstation. If your Macintosh does not have an additional expansion slot, you can still run MMF CUT Coax Workstation by using the Avatar DX Unit.

REMEMBER: We use these two markers throughout the text of this manual to indicate features related to MMF CUT Coax Workstations:

CUT terminals only:            ✓ CUT

Not for CUT terminals:        ✗ CUT

If you see a marker, follow the marker. If you don't see a marker, you can assume the text applies to your MMF Workstation no matter what kind of a Workstation it is.

## The DX Unit

- ✓ CUT The DX Unit offers several additional connectivity features:
  - Dial-up capability over asynchronous data communications lines,
  - MMF connectivity for Macintoshes without additional expansion slots — including the Macintosh Portable, and
  - External hardware alternative for MMF CUT Coax Workstations.

For complete information on the DX Unit, see Appendix C.

---

# Software

## Basic Requirements

To run the MMF Workstation software, your Macintosh must be equipped with System version at least 6.0.3.

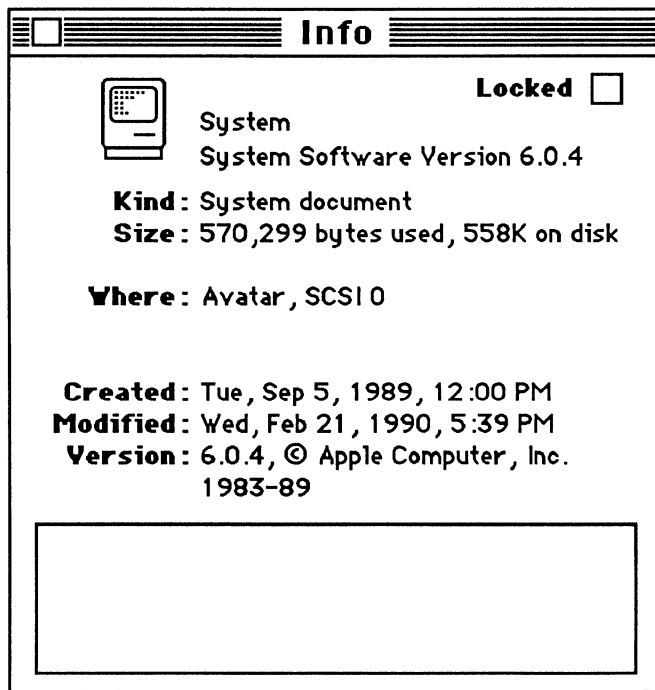

To find out the version of your System, go to the Finder, select the System's icon, then pull down the File menu and select **Get Info**; the Finder will display a window like the one above.

---

# Network Requirements

## Connectivity to the IBM Host

Your Workstation Macintosh must have access the IBM host — or to a cluster controller that is connected to the IBM host — with which you want to communicate.

Once the MMF Workstation software is running, it automatically makes contact with the IBM host and automatically obtains **logical unit (LU) sessions** from the host.

## External Cables

For all configurations of the MMF Coax Workstation, you must provide an external coax cable to connect the Workstation to the cluster controller.

# Chapter 2

## Installing the Hardware

### Introduction

To install the MMF Coax Workstation, you install both hardware and software into your Macintosh computer, and you connect the Macintosh to the IBM host.

The basic hardware installation steps are:

1. Install the Avatar Coax board into an expansion slot in your Macintosh.
2. Connect your board-equipped Macintosh to the IBM host machine.

This chapter explains how to perform these two tasks.

Appendix C explains how to install a **DX unit**, an external hardware unit that provides several other Coax connectivity features.

---

## How To Use This Chapter

Since the MMF Coax Workstation hardware can run on several different Macintosh hardware platforms, this chapter is divided into several subsections.

- In the first half of the chapter, turn to the subsection that applies to your Macintosh and follow the directions there.
- In the second half of the chapter, follow the single set of instructions for connecting your Macintosh to the IBM host, since they apply to all Macintoshes.

**NOTE:** For complete information about your Macintosh hardware, please see your original Macintosh documentation.

✓ **CUT** If you're using a **DX Unit**, *skip this chapter and go directly to Appendix C, "The DX Unit."*

---

## Hardware Installation — Macintosh SE Machines

**WARNING:** The hardware for the SE version of the MMF Workstation is not user installable.

Please have an authorized Apple dealer install the MMF Workstation hardware on your Macintosh SE.

These instructions are provided for the authorized Apple dealer.



---

## Unpacking Hardware for Macintosh SE

Open the shipping carton and make sure you have everything shown here:



MMF Coax Workstation board

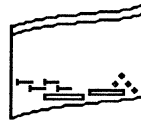

Plastic bag with screws, nuts, etc.

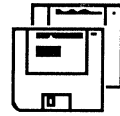

Two diskettes containing software



Internal cable with backing plate and BNC connector

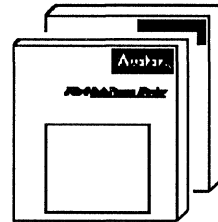

*MMF Workstation User's Guide, MMF Workstation Installation Guide*

If you're missing something, contact Avatar. If anything is damaged, contact the shipping agent.

### External Cables

**REMEMBER:** You must provide a coax cable to connect the Workstation to the cluster controller. Examples:



Coax cable — BNC connector on each end



Coax cable — BNC connector, RJ45 connector

---

## Installing Hardware Into Macintosh SE

Follow these steps to install the MMF Workstation hardware into a Macintosh SE machine:

1. Power down the SE.
2. Open the SE's case.
3. Disconnect the cables to the SE motherboard.
4. Remove the motherboard from the chassis.
5. Take the Workstation board out of its anti-static bag.
6. Connect the Workstation board to the motherboard:
  - Press the two standoffs onto the motherboard until you hear them snap into place.
  - Line up the connector on the Workstation board with the expansion connector on the SE motherboard.
  - Gently but firmly press the Workstation board into place on the motherboard.

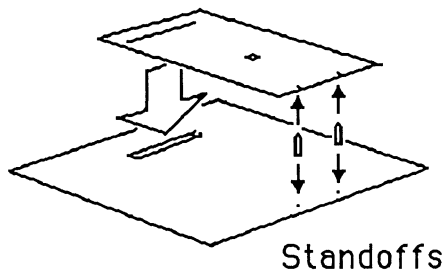

---

7. Install the internal cable:

- On the Workstation board, find the J2 connector; it is a white plug near the center of the board:
- Plug the cable into this connector so that the green wire is towards C12.

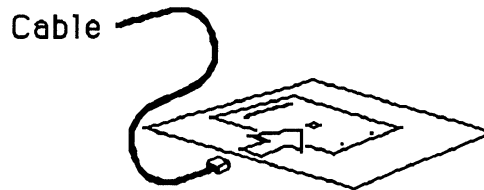

Close-up:

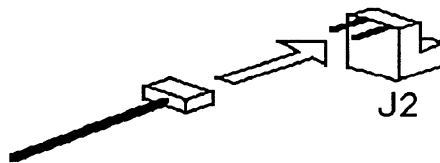

- 
8. Thread the cable into position in the SE's chassis:

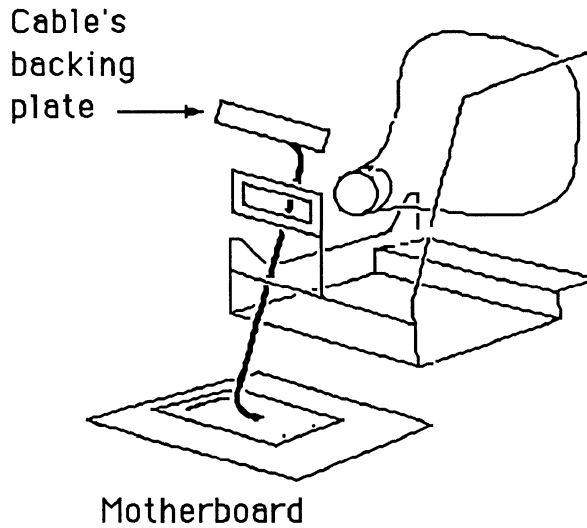

9. Slide the motherboard/Workstation board back into the SE chassis.  
First, rotate the Macintosh onto its face:

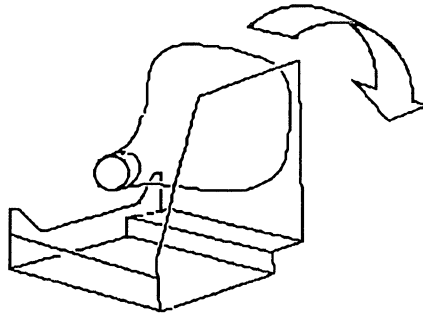

---

Then insert the motherboard:

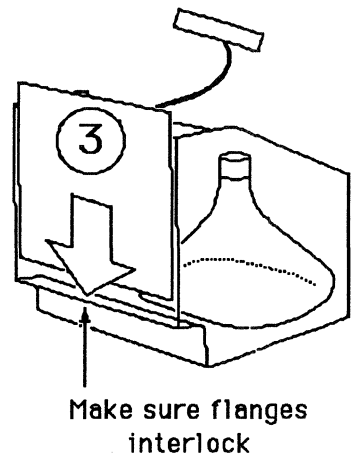
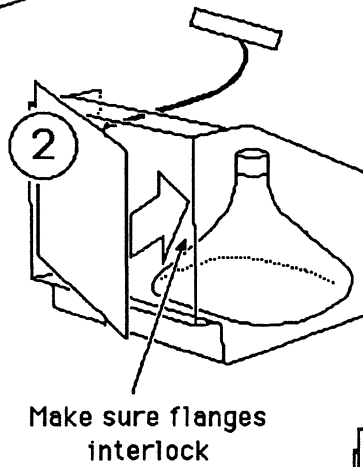
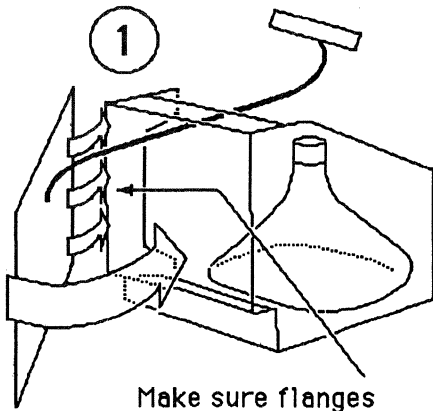

- 
10. Position the internal cable's backing plate in the backing plate mounting. Make sure the BNC connector faces outward:  
Screw the plate into the Macintosh chassis.

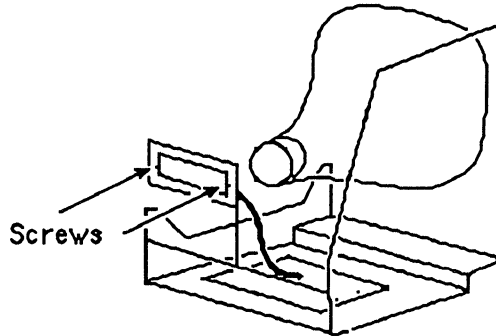

11. On the outside of the case in back, remove the knockout panel that covers the accessory port.

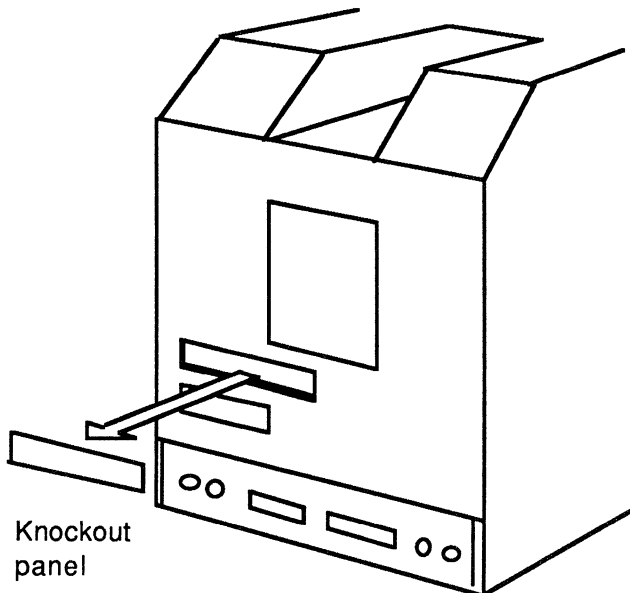

- 
12. Reassemble your SE, positioning the accessory port on the case over the mounted end of the cable that now projects out the back of the chassis.

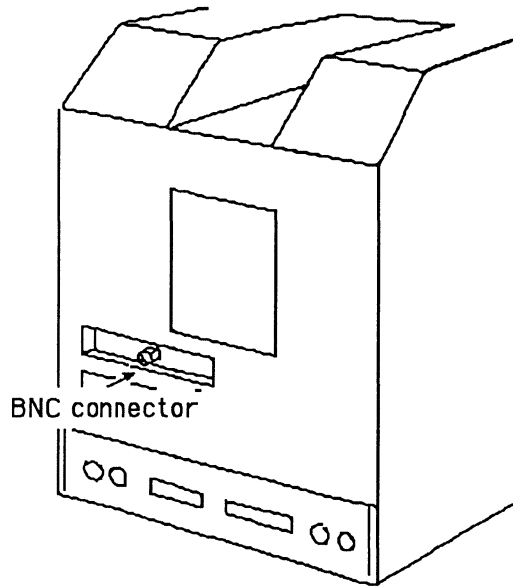

Physically, your internal hardware installation is complete.

Before you can use your MMF Coax Workstation, you must also install the external coax cable. See the second half of this chapter for complete instructions.

**REMEMBER:** Test your MMF hardware. To do this, you use the MMF Checker program, which comes with your MMF software. Software installation is described in Chapter 3. The Checker program is also described in Chapter 3.

---

## Hardware Installation — Macintosh SE/30 Machines

**WARNING:** The hardware for the SE/30 version of the MMF Workstation is not user installable.

Please have an authorized Apple dealer install the MMF Workstation hardware on your Macintosh SE/30.

These instructions are provided for the authorized Apple dealer.



---

## Unpacking Hardware for Macintosh SE/30

Open the shipping carton and make sure you have everything shown here:

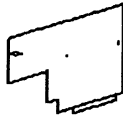

MMF Coax Workstation board



Plastic bag with screws, nuts, etc.

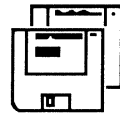

Two diskettes containing software



Internal cable with backing plate and BNC connector

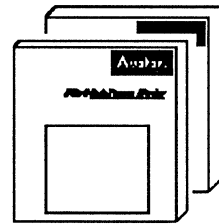

*MMF Workstation User's Guide, MMF Workstation Installation Guide*

If you're missing something, contact Avatar. If anything is damaged, contact the shipping agent.

### External Cables

**REMEMBER:** You must provide a coax cable to connect the Workstation to the cluster controller. Examples:



Coax cable — BNC connector on each end



Coax cable — BNC connector, RJ45 connector

---

## Installing Hardware Into Macintosh SE/30

Follow these steps to install the MMF Workstation hardware into a Macintosh SE/30 machine:

1. Power down the SE/30.
2. Open the SE/30's case. (The diagram below shows only the main features of the SE/30's internal hardware.)

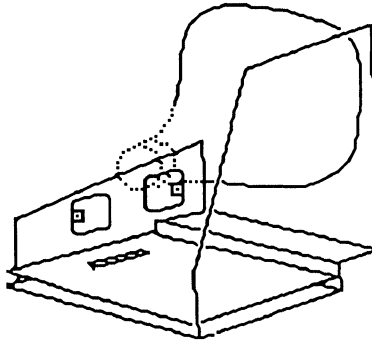

- 
3. Take the Workstation board out of its anti-static bag.
  4. Position the Workstation board inside the SE/30's chassis.

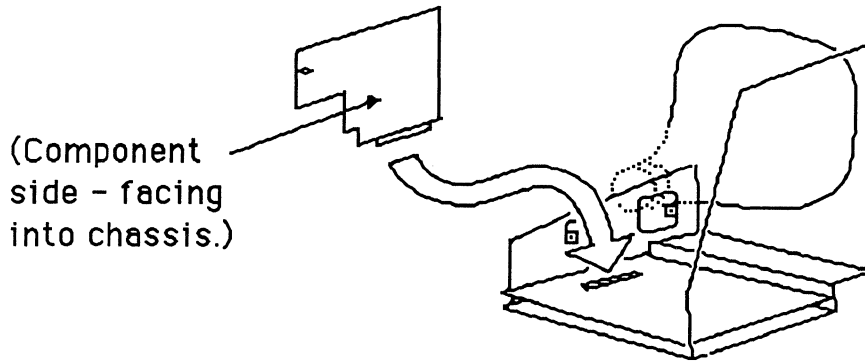

Make sure the Workstation board tucks under the forward flange on the side mounting plate.

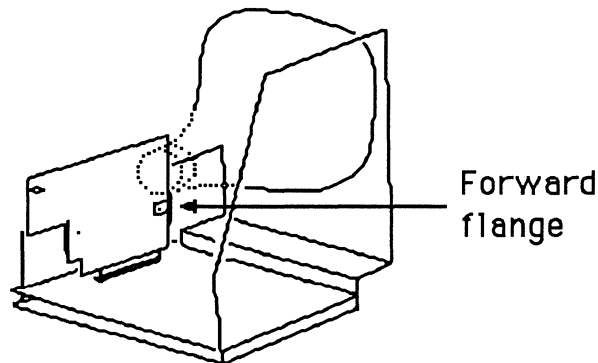

Press the Workstation board down on the expansion connector on the SE/30's motherboard.

- 
5. Screw the Workstation board to the side mounting plate.

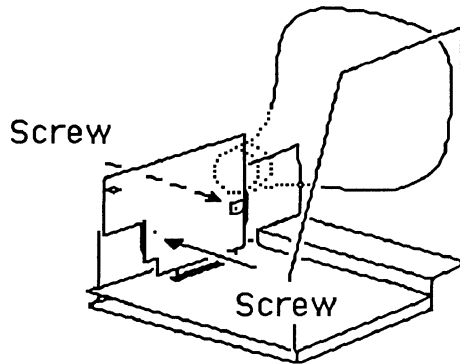

6. Install the internal cable.

Position the backing plate of the internal cable on the inside of the SE/30's chassis so that the BNC connector faces outward:

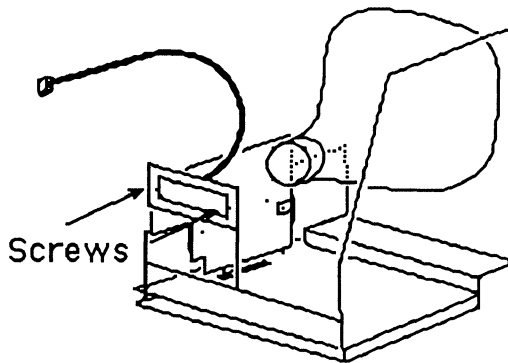

Screw the plate into the Macintosh chassis.

- 
7. Connect the other end of the internal cable to the Workstation board.
- On the Workstation board, find the J3 connector; it is a white plug near the edge of the board:
  - Plug the internal cable into this connector so that the green wire is towards CR1.

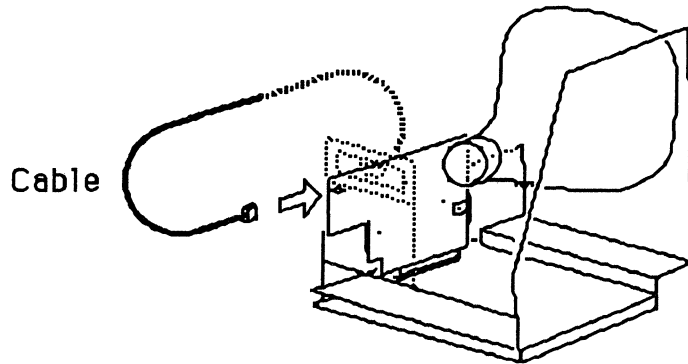

Close-up:

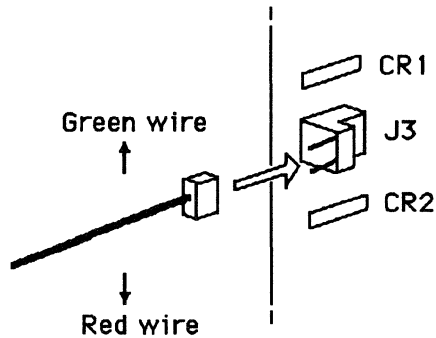

- 
8. On the outside of the case in back, remove the knockout panel that covers the accessory port.

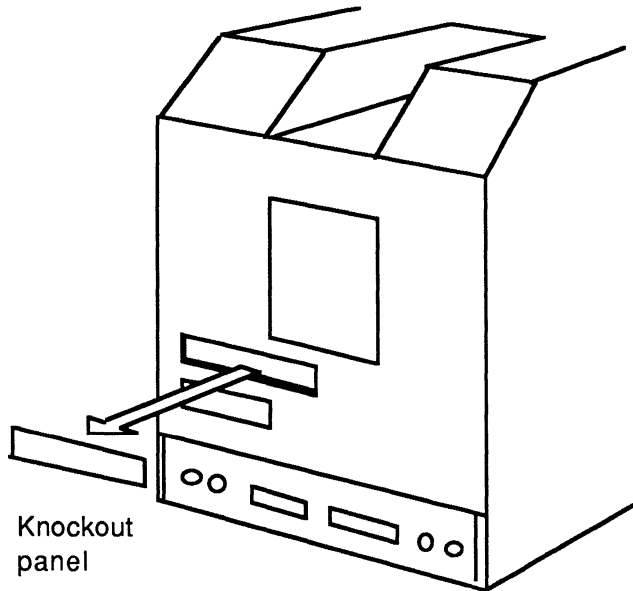

- 
9. Reassemble your SE/30, positioning the accessory port on the case over the mounted end of the cable that now projects out the back of the chassis.

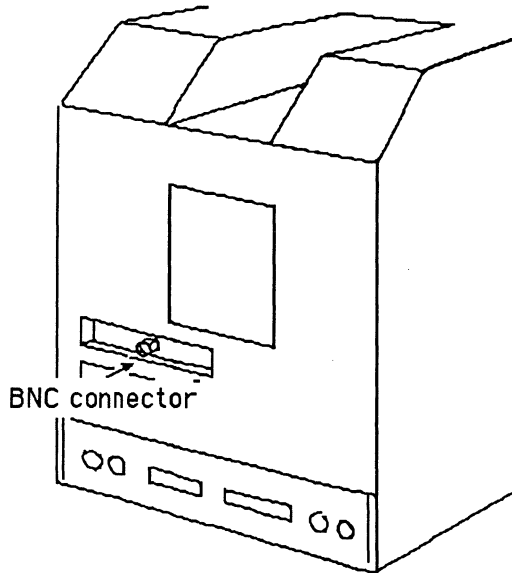

Physically, your hardware installation is complete.

Before you can use your MMF Coax Workstation, you must also install the external coax cable. See the second half of this chapter for complete instructions.

**REMEMBER:** Test your MMF Workstation hardware. To do this, you use the MMF Checker program, which comes with your MMF Workstation software. Software installation is described in Chapter 3. The Checker program is also described in Chapter 3.

---

# Hardware Installation — Macintosh II Family

## Unpacking Hardware for Macintosh II Family

Open the shipping carton and make sure you have everything shown here:

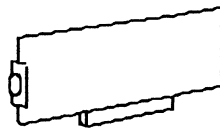

MMF Coax Workstation  
board

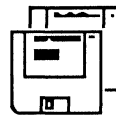

Two diskettes containing  
software

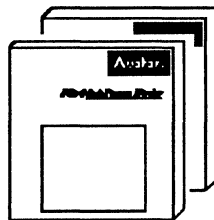

*MMF Workstation User's Guide,  
MMF Workstation Installation Guide*

If you're missing something, contact Avatar. If anything is damaged, contact the shipping agent.

### External Cables

**REMEMBER:** You must provide a coax cable to connect the Workstation to the cluster controller. Examples:



Coax cable — BNC  
connector on each end



Coax cable — BNC  
connector, RJ45 connector



---

## Installing Hardware Into Macintosh II Family

Follow these steps to install the MMF Workstation hardware into a Macintosh II machine:

1. Power down the Macintosh II.
2. Open the Macintosh II's case.

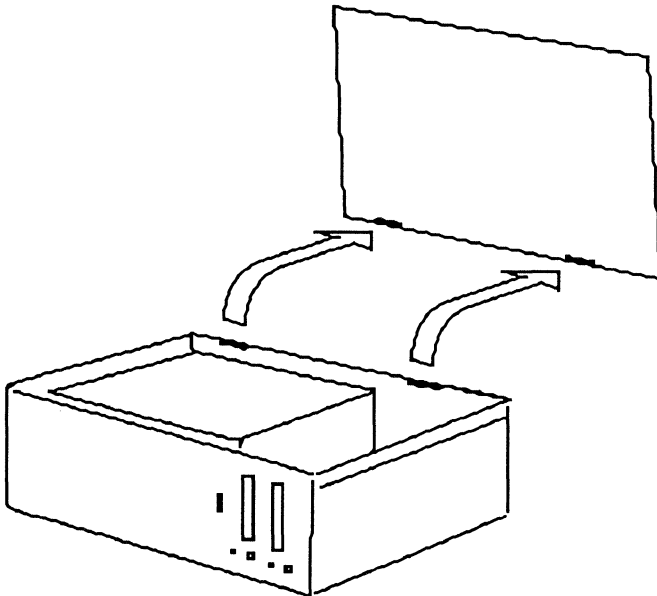

3. Select a slot for the Workstation board. Remove the knockout panel from that slot.
4. Take the Workstation board out of its anti-static bag.

- 
5. Slide the Workstation board into the slot in the Macintosh II's chassis:
- Make sure the BNC connector projects out through the rear panel.
  - Make sure the expansion connector on the Workstation board lines up with the expansion connector on the Macintosh II's motherboard; the motherboard is on the bottom of the chassis.
  - Gently but firmly press the Workstation board down into place.

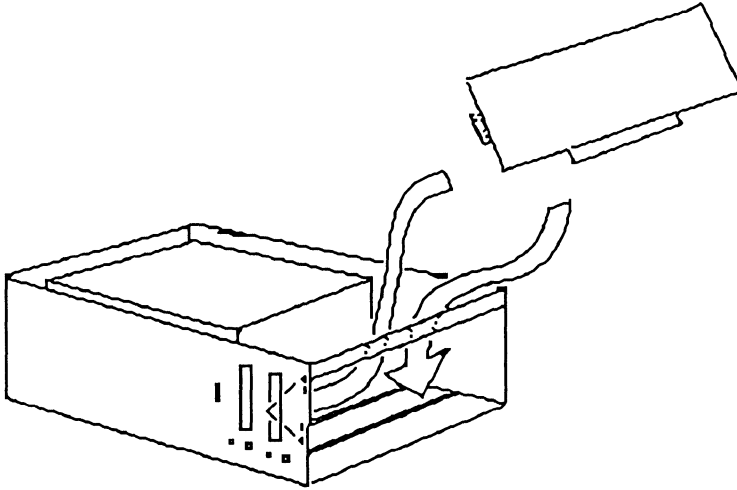

6. Close the Macintosh II's case.

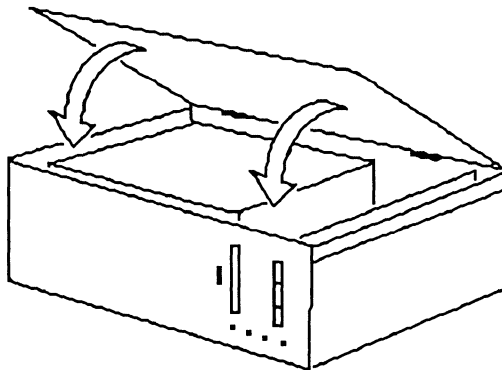

Physically, your internal hardware installation is complete.

---

Before you can use your MMF Coax Workstation, you must also install the external coax cable. See the second half of this chapter for complete instructions.

**REMEMBER:** Test your MMF hardware. To do this, you use the MMF Checker program, which comes with your MMF software. Software installation is described in Chapter 3. The Checker program is also described in Chapter 3.

---

## Attaching the External Cable

After you have installed the Workstation board in your Macintosh and closed the case, install the external coax cable that connects the Macintosh to the IBM host.

The following sections show how to attach the external cable to Macintosh SE and SE/30 machines and to Macintosh II machines.

### Attaching External Cable to Macintosh SE and SE/30

Plug the coax cable into the Workstation board's BNC connector, which extends out of the back of the Macintosh SE and SE/30, as shown here:

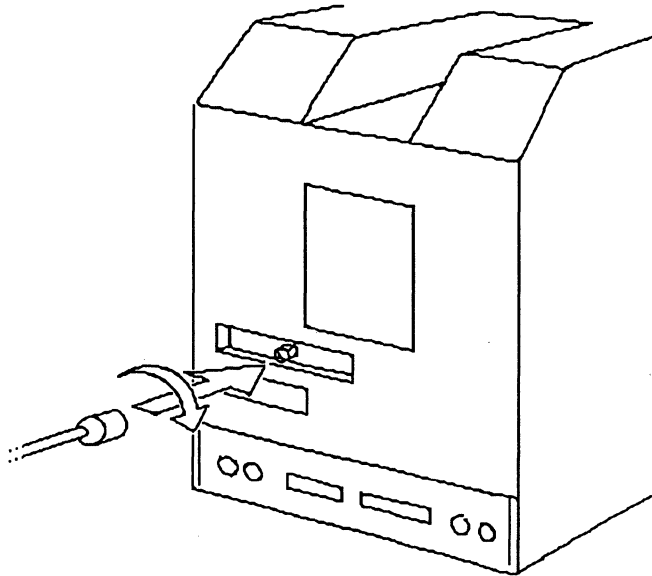

---

## Attaching External Cable to Macintosh II Family

Twist the coax cable onto the Workstation board's BNC connector, which extends out of the back of the Macintosh II, as shown here:

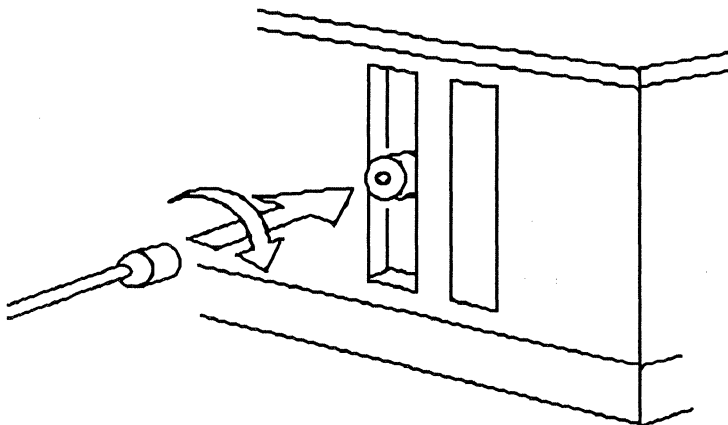

---

# Connecting the Workstation to the IBM Host

To connect the MMF Coax Workstation to the IBM host, you connect the coax cable from the Workstation machine to the IBM cluster controller.

## Ports on the Cluster Controller

The Workstation will connect to a port on the cluster controller.

- ✗ **CUT** If you're running MMF **DFT** (multi-session) Coax workstation, make sure the port is configured for:
  - A distributed function terminal (DFT).
  - Multiple LU sessions.
- ✓ **CUT** If you're running MMF **CUT** (single-session) Coax workstation, make sure the port is configured for a CUT terminal.



# Chapter 3

## Installing the Workstation Software

### Introduction

The steps to install the MMF Workstation software on your Coax Workstation are the same for all Macintosh hardware platforms:

1. Check your MMF Workstation components.
2. Open the Workstation diskettes.
3. Drag files to the System folder.
4. Install the Workstation application.
5. - 12. Go to the Control Panel and perform various set-up tasks.
13. Restart your Macintosh.
14. Run the MMF Checker application.

The following sections explain each step in detail.



---

# 1. Check Your MMF Workstation components.

To install the MMF Workstation software you need the software and the manual.

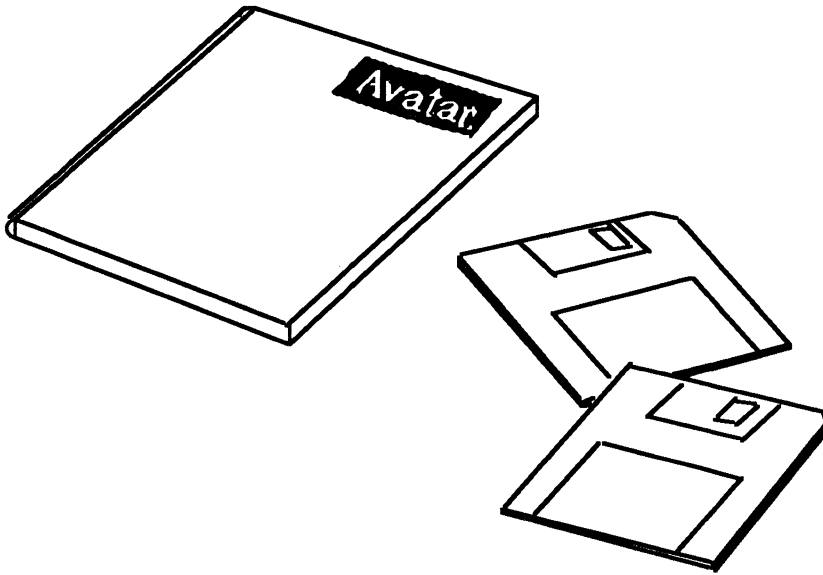

You're reading the manual now.

The software comes on two diskettes.

---

## 2. Open the Workstation diskettes.

Double-click the mouse on the diskette icon to open the diskettes.

Make sure you have all the documents shown below. If anything is missing, Contact Avatar.

**x CUT** NOTE: MMF 3287 is not available on MMF CUT terminals.

**Diskette 1:**

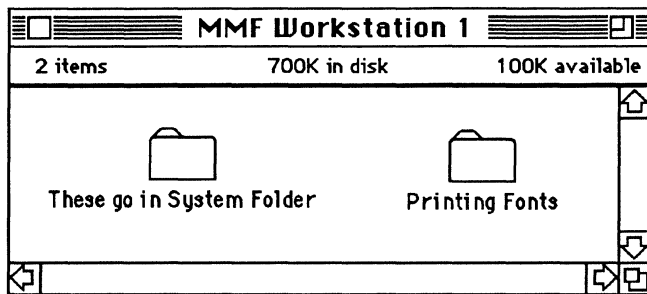

**Diskette 2:**

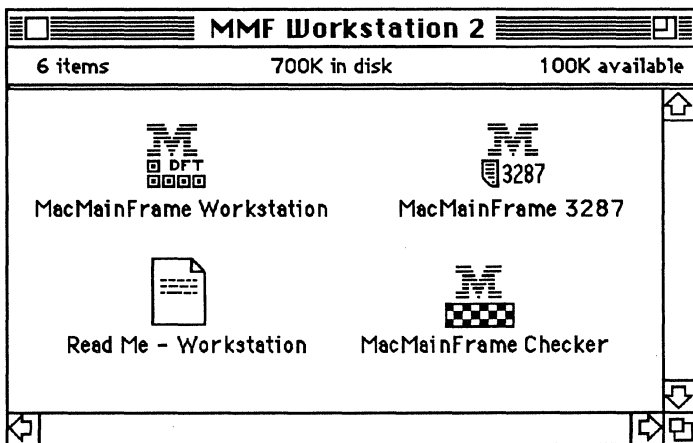

Make a backup copy of each diskette.

**Read the Read Me - Workstation document first.** It contains important information about the current release of the Workstation software. Read Me - Workstation is a Macintosh text document, which you can read with the TeachText application.

### 3. Drag files to the System folder.

Insert Diskette 1 and double-click on the folder entitled, "These go in System Folder."

Make sure the following documents are there: (If you're not sure which documents are which, Appendix A contains a key to the MMF Workstation icons.)

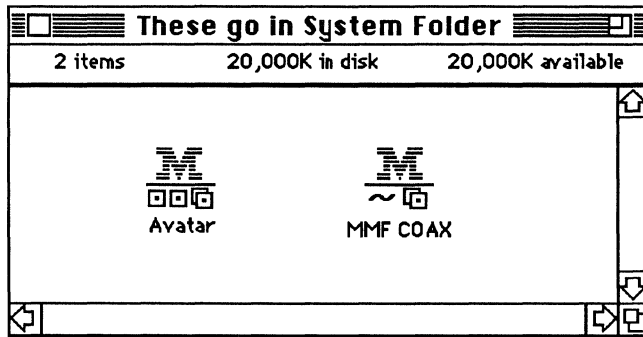

NOTE: We've used a stand-in icon — MMF COAX — in the above illustration to represent the seven possible Coax Workstation driver icons. The seven Coax drivers are:



C U T I c o n s



D F T I c o n s

---

Drag the Avatar icon and the driver icon that's appropriate for your Macintosh to the System folder. Here, we're dragging Avatar icon plus the driver for a Mac II DFT Coax Workstation:

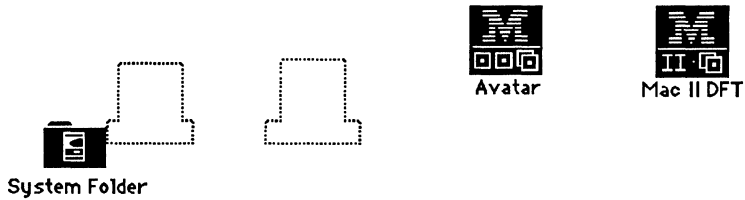

Close the System folder.

---

## 4. Install the Workstation application.

Insert Diskette 2 and drag the MMF Workstation application icon from the diskette to a convenient place on your Macintosh's start-up disk.

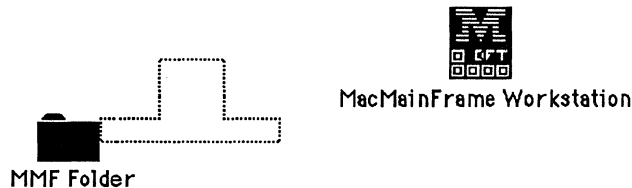

✓ CUT REMEMBER: If you're using MMF CUT Workstation, the application icon looks like this:

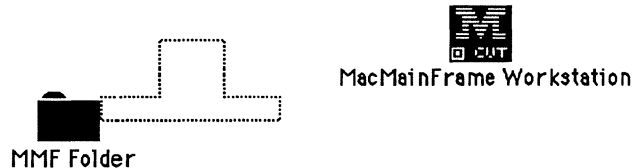

### MacMainFrame 3287, MacMainFrame Graphics

✗ CUT MMF 3287 and MMF Graphics are not available on MMF CUT terminals.

You may also install these other MacMainFrame products at this time:

- **MacMainFrame 3287**, Avatar's printer emulation software. For complete information on MMF 3287, see the MacMainFrame Series *Coax/SDLC/Token-Ring Workstation User Guide*.
- **MacMainFrame Graphics**, Avatar's IBM host graphics software, for use with MacMainFrame Series products. For complete information on MMF Graphics, see the MacMainFrame Series *Graphics Option User Guide*.

---

## 5. Go to the Control Panel.

Pull down the Apple menu and select the Control Panel.

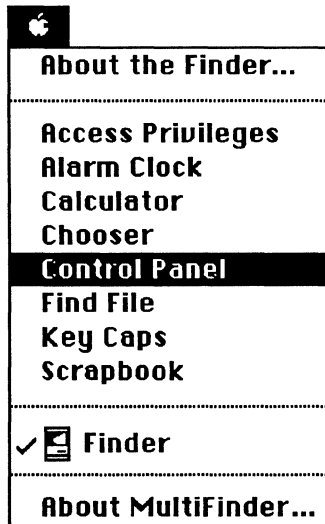

In the Control Panel, you'll do the following:

- Go to the Avatar panel; select a driver for the Coax hardware.
- Select the language conventions for your workstation.
- Identify your LU session(s) as being for Terminal or Printer.
- Optionally lock all the Avatar panel settings.

The following sections — steps 6 through 12 — show you how to do this.

---

## 6. Go to the Avatar Control Panel.

Click the Avatar icon.

The Avatar panel will appear, displaying a list of MMF Drivers.

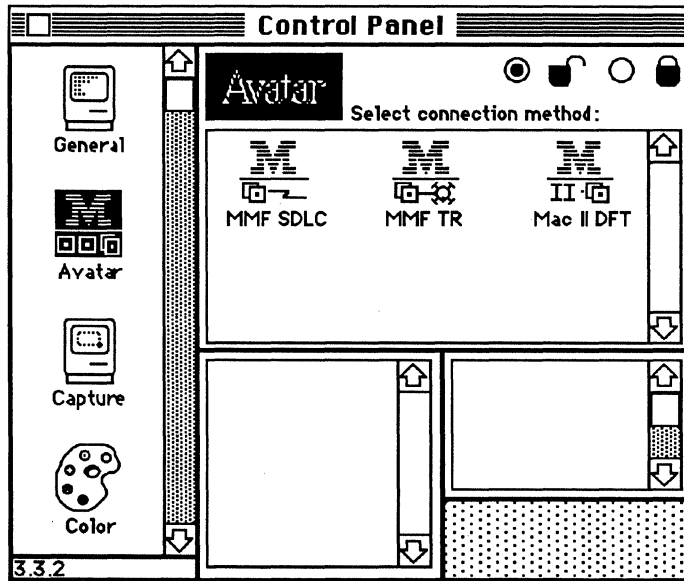

---

## 7. Check the lock panel.

Supply a password if necessary, and make sure the unlocked icon is selected:

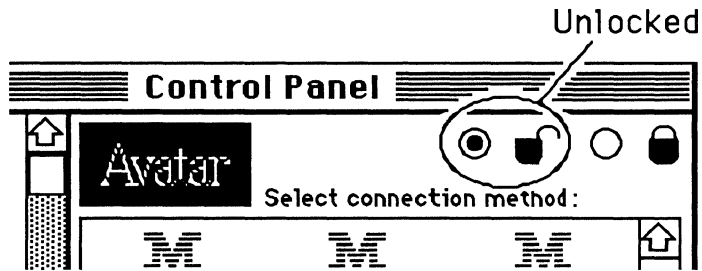

For complete information on how to use the Avatar lock panel, see Appendix B.



---

## 8. Select the Coax driver.

Click on the appropriate driver for your Macintosh hardware. Here we've clicked on the driver for a Mac II DFT Coax Workstation:

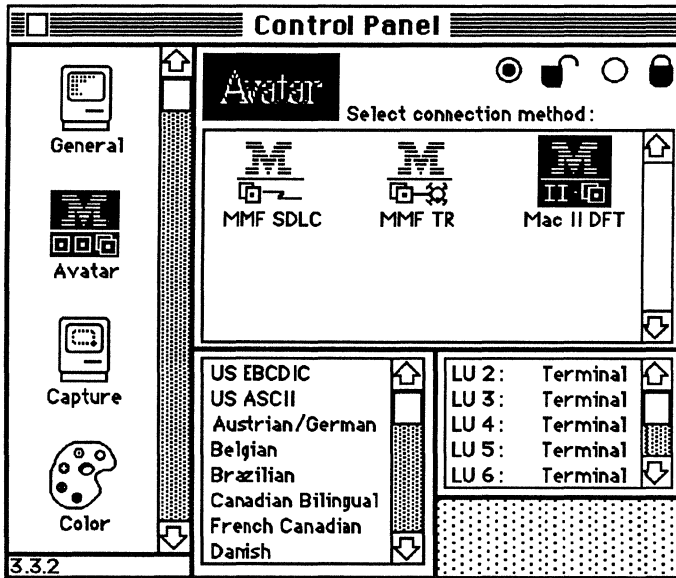

---

## 9. Go to the LU panel.

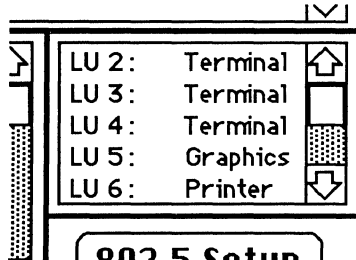

- x CUT** Make sure your LU sessions are set to the appropriate type, either Terminal or Printer. To do this, position the cursor over the desired LU and hold down the OPTION key. The cursor will change from a cross to a double-ended arrow:

|| LU 4: + Terminal [dotted pattern] ||

|| LU 4: ↔ Terminal [dotted pattern] ||

Click the cursor on the desired LU to have the LU's type change from Terminal to Printer to Graphics to Terminal, and so on.

- LU sessions of type **Printer** are for use by the **MMF 3287** printer emulation software. Only one LU session at a time can be a **Printer** session. For complete information on MMF 3287, see the *MacMainFrame Series Coax/SDLC/Token-Ring Workstation User Guide*.
- LU sessions of type **Graphics** are for use by the **MMF Graphics** software. For complete information on MMF Graphics, see the *MacMainFrame Series Graphics Option User Guide*.

---

✓ CUT If you're using MMF CUT, you'll see sessions of type Terminal only:

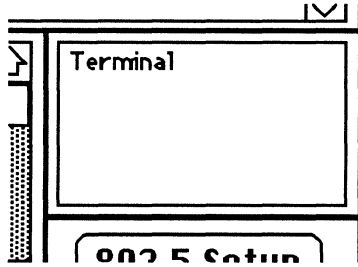

---

## 10. Go to the language panel.

The language panel appears in the Avatar Control Panel:

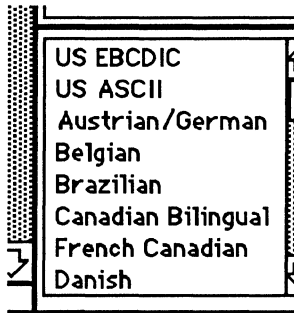

Scroll through the list of languages and click on the language that's configured on your IBM host or cluster controller. See your host system manager for information about this language.

The language panel lets you select the language conventions that your MMF Workstation will follow when it transfers data to and from the IBM host . (Example: When you select Austrian/German, MMF Workstation will recognize and reproduce characters that have umlauts over them — ä, ë, etc.)

This selection applies to all LU sessions on this Workstation.

The language choices are:

US EBCDIC	English (UK)	NewSpanish
US ASCII	Finnish	Norwegian
Austrian/German	French AZERTY	Portuguese
Belgian	French QWERTY	Spanish
Brazilian	Icelandic	Spanish Speaking
Canadian Bilingual	International	Swedish
French Canadian	Italian	Swiss French
Danish	Japanese (English)	Swiss German

---

## 11. Check the lock panel.

Go to the Lock panel again and make sure the icon you wish is selected — either locked or unlocked. Supply a new password now if you wish.

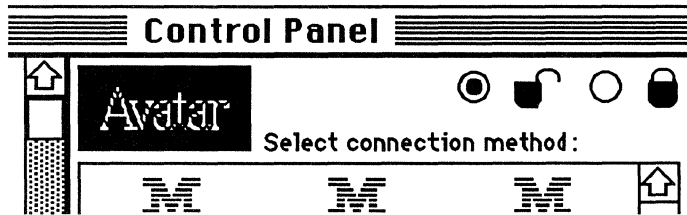

The Lock panel lets you optionally lock the parameters in the Avatar control panel. For complete information on how to use the Avatar lock panel, see Appendix B.

## 12. Close the Control Panel.

Close the Macintosh Control Panel by clicking the Close box in the upper left corner.

You'll see an alert box:

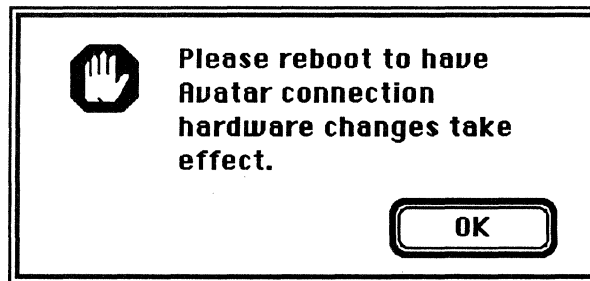

---

## 13. Restart your Macintosh.

Select **Restart** from the Special menu:



As your Macintosh comes up, the Workstation icon will appear. Here are the seven possible Coax Workstation icons again:

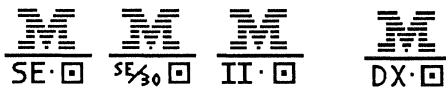

**C U T   I c o n s**



**D F T   I c o n s**

(See Appendix A for a complete list of MMF Coax Workstation icons.)

---

## Bad Start-up

At power-up time, if the Workstation icon turns on its side or has an X through it, make sure your MMF Workstation hardware and software are installed properly.

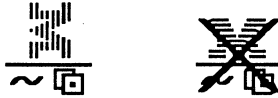

(We've used stand-in icons again here to represent the seven possible Coax Workstation icons.)

(You can force the MMF Workstation not to run by powering up your Macintosh with your finger on the OPTION key or the mouse button. The Token-Ring Workstation icon will also appear with an X through it in that case.)

When your Macintosh is up again (and no sideways or X-ed out icons have appeared), MMF Workstation is running again.

---

## 14. Run the MMF Checker Application

The MMF Checker application tells you the current status of your MMF hardware and software. You can use MMF Checker as soon as your Macintosh has powered up.

To check your entire MMF Workstation configuration:

1. Make sure the MMF Workstation hardware is properly installed in your Macintosh. See Chapter 2.
2. Make sure the Macintosh is physically connected to the IBM host via the external cable. See Chapter 2.
3. Make sure the MMF Workstation software is properly installed in your Macintosh. See the instructions above.
4. Load the MacMainFrame Checker application from the MMF Workstation distribution diskette to your Macintosh's start-up disk.



MacMainFrame Checker

The Checker provides options to check an external **DX unit**, which you might have if you're running a MMF CUT Coax Workstation. For information on using the Checker to check a DX unit, see Appendix C.

5. Double-click on the MMF Checker icon. The menu bar will change to the Checker's:





- 
6. To check your MMF Workstation hardware status, select **Hardware Status...** from the Control menu:

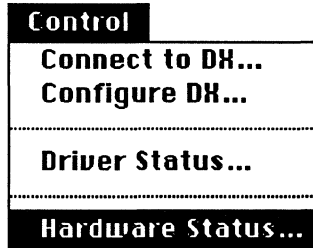

- To check your MMF Workstation software status, select **Driver Status...** from the Control menu:

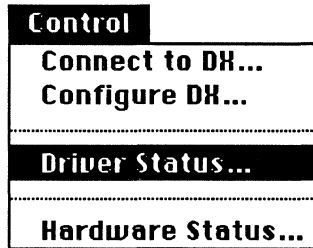

7. When you've finished running the Checker, pull down the Checker's File menu and select **Quit** to quit the Checker.

## Software Installation Done

Your MMF Workstation software is now installed.



To start and configure the MMF Workstation software, follow the instructions in the MacMainFrame Series *Coax/SDLC/SDLC Workstation User Guide*.

# Appendix A







## Key to MMF Workstation's Icons

This appendix lists the icons you may see when you use MMF Coax Workstation.





### System Icons

Icon	Type	Does this:
 Avatar	Control Panel document	Lets you select driver software that MMF products must use; lets you supply configuration parameters to the drivers.
 MacMainFrame Checker	Application	Lets you verify your hardware and software installation of MMF Workstation, and lets you configure your MMF Workstation.





## System Icons, continued

Icon	Type	Does this:
<p><b>Drivers for MMF CUT Workstations</b></p>  <p>Mac SE CUT</p>	<p><b>Drivers for MMF DFT Workstations</b></p>  <p>Mac SE DFT</p>	<p>Driver software</p> <p>Lets MMF products communicate with hardware and perform other basic tasks.</p>
 <p>SE/30 CUT</p>	 <p>SE/30 DFT</p>	
 <p>Mac II CUT</p>	 <p>Mac II DFT</p>	
 <p>DX CUT</p>		

# Application Icons

Icon	Type	Name and Function:
<p><b>For Coax DFT Workstations:</b></p>  <p>MacMainFrame Workstation</p> <p><b>For Coax CUT Workstations:</b></p>  <p>MacMainFrame Workstation</p>	<p>Application</p>	<p>MacMainFrame Workstation — This is the MMF Workstation software. Accepts and displays data in your 3270 windows; communicates with the MMF Workstation driver.</p>
<p><b>For Coax DFT Workstations:</b></p>  <p>(User supplies name)</p> <p><b>For Coax CUT Workstations:</b></p>  <p>(User supplies name)</p>	<p>Session Settings document</p>	<p>Saves your MMF Workstation set-up — LU sessions, host configuration, keyboard layout, etc.</p>
 <p>(User supplies name)</p>	<p>Batch document</p>	<p>Contains commands for MMF Workstation to perform batch processing of uploads, downloads, and File deletes.</p>

## Application Icons, continued

Icon	Type	Name and Function:
 MacMainFrame 3287	Application	MacMainFrame 3287 — Emulates a 3287-type printer and lets MMF Workstation route an IBM print stream to the Chooser printer.
 Armonk	Font	Armonk — Avatar's proprietary type font (bitmap version), for use with MMF Series products.
 Armon	Font	Armon — Postscript version of Armonk font.
 (User supplies name)	Print Settings document	Saves your MMF 3287 set-up.

# Appendix B

## The Avatar Lock Panel

### Introduction

The lock panel lets you secure some of the MMF Workstation's parameter settings so that no one can change them without a password. The lock panel does not prevent users from using the Workstation.

To get to the lock panel, go to the Macintosh Control Panel and select the Avatar icon in the scroll list on the left. (If there's no Avatar icon in the list, your Workstation software is not fully installed. See Chapter 3 for instructions.)

The lock panel looks like this:

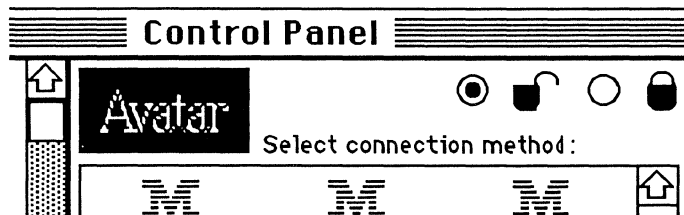

If the locked lock is selected, you must supply a password before you can change any parameters in the various parameters panels.

---

## Locked Items

On MMF Coax Workstations, the items that the Avatar lock panel locks include:

- LU panel settings.
- Language panel settings.

When the items are locked, you can view the parameter settings, but you can't change them unless you click the unlock radio button and fill in the passwords as MMF requests.

**CAUTION:** Once you give a user the password for their Workstation, they can change the password at that Workstation, which means they can temporarily prevent you, the network administrator, from changing the settings at that Workstation any further.

## Items the Lock Does Not Affect

The Avatar lock panel's mechanism does *not* affect the following items:

- Applications, such as the MMF Workstation application.
- The contents of MMF Session Settings documents.

---

## To Set The First Password

Avatar ships the lock panel in an opened state; that is, there is no password and anyone can use the lock panel and the parameters it controls.

To set the first password:

1. Click the "locked" radio button:  

You'll see the following dialog box:

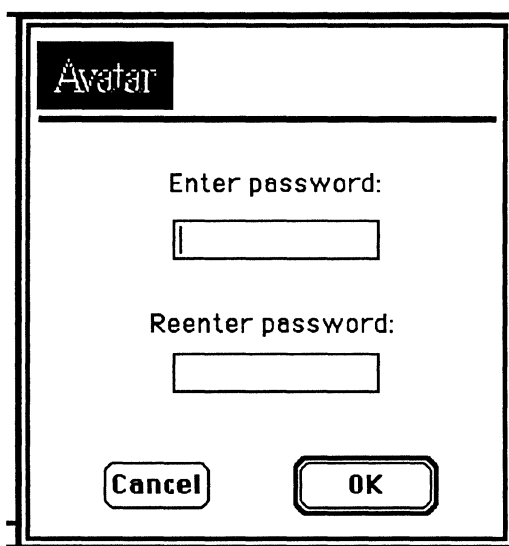

The dialog box has a title bar with the word "Avatar" on the left. Below the title bar, there are two text prompts: "Enter password:" followed by a rectangular input field, and "Reenter password:" followed by another rectangular input field. At the bottom of the dialog box, there are two buttons: "Cancel" on the left and "OK" on the right.

2. To set the new password, enter the password in both password items, as the prompts indicate.
3. Click OK.

MMF will return you to the lock panel, and the locked icon will be selected:



This means your MMF Workstation parameters are *now locked*; you can use your workstation but you can't change any of its parameters unless you unlock the lock.



---

## To Open the Lock

To open the lock:

1. Click the "unlocked" radio button:  

MMF will now display the following dialog box:

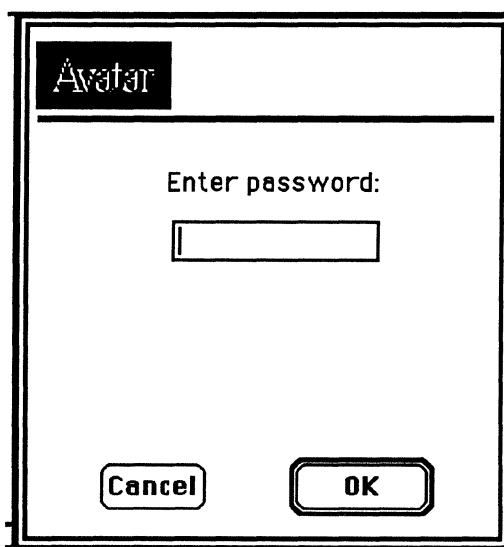

The dialog box has a title bar with the word "Avatar" on the left. Below the title bar, the text "Enter password:" is centered above a rectangular input field. At the bottom of the dialog box, there are two buttons: "Cancel" on the left and "OK" on the right.

2. Supply a correct password.
3. Click OK.

MMF will return you to the lock panel, and the unlocked icon will be selected:



---

## To Change the Password

To change the password:

1. Unlock the lock, as described above.
2. Then follow the same procedure as to set the first password: click the unlock radio button, then supply the new password in both password items.

## When You Forget Your Password

If you forget the password, you won't be able to unlock the lock; you also won't be able to change the password (for example, to one you can remember).

To solve this problem, you must install a new copy of the Avatar Control Panel document in your System Folder, then go to the Avatar Panel and follow the steps in "To Set the First Password," above.

Don't forget to get rid of the old Avatar Control Panel document.

**REMEMBER:** The password.



# Appendix C

## The DX Unit

### Introduction

✓ CUT The DX Unit is an external hardware device that provides single-session IBM connectivity for MMF Coax products. The DX Unit has several benefits:

- The DX Unit is an alternative to internal Coax hardware.
- The DX Unit allows Macintoshes with no extra expansion slots to get MMF Coax connectivity. This includes Macintosh Portables.
- The DX Unit allows a dial-up capability over asynchronous data communications lines; you place the DX Unit at the cluster controller and dial up the DX Unit's modem with your Macintosh's modem.

To use the DX Unit, you first install it, then configure it, then simply power it up each time you wish to use it. The following sections explain how to perform these tasks.

✓ CUT NOTE: The DX Unit supports single-LU-session operation only; that is, it operates in CUT (Control Unit Terminal) mode. For more information on the differences between CUT (single-session) and DFT (multi-session) terminals, see the MacMainFrame Series *Coax/SDLC/Token-Ring Workstation User Guide*.

---

# Unpacking the DX Unit

Open the shipping carton and make sure you have everything shown here:

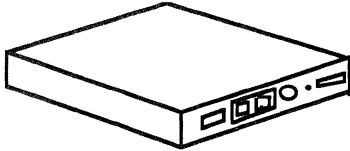

DX Unit



Diskette containing  
CUT software

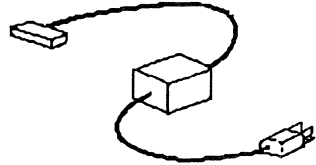

DX power cable with  
transformer



DX data cable — RJ45  
connector on each end.



Adapter



Macintosh data cable — RJ45  
connector, DIN8 connector

If you're missing something, contact Avatar. If anything is damaged, contact the shipping agent.

## External Cables

You also need a coax cable to connect the DX Unit to the cluster controller. Examples:



BNC connector on each end



BNC connector, RJ45  
connector

## Modems

If you're going to use the DX Unit in a remote configuration, you'll need to supply two asynchronous modems, one for the Macintosh and one for the DX Unit.

---

## Installing the DX Unit — Summary

You can place the DX Unit near the Macintosh or near the host, depending on your needs and the kind of communications lines you are using.

- In the local installation, the DX Unit is at the Macintosh and talks to the host via the cluster controller or via a modem.
- In the remote installation, the DX Unit is at the cluster controller, and the Macintosh must talk to it via a modem.

Here are the steps to perform each type of installation:

**To install a  
LOCAL DX Unit:**

- Connect the DX Unit to the cluster controller.
- Connect the DX Unit to the Macintosh.



**To install a  
REMOTE DX Unit:**

- Connect the DX Unit to the cluster controller.
- Connect the DX Unit to host-side modem.
- Connect the Macintosh to Macintosh-side modem.
- Open the modem-to-modem link.



- Configuration steps common to both installation types:
- Configure the DX Unit by using the MMF Checker application.
  - Select the DX CUT driver in the Avatar Control panel.

The following sections describe both sets of steps.

---

## Installing the DX Unit — LOCALLY

When you install the DX Unit locally, the DX Unit will occupy this position in the communications path:

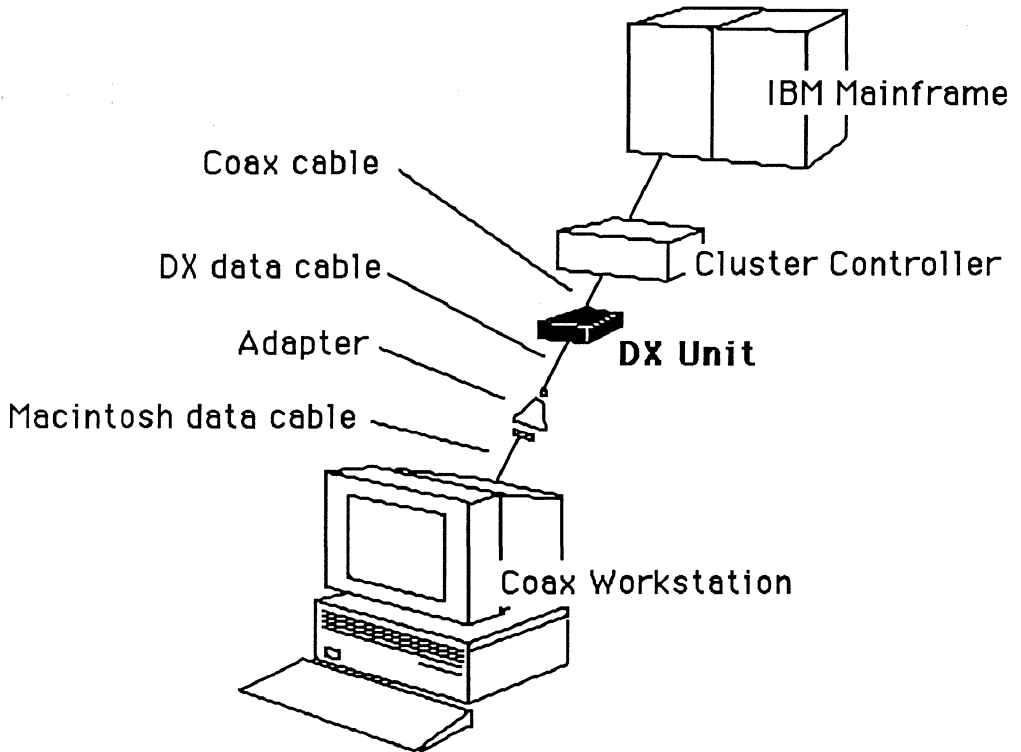

---

## 1. Power down your Macintosh.

Power down your Macintosh.

Also, make sure the DX Unit is powered down and is not plugged into AC electrical power.

## 2. Set the DTE/DCE switch.

When you're using the DX Unit **locally**, set the DX Unit's DTE/DCE switch to **DCE**:

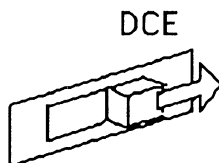

The DTE/DCE switch is on the DX Unit's back panel.



---

### 3. Connect the DX Unit to the cluster controller.

1. Connect the the coax cable to the COAX connector on the DX Unit:

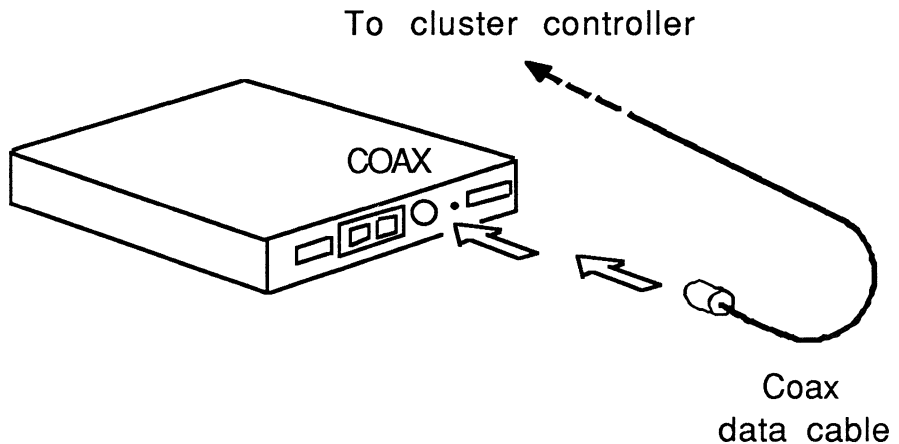

2. Connect the other end of the coax cable to the IBM cluster controller.

**This connects the DX Unit to the IBM host.**

#### Ports on the Cluster Controller

The DX Unit will connect to a port on the cluster controller.

This port must be configured for a control unit terminal (CUT). And make sure the port is configured for a terminal, as opposed to a printer.

Normally, the IBM host's system manager configures cluster controller ports.

---

#### 4. Connect the DX data cable to the DX Unit.

On the DX Unit's back panel, connect the DX data cable to the connector labeled "TERM".

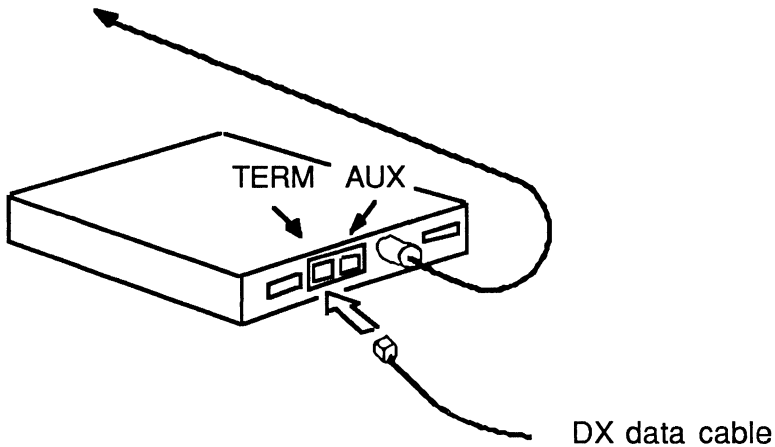

#### 5. Connect the power cable to the DX Unit.

On the DX Unit's back panel, plug the power cable into the POWER connector:

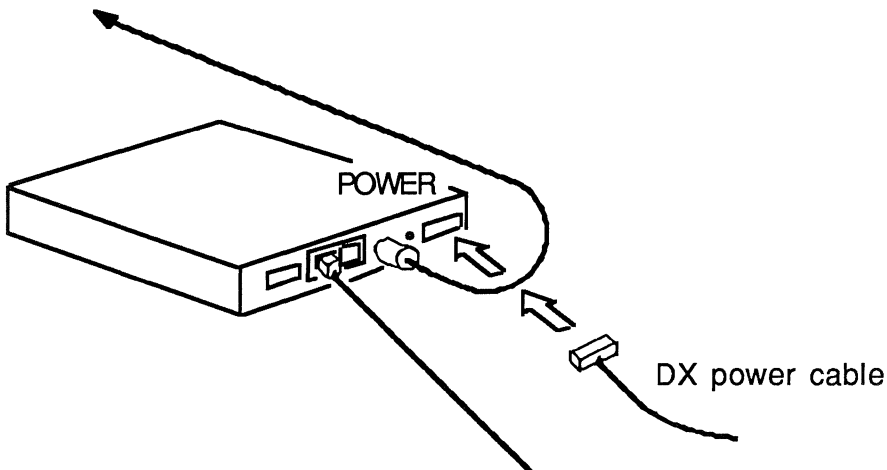

---

Your DX Unit is now fully cabled and should look like this:

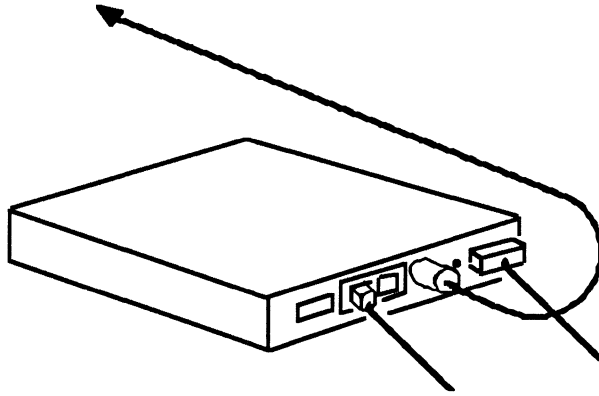

---

## 6. Connect the Macintosh data cable.

On your Macintosh's back panel, plug the Macintosh data cable into the phone port or printer port:

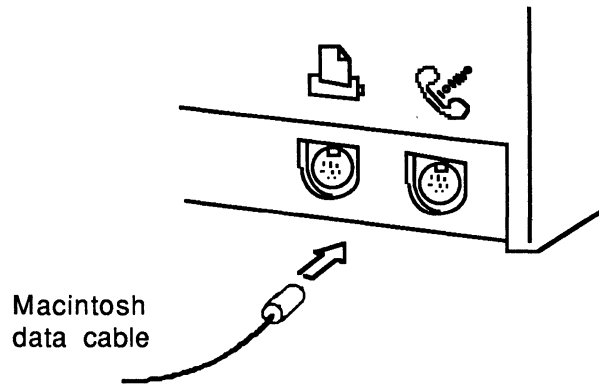

## 7. Join the data cables together.

Use the adapter provided with the DX unit to join the two data cables together:

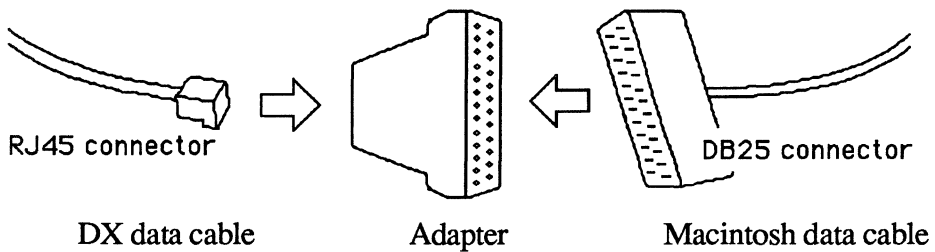

---

## 8. Power up the DX Unit.

Plug the other end of the DX power cable into AC electrical power.

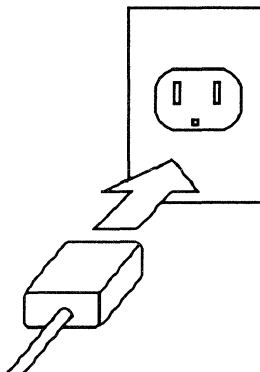

**This powers up the DX Unit.**

On the DX Unit's front panel, the POWER LED will come on.

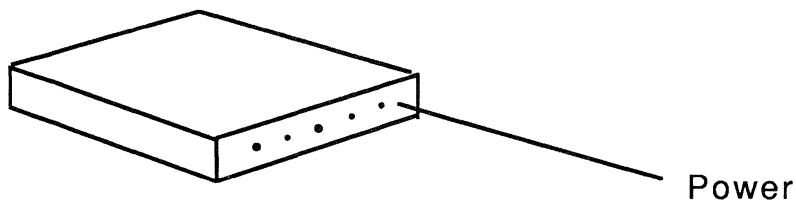

---

## 9. Reset the DX Unit.

On the DX Unit's back panel, press the RESET switch once:

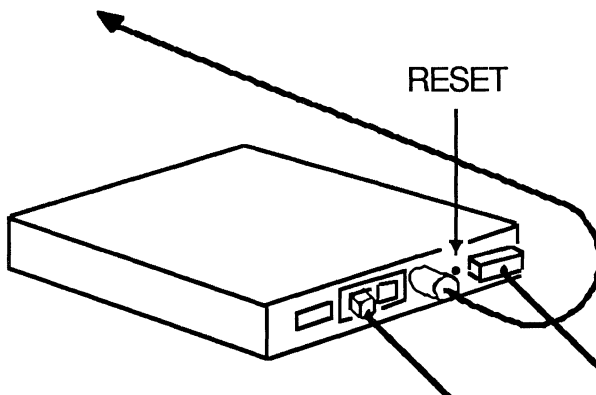

To view the DX Unit's functions, observe the lights on the front panel. (See "Using the DX Unit" later in this appendix for information on how to read the lights.)

## 10. Power up your Macintosh.

And then proceed to the section, "Configuring the DX Unit," later in this appendix.

---

# Installing the DX Unit — REMOTELY

The DX Unit will occupy this position in the communications path:

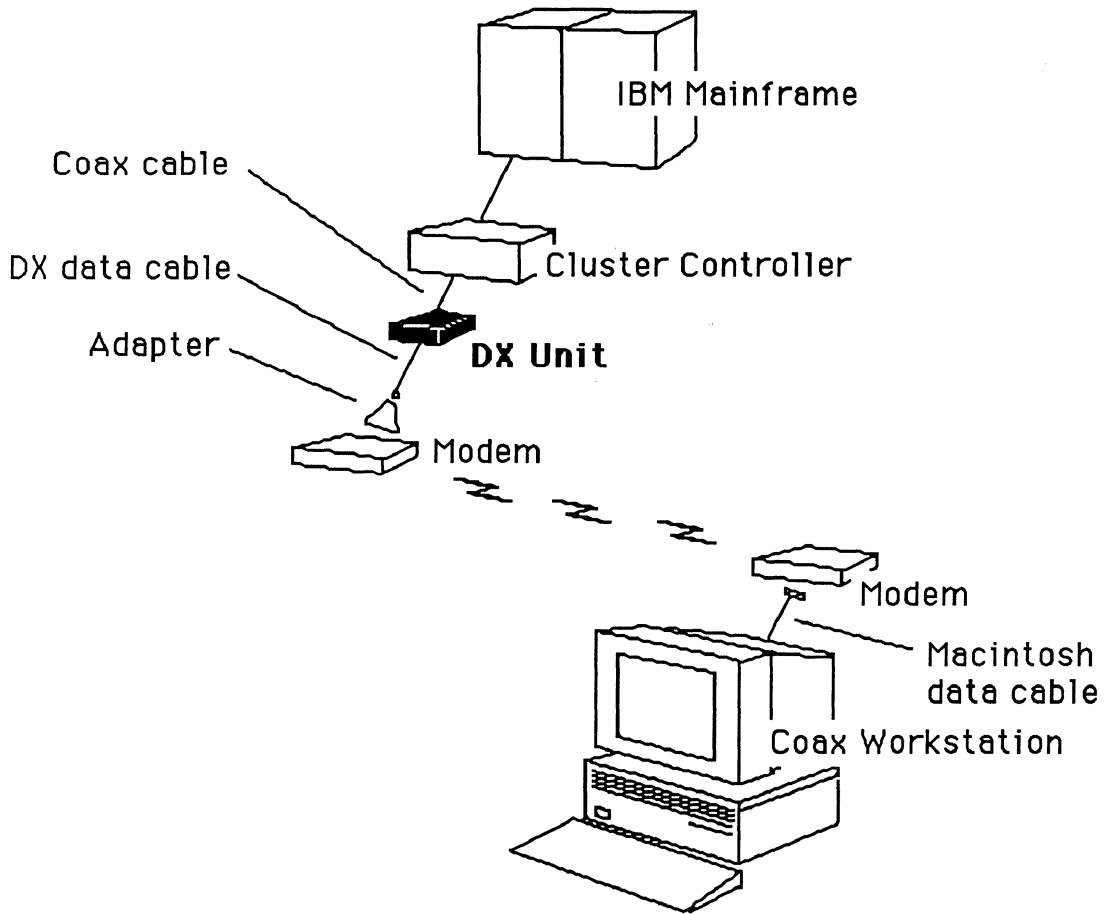

---

## 1. Power down your Macintosh.

Power down your Macintosh.

Also, make sure the DX Unit is powered down and is not plugged into AC electrical power.

## 2. Set the DTE/DCE switch.

When you're using the DX Unit **remotely**, set the DX Unit's DTE/DCE switch to **DTE**:

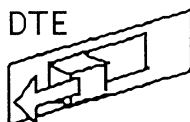

The DTE/DCE switch is on the DX Unit's back panel.



---

### 3. Connect the DX Unit to the cluster controller.

1. Connect the the coax cable to the COAX connector on the DX Unit:

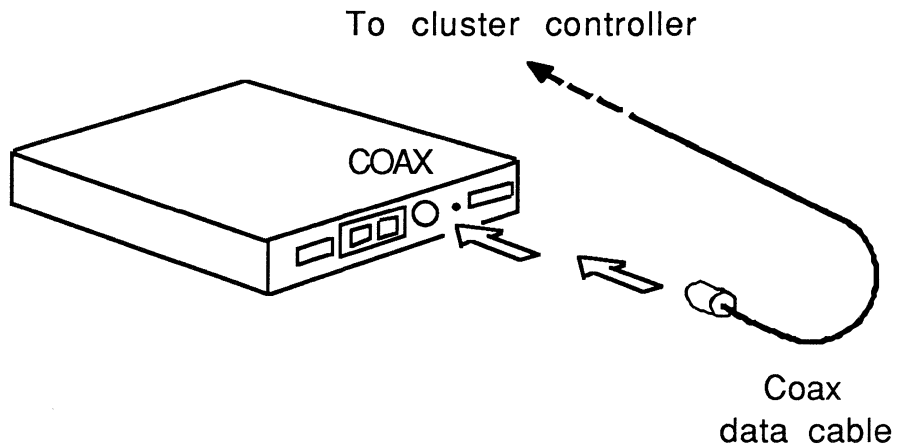

2. Connect the other end of the coax cable to the IBM cluster controller.

**This connects the DX Unit to the IBM host.**

#### Ports on the Cluster Controller

The DX Unit will connect to a port on the cluster controller.

This port must be configured for a control unit terminal (CUT). And make sure the port is configured for a terminal, as opposed to a printer.

Normally, the IBM host's system manager configures cluster controller ports.

---

#### 4. Connect DX data cable to the DX Unit.

On the DX Unit's back panel, connect the DX data cable to the connector labeled "TERM".

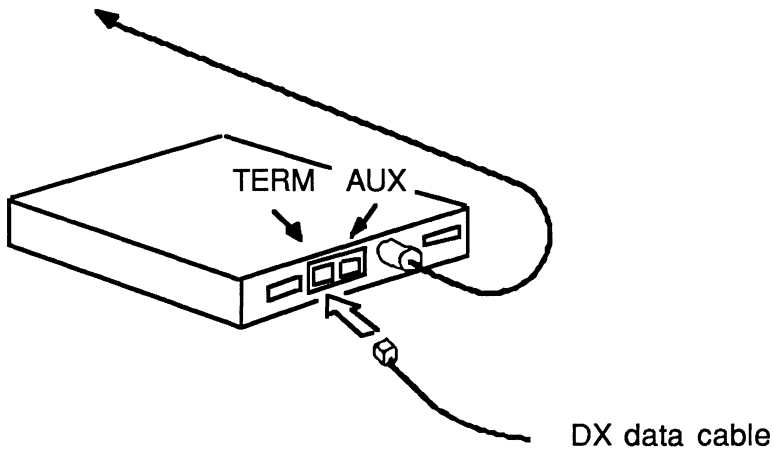

#### 5. Connect the power cable to the DX Unit.

On the DX Unit's back panel, plug the power cable into the POWER connector:

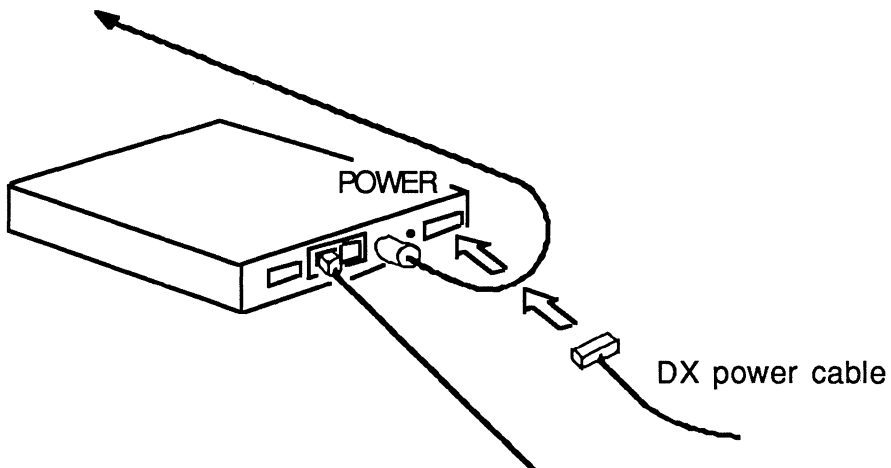

---

Your DX Unit is now fully cabled and should look like this:

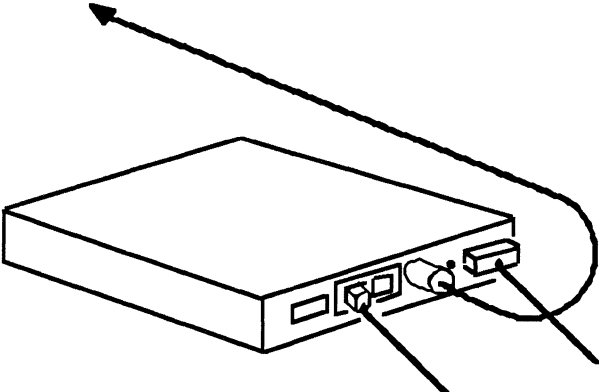

---

## 6. Connect the DX Unit to its modem.

If necessary, use the adapter provided with the DX unit to connect the data cable to the asynchronous modem that will communicate on behalf of the DX Unit.

REMEMBER: The **DX Unit is a DTE** here.

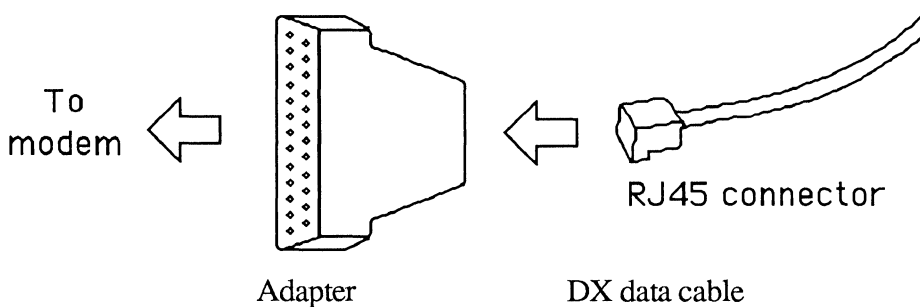

## 7. Connect the Macintosh data cable to the Macintosh.

On your Macintosh's back panel, plug the DX data cable into the phone port or printer port :

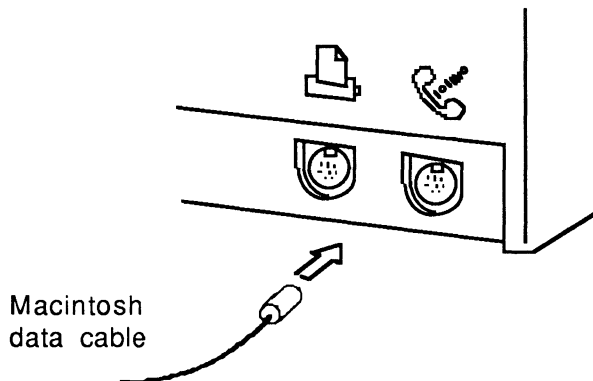

---

## 8. Connect the Macintosh to its modem.

Connect the data cable from the Macintosh to the asynchronous modem that will communicate on behalf of the Macintosh.

REMEMBER: The **Macintosh is a DTE** here.

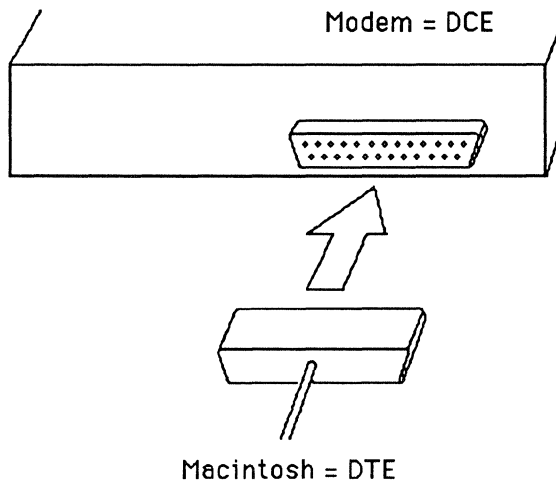

## 9. Power up the modems.

Make sure the modem link is operating properly.

---

## 10. Power up the DX Unit.

Plug the other end of the DX power cable into AC electrical power.

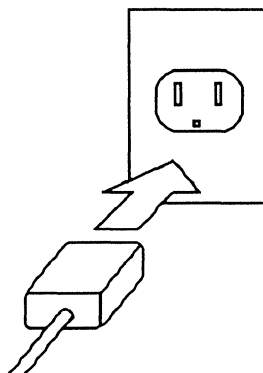

**This powers up the DX Unit.**

On the DX Unit's front panel, the POWER LED will come on.

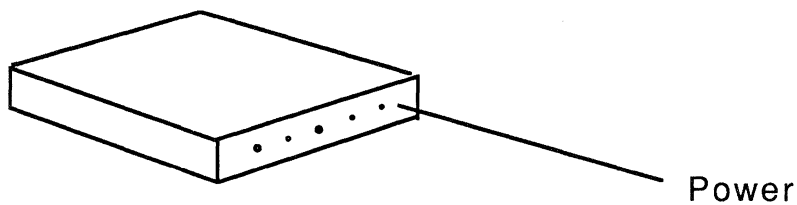

---

## 11. Reset the DX Unit.

On the DX Unit's back panel, press the RESET switch once:

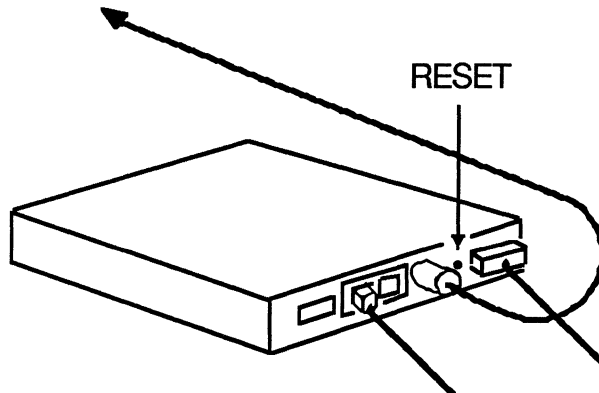

To view the DX Unit's functions, observe the lights on the front panel. (See "Using the DX Unit" later in this appendix for information on how to read the lights.)

## 12. Power up the Macintosh.

And then proceed to the section, "Configuring the DX Unit," below.

---

## Configuring the DX Unit

To configure the DX Unit, you use the Checker application.

The Checker application comes with your MMF software. Follow the steps in Chapter 3, "Installing the Workstation Software," to get the Checker installed on your Macintosh.

*The DX Unit must be connected to your Macintosh, either locally or remotely, as described in the previous sections in this chapter.*

However,

- The DX Unit can be connected or not connected to the cluster controller.
- The MMF software can be present or not present, and the DX CUT driver can be present or not present on your Macintosh.

## Using The Checker to Configure the DX Unit

The Checker application lets you contact the DX Unit and store configuration information in the DX Unit's non-volatile memory. The DX Unit uses this information whenever MMF users use the DX.

To use the Checker application to configure the DX Unit, follow these steps:

1. Make sure the DX Unit is connected to your Macintosh, either locally or remotely.
2. Open the Checker application by double-clicking on the Checker icon:



MacMainFrame Checker

The menu bar will change to the Checker's:





- 
3. Pull down the Control menu and select **Connect to DX... .**  
The Checker will now display the Serial Communications dialog box.  
Fill out the Serial Communications dialog box as described in the section below.  
**NOTE:** The information you supply in this box is for the Checker's use only; it does not affect the operation of the DX Unit or the DX driver.
  4. Pull down the Control menu and select **Configure DX... .**  
The Checker will now display the DX Configuration Settings dialog box.  
Fill out the DX Configuration Settings box as described in the section below.
  5. When you've finished filling out both DX-related dialog boxes, pull down the Checker's File menu and select **Quit** to quit the Checker.

---

## The Serial Communications Dialog Box

This dialog box lets you specify how your Macintosh will communicate with the DX Unit; it does not directly affect the way the DX Unit communicates with the IBM host.

**REMEMBER:** The information you supply in this box is *for the Checker's use only*; it *does not affect* the operation of the DX Unit or the DX driver.

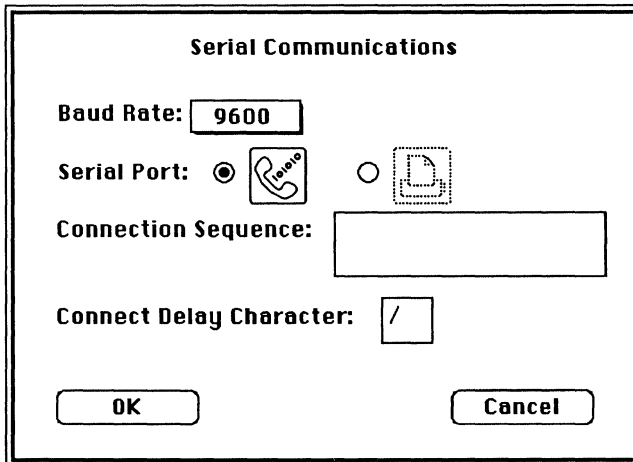

Items in the DX Configuration Settings dialog box are:

**Baud Rate:** The baud rate the Checker will use to communicate with the DX Unit.

Range: 300, 600, 1200, 2400, 4800, 9600, 19.2K

**NOTE:** 19.2K baud is available only when the DX Unit is connected to the Macintosh locally, not when it is connected remotely.

**Serial Port:** The port on the Macintosh to which your DX Unit is connected.

---

**Connection Sequence:** (Applies to remote DX Units only.) A phone number that the Macintosh should dial to reach the DX Unit. You can edit the sequence by using UPARROW, DOWNARROW, DELETE, etc.

The connection sequence is for use when the DX lies on the other side of a modem link.

Example of a connection sequence that the Macintosh might send to a Hayes-compatible modem: ATDT 1/555-1212

Where:	AT	Indicates that a command to the modem follows.
	DT	Command to the modem — requests tone dialing rather than pulse dialing.
	1	First digit for the modem to dial.
	/	Command to the Checker — Tells the Checker to delay before sending more characters to modem. (See Connect Delay Character, next item below.)
	555-1212	The remainder of the number to dial.
	-	(Ignored)

**Connect Delay Character:** (Applies to remote DX Units only.) The Checker will delay one second for each of these characters that it sees in the connection sequence. (You specify the connection sequence in the previous item.) These delays are useful when the Macintosh must wait for the DX Unit's modem to answer its phone.

In the above example, the connect delay character is a slash (/).

---

## The DX Configuration Settings Dialog Box

The DX Configuration Settings dialog box lets you supply basic information about how the DX should communicate with the host. It also lets you set passwords for using the DX Unit and for changing its parameters.

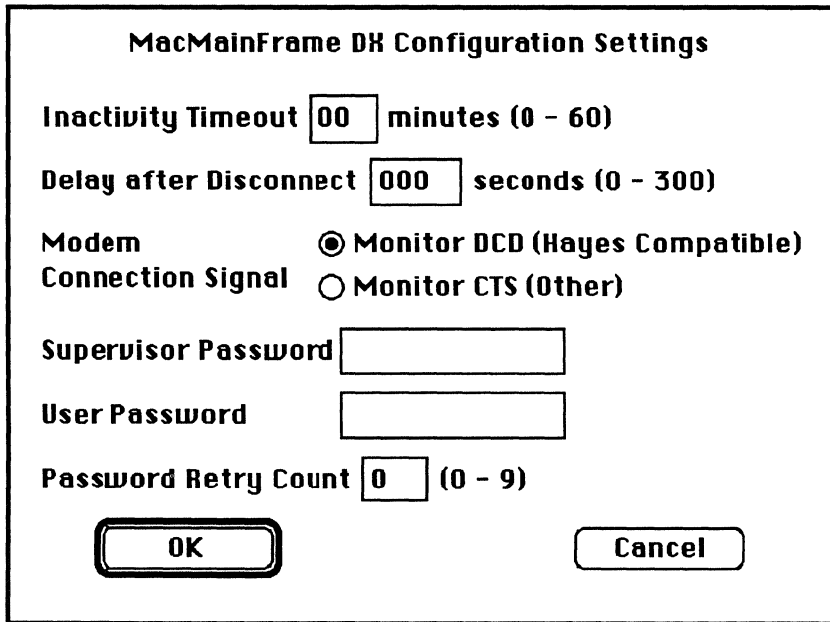

The dialog box is titled "MacMainFrame DX Configuration Settings". It contains the following fields and controls:

- Inactivity Timeout**: A text box containing "00" followed by "minutes (0 - 60)".
- Delay after Disconnect**: A text box containing "000" followed by "seconds (0 - 300)".
- Modem Connection Signal**: Two radio buttons. The first is selected and labeled "Monitor DCD (Hayes Compatible)". The second is labeled "Monitor CTS (Other)".
- Supervisor Password**: A text box.
- User Password**: A text box.
- Password Retry Count**: A text box containing "0" followed by "(0 - 9)".
- Buttons**: "OK" and "Cancel" buttons at the bottom.

Items in the DX Configuration Settings dialog box are:

**Inactivity Timeout** After the time period expires during which there is no activity on the Workstation (activity here means either the user typing at the keyboard or the IBM host updating the Workstation's 3270 screen), the DX will release the LU session to the IBM host.

0 (zero) means the DX Unit will never time out.

**Delay after Disconnect** The DX will delay this amount of time until it makes itself available for use, following:

- 
- A disconnect that results from the user exceeding the password retry count,
  - A disconnect that results from the user releasing the LU session,
  - A disconnect that results from the user quitting out of the MMF application, or
  - An inactivity timeout.

Delay after Disconnect is also useful for modems that require some time to reset themselves after disconnects.

0 (zero) means no delay.

**Modem Connection Signal** Causes a remote DX Unit to listen for and interpret data that arrives on the RX data line from its modem, as follows:

- **Monitor DCD (Hayes Compatible)** Remote DX Unit will listen for and interpret data that arrives on the RX data line from its modem.
- **Monitor CTS (Other)** Remote DX Unit will *not* listen for or interpret data that arrives on the RX data line from its modem.

**Supervisor Password** A password that a network administrator must supply in order to use the Checker to configure the DX.

Range: Up to 8 alphanumeric ASCII characters; case-sensitive.

**User Password** A password that a user must supply in order to use the DX Unit to communicate with the IBM host.

Range: Up to 8 alphanumeric ASCII characters; case-sensitive.

**Password Retry Count** After this number of retries, the DX Unit will wait according to its delay after disconnect period before making itself available again.

---

This feature allows the DX Unit to pause after multiple erroneous dial-ins to resist attempts to guess its password.

---

## Software for the DX Unit

When you're using a DX Unit with your MMF Coax Workstation, *you must use a special driver*, called DX CUT:



This driver will run on all Macintosh hardware platforms that support MMF Coax Workstation.

Install the driver the same way you install the drivers for non-DX-unit Coax Workstations. (See Chapter 3 for details.) Briefly:

1. Make sure the DX CUT driver is in your system folder.
2. Make sure the DX CUT driver is selected in the Avatar Control Panel.
3. Restart your Macintosh at least once after you select the driver and before you open the MacMainFrame Workstation application.

## Using the DX Unit

The DX Unit requires no operating procedures other than to power it up and power it down. The configuration data you supply remains in the DX Unit's non-volatile memory across power-downs.

**REMEMBER**, before you use the DX Unit, make sure the DX driver in your Macintosh's Avatar Control Panel is selected and your Macintosh has been restarted once since then.

---

To view the DX Unit's functions, observe the lights on the front panel:

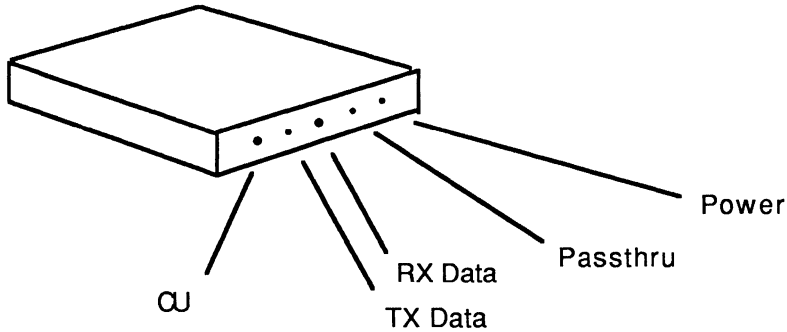

<u>Light</u>	<u>Meaning</u>
CU	Control Unit. When ON solidly, indicates that the DX Unit is connected to a host.
TX Data	Transmit Data. Indicates that the DX Unit is currently transmitting data to the Macintosh.
RX Data	Receive Data. Indicates the DX Unit is currently receiving data.
Passthru	Pass Through. When FLASHING, indicates the DX Unit is waiting for data.  When FLASHING slowly (and the CU light is also FLASHING slowly), indicates that data is in transit through the DX Unit between the MMF machine and the IBM host .
Power	Indicates the DX Unit is powered on.





# Index

## A

- Armon
  - Icon 54
- Armonk™ font
  - Icon 54
- Avatar
  - Control Panel document 37
    - Icon 51
  - Icon 40
  - Lock panel 55
  - Panel 40, (See also Control Panel)
    - Lock panel 41

## B

- Batch file
  - Icon 53
- Baud Rate
  - In Serial Communications box (DX Unit) 83
- BNC connector
  - On Macintosh II 27, 30
  - On Macintosh SE 15, 16, 24, 29
  - On Macintosh SE/30 21, 29

## C

- Cables
  - External 6
    - Attaching 29
    - How to attach 29
  - For DX Unit 62, 67, 69, 75, 77
  - For Macintosh SE 10
  - For Macintosh SE/30 18
  - Internal
    - Installing 12, 21

- Checker application 49, 81
  - Icon 51
- Cluster controllers 31, 66, 74
  - Ports 31, 66, 74
- Coax
  - BNC connector 15, 16, 21, 24, 27
  - Cables
    - Attaching to Macintosh II 30
    - Attaching to Macintosh SE 29
    - Attaching to Macintosh SE/30 29
  - Drivers 42
- Connect Delay Character
  - In Serial Communications box (DX Unit) 84
- Connection Sequence
  - In Serial Communications box (DX Unit) 84
- Connectors
  - BNC
    - On Macintosh II 27, 30
    - On Macintosh SE 15, 16, 24, 29
    - On Macintosh SE/30 21, 29
  - Coax
    - On DX Unit 66, 74
  - Expansion 11
    - Macintosh II 27
    - Macintosh SE/30 20
  - J2 12
  - J3 22
- Control Panel 39
  - Avatar panel 40
  - Closing 46
- CU (Light on DX Unit) 89

## **D**

- Delay after Disconnect
  - In DX Configuration Settings box 85
- Dialog boxes
  - DX Configuration Settings 85
  - For DX Unit 83
  - Serial Communications 83
- Diskettes
  - MMF Workstation software 35

- Dragging files to System Folder 36
- Drivers
  - Checking with MMF Checker 50
  - Coax 37, 42
  - DX CUT 88
  - Icons 52
  - Mac II DFT 42
- DTE/DCE switch
  - On DX Unit 65, 73
- DX Configuration Settings dialog box 85
- DX CUT 88
- DX Unit 61
  - Configuring 81
  - DTE/DCE switch 65, 73
  - Installing 63
- LEDs
  - CU 89
  - Passthru 89
  - POWER 70, 79, 89
  - RX Data 89
  - TX Data 89
- Software 88
- Switches
  - RESET 71, 80

## **E**

- External cables 29
  - Attaching to Macintosh II 30
  - Attaching to Macintosh SE 29

## **F**

- Folders
  - System 36

## **G**

- Graphics 43

## **H**

### Hardware 3

Checking with MMF Checker 50

Installation 7

Macintosh II 25

Macintosh SE 9

Macintosh SE/30 17

How to attach external cables 29

How to install MMF Workstation hardware 7

How to install MMF Workstation software 33

## **I**

### IBM host 1, 6

Connecting MMF Workstation to 31

Connectivity to 6

DX Unit communicating with 85

### Icons 51

At start-up 36, 47

Avatar 40

Avatar Panel 37

Bad start-up 48

### Inactivity Timeout

In DX Configuration Settings box 85

### Internal cables

For Macintosh SE 12

For Macintosh SE/30 21

## **J, K**

J2 connector (Macintosh SE motherboard) 12

J3 connector (Macintosh SE/30 motherboard) 22

## **L**

Language panel 45

Lock panel 41, 46, 55

LU panel (In Avatar panel) 43

LU sessions 43

Changing  
From Terminal to Printer to Graphics 43  
Configuring cluster controller for 31

## **M**

Mac II DFT 37, 42  
Macintosh 1  
    Machines 3  
    Restarting 47  
    System 6.0.3 5  
Macintosh II  
    Attaching external cable to 30  
    Installing hardware into 25  
Macintosh SE  
    Installing hardware into 9  
Macintosh SE and SE/30  
    Attaching external cable to 29  
Macintosh SE/30  
    Installing hardware into 17  
MacMainFrame (See also MMF)  
MMF 3287 43  
    Icon 54  
MMF Checker 49, 51, 81  
MMF Graphics 43  
MMF Workstation  
    Diskette 35  
    Hardware 3  
    Hardware installation 7  
    Icon 53  
    Icons 51  
    Installing 38  
    Software  
        Diskettes 35  
        Software installation 33  
Modem Connection Signal  
    In DX Configuration Settings box 86  
Modems  
    In DX Configuration Settings box 86  
Monitor CTS (Other)  
    In DX Configuration Settings box 86  
Monitor DCD (Hayes Compatible)

- In DX Configuration Settings box 86
- Motherboards
  - Macintosh II 27
  - Macintosh SE 14
  - Macintosh SE/30 20

## **N, O**

- Networks 6

## **P, Q**

- Panels
  - Avatar 40
  - Control 39
  - Language 45
  - Lock 41, 46
  - Macintosh Control Panel
    - Closing 46
- Passthru (Light on DX Unit) 89
- Password Retry Count
  - In DX Configuration Settings box 86
- Passwords 55
- Ports
  - On cluster controllers 31, 66, 74
- POWER LED (DX Unit) 70, 79, 89
- Print Settings documents (MMF 3287)
  - Icon 54

## **R**

- Read Me - Workstation 35
- RESET switch (DX Unit) 71, 80
- Restarting
  - Macintosh 47
- RX Data (Light on DX Unit) 89

## **S**

- Security 55
- Serial Communications dialog box 83

- Serial Port
  - In Serial Communications box (DX Unit) 83
- Session Settings document
  - Icon 53
- Software 5
  - Basic requirements 5
  - For DX Unit 88
  - Installation 33
- Standoffs (hardware)
  - For SE board 11
- Start-up
  - Bad 48
  - Icons at 36, 47
- Supervisor Password
  - In DX Configuration Settings box 86
- Switches
  - DTE/DCE (On DX Unit) 65, 73
- System Folder 36

## **T**

- Terminals
  - CUT (Control Unit Terminals) 31, 61, 66, 74
  - DFT (Distributed Function Terminals) 31, 61, 66, 74
- Terminology 1
- TX Data (DX Unit) 89

## **U, V**

- User Password
  - In DX Configuration Settings box 86

## **W, X, Y, Z**

- What you need first 1
- Workstation
  - Connecting to IBM host 31







65-2500-101-AA

AVATAR CORPORATION  
65 South Street, Hopkinton, MA 01748