



ALTOS 580 Computer System

Operator's Guide

**ALTOS 580 COMPUTER SYSTEM
OPERATOR'S GUIDE**

**Altos Computer Systems
2641 Orchard Parkway
San Jose, CA 95134**

**THE INFORMATION IN THIS DOCUMENT IS SUBJECT TO
CHANGE WITHOUT NOTICE. NEW EDITIONS OF THIS
DOCUMENT WILL INCORPORATE CHANGES AS THEY ARE
PUBLISHED.**

Copyright ©1984. All rights reserved. Altos Computer Systems.

ALTOS Manual Number: 690-13890-003

January 1984

ACKNOWLEDGEMENTS

ALTOS is a registered trademark of Altos Computer Systems.

CP/M is a registered trademark, and MP/M II is a trademark of Digital Research, Inc.

OASIS is a trademark of Phase One Systems, Inc.

Z80 is a trademark of Zilog, Inc.

FEDERAL COMMUNICATIONS COMMISSION NOTICE

W A R N I N G

This equipment generates, uses and can radiate radio frequency energy and, if not installed and used in accordance with the instructions manual, may cause interference to radio communications. It has been tested and found to comply with the limits for a Class A computing device pursuant to Subpart J of Part 15 of FCC Rules, which are designed to provide reasonable protection against such interference when operated in a commercial environment. Operation of this equipment in a residential area is likely to cause interference in which case the user, at his own expense, will be required to take whatever measures may be required to correct the interference.

VIDEO MONITOR INTERFERENCE NOTICE

If you are not using an Altos terminal with your 5-1/4 inch Altos Computer System, disk errors can occur when the terminal is placed within 12 inches of the disk drive unit. Signals generated by some low cost terminals sometimes cause these errors. This is an industry-wide problem and is not unique to Altos' computer systems.

The problem is easily solved, however; simply move your terminal at least 12 inches away from the disk drive unit. Data files can be restored by following your operating system's backup and restore procedure.

TABLE OF CONTENTS

PREFACE:

ABOUT THIS MANUAL

USING THIS MANUAL	v
DOCUMENTATION CONVENTIONS	viii
CHANGING INVALID DATA	ix
OTHER INFORMATION AVAILABLE	x
Altos Family of Related Manuals	x
Other Vendor Manuals	x

INTRODUCTION:

1. ABOUT YOUR ALTOS COMPUTER

INTRODUCTION	1-1
GENERAL DESCRIPTION OF THE ALTOS 580	1-2
What the Altos 580 Does	1-2
How the Altos 580 Works	1-2
BASIC HARDWARE	1-3
What Is a CPU?	1-3
What Is a Terminal?	1-4
What Is a Printer?	1-5
Putting It All Together	1-6
UNDERSTANDING COMPUTERS	1-7

2. ABOUT SOFTWARE

SOFTWARE CATEGORIES	2-1
SYSTEM VERIFICATION (DIAGNOSTICS)	2-2
OPERATING SYSTEMS	2-3
TWO CATEGORIES OF OPERATING SYSTEMS	2-4
SINGLE-USER ONLY OPERATING SYSTEMS	2-4
Control Program Monitor (CP/M)	2-4
MULTI-USER OPERATING SYSTEMS	2-4
Multi-Program Monitor (MP/M II)	2-5
OASIS	2-6
UTILITIES	2-7
LANGUAGES	2-8
COMMUNICATIONS	2-8
APPLICATION PROGRAMS	2-8

3. ABOUT OPTIONS

DESCRIPTION OF THE OPTIONAL UPGRADE	
KIT (UK-10) HARD DISK UPGRADE	3-2
KIT (UK-40) HARD DISK UPGRADE	3-2
KIT (MTU-6) MAGNETIC TAPE UNIT	3-2

4. CUSTOMER-SUPPLIED ITEMS

TABLE OF CONTENTS

SETTING UP:

5. SETTING UP	
SELECTING A COMPUTER SITE	5-2
A COMPLETE ALTOS 580 SYSTEM	5-4
Items Purchased from Altos	5-4
The User Supplies	5-4
6. CONNECTING THE TERMINAL	
Connecting the Cable	6-1
Connecting to Power	6-1
Selecting Switch Settings	6-3
7. CONNECTING THE PRINTER	
Connecting the Serial Printer Cable	7-1
Connecting the Parallel Printer Cable	7-2
Connecting to Power	7-2
Selecting Switch Settings on Serial Printers	7-2

OPERATING INSTRUCTIONS:

8. TURNING ON YOUR SYSTEM	
PREPARING THE SYSTEM	8-1
TURNING ON POWER TO THE ALTOS 580	8-2
9. HANDLING FLOPPY DISKETTES	
Diskette Insertion	9-1
Diskette Write-Protection	9-2
Saving Original Diskettes	9-2
Labelling Diskettes	9-2
Storing Diskettes	9-2
Further Reading	9-3
10. TESTING THE SYSTEM	
SYSTEM TESTS	10-1
AUTOMATIC SYSTEM TESTING	10-2
OPERATOR TESTING	10-3
AN OVERVIEW OF THE DIAGNOSTIC PROGRAM	10-4
Summary of Diagnostics and Utilities	10-5
11. TURNING OFF YOUR SYSTEM	

TABLE OF CONTENTS

MAINTENANCE :

12. PREVENTIVE MAINTENANCE

13. TROUBLESHOOTING PROCEDURES

USER TROUBLE-SHOOTING PROCEDURES	13-1
TERMINAL	13-1
No Screen Display	13-1
No Cursor Display	13-2
No Response to Keyboard Input	13-2
POWER UP	13-3
No Fan	13-3
No Floppy Diskette Drive Light	13-3
PRINTER	13-4
No Response	13-4
Interruptions	13-4
DIAGNOSTIC PROCEDURES ERROR	13-5
OPERATING SYSTEM ERRORS	13-5
CLOSE-DOWN ERRORS	13-5
PROGRAM ERRORS	13-5

14. MONITOR ERROR MESSAGES

APPENDIXES :

A. SYSTEM SPECIFICATIONS

SYSTEM CONFIGURATIONS	A-1
PHYSICAL DESCRIPTION OF THE ALTOS 580	A-2
FEATURES AND CAPABILITIES	A-3
POWER SUPPLY IDENTIFICATION	
CONVENTIONS	A-4

B. WARRANTY INFORMATION

WARRANTY	B-1
SHIPPING DAMAGE INSPECTION	B-3
REPAIR AND SERVICE PROCEDURES	B-4
ALTOS FACTORY REPAIR PROCEDURES	B-5

C. CABLES, TERMINALS, AND PRINTER INTERFACE CONFIGURATIONS

INTERFACE CONFIGURATIONS	C-1
TERMINALS	C-2
RS-232C Terminal Cabling	C-2
Standard Terminal Connection	C-4
SERIAL PRINTERS	C-6
PARALLEL PRINTERS	C-7

TABLE OF CONTENTS

GLOSSARY

INDEX

FIGURES

1-1	Typical Altos 580 with Terminal(s), Printer	vi
5-1	Diagram of Computer Site	5-3
6-1	Altos 580 Front and Rear Panels	6-2
9-1	Diskette Handling	9-4
C-1	Male Connector, RS-232C Cable	C-3

TABLES

C-1	RS-232C Pinning Instructions	C-4
C-2	Altos to Anadex (Serial)	C-6
C-3	Altos to Epson MX80 F/T (Serial)	C-6
C-4	Parallel (Centronics) Interface Connector	C-7

Preface: About This Manual

USING THIS MANUAL

This manual introduces you to the Altos 580 computer system. It guides you through the steps for setting up and installing your computer system. Other manuals in this set will give you complete details of the operating system and applications software, such as the word processing package, business packages, and communications.

To use this manual most effectively, follow these steps:

1. Read this Preface to learn how to enter data and make corrections from your terminal keyboard, and for referral to additional sources of information.
2. Follow the instructions for setting up in Chapter 5.
3. Connect your terminal(s) in accordance with directions in Chapter 6.

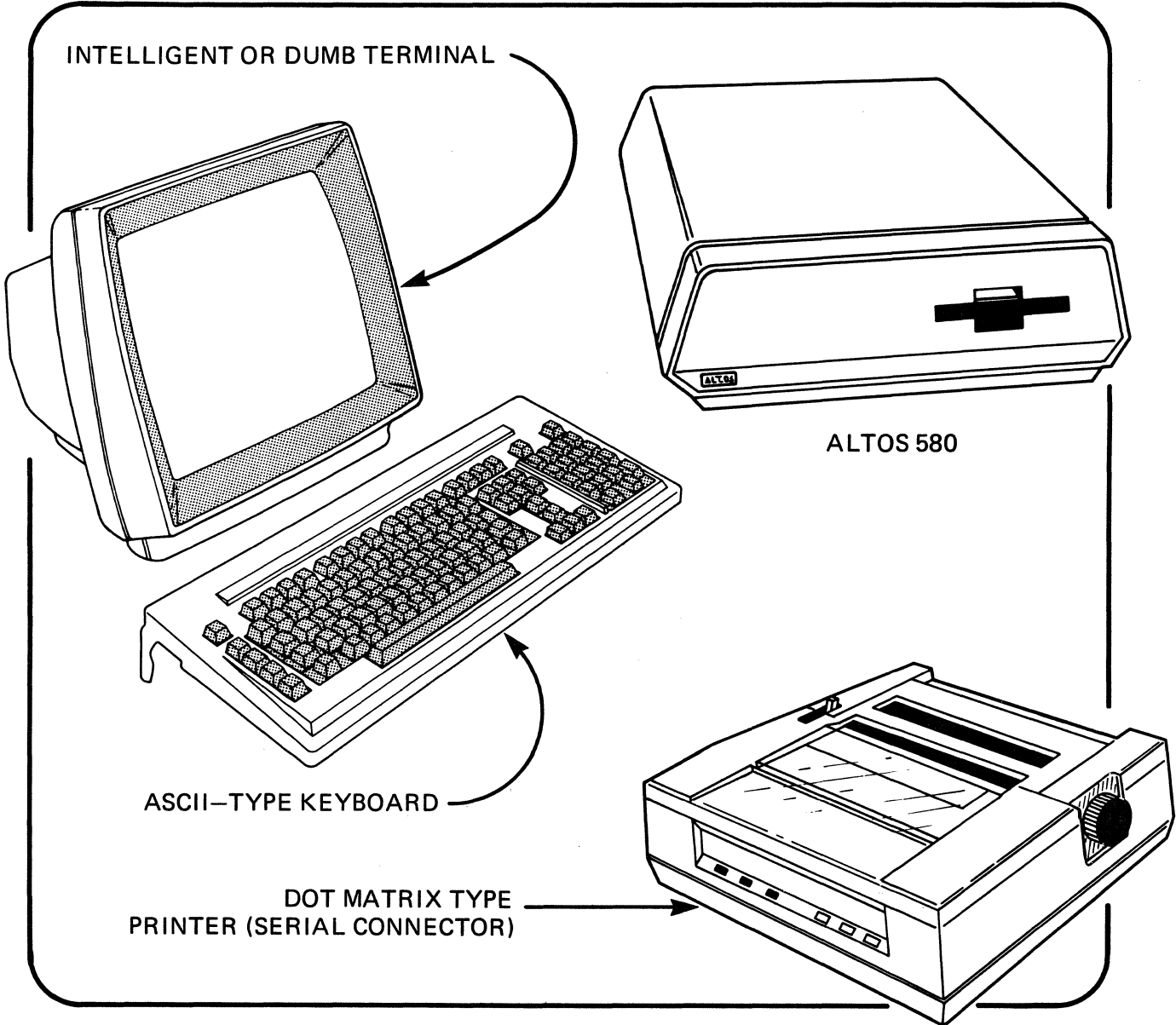

Figure 1-1: Typical Altos 580 with Terminal(s), Printer

4. Follow instructions in Chapter 7 for connecting printers. For specific details on printer functions, see the appropriate Operating System Manual.
5. Read Chapter 8 for instructions about turning on the system.
6. Read Chapter 10 for information on the automatic test procedure which runs when the system is turned on. When the tests described in this section have been completed, you are then ready to install the operating system. Refer to the Operating System Manual for the next steps.

One of three operating systems (MP/M II, CP/M or OASIS) can be installed. Each of these systems has its own loading procedures and operating characteristics. Some operating systems also have their own set of diagnostic programs. Instructions for the version you have purchased with your system, such as **Introduction to CP/M**, follow this Operator's Guide.

7. After you have tested the system, refer to Chapter 11 for instructions on turning it off.
8. The final section of this manual addresses the issues of maintenance and troubleshooting.

DOCUMENTATION CONVENTIONS

This manual follows certain conventions to indicate how data should be entered from your terminal keyboard. These conventions also correspond to the way information or queries may be displayed on the terminal screen.

Some entries require only one keystroke before the command or response is executed, i.e., as soon as you press one key, the computer begins a response. Other commands--especially those which require a string of characters or numbers--must be followed by a carriage return. Pressing the carriage return enters the data from the screen to the computer where it is acted upon.

A carriage return may be indicated either as "Carriage Return," "Return," or "<CR>."

Some operations require the use of a Control key. That is, you must press the Control key and hold it down while pressing another specified key. On the keyboard, the key may appear as CONTROL, CONTRL, or CTRL. In documentation, a control sequence may be indicated as Control-X, Cntrl-X, or <X>.

In this manual, data that you will enter is shown in bold face. For example, **Y**. Note that often the entry is abbreviated to the first letter. An alternate way is to name the key, such as "Press the Escape key." When a control key is specified, the key name is capitalized. Some examples are as follows:

Press the Return key.

Reply **Y<CR>** or **N<CR>**.

Select **l<CR>** for continuous display.

Most applications accept upper- and lower-case data entries interchangeably. For example, in the DIAGNOSTIC PROGRAM either **memtest<CR>** or **MEMTEST<CR>** is acceptable. However, some commands and entries, especially for operating systems, are specific as to the form and format of the data. Check the instructions in your software manuals.

CHANGING INVALID DATA

If you type incorrect information on the screen, but have not "entered" the data (i.e., have not pressed the Return key), you may correct or cancel the data. The following conventions are generally valid across operating systems. The representative examples that follow are taken from the DIAGNOSTIC PROGRAM.

- (1) To erase the last character typed: Depending on your keyboard, use the Backspace key or Cntrl-H, which are identical. With the Delete (or Rubout) key the erased character may be "echoed." That is, when a letter is deleted, the screen displays it back to you. To see the true entry if the erasure is echoed, use Cntrl-R.
- (2) To erase the whole entry, use Cntrl-X.

OTHER INFORMATION AVAILABLE

The **Altos 580 Operator's Guide** and the **user's guide** for the selected operating system are included with the system purchased from Altos. There are additional manuals and references which will assist you in understanding and operating your Altos 580. Some of these manuals are provided by Altos since they may refer to related items which Altos may manufacture or provide. Other manuals and documents are passed along from outside vendors to the purchaser if they directly pertain to parts or systems adapted for Altos' use.

Altos Family of Related Manuals

System Reference Manual: This manual gives the functional details of the Altos 580, including both hardware and software. Detailed specifications are given for the CPU, system memory, input and output, and controllers. The System Reference Manual is for advanced technicians and programmers and can be ordered from Altos.

Field Service Manual: This manual gives the principles of operation of the Altos 580 along with test and troubleshooting procedures. The manual specifies the diagnostic operations and software and includes a parts list. It includes the cabling diagrams, disassembly, reassembly and repair. The Field Service Manual is for use by service technicians who perform field repairs.

System Maintenance Manual: This manual is provided to qualified dealer and distributor technicians with sufficient information to permit them to repair or replace system hardware components, and to conduct tests to verify efficient system operation.

Operating System Manual: This manual describes the operating system under which your system will operate. It gives step-by-step installation procedures, and also introduces you to the supporting manuals and other publications related to that operating system.

Other Vendor Manuals

MP/M II: This operating system (developed by Digital Research, Inc.) is the multi-user version of CP/M and is compatible with programs developed under CP/M. It is supplied with a series of manuals which consists of the **User Guide**, the **Programmer Guide**, and the **System Guide**. Altos supplies these manuals to every purchaser of the MP/M II operating system to be used in conjunction with the **Altos Introduction to MP/M Manual**.

CP/M: This operating system (developed by Digital Research, Inc.) is supplied with a series of manuals which consists of the **User Guide**, the **Programmer Guide**, and the **System Guide**. Altos supplies these manuals to the purchaser of every CP/M operating system; they accompany the **Altos CP/M Operating System Manual**.

OASIS: This operating system (developed by Phase One Systems, Inc.) is supplied with a **System Reference Manual** provided by Altos, along with the **Altos OASIS Operating System Manual**.

About Your Altos Computer 1

INTRODUCTION

This section presents a general description of the Altos 580 and introduces you to some of the computer basics--hardware, software, and computer concepts. It also describes the optional upgrade kit (UK) and items that you need to supply in order to run your Altos 580.

GENERAL DESCRIPTION OF THE ALTOS 580

What the Altos 580 Does

The Altos 580 is a desk-top microcomputer system which handles up to three individual users simultaneously. It is compact, very powerful, and fast.

Four models of the Altos 580 are available:

MODEL NO.	DESCRIPTION
580-2	Dual 5-1/4 inch floppy drives
580-10	10 MB hard disk; 1 floppy drive (special order)
580-20	15 MB hard disk; 1 floppy drive
580-40	35 MB hard disk; 1 floppy drive

The Altos 580 runs a number of operating systems, has wide business applications, and has optional communications facilities.

How the Altos 580 Works

The 580 computer system is a Z80A-based multi-user system designed to fit many commercial, technical, industrial, scientific, and educational applications. It can run under either CP/M, MP/M II, or OASIS operating systems. The basic computer system includes the CPU, four RS-232C ports, one parallel port, 192 kilobytes of RAM, one (or two) 5-1/4 inch floppy disk drives with a controller, and, if you do not have a dual floppy drive, either a 10- or 15-megabyte 5-1/4 inch hard disk drive, and hard disk controller. The basic configuration of the 580 computer system is contained in a single chassis. An additional chassis (Upgrade Kit) may be added to the basic chassis to increase system capabilities. You have to add a keyboard terminal and provide your own floppy diskettes and cabling. You may also want to add a printer.

The 580 also supports a variety of peripherals such as CRT terminals, printers, and communications (networking) facilities.

BASIC HARDWARE

The CPU, terminal, and printer make up your basic Altos computer system. If you are a new computer "user" (anyone who uses a computer is known as a "user"), take some time to become acquainted with the instructions in this manual. With basic precautions it is unlikely that you will do any damage to the system. Most new users err by being too timid. What is more vulnerable than the hardware discussed above is the software. You will more than likely lose some data; this is a fact of computer life. There are means by which to protect yourself in case the computer goes "down," or is temporarily unavailable. Refer to the Handling Floppy Diskettes chapter of this manual and to the section on formatting diskettes and saving files in the Operating System manual.

What Is a CPU?

The Central Processing Unit, or CPU, might be likened to the "brain" or "heart" of the computer system. The CPU is central to your system; every other part of your system is referred to as "peripheral."

Technically, the CPU in your Altos 580 is a printed circuit board. By generalization, the term CPU also means the "box" that receives and stores information, or data, as directed. The CPU acts upon data as requested, and displays the results on your terminal or prints the results on your printer.

Your Altos 580 CPU looks like the drawing below. It may have one or two floppy drives and may or may not have a built-in hard disk.

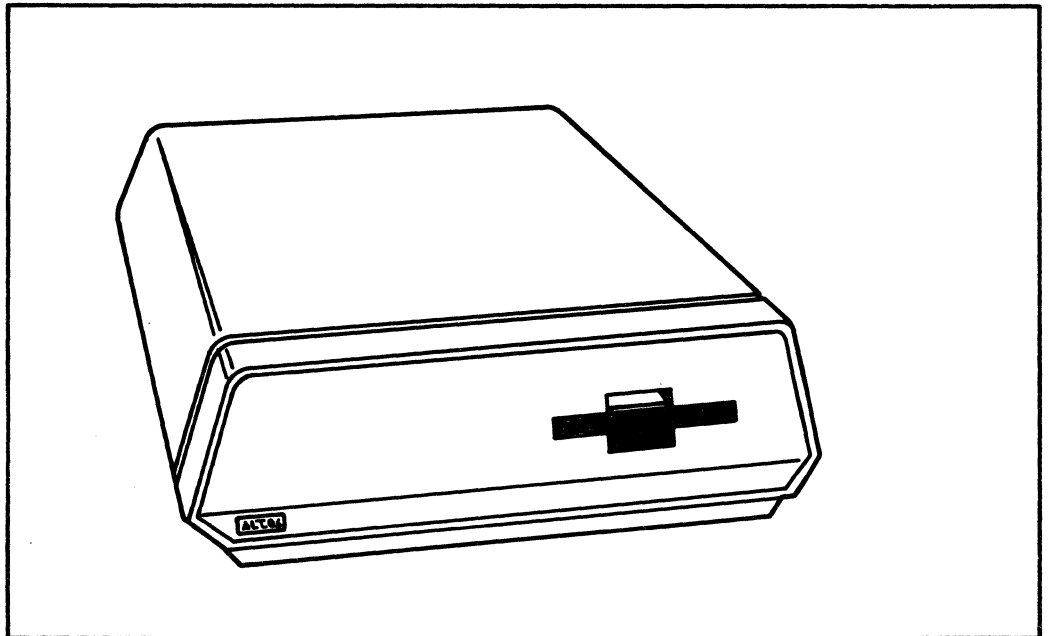

The CPU consists of an Arithmetic Logic Unit (ALU), a control unit, main storage (or memory), and registers. The ALU can operate on a pair of numbers; it can add, subtract, multiply, or divide these numbers. The ALU can also compare the two numbers to determine if they are equal or if one is greater than the other. The ALU works on data that has been brought out of main storage, or memory, and has been placed in registers. Registers temporarily hold the data. The ALU performs all arithmetic and logic operations on data in the registers of the microprocessor.

The control unit supervises the functioning of the whole machine. It receives instructions from a program one by one in sequence. The control unit interprets the instructions and sends appropriate control signals to the various units. For example, if data needs to be brought into memory from a disk drive, or if results are to be printed, the controller makes these events happen.

Main storage, also known as memory, holds both data and program instructions. Programs are brought into memory from an input device (a terminal or floppy diskette). Data is stored on floppy diskettes, hard disks, or tape. When the data is to be operated upon by the ALU, it is transferred to the appropriate register.

What Is a Terminal?

You can enter data, such as text, or instructions and data via a Video Display Terminal, a VDT, or terminal. This has a typewriter keyboard and a screen. Below is a sketch of a typical terminal.

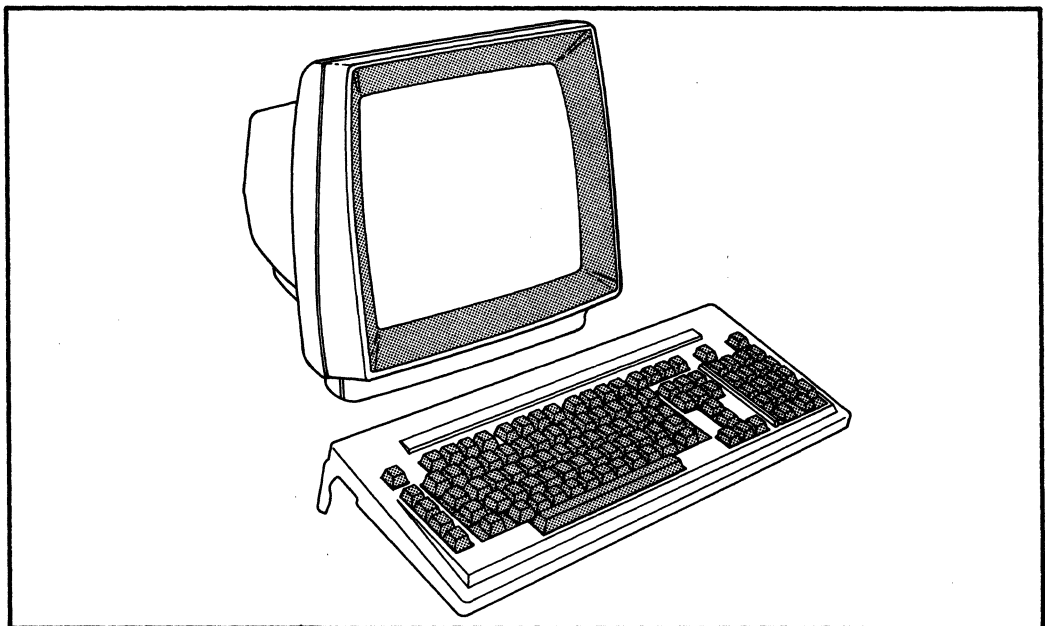

If you do not need "hard copy," which means a printout on paper, you can display the results of your computer session on the terminal. For example, you enter text from the keyboard which displays on the screen. You have a program that formats the text, but before you have the text printed on paper, you display the re-arranged text on the screen exactly as it will appear on paper. Suppose you find an error. You can correct it via the terminal and prevent having to throw away the first printout.

What Is a Printer?

When you want a record of your computer session, you request a printout. Standard printers are one of two types--serial or parallel. Parallel printers are generally faster because they transfer data units (such as a byte) as a unit. Serial printers transfer a byte one bit at a time. Your processing needs determine which kind of printer is right. A typical printer looks like this:

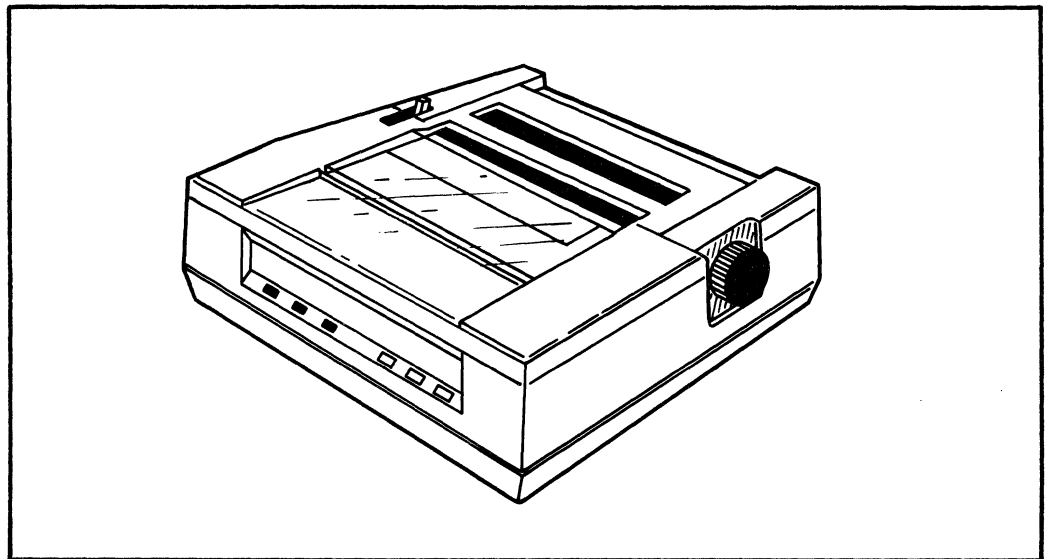

Print quality may or may not be important. If you are producing text that is to be "camera ready" for printing, you need a letter-quality printer. (Characters are produced by one stroke of a letter template against the ribbon as on a typewriter.) If you simply need readable copy, which can also be high quality, a dot-matrix printer is a less expensive option. (Characters are produced by a series of points that press against that ribbon to make up the letter.)

Putting It All Together

The terminal and printer connect to the CPU via cables. Refer to the following chapters for information on completing your system: Connecting the Terminal, Connecting the Printer, and Customer Supplied Items.

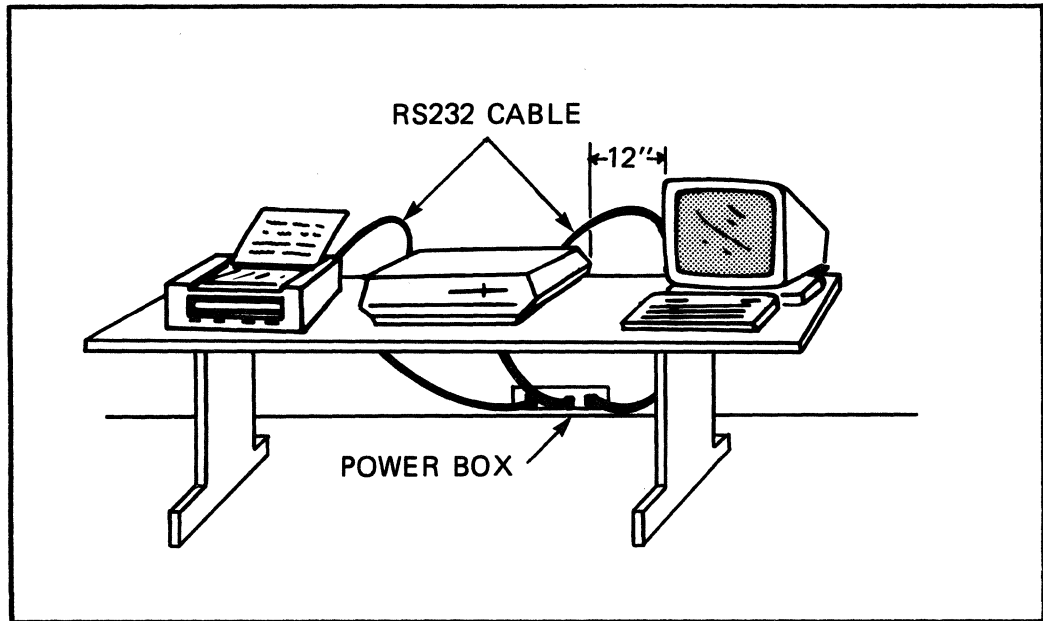

UNDERSTANDING COMPUTERS

If you are unfamiliar with computers, the following analogy is intended to give you a general understanding of how computer systems work and what they do. The analogy introduces some frequently used concepts and terms.

You will find computers are clearly defined devices and that the operations they perform are simple. The complexity arises from the fact that computers seem to perform many different tasks---and very quickly. In fact, the computer does three basic tasks: it calculates, it remembers, and it communicates. All other operations are variations of these three.

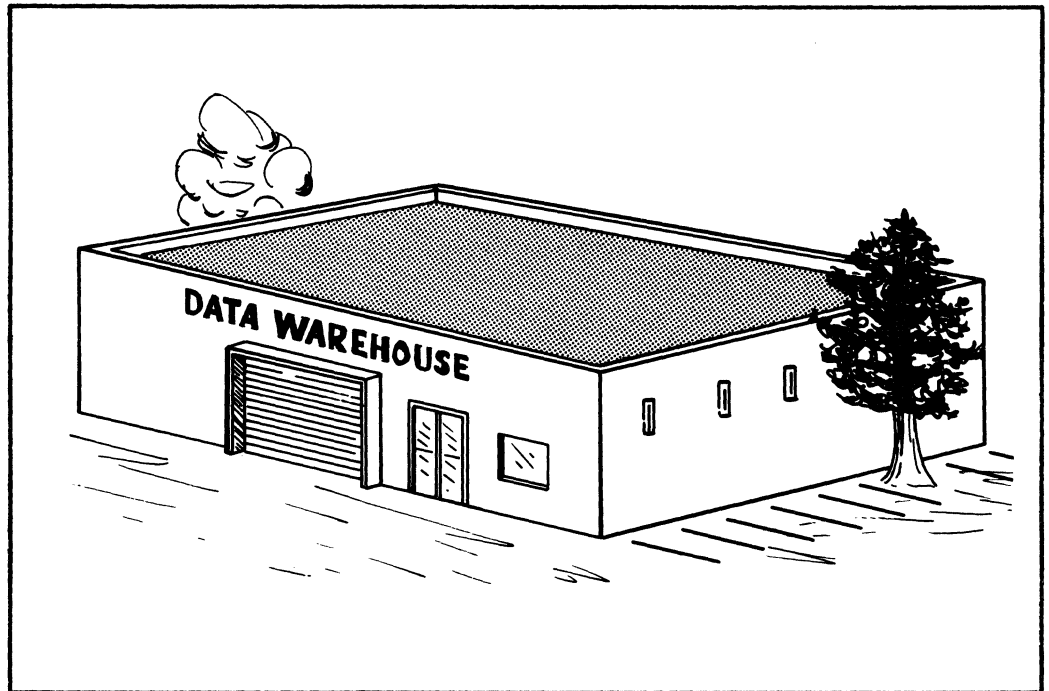

The computer system is like a large warehouse and a warehouseman. Someone comes to the window and gives the warehouseman a box of information. He takes this and carefully stores it in an empty slot laid out on the floor, and then he marks its location on his card. Later, if the person comes back to the window and wants the information back, the warehouseman looks on his card and goes to the place where the box is stored and gets it.

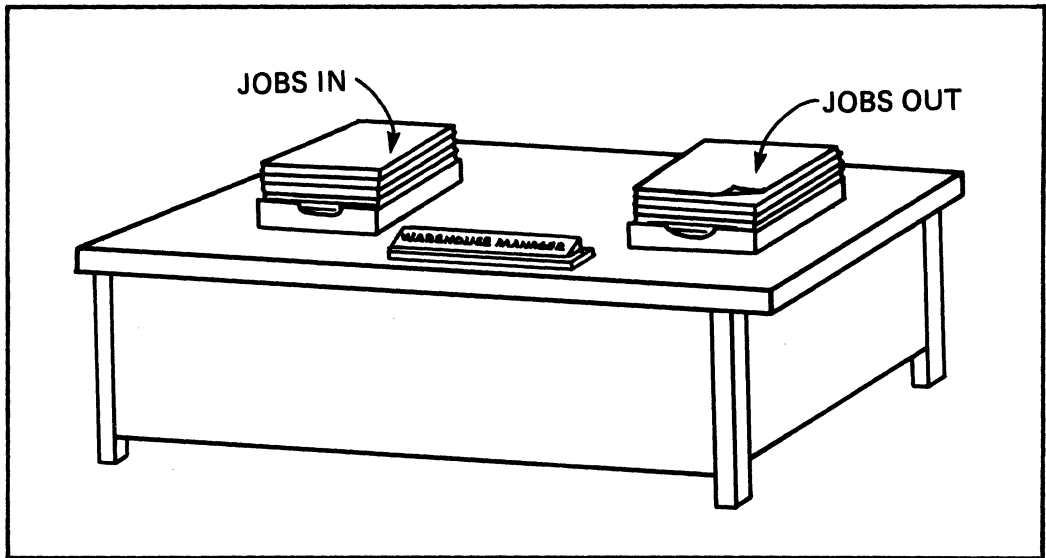

The computer itself is likened to the warehouse, and the instructions for how it is to function are likened to the warehouseman. In computer terms, this set of instructions is called the operating system. It is the warehouseman's routine operations which he knows all about and can perform quickly when the customer tells him what he wants. The operating system and other sets of instructions are called software. The physical parts of the computer, likened to the warehouse, its shelves, closets, and even office equipment are called hardware.

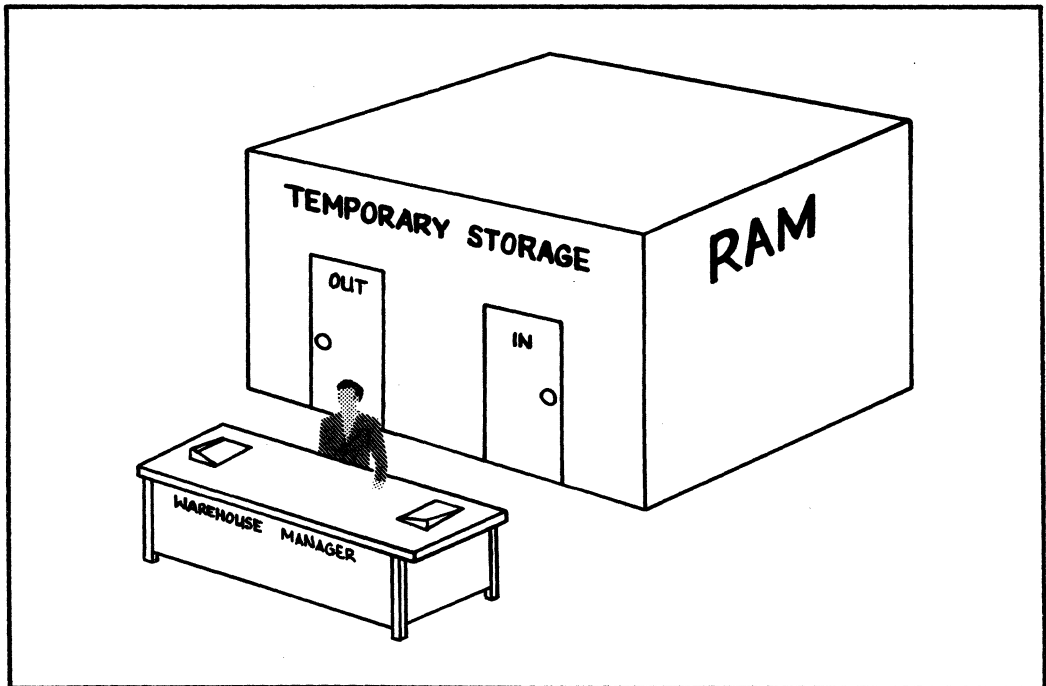

The computer handles information in a way analogous to the operation of the warehouse. One addition to our picture would be if a room were added in back of the warehouseman's window. This is where he stores items he has just received or that he is working on. That way, if someone wanted his information right back, the warehouseman would not have to go very far or search very much for the right items. This working room is like the computer's electronic holding room called RAM (Random Access Memory), where the information is temporarily stored while it is being manipulated. When the box of data is transferred to the warehouse floor or shelves or closets, this is likened to the computer concept of mass storage. Mass storage in a computer is accomplished on various media: hard disks, floppy disks, magnetic tape, etc. Each medium is different from the others in how much data it can store, how fast it can retrieve data, and in what format the data is received.

Data can be moved from RAM to mass storage and from mass storage to RAM, but it can only be manipulated in RAM, the computer's electronic holding (operating) room. Both these types of storage constitute the computer's memory. A computer is rated on how much short-term memory (RAM) it has, how much long-term memory (mass storage), and how quickly it can retrieve information. A microcomputer may be like a small, one story warehouse, and a large computer (mainframe) may be compared to a multi-story warehouse of vast floor space on each level. In spite of its size and complexity, a mainframe can generally manipulate data many times faster than a microcomputer.

Sometimes a person will show up at the counter with some papers to be duplicated, and the warehouseman will ask "do you want these now or later?" or he might even say "I'm busy now, I'll have that for you in a short time." At which point he'll either make the copies right then, or do them as he has time. This may involve copying only a few pages at a time. The computer handles information in the same way. If the customer is the only client the warehouse has, the warehouseman always has time to process the customer's requests. But if there are several clients (multi-users), there may be different strategies for handling their contending requests. The warehouseman may overlap the work as in the case of the copying, or he may prioritize jobs by assigning each client a number or order of processing. If the warehouseman is very good at his job, the client may not even know that his job is being delayed or being done intermittently.

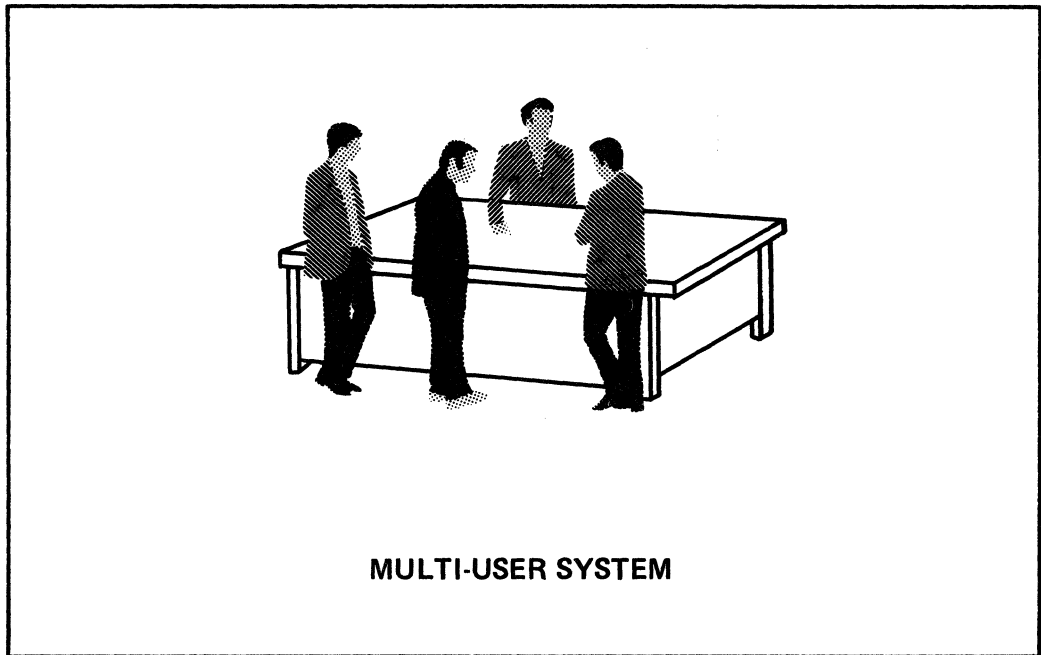

If the warehouse is very sophisticated, it may have an entire staff so that staff members can do different jobs at the same time. In computer parlance, this is known as parallel processing.

There will be times when a person comes with several boxes or one large box of information which will not fit in the warehouse's orderly layout. At that time the warehouseman repackages the contents of the large box into standard sized boxes; he neatly labels each of these smaller boxes with the contents and sequence. On the other hand, for several boxes which can't be placed together, he makes a note of where each one is and which others they go with.

In addition, the variety of customer requests at the counter can be very large. Sometimes the customer doesn't want the warehouseman to look in the box of data, just mechanically store or re-store information ('put this box with those two boxes'), but other times he will ask the warehouseman to look in the box and manipulate the papers or the information on the papers. The client (or in the case of computers, the operator) can request that his papers be duplicated, alphabetized, destroyed, rearranged, truncated, extended, renamed, searched for particular patterns, formatted, split, etc. It all depends on the capability of the warehouseman (operating system).

An operating system may even have file security, like a vault in a warehouse, so that sensitive information may be locked away. The client can instruct the warehouseman: 'let no one have access to this but me.' The client can also specify others who may have access to the information, or he may designate a password so that only those bearing the proper password may have access.

If the client has some special task to perform that the warehouseman is unfamiliar with, the client will have to write out step-by-step instructions. The computer term for this is programming. It is important that these steps are clear and exact. Otherwise, our very precise warehouseman will not be able to carry them out in the way intended.

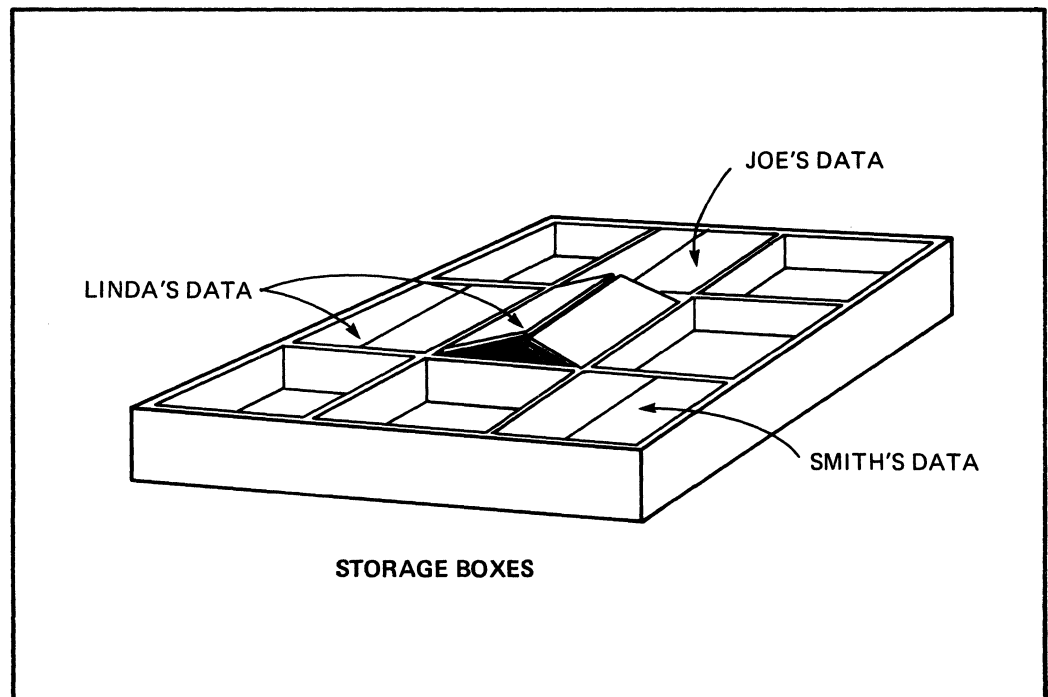

It is also important for the program to be written in a language (and dialect) that the warehouseman understands. Each warehouseman (operating system) understands different languages: BASIC, PASCAL, FORTRAN, etc. Some understand many languages and some know few.

A particular language itself may have several variations---just like dialects of a language. BASIC, for instance, has many versions. To our warehouseman, one dialect may be comprehensible and others not.

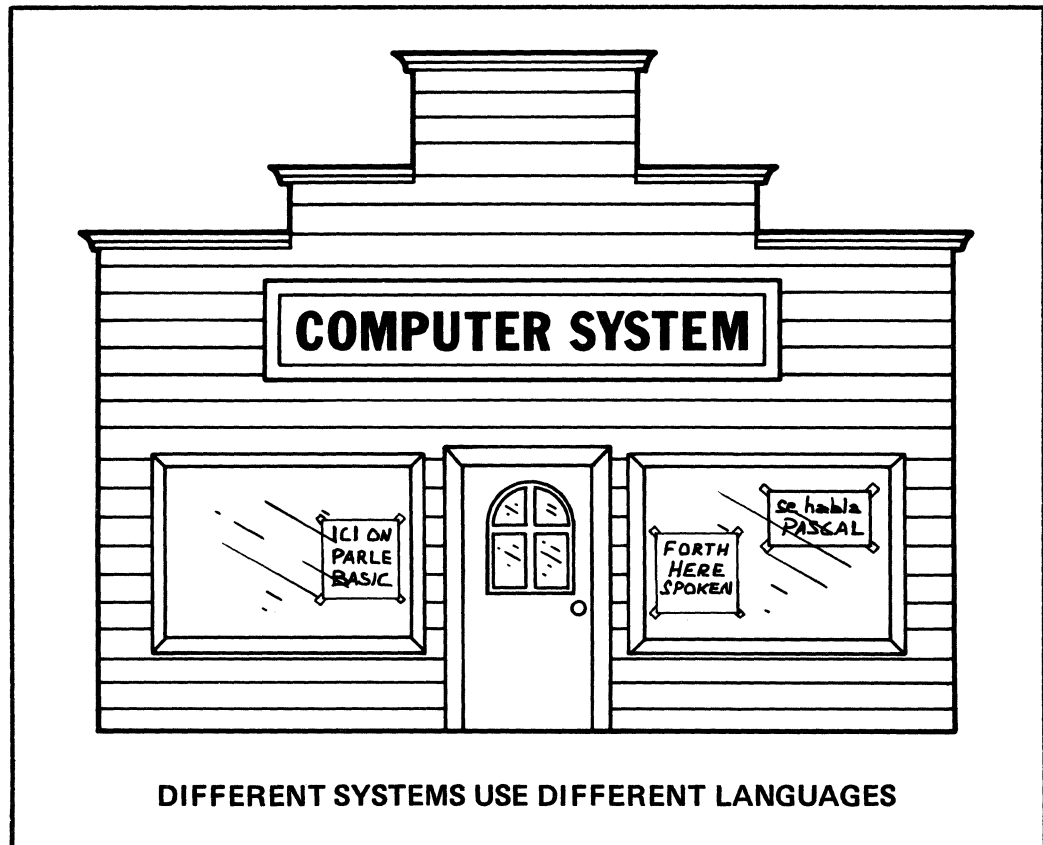

When the warehouseman comes to work in the morning, he has a specific sequence of duties he must perform in order to prepare the warehouse for operation. For instance, he may turn off the security alarm, turn on the lights and heat, check the time, day and date, sign himself in, do some bookkeeping, and he may turn on and check the office equipment. When he opens the counter, the client has access to his services. This same way an operating system will go through a start-up or initializing routine: it checks the computer and its peripherals for proper functioning and prepares it for the day's operation. On the other hand, at the end of the day, there are routines to be followed to insure that the warehouse is locked up properly. Similarly, an operating system may have many things to do when the system is to be shut down.

For our warehouseman, there is a lot of office equipment (peripherals) to help him do his job: telephones, typewriter, duplicaters, even video screens. These he uses to handle information. He handles data as incoming or outgoing, i.e., as Input or as Output. Input to the warehouseman is either a box of data or instructions as to what to do with it (or both). Output is either a box data or a report on its status (or both).

The client telephones (input) and says (instructions) that he has an order for processing. He may later bring the order in (input) which consists of a box of information (data). On the other hand, the warehouseman may use his telephone (peripheral) to call the client (output: report), and say 'Your order is ready.' When the client shows up, the warehouseman gives the client the data (output).

For computers, there are many peripheral devices which handle input. Examples of these are keyboards, light pens, digitizers, and joysticks. Some peripherals that handle output are terminals, plotters, and printers.

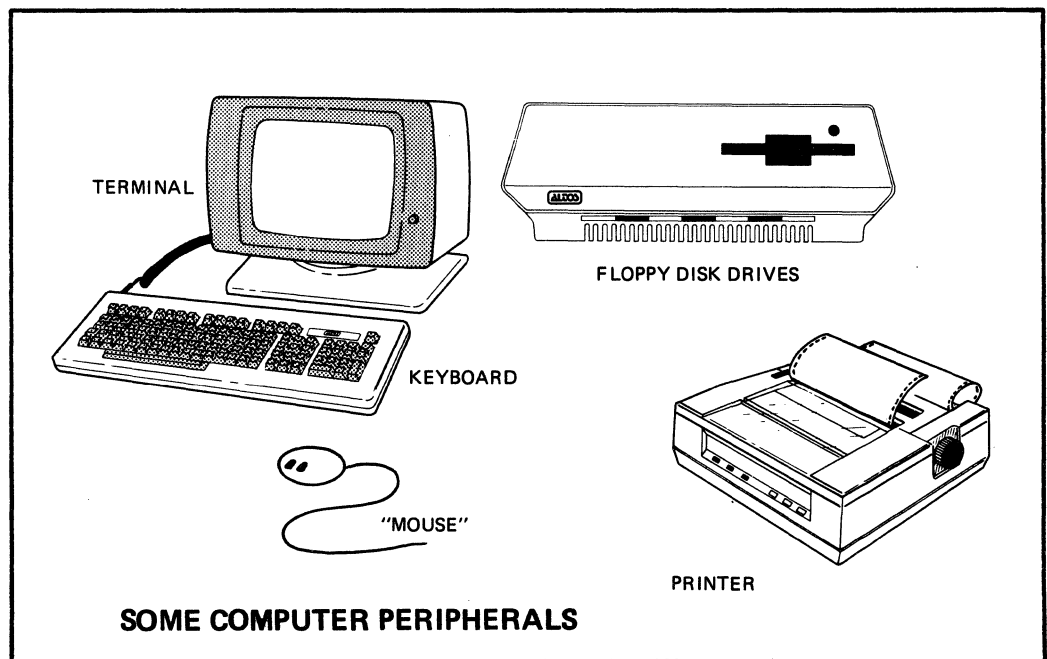

As to the warehouse, we have taken a tour through it to understand computers. We have seen many parallels as to how items (data) are received, manipulated, stored, and returned. Our understanding of the role of the warehouseman gives us a good appreciation of how the operating system works.

With this theoretical background, we are now prepared to handle the functional steps of daily operation of the computer.

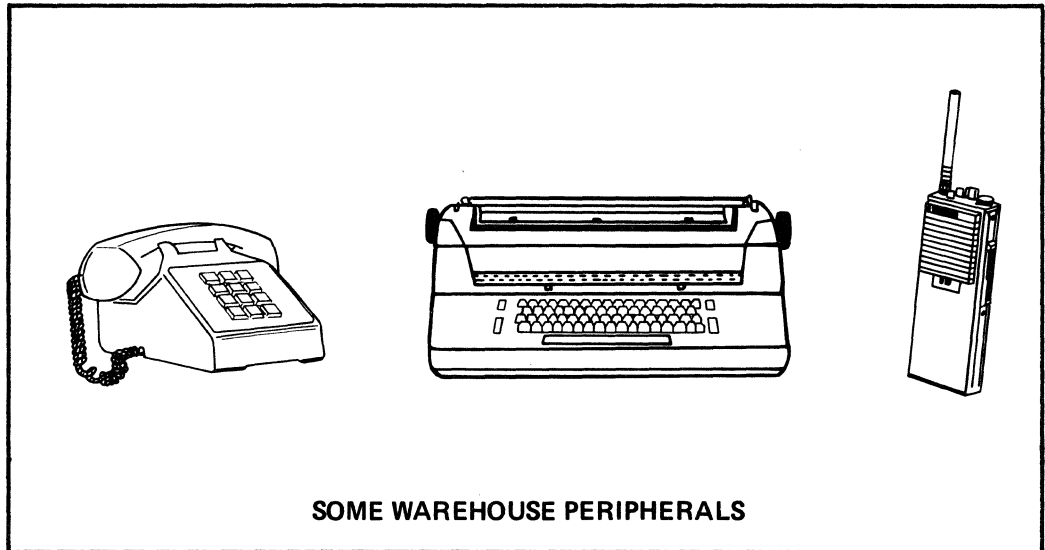

About Software 2

SOFTWARE CATEGORIES

There are different categories of software used to make your system work. This chapter discusses five of those categories: diagnostics, operating systems, utilities, applications, and languages. Although these divisions are somewhat arbitrary, they are intended to give a basic picture of how software works within your computer system.

SYSTEM VERIFICATION (DIAGNOSTICS)

System verification or diagnostic testing is discussed in Chapter 10. These are the tests that verify that all of the parts of your computer hardware are functioning properly. System verifications may be of two types: those which run automatically, and those which an operator must perform. The Altos 580 uses both types of tests. The first type ensures that the basic system gets a brief check-out each time the computer is turned on, and the second type allows the operator to run more comprehensive diagnostics if that is necessary.

The resident (or system) monitor is a program which permanently reside in system memory, stored in PROM (Programmable-Read-Only-Memory).

When the system is turned on, the monitor tests memory components. It tests all but a small portion of memory. Each memory byte is tested individually by writing a test pattern to it and then reading the contents of the memory byte to verify correctness of function. This test is run twice on each memory byte.

When the memory test has finished running, the system is then ready to have the Diagnostic Program installed. Should the system fail during the Power-Up diagnostics, the process can be restarted by removing the diskette and turning the system off and then on again. If the problem persists, refer to procedures outlined in Appendix B, Warranty Information.

OPERATING SYSTEMS

The Altos 580 supports three operating systems: CP/M, MP/M II, and OASIS.

Each of these operating systems will be discussed in this section. A detailed discussion of the particular operating system is found in the Operating System Manual. Only the manual for the operating system (or systems) purchased is provided.

Each manual gives specific, step-by-step installation procedures for one particular operating system, and also introduces you to the supporting manuals and other publications related to that operating system.

One of the three operating systems is to be installed. Each of these systems has its own loading procedures and operating characteristics and may have certain additional utility programs associated with it.

TWO CATEGORIES OF OPERATING SYSTEMS

Operating systems that run on the Altos 580 can be divided into two categories: those that handle single users only and those that handle multiple users (one or more). CP/M is the only single user operating system that Altos supports for the 580, while the others--MP/M II and OASIS are multiple-user systems.

SINGLE-USER ONLY OPERATING SYSTEMS

Control Program Monitor (CP/M)

CP/M is a single-user general-purpose operating system designed especially for microcomputer systems that use the the Z80 or Z80A microprocessor.

CP/M is an efficient and powerful operating system that has time-tested modular design. CP/M can support application programs that range from small to complex.

There are four modules within CP/M that perform the necessary control and house-keeping functions. These are BIOS (the Basic Input Output System), which provides the primitive operations necessary to access disk drives and to interface with standard peripherals. BDOS (the Basic Disk Operating System) which provides disk management and file organization, the CCP (the Console Command Processor) which serves as the link between the user terminal(s) and the rest of CP/M and, finally, the TPA (the Transient Program Area) which holds programs that are loaded from the disk(s) under command from the CCP.

MULTI-USER OPERATING SYSTEMS

From one to three users can operate the Altos 580 at a given time. In order to handle different tasks and system demands, special kinds of operating systems are required. These multi-user operating systems keep track of files, programs, and priorities within the system. The Altos 580 supports two popular multi-user operating systems: MP/M II and OASIS.

These operating systems will be discussed in this section. A detailed discussion of the particular operating system is found in the Operating System Manual. Only the manual for the operating system (or systems) purchased is provided.

Each manual gives specific, step-by-step installation procedures for one particular operating system, and also introduces you to the supporting manuals and other publications related to that operating system.

One of the two Operating Systems is to be installed. Each of these systems has its own loading procedures and operating characteristics and may have certain additional utility programs associated with it.

Multi-Program Monitor (MP/M II)

MP/M II is compatible with the CP/M operating system. Software that has been developed under CP/M can be upgraded to run with full compatibility under MP/M II, the Altos 580 version of that operating system. MP/M II provides record and file locking with password protection for use in settings where data base integrity is essential.

MP/M II supports up to sixteen logical drives managing upto 512-Kilobytes each. MP/MII features extensive error handling and reporting, real-time capabilities, and date and time stamps on files.

OASIS

OASIS is a multi-user operating system that is designed to run on Z80 based microcomputers. OASIS is composed of the following modules and utilities:

- o **NUCLEUS** consists of programs that manage system resources such as scheduling, and memory. Associated with the NUCLEUS are device driver programs that control the activity of a specific peripheral device. These device drive programs are responsible for the input and output of data to a device, error detection and handling, and device initialization.
- o **CSI**, or Command String Interpreter, which provides access to system and user programs. It is the hub of OASIS communications.
- o **Programs**, the various programs which perform functions required by the computer system user. These include system commands and computer languages such as MACRO-assembler, BASIC, and EXEC.

UTILITIES

Utilities are self-contained programs provided in addition to other programs which may be supplied with the operating system or in the Diagnostic Supplement. These stand-alone programs give the user greater file management capabilities.

Currently, only two utilities are provided by Altos. These are a File Transfer program (FTP) and a Backup (BACKUP) program which are included with the CP/M and MP/M II operating systems.

The File Transfer program permits transfer of files from Altos computer systems that have 8-inch disks to Altos computer systems that have 5-1/4-inch diskettes such as the Altos 580. The transfer is made through an asynchronous serial channel.

The BACKUP utility transfers files from a hard disk to one or more floppy diskettes, and restores hard disk files from those diskettes. The restore function can be for all files or selected files.

LANGUAGES

The Altos 580 supports a wide variety of high-level languages, which are available from the vendor or from Altos. Check with your vendor regarding available languages for your operating system that serve your processing needs.

COMMUNICATIONS

Altos supports two multi-user operating systems as outlined above, namely MP/M II, and OASIS. In turn, these provide a wide selection of communications software. Asynchronous and synchronous communication utilities for MP/M II are available from Altos. Asynchronous communication utilities are included as part of OASIS.

APPLICATION PROGRAMS

There are over a hundred compatible software packages developed by leading software houses available. Altos provides a list of such compatible program packages on request. If you are interested in a software package said to run on a Z80A microcomputer system under the specified operating system, check with the vendor or developer to see if it runs on the Altos 580.

Three software packages that Altos does provide are the Altos Accountant, Altos Executive Word Processor, and Altos Executive Financial Planner. A description of each of these packages is provided below.

The Altos Accountant includes seven financial applications: accounts receivable, accounts payable, general ledger, inventory control, sales order processing, payroll, and job costing. Each of these accounting solutions includes the Altos Computer Tutor, a step-by-step tutorial that teaches the first time user how to use these programs, at his or her own pace.

The Altos Executive Word Processor is a complete word processing system that comes with a dictionary and spelling checker, mail-merge (form letter) facilities, an editor, as well as its own Altos Computer Tutor.

The Altos Executive Financial Planner provides a programmed approach to financial analysis, budgeting and forecasting, so that it is easy to produce a wide variety of specially designed reports. The Financial Planner also works in conjunction with the Altos Accountant and the Altos Executive Word Processor.

About Options 3

Currently, there are three options that may be added to the Altos 580: the UK-10 and the UK-40 upgrade kits which add 10-megabytes or 35 megabytes, respectively of hard disk capacity to the basic configuration; a MTU-6 Magnetic Tape Unit adds 17 Mb of unformatted storage. These items are briefly discussed here. A full discussion of the option is given in the installation kit.

The primary Altos 580 enclosure contains the CPU with 192 Kilobytes of RAM, four serial channels, all peripheral controllers, power supplies and expansion interfaces, a 10 or 15-MB Winchester-type, hard-disk drive, and an 5-1/4 inch, 96 TPI double-sided, double-density, single or dual floppy-diskette drive.

DESCRIPTION OF THE OPTIONAL UPGRADE KIT (UK-10)

The UK-10 Upgrade Kit provides an additional 10 megabytes of formatted hard disk storage to the Altos 580. Only one of these kits may be added to your system. The kit includes all cabling and cords, and an installation manual.

The UK-40 Upgrade Kit provides an additional 35.6 megabytes of formatted hard disk storage. As above, only one of these kits may be added, and the kit includes all cabling, cards, and manuals.

The MTU-6 provides 17 megabytes of unformatted magnetic tape (cassette) storage.

Customer-Supplied Items 4

To complete your Altos 580 system you need the following items:

- o one to three terminals, depending on whether you have a single or multi-user operating system
- o one parallel printer; serial printer(s) according to your system configuration
- o cables to connect the terminal(s) and printer(s). Refer to the chapters on Connecting the Terminal and Connecting the Printer
- o diskettes
 - 5 1/4" floppy diskettes
 - double-sided, double density
 - 96 tracks per inch
- o diskette supplies:
 - labels
 - write protect stickers
 - diskette storage boxes
- o printer supplies
 - paper, ribbons, printwheels
 - binders for protecting and storing hardcopy printout

Setting Up 5

Setting up your Altos 580 is a fairly simple and easy operation. There are a few basic items which you should consider in getting your system ready. This section gives you a brief explanation of those items and a step-by-step procedure for accomplishing them. Before you attempt to set up your system, however, you should familiarize yourself with the information in this section.

This section explains how to:

- o Select a computer site.
- o Connect major system components (computer, CRT terminal, and printer).

SELECTING A COMPUTER SITE

The Altos 580 is rugged and dependable under any reasonable conditions. It operates most satisfactorily, however, under optimum temperature, humidity, and electrical conditions.

- o Select an area with minimal static electricity, or use anti-static mats and other anti-static materials as necessary.
- o Route power cords and interconnect cables to avoid walkways.
- o Plug power cords for system components only into a single power strip of adequate capacity. Although not required, a dedicated power line is recommended in order to minimize the likelihood of power surges or overloads.
- o Ensure that air flow through the side intake vents and the rear exhaust vent is not obstructed.
- o Locate remote multiple-user terminals anywhere that can be reached by a communications cable of up to 50 feet.
- o Consider the human needs of the operator: light, comfort, quiet, and safety.
- o Position terminals so that they face away from windows and other light sources in order to reduce screen glare; place at least 12 inches from disk drive unit.

It is advisable to avoid large temperature and humidity variations in the 580's surrounding environment as these may precipitate intermittent diskette or disk drive malfunctions.

In addition, it is best to keep the 580 and any peripherals in a normal upright position. Be aware that disk performance could be reduced or the drives damaged if the drives are placed on their side or tilted at a significant angle.

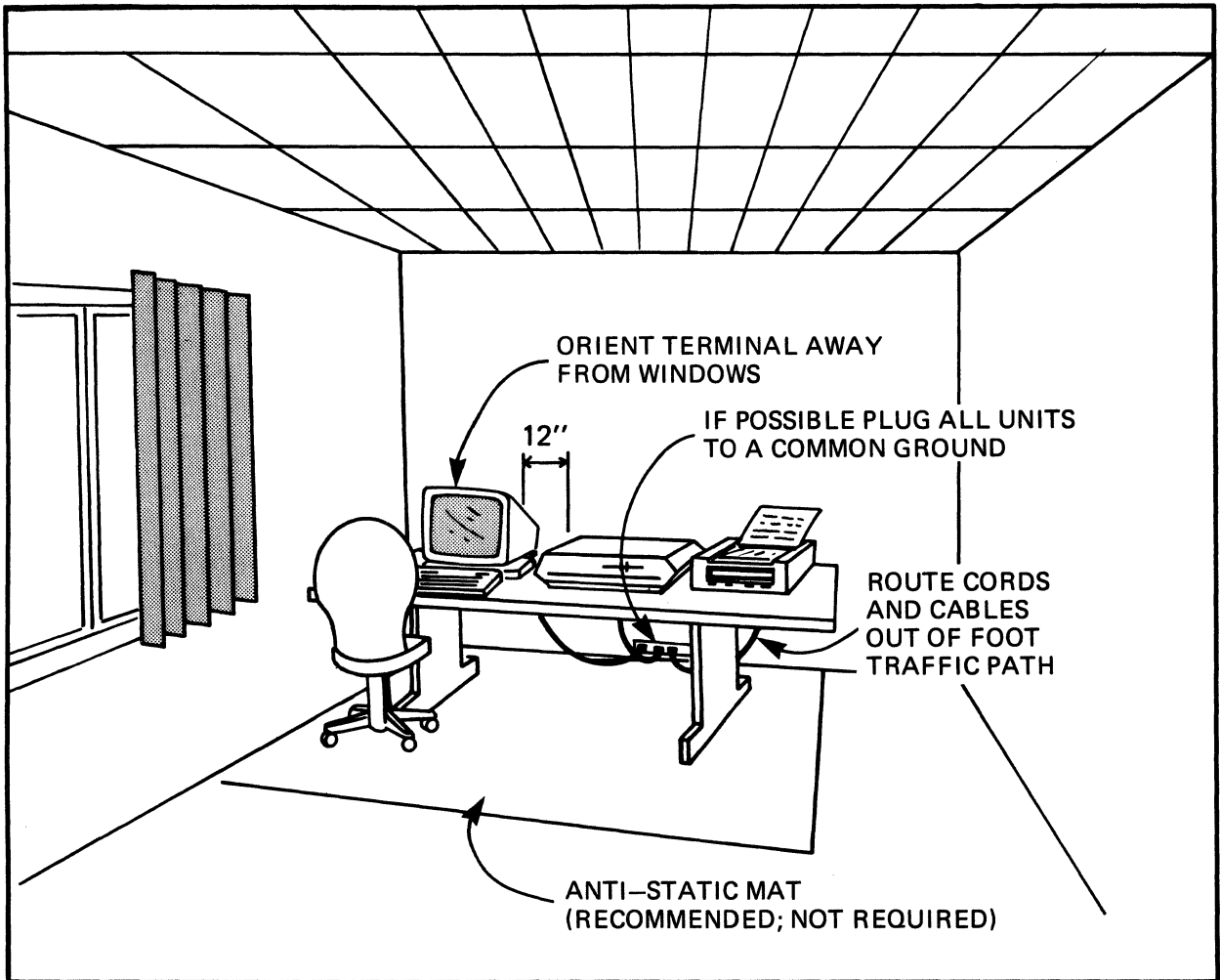

Figure 5-1: Diagram of Computer Site

A COMPLETE ALTOS 580 SYSTEM

Your complete computer system consists of items that Altos provides and additional items that you provide. A detailed list is given for a basic system. Note that peripherals, Upgrade Kits, and applications packages may be added or substituted to give a wide variety of configurations.

Items Purchased from Altos

An Altos 580 computer, complete with a 10- or 15-megabyte 5-1/4" hard disk and a 5-1/4" floppy drive (or, two floppy drives if you do not have a hard disk), power cord, fuse, fuse cap.

The following items relating to the operating system accompany the Altos 580:

- o Operator's Guide for the Altos 580, including the DIAGNOSTIC PROGRAM diskette.
- o Operating System Manual, which provides Operating System installation instructions and other supporting publications.
- o Operating system diskette(s). At least one operating system is required.

NOTE

Each operating system is purchased as an individual item separate from the computer system.

All operating systems are registered with the licensed seller and distributed under license to the end user to operate only on a particular computer. MP/M II is provided with the Altos 580, but CP/M and OASIS must be purchased from Altos Computer Systems. The diskette label for each operating system should so identify it, with a version number and serial number. No other copies of these systems are authorized except by special agreement.

The User Supplies

- o One or more keyboard CRT terminals with RS-232C serial interface, set at serial data transmission rate of 9600 baud. These terminals may be purchased as separate items from Altos.

- o One or more serial printers (dot matrix or impact) can be supported, using a RS-232C serial interface cable.
- o One parallel printer (dot matrix or impact) can be supported, using a RS-232C serial interface cable.
- o One interface cable for each terminal and printer.

Note that in order to maintain Class A compliance to the FCC EMI Regulation (Docket 20780) and limit possible radio/TV interference, all interface cables should have a grounded shield and be securely connected both electrically and mechanically to the Altos 580 and the peripheral device.

(For detailed information refer to Appendix C: Cables, Terminals, and Printer Interface Configurations.)

Connecting The Terminal 6

Connecting the Cable

The console terminal communications cable must be connected from the RS-232C port from the terminal to serial port JC of the Altos 580 (Figure 6-1). All cables should be fastened with the connector retaining screws to provide a proper shielded ground path.

Connecting to Power

Connect the terminal power cord to a properly grounded power source. This should be the same source as your Altos 580. Avoid having other appliances on this same power strip, if possible. Route power cords out of the way for safety.

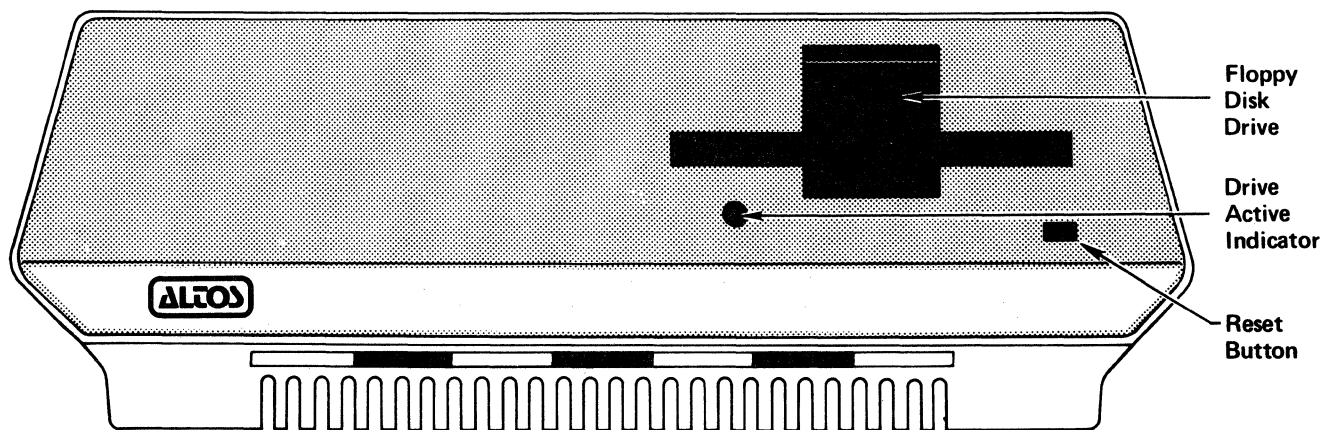
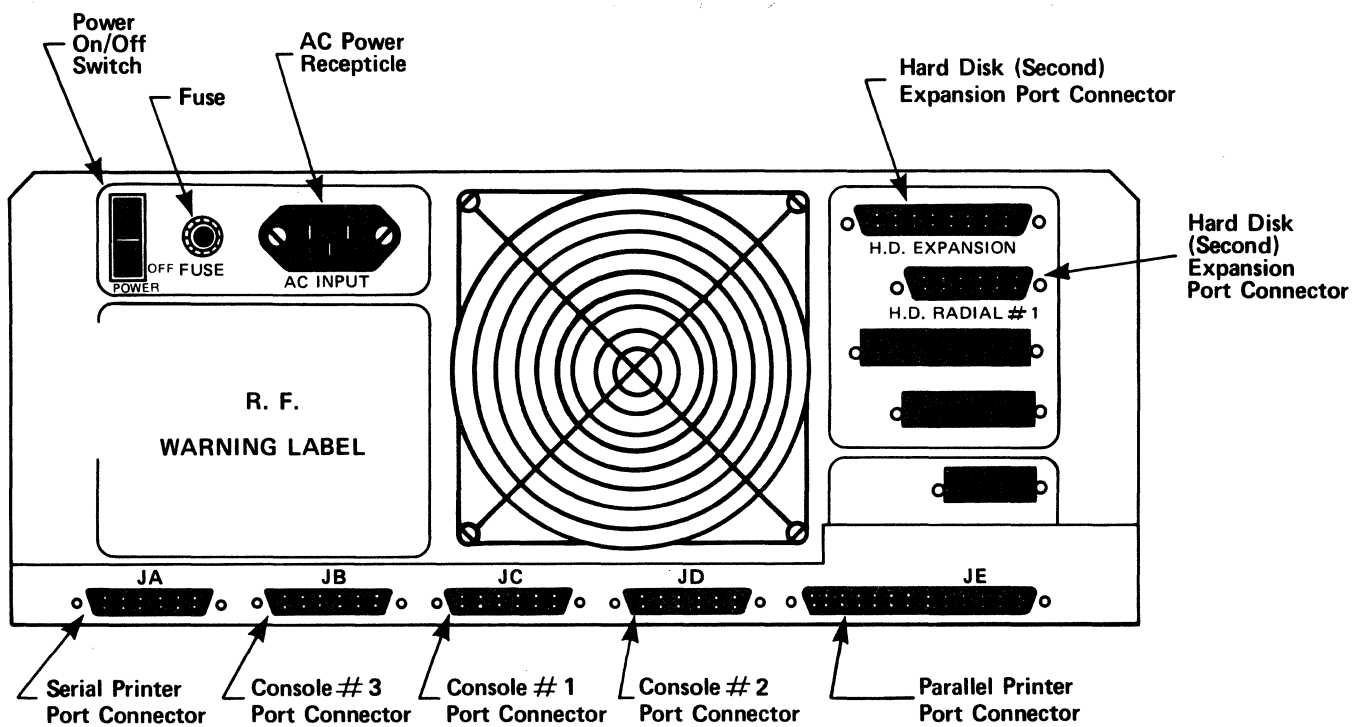

Figure 6-1: Altos 580 Front and Rear Panels

Selecting Switch Settings

The terminal must be set to communicate with the Altos 580 computer according to the specifications below:

- o 9600 baud asynchronous transmission.
- o Eight-bit word length, one start bit and one stop bit.
- o No parity.
- o Data-Terminal-Ready (DTR) handshaking.
- o Request-to-send (RTS) and clear-to-send (CTS) handshaking is disabled.

Refer to the operating system manual and vendor's manual provided with your terminal for information on how to set these parameters on the terminal. Appendix C lists some common terminals and how to configure them.

Connecting The Printer 7

You may operate your system without a printer, although the usual system configuration includes a printer for hard-copy output. In terms of system configuration, printers can be of two kinds: serial (the most common kind for microcomputer use) and parallel. This refers to the way these devices are hooked up to the computer, as well as the way each handles data from the computer. Your Altos 580 supports both serial and parallel printers.

Connecting the Serial Printer Cable

Your serial printer is connected to the Altos 580 with an RS-232C cable from the printer to serial port JA on the Altos 580 computer (Figure 6-1). All cables should be fastened with the connector retaining screws to provide a proper shielded ground path.

Connecting the Parallel Printer Cable

Your parallel printer is connected to the 580 with a special cabling interface from the printer to parallel printer port connector (JE). See Table C-5 for a layout of pin settings.

Connecting to Power

Connect the printer power cord to a properly grounded power source. This should be the same source as your Altos 580. Avoid having other appliances on this same power strip, if possible. Route power cords out of the way for safety.

Selecting Switch Settings on Serial Printers

Data rates for serial printers are set both on the printer itself (on one of the switches), and by operating system dependent utilities. Therefore, you'll need to refer to the manual for your printer and to the operating system manual for a discussion on baud rate setting. The baud rate setting must be the same on the printer as in the operating system or the printer will not work. Data rates may be 300 baud, 1200 baud, 9600 baud, etc.

Turning On Your System 8

PREPARING THE SYSTEM

Verify that the power specifications on the rear panel identification plate match the voltage available for the equipment (see Figure 6-1).

Equipment requiring 115 volts AC uses a 4-ampere fuse, and is designated by an "A" after the model number. Equipment requiring 230 volts AC uses a 2-ampere fuse, and is designated by an "E" after the model number.

Check that the fuse is installed, or insert the fuse and fuse cap (provided with the system) into the fuse receptacle in the rear panel.

Install the three-pronged power cord in the rear panel AC receptacle and plug it into a power source (i.e., wall plug).

Be certain that the floppy disk transport(s) are unloaded and the door(s) are open.

TURNING ON POWER TO THE ALTOS 580

Turn the **terminal** on and allow sufficient warmup time so system messages can be observed when the computer is turned on.

Turn the power switch on the Altos 580 to ON. It is located on the rear panel. Be prepared to press a key (such as the Space Bar) when the following message appears on the screen:

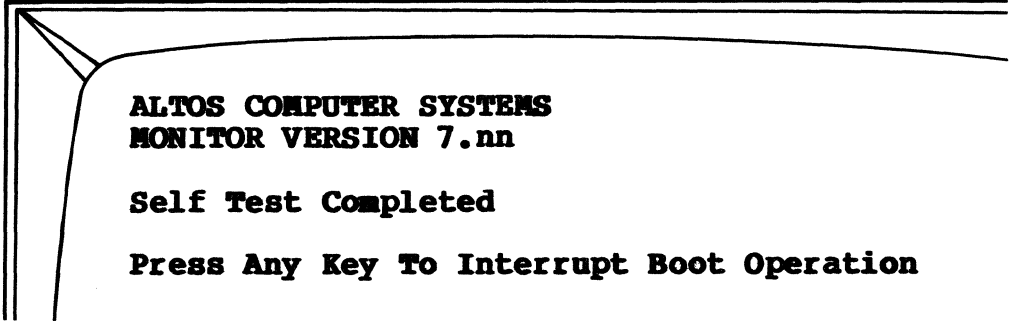

**ALTOS COMPUTER SYSTEMS
MONITOR VERSION 7.nn**

Self Test Completed

Press Any Key To Interrupt Boot Operation

Immediately (within 4 seconds) press the Space Bar or another key on the keyboard to interrupt the boot process. "Booting" the system enables the computer to start operation.

If the boot process is not interrupted, the following display appears:

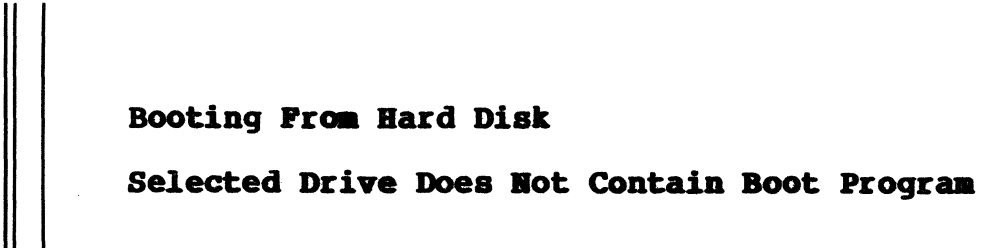

Booting From Hard Disk

Selected Drive Does Not Contain Boot Program

The last line of the above message appears because the computer cannot boot until the operating system has been installed. Press the reset button on the front panel to restart the boot process; within 4 seconds, press any key. If your system does not have a reset button, turn the system off and back on again via the power ON/OFF switch located on the rear panel.

Handling Floppy Diskettes 9

Reasonable care in handling your diskettes prevents numerous errors in your applications and prevents loss of valuable time. **Most systems errors come from improper handling of floppy diskettes.** Avoid touching the exposed coated mylar surfaces of the diskette or allowing those surfaces to become dusty, scratched, or otherwise damaged. Keep the diskette in its envelope when not in use. You should always close your drive after removing a diskette; smoke and dust particles can cause damage.

The following information is useful for software installation procedures and for arranging proper storage of diskettes.

Diskette Insertion

To insert a 5-1/4 inch floppy diskette in the drive, open the drive door cover. If your system has half-size drives, press indentation in center of drive door as shown in Figure 9-1. Insert the diskette with the diskette manufacturer label facing up and towards you. Seat the diskette gently and close the door. See Figure 9-1. (Note: inserting the diskette upside down does no harm but the system does not respond.)

Diskette Write-Protection

5-1/4 inch floppy diskettes are furnished in two ways: the jacket covering the diskette may be solid, or it may have a notch cut into the side. If the notch is covered, the system cannot write data on the diskette and cannot erase data from the diskette. This is known as being "write-protected." The diskette may be "write-enabled" by uncovering the notch.

The diskette manufacturer provides special silver-colored tape pieces for covering the write-disable notch. This tape is best for the purpose because the covering material must block infrared light. Scotch tape and certain other tapes will not work.

Saving Original Diskettes

While installing your Altos 580 system software, protect the original diskettes. This means the original Altos diskettes for the Diagnostic Program, the operating system, and any application program installation diskettes. For those diskettes that have write-enable notches, add the write protection tape. Make at least two copies of the diskettes using the ADXCOPY program on the Diagnostic Program diskette as discussed in Chapter 10. Use one of the copies for daily use. Store the original and the other set of copies as a "backup master." They should be stored away from the computer area.

Never use original diskettes for daily operations.

Labelling Diskettes

Use only felt-tip pens when writing on the diskette jacket or label. A pencil or pen can cause surface indentations which result in errors when the diskette is used. It is best to prepare and write diskette labels before placing them on diskettes.

Storing Diskettes

In daily use of your computer system, make backup copies of new files and changed files. Store backup diskettes in a safe place separate from your computer system working area. Store all diskettes in their jackets and inside boxes when they are not in use. A metal box is best.

Dust on a diskette surface damages the disk drive as well as the diskette. Heat damages diskettes. Avoid

temperatures above 115 degrees Farenheit and below 40 degrees. Avoid humidity above 80 percent.

Magnetic fields can damage the data integrity of the diskette. Magnetic fields are more common than usually realized. Electrical equipment generates a magnetic field. The ringing of a telephone near a diskette can damage it. Screwdrivers, even if not magnetized originally, can be magnetized by use. Avoid placing screwdrivers or other small metal tools on or near a diskette.

Elevators and elevator shafts have electrical cabling which can put out momentary surges of magnetic fields. Do not store diskettes or other magnetic media near a wall behind which is an elevator.

Further Reading

An excellent reference book for the proper care and maintenance of your computer system is **DON'T (Or How to Care for Your Computer)** by Rodney Zaks, printed by Sybex.

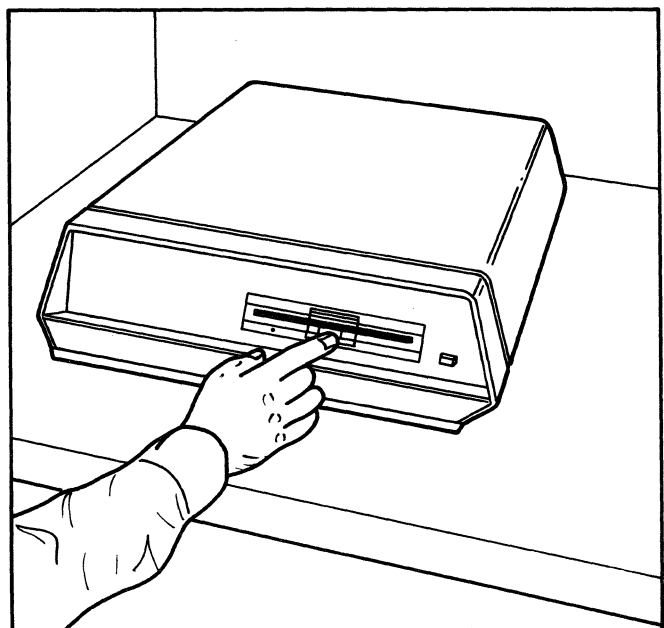
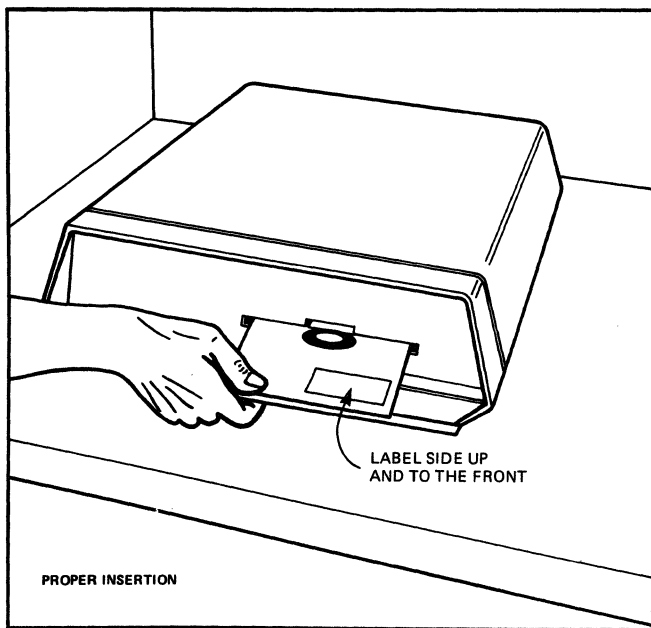
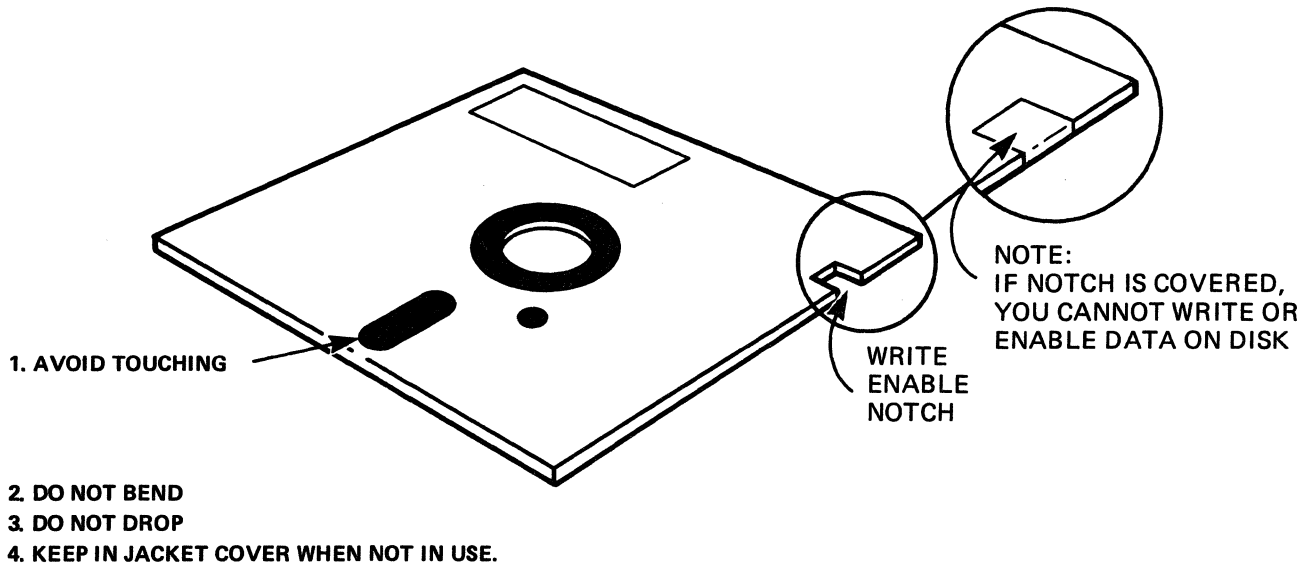

Figure 9-1: Diskette Handling

Testing The System 10

SYSTEM TESTS

An overview of system tests or verifications included on the Diagnostic Program and utilities diskette follows. Refer to the ADX manual that accompanied your Altos 580 for a more detailed discussion and for operating procedures.

There are two kinds of system tests or verifications to be performed on the Altos 580. The first kind runs automatically when the system is turned on. The second kind is performed by the operator, in accordance with step-by-step procedures.

AUTOMATIC SYSTEM TESTING

In the Altos 580 there is a short diagnostic test that automatically verifies the functioning of the system. This diagnostic test is contained in the system itself, stored in a computer memory chip called PROM (Programmable-Read-Only-Memory). The test is part of the Monitor program. When the system monitor begins execution, it sets a number of system parameters and tests each memory location in the system Random Access Memory (RAM). (See Chapter 14 for a list of Monitor error messages.)

OPERATOR TESTING

Additional system verification is performed by the operator. Before you install any one of the three operating systems, you should perform these test routines to verify proper system functioning in a more thorough fashion than the quick self-testing that the Altos 580 automatically runs when it is turned on. It is recommended that you run the Diagnostic Program the very first time the system is powered up and every time a new component is added to the system.

These tests, in turn, may be done in two ways: a routine system check-out and a comprehensive system check-out. The first of these two may take about one hour (with intermittent operator responses required). The second is an extension of the first that may take several hours, the longest portion of which may be run overnight. It is recommended that you do the comprehensive check-out if you have time. Procedures for both are explained in the 580 ADX Manual.

AN OVERVIEW OF THE DIAGNOSTIC PROGRAM

The Diagnostic Program master diskette that comes with the Altos 580 contains a group of command programs that test the computer system components, format diskettes, and copy programs.

The utilities and diagnostic tests that make up the Diagnostic Program are grouped into three categories. Each individual program prompts for every operation you need to perform.

The programs perform the following functions:

- (1) Format diskettes and copy diskette utilities.
- (2) Test the CPU (Central Processing Unit), computer memory, internal communications structure internal-to-external interaction (all ports), and floppy drives.
- (3) Test hard disk functions.

NOTICE

First make backup copies of the DIAGNOSTIC diskette using the ADXCOPY routine. This ensures protection of your master diskette before you proceed to test system components. You should make at least two copies. One copy is for daily use. The other, the back-up master, is only for making additional copies for daily use. You should never use your original DIAGNOSTIC PROGRAM diskette or your back-up master diskette for daily operations. They should both be stored away from your computer area in a secure location to prevent accidental use.

Summary of Diagnostics and Utilities

POWER-UP	System verification test. This test is initialized upon system activation. The Power-Up test cannot be controlled by the user. The Power-up test essentially tests memory and initializes system parameters.
MFT	Basic test for diskettes and diskette drives. The basic mechanical functions of the drive and its associated firmware are tested for validity.
MEMTEST	Memory and system test routines that check RAM memory, memory mapping, and hardware integrity.
HARDS5	A collection of hard-disk utility and test routines. Utilities include formatter, a routine to flag bad sectors. Diagnostics include quick tests, fault isolation tests, and long exercise routines.
MFORMAT	A program designed to format or reformat diskettes. This routine prepares the diskette surface for new data to be placed on it. Formatting erases all data previously stored on a diskette.
COPY	Diskette copy utility. This copies diskettes (5-1/4 inch floppy diskettes) byte for byte.
BOOTCOPY	A program designed to copy the autoboot system tracks (0 and 1) from a source disk to any object disk that has already been formatted.
ADXSETUP	A program used to specify baud rates for the console terminal, printer and auxiliary ports.

Turning Off Your System 11

Turning off your system involves a little more than just shutting the power off. Caution must be taken, otherwise damage can result to your files, someone else's files, or your diskette.

Be sure to copy (save) all work prior to logging off. Remove the diskette, put it in its dust jacket, and store it in the proper place as outlined in Chapter 9, Handling Diskettes.

If you are the sole user on your system, you can then turn the power off to the computer, the terminal, and the printer.

If you are operating in a multi-user environment, i.e., a multi-user operating system, be sure to familiarize yourself with the shutdown procedures so that you will not destroy other users' files when you log off. As with all systems, be sure to save your file, remove your diskette and store it properly.

Preventive Maintenance 12

The ACS 580 requires little maintenance, but there are procedures for ensuring that your system operates effectively. Review the instructions in Chapter 5 regarding setting up your computer system, especially the items which relate to choosing the proper site. Most operator preventive maintenance is associated with the proper care of the floppy diskettes, which is discussed in Chapter 9, Handling Floppy Diskettes.

An excellent reference book for the proper care and maintenance of your computer system is **DON'T! (Or How to Care for Your Computer)** by Rodney Zaks, published by Sybex.

The main precaution to take with your system is to ensure that the operating environment is properly maintained: it should be free of dust and harmful chemical vapors, within specified temperature and humidity ranges, controlled for static electricity, protected from accidental spills and contaminations, and connected to a clean source of electrical power.

Troubleshooting Procedures 13

USER TROUBLE-SHOOTING PROCEDURES

These procedures are for the end-user to verify the functioning of the ALTOS 580. They assume that the correct installation procedures have been followed. If the routine checks listed below do not correct the problem, refer to Appendix B for procedures to contact the appropriate repair facility.

TERMINAL

No Screen Display

1. Ensure that terminal is switched on. Locate the ON/OFF switch on the terminal and switch it from on to OFF to ON again. Some terminals have an audible beep switch which indicates that they have been turned on.
2. Check to see that the terminal is plugged in to the power source and that the power source is working. Check that each end of the RS-232-C cable is plugged into the correct connector--the modem, not the printer or auxiliary at the terminal. (Refer to the operator's guide for your terminal to verify the location of the modem connector.)

3. Check to see that cabling between the terminal and the computer is securely installed. Push each connector firmly to ensure that it is seated properly.
4. Check that cable is the correct one, namely an "RS-232-C." Refer to Chapter 6 of this manual. Inspect the cable to see if there are any cuts, sharp bends, holes, missing wires, or missing pins. If you have a second cable, switch cables.
5. Check the fuse on the terminal. Look closely. Sometimes the filament is very thin, and it may not appear to be there.
6. If you have a second terminal, switch terminals.

No Cursor Display

1. Check to see that terminal is properly configured. Refer to the terminal manual to see that all the terminal switches are set in accordance with the requirements given in Appendix C of this manual under "Terminals."
2. Check that the cable is correctly pinned. Refer to Appendix C of this manual. If this is the first time a particular cable is being used, verify that it is the correct cable, namely an "RS-232-C."

No Response to Keyboard Input

1. If your terminal has a cable connecting it to the keypad, check to see that the cable is connected securely.
2. Turn power to terminal off momentarily, then back on to reset it.
3. See your Operating System manual for discussion of control character sequences to unlock your terminal or program if the program malfunctions.
4. Also see your Operating System manual for procedures to restore your operating system to its state prior to the failure. (This is sometimes called a "warm boot" or a "warm start.")
5. As a last resort, press the RESET button (if you have one) or momentarily turn the system off, then back on. This causes a system reset. **Caution: this procedure erases all unsaved data.**

POWER UP

No Fan

1. Check the power cord. Make sure the cord is securely inserted into the receptacle on the back of the computer and to the power source. Make sure that there are no obvious interruptions in any extension cords you may be using, or that there are no obvious breaks or frays in the line itself.
2. Check the power source. Make sure that this is working by plugging in a lamp or typewriter, with which you can test the power source.
3. Check the fuse. Located on the rear of the computer is a fuse holder which can be easily removed. Take out the fuse holder and the fuse. Inspect the fuse to see if it is burned out. Re-insert the fuse securely into the fuse receptacle.

No Floppy Diskette Drive Light

1. See if the floppy diskette drive is running. Look into the open door to see if the rotor is spinning.

PRINTER

No Response

If you are directing output to the printer and there is no response:

1. Check to see that printer power switch is on. Locate the ON/OFF switch on the printer and turn it on and off a couple of times to see that it is operating.
2. Check to see that the printer is plugged in to the power source and that the power is on.
3. Check the cable connections between the computer and the printer. Make sure they are secure.
4. Refer to the ALTOS 580 rear panel illustration to verify that the printer cable is connected to the correct port on the computer.
5. If you have several work stations using the same printer, check the selector switch to the printer. The selector must indicate the correct work station.
6. If you have a serial printer, check the baud rate. It must conform to the required rates from the computer. Check your printer manual to see how to set the correct baud rate.
7. If the configuration switches that set the baud rate have been changed, it is necessary to turn the printer off and then back on because some printers (as well as other peripherals) only read the configuration switches when they are "powered-up" (turned on).
8. Refer to the Operating System to see how your particular operating system handles setting up the printer.
9. Check other switch parameters on the printer. See your printer manual.

Interruptions

Should your printing become interrupted, perform the following steps:

1. Make sure no one has changed the selector switch to the printer.

2. Check the paper supply and the ribbon.
3. Make sure the Reset Switch on the printer is reset.

DIAGNOSTIC PROCEDURES ERRORS

See Chapter 10, Testing the System and the **ALTOS 580 Computer System - ADX Diagnostic Manual**.

OPERATING SYSTEM ERRORS

See the respective Operating System manual.

CLOSE-DOWN ERRORS

If you have a multi-user operating System such as MP/M II or OASIS, see the respective Operating System manual and the vendor-supplied manuals for that system for the proper close-down procedures.

PROGRAM ERRORS

See your program manual for all error messages, recovery procedures, and operating details.

Monitor Error Messages 14

The monitor is Erasable Programmable Read-Only Memory (EPROM) resident code that executes the initial bootstrap logic to initialize and test your system and load the operating system from hard or floppy disk. The monitor only runs when your Altos 580 is powered up or when the reset button is pressed.

A complete list follows of error messages that the monitor displays when an error is encountered.

Message: **PARITY ERROR - - - - -**

BANK	ADDR	WRITTEN	READ
n	aaaa	ww	rr

where:

n = bank (0-3)
aaaa = address in hexadecimal
ww = value written to memory (hexadecimal)
rr = value reset from memory (hexadecimal)

Meaning: The hardware detects a single-bit parity error.

Action: Document the error; write down the complete message. Reboot the system. If error persists, call your authorized Altos Customer Service Representative.

Message: **Selected device does not contain Boot Program**

Meaning: The boot disk (either floppy or hard disk) does not have a valid boot program in the first sector. This message is displayed if the first byte contains 0E5H (which is the value written to every byte of a disk when it is freshly formatted. This message is not displayed for any other character such as that found on a non-formatted diskette or on a diskette used for floppy testing.

Action: Make a copy of your diskette containing the boot program and insert the new diskette in the drive.

Message: **Hard Disk read error.... status xx**

Meaning: The boot PROM encountered an error while trying to read the boot program from the hard disk. xx is the error status (in hexadecimal) from the hard disk controller. A status of "82" means the operation is good.

See Bit Pattern Translation to Hexadecimal under the next message, Floppy Disk read error, for an example of translation.

The bit definitions in the error status are as follows:

- bit 0 = 1 if busy
- bit 1 = 1 if task is complete
- bit 2 = 1 if bad sector encountered
- bit 3 = 1 if record not found
- bit 4 = 1 if CRC error
- bit 5 (not applicable)
- bit 6 (not applicable)
- bit 7 = 1 if drive is ready

Action: Document the error; write down the complete message. Call your authorized Customer Service Representative.

Message: Floppy Disk read error.... status xx

Meaning: The boot PROM encountered an error while trying to read the boot program from the floppy disk. xx is the error status (in hexadecimal) from WD1797 floppy disk controller. A status of "00" means the operation is good. The bit definitions in the error status are as follows:

- bit 0 = 1 if busy
- bit 1 = 1 if DR (data request) is full
- bit 2 = 1 if lost data
- bit 3 = 1 if CRC error
- bit 4 = 1 if record not found
- bit 5 = 1 if deleted data mark encountered
- bit 6 (not applicable)
- bit 7 = 1 if disk drive is not ready

Bit Pattern Translation to Hexadecimal:

How the bit pattern for hard disk or floppy disk errors are translated into two hexadecimal characters for error status messages:

If a CRC error is detected during a floppy disk read, error bit 3 is set. The binary value would be 00001000 where the right-most zero is bit 0. The equivalent hexadecimal value appearing in the error message would be hexadecimal 08.

Note that similar errors may produce different error values because of different bit positions. If a CRC error is detected during a hard disk read, error bit 1, 4, and 73 are set. The resulting hexadecimal value is 92.

Action: Verify that the floppy diskette is inserted correctly by reinserting the diskette and retrying. If this does not work, document the error; write down the complete message. Call your authorized Altos Customer Service Representative.

Message: Insert Floppy Disk for Autoload

Meaning: There is no diskette in the floppy drive, the diskette is not correctly inserted, or the disk drive door is not closed.

Action: Either insert a diskette, re-insert the diskette, or close the drive door.

**Message: PARITY ERROR -----
System Halted**

Meaning: A memory parity error occurred while the operating system was running.

Action: Run the memory test diagnostic (MEMTEST) and have a technician examine the computer.

Appendix A. System Specifications

SYSTEM CONFIGURATIONS

The Altos 580 is packaged in a desktop enclosure that contains either a hard disk drive with a floppy disk drive or a dual-floppy disk drive.

The primary enclosure contains the CPU with 192K bytes of RAM, 4 serial channels, all peripheral controllers, power supplies and expansion interfaces, and one of the following:

- o 580-10, 580-20 or 580-40: 10-, 15-, or 35.6 megabyte 5-1/4 inch Winchester-type hard-disk drive, and a 5-1/4 inch, 96 TPI double-sided, double-density, floppy-diskette drive.
- o 580-2: two 5-1/4 inch, 96 TPI double-sided, double-density, floppy-diskette drives.

PHYSICAL DESCRIPTION OF THE ALTOS 580

SIZE

16-7/8 inches wide, 18 inches deep, 6.4 inches high

WEIGHT

Free-standing weight - 30 pounds
Shipping weight - 45 pounds

FRONT PANEL CONFIGURATION (Figure 1-1)

Floppy Diskette Drive Door
Reset Button (note: not provided on some systems)

REAR PANEL CONNECTORS (Figure 2-3)

AC ON/OFF Switch
AC Power Receptacle
Fuse Holder
Hard Disk Expansion Connectors (20 pin and 34 pin)
Serial Printer Port (labeled JA)
Console Ports (labeled JB, JC, JD)
Parallel Printer Port (labeled JE)

MAXIMUM INPUT POWER

3 A at 115 V, 60 Hz
1.5 A at 220 V, 50 Hz

POWER DISSIPATION

250 Watts
1024 BTU per hour

AMBIENT OPERATING TEMPERATURE RANGE

50 to 90 Degrees Fahrenheit
10 to 32 Degrees Celsius

RELATIVE HUMIDITY RANGE

20% to 80% Non-condensing

FEATURES AND CAPABILITIES

- o Eight bit CPU section consisting of a Z80A microprocessor.
- o 192 kilobytes main memory with parity.
- o Bootstrap and configuration control read only memory permitting system initialization from either the floppy diskette or the hard disk.
- o One flexible diskette controller capable of controlling one (or two) 5-1/4 inch diskette transport(s) with support for single and double-density recording.
- o Hard disk controller for up to two drives of the 5-1/4 inch Winchester type rigid, fixed-disk technology.
- o Parallel interface capable of controlling one high speed, parallel input line printer.
- o Serial interfaces designed to support asynchronous terminals and printers, synchronous interfaces and local networks.
- o Fully-vectorized interrupt capability.

POWER SUPPLY IDENTIFICATION CONVENTIONS

Altos Computer Systems manufactures equipment for both 115-volt AC AND 230-volt AC power. Equipment that operates on 115-volt AC power is identified by an "A" after the model designator on the back panel identification plate; equipment that operates on 230-volts AC is identified by an "E".

Appendix B.

Warranty Information

WARRANTY

Altos Computer Systems warrants each of its products to be free from defects in materials and workmanship for a period of 90 days from date of purchase by the end-user. During the warranty period, Altos, at its option, will repair or replace components in the products that prove to be defective at no charge other than shipping and handling, provided the product is returned prepaid to an authorized Altos Service Center or to Altos Computer Systems, 2360 Bering Drive, San Jose, California 95131.

This warranty will not be effective if, in the opinion of Altos Computer Systems, the Altos product has been damaged by accident, misuse, misapplication, or as a result of service or modification by other than an authorized Altos service center.

This warranty is expressly exclusive and in lieu of all other warranties or guarantees either expressed or implied, including, but not limited to the implied warranties of merchantability and fitness for a particular purpose. In no event shall Altos be liable for lost profits, loss of good will, or any other special or consequential damages.

NOTE

Return of the End-User Registration Card is required for this warranty to be valid. Warranty claims are void unless the End-User Registration Card and Dealer Registration Card are on file at Altos Computer Systems.

SHIPPING DAMAGE INSPECTION

If an Altos computer is received that has been damaged in shipment, or the possibility that it could have been damaged judging by the appearance or condition of the shipping container, note it on the waybill and require the delivery agent to sign the waybill. Notify the transfer company immediately and submit a damage report to the carrier, your dealer, and to Altos Computer Systems, Customer Service Department, Attention: CLAIMS. If no exterior damage exists, unpack the microcomputer and inspect for hidden damage. All insurance claims for damage must be filed by the customer.

REPAIR AND SERVICE PROCEDURES

If you experience technical problems with your Altos computer, perform the steps in the following procedure:

1. Contact your Authorized Reseller for assistance. He will be able to fill most of your repair or service needs.

If your Authorized Reseller is unable to assist you and you are located in the United States, perform either step 2 or 3.

2. Contact the Customer Service Division of TRW, Inc. at one of the regional offices for service information.

WESTERN REGION
14472 Wicks Boulevard
P.O. Box 2133
San Leandro, CA 94577
(415) 352-2574

EASTERN REGION
One Lethbridge Plaza
Mahwah, NJ 07430
(201) 529-4700

SOUTHERN REGION
5924 Peachtree Corners East
P.O. Box 748
Norcross, GA 30091
(404) 449-7548

CENTRAL REGION
100 Bliss Drive
Oak Brook, IL 60521
(312) 986-6450

3. Contact Altos Computer Systems Customer Service Department for factory depot service.

Altos Computer Systems
Customer Service Department
2360 Bering Drive
San Jose, CA 95131
(408) 942-0555
Telex: 171562 ALTOS SNJ or 470642 ALTO UI

ALTOS FACTORY REPAIR PROCEDURES

Follow these steps to obtain Altos factory repair services:

1. Contact Customer Service for assistance in ensuring that your system needs factory service, and to minimize the occurrence of "no problem found" when your system is returned for repair.
2. Obtain Warranty or standard Return Authorization Number. At the time the Return Authorization Number is assigned you will need to provide the following information:
 - a. Model Number of your system
 - b. Serial Number
 - c. Date Purchased
 - d. Specific Problem
 - e. Purchase Order Number or Authorization for any repair charges
 - f. Name, address and telephone/telex number of your company and name of a responsible technical person whom Altos Customer Service may contact in the event of any question or problems
3. Return the defective Altos computer in its original shipping container, with the Return Authorization Number clearly labeled on the outside of the container. Include a detailed description of the symptoms of the malfunction, and any special instruction. Follow all shipping and packing instructions contained in your user manual.
 - a. Warranty freight:

The End-User pays freight to Service Center. Altos Service Center pays return freight via like carrier.
 - b. Non-Warranty Freight:

The End-User pays freight both ways.

CAUTION

Altos Customer Service is not responsible for the loss of data on any system returned for repair. A system returned for repair is fully tested, and this testing destroys all data on any hard disk product.

Appendix C.

Cables, Terminals, and Printer Interface Configurations

INTERFACE CONFIGURATIONS

The cabling configurations used to connect one or more terminals and one printer to the Altos 580 are given specified in this appendix. Printers come in two basic varieties: serial and parallel. Normally, terminals connect serial ports JB, JC, and JD, and a serial printer connects to port JA. Parallel printers are connected to port JE on the 580. Operating systems can change these assignments, if required.

The following information on terminals and serial printers is given independent of the operating system. The operating system manual gives additional information on configuring terminals and printers into the operating system, and on modifying the way the operating system uses these peripherals. The basic connection information given here does not depend on the operating system, but allows you to connect terminals and one or more printers and to install an operating system. It may be that no further operating system configuration is necessary after installation.

TERMINALS

RS-232C Terminal Cabling

The cable used is called an RS-232C interface cable, and is an industry standard. The full standard specifies the use of each pin on a 25-pin connector, but in many cases only a few pins are actually used.

For the terminals normally used with the Altos 580 both ends of the cable are provided with male connectors. Both ends have the same pinout, and either end can be connected to the computer or the terminal.

The minimum RS-232C interface for the Altos 580 requires connecting pins 2 and 3 (data in and out) from the computer to pins 2 and 3, respectively, on the terminal for data transmission, and then one of the following setups:

- o the terminal uses Data-Terminal-Ready (DTR) logic, so either pins 6 and 20 should be connected to the opposite pins 6 and 20, respectively,

-or-

- o at the Altos 580 end, pin 20 (DTR) should be "strapped" (connected) to pin 6 (DSR). The Altos 580 always raises the signal on pin 20, so this short-cut will work.

In addition, pin 1 (chassis ground) and pin 7 (signal ground) of the terminal are connected to pins 1 and 7 respectively on the Altos 580 end.

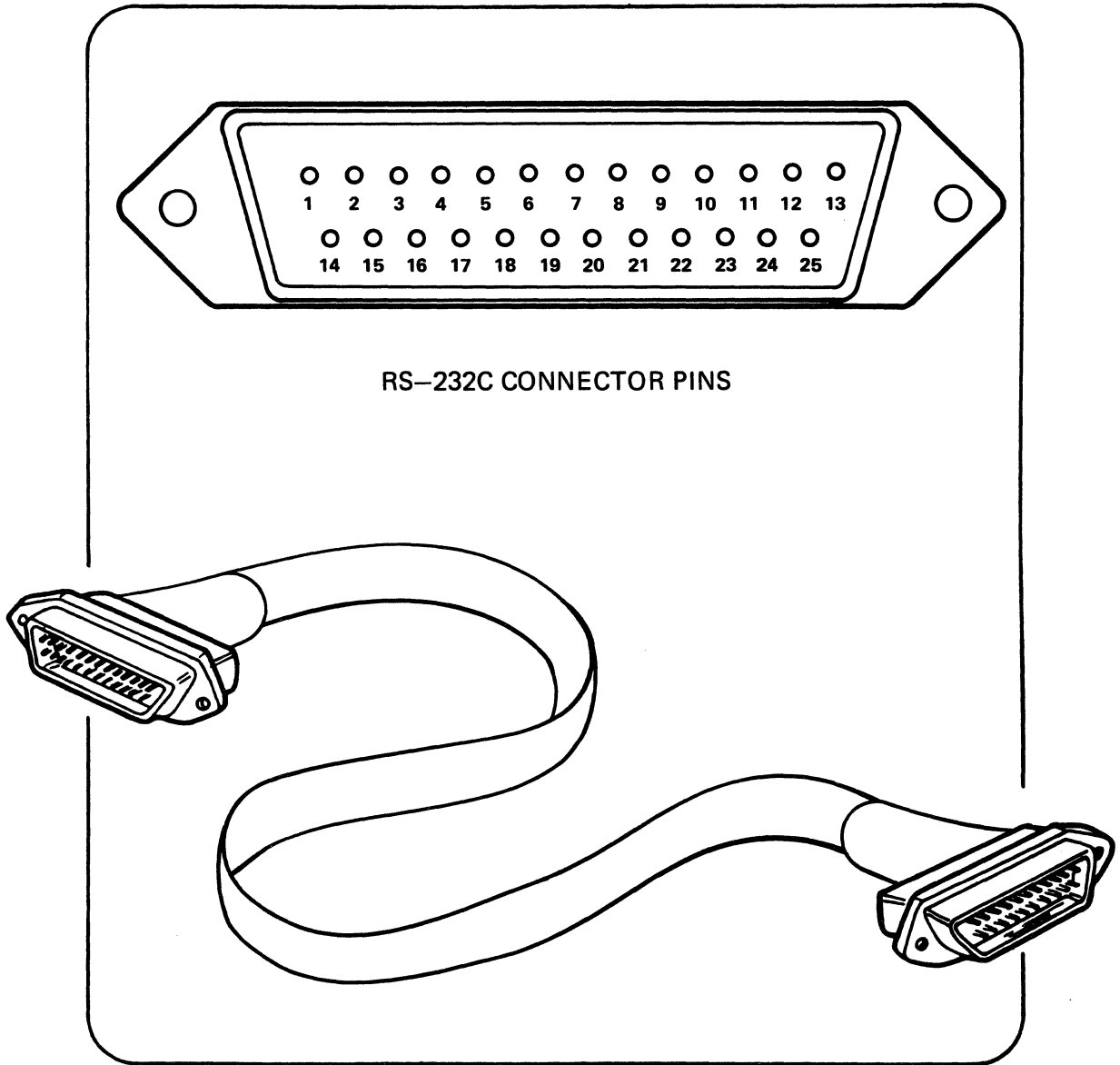

Figure C-1: Male Connector, RS-232C Cable

The full pinout is given in the following table:

Table C-1: RS-232C Pinning Instructions

PIN	1	Chassis Ground
PIN	2	Transmitted Data (from the terminal)
PIN	3	Received Data (by the terminal)
PIN	4	Request-to-Send (Optional--requires jumper change)
PIN	5	Clear-to-Send
PIN	6	Data Set Ready
PIN	7	Signal Ground
PIN	8	+12 Vdc
PIN	9	N/C*
PIN	10	N/C
PIN	11	N/C
PIN	12	N/C
PIN	13	N/C
PIN	14	N/C
PIN	15	N/C
PIN	16	N/C
PIN	17	N/C
PIN	18	N/C
PIN	19	N/C
PIN	20	Data-Terminal-Ready (DTR)

*N/C = Not Connected.

To make RS-232C interface cables for terminals, use male shielded 25-pin RS-232C type connectors and connect the pins in a one-to-one correspondence. All cables should be fastened with connector retaining screws to provide a properly shielded ground path.

Standard Terminal Connection

For a standard configuration, the console terminal must be connected to serial port JC of the Altos 580 computer at the time the operating system is installed and started up. (It can be placed on another serial port during the running of diagnostics, but must be on port 1 for installation.) As the operating system manual explains, you may change port assignments later. Each operating system differs as to how this is done.

The terminal must be set to communicate with the Altos 580 computer according to the specifications below:

- o 9600 baud asynchronous transmission.
- o Eight-bit word length, one start bit and one stop bit.

- o No parity.
- o Data-Terminal-Ready (DTR) handshaking. This can be accomplished by setting terminal controls or by strapping the cable, as mentioned in the Terminal Cabling section above.
- o Request-to-send (RTS) and clear-to-send (CTS) handshaking is disabled.

Refer to the vendor's manual provided with your terminal to set these parameters on the terminal.

SERIAL PRINTERS

Most serial printers use the RS-232C pinning configuration, so the standard RS-232C cable may be used. This cable is described above for terminals.

Some of the more common exceptions are given below.

Table C-2: ALTOS TO ANADEX (Serial)

ALTOS (DB-25)	ANADEX (DB-25)
1	1
2	2
3	3
7	7
20	19 (Jumper 6,8,20)

Table C-3: ALTOS TO EPSON MX80 F/T (Serial)

ALTOS (DB-25)	EPSON (DB-25)
1	1
2	2
3	3
7	7
20	20 (Jumper 6,19)

PARALLEL PRINTERS

The parallel printer connection on the 580 requires the use of a cable pinning configuration developed by Altos computers.

The following table gives standard parallel interface connectors. The connections shown here work with CP/M, MP/M II, and OASIS.

Table C-4: Parallel (Centronics) Interface Connector

REAR PANEL CONNECTOR	CENTRONICS CONNECTOR	FUNCTION
1	1	DATA STROBE to LP
2	2	DATA 0 to LP
3	5	DATA 3 to LP
4	3	DATA 1 to LP
5	8	DATA 6 to LP
6	9	DATA 7 to LP
7	10	ACKNOWLEDGE-from LP
8	11	BUSY from LP
9	4	DATA 2 to LP
10	6	DATA 4 to LP
11	7	DATA 5 to LP
13	13	SELECTED from LP
15	12	PAPER OUT from LP
19	17	GROUND
20	19	GROUND
21	20	GROUND
22	23	GROUND
23	21	GROUND
24	26	GROUND
25	27	GROUND
27	28	GROUND
28	29	GROUND
29	22	GROUND
30	24	GROUND
31	25	GROUND
32	16	GROUND
33	30	GROUND
34	32	FAULT-from LP

GLOSSARY

The general computer glossary of basic terms that follows, in conjunction with the operating system glossary, helps to clarify "computerese"--the jargon of computer professionals.

A

Acoustic Coupler	A device for coupling a computer with a telephone for the transmission of data.
Address	A group of digits that tells a computer where certain information is stored.
Algorithm	Step-by-step specification of the solution to a problem. A problem is conceived; an algorithm is devised for its solution. The algorithm is then represented by a flow chart. The flow chart is finally translated into a program.
Alphanumeric	A set of characters containing single-digit numbers and the letters of the alphabet, punctuation marks, and other printable symbols.
Analog	Continuous-value representation of a physical quantity.
Analog Signal	A continuous electrical signal representing a condition (such as temperature or the position of game control paddles). Unlike a digital signal, which is discrete, an analog signal can be any frequency or strength.
ANSI	American National Standard Institute. An agency concerned with setting up industry-wide standards. Some languages have ANSI standard.
Applications Programs	Programs designed to do specific jobs, such as general ledger or inventory record keeping.
Architecture	How the computer appears to a programmer. Different manufacturers may produce different hardware. With compatible architecture, the same program can run on both machines.
Arithmetic Logic Unit (ALU)	The element in a computer that can perform the basic data manipulations in the central processor.

ASCII Acronym for American Standard Code for Information Interchange. One of a number of industry standard computer codes for representing letters, numbers, punctuation, and control codes in computer format. Rhymes with "pass key."

Assembler Computer program that converts user-written symbolic (mnemonic) instructions into equivalent machine-executable binary object code instructions for execution.

Assembly Language A programming language supplied by the computer manufacturer to allow programmers to write machine-oriented programs using abbreviated word commands (mnemonics) in place of the long strings of ones and zeros that form a computer's machine language. Each manufacturer has a different Assembler that works with its machine. See Language.

Asynchronous Referring to an event or device not synchronized with the timing circuit of a computer's central processing unit.

Asynchronous Transmission The transmission of computerized information by individual characters having start and stop signals. Data is transmitted in irregular spurts, where the time interval varies between successive transmitted characters.

B

Backup The process or the device used to create a copy of critical system files--- programs, data, etc. The process should be done on a regular basis so that files are not lost or destroyed during data manipulation. Floppy disks and magnetic tape cartridges are two types of backup devices.

BASIC Beginner's All-Purpose Symbolic Instruction Code. An easy-to-use, high-level language that is often used for interactive business data processing because of its user orientation. It is also popular because of its availability on many microcomputer systems.

Batch	A processing mode whereby a program is submitted to the computer, and the result is delivered back, or a group of similar data items or transactions processed in sequence as one lot. No interactive communication between program and user is possible.
Baud	A measure of speed in sending data rated as binary units of information per second. 500 baud means 500 bits of data per second can be sent. 500 baud is approximately 50 characters per second.
Baud Rate	Unit of signaling (in bits per second) used as a measure of serial data flow between a computer and/or communication devices.
Benchmark	A set of standards used in testing a software or hardware product, or system, from which a measurement can be made. Benchmarks are often run on a system to verify that it performs according to specifications.
Bi-directional	The type of printer in which characters are printed as the head moves from left to right and from right to left.
Binary	The base-two number system computers use (as compared with a decimal system with a base of 10). It uses only 1's and 0's to form all numbers and letters.
Binary Code	The system of representing numbers using the characters 0 and 1 to represent any number.
Binary Number	Representation of a number in the binary system, using a series of zeros and ones.
Bisynchronous	Method of transmitting computerized data which allows for multiple error detection.
Bit	The contraction of Binary Digit. A bit always has the value zero or one. Bits are universally used in electronic systems to encode information, orders (instructions) and data. Bits are usually grouped in nybbles (four), bytes (eight) or larger units.

Boot To Bootstrap a computer system. See Bootstrap.

Bootstrap A program used for starting the computer, usually by clearing the memory, setting up devices and loading the operating system from input/output internal or external memory.

Buffer A part of a computer's memory where data can be stored temporarily until the computer is ready to do something with it. Some peripherals also have buffers.

Bug A mistake in a program or in an electrical circuit. Getting rid of the mistakes is known as debugging.

Bus A path for electrical signals having a common function. For example, data travels over the data bus. Normally, a wire or cable.

Byte A set of eight bits operated on as a unit. A byte is universally used to represent a character. Microcomputer instructions require one, two or three bytes. One byte includes two nybbles.

C

Cartridge Similar to the cassette you use on your home or car stereo or portable dictating machine. Used to put pre-recorded applications programs into the computer, to back up system files, or to transfer data between different machines.

CBasic Commercial Basic. CBasic is a compiled language that has more flexibility than Basic.

Central Processing Unit (CPU) Technically, the logic and arithmetic circuitry inside a computer. The place where data actually gets processed. In computerese, also used to describe the "box" that houses the CPU.

Character	A single digit, letter or symbol that a computer can recognize. Ordinarily represented in a one-byte combination of 1's and 0's.
Character Printer	A printer that transfers a fully formed letter, number, or symbol with each impression stroke. The characters are generally more legible than those created by a dot matrix printer.
Chip	An integrated circuit. In LSI technology, many functions are packed onto one chip. In microcircuitry, a single device, either a transistor or a diode, that has been cut from a larger wafer.
Circuit Board	A thin, rectangular plastic board on which are mounted one or more chips. There are many types of circuit boards (also called PC Boards and Cards) including memory boards, processor boards, I/O (Input/Output) boards, etc.
COBOL	Common Business Oriented Language. A programming language that simplifies business data processing programs. Its instructions are very similar to ordinary English.
Command	An order to the computer in the form of words and numbers typed on a keyboard, words spoken into a microphone, positions of a game paddle or joystick, etc.
Compatibility	Two computers are compatible if they can run the same software and work with the same devices. Also, a computer's ability to work with the same peripheral equipment-disk storage, printers, etc.
Compile	To translate high-level language into a set of binary instructions.
Compiled Program	Usually, a machine-code program produced by the action of a compiler and directly executable by the computer.
Compiler	A computer software program that translates a high-level language such as COBOL, PASCAL, FORTRAN, BASIC, PL/1, etc. to a machine-oriented language. If, for example, the program is in COBOL, a COBOL compiler is needed to do the translation.

More powerful than an assembler, a compiler can substitute subroutines as well as single machine instructions for certain symbolic inputs.

Computer

A device capable of accepting information, applying prescribed processes to the information, and supplying the results of these processes. It usually consists of input and output devices, storage, arithmetic and logic units, and a central processing unit (CPU).

Computer Power

A measure of a computer system's processing capability based on speed and memory capacity.

Configuration

The design or layout of a particular computer system with all its peripherals. To configure a system is to design a system to meet a customer's needs.

Controller

A piece of hardware that usually monitors the use of input and output equipment.

Core

Main memory resident in the computer.

CP/M

Control Program/Monitor. One of the more common computer operating systems on which many computers are based and much software written.

CPS

Characters Per Second. The speed of a printer, or any device that produces text.

CPU

Central Processing Unit. The computer module in charge of fetching, decoding and executing instructions.

Crash

Slang for a system failure because of a non-recoverable hardware failure. A situation in which the computer becomes misdirected or blocked, as a result of a hardware or software malfunction. A head-crash in a disk system refers to the accidental impact of the read/write (R/W) head on the disk surface.

CRT

Cathode Ray Tube. The television tube used to display pictures or characters. Also the computer terminal made from a CRT.

CTRL	Abbreviation of the word or command "Control."
Cursor	A manually moveable marker used to indicate the location of the next point at which an action will take place.
D	
Daisy Wheel	A wheel-like print head with type characters used on some types of printers to print typewriter quality characters on paper.
Data	A general term used to represent facts, numbers, letters and symbols in a well-defined manner for the purpose of human or machine communication, processing or interpretation. A single item of data is a data element.
Database	Comprehensive collection of information having predetermined structure (i.e., data files) and organization suitable for communication, interpretation, or processing; file data for easy access, retrieval and update.
Data Security	Protection of computerized information by various means, including cryptography, locks, identification cards and badges, restricted access to the computer, passwords, physical and electronic backup copies of the data, and so on.
DBMS	Data Base Management Systems.
Debug	The process of removing errors (bugs) from programs.
Diagnostic	A program or routine used to diagnose system malfunctions.
Diagnostics	The tests a computer or a peripheral, such as a disk or terminal, performs on itself to make sure it's working OK. Taking your own temperature is similar.
Digit	A single symbol or character used to represent a specific quantity of information. In the decimal numerical system, 0 through 9 are the symbols used; in the binary system, 0 and 1.

Digital	A discrete representation of a physical quantity.
Digital to Analog	D-to-A. Device that transforms a computer's digital electrical pulses to continuous analog pulses in order to relay information to, or power to some device outside of the computer.
Digitize	Convert drawing or picture information into digital form.
Digitizer	A device that converts coordinate information into numeric form readable by a digital computer.
DIP	Dual In-line Package. A standard Integrated Circuit (IC) package with two rows of pins at one-tenth of an inch intervals.
Direct Memory Access	DMA. A computer feature that allows peripheral systems to access the memory for both input and output operations without affecting the state of the computer's central processor. It also pertains to the process of obtaining data from or placing data into memory where the time required for such access is independent of the location of the data most recently obtained or placed into memory.
Disable	To render a control or process temporarily inoperable, while another process takes place.
Disc (Disk)	A storage device consisting of a flat circular plate with magnetic surface on which data can be stored by selective magnetization of portions of the flat surface. See "disk."
Disc Operating System (DOS)	A set of programs which handle housekeeping functions for a computer.
Disk	A flat, circular object that resembles a phonograph record. A record "stores" music; a disk stores information. The disk is inserted into a disk drive that rotates at high speed. The drive writes new information onto the disk and reads information that is already stored on the disk. There are two major types of disks

found on small computers: flexible floppy disks and hard disks. Disk storage is the amount of information, usually measured in thousands (K or Kbytes) or millions (Mbytes or Megabytes) of characters.

Disk Drive

The machinery that contains, rotates, writes onto and reads from a disk.

Diskette

Small, flexible disks (floppy disks) used to magnetically record information. They have less capacity than hard disks and are much slower, but are less expensive.

Distributed Processing

Data processing tasks performed simultaneously in several interconnected processors of a computer network.

Documentation

The written support material for a computer or a program (user or operator instructions).

DOS

Disc Operating System.

Dot Matrix

A method used in some printers to transfer images to paper. The characters are made up of small dots, like the lights on an electric scoreboard.

Down

Out of service because of power failure or hardware breakdown.

Down Time

That period during which a system is inoperable through power failure or hardware breakdown.

Drive

The electromechanical device that rotates the data storage disk while the magnetic sensor transfers data to and from the disk.

Dual Density

A reference to storage disks and disk drives that are capable of storing and reading twice the number of information tracks (80) per disk as the early standard (35-40).

Dumb Terminal

A computer terminal, normally providing keyboard and video monitor, which requires connection to a main computer, but which allows remote data entry and access.

Dump Computer term meaning to copy the contents of all or part of a storage device or medium, preserving the contents of one memory into another; usually from an internal storage into an external storage.

E

Error Message A one-sentence statement by the computer to the operator that something has been done incorrectly, e.g., "Does not compute."

Expansion Interface A device to expand the functional capacity of a computer by containing additional memory or controlling more peripherals.

External Memory Used to store programs and information that would otherwise be lost if the computer was turned off. Cassette tapes, disks, bubble memory and CCD (charge coupled devices) are also known as mass memory and removable memory.

F

File An organized collection of logically related records that are treated as a unit or block. In data processing, an integrated collection of a company's data files makes a data base. A file may be physically divided into smaller records.

Firmware Parts of a computer system that seem like software are sometimes locked into an unchangeable medium such as a Read Only Memory (ROM). This may be software instructions or simple control sequences. Software becomes firmware when it is put into a computer when it is built; it cannot then be changed without replacing the hardware.

Flexible Disk See Floppy disk.

Floating Point A method of representing a numeric value which contains a decimal point, i.e., not necessarily a whole number.

Floppy Disk	A small mass-storage device using a soft (floppy) disk to magnetically record information. The disk rotates in a cardboard jacket. Cutout holes provide access for the moving head (which must be applied against the disk in order to read or write) and for index information.
Fonts, line	Repetitive pattern used to give meaning to a line, e.g. solid, dashed, dotted, etc.
Fonts, text	A complete set of one character type.
FORTH	An interpreter language developed by FORTH, Inc. Forth programs, in general, are smaller and run faster than the same programs written in Basic. Forth programs are especially suited to controlling devices that can be hooked into the computer, such as household appliances, "snooper" sensors and robots.
FORTRAN	An acronym for FORMula TRANSlator, a procedure-oriented high-level computer programming language, used primarily for solving scientific problems. Requires a compiler. (By contrast, BASIC, derived from Fortran, can be interpreted.)
Function Key	Specific key which causes a pre-defined function to be requested of the system whenever the key is depressed.

H

Hardcopy	Printed copy of machine output, e.g. drawings, printed reports, listings, summaries.
Hard Disk	A data storage medium encompassing a permanently mounted disk and drive with a storage capacity 10 to 30 times that of the removable floppy disk.
Hardware	The mechanical, magnetic, electronic and electrical devices or components of a computer. Generally, the parts of a computer system you can see and touch.

HDC Hard Disk Controller (board).

HDU Hard (Rigid) Disk (Drive) Unit.

High-Level Language A programming language that is close to English. High-level languages make programming easier. Languages like COBOL and BASIC are high level.

Host Computer Computer attached to a network providing services such as computation, database management, and special programs.

Hz (Hertz) A unit of frequency equal to 1 cycle per second.

I

IC Integrated Circuit. Tiny complex of electronic components and their connections produced on a slice of material such as silicon.

Initialize Set counters, switches, or addresses to starting values at prescribed points in the execution of a program, particularly for re-execution of a sequence of code.

Input In computer terminology, the data being supplied to a computer for processing, or the device employed to accomplish the transfer of data, either by a human operator or another computer device.

Input Device Any machine that allows you to enter commands or information into the computer's main (RAM) memory. An input device could be a typewriter keyboard, an organ keyboard, a tape drive, a disk drive, a microphone, a light pen, a digitizer, or electronic sensors.

I/O Input/Output. The communication of information to and from a computer or peripheral device.

I/O Device Input/output equipment used to communicate with a system.

Intelligent Terminal A terminal with local processing power whose characteristics can be changed under program control.

- Interactive** A program that is able to carry on a "conversation" with the operator. The program prompts the operator, helping him through a routine, while checking input for acceptability and notifying the operator when an error is made.
- Interface** The hardware or software required to interconnect a device to a system. One-chip interfaces now exist for most peripherals.
- Interpreter** A translation program used to execute statements expressed in a high-level language. An interpreter translates each such statement into a sequence of binary instructions and executes it immediately. Instructions can be freely added or modified in the user program, and execution may be resumed without delay; an interpreter is interactive.
- Interrupt** To stop a process so that it cannot be automatically resumed.

K

- Kbyte** Kilobyte (1024 bytes)
- Keyboard** A group of pushbuttons used for entering information into a computer system.
- Kilo** Prefix meaning "1000." One thousand bytes equals 1,024. Used most often in defining memory capacity. "32K" is 32,767.
- Kilobyte** Term meaning "1000 bytes" (precisely, 1024 bytes).

L

- Language** A set of representations, conventions and rules used to convey information. In computer terminology, a set of instructions which may be interpreted by a computer, either directly or through translation by a compiler. Procedure-oriented programming languages used in the preparation of computer programs

include: ALGOL (ALGOrithmic Language), APL (A Programming Language), BASIC (Beginner's All-purpose Symbolic Instruction Code), COBOL (COMmon Business Oriented Language), FORTRAN (FORMula TRANslator), and PL/1 (Programming Language 1).

Large Scale Integration (LSI)

A technology that allows us to produce circuits with many (more than 1000) transistors on a chip.

Letter Quality

A type of printer which duplicates the type quality of an electric typewriter.

Library

Collection of related files, such as personnel files. The organization's libraries make up a data bank.

Line Printer

A printer that prints at high speed by printing an entire line at one time.

LISP

List-Oriented Interactive Language. A high-level programming language.

Location

The physical place in the computer's memory, reached by an address, where an item of information is stored.

Loop

Sequence of instructions which are executed repeatedly, with or without modifications during each iteration, until a terminating condition is satisfied.

LSI

Large Scale Integration.

M

Machine Instruction

Instructions that are machine-recognizable and executable.

Machine Language

Set of binary codes, representing the instructions that can be directly executed by a processor.

Macro

Combination of commands that are executed as a single command.

Magnetic Tape

A continuous, flexible recording medium whose base is either magnetic or coated with magnetic-sensitive material on which

data can be stored by selective polarization of portions of the surface. It is commonly used to "back up" files for secure storage or to load or transfer programs and information from other systems.

Mainframe	Generally refers to a central processing unit of a large-scale computer configuration.
Main Memory	The internal memory of the computer contained in its circuitry, as opposed to peripheral memory (tapes, disks).
Main Storage	The general-purpose storage of a computer, program-addressable, from which instructions may be executed and from which data can be loaded directly into registers.
Mass Storage	Auxiliary or bulk memory that can store large amounts of data readily accessible to the computer; e.g., a disk or magnetic tape.
Mbyte	Megabyte (one million bytes).
Mega	Prefix for million. Hence one megabyte equals a million bytes.
Megabyte	One million characters (bytes). Usually used in reference to storage or memory capacity.
Memory	The semiconductor storage inside the computer, used to hold the operating system and application programs currently in use. Part of the description of a computer includes the amount of memory, usually given in Kbytes.
Menu	<p>A list of programs or applications that are available for the user to select from. For example, a small home computer might display the following menu:</p> <p style="padding-left: 40px;">"Do you want to:</p> <ol style="list-style-type: none"><li style="padding-left: 80px;">1. Balance checkbook?<li style="padding-left: 80px;">2. See appointments for May?<li style="padding-left: 80px;">3. See a recipe? <p style="padding-left: 40px;">Type number desired."</p>

Menu Board	Input device consisting of command squares on a digitizing surface. It eliminates the need for an input keyboard for common commands.
Micro	The prefix indicating 1/1,000,000th.
Microcomputer	A small but complete computer system, including CPU, memory, input/output (I/O) interfaces and power supply.
Microprocessor	A single integrated circuit that contains complete processing circuitry on a single silicon chip.
Millisecond	1/1000th of a second.
Minicomputer	A computer which is larger than a microcomputer. Generally, a 16-bit computer with limited memory addressability.
Modem	Modulator-demodulator. A device that transforms a computer's electrical pulses into audible tones for transmission over a phone line to another computer. A modem also receives incoming tones and transforms them into electrical signals that can be processed and stored by the computer.
MTBF	Mean Time Between Failures.
MTC	Magnetic Tape Controller (board).
MTU	Magnetic Tape Unit or Transport.
Multiplexing	The sharing of one resource among several users.
Multiprocessing	See Multiprocessor.
Multiprocessor	A small computer that has more than one CPU and is therefore able to process several instructions simultaneously; another form of parallel processing.
Multi-programming	The capability of a computer or operating system to do more than one thing at a time, such as run two or more application programs.
Multi-user	The capability of a computer or operating system to have more than one terminal attached and in use at the same time.

Some systems are multi-user but all the users must be running the same application.

N

- Nanosecond** One-billionth of a second. Computers work at speeds measured in nanoseconds.
- Network** A computer network is a complex consisting of two or more interconnected computing units. In teleprocessing, a number of communication lines interconnecting computers and remote terminals.
- Nybble** Usually four bits, or half a byte.

O

- OEM** Original Equipment Manufacturer. In the computer business, a company whose business is putting together computer systems made up of hardware, software products from different vendors, and their own products. Selling the combination as their own product.
- Off-line** The computer or some part of the system is not connected or not working. Can also mean the data processing that is not done by a computer, such as the clerical work required to prepare information for processing.
- On-line** Any device or data processing work under the direct control of the computer. Can also mean a component of the system is in operation.
- Operating System** OS. Software which controls the execution of computer programs, including scheduling and file management, and the flow of data to and from peripheral devices. Every computer system uses one or more; very few application programs can run on a computer without one.
- Output** In computer terminology, the processed information being delivered by a computer. Also the device employed to

accomplish this data delivery. Output may be for human or machine communication. Common output devices for human interface with the computer are printers, typewriter terminals and cathode ray video terminals.

Output Device

A machine that transfers programs or information from the computer to some other medium. Examples of output devices include tape, disk drives and bubble memory; computer printers, typewriters and plotters; the computer picture screen (video monitor); robots, and sound synthesis devices that enable the computer to talk and play music.

P

Packaged Software

A program designed for a specific application of broad, general usage, unadapted to any particular installation.

Partitioning

Logical grouping of electrical functions within a given set of hardware components.

PASCAL

A high-level programming language.

PCB

Printed Circuit Board. Insulated substrate (often plastic) upon which interconnection wiring has been applied by photographic techniques.

Peripheral

Any device in a data processing system, other than the computer, required to do the work. Examples are printers, tape cartridge, terminals, and so on.

Peripheral Devices

Any device that is external to and connected to the central processing unit but is not a part of the CPU. Includes input/output devices. Peripheral equipment may be used on-line or off-line depending upon the computer system design.

Pin

A connection point for electrical components and logical elements.

PL/1

Programming Language/1.

Plotter A mechanical device for drawing lines under computer control.

Plug Compatible Refers to the ability to add or substitute hardware components to a system regardless of the manufacturing origin of each item.

PM Preventive Maintenance.

Printer A device used to print data output from a computer, usually text (letters and numbers), using paper.

Printout Printed information (hard copy) produced by a computer's printer.

Processor The parts of a computer that actually do the calculating or data processing. It is often used interchangeably with "computer."

Program A sequence of instructions that results in the execution of an algorithm. Programs are essentially written at three levels: (1) binary (can be directly executed by the CPU), (2) assembly language (symbolic representation of the binary), (3) high-level language (such as BASIC), requiring a compiler or interpreter.

PROM Programmable Read Only Memory.

Prompt Any message or symbol from the computer system informing the user of possible actions or operations. A guide to the operator in use of the system.

Protocol Set of rules governing message exchange between two communication processes.

Public Domain Programs Commonly used business programs available for purchase from their developers or other vendors of the same type of system.

Q

QC Quality Control.

R

RAM	Random Access Memory. Data stored in RAM can be accessed on a direct basis, regardless of its location in storage. RAM is erasable so it is used to store application programs when they are running. When the program is finished, a different application can be run using the same memory.
Random Access	The capability to store information so that it can be retrieved independently of where it is stored in a file.
Raster Display	A display in which the entire display surface is scanned at a constant refresh rate.
Raster Scan	Line-by-line sweep across the entire display surface to generate elements of a display image.
Read	An instruction to a computer to acquire or interpret data from a storage device, a data medium or some other source.
Read Only Memory (ROM)	A memory in which information is stored permanently such as a math function. A ROM is programmed according to the user's requirements during memory fabrication and cannot be reprogrammed.
Real Time	Immediate and concurrent processing.
Record	The process of writing information, or the block of information itself.
Register	One word memory, usually implemented in fast flip-flops, directly accessible to a processor. Most CPUs include a set of integral registers that can be accessed much faster than the main memory.
ROM	Read Only Memory. Non-erasable memory storage device used to store instructions that are always needed by the computer, built-in diagnostics, for example.
Routine	A set of coded instructions arranged in correct sequence that directs a computer to perform a certain task or series of tasks.

S

- Security** Methods used to prevent unauthorized access to part or all of the information in a data base. An important consideration in systems where the data base is shared by several users.
- Semiconductor** A device or material with an electrical conductance that lies between the high conductivity of metals and low conductivity of insulators. Integrated circuits, transistors and diodes are the most common semiconductor devices.
- Sequential Access** The method in which data is accessed by scanning sequential blocks or records.
- Sequential File** Normally, a data file in which items are placed one directly after another, as records are kept in a file cabinet. Sequential files are characterized by slower access than are random access files.
- Soft Copy** Information contained magnetically in storage.
- Software** Collective name for a set of computer programs, procedures, rules, or machine instructions used in a computer system which directs its operation.
- Sort** A program to reorder data sequentially, usually in alphabetic or numeric order.
- Source** User-written instruction statements prior to translation by the computer into machine-executable form.
- Source Program** The statements the programmer writes to create an application using a particular language such as COBOL, BASIC, or Assembly. Also referred to as source code. Source programs must be translated to machine language before the computer can understand them. When programmers speak of the size of a program they talk of the number of "lines of code" for source programs.
- Stand-Alone** The ability of a computer to do its work independently of other computers.

Storage	Any device in a computer system used to retain information. Disks and magnetic tape cartridges are storage devices.
Storage Tube	A CRT which retains an image for a considerable period of time without re-drawing.
Subroutine	A program segment permitting a frequently required task to be called from any point of the main program. Execution is transferred to a subroutine when a subroutine call occurs. Subroutines save memory space at the expense of execution speed.
Support	The help provided by the seller of a product to enable the customer to use it effectively. Support services can include installation, training, trouble shooting, advice about a customer requirement, repair, and preventive maintenance.
Synchronous	One way of sending messages from one device to another within a specified length of time. Both devices must be "synchronized" by the same clock signal in order to communicate. It is most efficient when large volumes of data must be transferred.
Systems House	An independent, third-party firm that sells computer systems made up of hardware they acquire from one or more manufacturers. They usually include their own software products.
Systems Software	The package of programs that performs the basic functions of the system. The most fundamental component is known as the operating system, which manages the computer memory, the disk, and all of the other peripherals. The other programs are sometimes referred to as Utility Programs.

T

Tape	Inexpensive mass storage medium. Must be accessed sequentially. Convenient for large files.
-------------	---

Terminal	A device that acts as the point of communication between user and computer. Usually a terminal is a typewriter-like device or a video display unit with a keyboard.
Throughput	The amount of work that can be done by a computer system in a period of time.
Time Sharing	When two or more users work on the same computer simultaneously, each getting a "slice" of each second of the computer's processing time. Usually in systems where the users have only "dumb" terminals (no processing capability of their own) that communicate with a large, central computer.
Turnkey	Pertaining to a computer system sold in a ready-to-use state.
U	
Upgrade	Replacing a smaller one with a larger one to accommodate the growth of a business or its increasing needs for data processing.
Upward Compatibility	A computer is upward compatible with another if its capabilities are present on the second machine so that software and devices attached to the first may be used on the second. The second computer may have capabilities not found on the first; in that case it is "downward compatible" with the first computer. Upward compatibility is important for growth.
User Friendly	Descriptive of both hardware and software designed to assist the user by being scaled to human dimensions, self-instructing, error proof, etc.
Utility	Software for routine tasks or for assisting of programmers.
Utility Program	A system software program that helps programmers and users perform specific types of common jobs. A program that sorts names and addresses is a common utility.

V

Video Display Terminal (VDT)

A computer picture screen and keyboard.

VLSI

Very Large Scale Integration. In practice, the compression of more than 10,000 transistors on a single chip.

W

Winchester Disk

A "hard" disk that is completely enclosed, preventing contamination from the environment.

Word

A logical unit of information. It may have any number of bits, but it is usually four, eight or 16 for micro-computers.

Word Processing (WP)

The form of data processing concerned with recording, editing and storing written text and data for the purpose of creating printed reports and documents.

Word Processor

A text editor system for electronically writing, formatting and storing letters, reports and books prior to printing.

Write

To transfer data from internal to external memory.

INDEX

- Application programs, 2-8
 - Altos Accountant, 2-8
 - Altos Executive Financial Planner, 2-8
 - Altos Executive Word Processor, 2-8

- Booting, 8-2, 14-1
 - errors during, 14-2—14-4

- Cables
 - connecting parallel printers, 7-2, C-7
 - connecting serial printers, 7-1, C-6
 - terminals, 6-1, 6-3, C-2—C-5
- Claims, see damage
- Communication utilities, 2-8
- Control key, viii
- CPU, def., 1-3—1-4

- Damage, B-3
- Data
 - changing invalid, ix
 - entering, viii
- Diagnostic Program, 10-4
 - summary, 10-5
- Diagnostics, 2-2, 10-2, 10-3
- Disk drives
 - opening, 9-1
 - positioning, 5-2
- Disk, hard
 - read errors, 14-2—14-3
 - specifications, A-1
 - testing, 10-4
- Diskettes, floppy, 14-1
 - care of, 9-1, 9-2—9-3
 - drive light, none, 13-3
 - insertion, 9-1
 - read error, 14-3—14-4
 - storing, 9-2
 - write-protection, 9-2

- Erasing
 - characters, ix
 - entire entry, ix

- Error messages, monitor, 14-2—14-4

- Floppy diskettes, see diskettes, floppy

- Hard disk, see Disk, hard

- Installing operating system, 10-3

- Languages, 2-8

- Maintenance
 - CPU, 12-1
 - diskette, 9-1, 9-2—9-3
 - humidity range, A-2
 - temperature range, A-2
- Manuals
 - Altos, x
 - Other vendors, x-xi
- Monitor, def., 14-1
 - error messages, 14-2—14-4

- OASIS, 2-6
- Operating systems, 2-3, 5-4
 - multi-user, 2-4—2-5
 - single-user, 2-4
- Options
 - UK-10, 3-2

- Power supply, A-2, A-4
- Printers, def., 1-5
 - connecting, C-1
 - parallel, C-7
 - serial, C-6
 - problems, 13-4
 - troubleshooting, 13-4
- Program, Diagnostic, 10-4
 - summary, 10-5
- Programs, application, 2-8
 - Altos Accountant, 2-8
 - Altos Executive Financial Planner, 2-8

Altos Executive Word Proces-
sor, 2-8

Repair, B-4—B-5

Service, B-4—B-5

Setting up, 6-1, 6-3, 7-1—7-
2, 8-1

Software, def., 2-1

application program, 2-8

communications, 2-8

diagnostics, 2-2

languages, 2-8

operating systems, 2-3—2-6,
5-4

utilities, 2-7

Specifications, system, A-1—
A-2

Terminals, def., 1-4—1-5

connecting, C-2—C-5

problems

cursor, 13-2

display, 13-1—13-2

keyboard input response,
13-2

setting parameters, 6-3

turning on, 8-2

Tests, system, 10-1

automatic, 10-2

operator, 10-3

Troubleshooting

fan, 13-3

floppy diskette drive, 13-3

printer, 13-4

terminal, 13-1—13-2

Turning off system, 11-1

Turning on power, 8-2

UK-10, 3-2

Upgrade Kit, 3-2

Utilities

BACKUP, 2-7

File transfer program (ftp),
2-7

Warranty, B-1—B-2

Write-protect, diskette, 9-2



2641 Orchard Parkway, San Jose, CA 95134

(408) 946-6700 Telex: 171562 ALTOS SNJ or 470642 ALTO UI