

**BUTTON-SHAPED DEVICE OFFERS DIGITAL IDs  
THE FUNDAMENTALS OF DIGITAL-FILTER DESIGN**

FOR ENGINEERS AND ENGINEERING MANAGERS — WORLDWIDE

# **ELECTRONIC DESIGN**

A PENTON PUBLICATION U.S. \$5.00

JULY 25, 1991



## **RISC CHIP SET "SPARCS" RACE FOR LOW-COST WORKSTATIONS**

- SPECIAL REPORT: SWITCHING-REGULATOR IC TECHNOLOGY
- PIPS: POWER, INTERCONNECTS, PASSIVES, SWITCHES/RELAYS

**QUICKLOOK**

# RS-232 TRANSCEIVERS

# $I_{SUPPLY} = 500\mu A!$

## Optimize Power Consumption

Maxim has designed its new MAX220/MAX222/MAX242 dual +5V RS-232 transceivers specifically for systems requiring low power operation. The MAX220 dual transceiver's quiescent operating supply current is a mere 500 $\mu A$  typical (unloaded), while the MAX222 saves power instead with a 10 $\mu A$  shutdown mode. The MAX242 is similar to the MAX222, but the receivers remain active in shutdown mode and have their own three-state enable. And, the MAX222/242 use small 0.1 $\mu F$  capacitors, saving valuable real estate in portable applications.

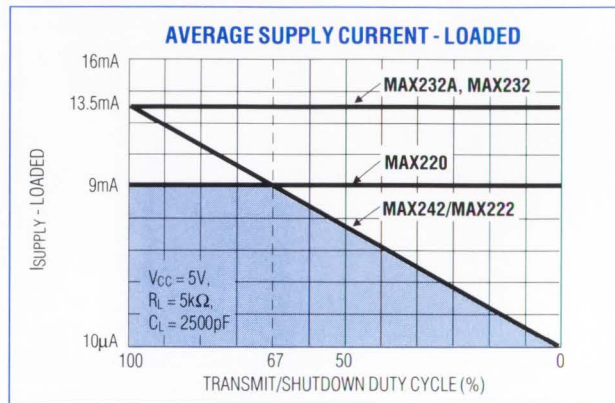

To conserve power, use the MAX220 when transmitting data more than 2/3 of the time. Use the MAX222/MAX242 with shutdown when transmitting less than 2/3 of the time.

## Select a Dual Transceiver For Your Low Power Application

Part Number	Guaranteed kb/sec	External Caps ( $\mu F$ )	Supply Current No Load (mA) max	Shutdown & Three-State	Features	Price*
MAX220	20	4.7/10	2	No	Lowest Power @ >2/3 xmit/SHDN Duty Cycle	\$2.65
MAX222	116	0.1	10	Yes	Lowest Power @ <2/3 xmit/SHDN Duty Cycle	\$2.65
MAX242	116	0.1	10	Yes	MAX222 + Receivers Active in Shutdown	\$2.65

\* 1000-up FOB USA, suggested resale

The cover of the 'FREE Interface Design Guide' features the title 'INTERFACE ANALOG DESIGN GUIDE' and 'New RS-232 Transceiver Doubles Speed of Existing +5V RS-232 Devices!'. It includes a graph of a signal waveform and the text 'RS-232 at 1/10th the Power!'.

## FREE Interface Design Guide

Including: Application Notes ♦ Complete Data Sheets ♦ Cards For Free Samples

Simply circle the reader response number, contact your Maxim representative or Maxim Integrated Products, 120 San Gabriel Drive, Sunnyvale, CA 94086, (408) 737-7600, FAX (408) 737-7194.



Distributed by Arrow, Bell/Graham, Elmo, Hall-Mark, Nu Horizons, Pioneer, and Wyle. Authorized Maxim Representatives: Alabama, (205) 830-0498; Arizona, (602) 730-8093; California, (408) 248-5300, (619) 278-8021, (714) 261-2123; (818) 704-1655; Colorado, (303) 799-3435; Connecticut, (203) 384-1112; Delaware, (609) 778-5353; Florida, (305) 426-4601, (407) 830-8444; Georgia, (404) 447-6124; Idaho, (503) 292-8840; Illinois, (708) 358-6622; Indiana, (317) 844-8462; Iowa, (319) 393-2232; Kansas, (816) 436-6445; Louisiana, (214) 238-7500; Maryland, (301) 644-5700; Massachusetts, (617) 329-3454; Michigan, (313) 352-5454; Minnesota, (612) 944-8545; Mississippi, (205) 830-0498; Missouri, (314) 839-0033, (816) 436-6445; Montana, (503) 292-8840; Nebraska, (816) 436-6445; Nevada, (408) 248-5300; New Hampshire, (617) 329-3454; New Jersey, (201) 428-0600, (609) 778-5353; New Mexico, (602) 730-8093; New York, (201) 428-0600, (607) 754-2171; N. Carolina, (919) 851-0010; Ohio, (216) 659-9224, (513) 278-0714, (614) 895-1447; Oklahoma, (214) 238-7500; Oregon, (503) 292-8840; E. Pennsylvania, (609) 778-5353; W. Pennsylvania, (614) 895-1447; S. Carolina, (919) 851-0010; Tennessee, (404) 447-6124; Texas, (214) 238-7500, (512) 835-5822, (713) 789-2426; Utah, (801) 561-5099; Virginia, (301)644-5700; Washington, (206) 823-9535; W. Virginia, (513) 278-0714; Canada, (416) 238-0366, (613) 225-5161, (604) 276-8735, (514) 337-7540.

Maxim is a registered trademark of Maxim Integrated Products. © 1991 Maxim Integrated Products.

CIRCLE 288 FOR U.S. RESPONSE

CIRCLE 289 FOR RESPONSE OUTSIDE THE U.S.

# A question for designers who aren't yet using high-performance $\mu$ PLDs.

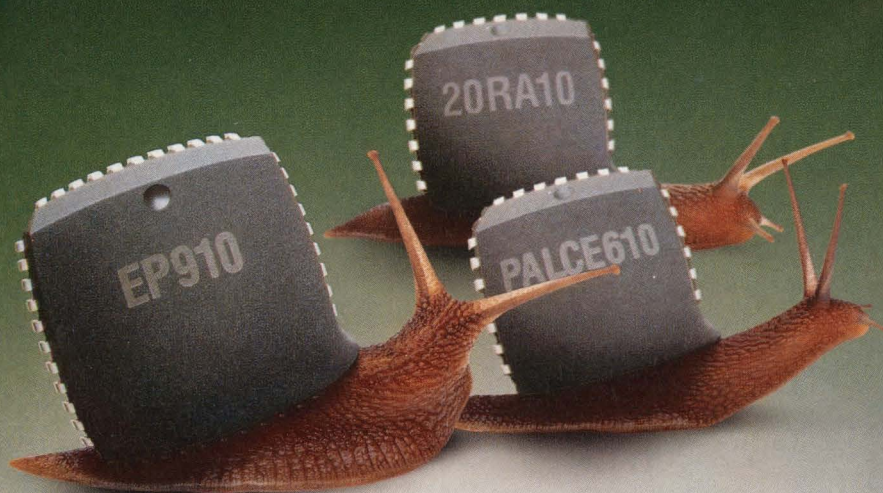

## Why the big delay?

Ever feel like your system designs aren't quite up to speed, so to speak? It's probably not your fault. Because PLDs have typically forced designers to sacrifice performance to achieve higher integration.

PLD Performance	
PLD	$t_{PD}^*$
Intel 85C060	10ns
PALCE610	15ns
20RA10	15ns
EP610	16ns
Intel 85C090	15ns
EP910	33ns

\*Propagation Delay

But not any more. Now, with Intel's  $\mu$ PLD family of programmable logic devices, you can finally achieve the higher integration you need—with the low total propagation delay you want.

In fact, with  $t_{PD}$  figures as low as 10ns, Intel's 16-macrocell 85C060

and 24-macrocell 85C090 are, without question, the fastest integrated PLDs in the industry.

So what are you waiting for? Call (800) 548-4725 and ask for Literature Packet #1A81.

We'll send you everything you need to know about how to improve system performance. Without delay.

**intel**<sup>®</sup>  
The Computer Inside.™

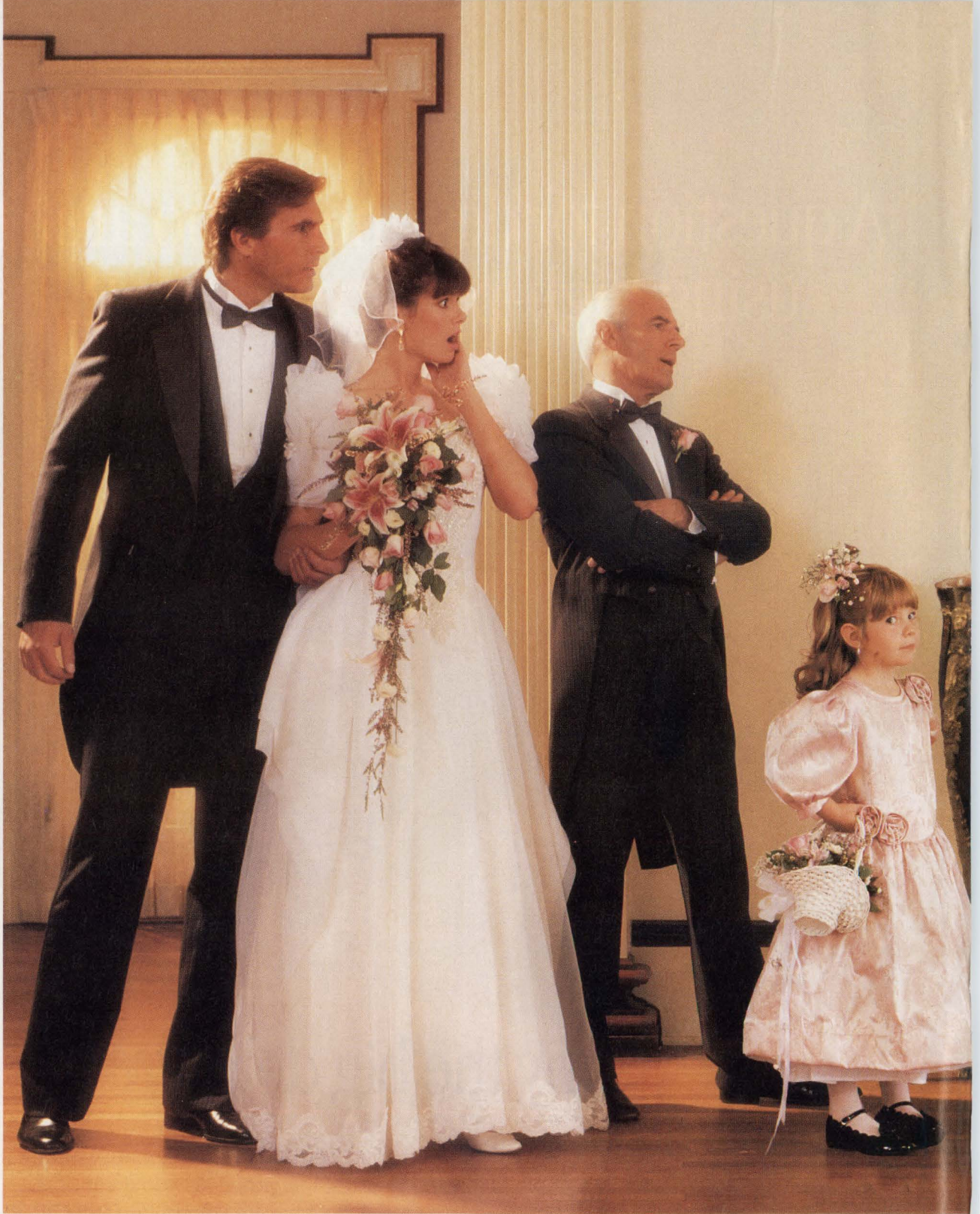

*[Faint, illegible text, likely bleed-through from the reverse side of the page]*



When Smith Corona's  
production line went  
down, HP support  
was up and running.

**It happened on a freezing  
Saturday in February.**

Joe Reiley, a Hewlett-Packard test and measurement support engineer, was at a wedding in Pottstown, Pennsylvania. The office was the furthest thing from his mind, when suddenly his beeper went off.

In minutes, Joe was on the phone to Travis Field, the support engineer for Smith Corona in Cortland, New York. An HP test system crucial to Smith Corona's production line had gone down. Suddenly, Joe's thoughts turned to figuring out how to get Smith Corona's production line back up. Joe bid the other guests goodbye and ran to his car.

After driving through a blinding snow storm over icy mountain roads, Joe pulled into Smith Corona at 10:30 pm. A thorough analysis of the problem made it clear they needed extra parts, so Joe called another HP support engineer, Pete Nahrgang, in Valley Forge. Working through the early morning, Pete took parts from a back-up HP system, then flew them to Cortland by special courier. By Sunday afternoon, just 24 hours after Joe's beeper first went off, Smith Corona's production line was up again.

True stories like this prove HP's dedication to responsive customer support throughout the world. We'll tailor our hardware, software and education services to your test and measurement needs. With one of the largest support organizations in the industry, we're committed to keeping your production line up and running. For more information, call your local HP sales office or circle the reader service number.

**There is a better way.**



**HEWLETT  
PACKARD**

© 1990 Hewlett-Packard Co. TMT&M034

CIRCLE 284 FOR U.S. RESPONSE  
CIRCLE 285 FOR RESPONSE OUTSIDE THE U.S.

# ELECTRONIC DESIGN



**COVER FEATURE** **45 CHIP SET ADDRESSES LOW-COST WORKSTATIONS**  
Design Sparc-based workstations with 50% fewer chips than before.

**ELECTRONIC DESIGN REPORT** **53 DESIGNING SWITCHERS GETS EASIER**  
Switch-mode regulator ICs, with controller and power switch on one die, move to volume jobs.

**DESIGN APPLICATIONS** **83 LEARN THE FUNDAMENTALS OF DIGITAL FILTER DESIGN**  
Basic techniques let designers build a finite-impulse-response filter in dedicated hardware using programmable logic.

**PRODUCT INNOVATIONS** **153 MEMORY-BASED IDENTIFIER TAG PROVIDES DIGITAL ID**  
Housed in button-shaped metal cans, digital memories offer electronic IDs for security, parts tracking, and more.

**159 MIXED-SIGNAL LIBRARY USES BREADBOARD AND SIMULATION**  
A "heavy on the analog," mixed-signal standard-cell library in CMOS offers silicon to breadboard and Spice models for simulation.

**165 X-TERMINALS EVOLVE TO NEXT LEVEL: NO ENCLOSURE BOX**  
ASIC eliminates enough components to allow controller board to fit inside monitor box.

## 14 EDITORIAL

### 18 TECHNOLOGY BRIEFING

Don't we need more generalists?

### 23 TECHNOLOGY NEWSLETTER

- EDA framework program eases tool integration
- NTC-thermistor made more accurate
- Discrete power MOSFETs get brains
- 16-Mbit DRAMs ready for commercial samples
- VHDL emerges as the PLD design standard
- Connector data comes via CD-ROM and fax
- Controller IC breeds fast power diodes
- Behavioral models mix accuracy and speed

### 32 TECHNOLOGY ADVANCES

- Boolean verification shortcuts circuit evaluation when comparing old and new
- Mini 486-based PC runs at 40 MHz
- Multichip modules hit desktops in prototype demonstration by IBM
- Servo simulator cuts disk-drive development time



Jesse H. Neal Editorial Achievement Awards:  
1967 First Place Award  
1968 First Place Award  
1972 Certificate of Merit  
1975 Two Certificates of Merit  
1976 Certificate of Merit  
1978 Certificate of Merit  
1980 Certificate of Merit  
1986 First Place Award  
1989 Certificate of Merit

Cover: Joe Drivas

## PIPS SPECIAL EDITORIAL FEATURE

97 Electromechanical relays: Factors to consider before buying

103 Switches

117 Relays

125 Power

126 Interconnects

127 Passives

128 New Literature

### 131 IDEAS FOR DESIGN

- Set comparator's window limits
- Probe drives low-impedance inputs
- View low duty-cycle waveform

### 139 QUICK LOOK

- Perspectives on Time-to-Market: Doing reports
- Sales of graphics workstations are going strong
- Free software demo disks
- Book details computer security

### 146 PEASE PORRIDGE

What's all this Widlar stuff, anyhow?

### NEW PRODUCTS

#### 167 Power

Rechargeable-battery system meets new environmental laws

#### 169 Computers & Peripherals

486-based desktop PC runs at 50 MHz

#### 170 Instruments

#### 172 Components

#### 173 Computer-Aided Engineering

#### 175 Computer Boards

### 180 INDEX OF ADVERTISERS

### 181 READER SERVICE CARD

## COMING NEXT ISSUE

- Special Report: RAMDACs offer more colors for better graphics
- Characterizing ASICs before integration on the board
- Special Section on Automotive Electronics: Advances in multiplexed buses
- First details on a revolutionary new accelerometer IC
- A new biCMOS array speeds communications development
- PLUS:  
Ideas for Design  
Pease Porridge  
Technology Advances  
QuickLook

ELECTRONIC DESIGN (USPS 172-080; ISSN 0013-4872) is published semi monthly by Penton Publishing Inc., 1100 Superior Ave., Cleveland, OH 44114-2543. Paid rates for a one year subscription are as follows: \$85 U.S., \$160 Canada, \$230 International. Second-class postage paid at Cleveland, OH, and additional mailing offices. Editorial and advertising addresses: ELECTRONIC DESIGN, 611 Route #46 West, Hasbrouck Heights, NJ 07604. Telephone (201) 393-6060. Facsimile (201) 393-0204.

Printed in U.S.A. Title registered in U.S. Patent Office. Copyright © 1991 by Penton Publishing Inc. All rights reserved. The contents of this publication may not be reproduced in whole or in part without the consent of the copyright owner.

Permission is granted to users registered with the Copyright Clearance Center Inc. (CCC) to photocopy any article, with the exception of those for which separate copyright ownership is indicated on the first page of the article, provided that a base fee of \$1 per copy of the article plus \$.50 per page is paid directly to the CCC, 27 Congress St., Salem, MA 01970 (Code No. 0013-4872/91 \$1.00 + .50). (Can. GST #R126431964) Copying done for other than personal or internal reference use without the express permission of Penton Publishing, Inc. is prohibited. Requests for special permission or bulk orders should be addressed to the editor.

For subscriber change of address and subscription inquiries, call (216) 696-7000.

POSTMASTER: Please send change of address to ELECTRONIC DESIGN, Penton Publishing Inc., 1100 Superior Ave., Cleveland, OH 44114-2543.

# HOW ENGINEERING SEES OUR NEW 32-BIT INTEGRATED PROCESSOR.



Actually, a bullet doesn't do it justice. But you get the picture. Motorola's new 68330 integrated microprocessor is fast.

And well it should be. After all, it gets its firepower from a 68020-based core processor that's optimized to run on a 16-bit data bus. So you get 32-bit microprocessor performance with the economy of a 16-bit memory system.

As the simplest and lowest priced member of the 68300 family, the '330 is an ideal companion to your favorite peripheral circuits. Even if you've already combined them into an ASIC or custom circuit.

What's more, the 68330's Systems Integration Module comes already loaded with system glue logic. Saving you the trouble of designing in functions like clock

68000 MICROPROCESSOR FAMILIES					
68000 CPUs Architectural Integration	000	020	030	040	
68EC000 EMBEDDED Performance/Cost	EC000	EC020	EC030	EC040	
68300 INTEGRATED Functional Integration	302	330	331	332	340

*Motorola's 68000 families let you choose the performance and integration that's right for your application.*



# HOW PURCHASING SEES IT.

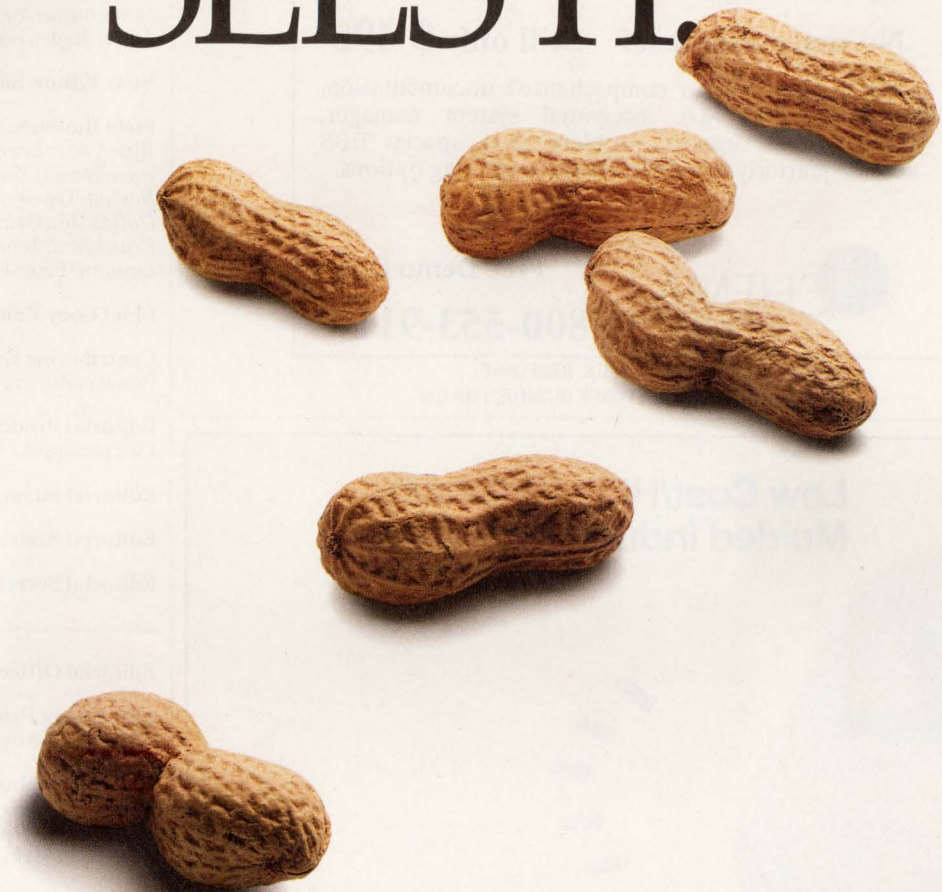

generation, chip selects and interrupt control.

And, since the '330 is fully binary software compatible with all members of the 68000 and 68300 families, it provides a seamless migration path, reams of reusable code, popular operating systems and familiar development tools.

All of which can save you a lot of trouble, while lowering overall system costs and raising your accountants' morale.

So if you're looking for 32-bit performance at a 16-bit system price, call 1-800-845-MOTO. Ask for a free 68330 product sample\* and discover a high-caliber value.



**MOTOROLA**

**NEW**

## SCHEMA III 3.3 schematic capture

### User Manual Included...

(but you probably won't need it)

The leader in price performance and ease of use in PC based schematic capture software is now shipping the all NEW, expanded version 3.3. Over 30 new features have been added to an already feature rich system.

\* online help/documentation for each command \* quick start tutorials \* full network compatibility \* unlimited hierarchies & drawing sizes \* incremental design compiler \* more microprocessors, PLDs & analog parts (7,500+ total parts) \* expanded editing commands \* EZ-Parts creator \* zoom plus hi/low res toggle \* PostScript, TIFF, DXF and much more!

**No price increase! Still only \$ 495**

Each license includes comprehensive documentation, tutorials, SCHEMA integrated system manager, FREE 1-800 support, problem fixes, special BBS access, quarterly newsletter & video training options.



Free Demo Disk

**800-553-9119**

CIRCLE 258 FOR U.S. RESPONSE  
CIRCLE 259 FOR RESPONSE OUTSIDE THE U.S.

## Low Cost/High Reliability Molded Inductors

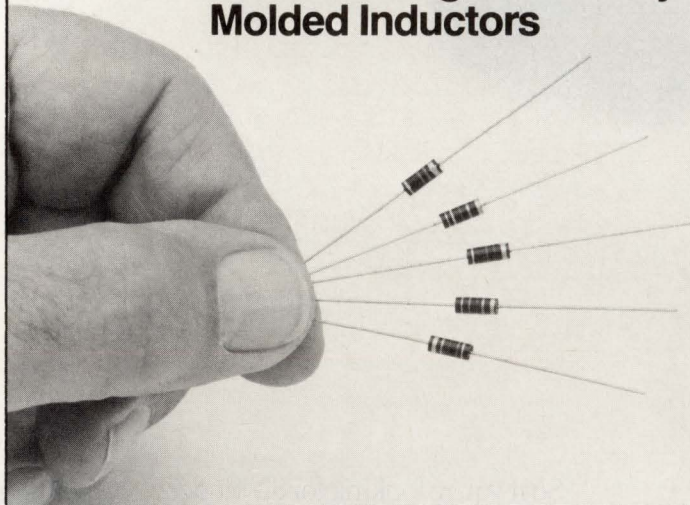

Manufactured in accordance with all requirements of MIL-C-15305

The 9110 and 9130 series inductors are ideal for industrial and commercial applications... use ferrite cores in lieu of powdered iron cores in comparable MIL Spec series.

- Precision Performance
  - High Reliability
  - Sturdy Construction
  - Uniform Size
  - Ideal For Automatic Insertion Equipment
- Catalog on Request



### J.W. Miller Division

BELL INDUSTRIES

306 E. Alondra Blvd., Gardena, CA 90248

Phone: 213-515-1720 FAX: 213-515-1962

Since 1924, Leading Manufacturer of Standard and Custom Inductors

CIRCLE 166 FOR U.S. RESPONSE  
CIRCLE 167 FOR RESPONSE OUTSIDE THE U.S.

# ELECTRONIC DESIGN

**Editor-in-Chief:** Stephen E. Scrupski

**Executive Editor:** Roger Allan

**Managing Editor:** Bob Milne

**Senior Editors:** Frank Goodenough,  
Milt Leonard, John Novellino

**Technology Editors:**

*Analog & Power:* Frank Goodenough

*Communications & Industrial:*

Milt Leonard (San Jose)

*Components & Packaging:* David Maliniak

*Computer-Aided Engineering:*

Lisa Maliniak

*Computer Systems:* Richard Nass

*Semiconductors:* Dave Bursky (San Jose)

*Test & Measurement:* John Novellino

**News Editor:** Sherrie Van Tyle

**Field Bureaus:**

*West Coast Executive Editor:*

Dave Bursky (San Jose)

*Boston:* Lawrence Curran

*Dallas:* Jon Campbell

*Frankfurt:* John Gosch

*London:* Peter Fletcher

**Chief Copy Editor:** Roger Engelke, Jr.

**Contributing Editors:**

Ron Kmetovicz, Robert A. Pease

**Editorial Production Manager:**

Lisa Iarkowski

**Editorial Support Supervisor:** Mary James

**Editorial Assistant:** Ann Kunzweiler

**Editorial Secretary:** Bradie Guerrero

**Editorial Offices:** (201) 393-6262

**Advertising Production:**

(201) 393-6093 or FAX (201) 393-0410

**Production Manager:** Michael McCabe

*Production Assistants:*

Donna Marie Bright, Lucrezia Hlavaty,

Eileen Slavinsky

**Circulation Manager:** Robert Clark

**Promotion Manager:** Clifford Meth

**Reprints:** Helen Ryan 1-800-835-7746

**Group Art Director:** Peter K. Jeziorski

**Computer Systems Administrator:**

Anne Gilio Turtoro

**Published by Penton Publishing**

**Vice President-Editorial:** Perry Pascarella

**Group Editorial Director:** Leland Teschler

**Publisher:** Paul C. Mazzacano

# UXART

## The Wait Is Over.

Now there's a serial I/O chip designed for UNIX.

For years, dumb UARTs have been the standard datacom solution. Now there's something better for today's multi-user, multi-protocol datacom environment. Our single-chip solution gives you multiple channels — each capable of full-duplex operation at 115.2 kbps — and replaces up to 10 chips.

Cirrus Logic introduces the UXART — the first and only UART with specific features to simplify and speed up serial I/O efficiency by a factor of ten or more. So your UNIX® system can support more users, with better response time — and less waiting.

The CL-CD1400 UXART™ gives you 4 fully independent datacom channels, each capable of full-duplex operation at 115.2 kbps. Each channel has two 12 byte FIFOs, one for transmit and one for receive. Separate vectored interrupts allow quick entry to the correct service routine.

A number of features reduce the load on the host system. Automatic expansion of Newline to CRNL, plus other CR and NL options. User-definable flow control characters for automatic flow control.

All five types of UNIX-specified parity and error handling. And more.

For high-line-count, cost-effective applications, there's the CL-CD180. It offers performance gains similar to the CL-CD1400, plus the advantage of 8 channels in a single 84-pin package.

The CL-CD2400 adds synchronous capabilities. It offers 4 independent, multi-protocol channels, plus an on-chip DMA controller for fast, efficient I/O.

For all your multi-protocol, multi-user datacom needs, the Cirrus Logic family of intelligent, high-performance data communications controllers gives you superior throughput in less space — with less waiting.

Don't wait. Call today for *free* product information and benchmark report on the CL-CD1400. **Call 1-800-952-6300. Ask for dept. LD35**

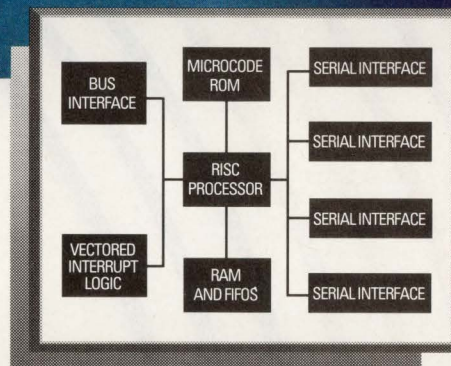

An on-chip 10 MIPS RISC-based processor handles transmit and receive functions, buffer management, flow control, and all special character processing. On-chip FIFOs reduce host interrupts to give you more efficient interrupt handling. The result: faster system throughput, lower host overhead, and less waiting.

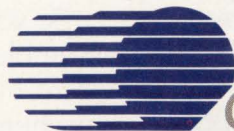

CIRRUS LOGIC

C L O S I N G T H E G A P

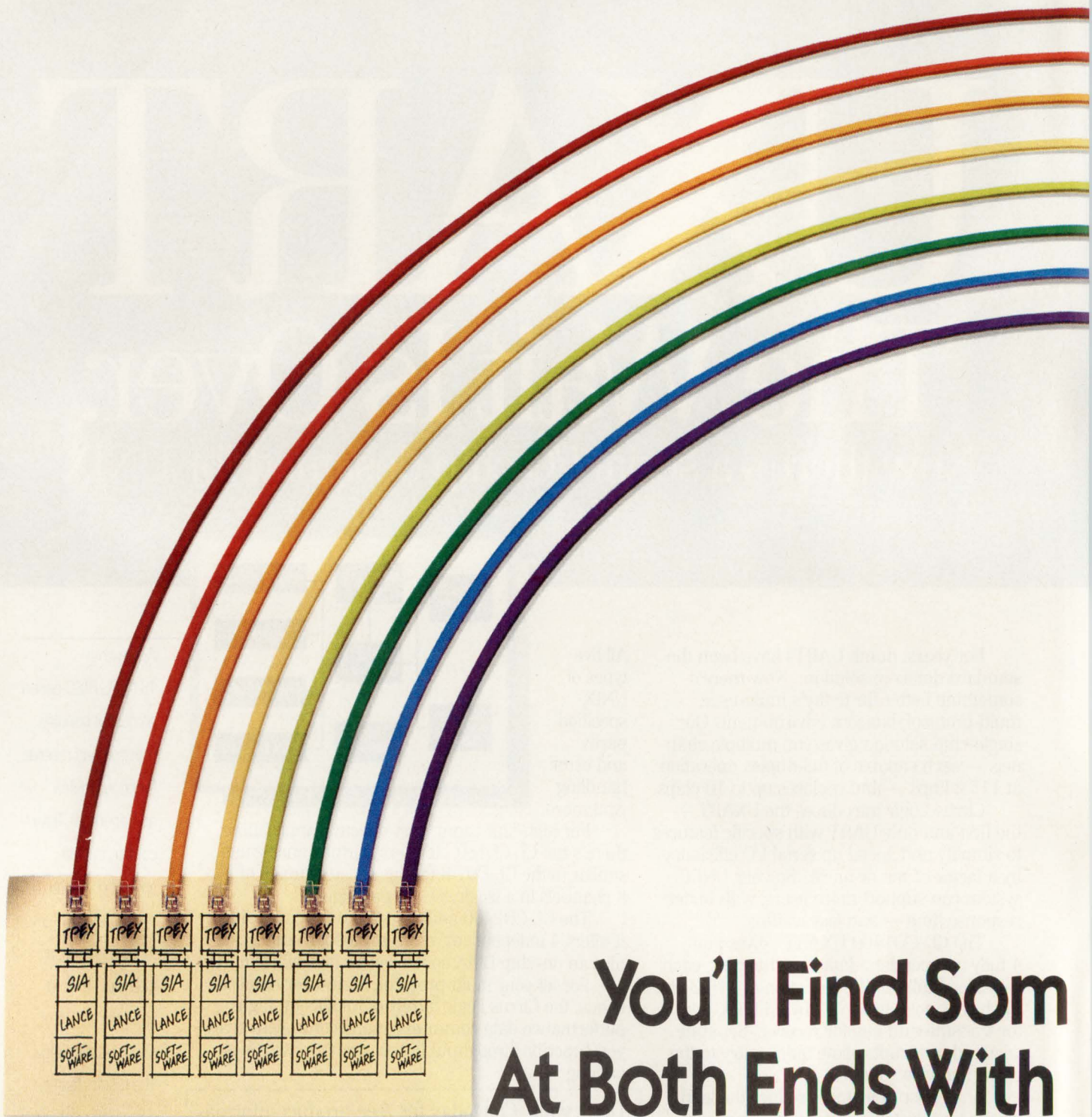

# You'll Find Som At Both Ends With

We've all seen the light regarding Ethernet on twisted-pair. Now we'd like to show you the full spectrum in IOBASE-T— with the most complete selection of silicon for both ends of the LAN.

At the terminal end, the TPEX™ (twisted-pair Ethernet transceiver) provides the physical layer connection for add-in cards, motherboards and stand-alone MAUs. At the hub end, the IMR™ (Integrated Multiport Repeater) integrates eight

transceivers and an expansion port on one chip, and replaces over a dozen ICs. And that brings down your per-port cost.

**TPEX**

Am79C980JC



**IMR**

Am79C98JC

So you can quickly design and assemble everything from compact Velcro® hubs that hang virtually anywhere, to larger intelligent hubs using multiple IMRs.

And you won't find the design

# Something Great AMD's 10BASE-T.

risks you normally face. We'll lead you to market faster, supplying you with complete board level solutions. And we're behind you all the way with 10 years experience in Ethernet, including strategic partnerships with SynOptics and HP — co-developers of our TPEX and IMR, respectively.

And of course, all our 10BASE-T products comply with current IEEE specs.

So call AMD today at **1-800-222-9323**

CIRCLE 266 FOR U.S. RESPONSE

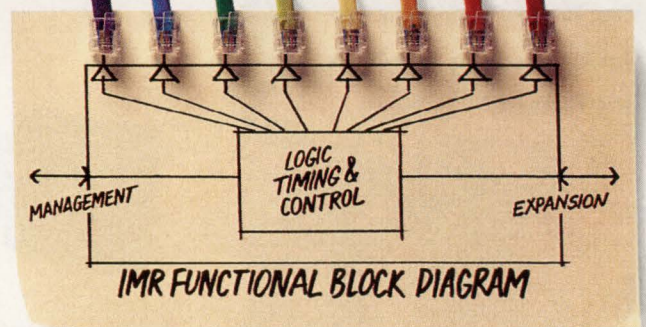

for a free information package. And give your next 10BASE-T design a truly brilliant ending.



## Advanced Micro Devices

© 1991 Advanced Micro Devices, Inc. 901 Thompson Place, P.O. Box 3453, Sunnyvale, CA 94088. TPEX and IMR are trademarks of Advanced Micro Devices, Inc. Velcro is a registered trademark of Velcro Industries B.V. (Netherlands Corporation), Amsterdam, Netherlands.

CIRCLE 267 FOR RESPONSE OUTSIDE THE U.S.

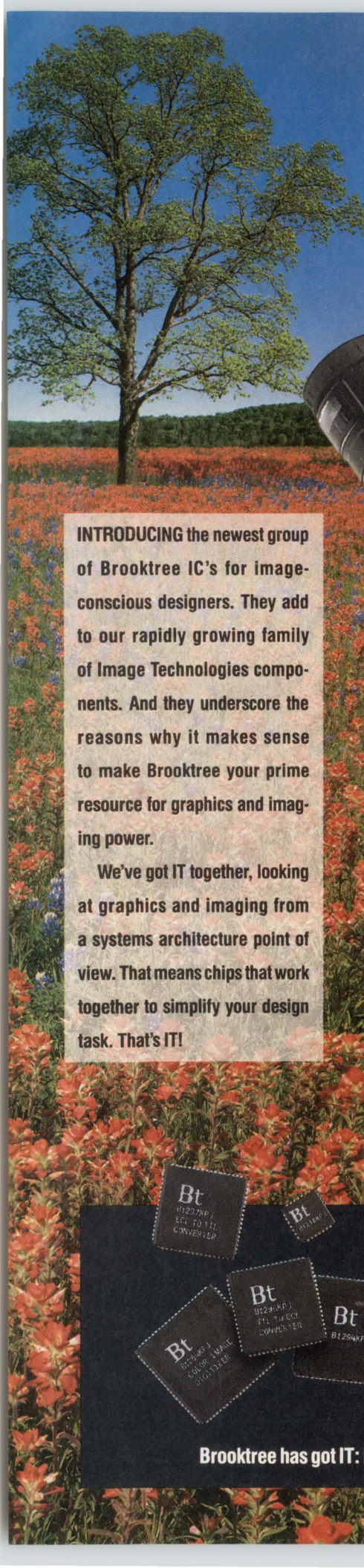

**INTRODUCING** the newest group of Brooktree IC's for image-conscious designers. They add to our rapidly growing family of Image Technologies components. And they underscore the reasons why it makes sense to make Brooktree your prime resource for graphics and imaging power.

We've got IT together, looking at graphics and imaging from a systems architecture point of view. That means chips that work together to simplify your design task. That's IT!

**IMAGE ACQUISITION.** We've got chip sets that bring image capture to your system with an added dimension: Image quality, made possible by three new 30 MSPS devices that support higher resolutions.

The Bt252 Gray-Scale Image Digitizer, with its onboard lookup table, is perfect for machine vision applications.

The Bt254 Color Image Digitizer's triple Flash A/D's digitize your analog RGB for low noise, high quality multimedia applications.

And our new Bt218 30 MSPS single channel CMOS Flash A/D provides another basic building block for image acquisition.

Team any of the three with our Bt261 30 MHz line lock controller and one of our true-color RAMDACs for a complete image acquisition system on a board.



*Convert and optimize its color space in real time,*



*Capture an image and digitize it,*

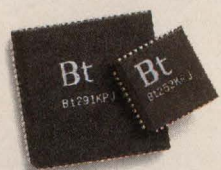

**IMAGE RECEPTION.** We've got chip sets to send and receive true-color digital video using an 8-bit interface. Our Bt294 CCIR 601/SMPTE RP 125 Decoder works with our upcoming Bt297 ECL-TTL Translator for a complete solution to 4:2:2 digital component video.



# WHAT

**Brooktree has got IT: Image Technologies. It's our system-smart approach to packing image acquisition, manipulation,**



send it and receive it as live color video then display it in high resolution true-color



**IMAGE TRANSMISSION.** We did say complete solution, didn't we? The Bt291 CCIR 601/SMPTE RP 125 Encoder teams with the upcoming Bt296 TTL-ECL Translator to provide cost effective 4:2:2 digital component video transmission without adjustments or support circuitry. In combination with the Bt294/297 reception devices, they make it easy and economical to add point-to-point video transmission to your multimedia system.

and do it all with Brooktree's Image Technologies. They make it easy to give your PC or WS design a visual edge in today's competitive markets.

**IMAGE PRESENTATION.** When it comes to display technology, we're where IT's at: We revolutionized RAMDACs. Now we're setting a new performance standard for super VGA, high-end XGA, 8514/A, TIGA compatible and x. terminal applications. It's the Bt484 true-color RAMDAC.

Its programmable pixel depth means you can run at 4 bits/pixel with 8:1 multiplex, 8 bits/pixel with a 4:1 MUX, 16 bits/pixel at 2:1 MUX or even 32 bits/pixel for 24-bit true color and 8-bit VGA. And its 32x32x2 three-color, user-definable cursor is absolutely awesome.

**GET IT NOW.**

Get with IT with Brooktree. Make us your source for Image Technologies products and information. We've assembled especially useful packets of technical information, geared to your special interest. To get yours, call 1-800-VIDEO IC. Or write Brooktree Corporation, 9950 Barnes Canyon Rd., San Diego, CA 92121. (619) 452-7580. FAX (619) 452-7294.

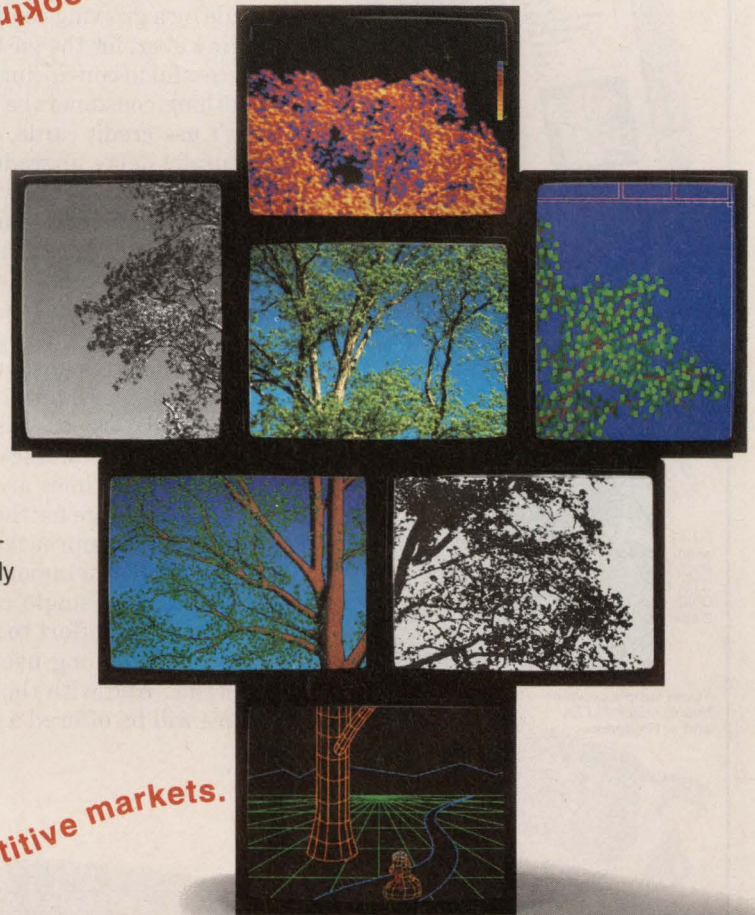

© 1991 Brooktree Corporation.

# IT IS.

transmission and presentation into highly-integrated, tightly-linked chip sets.

# Brooktree®

CIRCLE 196 FOR U.S. RESPONSE  
CIRCLE 197 FOR RESPONSE OUTSIDE THE U.S.

## LCD Proto Kit

Everything you need to start your LCD application ... create complex screens in just a few hours!



### Kit also includes:



**\$495 - Kit**  
Popular LCD Starter Kit.



(\$595 pre-assembled & tested)

\*The CY325 40-pin CMOS LCD Controller IC is available from stock @ \$75/singles, \$20/1000s (Surface mount also avail in qty.)

## CyberneticMicroSystems

Box 3000 • San Gregorio CA 94074  
Tel: 415-726-3000 • Fax: 415-726-3003

CIRCLE 202 FOR U.S. RESPONSE  
CIRCLE 203 FOR RESPONSE OUTSIDE THE U.S.

## EDITORIAL

### OUT WITH THE OLD...?

I can recall, several years ago, peering down into the parking lot from our fourth-floor office window at a full-sized dumpster loaded with computer terminals, first-generation portable computers, specialized desktop calculators, and the like. Our accounting department had upgraded its equipment, and these things became expendable. A few editors raced downstairs to rescue some of the equipment for personal tinkering. My reaction was one of surprise that we were throwing out such seemingly valuable equipment. At one time, those boxes were the best that the industry had to offer. Now, only a few years later, they were lying in the scrap heap, replaced by better systems made by a growing computer industry.

However, for the past year or more, the computer industry has not been as successful in convincing customers that it's time to call in the dumpsters. For one thing, consumers have cut their spending, and when people don't buy houses, don't use credit cards, don't buy insurance, etc., the sellers of such services naturally delay upgrading their computers. This has certainly been the case during the past year, even with the price cuts that have occurred.

Yet, despite the market's slowdown, the introduction of new computer hardware continues at a rapid pace. These new systems are based on the wealth of innovative technology—new RISC, as well as conventional processor chips—that continue to emerge from the semiconductor makers. However, this wealth of new technology will take some time to become assimilated into user systems. The expansion of user choices brought on by open systems, as well as the rapid advances made in software—for example, networking and desktop publishing software—has caused potential users to delay their hardware purchases until they can evaluate every possible choice.

Product lifetimes are shortening, and the new-product introductions are setting the stage for the next wave of growth for the computer industry. But as that wave approaches, it's becoming clear that the computer industry is undergoing a metamorphosis. The IBM-Apple Computer agreement demonstrates that a single company can no longer dominate any broad market segment. The effort to make computers easier to use has, in fact, resulted in confidence among users that they're better able to configure their own systems. And with the continued growth of the open-system concept, such users will be offered a steadily increasing range of choices. Knowledgeable users, like open systems, are here to stay, even if the equipment itself ends up in the dumpster.

*Stephen E. Scrupski*

Editor-in-Chief

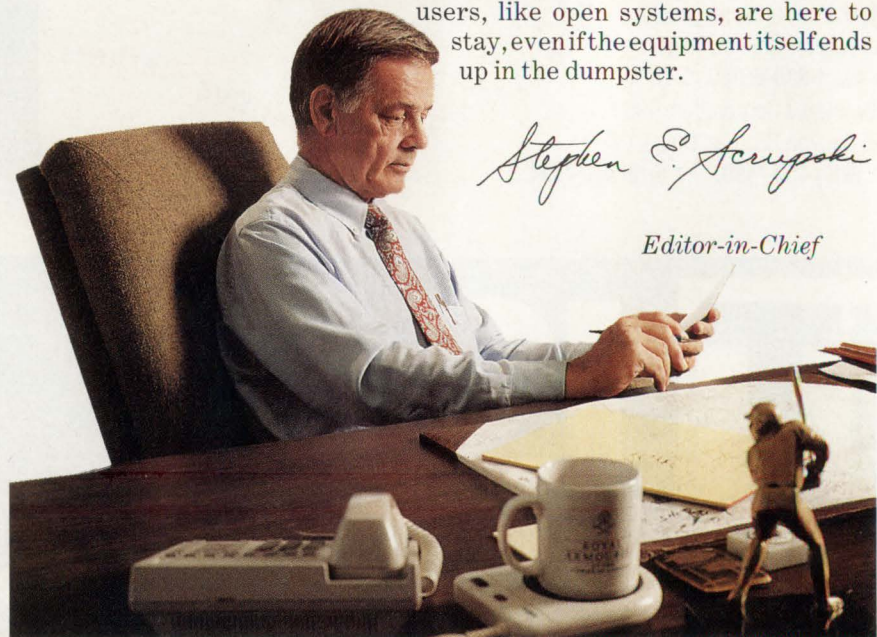



# TOUGHER SBL MIXERS

25KHz to 2000MHz  
from \$4.50

**ULTRA-REL™  
MIXERS**  
5-YR. GUARANTEE\*

Our tough SBL-mixers just got tougher, by including Mini-Circuits' exclusive Ultra-Rel diodes that can endure 160 hours of test at a scorching 300°C. Rugged, more reliable mixers in your systems lower production and test costs and increase systems reliability.

Over the past fifteen years, millions of SBL-units were installed in formidable industrial and commercial applications. Under severe operating conditions, they have earned the reputation as the world's most widely accepted mixers, based on quality, consistent performance in the field, and lowest cost.

In addition to the Ultra-Rel diodes, each SBL contains components that can withstand the strenuous shock and vibration requirements of MIL-STD-28837 along with more than 200 cycles of thermal shock extending from -55 to +100°C. Every Ultra-Rel™ SBL-mixer carries a five-year guarantee.

Unprecedented 4.5 sigma unit-to-unit repeatability is also guaranteed, meaning units ordered today and next year will provide performance identical to those delivered last year.

Tougher SBL-mixers, spanning 25KHz to 2000MHz, with +7dBm, +10dBm, and +13dBm LO models, priced from \$4.50 (10 qty) are available only from Mini-Circuits. Don't settle for a substitute or equivalent...insist on Ultra-Rel™ SBLs.

finding new ways...  
setting higher standards

**Mini-Circuits**

CIRCLE 272 FOR U.S. RESPONSE

CIRCLE 273 FOR RESPONSE OUTSIDE THE U.S.

P.O. Box 350166, Brooklyn, New York 11235-0003 (718) 934-4500 Fax (718) 332-4661 Telexes: 6852844 or 620156

F143 REV. ORIG.



#### SBL SPECIFICATIONS (typ.)

Model	Frequency (MHz)	Conv. Loss (dB)	Isolation (dB)		LO Level (dBm)	Price, \$ ea. (10 qty)
			L-R	L-I		
SBL-1	1-500	5.5	45	40	+7	4.50
• SBL-1X	10-1000	6.0	40	40	+7	6.25
SBL-1Z	10-1000	6.5	35	25	+7	7.25
SBL-1-1	0.1-400	5.5	35	40	+7	7.25
SBL-3	0.025-200	5.5	45	40	+7	7.25
• SBL-11	5-2000	7.0	35	30	+7	18.75
SBL-1LH	2-500	5.8	68	45	+10	5.50
SBL-1-1LH	0.2-400	5.2	64	52	+10	8.25
• SBL-1XLH	10-1000	6.0	40	55	+10	7.25
SBL-2LH	5-1000	5.9	61	54	+10	8.25
SBL-3LH	0.07-250	4.9	60	53	+10	8.25
• SBL-11LH	5-2000	7.0	45	30	+10	19.75
SBL-1MH	1-500	5.5	45	40	+13	9.80
SBL-1ZMH	2-1100	6.5	40	25	+13	11.70
• IF not DC coupled						

#### \*ULTRA-REL™ MIXERS 5 yr. Guarantee

with extra long life due to unique HP monolithic diode construction, 300°C high temp. storage, 1000 cycles thermal shock, vibration, acceleration, and mechanical shock exceeding MIL requirements.

# You have to build a to build just

## The new Tek TDS Series

More than a million Tektronix oscilloscopes have all been leading up to this: the most powerful, versatile, and intuitive instruments ever developed for the mainstream of test and measurement.

The new TDS 500 Series is the culmination of everything Tek has learned in the design, manufacture and use of digitizing oscilloscopes. It's an achievement made possible only by the unique integration of acquisition functions and combinational trigger logic onto a single board.

Only by the development of a milestone multiprocessor architecture.

Only by the addition of Tek's TriStar™ Digital Signal Processor (DSP).

Only by Tek's capacity for taking the hard work out of high performance.

**The TDS Series performs, live, up-**

**dates and measurements that inhibit most other digitizing scopes. Its real-**

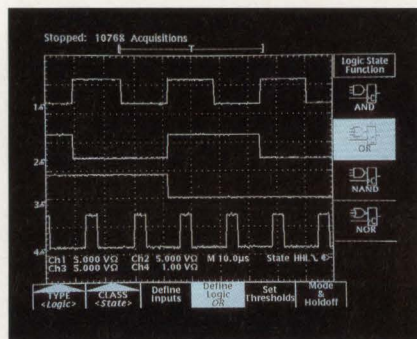

time DSP lets you perform single-shot averaging and extend resolution to 12 bits. The TDS Series arms you with up to

four full-featured channels. 500 MHz

bandwidth. Up to 1 GS/s sampling and 4 ns peak detect.

Up to 50K record lengths. Time interval,

2 ns glitch, runt, pattern and

state triggers. With acquisition sensitivity and fast overdrive recovery bringing greater waveform detail within your grasp.

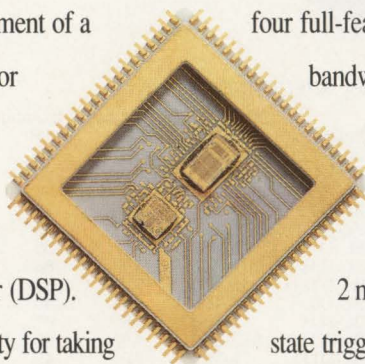

**And if you think oscilloscopes aren't as easy to use and comprehend as they**

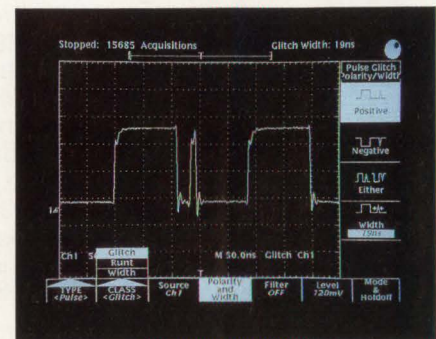

# million oscilloscopes one like this.

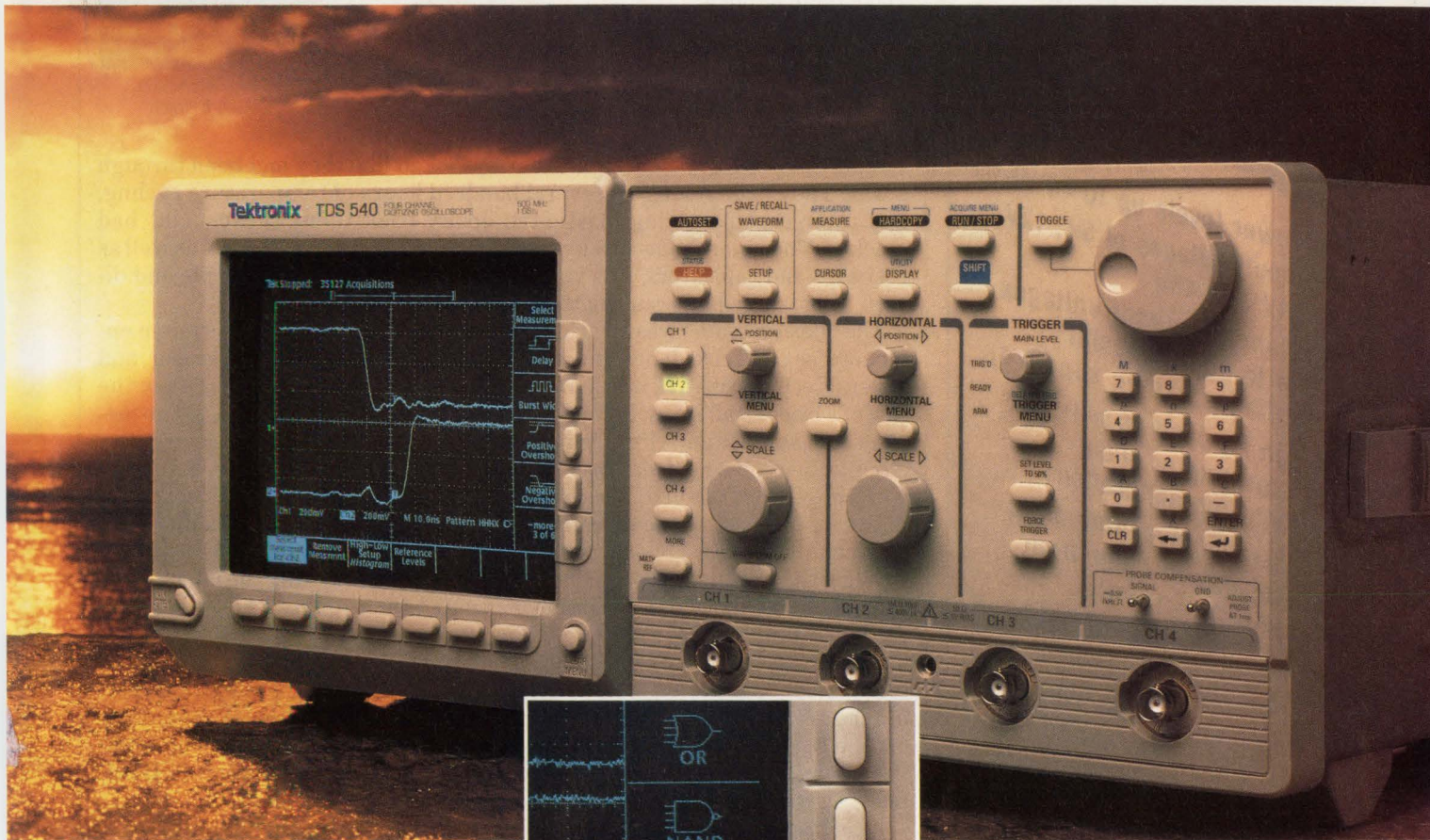

could be, you owe yourself a demo of the TDS. Its simplified front panel, VGA-quality display resolution, on-line help text, innovative icons that instantly differentiate menu functions — all add up to a scope that makes the user's manual more a formality than a necessity.

The TDS Series signals the start of a new generation of friendlier, more

CIRCLE 294 FOR U.S. RESPONSE  
CIRCLE 295 FOR RESPONSE OUTSIDE THE U.S.

One company measures up.

**Tektronix**  
COMMITTED TO EXCELLENCE

powerful instruments from the world's leading supplier of digitizing and analog oscilloscopes. To get a first-hand feel for why performance like this only comes along about once in a million scopes, contact your Tek sales engineer or call **1-800-426-2200**.

ULTRA-MINIATURE

# DC-DC Converter Transformers

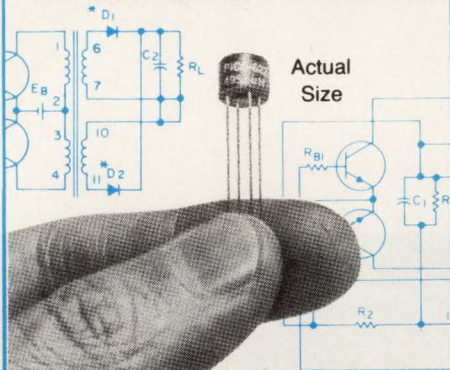

- Power levels up to 40 Watts
- Input voltages of 5V, 12V, 24V and 48V
- Standard output voltages up to 300V (special voltages can be supplied)
- Can be used as self-saturating or linear switching applications
- Operation over ambient temperature range from -55°C to +105°C
- All units meet MIL-T-27 (TF5S40ZZ)
- Secondary can be connected for full-wave or dual bridge
- All units are magnetically shielded
- Schematics and parts list provided with transformers
- Delivery-stock to one week

SEE EEM,  
THOMAS REGISTER  
OR SEND DIRECT FOR  
FREE PICO CATALOG

**PICO**  
**Electronics, Inc.**

453 N. MacQuesten Pkwy. Mt. Vernon, N.Y. 10552

Call Toll Free **800-431-1064**

IN NEW YORK CALL **914-699-5514**

Send for PICO's new catalog featuring  
Ultra Miniature Transformers/Inductors/  
DC-DC Converters

CIRCLE 172 FOR U.S. RESPONSE  
CIRCLE 173 FOR RESPONSE OUTSIDE THE U.S.

## TECHNOLOGY BRIEFING

### DON'T WE NEED MORE GENERALISTS?

**T**he last few years has seen the emergence of a number of buzz words, including concurrent engineering and its constituent parts, such as design for test and design for manufacturing. They are, of course, more than mere buzz words. They are powerful concepts. However, I have two questions: What's so new about them? And don't we need a lot more engineers who are generalists to make them happen?

For example, on my first day on a new job many years ago (at what today would be called a systems house), my boss showed me a cardboard carton containing about 100 dull-gray, cigarette-pack-sized plug-in modules that formed the heart of an analog fire-control



FRANK GOODENOUGH  
ANALOG & POWER

computer for a Navy fighter plane. They looked like they had been through a war. They had undergone several hundred hours of temperature cycling, and their thermosetting-plastic (no epoxy back then) encapsulant had cracked. The nylon frame inside, which held a pair of vacuum tubes as well as resistors and capacitors, was visible. My boss's words were simple and direct: "Find out what's causing the cracking and get it fixed."

The "design team" was a varied group. It consisted of several system engineers, several circuit designers (including me), a mechanical engineer, and several technicians. We worked at double rows of facing desks in a room the size of a basketball court, but we talked with each other—constantly. The mechanical engineer and circuit guys knew the system, the system guys knew circuits, and the whole team had a feel for test and manufacturing, designing with those steps in mind. The circuit designers' job included the mechanical design of the module, developing a test circuit that tested the module, and coming up with a test specification based on the circuit.

When the manufacturing department had trouble building the modules, or the test department ran into problems testing them, guess who got a phone call and was expected to appear *instantly* on the shop floor to solve the problem? In most cases, we made at least one pass a day through the shop, making sure our "babies" were doing all right. And, when it came to system-testing the prototype computers, pairs of engineers (not technicians), regardless of their specialty, worked 12 hours on, 12 hours off, until the tests were completed (in a non-air-conditioned shed on the roof of the building in Baltimore—in August).

Admittedly, this was a long time ago, when things were simpler. Still, how many of today's designers are prepared, both emotionally and with the tools and the training, to step outside their area of expertise? Yet, this degree of broad knowledge is where the future lies.

Evaluating trade-offs between technologies requires a good understanding of all of them. Consider, for example, the design of mixed-signal ASICs. Who in a small company will design a 10,000-device mixed-signal ASIC? Because it's a small company, the job probably will fall to just one engineer—but it will be an engineer who feels at home with both analog and digital design. By contrast, in a large system house, who will design a 100,000-transistor mixed-signal chip? In this case, it probably will be a design team composed of specialists, but chances are that design team will be led by a more senior designer who not only knows both analog and digital design, but also has at least a speaking acquaintance with packaging and thermal effects.

Even with concurrent engineering, we still need designers who can get excited about seeing a job through, from listening to a customer's problem (even an internal customer) to making sure it works in the customer's system. We still need designers who are willing to get excited about learning new skills, taking risks, and getting their hands dirty.

# Low Cost, Dual, Sampling ADC delivers 90dB SNR

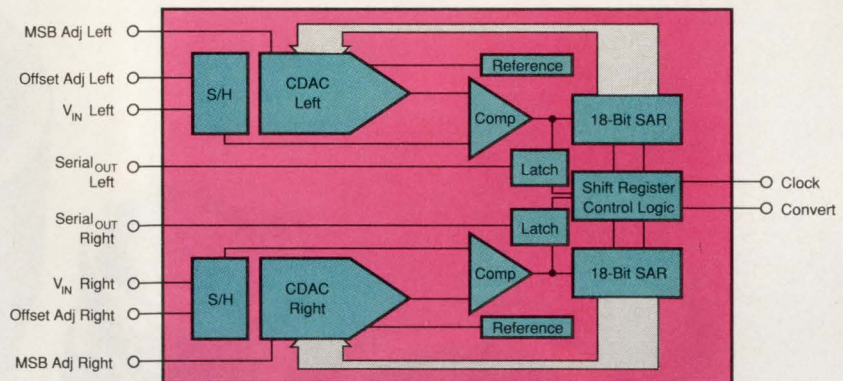
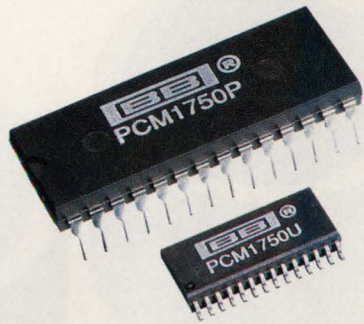

## Audio and more...

Our new PCM1750 is a low cost, high performance solution for digital audio, DSP, medical imaging, and industrial control applications. This low-power CMOS A/D converter samples faster than 200kHz and is complete with internal reference and true co-phase inputs with a separate S/H for each channel. A companion digital filter, DF1750, also improves SNR by 6dB. PCM1750's exceptional performance makes it ideal for many applications...from DC to audio, and beyond.

## Dynamic Performance Specs (with digital filter)

- 90dB SNR
- -88dB max THD+N (100% tested)
- 5 $\mu$ s conversion with internal S/H
- 300mW max power consumption
- 4X audio oversampling-capable
- compact 28-pin plastic DIP or SOIC
- from \$26.51\*

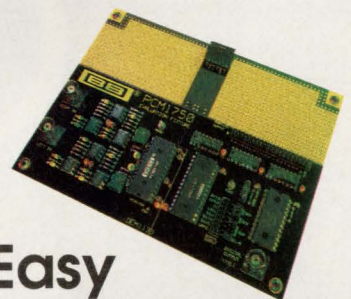
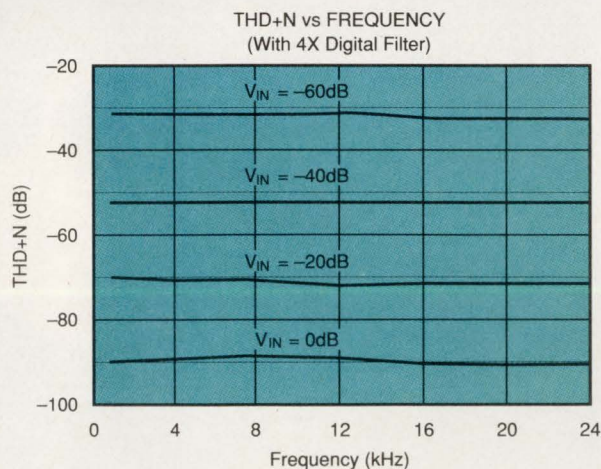

## Easy Evaluation

Evaluate PCM1750's super performance with free samples and comprehensive data sheets. A demo fixture including filters is also available. Just call **1-800-548-6132** for immediate assistance or contact your local Burr-Brown sales office.

**Burr-Brown Corp.**  
P.O. Box 11400  
Tucson, AZ 85734

\* U.S. OEM prices, in 1000s.

**BURR-BROWN®**  
**BB**

# FILTERS



# dc to 3GHz from \$11.45

## lowpass, highpass, bandpass, narrowband IF

- less than 1dB insertion loss • greater than 40dB stopband rejection
- 5-section, 30dB/octave rolloff • VSWR less than 1.7 (typ) • meets MIL-STD-202 tests
- rugged hermetically-sealed pin models • BNC, Type N; SMA available
- surface-mount • over 100 off-the-shelf models • immediate delivery



### low pass dc to 1200MHz

MODEL NO.	PASSBAND, MHz (loss <1dB)		STOP BAND, MHz (loss >20dB) (loss >40dB)		VSWR		PRICE \$ Qty. (1-9)	
	Min.	Nom.	Max.	Max.	pass-band typ.	stop-band typ.		
PLP-10.7	DC-11	14	19	24	200	1.7	18	11.45
PLP-21.4	DC-22	24.5	32	41	200	1.7	18	11.45
PLP-30	DC-32	35	47	61	200	1.7	18	11.45
PLP-50	DC-48	55	70	90	200	1.7	18	11.45
PLP-70	DC-60	67	90	117	300	1.7	18	11.45
PLP-100	DC-98	108	146	189	400	1.7	18	11.45
PLP-150	DC-140	155	210	300	600	1.7	18	11.45
PLP-200	DC-190	210	290	390	800	1.7	18	11.45
PLP-250	DC-225	250	320	400	1200	1.7	18	11.45
PLP-300	DC-270	297	410	550	1200	1.7	18	11.45
PLP-450	DC-400	440	580	750	1800	1.7	18	11.45
PLP-550	DC-520	570	750	920	2000	1.7	18	11.45
PLP-600	DC-580	640	840	1120	2000	1.7	18	11.45
PLP-750	DC-700	770	1000	1300	2000	1.7	18	11.45
PLP-800	DC-720	800	1080	1400	2000	1.7	18	11.45
PLP-850	DC-780	850	1100	1400	2000	1.7	18	11.45
PLP-1000	DC-900	990	1340	1750	2000	1.7	18	11.45
PLP-1200	DC-1000	1200	1620	2100	2500	1.7	18	11.45

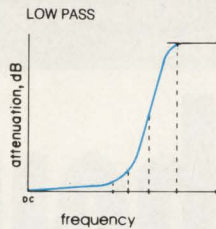

### high pass dc to 2500MHz

MODEL NO.	PASSBAND, MHz (loss <1dB)		STOP BAND, MHz (loss >20dB) (loss >40dB)		VSWR		PRICE \$ Qty. (1-9)	
	Min.	Nom.	Min.	Min.	pass-band typ.	stop-band typ.		
PHP-50	41	200	37	26	20	1.5	17	14.95
PHP-100	90	400	82	55	40	1.5	17	14.95
PHP-150	133	600	120	95	70	1.8	17	14.95
PHP-175	160	800	140	105	70	1.5	17	14.95
PHP-200	185	800	164	116	90	1.6	17	14.95
PHP-250	225	1200	205	150	100	1.3	17	14.95
PHP-300	290	1200	245	190	145	1.7	17	14.95
PHP-400	395	1600	360	290	210	1.7	17	14.95
PHP-500	500	1600	454	365	280	1.9	17	14.95
PHP-600	600	1600	545	440	350	2.0	17	14.95
PHP-700	700	1800	640	520	400	1.6	17	14.95
PHP-800	780	2000	710	570	445	2.1	17	14.95
PHP-900	910	2100	820	660	520	1.8	17	14.95
PHP-1000	1000	2200	900	720	550	1.9	17	14.95

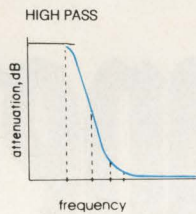

### bandpass 20 to 70MHz

MODEL NO.	CENTER FREQ. MHz F0	PASS BAND, MHz (loss <1dB)		STOP BAND, MHz (loss > 10 dB) (loss > 20 dB)				VSWR 1.3:1 typ. total band MHz	PRICE \$ Qty. (1-9)
		Max. F1	Min. F2	Min. F3	Max. F4	Min. F5	Max. F6		
PIF-21.4	21.4	18	25	4.9	85	1.3	150	DC-220	14.95
PIF-30	30	25	35	7	120	1.9	210	DC-330	14.95
PIF-40	42	35	49	10	168	2.6	300	DC-400	14.95
PIF-50	50	41	58	11.5	200	3.1	350	DC-440	14.95
PIF-60	60	50	70	14	240	3.8	400	DC-500	14.95
PIF-70	70	58	82	16	280	4.4	490	DC-550	14.95

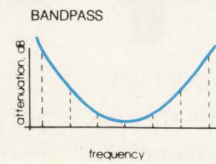

### narrowband IF

MODEL NO.	CENTER FREQ. MHz F0	PASS BAND, MHz I.L. 1.5dB max. F1-F2	STOP BAND, MHz I.L. > 20dB		STOP BAND, MHz I.L. > 35dB		PASS-BAND VSWR Max.	PRICE \$ Qty. (1-9)
			F5	F6	F7	F8-F9		
PBP-10.7	10.7	9.5-11.5	7.5	15	0.6	50-1000	1.7	18.95
PBP-21.4	21.4	19.2-23.6	15.5	29	3.0	80-1000	1.7	18.95
PBP-30	30.0	27.0-33.0	22	40	3.2	99-1000	1.7	18.95
PBP-60	60.0	55.0-67.0	44	79	4.6	190-1000	1.7	18.95
PBP-70	70.0	63.0-77.0	51	94	6	193-1000	1.7	18.95

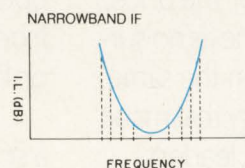

**Mini-Circuits**

P.O. BOX 350166, Brooklyn, New York 11235-0003 (718) 934-4500 FAX (718) 332-4661 TELEX 6852844 or 620156 WE ACCEPT AMERICAN EXPRESS

CIRCLE 270 FOR U.S. RESPONSE

CIRCLE 271 FOR RESPONSE OUTSIDE THE U.S.

F132-2 REV. ORIG.

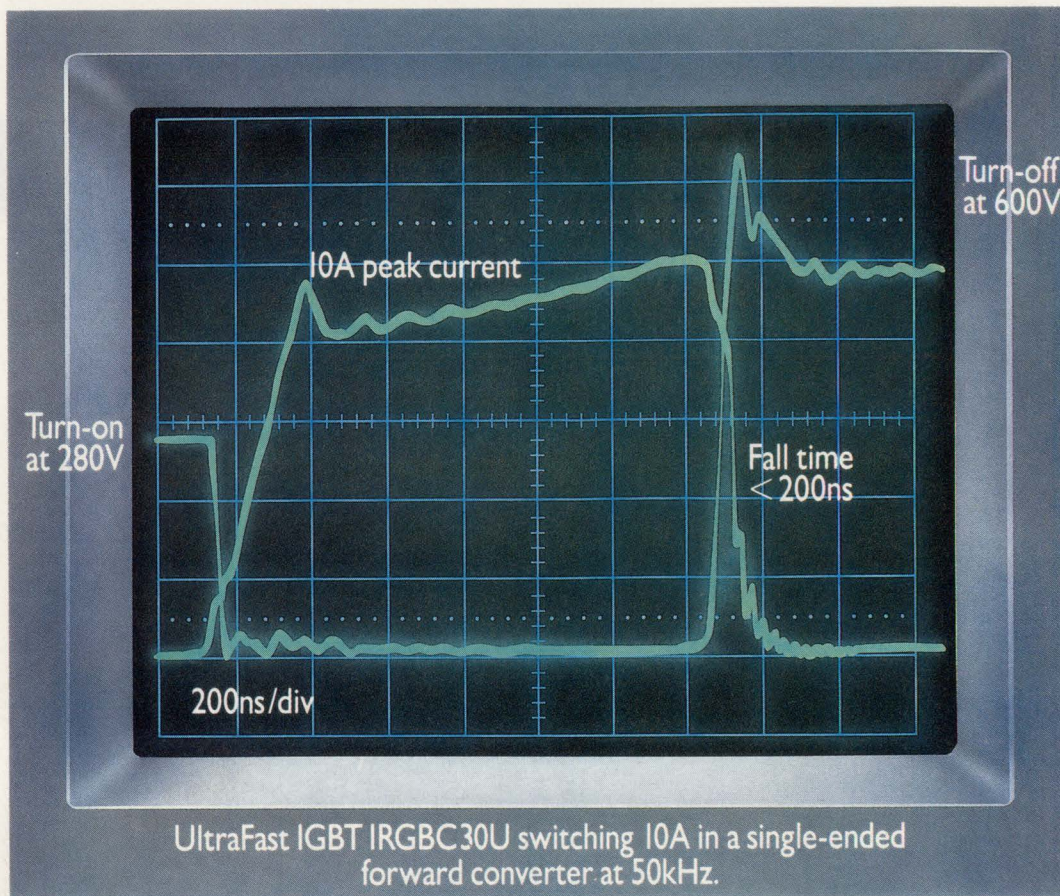

# IGBTs Without A Trace of Competition.

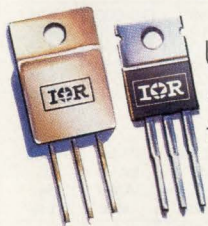

IR announces Ultra Fast IGBTs: our 600V power transistors that switch faster and run cooler than any you've ever used. Forget about bipolar. Put these

breakthrough devices in your high-voltage, high-current, medium-frequency applications and get performance unparalleled for the price.

Which should come as no surprise. IR IGBTs build on the same proprietary technology that made IR's HEXFETs® world leaders.

Call 1 (213) 640-6534 and ask about Standard, Fast or Ultra-Fast IGBTs, optimized for your operating frequency. And available from 10A to 70A, in commercial or hi-rel packages.

We'll be happy to arrange a screening.

**IR International Rectifier**

WORLD HEADQUARTERS: 233 KANSAS ST., EL SEGUNDO, CA 90245, U.S.A. (213) 772-2000. TWX 910 348-6291, TELEX 472-0403. EUROPEAN HEADQUARTERS: HURST GREEN, OXTED, SURREY RH8 9BB, ENGLAND TELEPHONE (0883) 713215, TELEX 95219

CIRCLE 232 FOR U.S. RESPONSE

CIRCLE 233 FOR RESPONSE OUTSIDE THE U.S.



## **EDA FRAMEWORK PROGRAM EASES TOOL INTEGRATION**

Designers trying to integrate proprietary or commercial EDA tools into the ValidFrame design-process framework can get support from the Connections Program, created by Valid Logic Systems Inc., San Jose, Calif. Among the ten charter members of the program are GenRad, Logic Modeling Systems Inc., Synopsys, and Zycad. Using application programming interfaces, program participants can plug design tools into the framework to exploit its real-time intertool communications and data-management capabilities. The Connections Program has three levels of integration. Level 1 deals with encapsulation in a batch mode through a standard net-list interface. Level 2 handles interactive integration through the framework's Communications Manager. And Level 3 is integration at the data-administration level through the Design Manager. Valid Logic tailors Connections Packages to each participant's requirements. These packages include software tools, documentation, training, technical support, and interface qualification services. For more information, call Valid Logic at (408) 432-9400. *LM*

## **NTC-THERMISTOR MADE MORE ACCURATE**

The resistance spread above and below the nominal temperature has been slashed for all types of NTC (negative-temperature-coefficient) thermistors manufactured by the German-Japanese firm Siemens Matsushita Components (S+M). The reduction was achieved by keeping the deviations of the material constant, the so-called B-value, to within  $\pm 0.5\%$  to  $\pm 3\%$ . This makes S+M the lone components manufacturer to offer a wide range of NTC thermistors with a tolerance not exceeding  $\pm 3\%$ . The B-value tolerance measures how well a manufacturer has mastered the production process for such parts. This can significantly affect the potential applications of NTC thermistors. For example, if they're used to measure temperatures, it means that the lower the B-value tolerance, the more precise the measurements are over a wide temperature range. Besides measuring temperatures, the NTC thermistors can be used in applications ranging from temperature compensation in consumer electronics to current limiting in switched-mode power supplies. The product range encompasses thermistors with diameters from 0.4 to 22 mm and resistance values from 1  $\Omega$  to 5 M $\Omega$ . *JG*

## **DISCRETE POWER MOSFETS GET BRAINS**

Motorola Inc., Phoenix, Ariz., the company that coined the term "smart power" to describe power ICs, is now offering "Smartdiscrete" power devices. If a 6-or-7-mask-step silicon wafer that holds one power MOSFET per die is dragged through another ten or more steps to add protection or other circuits, the die turns into an expensive IC. "Smartdiscreted," on the other hand, use the basic DMOSFET process but include transistors, diodes, and resistors for protection. At most, just one mask step is added. An example of this genre is the MLP1N06CL, which is basically a logic-level FET with an on-resistance of 75 m $\Omega$ . The drain-to-source voltage, however, is clamped to 62 V by drain-to-gate polysilicon Zener diodes integrated on top of the oxide to eliminate electrical parasitics. The diodes set the maximum drain voltage and snub inductive-load spikes. Similar Zeners on the input protect against line transients to 2000 V. Current limiting is provided by an npn transistor whose collector is tied to the FET's gate, its base to the source, and its emitter to the source pin. A 0.4- $\Omega$  metal resistor ties the FET's source to the source pin. An additional resistor lies between the gate pin and the gate itself. As the FET's current rises, the voltage across the 0.4- $\Omega$  resistor rises and turns on the npn transistor. Gate-drive current flows through it, and in doing so drops the gate-drive voltage across the series resistor between the gate pin and the gate, limiting FET current. For additional information, call Kirby Dorwichter at (602) 244-3370. *FG*

## **16-MBIT DRAMS READY FOR COMMERCIAL SAMPLES**

Although they will operate from an external 5-V supply, the first commercial generation of 16-Mbit dynamic RAMs released by NEC Electronics Inc., Mountain View, Calif., will employ on-chip voltage-reduction circuitry to shrink the internal levels to 3.3 V. Moreover, future versions of the chip will be able to operate directly from the reduced supply level. The lower internal voltage will help reduce stress on the 0.55- $\mu\text{m}$  minimum-size features applied by the company's design teams in Kawasaki, Japan. The memory chips will use the stacked-capacitor memory cell described by the company at previous solid-state conferences. The memory cell has also been applied to its 4-Mbit DRAM that's now in volume production. Initial releases of the memory will come in 70-, 80-, and 100-ns access-time grades, with either fast page, nibble, static-column, or write-per-bit operating options. For designers who seek refresh-cycle compatibility with previous-generation DRAMs, or a more efficient refresh scheme, the company will offer two versions of the

# Looks like you could use our new



Let's face it. When you pick a new microprocessor that takes performance to new heights, it's only natural to wonder what support you'll have.

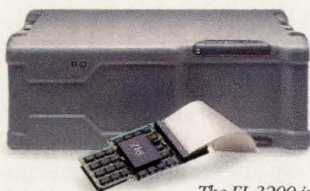

Not to worry. Because Applied Microsystems has everything you need to develop your embedded system now. So

*The EL 3200 is the only completely integrated development system for the i960 CA microprocessor.*

you'll be up and running to meet tight schedules.

**Intel supports us supporting you.**

They asked us to back their robust i960™ CA microprocessor with a high

# i960™ CA development system.



performance development system that's built to go. So we did.

Which means you get our fully tested EL 3200 emulator, complete with power features such as 40 MHz clock speed.

Advanced trace and event. And up to 4 MB of overlay memory, all at RISC speeds.

And all with fully integrated software backed by Intel®, including a highly-optimized compiler, assembler, disassembler and source-level debugger.

What's more, our system is completely networked for Sun® and PC setups. And has a windowed interface common to all our EL systems, making it much easier to learn and use.

This should have your design team flying.

## **Our roots are in embedded design.**

As a matter of fact, supporting your development business is our only business.

Which means you get the most dedicated technical expertise in the business. Like timely phone support from our own application engineers. Complete installation and systems training. And free

application articles.

It's exactly the kind of development support you'd expect from a company that's installed over 15,000 development systems worldwide for 16- and 32-bit designs.

**Before your bough breaks, call us.**

We'd like to send you more details about our i960 CA development support, plus a guide on sizing up a development

systems company.

Just call 1-800-343-3659 (in Washington, 206-882-2000).

We can help.

No matter what your design team is up to.

### Major microprocessors supported by our development systems:

Intel	Motorola
i960 CA	68030/020
80386/286	68EC030
80C186/188	68302
80186/188	68000/08/10
80C86/88	<b>Zilog</b>
8086/88	Z8001
	Z8002

What to look for in a development systems company. And what to look out for.



**Applied  
Microsystems  
Corporation**

**Where it all comes together.**

RAM, one with 2048 cycles and the other with 4096 cycles. Samples are immediately available in either 16-Mword-by-1-bit or 4-Mword-by-4-bit organizations (the  $\mu$ PD4216100 and 4216400, respectively). Contact Cecil Conkle, (415) 965-6303. *DB*

## VHDL EMERGES AS THE PLD DESIGN STANDARD

Leading EDA vendors, IC manufacturers, and VHDL commercial and military end users agree that VHDL will be the standard design language for programmable-logic design and synthesis. At a recent meeting, over 20 EDA-software and IC vendors jointly announced their unified support for VHDL. EDA-software vendors included Mentor Graphics, Minc, Synopsys, and Teradyne. Major end users, such as General Dynamics and Hughes, also made the VHDL commitment. Other supporters included the IEEE and VHDL International. The group agreed that VHDL, which provides vendor, platform, and device independence, is a perfect fit for programmable-logic design. This standardization to VHDL includes all types of programmable devices, such as PLDs and FPGAs. Minc Inc., Colorado Springs, Colo., and CAD Language Systems Inc., Rockville, Md., led and organized the meeting. The two companies are jointly developing full VHDL support for programmable-logic-design synthesis. Details on that relationship and the resulting products will be announced at the end of the summer. *LM*

## CONNECTOR DATA COMES VIA CD-ROM AND FAX

Detailed engineering data on interconnections is now available through two new means: CD-ROM disks and a 24-hour fax line. AMP Inc., Harrisburg, Pa., has introduced its Electronic Application Design Systems (EADS) library of CD-ROM disks. The product-specific volumes contain customer prints, product and applications specifications, instruction sheets, 3D CAD wireframe connector models, and 2D CAD models of connector footprints and panel cutouts. Each disk holds 650 Mbytes of data (equivalent to 1000 pages of documentation) and is compatible with any ISO 9660 CD-ROM drive. The toll-free 24-hour fax line uses voice prompts to trigger a computer search for appropriate documents, which are automatically transmitted to the specified fax machine. Call 1-800-522-6752. *DM*

## CONTROLLER IC BREEDS FAST POWER DIODES

Supplies with power-factor correction should be at the top of the feature list of any power-supply or system designer working on products for the 1992 European common market. Unitrode Corp., Watertown, Mass., one supplier of switching-regulator, power-factor-controller ICs, has found such supplies also demand power rectifiers with specialized characteristics. That is, they must combine ultrafast switching speed, high blocking voltages, and low reverse leakage currents. To meet that demand, they developed a high-voltage controlled-avalanche bipolar process. The process builds diodes that can block 600 V while handling 8 A continuously. Moreover, these diodes recover in under 35 ns. Their reverse leakage current, however, is under 10  $\mu$ A at 25°C and only 250  $\mu$ A at 125°C. At the same two temperatures, forward voltage drop for Unitrode's UHVP806 at 8 A is 1.5 and 1.2 V, respectively. Two siblings block 200 and 400 V while their other specifications remain identical. These diodes' 2-pin TO-220 packages make it easy to mount. In low volume, prices range from \$2.80 to \$3.40 each. For additional information, call John Vines at (617) 926-0404. *FG*

## BEHAVIORAL MODELS MIX ACCURACY AND SPEED

A set of behavioral driver and receiver subcircuits from Quantic Laboratories Inc., Winnipeg, Canada, cut analysis time while maintaining accuracy. The reduced-Spice models mirror the physical layout of each device. They use linear electrical elements and one or more diodes to simulate the electrical behavior of complex gate circuits over a range of loading conditions. Although other models emulate only the static voltage-current (V-I) characteristics, the Quantic models contain dynamic characteristics to simulate overshoot, undershoot, and other ringing problems. The driver subcircuits have two stages that are switched on and off, depending on the state of the driver. The high and low stages simulate the high-state and low-state V-I characteristics of the driver, respectively. The linear elements approximate the characteristics of the devices for quick and approximate analysis, but tend to slightly overestimate time delays and fall overshoots. The nonlinear portion of the subcircuits use diodes to model the p-n junctions of the transistors to accurately simulate the nonlinear switching characteristics of drivers and receivers. In an informal test, the models cut circuit analysis to one-tenth the time needed to analyze the same circuit with more accurate transistor-based models. However, differences in the results of the two model types were negligible. For more information on the models, call Quantic at (800) 665-0235. *LM*

# 350V OR 3A AMPLIFIER

## HV MONOLITHIC

The 350 Volt PA41 from Apex is the world's first monolithic op amp exceeding 100 Volts. Providing 60mA of load current while consuming only 2mA of quiescent current, the PA41 is the ideal choice for driving piezo electric devices efficiently and economically.

Drawing upon our expertise with MOSFET technology, the PA41 is approximately half the cost of any previous op amp.

## POWER MONOLITHIC

Complementing the PA41 are the PA21 and PA25 duals; rated at 40V and 3A output current and internal current limiting.

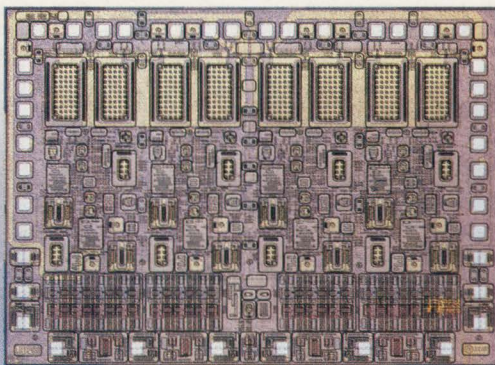

**LOW COST**  
**350V RAIL TO RAIL**  
**NO SECOND BREAKDOWN**  
**60mA OUTPUT CURRENT**  
**LOW QUIESCENT CURRENT (2mA)**  
**26KHz POWER BW**  
**40V/ $\mu$ S**

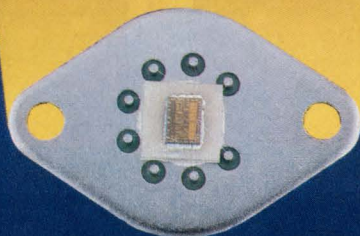

## MORE THAN HYBRIDS

With the introduction of the PA41, Apex now expands in two new product lines, monolithic power and DC/DC converters. Our new line of hi-rel DC/DC converters feature reliability, wave solderability and ruggedness.

To receive a copy of our handbook, or for more information about the PA41, PA21, PA25 or other Apex products, call 1-800-448-1025. For applications or product selection assistance, call 1-800-421-1865.

Attend the Apex sales seminar and improve your analog knowledge, call 1-800-421-1865 for scheduled dates in your area.



DEDICATED TO EXCELLENCE

APEX MICROTECHNOLOGY CORPORATION

5980 N. SHANNON ROAD, TUCSON, ARIZONA 85741

CANADA (416) 321-7800 DENMARK (42) 24 48 88 GERMANY (6152) 61081 SPAIN (1) 4094725 FINLAND (0) 8041-041 FRANCE (1) 69 07 08 24  
 HONG KONG 8339013 ISRAEL (3) 9345171 INDIA (212) 339836 ITALY (2) 99041977 JAPAN (3) 3244-3787 NETHERLANDS (10) 4519533  
 NORWAY (2) 50 06 50 KOREA (2) 745-2761 AUSTRIA (1) 505 15 220 SWITZERLAND (56) 26 54 86 SINGAPORE 284-8537 SWEDEN (8) 795 9650  
 TAIWAN (02) 721-9533 UK (0844) 278781 BELGIUM/LUXEMBOURG (3) 828-3880 AUSTRALIA (2) 4178777

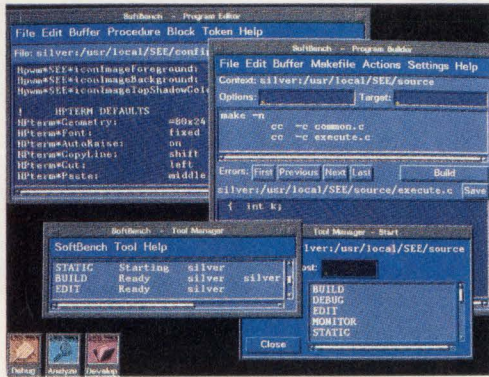

*HP's SoftBench: A tool integration framework and a program construction toolset.*

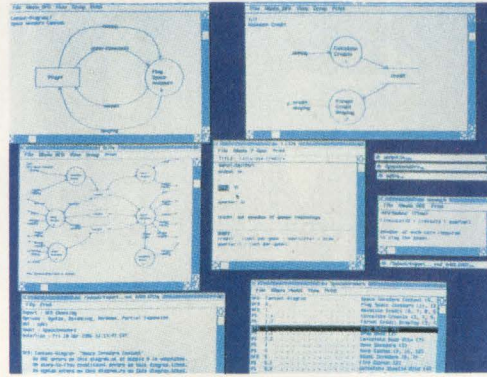

*Cadre Teamwork: A family of tools that implement system analysis and software design methodologies.*

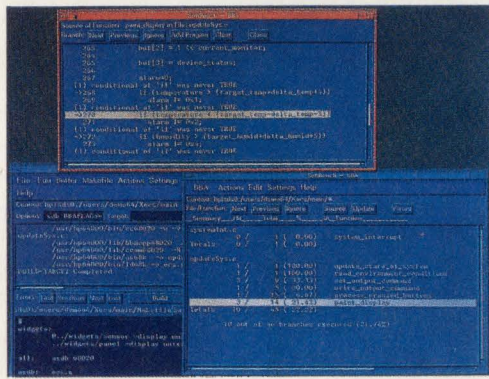
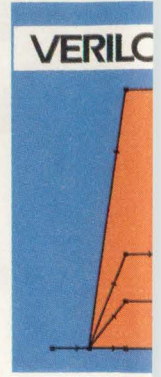

*HP Branch Validator: Provides accurate branch information quickly and easily, reducing software test time while increasing confidence.*

# Best CA

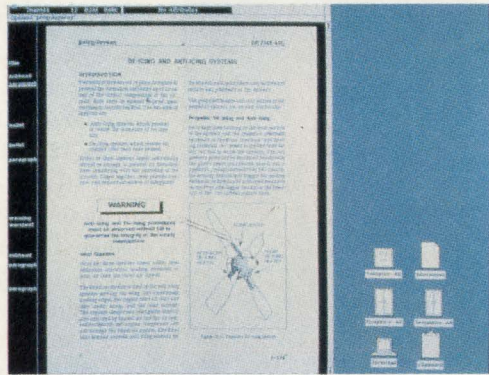

*Interleaf Technical Publishing Software: A documentation software and management system that features integrated text and graphics.*

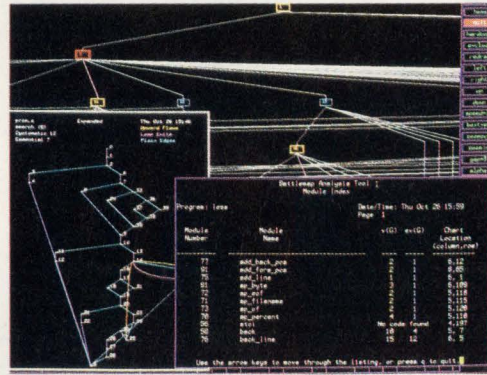

*McCabe Test Tools: An automated software testing and reverse engineering application.*



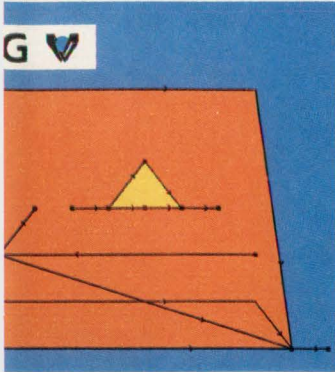

*Verilog LOGISCOPE:  
Automated testing of source  
code analysis for reverse  
engineering.*

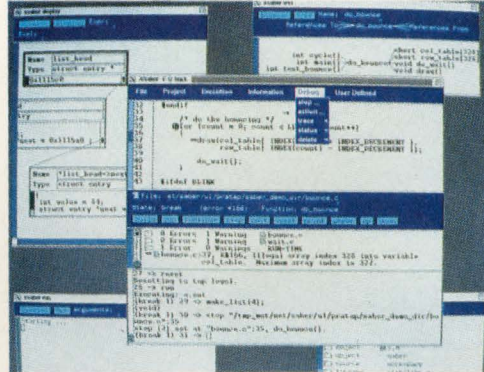

*Saber-C: A set of integrated tools for development,  
testing, maintaining and debugging C programs.*

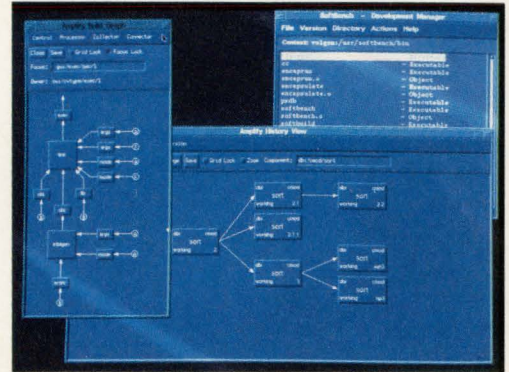

*CaseWare® AMPLIFY® CONTROL:  
A graphic development environment  
and configuration management system based  
upon an open architecture.*

# SE scenario.

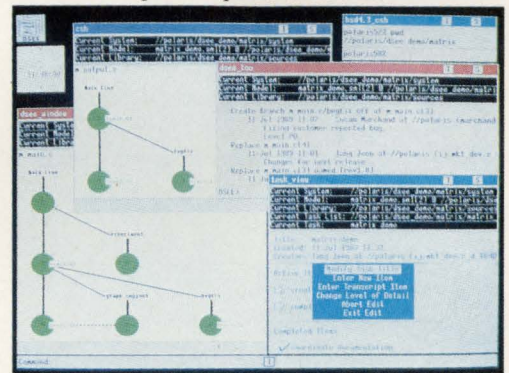

*Apollo DSEE: Offers unequalled software  
development support and configuration  
management for complex, team-oriented projects.*

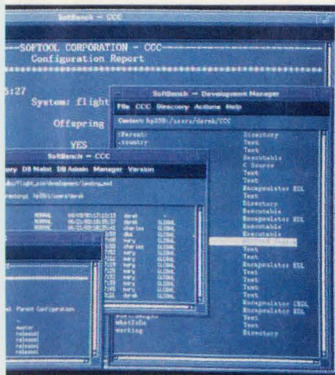

*Softool Corporation CCC:  
A complete, automated solution  
for change control and  
configuration management.*

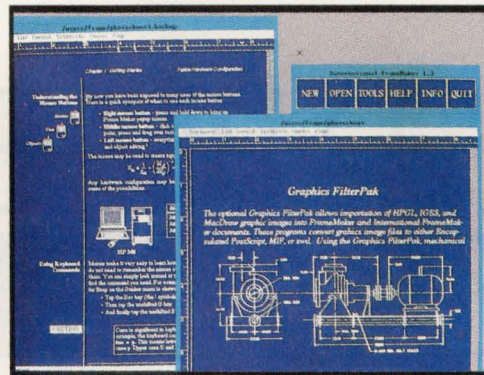

*Frame FrameMaker®: Easy-to-use text,  
graphics, and layout tools for documentation.*

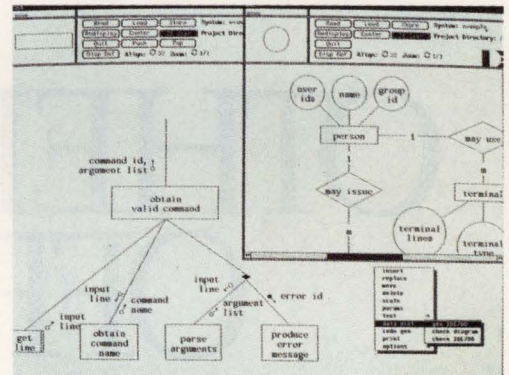

*IDE Software Through Pictures®: Integrated tools  
for improving software quality that emphasize  
systems analysis and software design.*

How can you make sure that your software release dates don't slip? That defects are discovered sooner rather than later? That your team has the most up-to-date tools?

Hewlett-Packard's SoftBench, that's how.

SoftBench is a tool integration platform, with its own toolset. It provides a common user interface, tool communication and distributed computing

services. And you can integrate your own or third-party tools into SoftBench.

These software suppliers and SoftBench are key elements of our CASEEdge program. Together, we offer a broad selection of development tools. They help automate the specification, design, implementation, debugging and maintenance processes.

This streamlines your entire CASE environment, while protecting your

investment, lowering your development costs and improving your time to market.

For more information, call us at 1-800-637-7740, Ext. 2202. We'll show you the best CASE scenario in the industry.

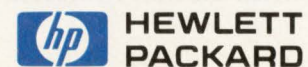

# OTHER 32-BIT EMBE OFFER SOMETHI

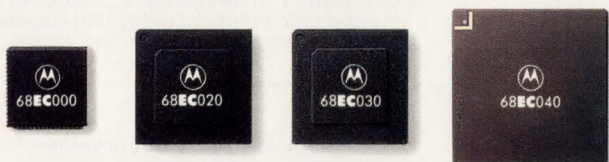

When you're picking an embedded processor, it pays to watch your step. Or you may wind up with a design that doesn't meet your performance expectations, and a schedule that keeps slipping.

Not so with the new Motorola 68EC000 line.

From the 68EC000 that's just two dollars and change, to the 68EC040 that delivers a full 22 MIPS, they're all based on the world's most popular architecture. The 68000.

Which means you get a seamless migration path and reams of reusable code. Because each 'EC000 embedded microprocessor is binary compatible with all 68000-based microprocessors, and with every other 'EC000 family member.

What's more, they're all engineered to give





# EMBEDDED PROCESSORS BEATING OURS DON'T.

your products virtual immunity from memory wait states.

They also deliver superior levels of sustained performance, not "peak" MIPS like with other processors. So you can use DRAM instead of SRAM, and minimize your overall system cost.

As you'd expect from Motorola, high performance, low cost and exceptional technical support are

68000 MICROPROCESSOR FAMILIES				
68000 CPUs Architectural Integration	000	020	030	040
68EC000 EMBEDDED Performance/Cost	EC000	EC020	EC030	EC040
68300 INTEGRATED Functional Integration	302	330	331	332 340

*Motorola's 68000 families let you choose the performance and integration that's right for your application.*

all part of the package. And 'EC000 embedded microprocessors are available at the price/performance points you need.

So before you pick your next embedded microprocessor, call 1-800-845-MOTO, and get a free sample from the 68EC000 family.\* It's one step you'll never regret.



**MOTOROLA**

## BOOLEAN VERIFICATION SHORTCUTS CIRCUIT EVALUATION WHEN COMPARING OLD AND NEW

Engineers generally use logic-simulation programs to ensure that a circuit design matches the original net list. Such programs, however, require the generation of test vectors, which can be time-consuming. Designs with many thousands of gates can require hundreds of hours to complete simulation. But what if logic-verification results, equivalent to those of simulation, were achievable without the need to generate test vectors, and they could be done in a fraction of the time required for simulation? Furthermore, what if such a solution required a minimum of user inputs and could automatically generate diagnostic test vectors to pinpoint errors as well as rectify the test design? Such features may no longer be suppositions if a technique called Boolean verification proves its worth.

Developed by Vertex Semiconductor Corp., Sunnyvale, Calif., for use dur-

ing verification of its own circuit implementations, the program extracts the actual logic functions of a design under test and compares the logic functions against the original design specification. Such a capability is especially handy when reimplementing a design—for example, when converting a TTL-based design to CMOS, or even an ECL design to CMOS, or vice versa.

The verification results are equivalent to exhaustive logic simulation. Furthermore, if some logic in a design mismatches against its specification, the Boolean verifier (BoolVer) will automatically generate test vectors. The approach, according to Terence Chan, manager of design verification at Vertex, is much more efficient than, and as comprehensive as exhaustive logic simulation. By using BoolVer, a designer can prove that a design, which has been modified by logic synthesis and/or manual

edits, is functionally equivalent to its original design specification.

For each design under test, BoolVer decomposes the logic into a set of single output logic cones (segments). Each logic segment consists of a design primary output or a scan-latch data input, and all of the fan-in logic that drives the output node. The inputs to a logic segment can be design primary inputs, scan-latch data outputs, signals in the test design that are known to be functionally equivalent to the specification (such as a global reset signal), or signals with constant logic states (ground or  $V_{CC}$ , for example). Users can also specify don't-care logic in the compared designs, so that if two designs are known to be nonequivalent in selected areas, BoolVer will bypass those regions.

Next, the logic function of each segment in a design is extracted and converted into a reduced-order binary decision diagram

(ROBDD). All generated ROBDDs for a chip are stored in a library file. Multiple ROBDD libraries can also be linked for multichip design evaluation.

An ROBDD graph is the canonical representation of a logic function. For instance, there are multiple ways to represent logic functions. In one example, an XOR gate can be created with NOR gates, a NAND gate, and an inverter in CMOS, and with four NAND gates in TTL (see the figure). The resultant binary decision diagram of each circuit will be the same, proving that the circuits are equivalent. If two logic functions are equivalent, then their ROBDD graphs are guaranteed to be isomorphic, provided the same node ordering is applied to the input variables of the two functions when the ROBDD graphs are being built.

Once the ROBDD libraries are created (one for the design under test and one for the original design specification), BoolVer extracts the ROBDD graphs for each corresponding segment from the test design and its specification libraries. Then they're compared for isomorphism. If the two don't match, the corresponding logic sections in question are proved to be functionally nonequivalent, and BoolVer generates diagnostic test vectors directly from the mismatched ROBDD graphs. These vectors can identify logic discrepancies between the test design and its specification.

As with all programs, BoolVer does have some limitations—timing characteristics of a design must

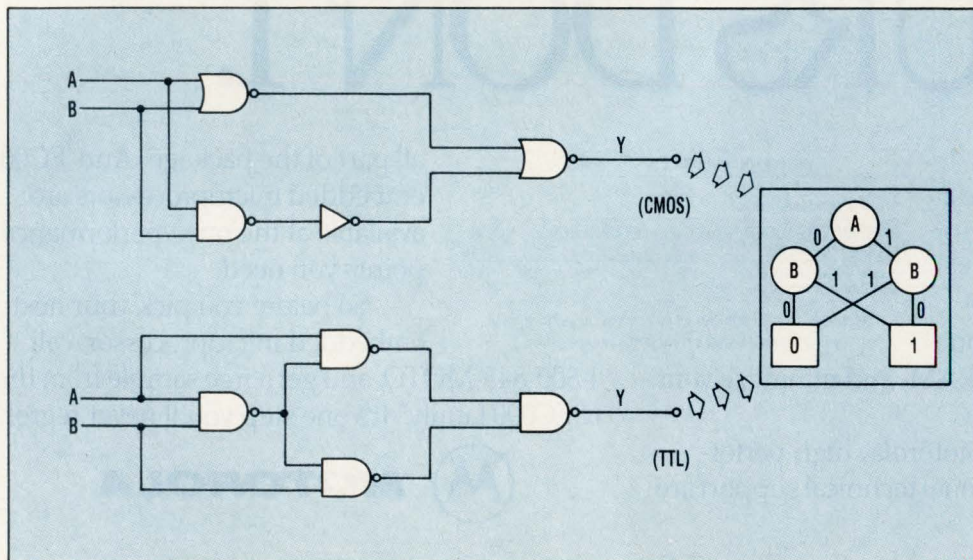

# Smash the Cache Barrier

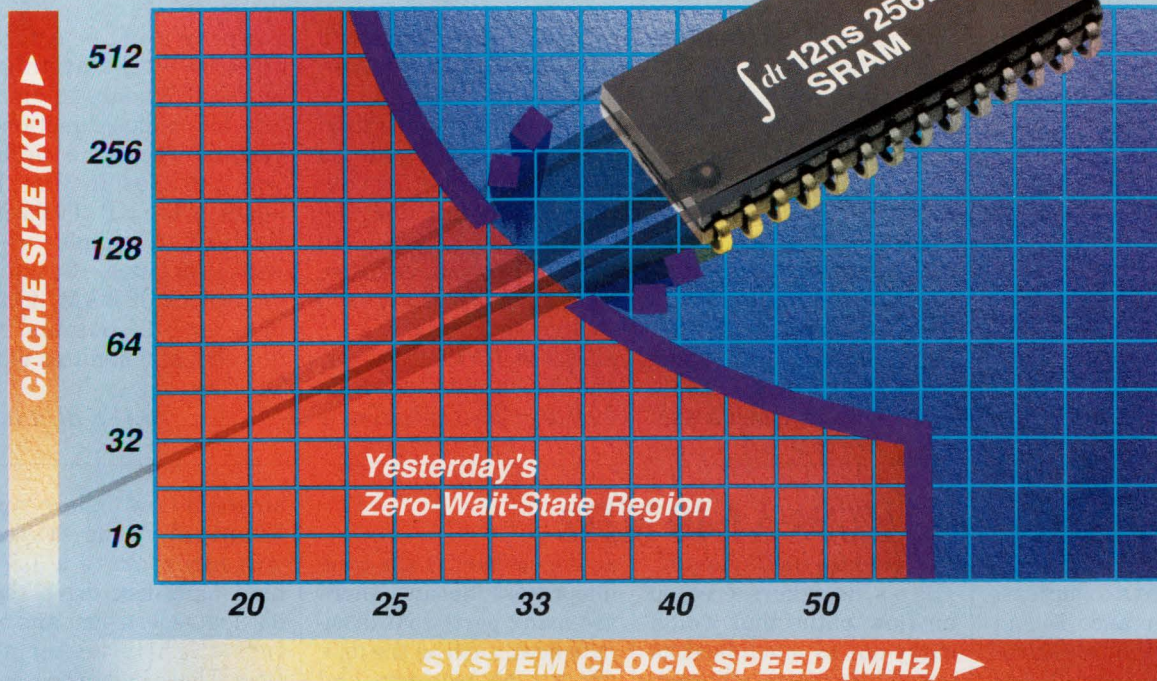

## 12ns BiCEMOS™ 256K TTL SRAMs

### Speed and Density

Now you can get cost-effective 12ns speed and 256K density. IDT's 256K BiCEMOS TTL Static RAMs are the ideal solution for high-density cache systems for applications like workstations, file servers, and graphics systems. These new-generation SRAMs provide the highest system speed without sacrificing system chip count or increasing power consumption.

### Fastest 256K SRAMs

IDT's 12ns 256K BiCEMOS Static RAMs are the fastest available 256Ks today and are the perfect match for optimizing the high performance needs of RISC and CISC processors. These SRAMs smash the barrier to efficient cache operation at the highest clock speeds.

BiCEMOS process technology achieves performance levels equivalent to "next-generation" CMOS technology and is the path to achieve zero-wait-state processing beyond 33MHz.

### Technology for the '90s

IDT's BiCEMOS technology offers the best of both worlds: the low power consumption of CMOS with the high speed of bipolar technology. And

BiCEMOS technology makes IDT's SRAMs the pace setters with ever-faster system designs. BiCEMOS is the technology for the '90s!

### 300mil Packaging

All of IDT's BiCEMOS SRAMs are available in 300mil PDIP and SOJ packages for easy design and layout. The 71B258 64K x 4 SRAM is available in

24-pin DIP and SOJ packages, and the 71B256 32K x 8 and 61B298 64K x 4 SRAMs are available in 28-pin packages.

### Free Samples Now!

Get your free samples of IDT's BiCEMOS TTL SRAMs today. Just fill out the coupon and send it in by FAX or mail, or call our Marketing Hotline at **(800) 544-SRAM.**

PLEASE COMPLETE AND FAX, OR MAIL IN AN ENVELOPE WITH YOUR BUSINESS CARD

**Yes! I want free samples of the fastest 256K TTL SRAMs!**

- Please send me data sheets on IDT's BiCEMOS SRAMs.
- Please have a salesperson bring me samples of the:
  - IDT61B298 (64K x 4) **12ns** TTL SRAM w/ $\overline{OE}$
  - IDT71B256 (32K x 8) **12ns** TTL SRAM

Name \_\_\_\_\_

Title \_\_\_\_\_

Company \_\_\_\_\_

Address \_\_\_\_\_

City/State \_\_\_\_\_ Zip \_\_\_\_\_

Phone (\_\_\_\_) \_\_\_\_\_ FAX (\_\_\_\_) \_\_\_\_\_

Send to:

**FAX: 408-758-4056**

**IDT SRAM Marketing**  
1566 Moffett Street  
Salinas, CA 93905

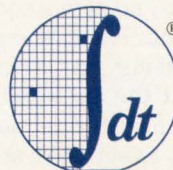

**Integrated  
Device Technology**

be verified by an exhaustive static timing analyzer, and the program works best for designs that employ synchronous logic. For asynchronous designs, the designer should identify equivalent signals between each test design and its specification to reduce the size of the logic segments that BoolVer must compare.

In addition, BoolVer

may require different-ordering heuristics for different types of circuits. Researchers at various institutions are studying advanced ordering schemes for ROBDDs.

Some actual test chips were run through BoolVer, and the results were compared to the results obtained for the same design run on a logic simulator. For the comparison,

an HP-400T workstation was used to run BoolVer. The processing time included the time required for BoolVer to build the ROBDD libraries for both the test design and the specification, as well as to do the Boolean comparisons. For a 43,686-gate chip containing 1184 latches, 8 blocks of RAM, 18 inputs, and 38 outputs, an Aida event-driven simulator

running on an Apollo DN4500 workstation required 397 hours to simulate 1.7 million functional vectors. The same circuit was verified in just 10 hours on the HP-400T with BoolVer. A simpler chip with 1339 gates, 104 latches, 1 block of RAM, 40 inputs, and 17 outputs required just 9 minutes with BoolVer.

DAVE BURSKEY

## MINI 486-BASED PC RUNS AT 40 MHz

The search for innovative ways to increase performance is endless. One method employed by computer manufacturers is to increase the microprocessor's speed by cooling it, which invariably means larger processor sizes due to the cooling mechanisms involved. Now there's a new technique that doesn't chill the processor, but keeps the chip cool enough to pump up its rated speed from 33 MHz to a blazing 40 MHz.

Falco Data Products Inc.'s, Sunnyvale, Calif., line of 386-based PCs gained the reputation of being very small—the latest 386 models fit in a box that's 13 by 10 by 2-3/4 in. When the company embarked on a 486DX version, it was determined to use the same small box. At the same time, the system had to run at 40 MHz. This meant solving an increasing heat problem inherent with a small-size box. Had the company decided to go with a larger box, the task would have been simplified, because a larger box would contain lots of air space, and a big fan could simply pump out the heat.

Through some innova-

tive cooling methodology, Falco's designers created air-flow paths that would carry out as much heat as possible using two thermostatically controlled, variable-speed fans. In addition, the fans aren't run constantly, lessening the power consumed by the fans and thus reducing heat. One fan is placed at the power supply's exit (*see the figure*). The supply is shielded in a box with air-flow vents in the front so that air is brought in, blown across the supply, and sent out the back of box. The second fan, which is positioned in front of the CPU, also vents air to the outside of the system.

The published specifications for the 486DX say that the chip will run at 33 MHz up to 85°C. But, using these basic cooling techniques, Falco got the chip to run at 40 MHz.

To be more specific, the chip isn't being cooled—it's kept from getting warm through simple aerodynamics. Aside from the fans, no active cooling elements exist. The system's housing was arranged so that the air would flow in the proper direction. In the PC, every part acts as an

active element in the cooling process. Because there are many parts that dissipate heat, such as the disk drives, the memory, and the CPU, air flow is vital. The heat sent out by those parts must be directed outward and away from the processor. The fans and air chamber obviously play a key role in directing the air flow. But other parts, such as the bottoms and sides of disk drives, the center dividers, the expansion cards, and even the routing of cable, all must be situated just right to keep the proper air flow.

Looking inside the case, it's obvious that parts were altered to achieve the proper air flow. But the OEMed parts, such as the fans and disk drives, weren't altered. These parts were accommodated into the system and designed around.

The physical sizes and shapes of the internal components became a key factor in system layout and design. Some very subtle dents or holes and components look like they're just hanging in space. For example, the 3-1/2-in.-diameter, 1.65-in.-high, hard-disk drive was mounted near the top of the case so that

air could flow underneath. Eventually, the system will incorporate a 1-in.-high hard-disk drive that dissipates less heat and offers slightly better air flow. There had to be a certain amount of space between the bottom of the disk drives, where the motors are, and the motherboard. The designers found that slight variations, such as moving the CPU one-quarter of an inch and straightening a particular cooling path, could make a 6° or 7° difference.

The air-flow design was basically done by trial and error, without using extensive CAD tools. There were instances where a standard 35-mm camera was used with infrared film to show the temperature in different places. The designers even pumped smoke through a Plexiglas-encased system to follow the flow of air.

Because some PCs in the field are never turned off, the "terminal temperature" must be one that's within the system's allowable limit. Terminal temperature is the maximum temperature that the computer will reach under normal operating conditions. Falco says that their system reaches that tempera-



# THE PTS 1000 SYNTHESIZER

COSTS MORE THAN SOME ECONOMY GENERATORS.

DON'T BUY IT, UNLESS YOU NEED:

## Good Sines & Bad Signs

Looking for a low-noise, fast-switching signal source?

### Good Sines

Whether it's automatic test equipment, satellite uplinks, EW communications or imaging systems, **Programmed Test Sources** has a frequency synthesizer to fit your needs. GE MRI units, Teradyne Testers, Varian Spectrometers . . . all use **PTS** synthesizers.

### Bad Signs \$\$\$

And while other manufacturers have big dollar signs, PTS synthesizers start as low as \$2,010.

**PTS** manufactures a complete line of precision synthesizers covering the 100 KHz to 1 GHz frequency range with switching times as fast as 1 $\mu$  second for our **direct digital** models. And plenty of other options as well, like resolution down to .1 hertz (millihertz available as special order), GPIB and digital phase rotation.

Just as important, along with every **PTS** synthesizer comes our "absolutely everything covered" **2-year warranty**. At the end of two years comes our flat \$350\* service charge for any repair up to the year 2001! **PTS** has a commitment to quality you won't find anywhere else.

Find out how **PTS** synthesizers used the world over can help you in your application today. Call for our complete catalog, or to talk to an applications engineer.

\*\$500.00 for **PTS** 1000.

Call (508) 486-3008

Fax (508) 486-4495

# PTS

PROGRAMMED TEST SOURCES, Inc.  
9 Beaver Brook Road, P.O. Box 517, Littleton, MA 01460



- Frequency switching time: 5 - 10  $\mu$ s
- Very low close - in phase noise:  
100 Hz = 100dBc/Hz  
10 Hz = 90dBc/Hz
- Absolute accuracy fully coherent with frequency standard (no offset), from 0.1 — 1000 MHz
- Modular flexibility
- BCD or GPIB control
- Remote-only versions
- Choice of resolution (standard to 0.1 Hz)
- Low power consumption
- High reliability from the premier OEM synthesizer supplier for over a decade.
- Low cost of ownership assured by 2 & 8 year warranty/service policy.

If you **do** need these specs, for \$11,525.00 you get all of the above with a high-stability  $1 \times 10^{-9}$ /day internal frequency standard.

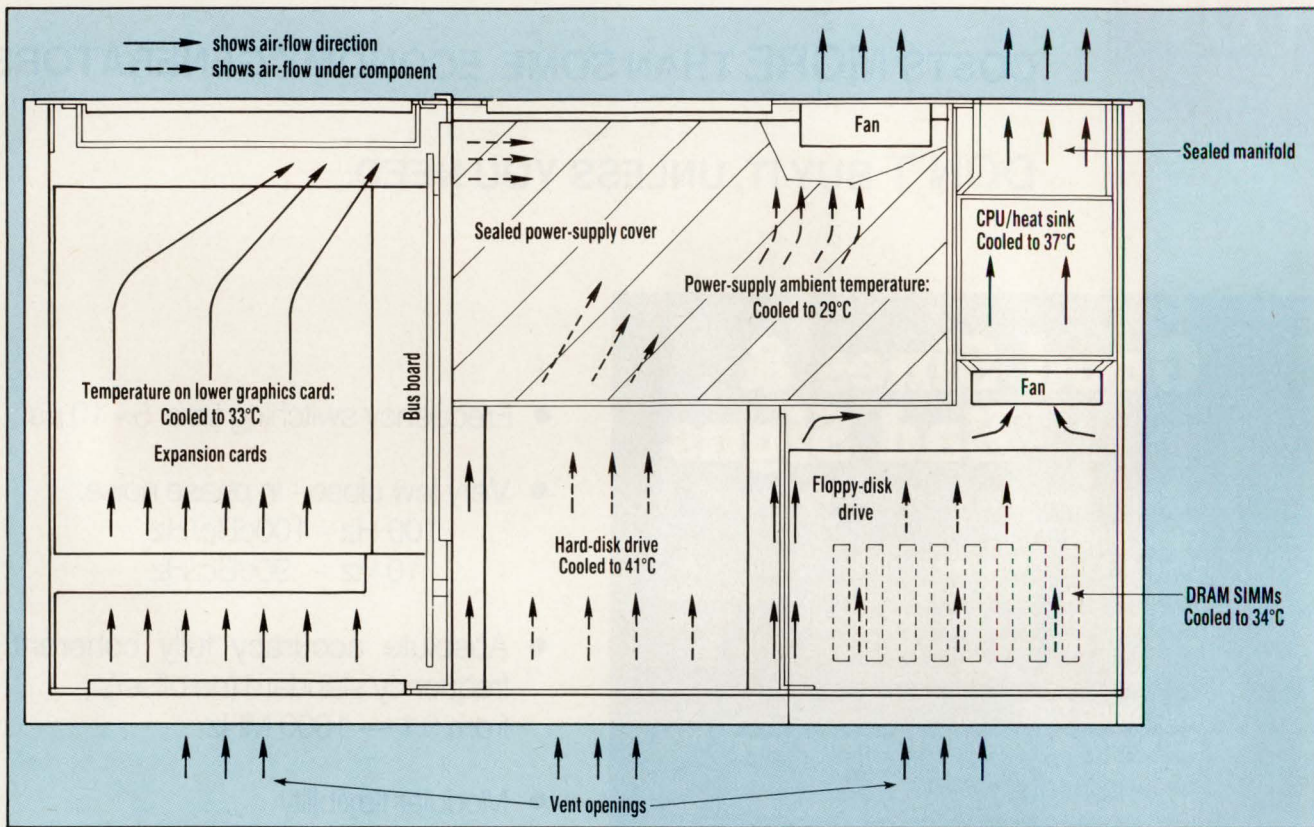

ture in about 3 hours. Its operating-temperature range is 5° to 40°C.

The only compromises Falco made to get down to such a small size is in the PC's expandability. There's only room for three ISA slots. But because so much functionality was built into the motherboard, the number of expansion boards needed is minimal.

The motherboard is designed to run at 50 MHz. Therefore, when Intel releases the 50-MHz version of the 486, Falco will simply substitute that chip for the 33-MHz chip. Because all of the heat-dissipation mechanisms are already built in, Falco's 50-MHz design will have immediate stability. The company also feels it might be able to push this design with the 33-MHz part to 50 MHz. Some issues, such as lower power drain, still stand in

the way.

Falco developed their own BIOS for the system. The designers made sure that the system was downward-compatible with all existing 286- and 386-based products.

The system, dubbed the GT486/40, will be available by the end of this month for under \$6000. The price includes 4 Mbytes of main memory (expandable up to 32 Mbytes), a 2.88-Mbyte floppy-disk drive (compatible with a 1.44-Mbyte format) with an external floppy-disk port, a 100-Mbyte hard-disk drive (expandable up to 200 or 420 Mbytes), and a color display. The price can range up to \$8000, depending on the amount of installed memory and storage capacity. Call Heidi Sodos of Falco at (800) FALCO-4U or (408) 745-7123.

RICHARD NASS

## MULTICHIP MODULES HIT DESKTOPS IN PROTOTYPE DEMONSTRATION BY IBM

**M**ultichip modules (MCMs), which for years have been a staple in semiconductor packaging for mainframe computers, will have to trickle down to the desktop and workstation level if those machines are to fully exploit the processing speeds promised by CMOS. Eying future generations of PCs and workstations with 100-MHz clock speeds, an IBM Corp. research project has successfully demonstrated a prototype MCM that contains the entire central-electronics complex of its RISC System/6000 Model 540 and 320 machines.

The prototype module, which holds nine individual

chips and 100 feet of interconnecting wire, is the result of a joint project between IBM's T.J. Watson Research Center, Yorktown Heights, N.Y., its Advanced Workstations Division, Austin, Texas, and its Yasu Technology Applications Lab, Yasu, Japan.

According to David McQueeney, manager of VLSI packaging at the T.J. Watson Research Center, the rapid increases in circuit density that come with CMOS mandated the effort to import MCM technology to desktop machines. "The RISC chips in the System/6000 have 256 signal I/Os, and as we go to future generations of logic that are derived from future gener-

TECHNOLOGY ADVANCES

What do p-channel load switches give battery powered systems?

# LIFE EVERLASTING

Life everlasting.  
Well, not quite.  
But it may  
seem that  
way to users  
of your battery-  
powered system.



**Double battery life during normal operation! And increase it by 1000% (ten times) in standby mode!**

How? With Siliconix' Si9405 load switches. Devices that let you shut down unneeded sections of your system. Now you can turn off the display, disk drive, internal FAX/modem, coprocessor, extra memory, transmitter and other analog functions when they are not in use. Then activate them instantly from your standby mode.

#### Added value.

This improved power management empowers your system with (almost) life everlasting. It's a compelling competitive advantage that will significantly increase your product's

market share and profit margin.

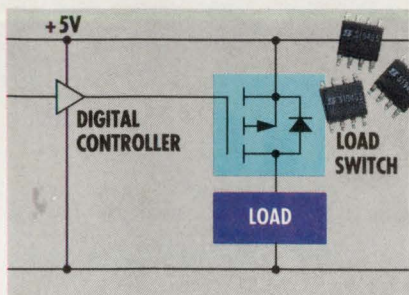

#### LITTLE FOOT™ packaging.

The 5-V logic compatible p-channel Si9405 has an incredibly

low 120-m $\Omega$  on-resistance that allows simple switching of high currents. And it comes in a space-saving LITTLE FOOT SOIC 8-pin package — assuring your portables will be truly portable, your laptops lap-size, and your notebooks notable. Other small footprint solutions are listed below.

#### Siliconix P-Channel & N-Channel Load Switches

<b>Si9400DY</b>	Single P-channel, 250 m $\Omega$
<b>Si9405DY</b>	Single P-channel, 120 m $\Omega$
<b>Si9953DY</b>	Dual P-channel, 2 x 250 m $\Omega$

*These SO-8 IC devices can be driven directly by 5-V logic.*

<b>Si9956DY</b>	Dual N-channel, 2 x 100 m $\Omega$
-----------------	------------------------------------

*This SO-8 IC device is ideal for higher current loads.*

<b>SMP60N03-10L</b>	Single N-channel TO-220, 10 m $\Omega$
---------------------	--

*A great solution for switching between batteries.*

Get more compact and power-saving designs! Call our toll-free hot line now. **1-800-554-5565, Ext. 560.** Ask for our "Power Management" Design Kit. And remember, at Siliconix we're committed to achieving a seamless interface between the power and digital worlds.

## Siliconix

2201 Laurelwood Road, Santa Clara, CA 95056

## TECHNOLOGY ADVANCES

ations of DRAM technology, the number of circuits on the chip and the inputs and outputs to support them rise dramatically," McQueeney explained. Systems built with several CMOS chips with that kind of I/O requirement translates into a great deal of interconnection wiring to stitch them together.

The densely packed, 4.5-in.<sup>2</sup> module carries 512 signal lines and has a total I/O count of 684. Its 13- $\mu$ m-wide interconnection lines are sandwiched in eight alternating layers of aluminum wiring and polyimide insulator. The nine CMOS chips are bonded directly to a silicon base using IBM's longstanding C-4 flip-chip process for bipolar chips in

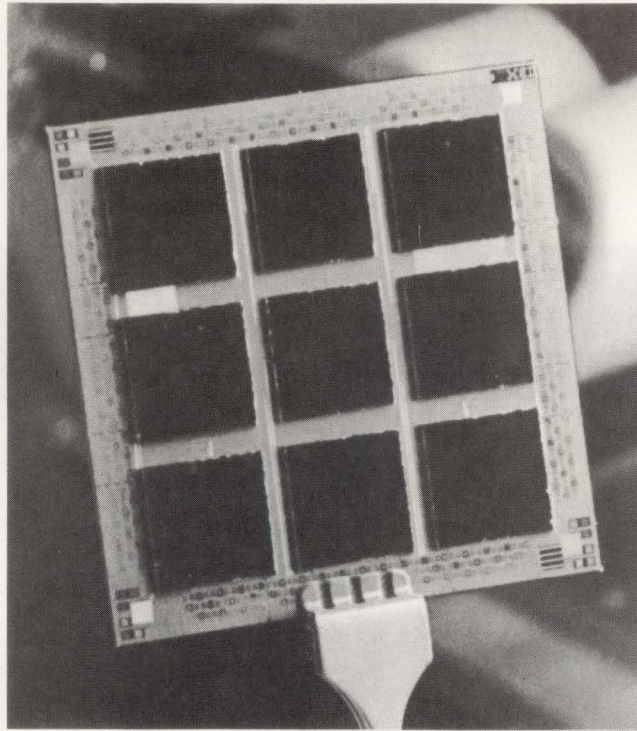

mainframe MCMs (see the figure).

The nine CMOS chips in the module are those found in the RISC System/6000 central-electronics complex, and include the floating-point chip, the fixed-point chip, the instruction cache, the storage-control chip, the I/O-control chip, and four data-cache chips. The module has been incorporated in prototype versions of the IBM RISC System/6000 models 540 and 320 computers.

Going to MCMs gives system integrators all of the technology's traditional benefits, which include higher wiring density and better electrical performance. The quality of the transmission lines im-

## Every connecting product for every kind

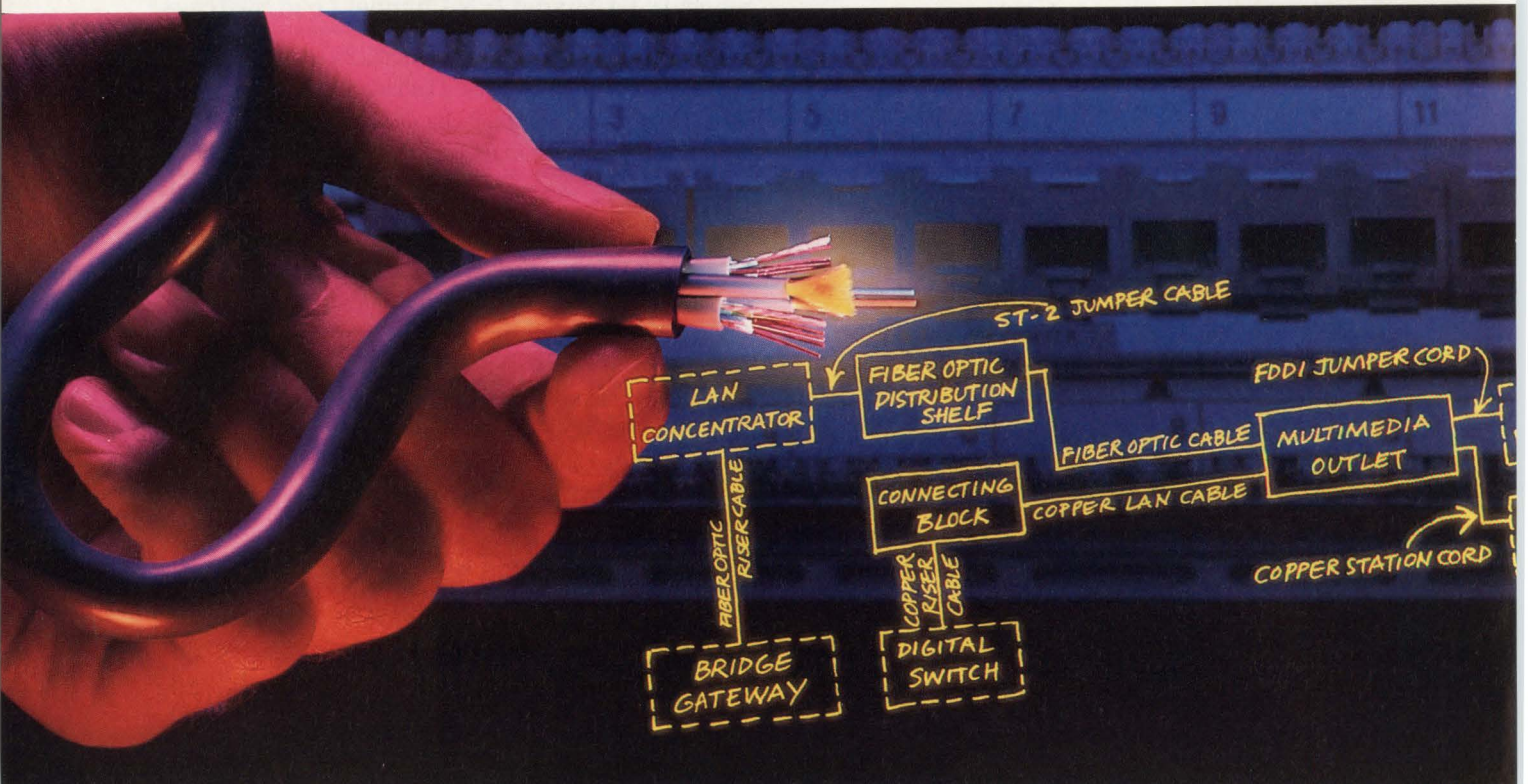



## TECHNOLOGY ADVANCES

proves as does the spacing between chips. In the case of the RISC System/6000, the real-estate gains translate into a package that's about 12 times smaller than the 56-in.<sup>2</sup> board it replaces.

IBM chose silicon as the substrate for its desktop MCMs because it was easy to fabricate on existing lines set up to do CMOS logic. In addition, silicon offers compatibility with the bare CMOS die it carries in terms of thermal coefficient of expansion. On top of that, the substrate has very high thermal conductivity. That makes it an excellent substrate choice for a package that contains all of its power distribution and wiring in thin-film lay-

ers, McQueeney said.

In developing the process for the module, IBM's research teams cultivated the experience of the company's mainframe-packaging designers. "The things that were difficult about this project weren't what we expected to be difficult," McQueeney said. "It was all the issues of putting the module together and providing adequate test coverage of the chips when they're on a multi-chip module, and understanding how to do burn-in and assembly at high yield and low cost." Actual fabrication of the substrate turned out to be straightforward. The logistics of the module's assembly were worked out with the

help of the mainframe-packaging experts to facilitate rework.

Testing of the chips is done first at the wafer level. Then, after attachment, a set of pads, which is used only for test and burn-in contactors, is placed on the module's perimeter. These pads reside in a part of the module that eventually is covered by a seal to its aluminum cap, and is thus unusable for active circuitry. The module's final test follows board attachment.

Attaching the entire module to its circuit board is accomplished with TAB film that acts as a flexible, surface-mount-compatible interconnection. The link is made with four independent pieces that translate

the module's tight I/O pitch to the somewhat looser pitch required for a board. The TAB film is soldered to the board using a gang-bonding process. The use of a surface-mounted connection to the board is a departure from IBM's usual pin-grid-array approach, which requires a zero-insertion-force socket that's probably too expensive for the module's intended class of machines, McQueeney said. A surface-mounted arrangement is also compatible with all of the board-assembly processes used for PCs and workstations.

IBM has already run the module through its internal qualification procedures, which verify that it

of connection.

© 1991 AT&T

## That's AT&T "Customerizing."

**AT&T is your one-stop quality source for everything from cable to splicing and test equipment.**

Whether it's data cable, composite cable, optical cable or fiber, AT&T has it all.

Along with 110 Connecting Blocks, ST<sup>®</sup> Connectors, FDDI Jumpers, and any number of other connecting products.

Everything you need in copper and fiber optics for the transmission of voice, data, image, and remote sensing.

Everything you need for all your applications, such as LAN and harsh environment, off-the-shelf or custom designed.

Technical support? We'll work side-by-side with you to design special situation connections. And we'll provide system as well as component solutions.

You also have AT&T's assurance of product quality and reliability. Backed by the design and technology expertise of AT&T Bell Laboratories. And by a century of AT&T cable and apparatus manufacturing experience.

Giving you everything you need. Exactly the way you need it. That's what we mean by "Customerizing."

For more information, just give AT&T a call at 1 800 344-0223, ext. 1053.



**AT&T**

Microelectronics

CIRCLE 206 FOR U.S. RESPONSE  
CIRCLE 207 FOR RESPONSE OUTSIDE THE U.S.

GRAPHICS  
WORKSTATION  
ISDN  
STATION

## TECHNOLOGY ADVANCES

meets all pertinent reliability specifications. In declining to speculate on the company's specific production applications for the technology, McQueeney stated that almost any

CMOS engine complicated enough to be more than one chip would require such a packaging scheme within the next generation or so of CMOS logic.

DAVID MALINIAK

### SERVO SIMULATOR CUTS DISK-DRIVE DEVELOPMENT TIME

Many disk drives, including hard, floppy, removable Winchester, and optical types, can take a year or longer to develop. This is because the drive maker must first wait for an accompanying servowriter to be built. The servowriter is a sophisticated machine that writes reference in-

formation to the disk's surface so that the read/write head is placed accurately. Now that lengthy development process has been cut by many months with the development of a servo simulator from Helios Inc., Sunnyvale, Calif. (see the figure).

The \$29,000 Proteus simulator simulates the servo

signal of any disk drive before the drive is even built. This enables the design engineer to develop and debug the drive servo electronics before the drive hardware or servowriter even become available.

Proteus simulates the composite servo-signal output of a disk drive as though the signal was derived from reading the servo pattern from the disk surface. The simulation of this signal is unique because it's created by the interference of two separate channels used for position reference. The channels exhibit an interdependence when changing, an interdependence that indicates head position and movement. Thus, the servo sig-

nal simulates the drive's read/write head while staying on track and in the seek mode.

Traditionally, development of hard-disk-drive electronics has been delayed until two critical stages were achieved—the manufacture of the drive hardware and the development of the servowriter. The drive castings with the actuator, read/write head, and media had to exist, and the servowriter had to write the servo patterns (reference material) on the disks before the electronics could be tested and debugged. Using the Proteus simulator, designers can test and debug the electronics with the initial servo system design, typically

## Venture into the Modulation Domain and

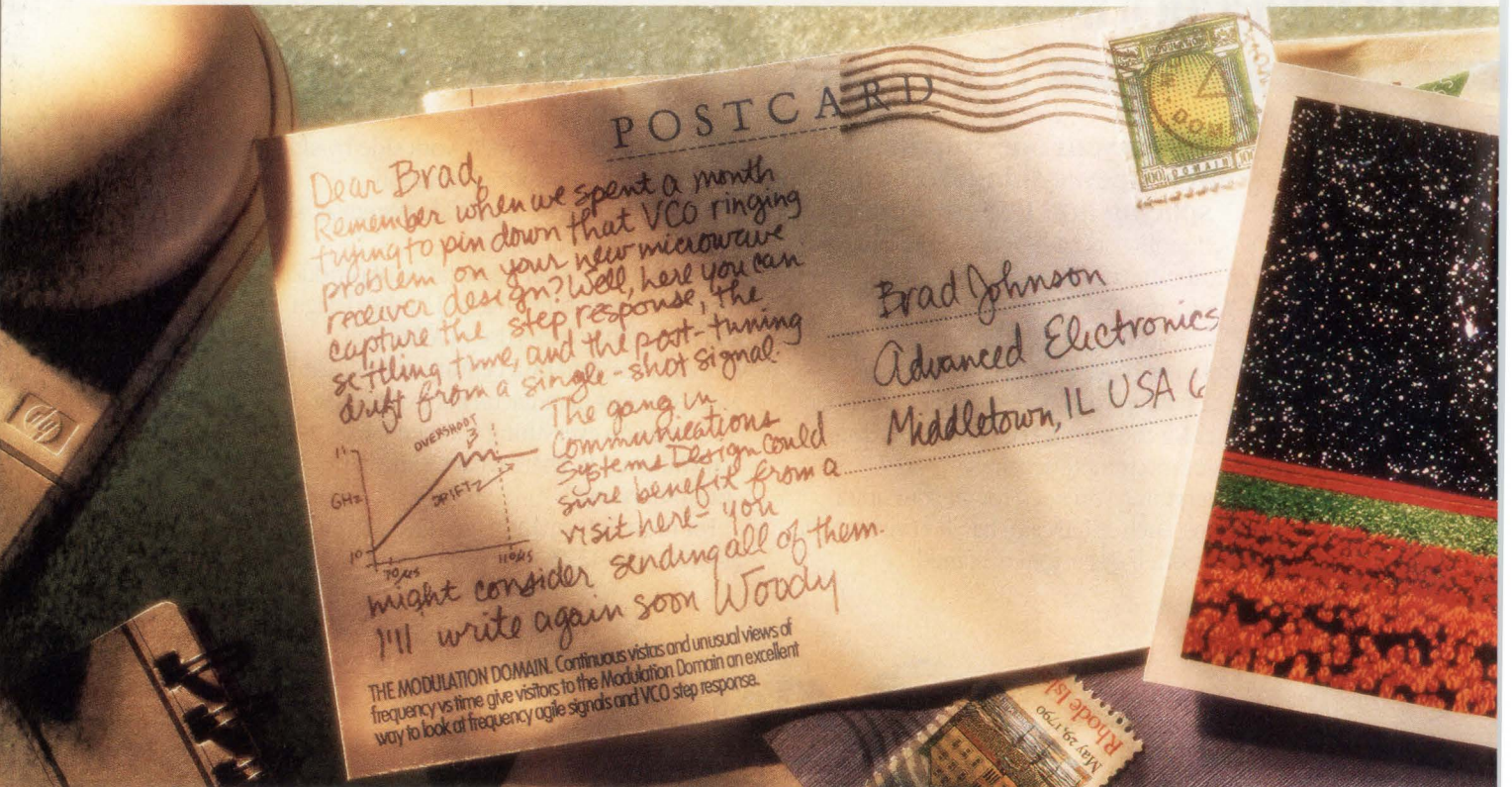

## TECHNOLOGY ADVANCES

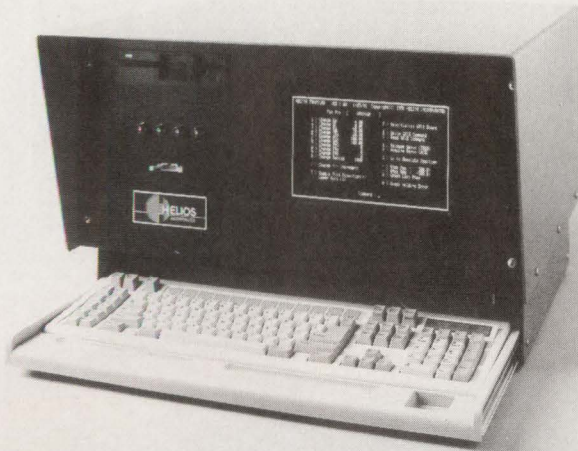

four to six months ahead of schedule.

In addition, designers also had to wait to develop the servo electronics until the actual drive mechanism was built. Proteus

eliminates this wait, making it possible for boards to be developed and debugged prior to the availability of the drive mechanics.

Proteus can also be used

in the manufacturing process to improve product quality. Drive electronics are currently production-tested by connecting to a disk drive, or by using the actual drive mechanics. This means that the test only offers results of the electronics with a specific drive under nominal conditions—extreme conditions aren't tested. Proteus can be programmed to simulate any condition, including worst-case mechanical characteristics, to test the electronics' tolerance and recovery capability. By testing the boards under worst-case mechanical conditions, the electronics design and production process results in higher product quality and yields.

Proteus is fully programmable to simulate the head-disk assembly, including the voice-coil motor, mechanics characteristics, and the movement of the read/write head across the media. The designer can program a seek profile, nonrepeatable and repeatable runout, media defects, and servo patterns. The drive's servo patterns can be programmed to the single-transition level, and closed-loop, complete feedback operation can be simulated. Moreover, mechanical phenomena can be simulated, observed, and studied.

For more information, contact Helios at (408) 732-8208.

RICHARD NASS

## improve your powers of observation.



When characterizing VCO responses and frequency agile signals, most designers depend on their powers of deductive reasoning. The Modulation Domain offers a more direct approach. It brings changes in frequency vs. time clearly into view. So you can see the transient response and post-tuning drift of a single-shot VCO step, or the chirp linearity and staggered PRI of a frequency agile signal. On a single display. In seconds.

Find out how looking at frequency vs. time in the Modulation Domain can make you a better designer, call Hewlett-Packard at 1-800-752-0900\*. Ask for Ext. 1828, and we'll send you a *Visitor's Guide to the Modulation Domain* on floppy disk, complete with a list of sights and excursions you won't want to miss.

There is a better way.



\*In Canada, call 1-800-387-3867, Dept. 419.

Any similarity to existing persons or companies is purely coincidental.

© 1990, Hewlett-Packard Co. TMSCD054A/ED

CIRCLE 244 FOR U.S. RESPONSE

CIRCLE 245 FOR RESPONSE OUTSIDE THE U.S.

*Making the interface transparent  
to sub-nanosecond rise times.*

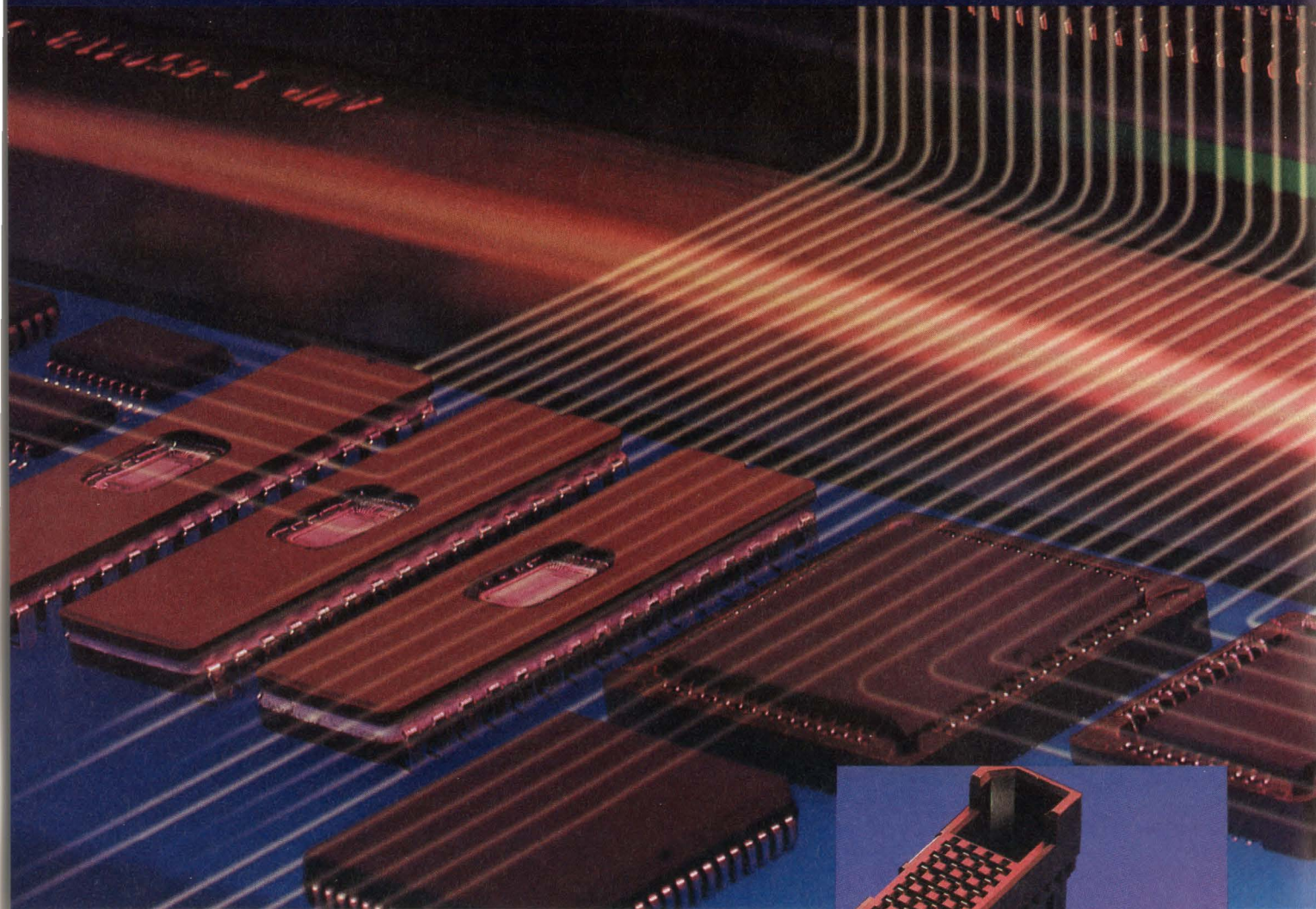

***THIS IS AMP TODAY.***

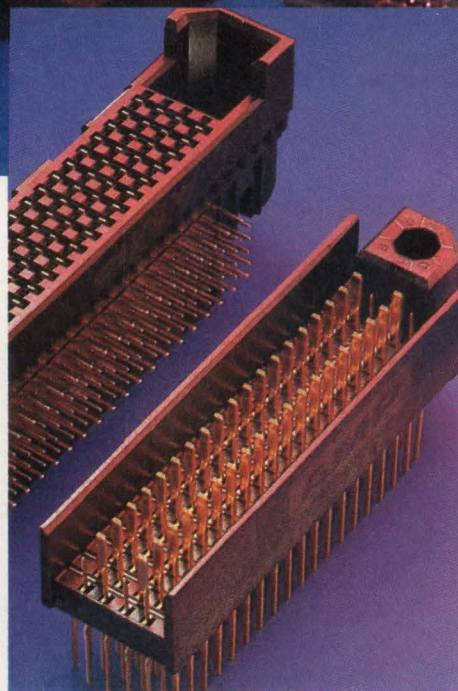

*Stripline high-performance connectors.*

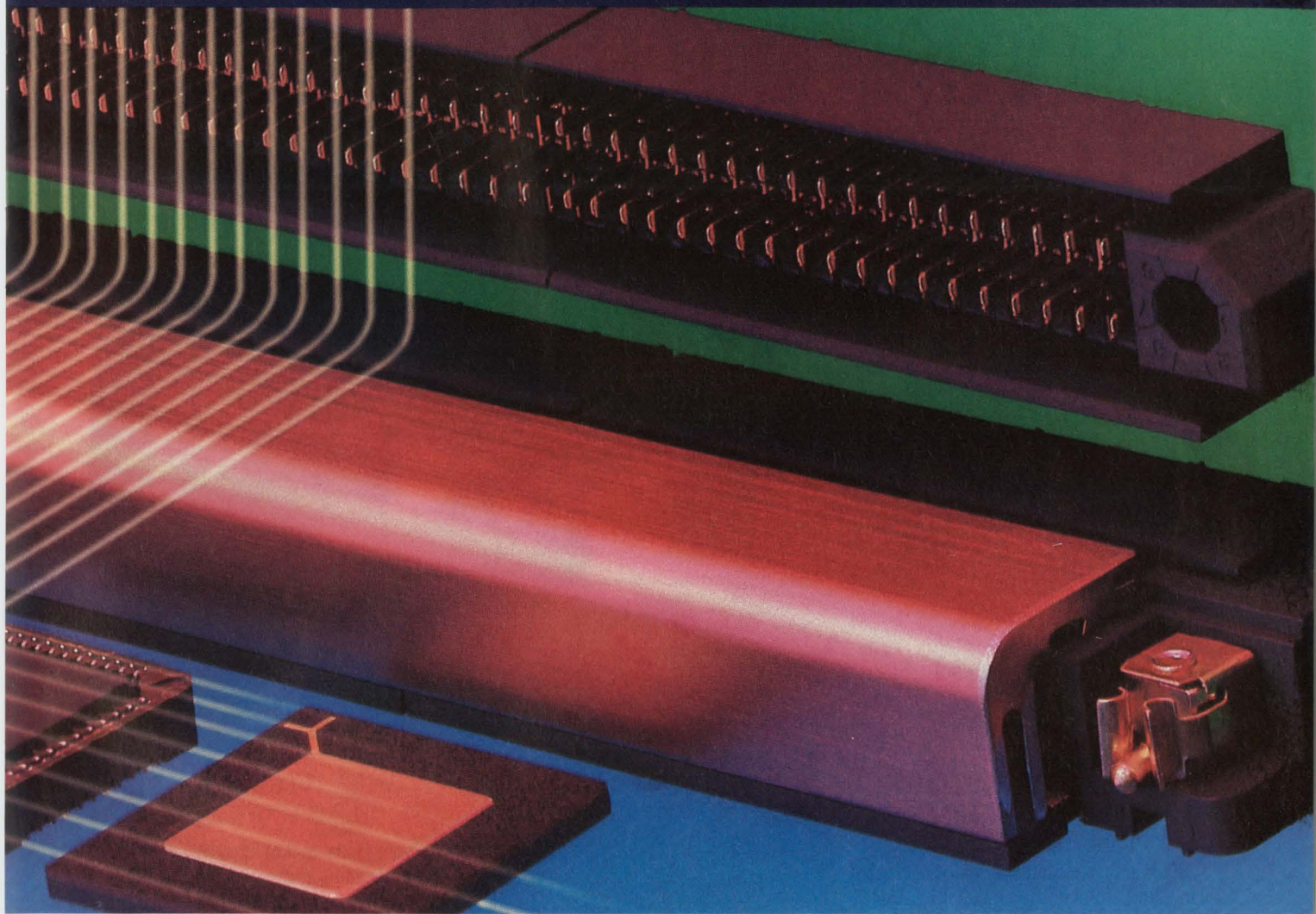

'Fast silicon' (rise time  $\leq 1$  ns) requires strict impedance control. Conventional connectors give up half their pin count for this – a sacrifice you can do without.

Our modular, scalable Stripline 100 connector system can accommodate edge rates of 250 ps (500 ps at  $<3\%$  crosstalk), and still give you 40 signal lines per inch – all four rows on a .1"x.1" grid. Reference planes isolate individual signal columns within the standard grid geometry, creating an interface completely trans-

parent to high-speed logic.

Stripline 100 connectors deliver more than raw speed, too. Each reference plane can distribute three amps, and sequenced mating is available for ground, power, and two signal levels.

Manufacturing is easier as well. ACTION PIN compliant posts (for existing 0.040" pcb holes) simplify backplane assembly, and all materials are compatible with high-temp reflow processing.

In fact, sub-nanosecond logic just got easier all around, and there's an easy way to 'bring yourself up to speed' on this exciting technology: call our Product Information Center at 1-800-522-6752 (fax 717-561-6110). In Canada call 416-475-6222. AMP Incorporated, Harrisburg, PA 17105-3608. For design assistance in characterized backplane assemblies, contact AMP Packaging Systems Inc., 512-244-5100, P.O. Box 9400, Austin, Texas, 78766.

# AMP

CIRCLE 186 FOR U.S. RESPONSE

CIRCLE 187 FOR RESPONSE OUTSIDE THE U.S.

# Opus introduces something new to the SPARC market. A choice.



## THE PREMIER SPARC-COMPATIBLE MANUFACTURER THAT OFFERS YOU A CHOICE.

SPARC® is the definitive choice for workstations, and Opus is the choice for SPARC. Opus offers a range of affordable SPARC solutions, from PC add-in boards to workstations, file servers, and multiuser systems.

## OPUS PRODUCTS ARE 100% BINARY COMPATIBLE WITH SUN SPARCSTATIONS™.

Opus is the second largest supplier of SPARC workstations worldwide. We offer innovative SPARC-compatible products supported by senior UNIX® engineers and comprehensive service programs.



All SPARCstation applications run effortlessly on our systems. They are fully compliant with the binary compatibility standards (SCD 1.0) defined by SPARC International.

## IF YOU WANT SPARC AND YOUR PC, CHOOSE THE 500PM.

Transform your PC into a high-performance SPARC-compatible UNIX system. The 500PM occupies a single IBM® PC/AT® slot, allowing you to run native SunOS™ and MS-DOS®. Now you can take advantage of the wealth of DOS and SPARC-based applications.



## WHEN IT COMES TO SUPPORT, OPUS IS YOUR BEST CHOICE.

Every Opus system includes a hardware warranty and software support free for one year. Cost-effective, extended service programs are available, including on-site hardware service seven days a week, 24 hours a day.

## TEST OUR COMPATIBILITY.

If your SPARC applications aren't fully compatible with your new Opus system, let us know within 30 days after purchase, and we'll send your money back.

FIND OUT MORE ABOUT OUR GUARANTEE, AND GET THE NAME OF AN OPUS REPRESENTATIVE NEAR YOU.

Call 1-800-952-6300, ask for Dept. 521.



# OPUS

S Y S T E M S



DESIGN SPARC-BASED WORKSTATIONS WITH 50% FEWER CHIPS THAN BEFORE.

# CHIP SET ADDRESSES LOW-COST WORKSTATIONS

RICHARD NASS

**T**he demand for high-performance desktop systems seems to be insatiable if the right performance and price points can be hit. However, fully configured RISC-based workstations may still command a significant price premium over IBM PC-compatible CISC-based platforms. To bring the RISC-based systems cost down, system suppliers have to integrate the large number of chips that are typically required on the motherboard. Unlike the PC market, which has over 30 motherboard chip-set suppliers, there are only one or two in the fledgling workstation market. Workstation vendors have, for the most part, done the integration with proprietary chip sets to bring base system prices to less than \$5000.

Thanks to a new motherboard logic chip set, Tera Microsystems has created a product that any design team can use to build even more cost-effective RISC systems. Its microCORE chip set has allowed the company to open up the workstation market. The chip set packs all of the base-level functionality for Sparc-based workstations into just two to four VLSI chips. By carefully tuning the system architecture to optimize the chips' functionality, Tera's designers have compressed all of the control for a monochrome system into two chips (including the video support), and for a color system into a four-chip set (the first two chips plus two more).

Tera Microsystems' designers initially decided to support the Sparc architecture because it currently has the largest application-software base. Later, the company plans to address other popular architectures. During



the chip set's development, Tera focused on areas that most chip-set vendors had not fully exploited with integrated solutions—graphics, I/O, and memory control.

The chip set consists of the TM5610 System Controller Unit (SCU) and the TM5620 I/O Controller (IOC). With these two chips, designers can build a system with equivalent functionality to a Sparcstation SLC. However, Tera's engineers felt that the SLC had lim-

# LOW-COST RISC-WORKSTATION CHIP SET

itations that they could improve on the basic system. For instance, the SLC is only upgradable to 16 Mbytes, it can only use a monochrome display, it's limited to 20 MHz, and it isn't very expandable. With the microCORE chip set, designers can build 25-, 33-, or 40-MHz systems that offer much more expandability.

An SLC-equivalent motherboard can be built with just 15 to 20 components and without any static RAMs (Fig. 1). Furthermore, except for the microCORE chips, all of the other components, including the Sparc CPU and peripheral control and interface chips, are readily available from multiple vendors.

The SCU, the heart of the motherboard, has lots of built-in features. These include an 8-kbyte cache that's actually split into 2 caches, 4 kbytes for instruction and 4 kbytes for data. There's also a dynamic-RAM controller that can handle up to 64 Mbytes of main memory and a bus-arbitration unit to control the traffic going to main memory. The chip's 64-entry fully associative memory-management unit (MMU) follows the Sparc Reference MMU specification so that people building a software

port can utilize the standard MMU virtual memory code. The SCU also supplies the clock and the reset logic to the entire system. It actually generates the clock for the CPU and a reset signal to the CPU and all of the peripheral controllers. Integrating the cache, MMU, and DRAM controller makes it easier to scale to higher frequencies because all critical timing is contained in one chip.

At first glance, it appears that the microCORE chip set contains a small cache for a workstation-level system. But keep in mind that a key component of cache performance is the miss penalty or latency of the main memory. Tera has integrated the cache, the MMU, and the DRAM controller all onto one chip. Therefore, no bus or chip transactions are made from one chip to another. The signals never have to go across the bus, which eliminates added cycles. The miss penalty is thus an average of about 5-1/2 cycles. The main memory controller uses page-mode DRAMs with bank interleave. The miss penalties here range from 4 to 7 cycles (7 is worst case).

Another feature of the cache mem-ory that allows the system to run as

fast as possible is its support of instruction and data streams. If the CPU request results in a cache miss, it'll lock up and wait for the first word back. It doesn't have to wait for the rest of the cache block to fill up before restarting. Other cache implementations force the CPU to wait until the cache-line fill is complete before proceeding. And because the instruction and data caches are separated, the CPU can continue to access the data cache while an instruction fill is completing, or vice versa.

An 8-word write buffer was included so that the CPU wouldn't be held up during store instructions. Because of the write buffer's depth, the system rarely interlocks on store commands. The chip set can merge bytes and half-words through the write buffer, decreasing the bandwidth occupied by stores.

A write-through hardware cache-coherency scheme is employed. To minimize the amount of memory bandwidth that's used, the chip merges two single-word stores into one double-word store. Because the caches are physically addressed, not virtually addressed, there's no concern with aliasing. In addition to the

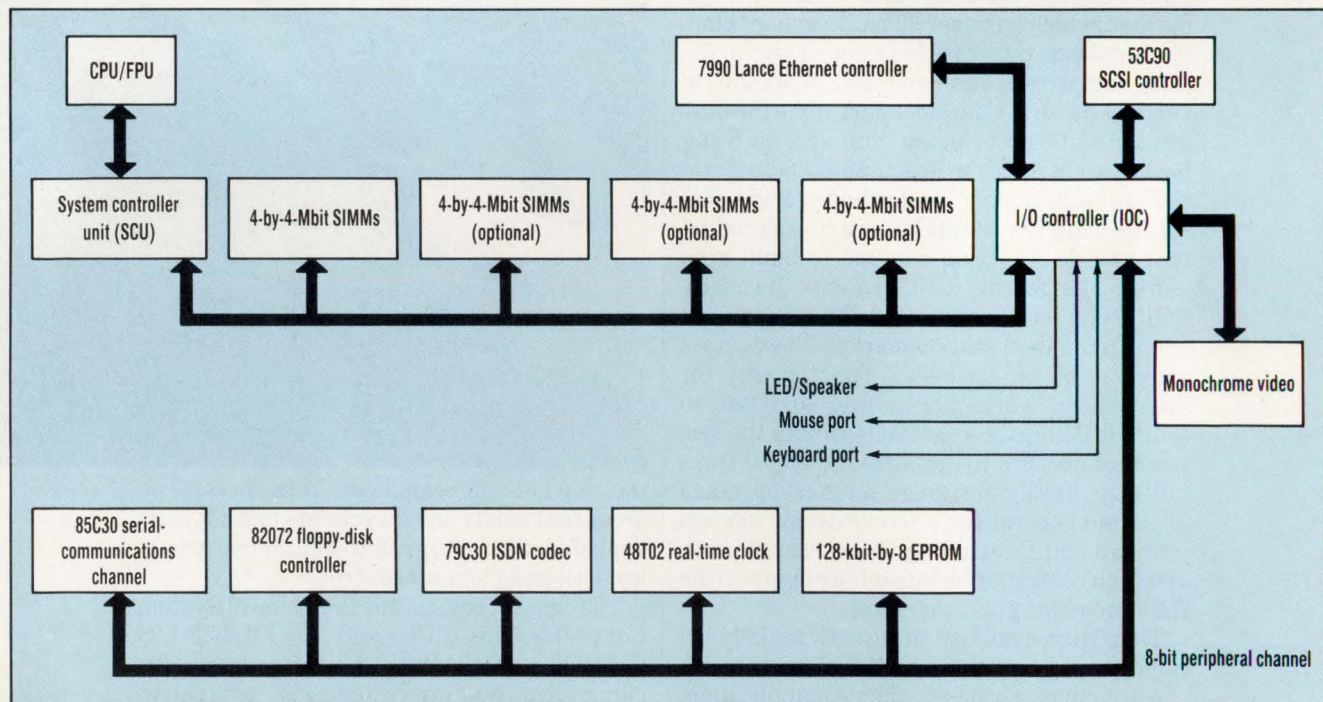

**1. BY USING THE MICROCORE CHIP SET,** a Sparcstation SLC-equivalent workstation can be designed with just 15 to 20 off-the-shelf peripheral control and logic chips. In addition, all of the SRAMs found in Sun's implementation can be eliminated.



## LOW-COST RISC-WORKSTATION CHIP SET

integrated cache's lower component count and lower cost, the cache doesn't have to be flushed as often.

The chip's MMU is compatible with the Sparc Reference MMU. It's a standard 64-entry fully associative translation lookaside buffer (TLB). All of the TLB miss handling is done in hardware, increasing performance. The chip supports virtual addressing throughout the entire system, meaning that every I/O transaction out to the SCSI and Ethernet controllers is virtually mapped. This is advantageous from a software standpoint, because address-mapping mechanisms can be used for all transactions within the system, and simplifies programming.

There are three ways to transfer a DMA block to and from main memory. The first approach, a basic method, is software chaining where the software sets up the DMA channel on a page basis. Every time there's a block transfer that causes an interrupt, software has to run through the mapping mechanism. The second way is hardware chaining. Here, software sets up a translation table beforehand and the hardware just runs full steam ahead and accesses the software table. Tera, though, has implemented a third method, virtual DMA. Here, all I/O traffic goes through a standard MMU. The translation tables set up for a particular CPU's operating system are also used for I/O. In this case, the complicated hardware chaining devices needn't be built into the components. Therefore, virtual DMA lowers software overhead, simplifies the hardware chaining, and memory protection comes for free because the standard MMU is being used.

The address-translation processor (ATP) within the MMU services all address translation requests. This means that CPU-TLB misses are serviced by the ATP. I/O-TLB misses are also serviced by the centralized TLB miss-handling mechanism. Therefore, the SCU performs the translation service for I/O DMA activity besides CPU references. Other implementations haven't centralized this procedure on one chip.

The chip set can link up to four 36-

bit DRAM banks (the extra bits are needed for parity to be added to main memory), and supports 1- and 4-Mbit DRAMs in by-1 and by-4 configurations. Two- or four-way page memory interleaving can be done with page-mode DRAMs. Tera also added support for SRAM- and EPROM-based memory banks for real-time high-end embedded control.

The memory interconnect bus, a fully synchronous local bus on which all of the Tera components reside, contains multiplexed address and data lines (32 bits plus parity) and supports 36-bit physical-memory space. Variable-length block transfers are supported, including 1 to 8 and 16 words. The bus control and arbitration is done within the SCU.

Tera chose to do its own nonproprietary memory-interconnect scheme (microBUS) rather than use Mbus, to address the low-cost entry-level workstation market. Mbus isn't an optimal solution because of its higher pin count and the lower memory-CPU bandwidth requirements of a uniprocessor system. The Mbus has 74 pins (about 99 if power and ground lines are included). The microBUS uses 44 pins (59 with power and ground). Power and die-area reductions result from fewer pins, enabling the chips to be packaged in PQFPs. The bus also includes a balanced memory and CPU bandwidth.

The IOC chip is typically implemented by others in three or more chips. Tera packed what it feels is all necessary I/O control into one chip. The part links directly to AMD's 7990 Lance Ethernet controller and to a 53C90 SCSI controller chip. It can also connect to up to eight byte-wide peripheral and memory devices, such as a floppy-disk controller, EPROM, a real-time clock, and serial-controller devices. And it has a built-in monochrome video-display controller. Other internal peripherals include two buffered serial receive-and-transmit ports, three DMA controllers, and multiple mini-TLBs. Both the Ethernet and SCSI controllers have their own DMA-control devices. The IOC also contains three counter-timers and a system interrupt controller that collects all

of the interrupt signals from up to 21 sources within the system and translates that data into the interrupt lines that the CPU wants to see.

The Ethernet channel contains a 16-byte FIFO for byte and half-word assembly/disassembly so that the memory-bus bandwidth isn't saturated with low-byte-count transfers. The goal is to catch as much data in a block before sending it onto the memory bus at a high speed.

The SCSI channel also has a 16-byte FIFO for byte assembly/disassembly and a single-entry mini-TLB. To overcome the low-performance limitation of the Ethernet and SCSI controllers, Tera added enough intelligence into the I/O controller and buffer so that performance wouldn't be degraded by hanging Ethernet and SCSI devices directly on the high-speed memory bus.

The byte-wide peripheral channel has a single-entry mini-TLB for each of the three undedicated DMA channels. There are one-word buffers for byte assembly/disassembly. And all eight devices that can hang off the bus are software-mappable and can have variable-access times.

The video-display controller that's also embedded in the IOC chip supports monochrome resolutions up to 1280 by 1024 pixels. The buffer is DRAM main-memory based. There's an 18-word FIFO buffer that sends pixels out to the display. Eight-word transfers from main memory are used to minimize bus time. For high resolution, the controller sends out two pixels at a time (an external multiplexer would be needed). The controller has a built-in X-Windows-compatible hardware cursor. Video-sync timing is generated internally.

Two asynchronous serial ports with programmable-baud rates are added for keyboard and mouse support. This eliminates another external dual serial-port chip. The system interrupt controller supports 21 sources—11 within the IOC and 10 that are external. One of the chip's fully programmable counter-timers can drive a speaker.

By adding two extra components to their systems—the TM5640 Color Video-Display Controller and the

# LOW-COST RISC-WORKSTATION CHIP SET

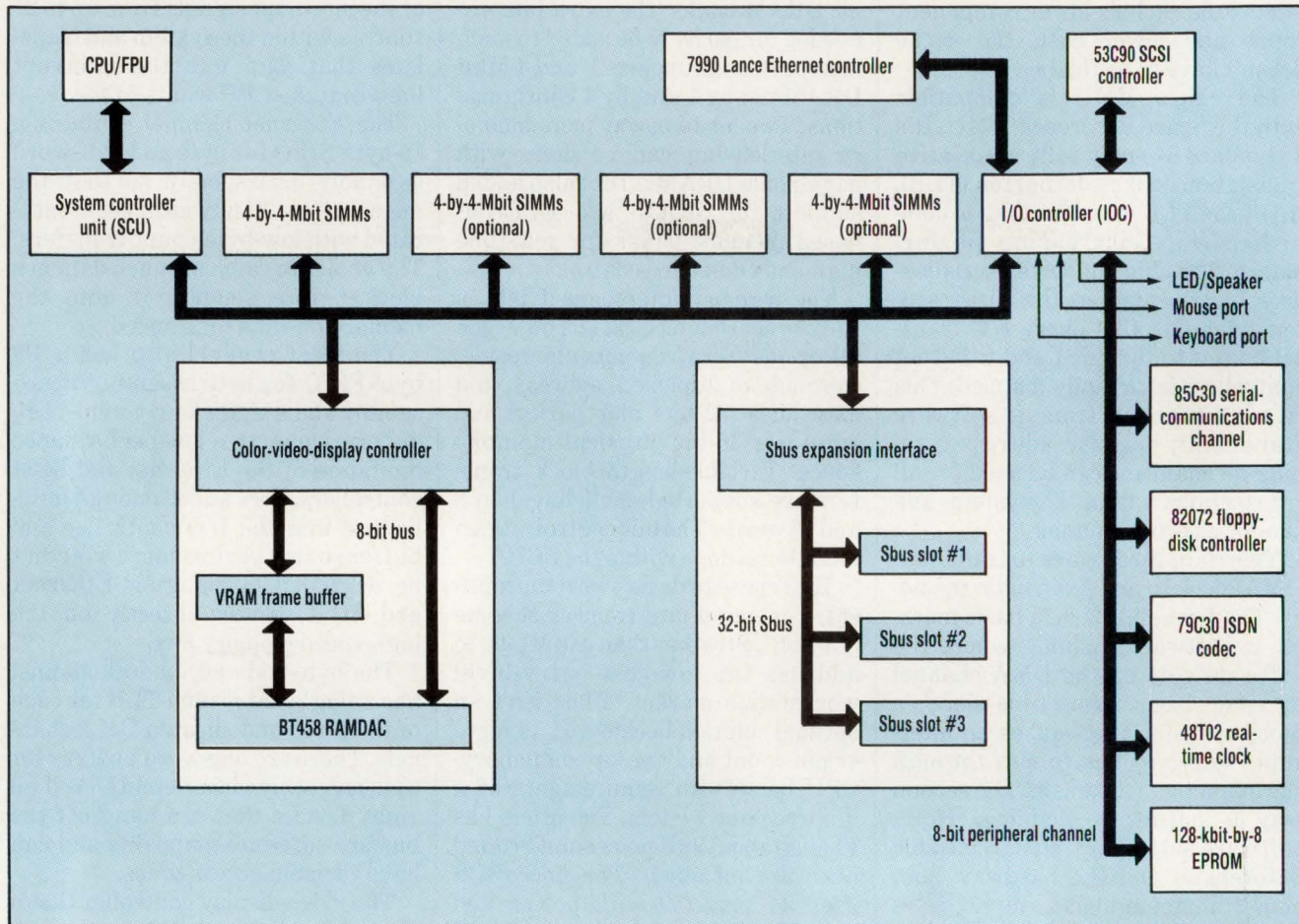

**2. BY ADDING TWO ADDITIONAL VLSI CHIPS** developed by Tera Microsystems, a RAMDAC, and some video RAM to the base system, the motherboard can be upgraded to a Sparcstation-2 configuration. Up to four Sbus slots can be included.

TM5630 Sbus Expansion Interface, users can obtain a Sparcstation-2 configuration (Fig. 2). The latter lets users add up to four Sbus slots. The former adds support for 8-bit color or gray-scale displays. The display controller needs just a RAMDAC and standard video RAM. No other glue logic is required. With this low-cost 160-pin PQFP, users can add color support right on the motherboard.

The Sbus controller chip implements the full Sbus Rev. B.0 specification. It allows asynchronous communication between the high-speed memory bus and the Sbus. Therefore, the Sbus can always run at 25 MHz, regardless of the system clock frequency. The IC contains an integrated interrupt controller and four unidirectional FIFOs, two 64-bytes deep, and two that hold 128 bytes (one of each type is for read opera-

tions and one is for write operations). The 64-byte FIFOs are dedicated to the microBUS interface and the 128-byte FIFOs to the Sbus interface. The buffers support 64- and 128-byte burst transfers on the microBUS and Sbus, respectively. The Sbus controller chip will be offered in a 208-pin PQFP and a 208-pin PPGA.

Tera's implementation of an SLC uses 19 chips. Sun's version takes 56 chips. This count includes a frame buffer but excludes DRAMs. Similarly, a Sun Sparcstation 1+ uses 63 chips, and a Tera-based equivalent model employs just 30. In the SLC, all 18 SRAMs and VRAMs are eliminated, the chip set is reduced from 8 chips to 2, and MSI logic goes from 20 to 9 packages. In the Sparcstation 1+, the chip set goes from 8 to 4, the SRAMs and VRAMs drop from 25 to 8, and MSI logic from 17 to 8.

## PRICE AND AVAILABILITY

The SCU and IOC chips will sample later this quarter with production to start in the fourth quarter. Both parts will be available in 208-pin QFPs. The IOC will also be housed in a 208-pin PPGA, and the SCU fits into a 224-pin ceramic or plastic PGA. Samples of the video-controller and Sbus-interface chips will be available in the fourth quarter. An entry-level 25-MHz chip-set configuration, suitable for laptop computers, will be priced at \$400 each in lots of 5000. The complete 33-MHz configuration, for implementing a Sparcstation-class machine, will be priced at \$745 each in 5000-unit lots.

Tera Microsystems Inc., 5200 Great America Pkwy., Suite 250, Santa Clara, CA 95054; Lisa Quinones, (408) 987-5600.

CIRCLE 511

## HOW VALUABLE?

HOW VALUABLE?	CIRCLE
HIGHLY	541
MODERATELY	542
SLIGHTLY	543

TEXAS INSTRUMENTS

A PERSPECTIVE ON DESIGN ISSUES:

# Breaking the analog barriers to optimum system design

IN THE ERA OF

# MegaChip

TECHNOLOGIES



# Advanced Linear extends the boundaries of system performance.

Innovative analog circuits from Texas Instruments add a new edge to Digital Equipment's proven market winners. They can do the same for you.



**T**he goal Digital Equipment Corporation set was clear: Strengthen its position as the leading supplier of Ethernet-based local area network products. Achieving the goal has been spurred by the use of Advanced Linear circuits from Texas Instruments.

These leadership ICs meet growing industry demand for linear circuits that can improve overall system performance and reliability, reduce costs and speed design cycles.

These were precisely the advantages Digital's designers needed.

## Expertise and teamwork carry the day

For many years, Digital has used a wide variety of TI linear circuits — from op amps to mixed-signal devices — and values our analog viewpoint toward system design.

As Digital defined the requirements to meet its market goal, the decades-long relationship entered a new era of even more intense cooperation. With Digital handling system-level design and TI applying its linear expertise, the two teams fully utilized our LinASIC™ design methodology to create a series of mixed-signal Ethercell™ functions. They are the basis for the advanced linear devices Digital requires.

The design flow was aided by our

Boston-area Regional Technology Center that provides access to LinASIC development tools and by the extensive use of EDIF to exchange information.

## Enhancing Digital's competitive edge

To date, close teamwork has produced components that can enhance Digital's ability to respond quickly to market demands for feature-rich but lower cost Ethernet and communications products:

- A dual driver and dual receiver IC that minimizes the number of components required for the Attachment Unit Interface (AUI) function in an Ethernet network.

“Utilizing TI’s LinASIC mixed-signal design methodology allows us to design cost-effective solutions with aggressive time-to-market goals.”

— Nick Ilyadis, Product Engineer  
Telecommunications and Networks Group  
Digital Equipment Corporation



- An octal receiver created to solve system-level cross-talk noise problems in RS-232, -485 and -423 applications. This full-custom device, fabricated in TI’s Advanced LinCMOS™ process, is designed to meet EIA and CCITT specs.
- A device that will be a complete AUI multiport concentrator on a chip. Fabricated in our LinBiCMOS™ process, it will replace a 6-inch by 12-inch circuit board that incorporates nine discrete ports, logic devices and analog circuitry. The new device will tie any combination of as many as eight units into Ethernet.

- A single-channel 10BASE-T twisted pair interface chip that includes internal precompensation and full duplex operation. Also fabricated in our LinBiCMOS process, this IC cuts component count and improves data transmission. The Ethercell devices developed by Digital and TI will be incorporated into our existing LinASIC cell library.

#### Extensive mixed-signal capabilities

As Digital recognizes, few in the industry can match our experience in analog design and digital design. This expertise enables us to effectively combine high-performance

analog functions with leadership digital functions. The resulting mixed-signal devices typify our capabilities to design and develop the Advanced Linear circuits our customers need.

#### Let us help you meet your challenge

We are ready to provide information and assistance, as well as access to the hardware and software development tools you need, to help extend the boundaries of your system performance.

Our service circles the globe, and our worldwide manufacturing capability can support your production schedules wherever you are.

# TI's analog viewpoint: From process technologies come Advanced Linear ICs.

## TI's LinASIC mixed-signal methodology —

A cell-based design methodology allowing the combination of high-performance analog and digital functions on the same chip. This mixed-signal capability is used for many of our catalog products and for custom/semicustom solutions. It is supported by large cell libraries, design-automation tools and these TI Advanced Linear wafer process technologies:

**LinBiCMOS** — Combines Advanced LinCMOS, digital ASIC CMOS and up to 30-V bipolar technologies to allow the integration of digital and analog standard cells and handcrafted analog components on a monolithic chip.

**LinEPIC™** — One-micron CMOS double-level metal, double-level polysilicon technology that adds highly integrated, high-speed analog to the high-performance digital EPIC™ process.

**Advanced LinCMOS** — An N-well, silicon-gate, double-level polysilicon process featuring improved resistor and capacitor structures and having three-micron minimum feature sizes.

**Power BIFET™** — Merges standard linear bipolar, CMOS and DMOS processes and allows integration of digital control circuitry and high-power outputs on one chip. Primarily used for circuits handling more than 100 V at currents up to 10 A.

**Multi-EPI Bipolar** — A very cost-effective technology that utilizes multiple epitaxial layers instead of multiple diffusion steps to reduce mask steps by more than 30%. Used to produce intelligent power devices that can handle loads as high as 20 A and voltages in excess of 100 V.

**Excalibur** — A true, single-level poly, single-level metal, junction-isolated, complementary bipolar process developed for high-speed, high-precision analog circuits providing stable op amp performance.

For more information on our Advanced Linear process technologies and the products they are producing, call 1-800-336-5236, ext. 3425.

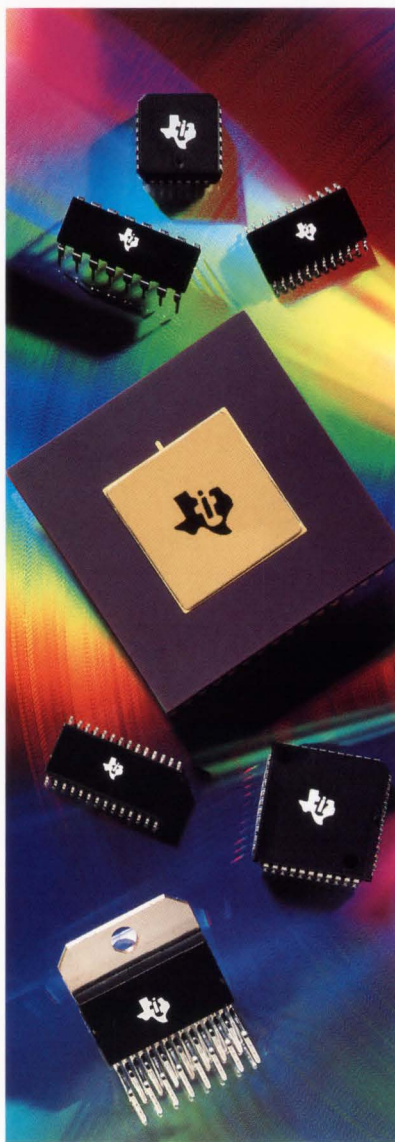

## TI's LinASIC methodology and Advanced Linear process technologies are enhancing these product families

**Data Transmission** — This family meets the needs of most industry-standard interfaces (EIA, IEEE, ANSI) and ranges from drivers/receivers/transceivers to fully integrated controller/transceivers.

**Data Acquisition** — The family ranges from stand-alone A/Ds and D/As to complete data conversion subsystems on a chip; from general-purpose functions to highly integrated digital signal processor and graphics signal processor analog interface circuits. Other specialized family members include telecom and speech synthesis functions.

**Intelligent Power** — These devices combine high-voltage and/or high-current switches with the analog and digital circuitry required to perform interface, control, protection and diagnostic functions in microcontroller-based systems.

**Operational Amplifiers** — A family of op amps and comparators ranging from standard bipolar to leadership high-performance CMOS and Excalibur complementary-bipolar devices, meeting needs ranging from low power and/or low noise to high speed and/or high precision.

**Custom/semicustom Functions** — In modifying existing products to fit your needs or in defining your own unique functions, our LinASIC methodology allows access to existing analog cells used in the development of our catalog products and compatibility with our digital cell libraries.

# Put Our List On Your List

Our list can help you do the other things you have on your list. Such as buy a car. . . estimate social security. . . start the diet. . . check out investments. . .

Our list is the *Consumer Information Catalog*. It's free and lists more than 200 free and low-cost government booklets on employment, health, safety, nutrition, housing, Federal benefits, and lots of ways you can save money.

So to shorten your list, send for the free *Consumer Information Catalog*. It's the thing to do.

Just send us your name and address. Write:

**Consumer Information Center  
Department LL  
Pueblo, Colorado 81009**



A public service of this publication  
and the Consumer Information Center  
of the U.S. General Services Administration

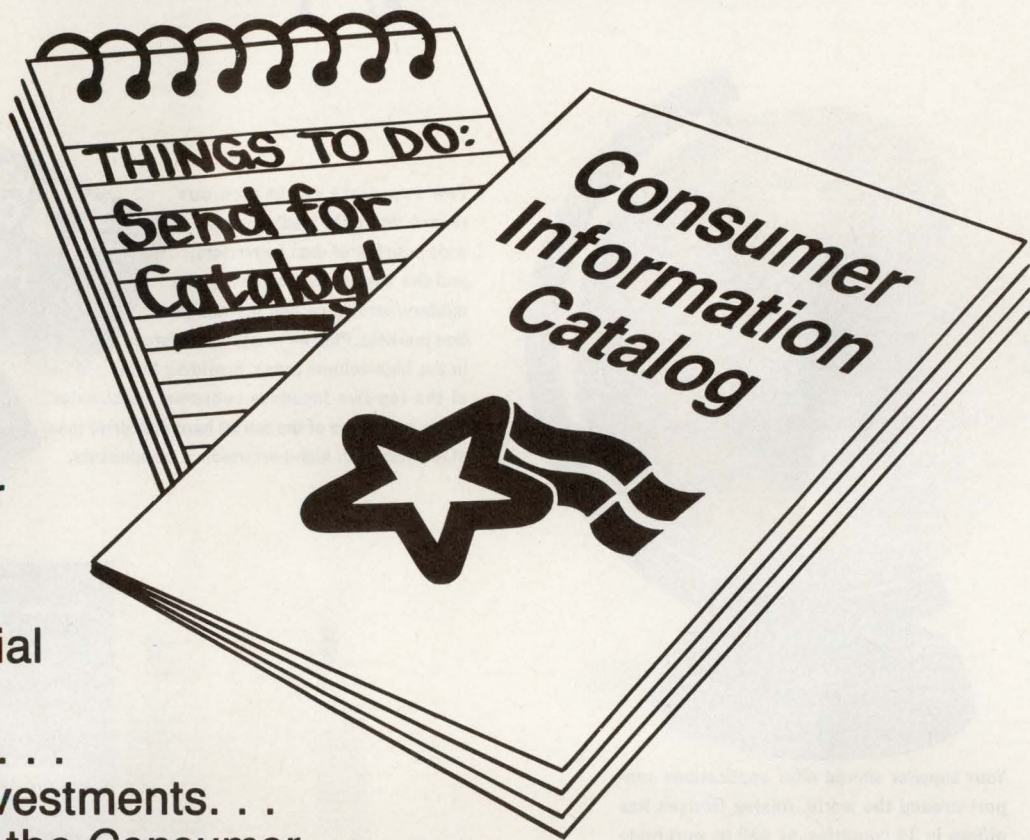

# When you're looking for a sure they provide these



**Your supplier should offer applications support around the world. Analog Devices has offices in 34 countries, as well as worldwide manufacturing and stocking facilities.**

**Does your supplier have 25 years of signal processing expertise? Analog Devices does, and you can tap into it by simply picking up the phone. And with our recent acquisition of PMI—a leader in precision op amps and Class S mil/aerospace applications—you have even more experience to call upon.**

**Few suppliers can match our record. We're the leading worldwide supplier of data converters, and the top analog supplier to the military/aerospace and instrumentation markets. Plus we're a growing force in the high-volume arena, providing three of the top five Japanese consumer electronics firms, and seven of the top 10 hard disk drive manufacturers with high-performance components.**

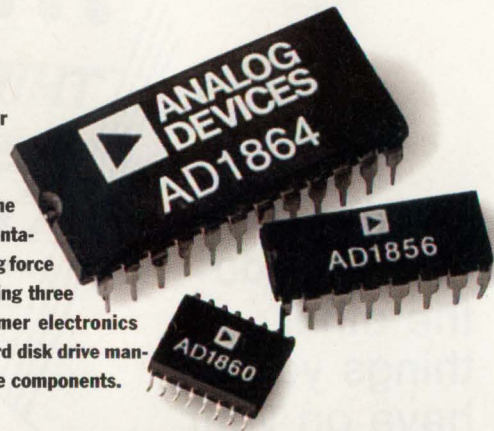

With Analog Devices, you get direct access to the most knowledgeable applications engineers in real-world signal processing.

You get the design tools—macromodels, evaluation boards, on-line support, technical seminars and application notes, among other things—necessary to get your products up and running quickly.

And you get 25 years of design expertise—expertise evidenced by the most complete line of high-performance linear, DSP and mixed-signal components. ICs made possible by one of the broadest manufacturing process portfolios,



# mixed-signal supplier, make high-performance parts.

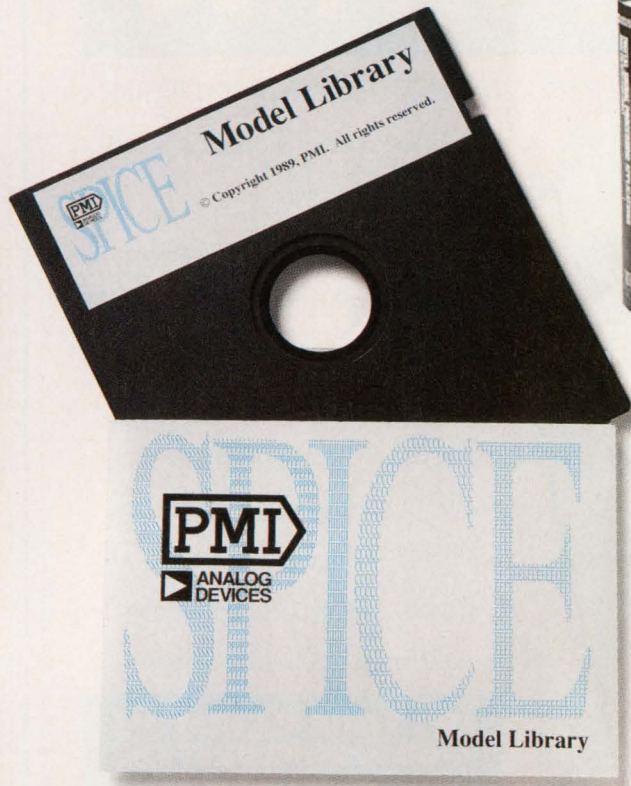

A good supplier works to save you time and money. One way we do it is by providing state-of-the-art macromodel design tools that let you quickly and easily simulate the performance of many of our op amps. We also offer you evaluation boards for our data converters, and complete design kits for our DSP processors.

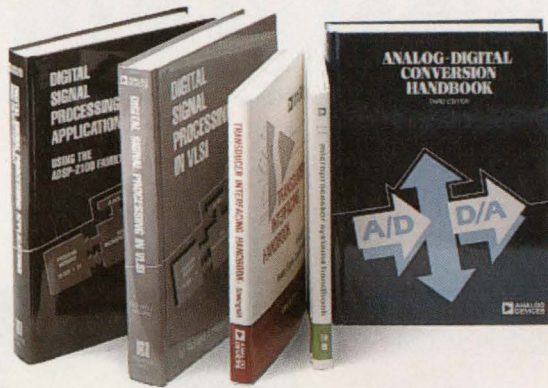

A good supplier also helps you do your job better. That's why we publish more newsletters, technical books, application notes and seminar handbooks filled with the latest information on linear, DSP and mixed-signal technology.



Do you get the service of a small company backed by the resources of a large one? If your supplier is Analog Devices, you do. Analog and digital experts work together to solve your problems. And top management takes a hands-on approach to customer support.

which includes leading edge BiCMOS, Flash, Complementary Bipolar and many others.

As a \$540 million operation, we have the resources that help you achieve top performance from our ICs.

Performance that translates into higher levels of system integration, greater reliability and a better end product.

Whatever high-performance part you're looking for, we are the one company that can deliver it.

Call us at 1-800-262-5643 for a free copy of our recent booklet on

Mixed-Signal Technology.



Analog Devices, Inc., One Technology Way, P.O. Box 9106, Norwood, MA 02062-9106. Headquarters: (617) 329-4700. Offices and applications support available worldwide.

CIRCLE 264 FOR U.S. RESPONSE

CIRCLE 265 FOR RESPONSE OUTSIDE THE U.S.

# EXPANSION OF RISC WORKSTATIONS IS NOW ENTIRELY IN YOUR HANDS.

Ever wonder how to get into RISC without worrying about obsolescence? Digital's new, ACE-compatible DECstation™ 5000/100 Series has the answer: an upgradeable 3" x 5" CPU card. That's right. Our revolutionary "daughter" card is the only thing you need to change to get higher CPU performance. You can get cards to upgrade your graphics and I/O performance as well.

This upgradeability means two things. You can buy now at a comfortable mid-price, mid-performance level. And your investment in the DECstation 5000/100 Series lasts longer because we're always developing better cards.

The DECstation 5000/100 Series is ideal for running electronic design automation applications, like the popular Amadeus™, Analog Artist™, Opus™, ValidGED™, ValidTIME™,



Analog/Workbench II™, RAPIDSIM™, Allegro Compose™, Workview Series II™, and Scicards®.

So get into RISC without the risk. Call 1-800-343-4040 ext. 912 for more information (and a special discount offer on some terrific software packages.) To become a Digital reseller or applications provider, call 1-800-343-4040, ext. PARTNER. Call soon. And get your hands on the DECstation 5000/100 Series.

## GET YOUR HANDS ON A 40% DISCOUNT ON 20-20 OR WINGZ.

For a limited time, you can get a 40% discount on Access Technology's 20/20™ or WINGZ™ from Informix. Just give us a call, at 1-800-343-4040, ext. 912. We'll link you up with one of these software vendors for 40% off the purchase price.

ADVANCED COMPUTING ENVIRONMENT

© Digital Equipment Corporation 1991. The DIGITAL logo and DECstation are trademarks of Digital Equipment Corporation. Amadeus, Analog Artist and Opus are trademarks of Cadence Design Systems, Inc. ValidGED, ValidTIME, Analog/Workbench II, RAPIDSIM, Allegro Compose are trademarks of Valid Logic Systems, Inc. Workview Series II is a trademark of Viewlogic. Scicards is a registered trademark of Harris/Scientific Calculation, Inc. 20/20 is a trademark of Access Technology, Inc. WINGZ is a trademark of Informix Software, Inc.

**digital**™

# DIGITAL. THE OPEN ADVANTAGE.

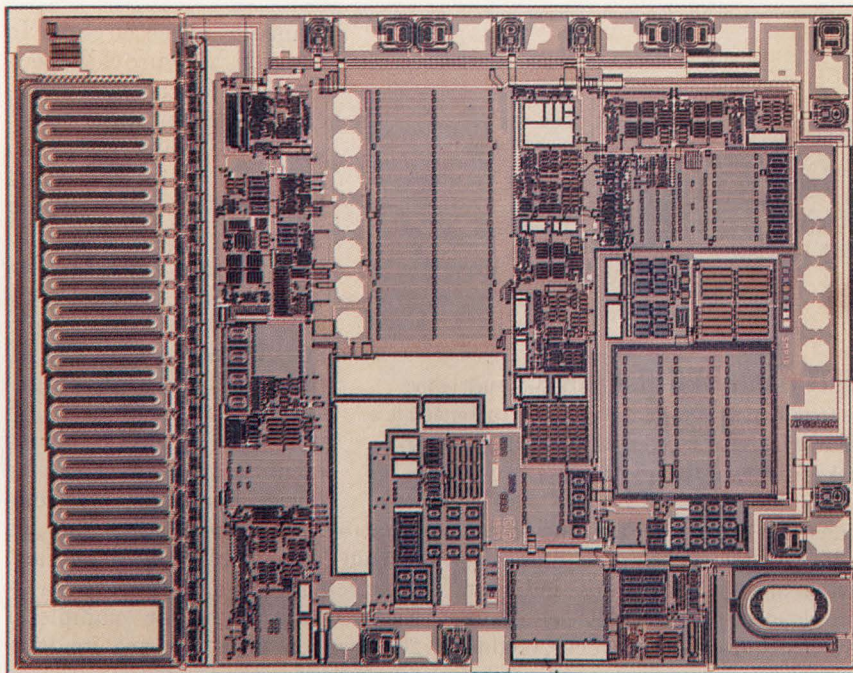

SOURCE: POWER INTEGRATIONS

FRANK GOODENOUGH

## SWITCH-MODE REGULATOR ICs, WITH CONTROLLER AND POWER SWITCH ON ONE DIE MOVE TO VOLUME JOBS.

both a switching-regulator controller and a power switch—are becoming so easy to apply that many non-specialists have used them successfully. While originally aimed at narrow niches, SRICs can now be found in volume (and thus at low cost) in a host of consumer, automotive, and telecommunications applications.

There are three broad, overlapping classes of switching-regulator ICs (and the power supplies built from them)—general purpose, low-power/low-voltage, and high-voltage/off-line types. The first handles currents of one or more amperes and voltages to 70 V; the second handles voltages as low as 1 V and currents to a few hundred milliamperes. Voltages above 70 V and currents to several hundred milliamperes (at present) represent the venue of the third class. The first and third classes can be considered power ICs, or PICs. The third class also falls into the high-voltage IC, or HVIC, category. Several of the low-power devices in the second class might also be called PICs. But the acronym SRIC blankets all three classes. Charge pumps (not the subject of this report) represent a fourth class of dc-dc converter IC. However, they don't provide regulation.

Trade-offs governing the use of these regulator ICs is critical to the application. At high voltage and power levels, it's almost always cheaper to go with a controller IC and a discrete power switch. For a new design, a power MOSFET is probably the technology of choice. Moreover, final performance is usually equal or superior to that possible from the SRIC. On the other hand, SRICs, like all ICs with higher integration levels, reduce the cost of purchasing, inspecting, testing, stocking, and assembling at least one, and often several parts. But more important, they save space and simplify the design job for novice and expert alike.

### TRADE OFFS

SRIC design aids range from voluminous application

# DESIGNING SWITCHERS GETS EASIER

**W**hen the topic of switching regulators, or regulated-output dc-dc converters, comes up, digital designers run for the hills. Even top analog-circuit designers don't find much comfort with them, as currents switch in and out of inductors rapidly. Now, however, several factors are driving digital-system engineers to try their hand at designing them. They include the need for smaller PCs; using distributed power in large systems; the coming of age of battery-powered, portable products; shorter time-to-market spans; and a shortage of skilled switching-power-supply designers. Another key factor is the availability of design aids. These include PC software for analog-circuit design, as well as a vast array of application notes and IC evaluation kits.

Switching-regulator ICs (SRICs)—chips containing

## SWITCHING-REGULATOR ICs

notes to detailed cookbook designs calling out specific inductors, capacitors, and rectifier diodes by manufacturers' model numbers. National Semiconductor provides an expert system on a floppy disk to assist the designer. Most suppliers provide a pc-board layout and a parts list for a basic supply made with each IC, having already built working supplies that were tested and debugged. Many SRIC suppliers also provide an evaluation kit with the chip, the board, and usually all of the parts needed for a breadboard. And the price is most always attractive (some suppliers even include a heat sink).

For example, a designer can purchase a production kit containing the critical parts (low-loss inductors, low-ESR capacitors, and Schottky rectifiers) to go along with a SRIC for about one-third the cost of competitive potted modules. He can then put the layout right on his pc board.

When it comes to the low-power/low-voltage regulators, the situation changes. In most cases, the IC isn't just one of several ways to get the required performance—it's the only way. It's also lower in cost. Only a special-purpose SRIC can optimize the performance for the application and for low power (for instance, the ability to convert the output of a 1.1-V battery to 5 V).

High-voltage converters, ideally able to work off domestic and international ac lines, are the newest and smallest class of SRICs. While several represent advanced semiconductor-process technology, they're still relatively low-power devices. These inexpensive converters, however, save significant space and design time. But their use must be weighed against safety and regulatory-agency (UL, VDE) rules.

For most SRIC applications, efficiency, beyond the basic voltage and current ratings, represents the most important specification. Efficiency (regulated power out divided by power in), is a function of the application, the circuit, other components be-

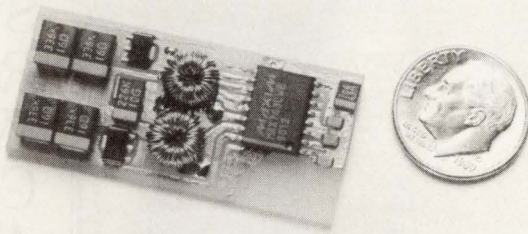

**1. SWITCHING-REGULATOR ICs**, such as the MAX743 from Maxim, let you cram a 3-W dc-dc converter into a pc-board area 1/3 in.<sup>3</sup>. The device is housed in the wide-body SOIC package located in the upper right.

sides the regulator, and the chip itself. Trade-offs can be made between high-priced low-loss inductors and less expensive devices. Using low-loss inductors, however, enables high-voltage circuits to run more efficiently. This is because conduction losses in the power switch and the rectifiers represent a lower percentage of the total power controlled. Efficiency in such supplies typically runs between 75% and 95%.

The importance of efficiency peaks at maximum and minimum power use, but for very different reasons. Low-power systems running off batteries demand superior efficiency to maximize battery life and minimize size. In fact, Linear Technology (LTC), Maxim, and others offer alternative designs optimized for maximum efficiency or maximum power for many low-power chips. In high-power applications where significant power is dissipated by the power supply, efficiency must be high to cram maximum power control into a minimum-size package. The lower the converter losses, the greater the controlled power in a given volume.

Ordinarily, when you think of regulators, initial accuracy and line and load regulation come to mind. However, with most SRICs, these parameters depend on other circuit components, as is the case with efficiency. Rather than providing these specifications, suppliers offer circuits with component values (for inductors they also call out suppliers and model numbers) and give the perfor-

mance of those circuits. In addition, they provide specifications for the various circuit blocks within the chip that determine accuracy and regulation. These range from reference accuracy and temperature coefficient, to oscillator-frequency accuracy and error-amplifier gain and offset voltage. However, virtually all of the available SRICs are specified to hold their output well within  $\pm 10\%$  of nominal value over the ac power line, load, and tem-

perature if the other components are chosen correctly. If they're not, and the circuit is not breadboarded, a disaster could result. For example, if 20% carbon resistors are inadvertently used in the feedback path, the best regulator in the world can't provide accuracy within 2%.

A few words of caution are in order here. Don't use SRICs without first looking at what's waiting for you. Pore over all of the software (data sheets, application notes) that comes with the chip. Remember that you're adding fast-rising, high-voltage, high-current pulses to your pc boards that potentially contain sensitive digital and/or analog circuits. You may need additional filtering on input and/or output lines, as well as electrostatic and maybe even magnetic shielding around the converters. And, as noted, if you're working off-line, there are other considerations. One major consideration is your own safety, as well as the safety of your test equipment, when checking out circuits containing lethal voltages. For instance, what if a screwdriver accidentally connects the ac line to your 5-V bus?

Another down side also appears as you start to look closely at SRICs. For all practical purposes, there are no standard parts or second sources (though this is starting to change, as will be noted later). On the other hand, if you decide to use a controller with a power MOSFET, multiple sources are available. And the few suppliers that are around simplifies the selection process. For example,

# HI-SIDE POWER SWITCHING EXTENDS BATTERY LIFE

## MAX621 Drives Four Low-Cost 15A/0.1Ω N-MOSFETs From +5V

Extend battery life in PC and hand-held designs with Maxim's new MAX620 family of high-side power switches, MOSFET drivers and power supplies. These devices simplify load switching in battery-powered systems by replacing up to 12 components with a single device. Save money, board space and design time.

The MAX620/MAX621 allow logic signals to drive low-cost N-channel power MOSFETs connected between the positive supply and high-current loads—on the "high side." The required 10V gate-source voltage is generated by an on-chip charge pump. High-side switching eliminates expensive P-channel MOSFETs, separate power supplies, bulky inductors and mechanical relays.

The MAX622/MAX623 are stand-alone regulated high-side charge pumps for designs requiring flexibility in driver count and type. The MAX625 contains four internal 1A/0.2Ω switches and all capacitors—a complete solution in 0.3 square inches of board space!

- ◆ Save Space, Design Time, and \$15\*
- ◆ Wide Supply Voltage Range +3.5V to +16.5V
- ◆ Output Voltage Regulated to Vcc plus 11V
- ◆ Minimal Component Count
- ◆ Quad Latched Logic-Level Inputs
- ◆ 70μA Quiescent Current
- ◆ Power-Ready Output Protection

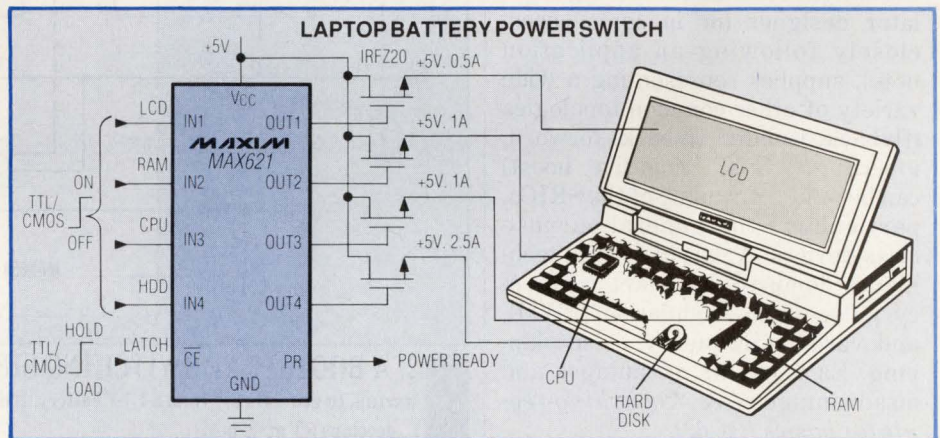

Logic-level signals independently control four high-current MOSFET switches.

### MAX620 FAMILY OF HIGH-SIDE SWITCHES, DRIVERS, AND POWER SUPPLIES

	MAX620	MAX621	MAX622	MAX623	MAX625
<b>Function</b>	4 Drivers	4 Drivers	Power Supply	Power Supply	4 Switches
<b>Internal Power Supply</b>	YES	YES	YES	YES	YES
<b>Internal FET Drivers</b>	4	4	External	External	4
<b>Internal FET Switches</b>	External	External	External	External	4x1.0A/0.2Ω
<b>External Capacitors</b>	3	0	3	0	0
<b># Pins/Package</b>	18/DIP, SO	18/DIP	8/DIP, SO	16/DIP	18/DIP
<b>Price (1000-up)†</b>	\$3.91	\$5.82	\$1.99	\$3.95	Available 9/91

\* Savings based on cost difference between using IRFZ20 NMOSFETs and MAX620 versus using equivalent IRF9Z32 PMOSFETs, 1000-up.

**POWER SUPPLIES ANALOG DESIGN GUIDE**

◆ 4 Applications Notes ◆ Five Samples

**+5V To +15V DC-DC Converter Delivers 30W**  
No Design Required—Just Drop It In

**Evaluation Kit Simplifies Prototyping**  
Start your design with a complete evaluation kit that includes the MAX620, MAX621, MAX622, MAX623, MAX625, and all the components you need to get started.

**Production Kit Saves Placement and Increases Reliability**  
The production kit is a complete solution for your design. It includes the MAX620, MAX621, MAX622, MAX623, MAX625, and all the components you need to get started.

**ANALOG**

1. Buck Converter  
2. Boost Converter  
3. Inverting Amplifier  
4. Non-Inverting Amplifier  
5. Op Amp  
6. Schmitt Trigger  
7. Voltage Divider  
8. Voltage Follower

MAXIM

## FREE Power Supply Design Guide

Includes: Application Notes ◆ Data Sheets ◆ Cards For Free Samples

Simply circle the reader response number, contact your Maxim representative or Maxim Integrated Products, 120 San Gabriel Drive, Sunnyvale, CA 94086, (408) 737-7600, FAX (408) 737-7194.



Distributed by Arrow, Bell/Graham, Elmo, Hall-Mark, Nu Horizons, Pioneer, and Wyle. Authorized Maxim Representatives: Alabama, (205) 830-0498; Arizona, (602) 730-8093; California, (408) 248-5300, (619) 278-8021, (714) 261-2123; (818) 704-1655; Connecticut, (203) 384-1112; Delaware, (609) 778-5353; Florida, (305) 426-4601, (407) 830-8444; Georgia, (404) 447-6124; Idaho, (503) 292-8840; Illinois, (708) 358-6622; Indiana, (317) 844-8462; Iowa, (319) 393-2232; Kansas, (816) 436-6445; Louisiana, (214) 238-7500; Maryland, (301) 644-5700; Massachusetts, (617) 329-3454; Michigan, (313) 583-1500; Mississippi, (205) 830-0498; Missouri, (314) 839-0033, (816) 436-6445; Montana, (503) 292-8840; Nebraska, (816) 436-6445; Nevada, (408) 248-5300; New Hampshire, (617) 329-3454; New Jersey, (201) 428-0600, (609) 778-5353; New Mexico, (602) 730-8093; New York, (201) 428-0600, (607) 754-2171; N. Carolina, (919) 851-0010; Ohio, (216) 659-9224, (513) 278-0714, (614) 895-1447; Oklahoma, (214) 238-7500; Oregon, (503) 292-8840; E. Pennsylvania, (609) 778-5353; W. Pennsylvania, (614) 895-1447; S. Carolina, (919) 851-0010; Tennessee, (404) 447-6124; Texas, (214) 238-7500, (512) 835-5822, (713) 789-2426; Utah, (801) 561-5099; Virginia, (301) 644-5700; Washington, (206) 823-9535; W. Virginia, (513) 278-0714; Canada, (416) 238-0366, (613) 225-5161, (604) 276-8735, (514) 337-7540.

† 1000-up FOB USA, suggested resale

Maxim is a registered trademark of Maxim Integrated Products. © 1991 Maxim Integrated Products.

CIRCLE 290 FOR U.S. RESPONSE

CIRCLE 291 FOR RESPONSE OUTSIDE THE U.S.

## SWITCHING-REGULATOR ICs

only about a dozen device families, from just six suppliers, complete the general-purpose class of SRICs (Table 1). The other two classes have even fewer devices and suppliers.

Most available SRICs are designed for operation in either a buck or boost topology using an inductor rather than a transformer. The former are designed to convert a higher voltage to a lower one (for example +15 V to +5 V), the latter to convert a low voltage to a higher one (for example +5 V to +12 V). However, in the hands of a skilled switching regulator designer (or in some cases, closely following an application note), supplies representing a wide variety of other common topologies (flyback, isolated flyback, forward, inverting, "Cuk," negative boost) can be built from many of the SRICs, particularly the general-purpose class devices. A pair of control techniques dominate: constant frequency pulse-width modulation (PWM), and variable-frequency pulse skipping. Each has its advantages and disadvantages (see "Switching-regulator basics," p. 62).

Presently, the most-widely used SRICs fall in the general-purpose class, with practical power capability ranging from about 1 to 100 W. These SRICs are finding their way into everything from laptop PCs to automobiles, and from medical instruments to appliances. In all of these applications, someone realizes that a power supply is needed after the system or product is completely designed (both circuit and package). Moreover, not only must the supply be stuffed into zero space, but it must dissipate zero power and be ready to drop into the system last week. And many times it becomes a case of "let Joe design it. He's just out of school and knows all that theoretical stuff about power-switching circuits, inductors, and  $Ldi/dt$ ."

It's no wonder that novice and expert designers alike are turning to SRICs. Say you have plenty of +5-V power and need 100 mA of  $\pm 15$  V (or 125 mA of  $\pm 12$  V) to go into a space about 1 by 3 by 0.7 in. You can employ, for example, Maxim's MAX743. Just lay out your board from their

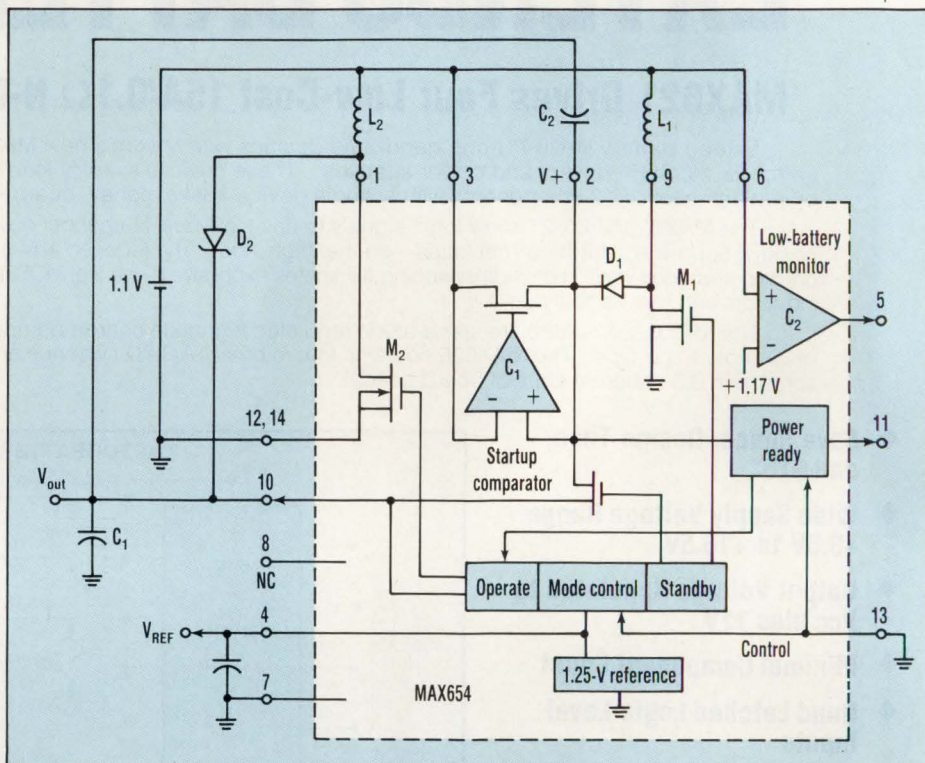

**2. A BOOTSTRAP SWITCHING CIRCUIT** uses FET  $M_1$  and inductor  $L_1$ , at startup, to generate 8 V from a 1.1-V battery. It drives the gate of power FET  $M_2$ , with which  $L_2$  develops 5 V at 40 mA.

data sheet (the layout is critical for minimum noise), purchase their production kit (which employs through-hole parts) plus a handful of additional passive parts (typically less than 50 cents total in similar quantities), and you're ready to go. Their complete evaluation kit, at \$20 each, can often serve in your prototype. If that much space isn't available, a surface-mounted MAX743 with layout and parts list is available. Critical parts can be obtained from Maxim. It puts the supply into a volume of just 1.75 by 0.75 by 0.25 in., for a power density of 9 W/in.<sup>3</sup> (Fig. 1). Efficiency is also higher, 83% versus 79%.

In its 16-pin DIP or SOIC, The MAX743 contains two, complete, current-mode PWM circuits. Its output voltage is set at 12 or 15 V by holding pin 11 high or low, respectively (hardwired or with logic). A single oscillator drives both circuits. Like all Maxim SRICs, and virtually no others, this one is in CMOS. Self-protection features include current limiting, thermal shutdown, and soft

start. While putting out  $\pm 15$  V, line regulation runs  $\pm 0.5\%$  maximum for a  $\pm 10\%$  input-voltage change (4.5 V to 5.5 V), load regulation runs 1% maximum over a 0-to-100-mA load.

## PEOPLE POWER

Some circuit tricks will let the MAX743 provide higher and lower voltages, but that's not its job. Besides, output power is limited. If much design help is still required and/or a design needed by last week is vital, plus more power and input- and output-voltage flexibility is required, you might turn to National's simple switchers (Table 1, again). National provides a detailed data sheet with equations, cookbook circuits, and charts calling out component values (and inductor suppliers). An expert system called "Switchers Made Simple" comes on a floppy disk for use on PCs. Not only is the system simple to use, it also halts when an illegal or impossible-performance capability is asked for by the user, pointing out the possible problems in

# 10MHz MICROPPOWER OP AMPS— 40V/ $\mu$ s FROM 375 $\mu$ A

No other op amps match the new MAX402 and MAX403's combination of high speed and micropower operation. At only 375 $\mu$ A supply current, the 10MHz MAX403 slews at 40V/ $\mu$ s—14 times faster than the industry standard OP27 at less than 1/10th the supply current. For applications requiring even lower power, the MAX402 has a 2MHz bandwidth and 7V/ $\mu$ s slew rate while drawing less than 75 $\mu$ A supply current. The MAX402 and MAX403 are both unity gain stable. They operate from  $\pm$ 3V to  $\pm$ 5V supplies, or a single supply from 6V to 10V, making them ideal for low power signal processing and remote sensors.

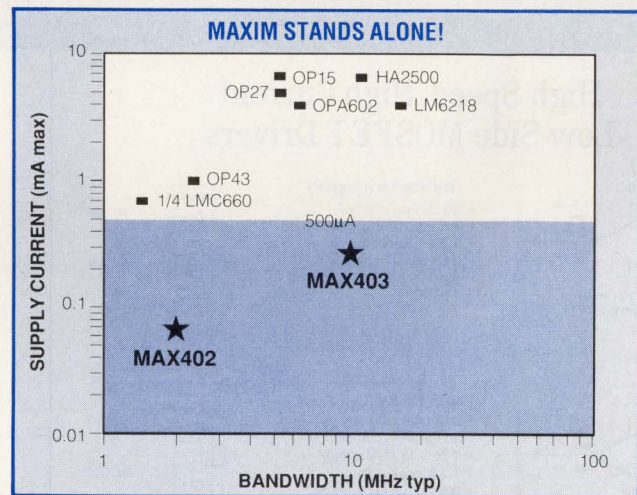

Best speed and power combination: 2MHz at 75 $\mu$ A (MAX402) or 10MHz at 375 $\mu$ A (MAX403)

## Choose the Best Speed/Power Combination

	MAX402	MAX403
Unity-Gain Bandwidth	2MHz	10MHz
Slew Rate	7V/ $\mu$ s	40V/ $\mu$ s
Supply Current (max)	75 $\mu$ A	375 $\mu$ A
V <sub>OS</sub> (max)	2mV	2mV
I <sub>B</sub> (max)	5nA	25nA
CMRR (min)	75dB	60dB
AVOL	75dB	80dB

## FREE Op Amp Design Guide

Includes: ♦ Application Notes ♦ Data Sheets ♦ Cards For Free Samples

Simply circle the reader response number, contact your Maxim representative or Maxim Integrated Products, 120 San Gabriel Drive, Sunnyvale, CA 94086, (408) 737-7600, FAX (408) 737-7194.

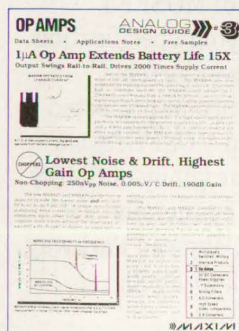

Distributed by Arrow, Bell/Graham, Elmo, Hall-Mark, Nu Horizons, Pioneer, and Wyle. Authorized Maxim Representatives: Alabama, (205) 830-0498; Arizona, (602) 730-8093; California, (408) 248-5300, (619) 278-8021, (714) 261-2123; (818) 704-1655; Colorado, (303) 799-3435; Connecticut, (203) 384-1112; Delaware, (609) 778-5353; Florida, (305) 426-4601, (407) 830-8444; Georgia, (404) 447-6124; Idaho, (503) 292-8840; Illinois, (708) 358-6622; Indiana, (317) 844-8462; Iowa, (319) 393-2232; Kansas, (816) 436-6445; Louisiana, (214) 238-7500; Maryland, (301) 644-5700; Massachusetts, (617) 329-3454; Michigan, (313) 583-1500; Minnesota, (612) 944-8545; Mississippi, (205) 830-0498; Missouri, (314) 839-0033, (816) 436-6445; Montana, (503) 292-8840; Nebraska, (816) 436-6445; Nevada, (408) 248-5300; New Hampshire, (617) 329-3454; New Jersey, (201) 428-0600, (609) 778-5353; New Mexico, (602) 730-8093; New York, (201) 428-0600, (607) 754-2171; N. Carolina, (919) 851-0010; Ohio, (216) 659-9224, (513) 278-0714, (614) 895-1447; Oklahoma, (214) 238-7500; Oregon, (503) 292-8840; E. Pennsylvania, (609) 778-5353; W. Pennsylvania, (614) 895-1447; S. Carolina, (919) 851-0010; Tennessee, (404) 447-6124; Texas, (214) 238-7500, (512) 835-5822, (713) 789-2426; Utah, (801) 561-5099; Virginia, (301) 644-5700; Washington, (206) 823-9535; W. Virginia, (513) 278-0714; Canada, (416) 238-0366, (613) 225-5161, (604) 276-8735, (514) 337-7540.

Maxim is a registered trademark of Maxim Integrated Products. © 1991 Maxim Integrated Products.

CIRCLE 292 FOR U.S. RESPONSE

CIRCLE 293 FOR RESPONSE OUTSIDE THE U.S.

# Now, one family drives all FETs.

## High Speed, High Current Low Side MOSFET Drivers

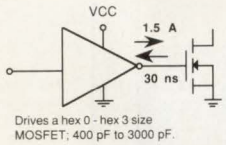

Drives a hex 0 - hex 3 size MOSFET; 400 pF to 3000 pF.

### MIC426/7/8 (Original)

- 30 nS into 1000 pF
- 4.5 V to 18 V supply
- 1.5 A peak output
- 6  $\Omega$  output impedance
- Available in surface mount packages

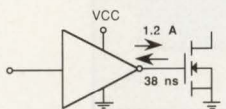
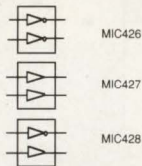

Drives a hex 0 - hex 3 size MOSFET; 400 pF to 3000 pF.

### MIC1426/7/8 (Low Cost)

- Low cost predriver
- 38 nS into 1000 pF
- 4.75 V to 16 V supply
- 1.2 A peak output
- 8  $\Omega$  output impedance
- Available in surface mount packages

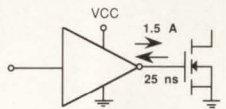
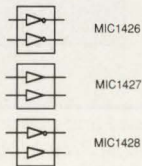

Drives a hex 0 - hex 3 size MOSFET; 400 pF to 3000 pF.

### MIC4426/7/8 (Protected)

- Latch-up protected
- 25 nS into 1000 pF
- 4.5 V to 18 V supply
- 1.5 A peak output
- 7  $\Omega$  output impedance
- Withstands 5 V negative swing
- Available in surface mount and high temperature packages

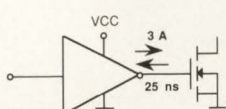
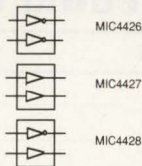

Drives a hex 4 - hex 5 size MOSFET; 6000 pF to 12000 pF.

### MIC4423/4/5 (High Current)

- Latch-up protected
- 25 nS into 1800 pF
- 4.5 V to 18 V supply
- 3 A peak output
- 3.5  $\Omega$  output impedance
- Withstands 5 V negative swing
- Available in surface mount packages

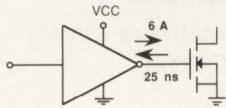
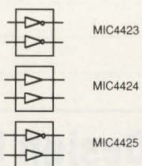

Drives a hex 6 - hex 7 size MOSFET; 15000 pF to 16000 pF

### MIC4420/4429 (Singles)

- Latch-up protected
- 25 nS into 10,000 pF
- 4.5 V to 18 V supply
- 6 A peak output
- 2.5  $\Omega$  output impedance
- Withstands 5 V negative swing
- Available in surface mount packages

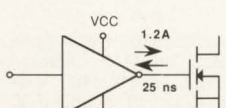
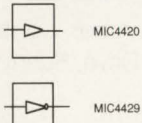

Drives a hex 0 - hex 3 size MOSFET; 400 pF to 3000 pF

### MIC4465/6/7/8/9 (Quad)

- Latch-up protected
- 25 nS into 470 pF
- 4.5 V to 18 V supply
- 1.2 A peak output
- Available in surface mount packages
- Five logic choices

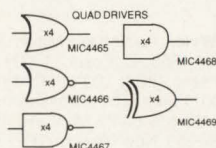

## High Side, Protected MOSFET Drivers

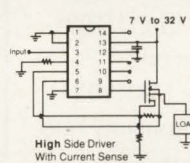

High Side Driver With Current Sense

### MIC5010

- Full Featured predriver
- Optional speed up caps
- 7 V to 32 V supply
- Internal charge pump
- 60  $\mu$ S into 1 nF
- Over current sensing
- Fault flag output
- Surface mount packages
- Dynamic sensing threshold

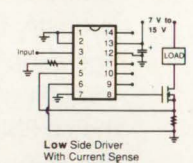

Low Side Driver With Current Sense

### MIC5011

- Minimum parts count
- Optional speed up caps
- 4.75 V to 32 V supply
- Internal charge pump
- 60  $\mu$ S into 1 nF
- Surface mount packages

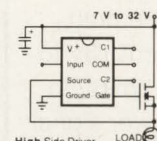

High Side Driver

### MIC5012

- Dual predriver
- Provides high and low side
- 4.75 V to 32 V supply
- Internal charge pump
- 60  $\mu$ S into 1 nF
- Surface mount packages

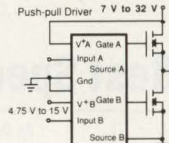

Push-pull Driver 7 V to 32 V

### MIC5013

- Over current sensing
- 7 V to 32 V supply
- Fault flag output
- Internal charge pump
- 60  $\mu$ S into 1 nF
- Surface mount packages
- Dynamic sensing threshold

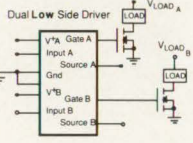

Dual Low Side Driver

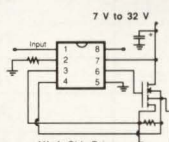

High Side Driver With Current Sense

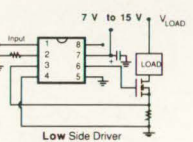

Low Side Driver With Current Sense

Choose from the widest selection of MOSFET predrivers in the industry. Whether your specification requires ultrafast low side driving, overcurrent protected high side driving, or overcurrent protected low side driving of 1 Amp to 100 Amp MOSFETs, we can supply the right product from our family of CMOS drivers to reliably meet your needs. For details contact: Micrel Semiconductor, 560 Oakmead Parkway, Sunnyvale, CA 94086. Or call (408) 245-2500.

**MICREL**  
SEMICONDUCTOR

*The Intelligent Power Company™*



To place **orders** or receive a copy of **Micrel's 1991 Data Book** please contact the sales locations listed below. For application information please call Micrel Inc. at **408-245-2500**.

**AUTHORIZED REPRESENTATIVES WORLDWIDE**

**UNITED STATES**

**ALABAMA**

Electronic Marketing Assoc.  
Tel: 205-880-8050

**ARIZONA**

Sun State Technical Sales  
Tel: 602-220-0595

**ARKANSAS**

Barry Sales  
Tel: 214-234-0255

**CALIFORNIA (Northern)**

W-J Electronic Sales  
Tel: 408-982-9222

**CALIFORNIA (Southern)**

D2 Sales Incorporated  
Tel: 619-481-9310

**CALIFORNIA (Southern)**

RTS Associates  
Tel: 714-730-9561

**CALIFORNIA (Southern)**

The LCS Company  
Tel: 619-868-5844

**COLORADO**

Component Sales Inc.  
Tel: 303-779-8060

**CONNECTICUT**

Dynamic Sales  
Tel: 203-693-6567

**DELAWARE**

Omega Electronic Sales  
Tel: 215-244-4000

**GEORGIA**

Electronic Marketing Assoc.  
Tel: 404-448-1215

**IDAHO**

SPS Electronics Inc.  
Tel: 503-697-7768

**ILLINOIS**

ESA Technical Marketing  
Tel: 708-544-0120

**INDIANA**

Applied Data Management  
Tel: 317-257-8949

**IOWA**

J R Sales Engineering  
Tel: 319-393-2232

**KANSAS**

Midwest Technical Sales  
Tel: 913-888-5100

**LOUISIANA**

Barry Sales  
Tel: 214-234-0255

**MASSACHUSETTS**

Dynamic Sales  
Tel: 617-272-5676

**MARYLAND**

Boyle Associates  
Tel: 703-620-9558

**MICHIGAN**

Applied Data Management  
Tel: 313-741-8558

**MICHIGAN**

Applied Data Management  
Tel: 313-485-2974

**MINNESOTA**

George Russell Associates  
Tel: 612-854-1166

**MISSISSIPPI**

Electronic Marketing Assoc.  
Tel: 205-880-8050

**MISSOURI**

Midwest Technical Sales  
Tel: 314-298-8787

**NEW HAMPSHIRE**

Dynamic Sales  
Tel: 617-272-5676

**NEW JERSEY**

Comp Tech Sales  
Tel: 201-288-7400

**NEW MEXICO**

Nelco Electronix  
Tel: 505-293-1399

**NEW YORK CITY**

Comp Tech Sales  
Tel: 201-288-7400

**NEW YORK (Upstate)**

Smith Technical Sales  
Tel: 716-924-8612

**NEBRASKA**

J R Sales Engineering  
Tel: 319-393-2232

**NORTH CAROLINA**

Electronic Marketing Assoc.  
Tel: 919-847-8800

**OHIO**

Crest Components  
Tel: 216-543-9808

**OKLAHOMA**

Barry Sales  
Tel: 214-234-0255

**OREGON**

SPS Electronics Inc.  
Tel: 503-697-7768

**PENNSYLVANIA**

Omega Electronic Sales  
Tel: 215-244-4000

**SOUTH CAROLINA**

Electronic Marketing Assoc.  
Tel: 803-233-4637

**TENNESSEE**

Electronic Marketing Assoc.  
Tel: 404-448-1215

**TEXAS**

Barry Sales  
Tel: 214-234-0255

**UTAH**

Component Sales, Inc.  
Tel: 801-561-5688

**VERMONT**

Dynamic Sales  
Tel: 802-476-4223

**VIRGINIA**

Boyle Associates  
Tel: 703-620-9558

**WASHINGTON**

SPS Electronics Inc.  
Tel: 206-794-0154

**WASHINGTON D.C.**

Boyle Associates  
Tel: 703-620-9558

**WISCONSIN**

ESA Technical Marketing  
Tel: 708-544-0120

**WYOMING**

Component Sales, Inc.  
Tel: 303-779-8060

**EUROPE**

**FRANCE**

Rep France  
Tel: 011-331-420-42925

**GERMANY**

Adicom GmbH  
Tel: 011-49-089-723-7078

**ISRAEL**

I.E.S. Electronic Agencies  
Tel: 011-972-3-752-6333

**ITALY**

Acxis s.r.l.  
Tel: 011-39-2439-0832

**UNITED KINGDOM**

Mogul Electronics  
Tel: 011-44-732-741841

**ASIA**

**JAPAN**

Kawasho Corporation  
Tel: 011-813-35-78-5190

**KOREA**

Acetronix  
Tel: 011-822-796-4561

**SINGAPORE**

QuadRep Electronics (T) Ltd.  
Tel: 011-886-2-5522372

**TAIWAN**

QuadRep Electronics (T) Ltd.  
Tel: 011-886-2-5522372

**AUTHORIZED DISTRIBUTORS WORLDWIDE**

**Calder Electric**

Grand Rapids, MI  
Tel: 616-698-7400

**Competitive Components**

Fullerton, CA  
Tel: 714-871-8700

**Connec Tek, Inc.**

Carrollton, TX  
Tel: 214-245-1266

**Connec Tek, Inc.**

Houston, TX  
Tel: 713-956-9091

**Connec Tek, Inc.**

Austin, TX  
Tel: 512-837-9892

**Ditz Schweitzer**

Denmark  
Tel: 011-45-42-459244

**Electronitel**

Switzerland  
Tel: 011-41-37-410060

**Elcontrol S.p.A.**

Italy  
Tel: 011-39-51-86-10-79

**High Technology Semi**

Tustin, CA  
Tel: 714-259-7733

**ISC France**

France  
Tel: 011-331-45-064275

**Integrated Electronics**

Finland  
Tel: 011-358-351-3133

**Jan Devices Incorporated**

Reseda, CA  
Tel: 818-708-1100

**Kawasho Corporation**

Japan  
Tel: 011-813-35-78-5190

**Lagerkrantz Keltech**

Sweden  
Tel: 011-46-08-754-7400

**Microlink S.A.**

Belgium  
Tel: 011-32-2-5218650

**Nu Horizons**

Amityville, NY  
Tel: 516-226-6000

**Nu Horizons**

Pine Brook, NJ  
Tel: 201-882-8300

**Nu Horizons**

Wakefield, MA  
Tel: 617-246-4442

**Nu Horizons**

Rochester, NY  
Tel: 716-248-5980

**Nu Horizons**

Columbia, MD  
Tel: 301-995-6330

**Nu Horizons**

Marlton, NJ  
Tel: 609-596-1833

**Nu Horizons**

Ft. Lauderdale, FL  
Tel: 305-735-2555

**Nu Horizons**

Huntsville, AL  
Tel: 205-722-9330

**Nu Horizons**

Norcross, GA  
Tel: 404-416-8666

**Opto Plus + Incorporated**

Mission Viejo, CA  
Tel: 714-380-8654

**R&D Electronics**

Australia  
Tel: 011-61-03-808-8911

**R-Theta**

Canada  
Tel: 416-890-0221

**Solid State Supplies**

United Kingdom  
Tel: 011-44-892-35366

**Taylor Electric**

Mequon, WI  
Tel: 414-241-4321

**Unitronics S.A.**

Spain  
Tel: 011-34-1-542-5204

the process.

Efficiencies using the National SRICs run from 80% to 90%. The output of a 1-A, LM2575 buck regulator with 12 V in and a nominal 5 V out stays between 4.8 and 5.2 V ( $\pm 4\%$ ), operating with an input voltage between 8 and 40 V, and a load between 0.2 and 1 A. All buck-family devices offer a logic-controlled shutdown mode with a quiescent current of 200  $\mu$ A. Self-protection features include current limiting and thermal shutdown. On-chip timing and loop compensation (buck units only) save both pins and parts.

If you need more current, you can turn to devices from LTC, Motorola, SGS-Thomson, and Semtec Corpus Christi (formally Lambda Semiconductor). All have devices that can handle four or more amperes. LTC is ahead of the pack with their 10-A LT1270A, an adjustable-output, current-mode PWM boost converter.

The internal architecture of the LTC chips, coupled with a detailed application note by its designer Carl Nelson, permits them to be used in

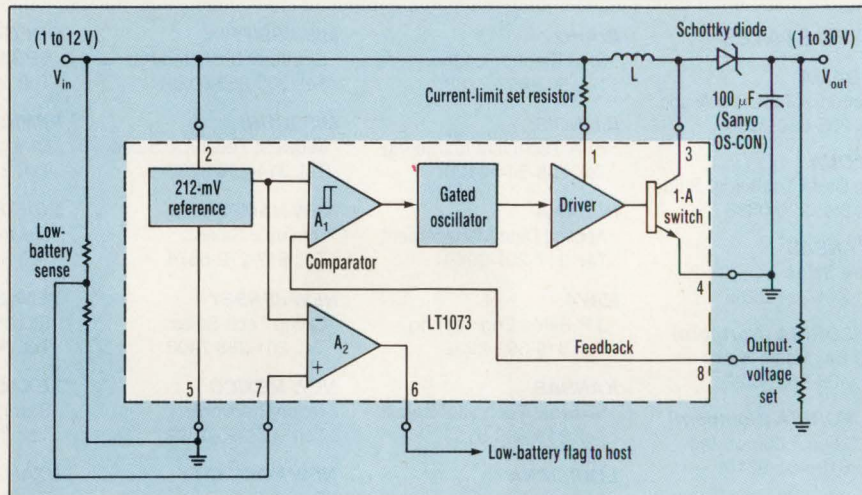

**3. A SINGLE INDUCTOR AND SWITCH** are all that the Linear Technology LT1073 switching regulator requires to convert the power in a 1.1-V battery to 5 V at 40 mA. A bipolar process and special circuitry are the reasons this conversion can occur.

most other common topologies, including buck, forward, inverting, "Cuk," and an isolated flyback mode. This last topology permits transformer isolation between input and output without dc feedback between the output and the control cir-

cuit. When in this mode, internal circuits sense the amplitude of the flyback pulse (a direct function of the output voltage) and use it in lieu of sensing the output voltage on the secondary side of the transformer. A delay circuit on the chip lets the cir-

**TABLE 1. REPRESENTATIVE GENERAL-PURPOSE SWITCHING-REGULATOR ICs**

Specifications	Units	LT1070/71/72	LT1070/71/72	LT1270A	LT1074	LM2575	LM2576	LM2577
		(Linear Technology)			(National Semiconductor)			
Basic topology	na	Boost	Boost	Boost	Buck	Buck	Buck	Boost
Switch current	A	5/2.5/1.25	5/2.5/1.25	10	5, 10#	1	3	3
Input-voltage range	V	3-40 60 (HV model)	3-40	3.5-30	4.5-45 64 (HV model)	8-40 60 (HV model)	4-40	3.5-40
Output voltage	V	65 75 (HV model)	65	60	2.5-50	5 12 (-12 model) 15 (-15 model) 1.2-37 (adj. model) 57 (HV and adj. model)	5 12 (-12 model) 15 (-15 model) 1.2-37	na 12 (-12 model) 15 (-15 model) 5-60
Frequency (nominal)	kHz	40	100	60	100	52	52	52
I <sub>q</sub> (run/sleep)	mA	9/0.25	9/0.25	9/0.25	9/na	9(t)/0.2	9(t)/0.2	7(t)/na
External parts required	na	8	8	8	8	4/6 (fixed/adj.)	4/6 (fixed/adj.)	6/8 (fixed/adj.)
Price	na	\$5.36/\$4.45/ \$2.24	\$5.36/\$4.45/ \$2.24	\$5.36	\$4.93	\$2.75/\$3.15 (Std./HV)	\$4.95 (Std./HV)	\$4.40 (Std./HV)
Package	na	1,2/1,2/1-5	1,2/1,2/1-5	2	1,2,6	1,2,7,8	1,2	1,2,7,8
Control mode	na	Current PWM	Current PWM	Current PWM	Current PWM	Current PWM	Current PWM	Current PWM
Other topologies	na	10-15	10-15	10-15	11, 13, 17, 18	12, 14, 18	12, 14, 18	11, 13
Features	na	20-23	20-23	20-23	20, 21, 22-27 (11-pin version only)	20, 21, 23, 28, 29, 30	20, 21, 23, 28, 29, 30	20, 21, 22, 26, 29, 30, 31, 33

**FOOTNOTES FOR ALL DEVICES**

All specifications are maximums or minimums at 25°C, unless noted as (t) for typical or noted as nominal.

Package types: 1 = 4-pin TO-3; 2 = 5-pin TO-220; 3 = 8-pin plastic DIP; 4 = 8-pin ceramic DIP; 5 = 8-pin SO; 6 = 11-pin power SIP; 7 = 16-pin DIP; 8 = 24-pin SOIC; 9 = 16-pin SOIC; 10 = 16-pin power DIP; 11 = 15-pin power SIP; 12 = 7-pin power SIP; 13 = 18-pin power DIP; 14 = 8-pin TO-3; 15 = 9-pin power SIP; 16 = 14-pin DIP.

Other topologies: 10 = Buck; 11 = Flyback; 12 = isolated flyback; 13 = forward; 14 = inverting; 15 = "Cuk"; 16 = boost; 17 = positive to negative; 18 = negative boost.

## SWITCHING-REGULATOR ICs

cuit ignore the accuracy-reducing spike that's caused by leakage inductance, on the leading edge of the fly-back pulse.

Although most members of the LT1070 family have only four pins besides ground (the 4-pin TO-3 is the exception), multi-use pins let features abound. The compensation pin, which connects to the junction of the error-amplifier output and the comparator input does four jobs: loop compensation, shutdown, soft start, and programming the current limit. Shutdown requires pulling the pin below 0.15 V, reducing the typical 6 mA of quiescent current to just 50  $\mu$ A. The output voltage is set by connecting the feedback pin to the midpoint of a voltage divider between output and ground. Pulling the feedback pin low puts the chip in the fly-back mode. On-chip timing also reduces the number of pins.

On-chip adaptive anti-saturation circuitry maximizes efficiency by detecting the onset of power-switch saturation. Then, it virtually instantaneously adjusts switch-driver cur-

rent to limit saturation. Not only is driver dissipation minimized, but switch turn-off time drops. However, because efficiency is very application specific, LTC doesn't specify it on their data sheets. But Nelson's application note devotes over a page to its calculation with equations and an example. It considers operating current, and switch, inductor, and diode losses. In the example, 5- and 15-V-output versions of a typical circuit show efficiencies of 79% and 86%, respectively. Diode losses are minimal.

If you need an adjustable 5-A buck converter in a TO-3 or TO-220 package, LTC's LT1074, which uses current-mode PWM, may be the answer (*Table 1, again*). Rated at 5 A, its unique process/structure without isolation tubs permits the switch output to swing 40 V below ground. As a result, it can be used with a tapped inductor to provide 10 A out at 5 V. In addition, unlike some devices, it can also operate in positive-to-negative, negative-boost, flyback, or forward-converter topologies.

To cover the 1-to-5-A range, Motor-

ola offers two SRIC families. One employs pulse skipping, the other voltage-mode PWM. Most provide a 5-V output with just a jumper from output to the sense pin. However, a divider turns them into variable-output devices. The pulse-skipping MC34063 stands out. With the exception of the just-announced LT1072S8 and LT1172S8, it's the only SRIC in an 8-pin surface-mounted package that can handle more than 1 A (it also comes in 8-pin DIPs).

Like Motorola, SGS-Thomson builds both PWM machines (3 of them) and a pulse skipper, all for buck topologies (*Table 1, again*). The three voltage-mode PWM SRICs, the L296, L4960 and L4962, are rated at currents of 4, 2.5, and 1.5 A, respectively.

When Semtech Corpus Christi (SCC) discovered (as competitors have more recently) that designers wanted no part of the design process no matter how detailed the data sheet and application notes, they came up with the LSH-6300 and LSH-6400 families (*Table 1, again*). These

MAX738 (Maxim)		MAX743	MC34165/MC34153 (Motorola)	MC34166/MC34167 (Motorola)	L296 (SGS Thomson)	L4963	LAS6320/30/50/80 (Semtech Corpus Christi)	LAS6420/30/50/80 (Semtech Corpus Christi)
Buck	Boost	Boost	Buck	Buck	Buck	Buck	Buck	Buck
0.3/0.75	0.125/0.1	1/3	3/5	4	1.5	2/3/5/8	2/3/5/8	
6.6-16.5	4.2-6	2-65/2.5-40	7.5-40	5-35	5-36	5-35	5-40	
5 (fixed)	$\pm 12, \pm 15$	65/40 (5 fixed)	40 (5 fixed)	5.1 (fixed), 5-40	5.1 (fixed), 5-40	5-27	5-31	
200	160	50	72	100	60	to 100	to 100	
3/0.1	4/0.2	10/na	40 (max duty cycle)/0.1	40/na	16/0.1	na	na	
5	7	6 (5V), 8 (adj.)	7 (5V), 8 (adj.)	8/10 (5.1-V fixed/adj.)	5/7 (5.1-V fixed/adj.)	12	12	
\$4.50 (approx.)	\$5.82	\$1.59/\$1.59	\$1.86/\$2.45	\$3.50	\$2.25	\$3.37/\$5.07/\$6.58/\$9.19	\$3.82/\$5.58/\$7.24/\$10.05	
3,9	7,9	10	2	11	13	14,15	14,15	
Current PWM	Current PWM	Voltage pulse skipping	Voltage PWM	Voltage PWM	Voltage pulse skipping	Voltage PWM	Voltage PWM	
14	Buck	10,14	14	14	14,16	11, 13, 14, 15, 16	11, 13, 14, 15, 16	
20, 21, 22, 26, 27, 29, 31	20, 21, 22, 26, 29, 31, 32	21, 22, 27, 29, 33	20, 21, 22, 23, 26, 29	21, 22, 23, 24, 25, 27, 29, 34	21, 25, 25, 26, 29, 31, 33	21, 23, 27, 29	21, 23, 27, 29	

Features: 20 = on-chip timing; 21 = pulse-to-pulse current limiting; 22 = soft start; 23 = external shutdown (sleep mode); 24 = synchronizable; 25 = high/low-voltage output flag; 26 = undervoltage lockout; 27 = programmable-current limit; 28 = on-chip compensation; 29 = thermal shutdown; 30 = design software; 31 = line and load regulation guaranteed; 32 = output voltage guaranteed; 33 = no compensation needed; 34 = overvoltage crowbar; 35 = low-battery flag; 36 = power-ready flag; 37 = charge pump for negative voltages. na = not applicable; ns = not specified; # = at 5 V with tapped inductor

## SWITCHING-REGULATOR ICs

are simple, thick-film hybrids incorporating all of the required off-chip parts except input and output filter capacitors and the inductor. Essentially, the predecessors to National's simple switchers, they come in a 5-pin TO-220 package (the 8-A chips are in the original 9-pin SIP). In fact, Ken Bretsch, marketing director at the company (under both SCC and

Lambda logos) is puzzled as to why National didn't choose the same pin-out for their buck SRICs. With that in mind, we can expect to see by year's end a drop-in second source for the National chips from SCC. And they'll be available in 4-pin TO-3 packages, as well.

If you need no more than 750 mA at 5 V and have a power source in the

10.2-to-16.5-V range, Maxim's new MAX738 current-mode PWM buck regulator may be the preferred chip. If you only need 300 mA at 5 V, the power source can be as low as 6.6 V. It lends itself to applications where the amount of 12- or 15-V power is limited and becomes a natural for portable instruments or "smart" power tools running off 12-V batter-

## SWITCHING REGULATOR BASICS

**T**hough there are many switching-regulator configurations, commonly called topologies, they basically combine voltage regulation with dc-dc conversion. Any given topology takes a dc power source and efficiently either steps it up, steps it down, and/or changes its polarity. The simplest regulator topologies are boost, buck, and inverting. The last is also often called buck-boost. All three use a simple inductor. When isolation is needed, a transformer is substituted for the inductor, most often in a fourth topology called flyback. These four topologies employ one power switch and dominate low-power dc-dc converter applications up to a few hundred watts, the venue of switching-regulator ICs (SRICs).

In a basic buck regulator, the two switches alternately open and close so that the voltage applied to the inductor L is either the input

voltage or zero (see the figure, a). The dc output voltage is then the average of the voltage applied to  $L_1$ . If  $S_1$  closes at time  $t_{on}$  and opens at time  $t_{off}$ :

$$V_{out} = (V_{in}) \frac{t_{on}}{t_{on} + t_{off}} = (V_{in}) (\text{duty cycle})$$

where by convention, the duty cycle (DC) is defined as:

$$DC = t_{on} / (t_{on} + t_{off})$$

By definition, values of  $t$  must lie between 0 and 1, illustrating a basic property of buck converters: The output voltage is always less than the input voltage. The items missing from this simple equation, namely  $L$ ,  $C$ , switching frequency, and load current, also tell much about switching regulators in general. To a first approximation, regardless of topology, a

switcher's output voltage depends only on the duty cycle of the switches and the input voltage.

A diode can replace one of the switches in a buck regulator (see the figure, b). When the switch is closed, the input voltage minus the output voltage appears across the inductor. The diode  $D$  is back-biased so a linearly increasing inductor current starts flowing into the load while developing a magnetic field in the inductor. When this rising current exceeds the load current, the excess starts to charge capacitor  $C$  and the output voltage starts to rise. When the switch opens, the magnetic field collapses, discharging the energy in the inductor and developing a voltage  $L di/dt$ . This forward-biases the diode and starts current flowing into the load/capacitor.

The ideal switching regulator dissipates no power because it contains only inductors, capacitors and switches. Therefore:

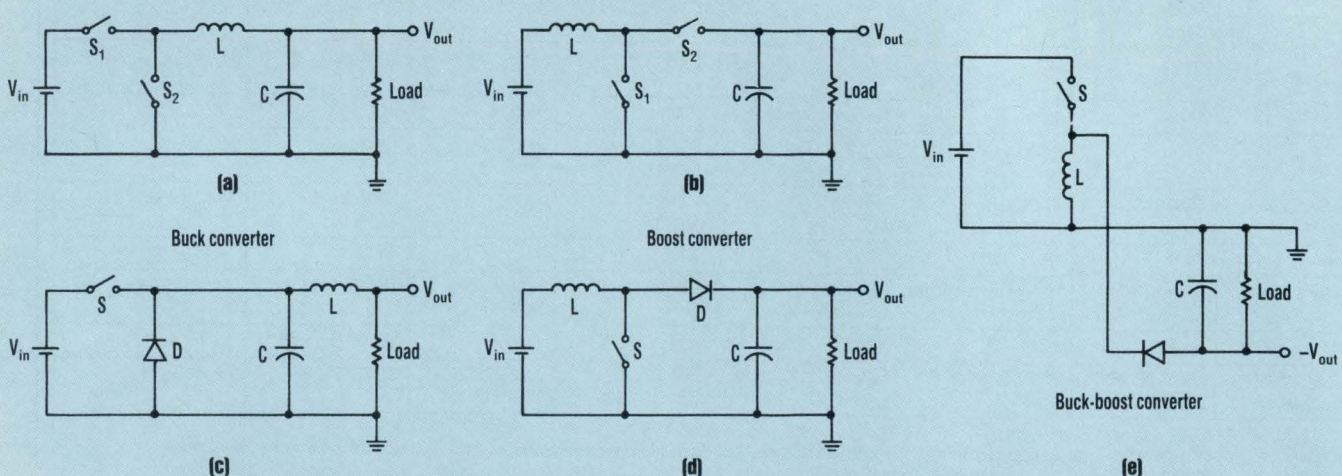

## SWITCHING-REGULATOR ICs

ies. Alternatively, it can regulate the power from 9-V alkaline batteries, or from the "wall cubes" that convert the ac line to 9 V (to run 9-V battery-powered products).

The last few years has seen the development of several families of converters that can operate off one- or two-cell, primary or storage batteries (Table 2). Several run off volt-

ages as low as the 1 V from a single NiCad cell, or from the 1.5 V from an alkaline cell. Others are optimized to work off 2 to 3 V to handle a single lithium cell, or a pair of NiCad or alkaline cells. These SRICs are needed for applications ranging from notebook/palmtop PCs, cellular telephones, and pagers, to electronic games, and other ultra-miniature

battery-powered devices. Solar-powered devices need similar performance from a converter. These devices can also provide the power for circuits running off 4-to-20-mA process-control current loops. Most provide boost capability (for obvious reasons), but buck-boost topology is also needed to create minus voltages.

In these converters, the specification for minimum startup voltage (either 1.1 or 2.2 V) is even more important than efficiency. However, most of them employ pulse skipping, not PWM, to maximize it. In addition, they must have a shutdown mode that truly puts them to sleep.

The MAX654 and MAX657 represent the first SRICs available in the U.S. to truly address single-cell applications. They come in 14-pin ceramic and plastic DIPs, 14-pin narrow-body SOICs, and as die. Because Harris has just announced a second source, they may well become the first standard SRICs. Both companies' devices are guaranteed to start up at voltages as low as 1.15 V, and as the battery discharges they typically will continue to operate down to 0.9 V. The MAX654 boosts the input to 5 V at 50 mA; the MAX657 to 3 V at 70 mA. A sibling, the MAX655, is optimized for two-cell operation. Guaranteed to start on 2.3 V, it produces 80 mA at 5 V.

Using two separate converter circuits on the same chip, each with its own inductor, represents the secret behind these Maxim and Harris ICs (Fig. 2). If you're familiar with n-channel MOSFETs, you know that their gates must be driven very positive with respect to the drain to turn them on hard (minimize their on-resistance). This task is virtually impossible if only about 1 V is available. Maxim's designer, Dave Bingham, used what is called a bootstrap circuit. When power is applied, a specially designed oscillator starts itself up on the low voltage and turns on the FET in series with inductor  $L_1$ , "charging" the coil with current (creating its magnetic field). The FET switch turns off about 40  $\mu$ s later, generating a high-voltage flyback pulse that's rectified by diode  $D_1$  and

$$P_{out} = P_{in}$$

or

$$(I_{out})(V_{out}) = (I_{in})(V_{in})$$

and

$$I_{in} = (I_{out}) \frac{V_{out}}{V_{in}}$$

That is, for a given input current, the input current in a buck converter is less than the output current. In a boost converter, the input current is higher than the output current.

The output voltage of an ideal boost converter (see the figure, c) is given by:

$$V_{out} = \frac{V_{in}}{1-DC}$$

where DC represents the ratio of  $S_1$ 's on time to off time, when  $S_1$  and  $S_2$  alternately open and close. The duty cycle can take on values between 0 and 1, so the output is always higher than the input. When  $S_1$  is opened, a voltage  $V$  higher than the supply voltage is developed across the inductor by the rapidly changing current created by the collapsing magnetic field ( $V = Ldi/dt$ ). Like the buck circuit, a diode can replace  $S_2$  (see the figure, d). When switch  $S$  opens, the inductor voltage instantly rises high enough to forward-bias the diode. This voltage must exceed the sum of the output voltage and the forward drop of the diode. The inductor current now flows through the diode to the load and the capacitor. Buck-boost (inverting) converters are similar to boost converters except that the diode (switch) connects the load across the inductor in-

stead of across the switch (see the figure, e). Thus:

$$V_{out} = (-V_{in})(DC)/(1-DC).$$

In most switching regulators, the duty cycle is controlled by a feedback loop using one of two techniques: constant-frequency pulse-width modulation (PWM) or constant on-time, variable-frequency, pulse skipping. In the former, the on-time of the switch is a function of the error signal representing the difference between the actual and desired output voltages. The greater the difference, the greater the on-time. The switch is turned on by a fixed-frequency oscillator. A comparator sensing the error turns it off. The oscillator in a pulse skipper has a fixed on-time, but the switch is only turned on when the error exceeds a limit. Because every clock pulse may not turn the switch on, pulse skippers offer greater efficiency and simpler circuitry than PWM converters. And they usually don't require compensation. But they have more ripple on the dc output, which is harder to filter out as low-duty-cycle operation creates low-frequency subharmonics of the clock frequency.

These converters, regardless of topology, operate in either voltage or current mode. In the voltage mode, the duty cycle is strictly a function of the output voltage. But current-mode converters also sense pulse-by-pulse switch current. The technique removes one pole from the feedback control loop, simplifying compensation, and provides feed-forwarding, improving line regulation.

WE DESIGNED THE BEST  
A/D CONVERTER IN NO TIME AT ALL.  
BUT THEN, WE HAD A 30-YEAR  
HEAD START.

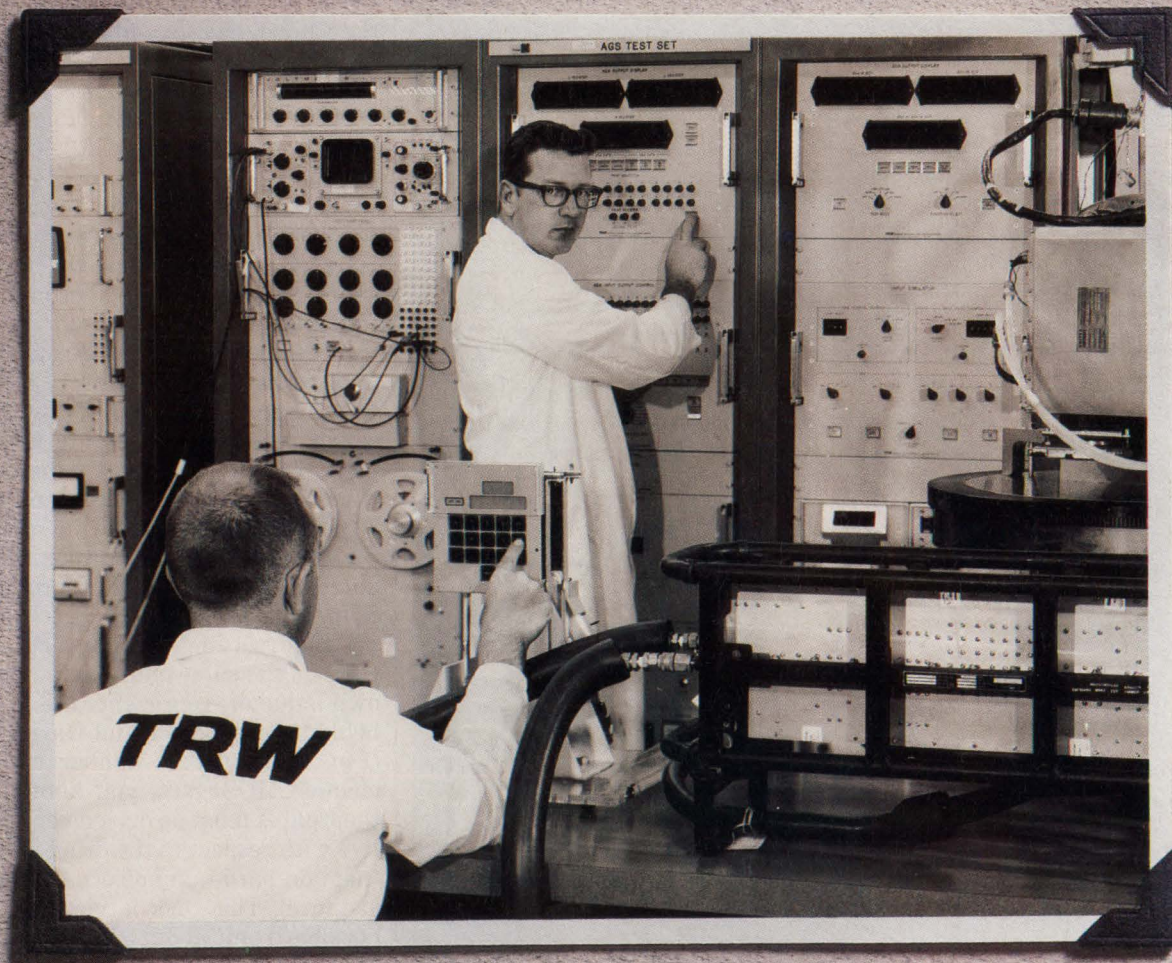

8-bit resolution. 40 Msps. Two-step architecture and CMOS technology that reduces power dissipation to less than 180mW.

All with a significant cost advantage. And all from a single +5 Volt power supply.

That is the TMC1175, developed in only months by TRW LSI Products Inc. But then, that's what you can expect from the industry leader in high-performance A/D converters.

Our years of setting standards have given us the ability to respond quickly to changing needs in the industry, continually improving our line of products in terms of performance and cost. The same dedication to perfection that earned us an Emmy award in 1989 for video technology.

With the TMC1175, video driving amplifiers can be eliminated. The Track-and-Hold circuit is built-in; so is the voltage reference. All digital inputs and three-state outputs are TTL-compatible. And all performance specifications are guaranteed over the -20°C to 75°C temperature range.

All of which makes the TMC1175 excellent for Digital Television designs. Video Digitizing. Image Scanners. Multimedia. And low cost, high speed Data Conversion. It can even be used in PC video board designs.

The TMC1175 is available in 24-pin plastic skinny DIP, 28-lead PLCC and 24-lead plastic SOIC (small outline) suitable for surface mount applications.

And of course, TRW LSI backs you with all the support you need. With field and in-house application engineers. Application notes. And a full line VLSI Data Book.

All with the full spec performance that is synonymous with TRW standards.

Ask for the Data Sheet, applications and other information on the TMC1175 today. You'll agree, it's an A/D converter that meets your standards. From the company that has been setting them for years.

Call or write: TRW LSI Products Inc.,  
P.O. Box 2472, La Jolla, CA 92038  
(619) 457-1000, FAX (619) 455-6314  
**(800) TRW-LSIP** (800) 879-5747



**TRW LSI Products Inc.**

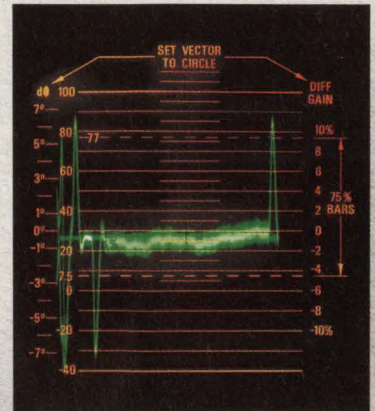

TMC1175 differential gain

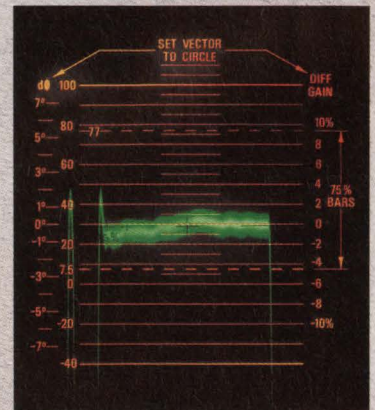

TMC1175 differential phase

**STANDARDS SET. STANDARDS TO BE MET.**

PRESENTING A FASTER LOW-COST  
D/A CONVERTER. FROM THE PEOPLE  
WHO'VE BEEN THE LEADERS SINCE THE  
BEGINNING OF DIGITAL TIME.

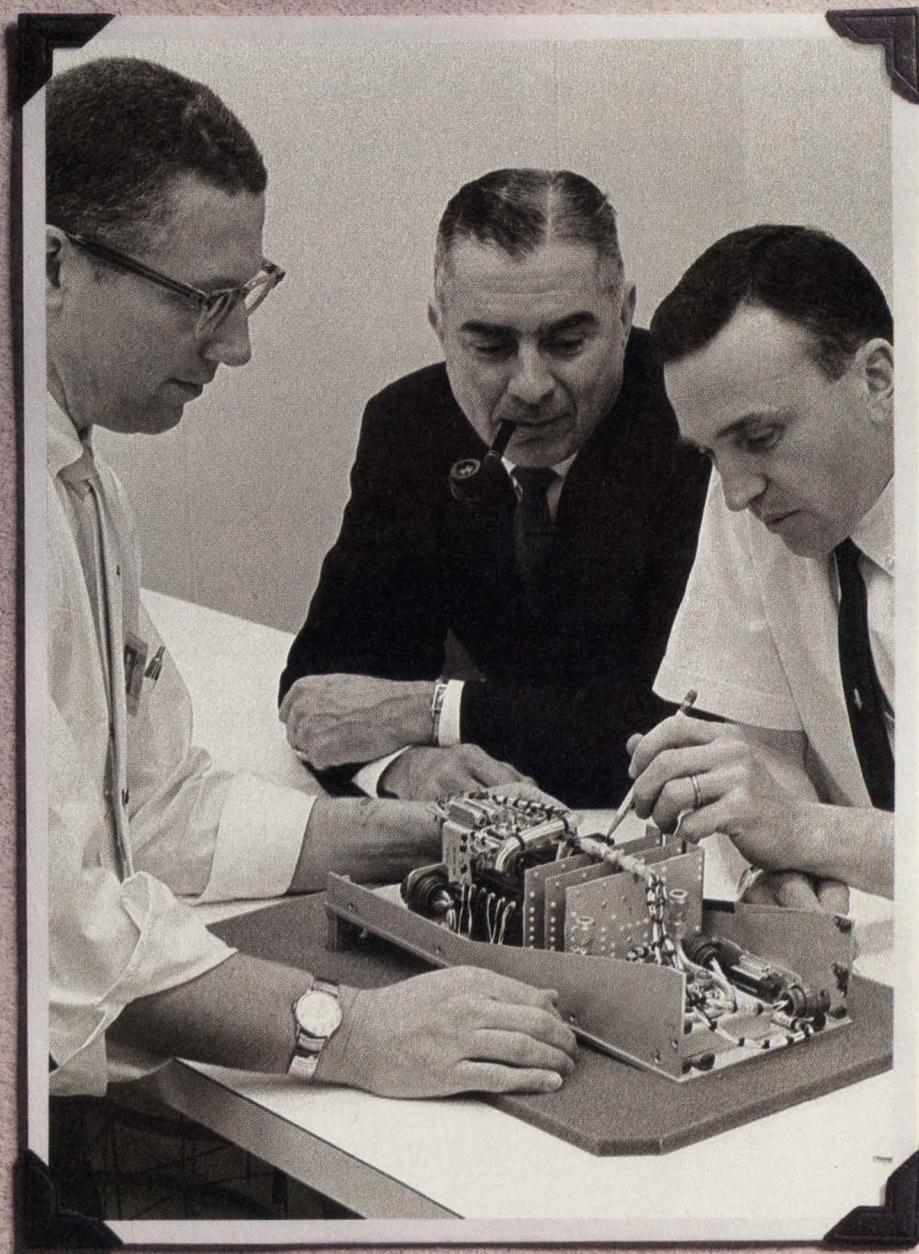



With 10-bit resolution and a speed of 40 Msp/s, a low-cost high-speed D/A converter is here. The TDC3310.

Another timely move from the company who pioneered the Monolithic Video D/A converter. TRW LSI Products, Inc.

Which means that now, you've got just what you need for low-cost video applications.

Because you know TRW LSI's standards. We provide more than innovation. We provide exactness. Performance specs with mins and maxes that you can rely on.

The TDC3310 requires only a +5 Volt power supply and has TTL-compatible inputs,



with a voltage output and a control that inverts video levels. It's ideal for reconstructing both composite and component wave-

forms, including NTSC, PAL, SECAM and RS-343A. And with data decoded and registered ahead of the current switches, the results are outstanding low-glitch characteristics.

In essence, you're getting studio video quality and performance. At a consumer price.

Furthermore, the TDC3310 has a low-cost high-speed A/D companion – the TMC1175. And add the TMC2242 for half-band digital filtering – reducing your design complexity and cost.

The TDC3310 is available in a 32-lead plastic J-leaded PLCC and 28-pin plastic DIP packages, and is guaranteed over the 0°C to 70°C temperature range.

All with the full spec performance that is synonymous with TRW standards.

Ask for the Data Sheet, applications and other information on the TDC3310 today. From the company whose standards get even better with time.

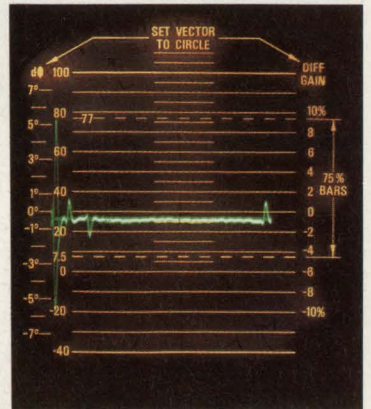

TDC3310 differential phase

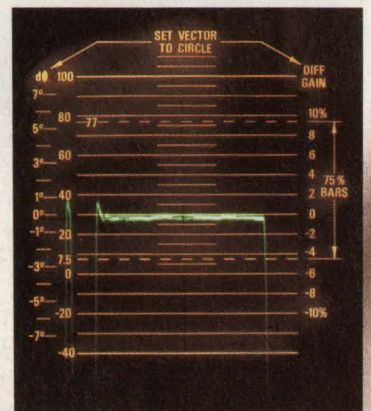

TDC3310 differential gain

Call or write: TRW LSI Products Inc.,  
P.O. Box 2472, La Jolla, CA 92038  
(619) 457-1000, FAX (619) 455-6314  
**(800) TRW-LSIP** (800) 879-5747



**TRW LSI Products Inc.**

# STANDARDS SET. STANDARDS TO BE MET.

## SWITCHING-REGULATOR ICs

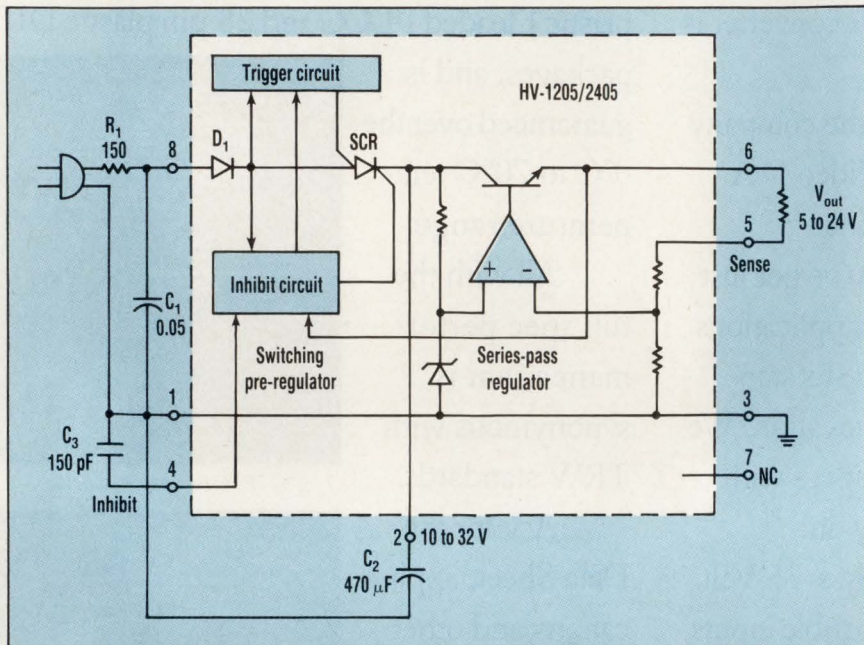

**4. DIRECT CONNECTION TO THE AC LINE** is possible with the Harris HV-1205/2405 switching regulator. The IC works like a light dimmer by controlling how long (what percentage of) each half of the input sine wave is connected to storage capacitor  $C_2$ . It provides up to 50 mA at 5 to 24 V.

stored on external capacitor  $C_2$ , which is connected between the  $V+$  pin (pin 2) and the output.

### IT TAKES TWO TO TANGO

This voltage ( $V+$ ), the rectified flyback pulse, now powers the oscillator and the rest of the chip. Each additional cycle of the oscillator turns  $M_1$  on harder (more current flows), generating a higher voltage, until an internal regulator cuts it off and holds it at 12 V. When it reaches 8 V, the startup comparator,  $C_1$ , starts the "high voltage" driving the gate of the chip's power FET,  $M_2$ , turning it on and off. The high voltage gives this large transistor (it takes up about one-third the area of this 11,150-mil<sup>2</sup> chip) an on-resistance of no more than 0.67  $\Omega$ . The current flowing through it and  $L_2$  develop the high-voltage power pulse that's rectified by external Schottky diode  $D_2$ , and filtered by capacitor  $C_1$ , to create the 3- or 5-V output at  $V_{out}$  (pin 10).

Bringing the normally low control pin (CTL) high, or open, puts these SRICs into a standby (sleep) mode, cutting quiescent current to 80  $\mu$ A. When put to sleep, the power-ready

pin (pin 11) that's tied to the output of  $C_1$  goes low, the power FET is held off, and  $V+$  is cut to 3 or 5 V and connected to  $V_{out}$ . The startup FET,  $M_1$ , can still provide up to 500  $\mu$ A of standby current for circuits that must remain powered, such as volatile memory. The power-ready pin can control external circuits, further

reducing battery drain. The chip also contains an independent low-battery monitor comparator,  $C_2$ . Its input is connected to an internal 1.17-V reference, and its output can sink 1.6 mA or source a few microamperes from  $V+$ .

Harris calls members of its second-source family, ICL644/645/646/647, with the same last digit as the Maxim parts. Note the absence of the two-cell controller, which is a job that can be handled by the one-cell device. The basic specifications are identical with the Maxim parts (as they should be for a viable second source). However, Harris has added a second family with the model numbers ICL7644/7645/7646/7647. These devices offer a complete shut-down mode, dropping quiescent current to 5  $\mu$ A. This is done by bringing pin 8 low (no connection on the original devices).

Although Steve Pietkiewicz of LTC had both bipolar and CMOS processes available to him, a bipolar process was chosen for his IC to challenge the MAX654 family (ELECTRONIC DESIGN, Dec. 27, 1990, p. 26). What resulted was a chip that could run off one or two cells without a bootstrap circuit and its second inductor. In fact, the fixed 5- and 12-V output versions of the LT1073 (single-cell) and the LT1173 take just three external devices (if you don't

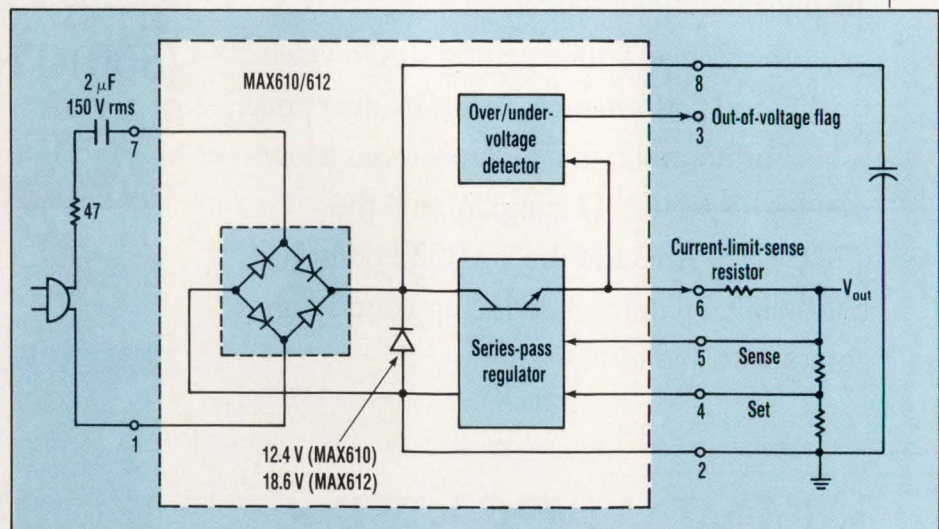

**5. NOT TRULY SWITCHERS**, the Maxim MAX610/612 switching-regulator ICs connect directly to the ac line. An external R-C network drops the voltage and an on-chip linear regulator controls the output.

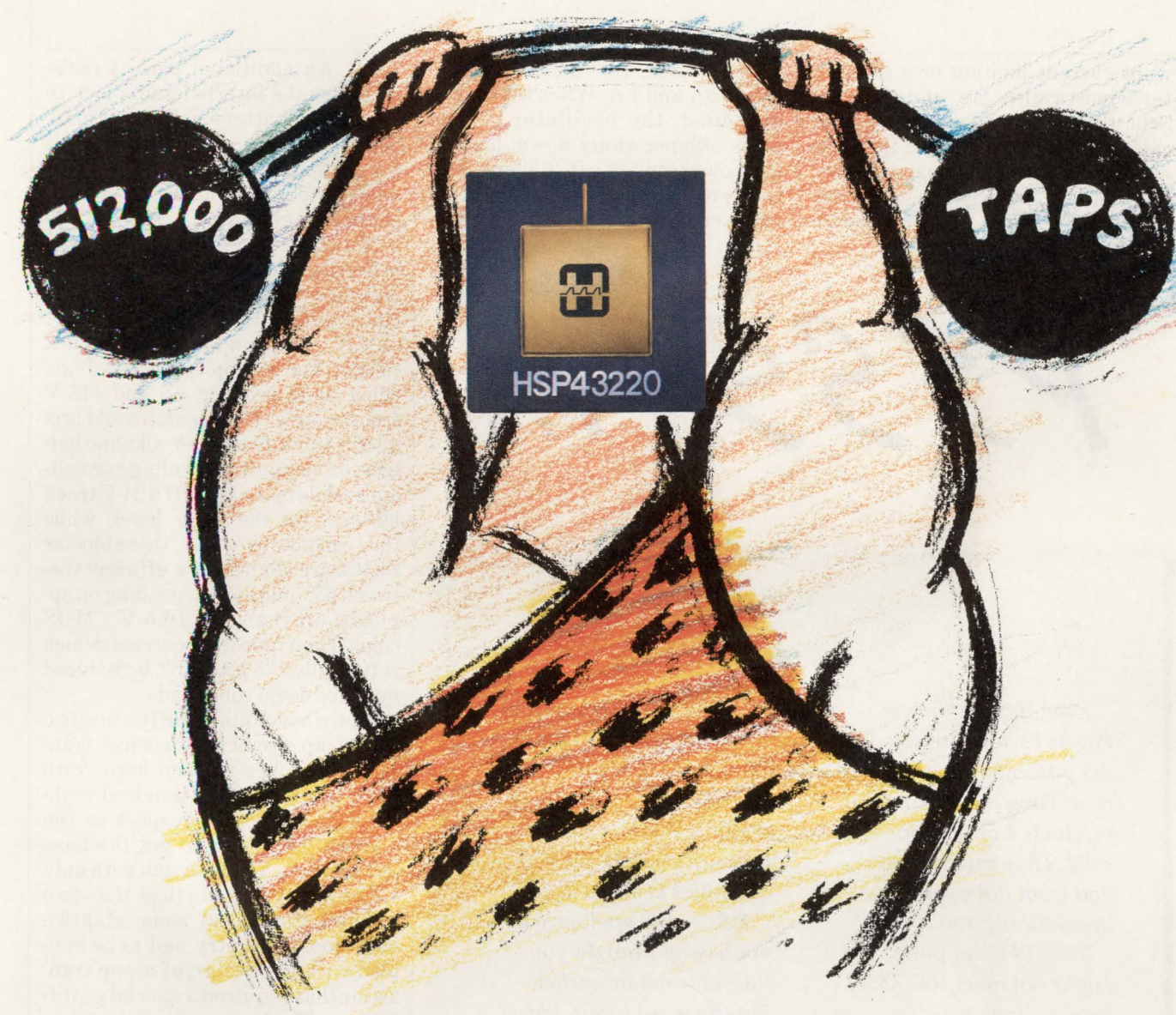

## The world's most powerful digital filter on a single chip.

The new Harris HSP43220 DDF (Decimating Digital Filter) packs more power into a single-chip digital filter than ever before. With features

Decimation:	Up to 16,384
Tap Length:	Up to 512,000
Out-of-band Attenuation:	96 dB
Sample Rate:	Up to 33 MHz
Data Width:	16 bits
Coefficient Width:	20 bits

like programmable decimation to over 16,000, and up to 512,000 equivalent taps, it's a powerhouse of performance.

And despite its incredible power, our DECI-MATE™ software makes designing filters with the

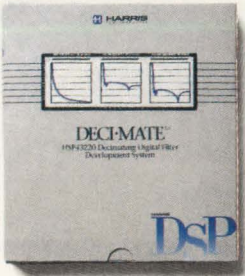

Harris DDF incredibly easy.

Want to know more? That's easy, too. Just call 1-800-4-HARRIS, ext. 1220. And find out more about our complete line of industry-leading ICs for digital signal processing applications.



\*DECI-MATE is a trademark of Harris Corporation.

CIRCLE 102 FOR U.S. RESPONSE  
CIRCLE 103 FOR RESPONSE OUTSIDE THE U.S.

## SWITCHING-REGULATOR ICs

want current limiting or a low-battery warning): an inductor, a Schottky diode, and an output-filter capacitor (Fig. 3). The adjustable model takes two additional resistors.

Unlike the CMOS devices, a user-selectable resistor sets a maximum

current limit for the switch between 0.1 and 1 A. When the limit is exceeded, the oscillator of this pulse skipper shuts down, leaving the power switch off. Reverse-battery protection circuitry limits reverse current to safe values up to -

1.6 V. An additional pair of resistors uses the internal gain block to detect low-battery voltage (Fig. 3, again, far left). It can also be used for undervoltage lockout, or with an external pnp transistor as a linear post regulator.

Not only can these SRICs be used in boost circuits, but also in buck and inverting topologies. In a boost circuit, input voltages can range from 1 to 15 V, and from 1 to 30 V in a buck circuit. For example, a pair of the chips could produce +5 and -12 V from a single cell. One chip could produce 3 or 5 V from a 9-V alkaline battery, or virtually any voltage or voltages while operating off a 24-V truck battery. On the other hand, while they can take over 30 V, these bipolar SRICs are slightly less efficient (between 65% and 85%, depending on application) than the 16.5-V CMOS chips. Their quiescent current, which is typically 135  $\mu$ A, can't be reduced by a shutdown command.

These low-voltage SRICs need no bootstrap circuit because npn-transistor switches turn on hard, with the base only a few hundred millivolts positive with respect to the emitter. However, to get the base drive for a 1-A, 1- $\Omega$  switch with only 1 V on the supply rail (less than two base-emitter drops), some adaptive base-boost circuitry had to be coupled with the design of a pnp transistor that required a special  $p_+$  diffusion. The power switch takes about one-third the area of the 6000-mils<sup>2</sup> die.

LTC isn't alone in choosing bipolar technology for this class of SRICs. In fact, the first devices available in the U.S. (about 1985) were Raytheon's RC4191 family of boost devices. They handle 2.2 V to 30 V with currents to 150 mA on a tiny chip of just 4400 mils<sup>2</sup>.

The first SRIC in this venue, the TL499AC, came from Texas Instruments in late 1983, but it was only available in Japan. It didn't arrive into the U.S. until about April 1989. This unique bipolar chip was the first to run off a single cell, and it contains an independent linear regulator, all crammed into an 8-pin DIP. The boost switcher can provide from 2.9

# PSSST...

Even though they're Power Factor Corrected, the power supplies you're now using could ban your products from Europe after 1992. They might keep you from doing business domestically, too.

Your PFC supplies might not meet IEC 555-2 because they have too much current circulating in third and fifth order line current harmonics.

Pioneer supplies have less than 5% total harmonic current content. They feature built-in >.99 active Power Factor Correction, meet proposed IEC 555-2,

all applicable international safety and EMC standards, and are available from 250 to 2000 watts, in single or multiple outputs. Delivery for most models in OEM quantities is 60-90 days.

*P.S.* — We apologize for not having brought you this information earlier. But the word is out. We've been shipping our PFC supplies worldwide for more than two years. So call us now at 800-233-1745, or 800-848-1745 in California.

*Pioneer Magnetics*

CIRCLE 180 FOR U.S. RESPONSE

CIRCLE 181 FOR RESPONSE OUTSIDE THE U.S.

# Special Forces

## For Your Toughest ASIC Missions

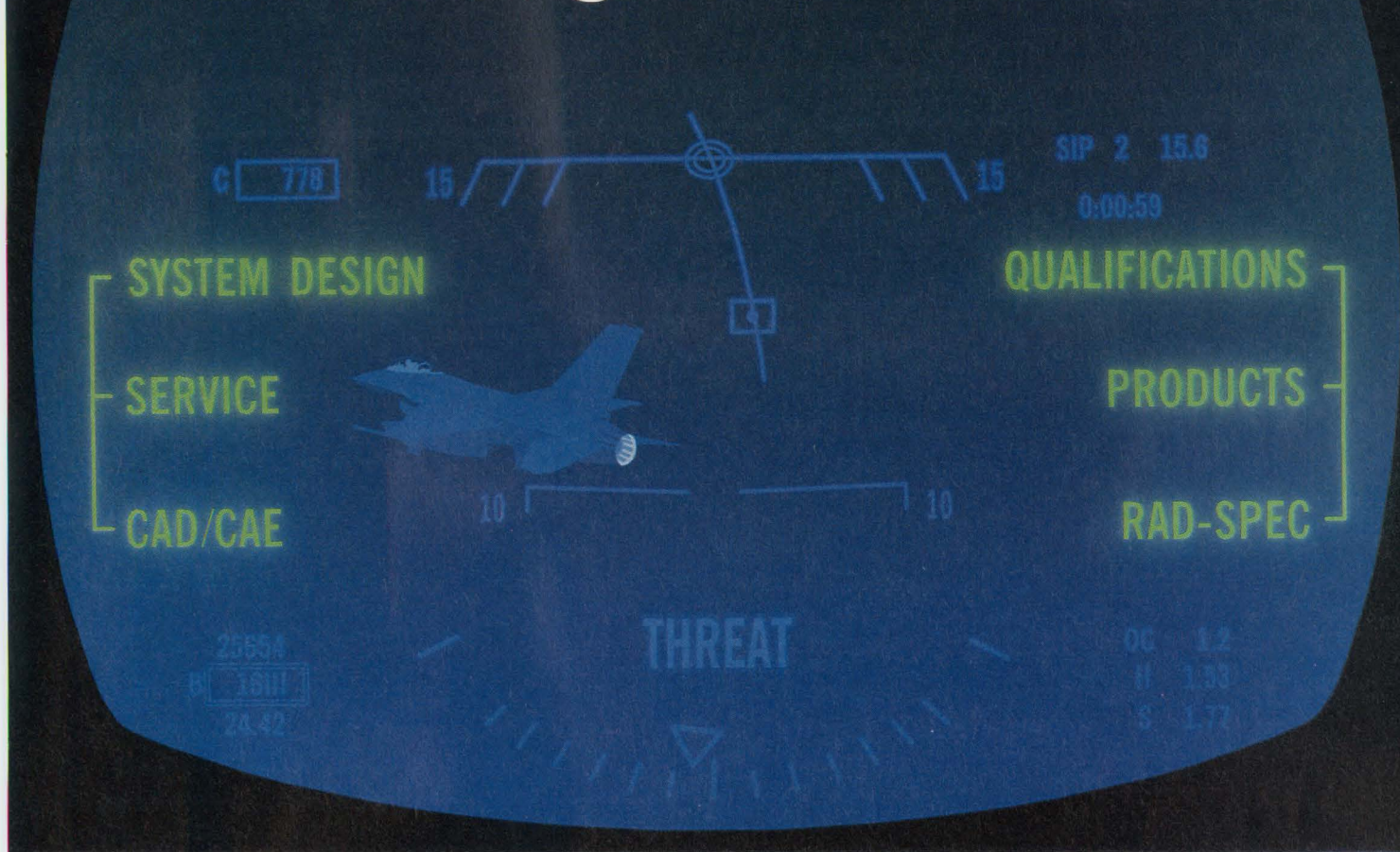

**Qualifications:** From JAN Class B QPL through 883 Levels B and S, UTMC's SystemASICs<sup>SM</sup> are qualified for the toughest missions. In fact, our 1.5-micron UTD is the only readily-available JAN QPL gate array and our 1.2-micron UTE-R is available to 883 levels B and S.

**Products:** With up to 50,000 usable gates and 256 I/Os, SystemASICs are the most capable arrays available. Their tours of duty include the NASA/JPL Mars Observer.

**CAD/CAE:** Be prepared with SystemASIC toolkits to map out the design, simulation, and verification of your ASICs on Mentor Graphics<sup>®</sup> and Valid workstations. SystemASIC CAD/CAE helps you evade risks and capture the objective faster.

**System Design:** Our team of veterans helps you sweep through difficult systems design and keep your program on course. Tactical support includes SystemASIC Megafunctions — like RAM, 1553 bus interfaces, and RISC processor.

**RAD-SPEC<sup>SM</sup>:** Outflank special screening with RAD-SPEC SystemASICs, guaranteed to meet MIL-M-38510 radiation levels with off-the-shelf pricing and delivery.

**Service:** SystemASIC deploys your ASICs faster, with less risk. Whatever the challenge — system design, special screening, packaging, or delivery schedule — UTMC's SystemASIC special forces deliver. No wonder that customers like Honeywell and Rockwell have given UTMC special vendor service awards.

The SystemASIC mission: Deliver semicustom solutions for the toughest ASIC assignments. Beyond high-rel, SystemASIC unites products, technology, qualifications, and support geared specifically to meeting aerospace and defense requirements. And SystemASIC means more than products; it means methodologies to get ASICs from concept through production on-time and with minimal risk, and the total commitment of people to see the mission through. Our forces are fully equipped to handle your objective, with a MIL-STD-976 certified facility, in-house radiation testing, environmental screening, and high-pincount packaging and automated testing. SystemASIC products are supported by the latest Mentor and Valid toolkits and qualification through JAN Class S. So call in the SystemASIC special forces. **When the going gets tough, SystemASIC delivers.**

For more information on SystemASICs,  
call: 1-800-MIL-UTMC  
1575 Garden of the Gods Rd.  
Colorado Springs, Colorado 80907

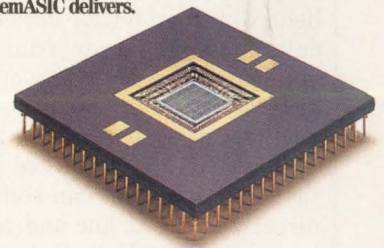

DEDICATED TO AEROSPACE AND DEFENSE

CIRCLE 238 FOR U.S. RESPONSE

CIRCLE 239 FOR RESPONSE OUTSIDE THE U.S.

## SWITCHING-REGULATOR ICs

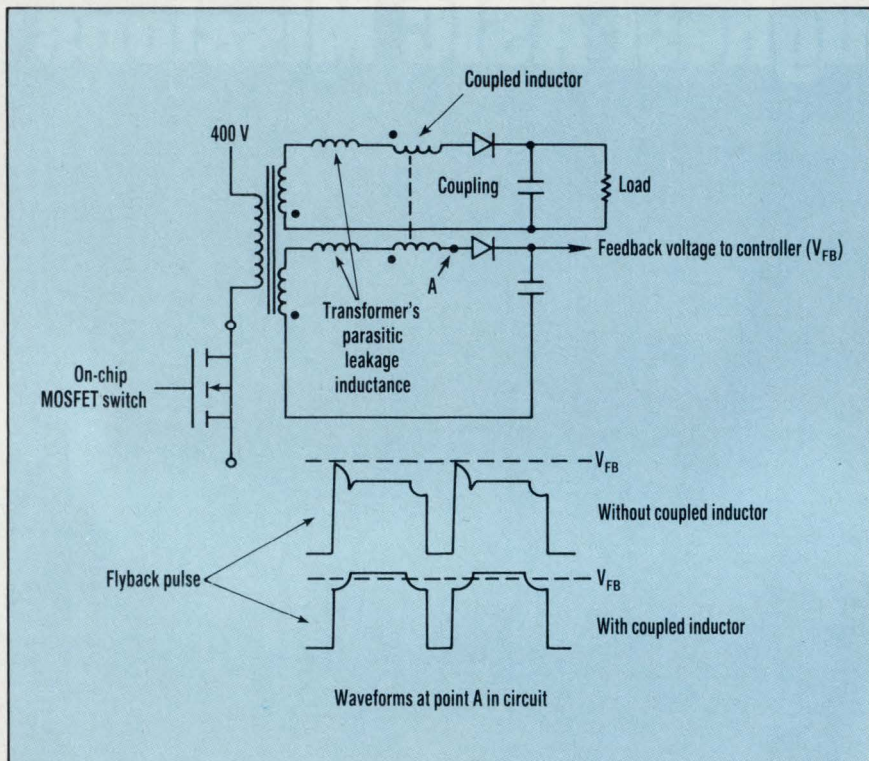

**6. GREATER OFF-LINE ACCURACY** for switching regulators that employ a flyback topology for isolation and feedback is possible using coupled inductors. The inductors eliminate the spike on the leading edge of the flyback pulse caused by parasitic inductance.

to 30 V. Switch current is 500 mA. When coupled to the ac line through a step-down transformer, the chip uses the linear regulator. When moving over to a battery, the switcher is employed. No external rectifier is needed, but a pair of output-voltage-setting resistors are required, as well as a current-limit resistor.

## DEADLY DIPS

If you go back to the ancient BT (before-transistor) days, or if you've been working on CRT deflection circuits or high-power transmitters, you learned early on to work on hot circuits with one hand buried in your pocket. But what about ICs?

Now arriving on the scene are little 8-pin DIPs that can connect you directly to the ac line and/or handle better than 250 V dc. But remember to keep your fingers out of that breadboard! These SRICs divide instantly into chips for two distinct types of applications: those that require galvanic isolation from the ac

power line, such as a transformer, and those that do not. Siliconix and Power Integrations have devices for the first type, Maxim and Harris for the second.

With the heavy move toward safety in both consumer and non-consumer electrical/electronic products over the last few years, the fate of non-isolated devices has been questioned. As it turns out, the safety push, particularly the move to double insulation (sealed plastic cases), has also made it possible to use the non-isolated devices in consumer and non-consumer electrical/electronic products. Consequently, these chips are even finding their way into such products as electric blankets, swimming-pool cleaners (motor control), and lighting controls. They also drive muffin fans, provide the startup/housekeeping power in large switching power supplies, control relays, and provide regulated power for 26-V ac environmental-control systems. They even get into some

consumer toys.

Harris builds two virtually identical chips on their high-voltage (500-V) dielectrically isolated (DI) process. The HV-2405, for worldwide use, handles 18 to 264 V rms. Its U.S. counterpart, the HV-1205, handles 18 to 132 V rms. These aren't typical switching-regulator ICs. Requiring neither inductor nor diode, they provide 5 to 24 V at up to 50 mA (Fig. 4). While there's no isolation between input and output (just silicon junctions rated at 500 V), each 500-V device floats in its own DI tub.

The circuit consists of a switching preregulator followed by a linear series-pass regulator. At power-up, diode  $D_1$  rectifies the positive-going input sine wave, and the preregulator's trigger circuit momentarily switches the rectified voltage to a large 470- $\mu$ F capacitor, ( $C_2$ ). When the capacitor is charged to about 6 V above the selected output voltage, the switch—an SCR with two gates—opens and stays open until the next ac-line cycle starts. The capacitor supplies power to the series-pass regulator, which in turn provides current, at a regulated voltage, to the output. The output current discharges the capacitor at a rate dependent on load current. Each line cycle refreshes the capacitor's charge anew.

Like many SRICs, if the output is pinstrapped to the sense (feedback) pin (pin 5), there's 5 V at the output. A series resistor (shown) or a Zener diode between the output and the sense pin, or a divider in parallel with the internal divider, raises the voltage. Resistor  $R_1$  (typically 150  $\Omega$ ) keeps in-rush current under control and snubber capacitor  $C_1$  (typically 0.05  $\mu$ F) with  $R_1$  form a low-pass filter, limiting the rate of voltage rise at the chip's input. Inhibit capacitor  $C_3$  (typically 150 pF) keeps the chip from turning on during input transients. Pulling the Inhibit pin (pin 4) low keeps the power switch off, shutting down the circuit. In their 8-pin DIPs, the HV-1205 and HV-2405 go for \$2.55 and \$2.93 each, respectively, in 1000-unit lots.

Maxim's three off-line regulators aren't switchers. But from an appli-

## Arrays

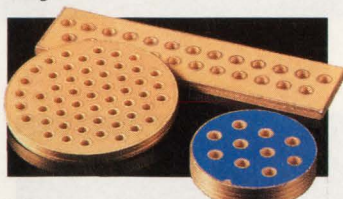

- Highest volumetric efficiency for capacitive filtering in connectors by restricting high frequency current at the interface, sharply reducing EMI emissions.
- Gold plated terminations provide superior solderability and leach resistance.
- MLC capacitor arrays deliver cost-effective filtering, increased yields and an unlimited range of cap values.

**CIRCLE 132**

## TransGuard™

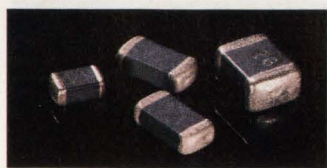

- Low voltage transient suppressors (5.6v to 60 vdc).
- Miniature SMT case sizes 0805, 1005, 1206, 1210.
- High peak current capability 40 to 300 Amps.
- Sub-nanosecond response time.
- High reliability avionic and commercial versions available.

**CIRCLE 133**

## Switch Mode Power Supply Capacitors **SupraCap™**

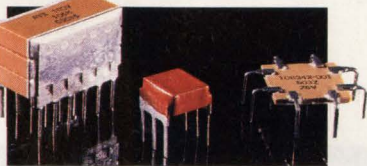

- Lowest ESR and ESL available.
- Highest current carrying capability.
- Supplied with lead frames for through-hole or surface mount assembly.
- Can be built in any shape or form factor.
- For high frequency power applications—SupraCap™ MLCs have less than 20 pico Henries Inductance.

**CIRCLE 134**

## EMI/RFI Filters



- All filters constructed with rugged MLC discoidal capacitors.
- Smallest available hermetically-sealed filters.
- Custom designed multicircuits, filter brackets and cylindrical filters meet mil spec MIL-F-28861 or MIL STD-461, NASA SSQ drawing and other EMI specifications.

**CIRCLE 135**

# WE PREFER THE STRONG, SILENT TYPE.

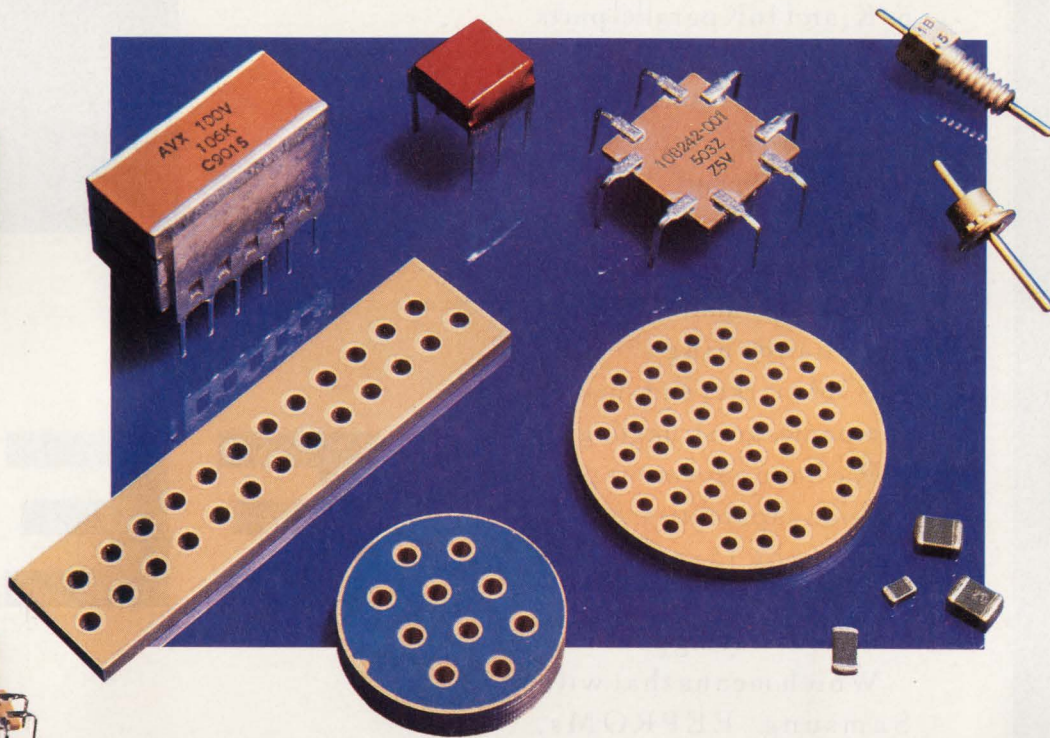

With their solid construction and ability to silence EMI/RFI, these Advanced Products are quietly becoming the number one choice of design engineers.

Their variety of sizes and configurations allow easy implementation at the critical design stage—whatever your application. They're proven effective in helping design engineers meet the FCC's EMI/RFI standards. And as with all our products, they come backed with the worldwide service and reliability that can only come from AVX.

From capacitors and resistors to resonators and piezo devices, AVX offers the broadest line of passive components in the world.

So, the next time your design demands a product to reduce EMI/RFI, call on one of these Advanced Products. And enjoy the silence.

For more information, contact AVX Corporation at (803) 448-9411, or fax us at (803) 448-1943. Write to AVX Corporation, 17th Avenue South, P.O. Box 867, Myrtle Beach, SC 29577.

**AVX** CORPORATION  
A KYOCERA GROUP COMPANY

S A M S U N G  
**NOW**

Once you've been able to see the Samsung line of EEPROMs, it's plain as day that it's the broadest line available.

In commercial and industrial grades—and from 256K, 64K, and 16K parallel parts down to serial chips in many organizations—the Samsung EEPROM line represents a true commitment.

Which is good news.

Particularly at a time when major manufacturers are abandoning the EEPROM market and smaller companies are struggling.

We have enormous production capabilities. And as one of the largest chip makers in the world, also enormous staying power.

Which means that with Samsung EEPROMs, you're assured of a supply that's just not going to be threatened.

In the all-important 256K EEPROM, we are the only offshore supplier, and probably the only large manufacturer to offer it.

Both our 256K and 64K

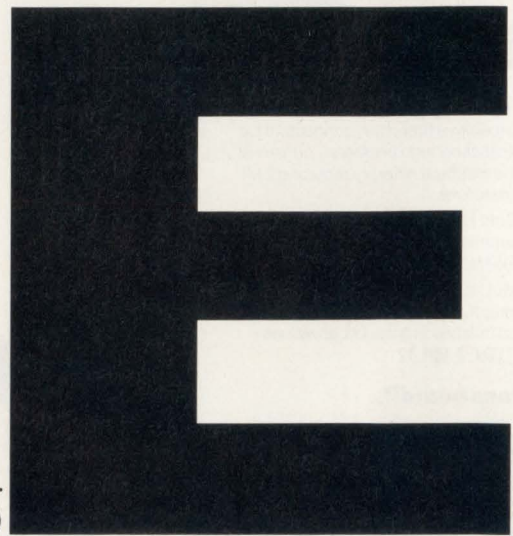

28C256



28C65 PROM 28C65A



28C64A PROM 28C16 PROM 28C17

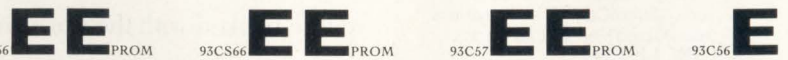

93C66 PROM 93C66 PROM 93C57 PROM 93C56

**IF YOU'RE NOT FINDING THE  
LINE, MAYBE YOU SHOULD**



# E PROM

E PROM 28C64 E E PROM

E PROM 29C010 EE PROM 93C67 EE PROM

E PROM 93CS56 EE PROM 93C46 EE PROM 93C46V EE PROM

chips are available with a high, 100K cycle rating. We will introduce the 1-meg EEPROM late this year. And in the flash EEPROM category, we're in development up to 8-meg right now.

Many of our serial parts are available in low voltage. On our 2K and 4K serial parts, we offer a secure access feature. And across our entire line of both parallel and serial EEPROMs, our parts are available with industrial ratings.

If you make mainframes, or switching systems, or modems, or anything else that uses EEPROMs and is going to keep doing it—look no further for a supplier with the staying power you need. For data, contact us now at 1-800-423-7364 or (408) 954-7229.

Or write to EEPROM Marketing, Samsung Semiconductor, 3725 No. First St., San Jose, CA 95134.



*Technology that works for life.*

## INDUSTRY'S BROADEST EEPROM HAVE YOUR EYES CHECKED.

CIRCLE 278 FOR U.S. RESPONSE  
CIRCLE 279 FOR RESPONSE OUTSIDE THE U.S.

## SWITCHING-REGULATOR ICs

cation point of view, they belong to the same genre. The MAX610 and MAX612 use a resistor, or a resistor and a capacitor, to limit input current and drop the line voltage (*Fig. 5*). The MAX611 uses a low-cost step-down transformer inserted between it and the ac line. The ac input is rectified, applied to a Zener diode in parallel with a filter capacitor, and applied to a linear (series-pass) regulator. All three are rated for output currents to 50 mA. A jumper between the output (pin 6) and sense pin (pin 5) sets the output of the MAX610 and MAX611 at 5 V. A resistive divider to the  $V_{set}$  pin sets the output of the former device between 1.3 and 9 V, and the output of the latter device between 1.3 and 15 V.

The output of the overvoltage/undervoltage pin (pin 3) goes low if the voltage at the sense pin is less than 4.65 V or greater than 5.4 V, regardless of the output voltage (it will be low all of the time if 5 V isn't the set output). A resistor in series with the output will force the pin low to indicate an overcurrent condition. The MAX611 has a fixed 5-V output, but a capacitor hung on what are its sib-

### A SAMPLING OF SWITCHING-REGULATOR IC SUPPLIERS

<p><b>Harris Semiconductor Corp.</b> Melbourne, Fla. Alan Moore (407) 724-3886 <b>CIRCLE 571</b></p>	<p><b>National Semiconductor Inc.</b> Santa Clara, Calif. Parag (Coco) Patel (408) 721-7509 <b>CIRCLE 575</b></p>	<p><b>SGS-Thomson Inc.</b> Phoenix, Ariz. (602) 867-6100 <b>CIRCLE 578</b></p>
<p><b>Linear Technology Corp.</b> Milpitas, Calif. Bob Scott (408) 432-1900 <b>CIRCLE 572</b></p>	<p><b>Power Integrations Inc.</b> Mountain View, Calif. Doyle Slack (415) 960-3572 <b>CIRCLE 576</b></p>	<p><b>Semtech Corpus Christi</b> Corpus Christi, Texas Ken Bretsch (512) 289-0403 <b>CIRCLE 579</b></p>
<p><b>Maxim Integrated Products Inc.</b> Sunnyvale, Calif. Chris Neil (408) 737-7600 <b>CIRCLE 573</b></p>	<p><b>Raytheon Co., Semiconductor Div.</b> Mountain View, Calif. (415) 968-9211 <b>CIRCLE 577</b></p>	<p><b>Siliconix Inc.</b> Santa Clara, Calif. Bill Numann (408) 970-5202 <b>CIRCLE 580</b></p>
<p><b>Motorola Inc.</b> Phoenix, Ariz. Bob Benzer (602) 897-3840 <b>CIRCLE 574</b></p>		<p><b>Texas Instruments Inc.</b> Dallas, Texas Ken Durham (214) 997-3382 <b>CIRCLE 581</b></p>

lings'  $V_{set}$  pin creates a delay in the out-of-voltage circuit's operation. The pin can provide a shutdown and power-up reset flag for a microprocessor. All three chips come in 8-pin DIPs and go for \$2.58 each in 1000-unit lots.

In principle, the isolated off-line SRICs from Power Integrations and

Siliconix employ current-mode PWM flyback topologies with transformer coupling. Like the LTC LT1070, they use the rectified flyback pulse to sense the output voltage (its height is a function of the output voltage) when in an isolated-flyback mode. Thus, they don't require an optocoupler between output and input.

### TABLE 2. REPRESENTATIVE LOW-POWER, LOW-VOLTAGE, SWITCHING-REGULATOR ICs

Specifications	Units	MAX654/55/57/59	MAX631/32/33	MAX638	MAX635/36/37	ICL644/46/47	ICL645
		(Maxim)			(Harris Semiconductor)		
Basic topology	na	Boost	Boost	Buck	Invert	Boost	Boost
Switch current	A	1.5	0.425	0.525	0.525	1.5	1.5
Supply-voltage range	V	1.1-5.6	2-16.5	5-16.5	2.3-16.5	1.1-5.6	2.6-3.6
Output voltage	V	5/5/3/3 (fixed)	5/12/15 (fixed) 2-16.5 (adj.)	5 (fixed) 1.3-15 (adj.)	-5/-12/-15 (fixed) -1.3 to -16 (adj.)	5/5/3 (fixed)	5 (fixed)
Frequency (nominal)	kHz	18	50	65	50	18	18
$I_q$ (run/sleep)	mA	na/0.08 (654/655) na/0.04 (657/659)	0.4/na (631) 2/na (632) 2.5/na (633)	0.6/na	0.5/na	na/0.08 (644) na/0.08 (640) na/0.08 (647)	0.04/na
External parts	na	6	2 (fixed), 4 (adj.)	3 (fixed), 5 (adj.)	4 (fixed), 5 (adj.)	6	6
Price	na	\$3.35	\$2.45	\$2.45	\$2.45	\$3.35	\$3.35
Package	na	16	3	3	3	16	16
Control mode	na	Pulse skipping	Pulse skipping	Pulse skipping	Pulse skipping	Pulse skipping	Pulse skipping
Other topologies	na	na	na	na	na	na	na
Features	na	20,23,25,32,33,34,35	20,33,35,37	20,32,33,34,35	20,33,35,37	20,23,25,32,33,34,35	20,23,25,32,33,34,35

#### FOOTNOTES FOR ALL DEVICES

All specifications are maximums or minimums at 25°C, unless noted as (t) for typical or noted as nominal.

**Package types:** 1 = 4-pin TO-3; 2 = 5-pin TO-220; 3 = 8-pin plastic DIP; 4 = 8-pin ceramic DIP; 5 = 8-pin SO; 6 = 11-pin power SIP; 7 = 16-pin DIP; 8 = 24-pin SOIC; 9 = 16-pin SOIC; 10 = 16-pin power DIP; 11 = 15-pin power SIP; 12 = 7-pin power SIP; 13 = 18-pin power DIP; 14 = 8-pin TO-3; 15 = 9-pin power SIP; 16 = 14-pin DIP.

**Other topologies:** 10 = Buck; 11 = Flack; 12 = isolated flack; 13 = forward; 14 = inverting; 15 = "Cuk"; 16 = boost; 17 = positive to negative; 18 = negative boost.

**Features:** 20 = on-chip timing; 21 = pulse-to-pulse current limiting; 22 = soft start; 23 = external shutdown (sleep mode); 24 = synchronizable; 25 = high/low-voltage output flag; 26 = undervoltage lockout; 27 = programmable-current limit; 28 = on-chip compensation; 29 = thermal shutdown; 30 = design software; 31 = line and load regulation guaranteed; 32 = output voltage guaranteed; 33 = no compensation needed; 34 = overvoltage crowbar; 35 = low-battery flag; 36 = power-ready flag; 37 = charge pump for negative voltages. na = not applicable; ns = not specified.

# Live Long.

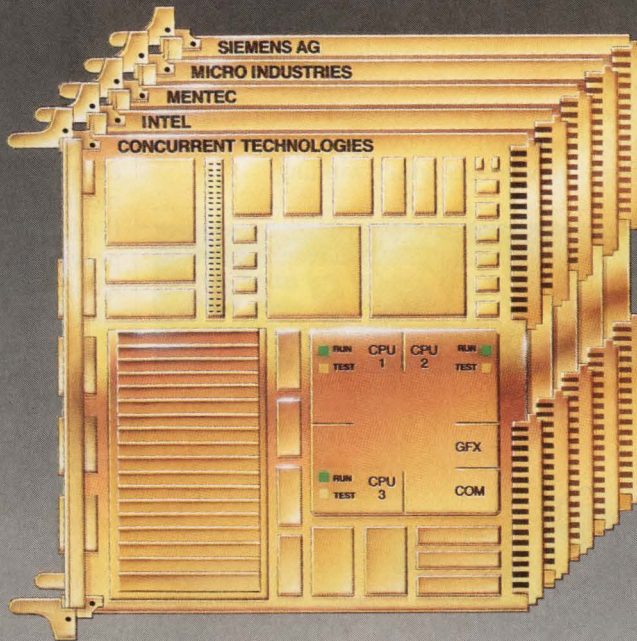

# And Prosper.

## MULTIBUS II

It is logical to choose the bus architecture that will deliver the greatest return on your development investment, for the longest possible time.

- Today's Multibus II not only gets you to market quickly, with higher performance and superior reliability. But of all available buses, only Multibus II provides the performance headroom to effectively absorb silicon advances through the 1990s, to protect your investment long into the future.
- During the past year Multibus II has grown faster than any other open architecture. One third more

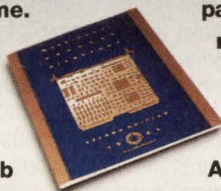

vendors have expanded the range of available Multibus II boards, systems, software and packaging products by nearly 40 percent!

- You can explore the world of Multibus II with your free copy of the new 1991 *Multibus II Product Directory*. Just send your business card to the MMG.
- And, contact the enterprising manufacturers listed below for complete information on Multibus II products that will transport you into the future. ■ Discover Multibus II. Your application will live long. And you will prosper.

#### CONCURRENT TECHNOLOGIES

Jerry Hoffman 217-356-7004 FAX 217-356-6238  
**NEW!** i486 CPU Board/Communications Controller

#### INTEL

Call 800-548-4725  
**NEW!** High integration 33 MHz i486 CPU board

#### MENTEC

Ralph Shaw 800-446-6762 FAX 614-548-6184  
**NEW!** i860-based SBC running UNIX System V Rel. 4

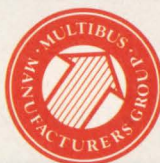

#### MICRO INDUSTRIES

Bill Jackson 800-446-6762 FAX 614-548-6184  
**NEW!** i960-based RISC development board

#### SIEMENS AG

Dr. Klaus P. Killian, Germany 089 4144 5737 FAX 089 4144 5841  
**NEW!** Scalar CPU board with Hard-Realtime Unix

MULTIBUS MANUFACTURERS GROUP

© COPYRIGHT 1991 MULTIBUS MANUFACTURERS GROUP

P.O. BOX 6208, ALOHA, OREGON 97007, 503-696-7155

## SWITCHING-REGULATOR ICs

They also use this rectified voltage to power the chip after startup. To improve accuracy, Power Integrations recommends using a coupled inductor to eliminate the spike on the leading edge of the flyback pulse (Fig. 6). The spike raises the effec-

tive value of the feedback voltage. The inductor consists of a small toroid with a single "primary" turn, and several secondary turns. The "primary" is created by slipping the toroidal core over the transformer's power secondary winding.

To drop and regulate the input voltage, both the Siliconix and Power Integrations chips use MOSFETs as linear preregulators during startup. The Siliconix chip uses conventional enhancement-mode FETs; the Power Integrations chip uses depletion-mode FETs. In addition, like many of the latest controllers, but unlike the previously discussed SRICs, these chips can run at switching frequencies to 1 MHz.

The five-member Power Integrations family (PWR-SMP3/110/120/210/400) consists of chips that can control between 3 and 20 W from the rectified 115-V ac line, and 10 W from the rectified 220-V ac line (see the photo, p. 53). A companion controller, the PWR-SMP520, using an external power MOSFET, supplies 20 W from the 220-V ac line. The 115-V ac chips handle dc inputs from 36 to 200 V; the 220-V chips dc inputs from 74 to 400 V. The PWR-SMP400, aimed at 48-V telecommunications applications, handles dc input voltages from 30 to 100 V. Because a transformer is used, output voltage and currents are strictly a function of the controlled power. For example, the 20-W devices could provide close to 4 A at 5 V or 200 mA at 100 V. In addition, multiple outputs are possible. All of the devices are available in 16-pin power DIPs. Pricing ranges from \$1.63 each to \$2.63 each in 1000-unit lots.

The Siliconix family is primarily aimed at telecommunications applications. It has four very similar members, the 3-W, 10-to-70-V-input Si9100/Si9101 (1%/10% reference accuracy); the 3-W, 10-to-120-V-input Si9102; and the 1-W, similarly-rated Si9105. They also have a pair of companion controllers, the Si9110/Si9111, which can handle 10 to 120 V. The regulators come in 14-pin DIPs and 20-pin PLCCs; the controllers in 14-pin DIPs and SOICs. In quantities of 1000, pricing ranges from \$3.87 to \$5.04 each. □

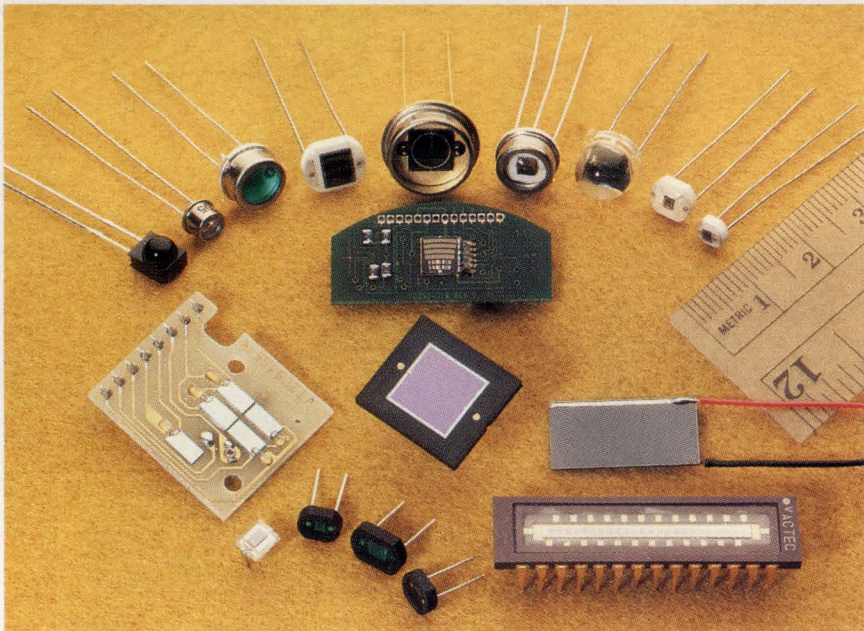
## HIGH QUALITY/ LOW COST STATE-OF-ART PERFORMANCE

EG&G Vactec's complete line of planar silicon photodiodes—the cost-effective way to detect light, from ultra-violet through near-infrared.

Excellent linearity in output signal versus light intensity, low noise, and fast speed of response often make them the ideal detector for automotive, communications, and medical instrumentation applications. They are used in smoke detectors, cameras, security systems, X-ray detection

equipment, flame monitors, encoders, bar code scanners, colorimetric analysis equipment, and other products.

Stock and custom devices are available packaged as discretes or configured into arrays, screened or modified to meet particular demands.

Call or write for new catalog:

EG&G Vactec, Inc.

10900 Page Blvd. ■ St. Louis, MO 63132

(314) 423-4900 ■ TWX 910-764-0811 ■ FAX 314-423-3956

CIRCLE 246 FOR U.S. RESPONSE  
CIRCLE 247 FOR RESPONSE OUTSIDE THE U.S.

### HOW VALUABLE?

HIGHLY  
MODERATELY  
SLIGHTLY

### CIRCLE

544  
545  
546

# SPEC THE BEST! USER CONFIGURABLE SWITCHING POWER SUPPLIES



Meets IEC 555-2

- User Adjustable Wide Range Outputs
- 2V to 56VDC Outputs
- 200 to 3000 Watts
- 1 to 9 Outputs
- Auto Current Share (N + 1)
- New -- Three Year Warranty

Spec Qualidyne -- and expect power supply flexibility. Qualidyne designs and builds custom models tailored to your specific volt/amp output requirements or delivered with a wide range of user adjustable outputs -- for the ultimate in flexibility. Options and features include automatic current sharing, input & output status signals, integral DC ball-bearing fan, margining, inhibit, 0.99 PFC, and DC input.



High Power

- Compact: 5 x 5" or 5 x 8" Cases
- 750 to 3000 Watts
- AC or DC Inputs
- 1 or 3-Phase AC
- Auto Current Share (N + 1)



Low Profile

- Compact: 2" to 3" High
- 250 to 1000 Watts
- Single & Multi-Outputs
- 2V to 56V Outputs
- Auto AC Line Selection

0.99 Power Factor Option

AC to DC Switchers

DC to DC Converters

### Multi-Output Models-3, 4, or 5 outputs (Partial Listing)

Size (HxWxL)	Total Watts	Output Voltage Range/Max. Amps				
		Output 1	Output 2	Output 3	Output 4	Output 5
2.5x5x6.5"	200W	2-6V/25A	5-15V/3A	5-15V/3A		
2.5x5x11"	400W	2-6V/60A	5-15V/12A	5-15V/12A	12-28V/7A	
2.5x5x11"	400W	2-6V/60A	5-15V/12A	5-15V/12A	2-6V/12A	
2.5x5x11"	400W	5-15V/24A	5-15V/12A	2-6V/12A	2-6V/12A	
2.5x5x11"	400W	12-28V/15A	5-15V/12A	5-15V/3A	5-15V/3A	2-6V/12A
3x5x14.25"	600W	5V/80A	5-24V/10A	5-24V/10A	5-24V/5A	5-24V/5A
4x5x14.25"	750W	5V/100A	5-15V/20A	5-15V/20A	5-24V/5A	5-24V/5A
5x5x11.5"	1000W	5V/120A	5-15V/20A	5-15V/20A	5-24V/5A	5-24V/5A
5x8x11"	1000W	5V/150A	5-15V/20A	5-15V/10A	5-15V/10A	5-24V/10A
5x8x13.75"	2500W	5V/400A	5-15V/20A	5-15V/20A	5-24V/10A	5-24V/10A

### Single Output Models (Partial Listing)

Size (HxWxL)	Total Watts	Output Voltage Range/Max. Amps (select one)				
		2-4VDC	4-6VDC	7-12VDC	12-28VDC	28-56VDC
2.5x5x6.5"	200W	2-6V/40A	2-6V/40A		12-28V/7A	
2.5x5x8.4"	400W	2-6V/80A	2-6V/80A		12-28V/15A	
3x5x14.25"	600W	2-4V/150A	4-6V/120A	7-12V/50A	12-28V/22A	28-56V/11A
5x5x11.5"	1000W	2-4V/250A	4-6V/200A	7-12V/84A	12-28V/36A	28-56V/18A
5x8x11"	1000W	2-4V/250A	4-6V/200A	7-12V/84A	12-28V/36A	28-56V/18A
5x8x15.5"	3000W	2V/700A	5V/600A	12V/250A	24V/125A	48V/65A

### FREE CATALOG

Complete line of quality power supplies from 100 to 3000 Watts.



**Qualidyne**  
Lambda Group of Unitech plc

3055 Del Sol Blvd., San Diego, CA 92154  
(619) 575-1100 fax: (619) 429-1011

CIRCLE 124 FOR U.S. RESPONSE

CIRCLE 125 FOR RESPONSE OUTSIDE THE U.S.

Some people  
think we're  
power crazy,  
obsessed  
with quality  
and downright  
cheap.

# And it's all true.

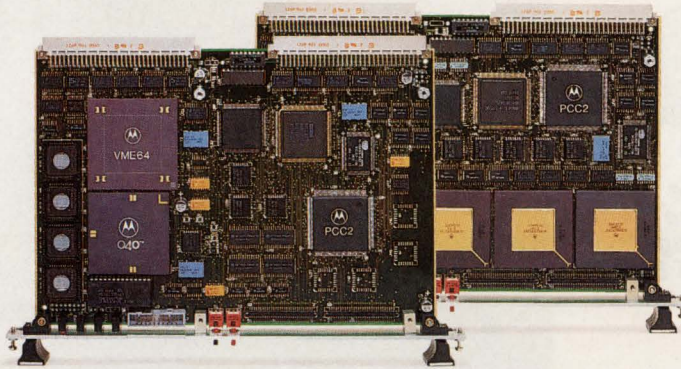

Okay, we admit it. We're hopeless perfectionists. Driven to produce the best boards at the best price.

Take our new MVME187 and MVME167 single board computers, for instance. Best in performance at 23 MIPS (RISC) and 20 MIPS (CISC), respectively. Best in value at \$174 (RISC) and \$200 (CISC) per MIPS.

Which comes out to just \$3,995 per board. And which compares rather nicely with the \$8,000 to \$12,000 you could pay for the competition's boards.

Based on the 88100 and 68040, Motorola's highest performance

32-bit microprocessors, the MVME187

and MVME167 employ VME D64 architecture. Boosting the VMEbus bandwidth to a full 40MB/s. And both boards come with four 32-bit timers, as well as SCSI and Ethernet connections.

Naturally, since they're made by Motorola, you can expect the best in quality. The Malcolm Baldrige Award is a powerful testament to that fact.



So call 1-800-234-4VME for a free color brochure. And see why so many people are obsessed with Motorola products.



**MOTOROLA**  
Computer Group

For a free brochure, call 1-800-234-4VME.

Motorola and the (M) are registered trademarks of Motorola, Inc. ©1991 Motorola. All rights reserved.

**CIRCLE 154 FOR U.S. RESPONSE**

**CIRCLE 155 FOR RESPONSE OUTSIDE THE U.S.**

# FASTEST IMAGE PROCESSING ON A SINGLE PC/AT BOARD

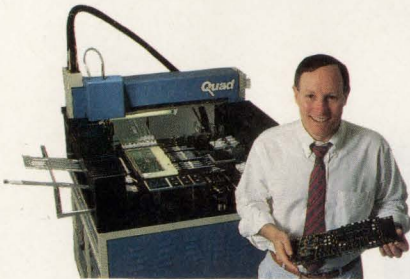

**"Our DT2867 Integrated Image Processor combines real-time processing and precision image acquisition on a single PC/AT board."**

—Fred Molinari, President

#### Real-Time Processing

- 75 MHz, 16-bit processor
- Simultaneous acquisition and processing

#### Precision Image Acquisition

- Programmable gain, offset, and reference
- Square pixels

#### Optional 32-Bit, 25 MFLOP DSP Board

- 10 MHz DT-Connect™ interface to DT2878 Advanced Processor

#### Extensive Development Software Included

- Subroutines callable from Microsoft C
- Device driver and utilities

#### Quantity pricing available

#### FAST 5 day delivery

Call for FREE Catalog

**(508) 481-3700**

In Canada, call (800) 268-0427

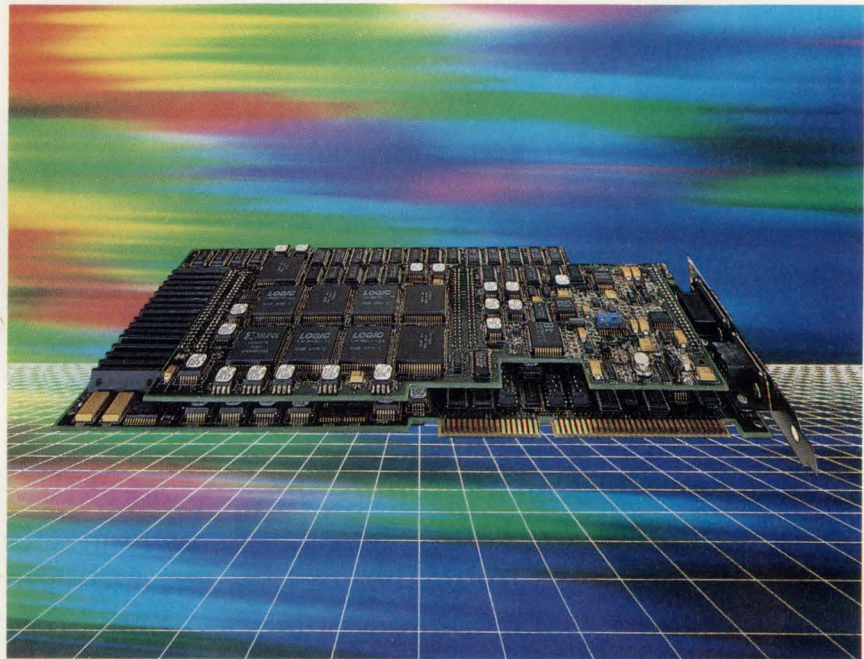

#### DT2867 Processing Times

Full 640 x 480 image

True Frame Averaging (to 256 frames)	real-time
Histogram	real-time
Math and Logic	real-time
3 x 3 Binary Morphology	.043 sec
3 x 3 Convolution	.043 sec
7 x 7 Convolution	.30 sec

THE LEADER IN DATA ACQUISITION AND IMAGE PROCESSING

# DATA TRANSLATION®

**World Headquarters:** Data Translation, Inc., 100 Locke Drive, Marlboro, MA 01752-1192 USA, (508) 481-3700, Fax (508) 481-8620, Tlx 951646

**United Kingdom Headquarters:** Data Translation Ltd., The Mulberry Business Park, Wokingham, Berkshire RG11 2QJ, U.K., (734) 793838, Fax (734) 776670, Tlx 94011914

**Germany Headquarters:** Data Translation GmbH, Im Weileren 10, 7120 Bietigheim-Bissingen, Germany 7142-54025, Fax 7142-64042

**International Sales Offices:** Australia (2) 699-8300; Belgium (2) 466-8199; Brazil 11 240-0598; Canada (416) 625-1907; China (1) 513-7766 x 1222; Denmark 2 274511; Finland (0) 3511800; France (1) 69077802; Greece (1) 361-4300; Hong Kong (5) 448963; India (22) 23-1040; Israel 52-545685; Italy (2) 82470.1; Japan (3) 502-5550, (3) 5379-1971; Korea (2) 718-9521; Netherlands (70) 399-6360; New Zealand (9) 415-8362; Norway (2) 53 12 50; Poland (22) 580701; Portugal 1-7934834; Singapore 338-1300; South Africa (12) 803-7680; Spain (1) 555-8112; Sweden (8) 761 78 20; Switzerland (1) 723-1410; Taiwan (2) 3039836

DT-Connect is a trademark and Data Translation is a registered trademark of Data Translation, Inc. All other trademarks and registered trademarks are the property of their respective holders.

CIRCLE 184 FOR U.S. RESPONSE

CIRCLE 185 FOR RESPONSE OUTSIDE THE U.S.



BASIC TECHNIQUES LET DESIGNERS  
BUILD A FINITE-IMPULSE-RESPONSE  
FILTER IN DEDICATED HARDWARE  
USING PROGRAMMABLE LOGIC.

# LEARN THE FUNDAMENTALS OF DIGITAL FILTER DESIGN

**H**istorically, designers often have taken an analog approach to filtering. Filters were constructed using operational amplifiers, resistors, and capacitors. One op amp could implement a second-order filter, and higher-order filters could be implemented by cascading second-order filters. However, passive components with tolerances of 1% or better are necessary for the filter to have reproducible characteristics. And the filter is typically fine-tuned by trial-and-error substitution of available component values. In addition, operational amplifiers with a high gain-bandwidth product may be needed to keep undesirable phase shift to a minimum or keep a closed-loop system stable. These factors are among the many problems in real-world implementations of filters.

With the advances made in digital-signal processing, however, digital filters are becoming a more attractive design alternative to traditional analog techniques. Because digital-system information is in digital form, filtering can be accomplished relatively easily by passing the data through a filter algorithm. In addition, digital filters have the advantages of no filter-characteristic drift over time, temperature, or voltage. And they can easily be designed to filter low-frequency signals. Moreover, the filter response can be made to closely approximate the ideal response, and linear phase characteristics are possible.

There are many well established methods of determining the filtering algorithm. Basically, the designer establishes the desired filter characteristics, thereby yielding a filter transfer function. The continuous-time transfer function is then transformed to the equivalent linear discrete-time-difference function. This function in the Z domain has the general form of:

$$G(Z) = (A_0 + A_1Z^{-1} + A_2Z^{-2} + \dots + A_nZ^{-n}) / (1 + B_1Z^{-1} + B_2Z^{-2} + \dots + B_mZ^{-m}) = Y(Z)/X(Z)$$

The equation is referred to as the pulse transfer function. It's actually the Z transform of the continuous-time filter's unit impulse response. Conversely, the inverse Z transform of the pulse transfer function yields the impulse response of the filter.

The coefficients  $A_n$  and  $B_m$  determine the response of the digital filter. Changing

**MIKE TRAPP**

Lattice Semiconductor Corp., Carlsbad Pacific Center One, 701 Palomar Airport Rd.,  
Third Floor, Carlsbad, CA 92009; (619) 931-4751.

## DIGITAL FILTERS

the coefficients changes the response of the filter. The terms  $Z^{-n}$  and  $Z^{-m}$  represent sampling delays or taps. The  $G(Z)$  equation represents the algorithm of sampling the input, multiplying it by  $A_0$ , and adding it to the previous sample that's been multiplied by  $A_1$ , then adding that value to the next previous sample which has been multiplied by  $A_2$ , and so on. An output value occurs when all  $N$  values have been multiplied and accumulated.

In parallel, each output value is stored, multiplied by  $B_1$ , then added to the previous output value which has been multiplied  $B_2$ , and so on. The equation can be rearranged so that the result of the output multiply accumulate is added to the result of the input multiply accumulate to produce an output. This procedure is referred to as convolution. An output sample is produced for every input sample (Fig. 1).

The key to digital-filter design is to determine the filter coefficients that will produce the desired frequency response. Recursive digital filters, or infinite-impulse-responsive (IIR) filters, are a type of digital filter in which the design methodology closely follows that of an analog filter. One method for determining the coefficients is to define a realizable

continuous-time domain Chebyshev, Butterworth, or equal-ripple filter then use  $Z$  transforms to transform the continuous-time-domain transfer function to the equivalent discrete-time transfer function that yields the filter coefficients.

A second popular method is the bilinear transform. In this method, engineers first design an analog filter so that after it's transformed to a digital filter, the resulting filter meets a set of desired digital-filter specifications. This analog filter is then transformed to a digital filter via the bilinear transform from the  $S$  variable of the Laplace transform to the  $Z$  variable of the  $Z$  transform.

In a non-recursive digital filter or finite-impulse-response (FIR) filter, the output is computed using the present input  $X_n$  and the previous inputs  $X_{n-1}, X_{n-2} \dots X_{n-N}$ . This implies that the coefficients,  $B_m$ , are all 0, and there's no feedback from the output. Designing non-recursive digital filters (FIR) involves defining an ideal desired frequency response from which the ideal impulse response is computed. The ideal impulse response is truncated to a finite number of non-zero samples using a windowing function, which is judiciously chosen. A common windowing function is the Kaiser window function.

An interesting property of FIR filters is that if an FIR system has linear phase, then its frequency response is constrained to be zero at  $f = 1/2T$ , where  $T$  equals the sampling frequency if:

$$h[M - n] = h[n] \text{ and } M \text{ is odd. (} M = \text{truncation length of the window).}$$

This implies the  $M$  should be even when designing high-pass and band-stop filters. Or,

$$h[M - n] = -h[n] \text{ and } M \text{ is even.}$$

A second method is the Parks-McClellan method. In this approach, the filter order and the edges of the passbands and stopbands are fixed, and the impulse-response coefficients are varied systematically so that an equal-ripple behavior is achieved in each approximation band. With this approach, the filter order can't be specified in advance. Therefore, a cut and try procedure must be used to find the minimum filter order. The cut and try can be reduced by using a formula that predicts the filter order required to meet a given set of specifications.

There are advantages and disadvantages to each type of digital filter (IIR and FIR). An FIR filter is always stable because there's no feedback from the output and the impulse response is finite. In addition, the amplitude and phase can be arbitrarily specified. On the other hand, an FIR filter will generally require more taps, and consequently more math, to compute the output value. The design methodology doesn't resemble the familiar analog design techniques.

An IIR will generally have fewer coefficients, but the required output feedback can make circuit implementation more complex. A stable IIR filter can become unstable if the coefficients aren't chosen properly to account for digital math errors.

There are four main type of errors that can arise in the design of digital filters. These are referred to as quantization errors. They are:

1. Quantization errors of the input analog-to-digital conversion
2. Quantization errors of the coefficients
3. Quantization errors due to arithmetic computations, including overflow
4. Limit cycles

In most cases, a 12-bit analog-to-digital converter (ADC) provides enough dynamic range and sufficiently small quantization noise. If floating-point numbers are used for the filter coefficients, the quantization error is usually small enough. However, floating-point arithmetic is more complex and more expensive

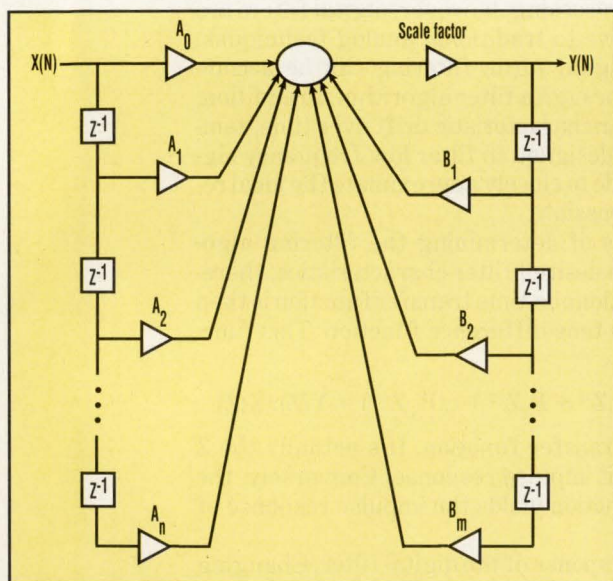

**1. IN THE FUNCTIONAL** structure of a digital filter, the  $A$  and  $B$  coefficients determine the response of the filter and the  $Z$  terms represent sampling delays called taps.

# Power Solutions



**Highest Power Density**  
**AC/DC and DC/DC to KiloWatts**  
**UL, CSA, VDE and TÜV**  
**Worldwide Support**

## VI-200™

- Inputs: 10 to 400 VDC
- Outputs: 2 to 95 VDC
- 50 to 200 Watts
- Booster expansion to kiloWatts
- Size: 4.6"L x 2.4"W x 0.5"H



*Worldwide Applications Support.*

**CIRCLE 140**

## MiniMod™

- Inputs: 10 to 400 VDC
- Outputs: 2 to 95 VDC
- 25 to 100 Watts
- Size: 2.28"L x 2.4"W x 0.5"H



**CIRCLE 212**

## AC Input Front Ends

- Converter interface for worldwide AC lines: 85 to 264 VAC
- Single and three-phase: 250 Watts to 5 kiloWatts and over
- PCB and Chassis mount
- Power status signals
- Transient protection and filtering

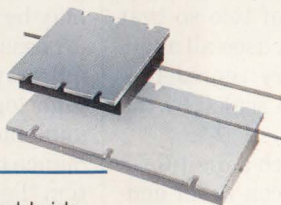

**CIRCLE 214**

## ComPAC™

- Inputs: 24, 48, and 300 VDC
- 1, 2 or 3 user-definable outputs
- Any output: 2 to 95 VDC
- Up to 600 Watts
- Transient protection and filtering for Telecom and Industrial
- Low profile: 0.99"

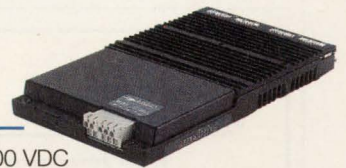

**CIRCLE 216**

## FlatPAC™

- Worldwide AC Input
- 1, 2 or 3 user-definable outputs
- Any output: 2 to 95 VDC
- Up to 600 Watts
- Transient protection and filtering to VDE/FCC Class A
- Low profile: 1.37"



**CIRCLE 218**

## StakPAC™

- Worldwide AC or DC Input
- Up to 8 user-definable outputs
- Any output: 2 to 95 VDC
- Up to 1200 Watts
- Transient protection and noise filtering
- High density packaging
- Fan cooled



**CIRCLE 220**

## PowerCage™

- Choice of single  $\phi$  and three  $\phi$  inputs
- 1 to 36 isolated outputs at up to 7200 Watts
- Size: 19"L x 10.5"W x 11.25"H
- Designed to meet UL, CSA and TÜV

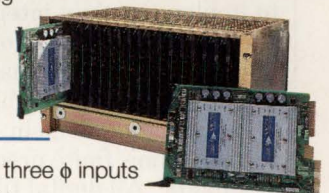

**CIRCLE 222**



*Call for further information.*

### Vicor Corporation

23 Frontage Road, Andover, MA 01810  
 TEL: (800) 735-6200 • FAX: (508) 475-6715

*Call for our complete catalog, including information on all products, applications and accessories.*

DESIGN APPLICATIONS  
**DIGITAL FILTERS**

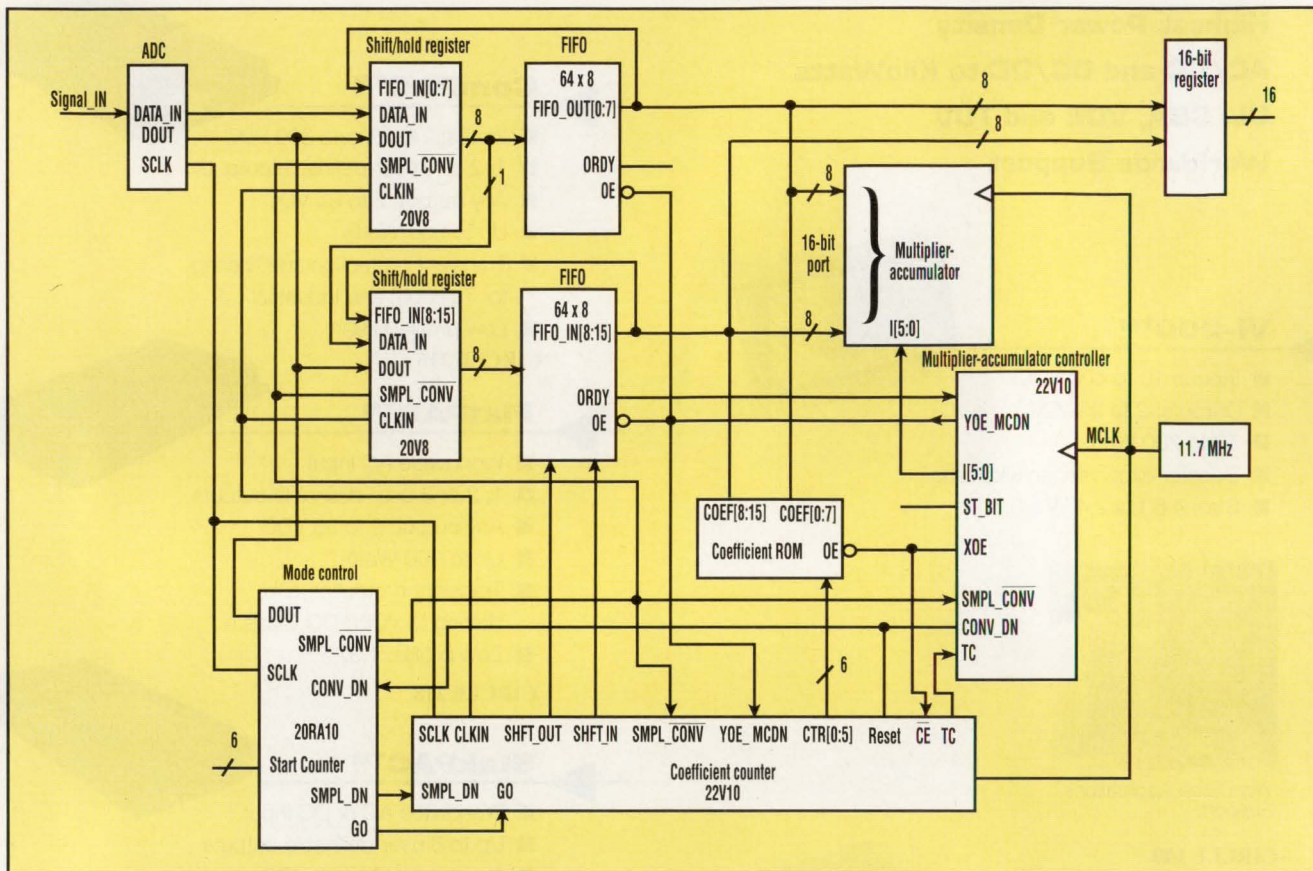

**2. AN FIR FILTER IS IMPLEMENTED** in a circuit that uses a single-port 16-bit multiplier-accumulator capable of a 85-ns clock speed. Because it's based on microcode, the multiplier-accumulator can be controlled with a PLD.

to implement than integer or fixed-point arithmetic. If 12- or 16-bit coefficient are used, the quantization error is generally negligible.

In the digital domain, math is performed using finite precision binary arithmetic. All digital filters need to multiply a signal sample by a constant coefficient. Of course, multiplying 2 N-bit binary numbers results in a 2N-bit result, but digital systems are usually confined to a fixed number of bits with which to represent binary numbers. Therefore, it's necessary to round off the 2N-bit digital number back to N bits. If a 32-bit multiply accumulator is used and the final output is rounded to 16 bits, the arithmetic quantization errors can be minimized.

If overflow occurs during mathematical operations, the digital filter can behave in a nonlinear fashion and oscillations can occur. Twos-complement arithmetic can help eliminate overflow. In addition, a satu-

rating adder can be used. If the coefficients are less than one, then the resulting product will also be less than one. Scaling is used to force this condition. The coefficient can be scaled by a multiple of two so that the largest coefficient uses all available bits in the binary representation. The input is then scaled by the same amount.

The detail with which a digital filter can be described can seem endless. Fortunately, a wide variety of computer programs exist that help the engineer with the filter's design. One such product is the DFDP software from Atlanta Signal Processing Inc. (ASPI), Atlanta, Ga.

Before a signal can be digitally filtered it must be digitized by an ADC. If a delta-sigma converter is used, the need for antialiasing filters (which must be analog and can be many orders) is virtually eliminated. Delta-sigma converters may have sample rates as high as 100 kHz. The

filter algorithm can then be implemented in software or hardware.

A single-chip microprocessor can be used to implement a digital filter in software. However, "single chip" may be misleading, because a microprocessor system will generally require system RAM, ROM, I/O, and glue logic. The microprocessor can implement low- to medium-performance digital filters if the only function they're performing is the digital filtering. As the work load of the microprocessor increases, its capability to digitally filter a signal in real time decreases. Once the system is designed, changing the filter's characteristics is as easy as changing variables in software and downloading the code to the system.

For higher performance and moderate flexibility, the filter can be implemented in dedicated hardware using programmable logic for design flexibility. The limiting parameter will be the time to do a multiply-accu-

# Sampling ADCs With Zero Power Dissipation\* Plus 100% Tested Dynamic Performance.

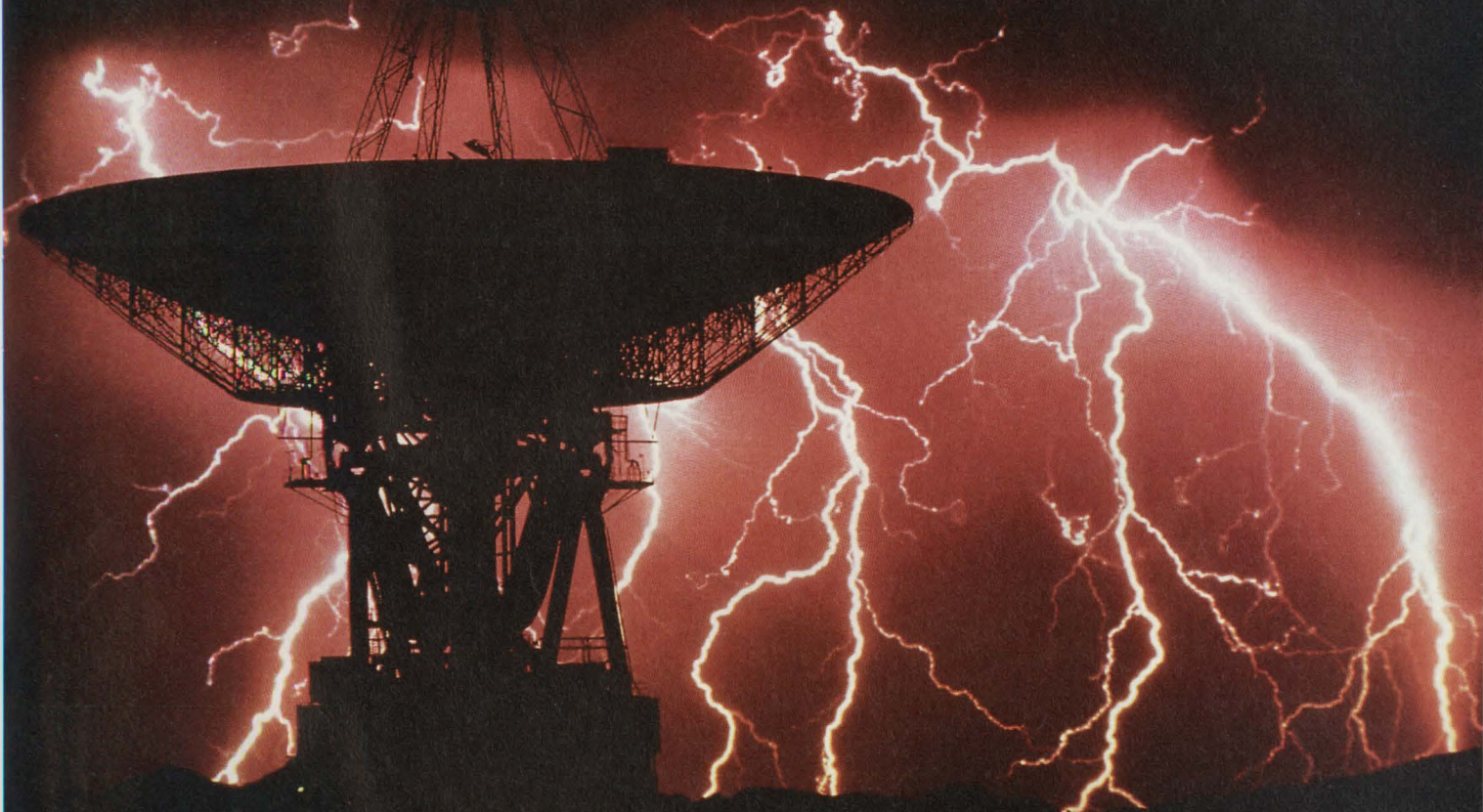

*Anybody can guarantee the dynamic performance of a Sampling ADC. Like most other ADC suppliers, Sipex understands what dynamic performance means to the final image, and ultimate success of your system. That's why we run all-codes and full dynamic production testing on 100% of our Sampling ADCs — to give you guaranteed dc and SNR, THD and SINAD ac dynamic performance.*

*But, Sipex's 100% tested performance comes with one very important difference — the lowest power dissipation in the industry.*

*\*While we can't give you these high performance SADCs with no power dissipation, one look at "their" power dissipation specs will show you ours are almost zero by com-*

*parison. Think what that will mean to system reliability.*

*Of course, the high-level of integration, with single-package ADC, Sample-and-Hold and reference gets you an easier design-in, and less pc board space.*

*When you're ready to design your next medical imaging, radar or other high performance system with the lowest-power SADCs available, let us know. We'll get you a data sheet and application note on either of these two high performance Sampling ADCs, and a unit to evaluate.*

*Which will get you convinced. 100%.*

**Sipex**  
Corporation

SIGNAL PROCESSING EXCELLENCE Sipex Corporation • 22 Linnell Circle • Billerica, MA 01821 • 1-800-272-1772 • (508) 667-8700

## 12-BIT/10MHZ (SP9560)

(25°C at Nyquist)

- 72dB Spurious-Free Range
- 70dB SNR
- 64dB SINAD
- 3.0 Watts



## 16-Bit/1MHz (SP9490)

(25°C @ 1MHz Sampling Rate)

- 90dB Spurious-Free Range
- 87dB SNR
- 85dB SINAD
- 2.7 Watts



16M  
DRAM

## Memories of Tomorrow

# 16M DRAMs. Available Today.

When it comes to memories, the future is now at NEC. We have the high-density, high-technology devices you need to develop next-generation products. And we're ready to ship them, today.

Our 16M DRAMs use a  $0.55\mu$  CMOS process to give you higher speed and higher integration. They offer a 70ns access time with Fast Access and Fast Page operating modes. Organizations are x1 and x4. Using sophisticated lead-on-chip technology, our 16M DRAMs come in 28-pin, 400-mil SOJ packages.

Swift development of new products is the key to success in tomorrow's fast-paced markets. To shorten your time-to-market, develop a partnership with the leader in memory technology. NEC has the resources to adapt speeds, organizations and package types to meet your system needs. For more information, contact NEC today.



## From the leader in memory technology

***For fast answers, call us at:***

USA Tel: 1-800-632-3531. Fax: 1-800-729-9288. Germany Tel: 0211-650302. Telex: 8589960. The Netherlands Tel: 040-445-845. Telex: 51923.  
Sweden Tel: 08-753-6020. Telex: 13839. France Tel: 1-3067-5800. Telex: 699499. Spain Tel: 1-419-4150. Telex: 41316. Italy Tel: 02-6709108. Telex: 315355.  
UK Tel: 0908-691133. Telex: 826791. Ireland Tel: 01-6794200. Fax: 01-6794081. Hong Kong Tel: 755-9008. Telex: 54561. Taiwan Tel: 02-719-2377. Telex: 22372.  
Korea Tel: 02-551-0450. Fax: 02-551-0451. Singapore Tel: 253-8311. Fax: 250-3583. Australia Tel: 03-267-6355. Telex: 38343.

CIRCLE 226 FOR U.S. RESPONSE

CIRCLE 227 FOR RESPONSE OUTSIDE THE U.S.

# NEC

DESIGN APPLICATIONS  
**DIGITAL FILTERS**

multimate function and the amount of physical space required for the hardware implementation of the taps. Consider a circuit that uses a single-port 16-bit multiplier-accumulator capable of an 85-ns clock speed (Fig. 2). The device can work in twos-complement numbers and has output saturation capabilities. As stated before, these two features are desirable when implementing digital filters. In addition, the device can be easily controlled with a programmable logic device (PLD) because it's microcoded based.

First, the system must initially load the first N (N = 64) samples into the FIFO before any convolution takes place. Otherwise, the FIFO would never fill up. A counter implemented in a 20RA10 works well. The 6-bit counter is implemented with the four least-significant bits implemented as an asynchronous counter. SMPL\_DN (ADC sample done) acts as the clock. The two most-significant bits are implemented as a ripple counter. This type of counter design makes it possible for a long counter to be implemented with only four product terms per output. The SMPL\_DN signal is also generated in the 20RA10, and is triggered off signals from the ADC.

When the counter reaches the value 63, indicating that the FIFO is full minus the one sample that's held in the shift/hold register, GO becomes true and the system begins to execute the filtering algorithm. Because the system is linking two asynchronous subsystems (ADC and the multiplier-accumulator), there must be an asynchronous interface between the two. The 20RA10 is utilized by generating one interface signal SMPL\_CONV (sample or convolve mode). The system powers up with this line held in the sample mode (SMPL\_CONV = 1). When GO goes true, synchronous with the falling edge of the clock from the ADC, SMPL\_CONV goes low asynchronously with MCLK (synchronous with SCLK). Because SMPL\_CONV is an input to the state machine, the machine could be subject to a metastable input. The Lattice CMOS PLDs are very high

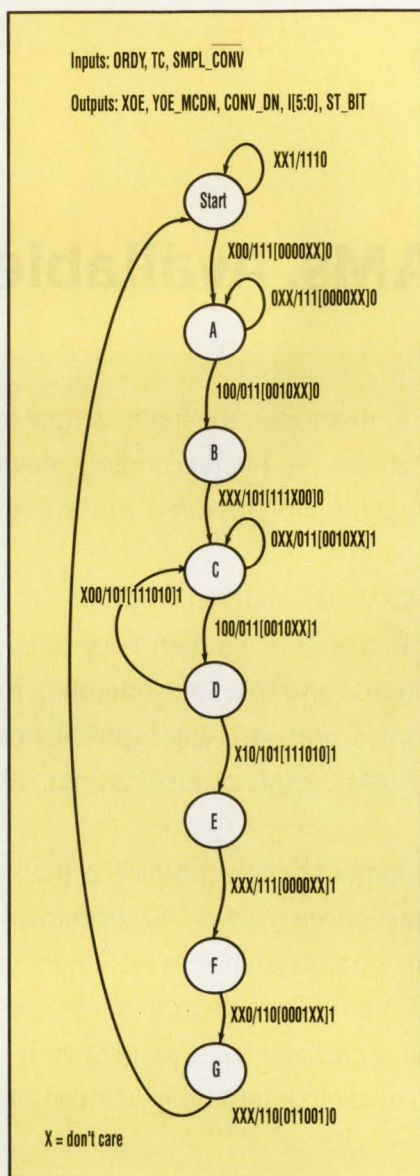

**3. AN 8-STATE** state machine implements the operations of loading a sample into the multiplier-accumulator, then loading the coefficients in and issuing the multiply-accumulate command until all N samples are done.

speed, so the metastable characteristics are excellent. That is, the state flip-flop has a very low probability of going metastable. Therefore, the state machine will have to wait, at most, one extra MCLK cycle before starting the convolution.

Once the convolution is started, the operations of loading a sample into the multiplier-accumulator, then loading the coefficient into the

multiplier-accumulator and issuing the multiply-accumulate command, can be repeated until all N samples have been done. At this time, the filter output is valid and the cycle is restarted. These steps can be implemented with an 8-state state machine (multiplier-accumulator controller) (Fig. 3).

By coding the states properly, the state variables out of the state machine can be used to directly control the multiplier-accumulator. Two output enable signals, XOE and YOE\_MCDN, control the data into the multiplier-accumulator. The signal CONV\_DN indicates that all N samples have been convolved. A dummy state variable (ST\_BIT) is used so that the state bit (XOE, YOE\_MCDN, CONV\_DN) can be employed as outputs. If the dummy bit was unused, two states would be forced to have the same state assignments, which isn't allowed. The design takes advantage of the power-up reset of Lattice's programmable logic devices (PLDs). After power-up, the registers will be left in the 0 state, which by careful design is also the start state of the state machine.

Except for the last SMPL\_DN during initial load, every time SMPL\_DN (sample done by the ADC) takes place, SHFT\_IN occurs to load sampled data from the shift/hold registers into the FIFO. During convolution, XOE occurs every time a coefficient is loaded to the multiplier-accumulator. The first XOE of a convolution causes the last data sample left in the shift/hold registers during initial load or sample mode to be shifted into the FIFO. Following every XOE is a YOE\_MCDN (Y-output enable, multiply-accumulate done). YOE\_MCDN causes data from the FIFO's output to be parallel loaded into the shift/hold registers. A single data sample is then shifted out of the FIFO. The system is ready for the next XOE that shifts in the data held in the shift/hold registers and so on. This loop continues until SMPL\_CONV (sample or convolve mode) goes to sample mode, at which time a new sample is loaded into the shift register, restarting the cycle.

Inputs to the state machine,



DESIGN APPLICATIONS  
**DIGITAL FILTERS**

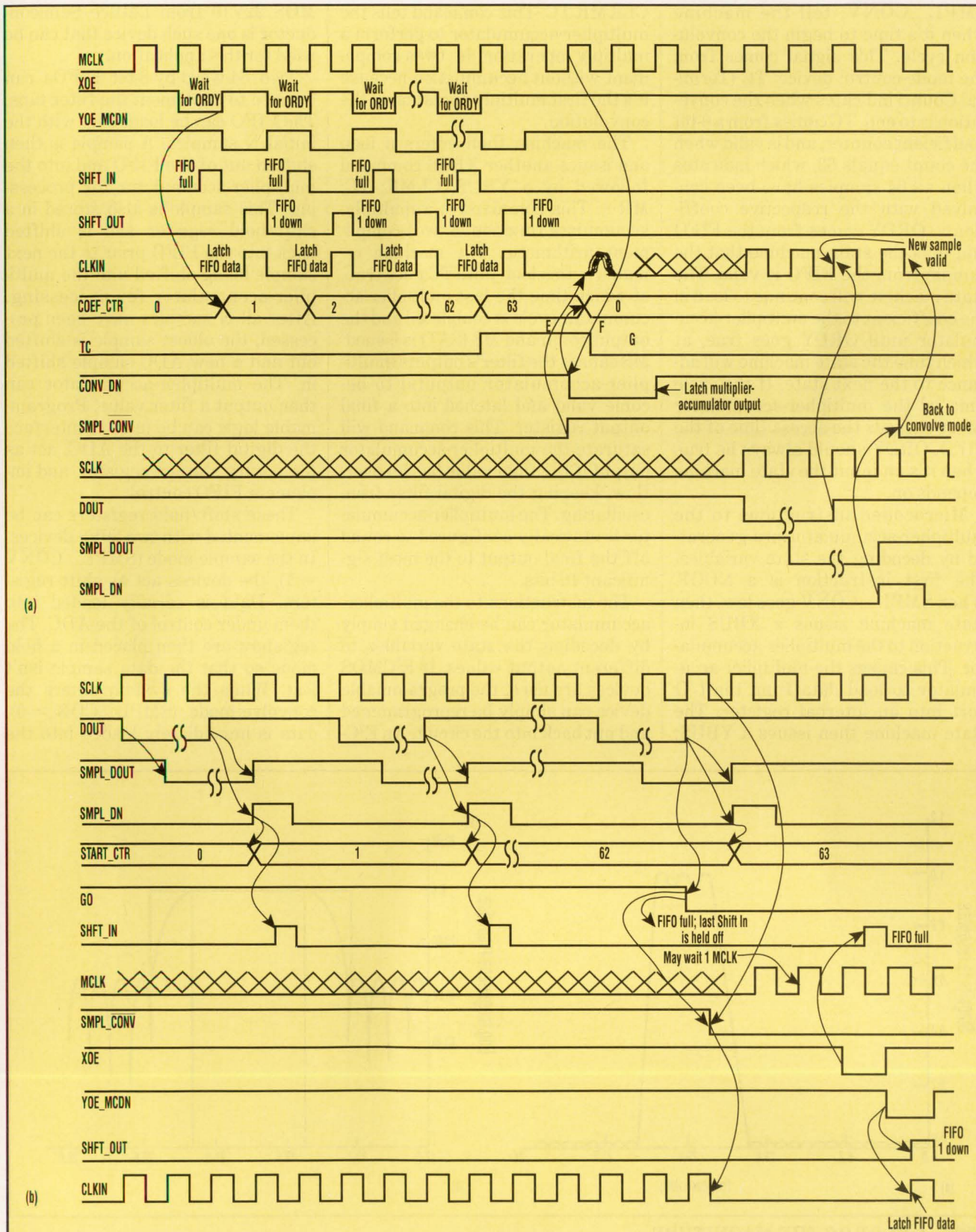

**4. FIFO CONTROL SIGNALS** are generated asynchronously. The system timing diagrams for the convolve (a) and initial load (b) operations show the appropriate Shift In and Shift Out signals, and clock signals sent to the shift/hold register.

## DIGITAL FILTERS

SMPL\_CONV, tell the machine when it's time to begin the convolution cycle. This signal comes from the mode-control device. TC (Terminal Count) indicates when the convolution is to end. TC comes from a 6-bit coefficient counter, and is valid when the count equals 63, which indicates when all 64 samples have been convolved with the respective coefficients. ORDY comes from the FIFO and tells the state machine that the sample from the FIFO is valid. The state machine will continue to load in the coefficient to the multiplier-accumulator until ORDY goes true, at which time the state machine will advance to the next state. If the cycle time of the multiplier-accumulator never exceeds the access time of the FIFO, ORDY should always be true when it's an input the state machine depends on.

Microcoded instructions to the multiplier-accumulator are generated by decoding the state variables. The first instruction is a NOOP. When SMPL\_CONV goes low, then state machine issues a XBUS instruction to the multiplier-accumulator. This causes the multiplier-accumulator to load data from the I/O port into an internal register. The state machine then issues a YBUS;

CLKMR TC. This command tells the multiplier-accumulator to perform a multiply operation in twos-complement without accumulation because it's the first multiply operation of the convolution.

The machine then enters a loop and issues another XBUS command followed by a YBUS; CLMR; TC; MR+. This command is a multiply-accumulate function in twos-complement arithmetic. The machine remains in this loop until TC goes true, at which time the last multiplier-accumulator cycle is completed and the output command MS (SAT) is issued. MS causes the filter's outputs (multiplier-accumulator outputs) to become valid and latched into a final output register. This command will saturate the multiplier-accumulator output if the final value has an overflow, keeping the digital filter from oscillating. The multiplier-accumulator is statically configured to round off the final output to the most significant 16 bits.

The instructions to the multiplier-accumulator can be changed simply by decoding the state variables to different output values. If E<sup>2</sup>C MOS devices are used, the programmable device can simply be reprogrammed and put back into the circuit. An E<sup>2</sup>C-

MOS 22V10 from Lattice Semiconductor is one such device that can be used for this application.

Two 64-word-by-8-bit FIFOs can be used to implement the filter taps. The FIFO can be loaded up with the initial N samples. A sample is then shifted out of the FIFO and into the multiplier-accumulator for processing. This sample is also stored in a shift/hold register and is shifted back into the FIFO prior to the next sample being shifted into the multiplier-accumulator for processing. After all N samples have been processed, the oldest sample is shifted out and a new ADC sample shifted in. The multiplier-accumulator can then output a filter value. Programmable logic can be used to interface the digital filter to the ADC, act as temporary storage register, and implement FIFO control.

These shift/hold registers can be implemented with two 20V8 devices. In the sample mode (SMPL\_CONV = 1), the devices act as shift registers. Data is serially loaded into them under control of the ADC. The registers are then placed in a hold mode so that the data sample isn't lost. When the system enters the convolve mode, (SMPL\_CON = 0), data is immediately loaded into the

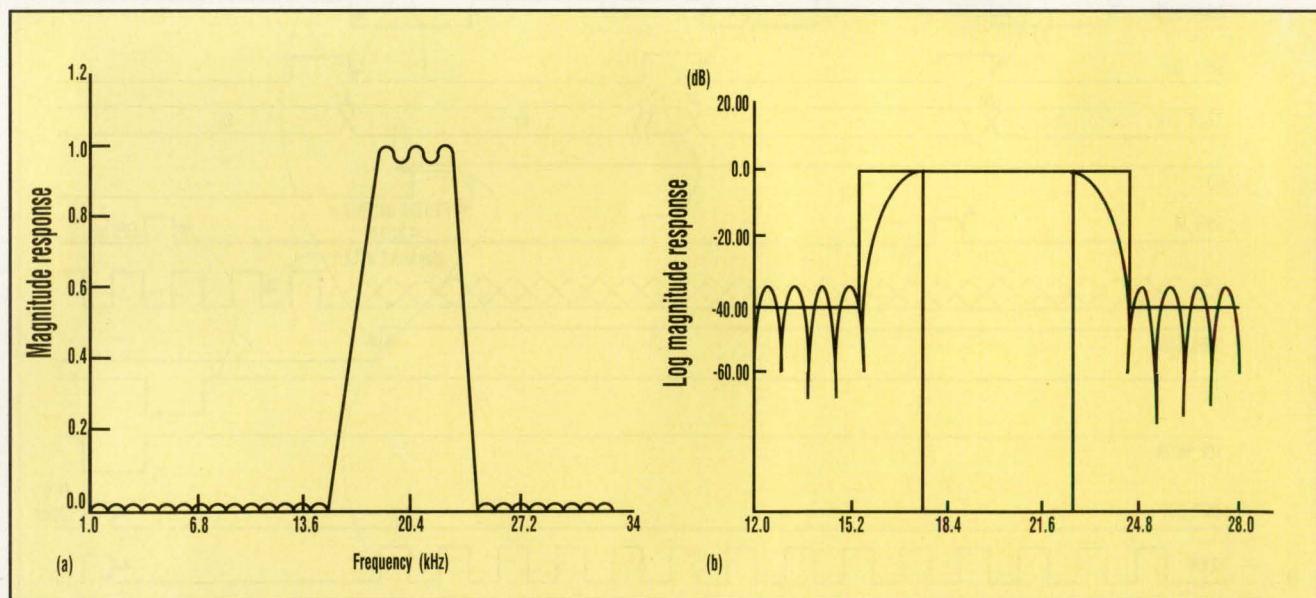

**5. A PLOT OF THE MAGNITUDE** response shows that the bandpass filter's center frequency is 20 kHz with a passband of 5 kHz (a). The transition region occurred in 2 kHz. The log magnitude response plot reveals a 175-dB/decade slope at the edges of the filter (b). It would take a 9th-order analog filter to implement the same specifications.

# Afford. Ability.



© 1991 Hewlett-Packard Co. TMNJ105/ED

## In a dc power supply.

Now, put a dependable, 30-watt dc power supply on your bench for just **\$300\***. You'll get the low noise your work demands (200  $\mu$ V rms). Constant-voltage or constant-current operation. And built-in reliability ensured by conservative design margins and rigorous environmental testing.

Outstanding value in a dc power supply. It's just one in a full line of basic instruments developed by HP to give you uncompromising performance at an affordable price.

 **To order, call HP DIRECT, 1-800-538-8787, Ext. TW11.**

We'll ship your order the day it's received. Instruments come with a sixty-day, money-back guarantee.

All you need is a company purchase order or credit card.

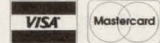

HP 30-watt power supplies		E3610A	E3611A
Output	Range 1	8V, 3A	20V, 1.50A
	Range 2	15V, 2A	35V, 0.85A
Load or line regulation		0.01% + 2 mV	
Ripple and noise (10 Hz-10 MHz)		200 $\mu$ V rms/2 mV p-p	

\* U.S. list price

There is a better way.



CIRCLE 110 FOR U.S. RESPONSE  
CIRCLE 111 FOR RESPONSE OUTSIDE THE U.S.

# AVANTEK MMICs NATURE, AT A NATURAL PRICE



## High Performance RF/ Microwave Circuits in Tiny SMD Packages

Fresh idea. A growing family of DC to 5.0 GHz amplifiers, active mixers, and other high performance monolithic microwave ICs (MMICs), at design conscious prices—as low as \$0.95 each in 10,000 piece quantities. Avantek's new ISOSAT™ process yields a harvest of silicon MMICs in plastic SMD packages for portable, handheld, and low-power high-volume designs, where size and cost are as critical as RF performance.

## Cellular, Spread Spectrum, Fiber Optics, GPS—Any RF/ Microwave Application

Avantek, the pioneer of commercial and defense RF/microwave solid-state, offers the ISOSAT family of plastic MMICs in bulk, tape and reel. High-volume, low-cost circuits that meet your highest requirements for low power consumption, bandwidth, low noise (as low as 1.7dB), high gain, stability and cascadeability. ISOSAT products make your linear design goals easy and efficient.

## Get a Little Help from Your Friends

Avantek has over 50 field specialists around the world to assist in developing your RF/microwave designs. And, Avantek ISOSAT amplifier product data is available for use in all major CAE libraries, such as EEsof Touchstone™.

Power Gain vs. Frequency

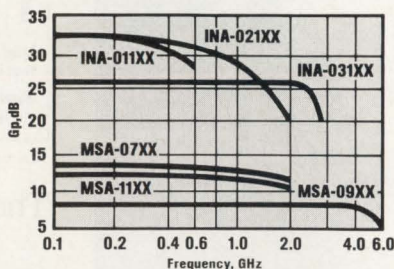

With over 20 major stocking locations, and a worldwide trans-shipment operation, Avantek has the largest RF/microwave semiconductor distribution network in the world. We meet the demands of the most demanding JIT programs, or supply critical prototypes with the same matchless service and support.



Call Your Local Distributor or  
1-(800) AVANTEK for Fast  
Delivery

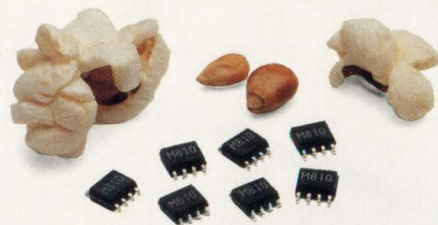

Putting Microwave  
Technology to Work for You



## DIGITAL FILTERS

shift/hold registers in parallel.

Filter coefficients are stored in PLDs emulating ROM. A 6001 has a programmable AND and a programmable OR array so that it easily emulates a 64-by-8 high-speed PROM. Again, if  $E^2$  devices are used, the filter coefficients can be changed simply by reprogramming the devices. An address counter is used to access the coefficients in the correct order. Because there are 64 required coefficients for the 64 taps, only 6 bits of address are required.

The coefficient-address counter is a simple 6-bit counter implemented in a 22V10. The counter is a synchronous type with a count enable. The clock is synchronous with the multiplier-accumulator clock. The count-enable input pin is connected to XOE from the multiplier-accumulator controller. Therefore, the counter is incremented only after the coefficient value has been loaded into the multiplier-accumulator. When the counter reaches 63, TC goes true to indicate that all 64 coefficients have been convolved. Again, the power-up reset is used to ensure that the counter starts in a known state.

The remaining four output-logic macro cells can be used to generate FIFO control signals. These signals are generated asynchronously. Depending on the state of the system—whether it be initially loading, sampling, or convolving—the appropriate Shift In, Shift Out, and clock signals for the shift/hold register will be generated (Fig. 4).

When the convolution is done, the state machine sets the CONV\_DN signal true synchronous with MCLK. Hence, SMPL\_CONV will also be set synchronous with MCLK. This will create glitches on the signal CLKIN, which is the clock to the shift/hold registers. This is a don't-care condition, as the registers will soon be loaded with a new valid data sample under the control of the ADC.

The system requires 133 MCLK cycles to complete the convolution. With a 11.7-MHz clock, this takes 11.4  $\mu$ s. This system used an ADC with a serial interface that requires 3.3  $\mu$ s to shift the data into the shift/

hold registers. Thus, the system can sample an input signal at  $11.4 + 3.3 = 14.7 \mu$ s or 68 kHz. The Nyquist sampling theorem states that a signal must be sampled at twice the highest frequency component to accurately preserve the information in that signal. Therefore, this system can accurately filter a signal with the frequency component as high as 34 kHz.

Using the DFDP software from ASPI, a bandpass filter was designed using the Parks-McClellan method. The center frequency is at 20 kHz with a passband of 5 kHz. The transition region occurred in 2 kHz (Fig. 5). It's interesting to note that the edges of the filter have a slope of approximately 35 dB/0.2 decade, or 175 dB/decade. It would take a 9th-order analog filter to implement the same specifications.

The system presented in this example is a straightforward FIR filter. Because of the extensive use of programmable logic, the system can be easily adapted to implement an IIR filter. The final output value can be fed back into the FIFO prior to a new sample shifting into the FIFO. The coefficients can be staggered in the coefficient ROM so that the  $B_m$ s line up with the  $Y(n - M)$ , and the  $A_n$ s line up with the  $X(n - N)$ .

If enhancement of the system's performance is desired, a larger FIFO memory can be used with a faster multiplier-accumulator. Because 15-ns programmable-logic devices are used, they're not a limiting factor. If a parallel ADC, 64-by-8 FIFO, and a 45-ns multiplier-accumulator are employed, the system could be made to run at 167 kHz with little modification. □

*The author would like to thank Atlanta Signal Processing for their help in developing this article.*

*Mike Trapp, an applications engineer for Lattice Semiconductor, holds a BSEE from the University of Colorado, Boulder.*

HOW VALUABLE?	CIRCLE
HIGHLY	547
MODERATELY	548
SLIGHTLY	549

# NO WAITING AVANTEK DELIVERS TODAY

## North American Distributors

*Northeast*  
Nu Horizons  
(617) 246-4442 MA  
Sickles Distribution Sales  
(617) 862-5100 MA

*East Central*  
Applied Specialties, Inc.  
(301) 595-5395 MD  
Nu Horizons  
(301) 995-6330 MD  
(201) 882-8300 NJ  
(516) 226-6000 NY  
(716) 248-5980 NY  
(215) 557-6450 PA  
Penstock East  
(800) 842-4035 NJ  
(516) 368-2773 NY  
(215) 383-9536 PA

*Southeast*  
Component Distributors, Inc.  
(800) 558-2351 FL  
Nu Horizons  
(305) 735-2555 FL

*North Central*  
Penstock Midwest  
(708) 934-3700 IL  
(317) 784-3870 IN

*South Central*  
Insight Electronics, Inc.  
(800) 677-7716 TX  
Thorson Distributing Co.  
(214) 233-5744 TX

*Northwest*  
Insight Electronics, Inc.  
(800) 677-7716

Penstock, Inc.  
(800) PENSTOCK  
(206) 454-2371 WA

*Southwest/Rocky Mountain*  
Insight Electronics  
(800) 677-7716  
Sertek, Inc.  
(800) 334-7127

*Canada*  
Sertek, Inc.  
(800) 548-0409

## International Distributors

*Europe*  
Italy  
BFI-Ibexsa SpA  
(39) 2-331-005-35 Milan  
(39) 6-8088191 Rome  
Germany  
BFI-Ibexsa Elektronik GmbH  
(49) 89-3195135  
France  
Scie Dimes  
(33) 1-69-41-8282  
Sweden  
BFI-Ibexsa Nord AB  
(46-8) 626-99-00  
U.K.  
BFI-Ibexsa Electronics LTD.  
(44) 62-288-2467

*Asia and Far East*  
Japan  
Yamada Corporation  
(81) 03-3475-1121



**Putting Microwave  
Technology to Work for You**

**AVANTEK**

CIRCLE 128 FOR U.S. RESPONSE  
CIRCLE 129 FOR RESPONSE OUTSIDE THE U.S.

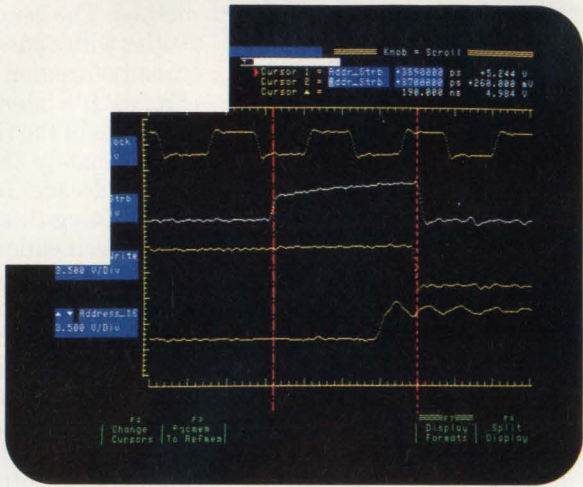
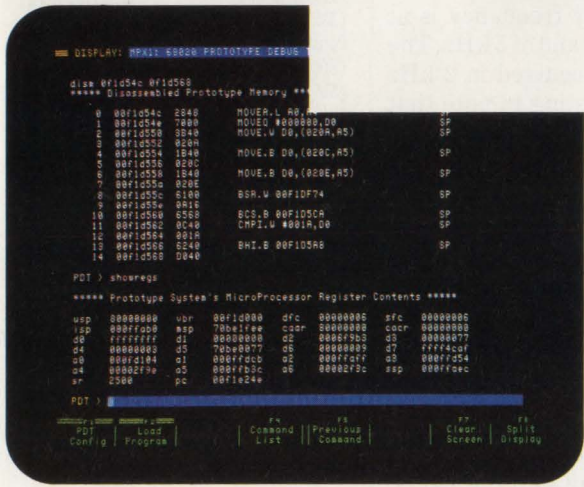
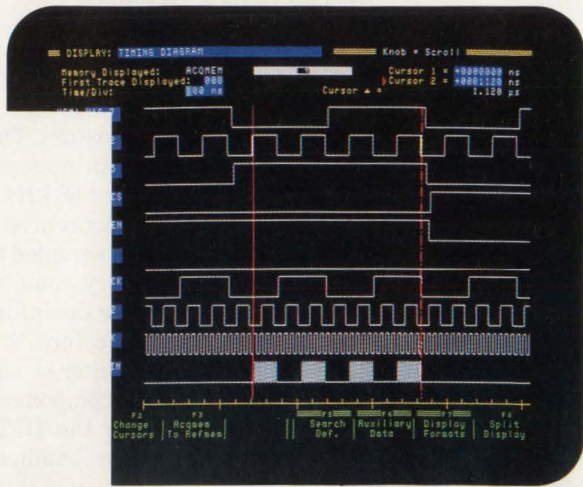
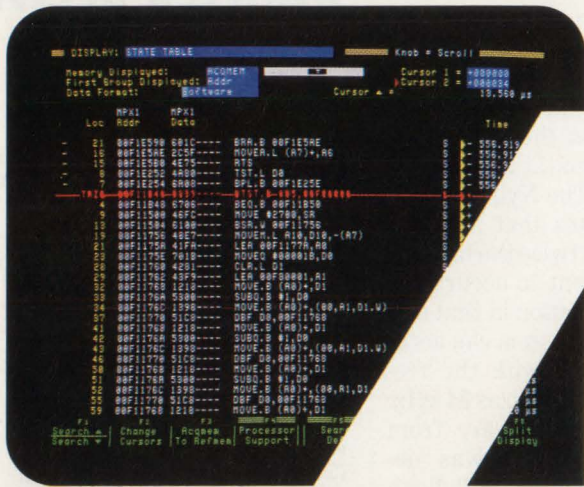

# Prism. Four instruments in one logic analyzer. For faster, time-correlated results.

State analyzer. Timing analyzer. Emulator. DSO. Getting the complete picture is easier than you think.

The 4-in-1 Prism 3000 Series is unlike any other logic analyzer. From one keyboard and display, it can do the work of multiple instruments. It can time-correlate data acquired by one Prism module to data acquired by all other modules, via revealing split-screen displays.

Combine the triggering and channel resources of a logic analyzer with emulator-like ability to change registers, patch memory, and step through your code. View both signal timing and signal integrity at the same time with the integrated DSO.

For twice the power and convenience afforded by separate instruments, at half the cost, contact your Tek sales engineer. Or call 1-800-426-2200 for the complete multipurpose Prism story.

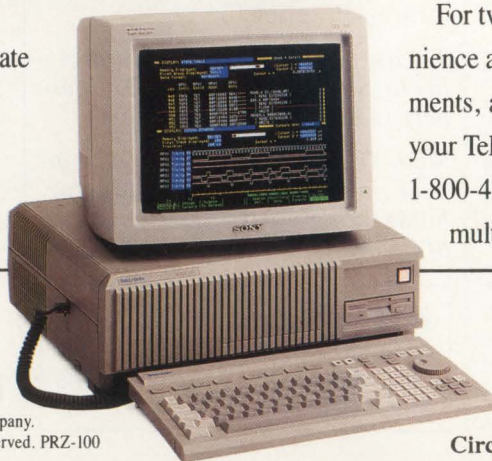

**Tektronix**  
COMMITTED TO EXCELLENCE

Rental units available from your local rental company.  
Copyright © 1990, Tektronix, Inc. All rights reserved. PRZ-100

Circle 149 for Sales Contact (U.S. Response)

Circle 148 for Literature

Circle 150 for Literature

Circle 151 for Sales Contact (Response Outside U.S.)

## PIPS

POWER • INTERCONNECTIONS • PASSIVES • SWITCHES • RELAYS

ELECTRONIC DESIGN

# Electromechanical Relays: Factors To Consider Before Buying

*Correct interpretation of relay data sheets can spell the difference between a successful system design and a failure.*

BY BLAIR CAPRIOTTI

Aromat Corp., 629 Central Ave., New Providence, NJ 07974; (908) 464-3550.

Despite their modest size, relays can determine the quality of electronic equipment. In a matter of milliseconds, the wrong relay can turn a well-designed computer into an expensive desk ornament. Choosing the right electromechanical relay during the design stage avoids such problems. Doing so is simple—once you know what to look for.

Basically, an electromechanical relay is a remote switch capable of switching multiple circuits, either individually, simultaneously, or in sequence. When the coil is energized, it becomes an electromagnet and moves the contacts. It's a deceptively simple concept.

Hundreds of different electromechanical relays exist for specialized applications ranging from telecommunication and computers to motors and lights. Such variety allows designers to select the right relay for any given application, but it also complicates the selection task. Which relay is the right one?

The process starts with identifying the type of switching required. Power relays switch high-level loads ranging from 5 A to 80 A or more, and are used in lamps, motors, and other equipment. A signal relay typically switches loads of 2 A or

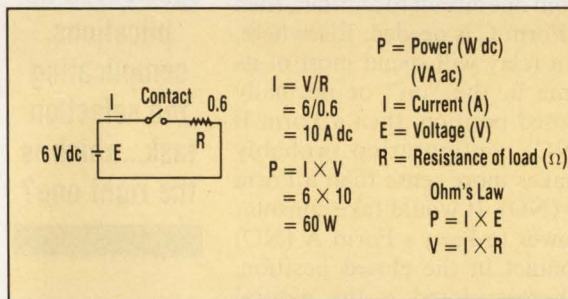

1. Designers should use Ohm's Law in determining a proper contact rating for relays. In the example shown, the relay should have a contact rating of more than 60 W, 10 A, and 6 V dc.

less, controlling signals such as those found within logic circuits for computers, copiers, and phone systems.

Once the basic type of switching has been identified, there are five specific points to consider in narrowing down the choice: the contact specifications and their configuration, the coil, the package, and relay standards. Despite the diversity among electromechanical relays, these points must be considered for all applications.

Relay contacts are designed to carry certain rated loads and load types. Overloading a relay will damage the contacts and cause a failure in the circuit. Conversely, a 30-A power relay won't switch 2 A as efficiently as a low-power signal relay. Use Ohm's law to determine the proper contact rating for a specific application (Fig. 1). A frequent error made in specifying a relay is failing to account for the

type of load and its specific inrush current.

There are many different load types: resistive, inductive, and capacitive, among others. Except for resistive loads, each one creates an inrush current that is much greater than its steady-state current. For example, when a motor is turned on, it immediately tries to draw five to 10 times its steady-state current. In this case, the inrush decreases over a period of 0.25 to 0.5 seconds. Other loads may draw up to 40 times more than their steady-state current over a period lasting from several seconds to several minutes.

Here are some typical loads and the related inrush versus steady-state current:

- Solenoid (10 to 20 times greater)
- Motor load (five to 10 times greater)
- Incandescent lamp (10 to 15 times greater)
- Mercury lamp (three times greater)
- Sodium-vapor lamp (one to three times greater)
- Capacitive load (20 to 40 times greater)
- Transformer load (five to 15 times greater)

In applications with inrush current, use the steady-state current as a guide to determine the

# ELECTROMECHANICAL RELAYS

size of the inrush current. Then select a relay that provides ample safety. A major factor in protecting against inrush current is the contact material. Silver alloys are the most common contact materials. Silver cadmium oxide (AgCdO), for example, has the conductivity and low contact resistance of silver, but it also has excellent resistance to welding, which means better inrush protection. Sometimes additional layers are added to relay contacts when they're used in certain applications. Gold or chromium layers add extra corrosion resistance. In telecommunication relays, gold flashing or cladding is sometimes used to improve conductivity at low current levels.

There are three basic contact configurations: Forms A, B, or C. Form A is a single-pole, single-throw, normally open (SPSTNO) configuration. Upon actuation, the contacts close to complete a circuit.

The Form B configuration is also a single-pole, single-throw type, but is normally closed (SPSTNC). With form B, the contacts move apart, breaking the circuit.

Form C contacts, which are single-pole, double-throw (SPDT) types, transfer the con-

tact from one pole to another. As the armature moves, it breaks one contact before making the other.

When a catalog or data sheet refers to contact configuration as 2b, it means the relay has two Form B contacts. When activated, the relay will turn off or break two independent circuits. Conversely, a 3a relay will turn on or make three independent circuits when activated. Some relays combine configurations. A 2a2b relay will make two circuits while breaking two others.

Typically, the application determines the choice of configuration. For example, if a common signal must be switched from one circuit to another, then a Form C is needed. Elsewhere, if a relay will spend most of its time in the "on" or normally closed position, then a Form B (NC) configuration probably makes more sense than a Form A (NO). It would take constant power to keep a Form A (NO) contact in the closed position, whereas closed is the natural state for a Form B contact.

Sometimes, however, the circuit dictates use of Form A (NO) contacts even though the contacts will be held in the closed position for prolonged periods. In these situations,

latching relays can be used.

Latching relays, available in all three configurations, contain either one or two coils and are activated by pulses of current rather than steady flows. In a two-coil type, a single pulse energizes the "set" coil, moving the contacts into the closed position. The contacts remain closed without application of power until another pulse energizes the "reset" coil, moving the contacts into the open position. In the single-coil type, the relay is set and reset by applying signals of opposite polarities to the coil. Multiple latching relays may be synchronized and controlled by a microprocessor (Fig. 2).

Coil specifications are another key to identifying the right relay for an application. The following specifications primarily refer to polarized dc coils, which is the most common type of coil used today because of its high efficiency. The older ac coils are used only when alternating current is the only type of power coming through the line.

Under normal operating conditions, the coil's nominal voltage is the recommended voltage required to operate the relay. The pick-up voltage, which is typically 70 to 80% of the nominal voltage, is the minimum voltage needed to activate the relay. Theoretically, a pick-up voltage of 5 V dc for a 1 Form A relay means that it will take at least 5 V to close the contacts and make a circuit. In practice, however, because of varying operating conditions such as temperature, load, or others, it's best to confirm the actual pick-up voltage.

The drop-out voltage is the highest voltage at which the contacts revert to their inactive position. Typically 10% of the nominal voltage, the drop-out voltage tells you the point at which the relay is guaranteed to be in its energized position.

The maximum continuous voltage is the highest voltage

**Hundreds of relays exist for specialized applications, complicating the selection task...which is the right one?**

2. In the circuit shown, latching relays are controlled by a timing pulse that's generated in synchronization with the control signal of each relay. CPU software can easily be programmed to generate the timing pulse. The application is useful for microprocessor-based equipment with many output relays, because the relays are only energized briefly, and there is no heat to attack the surrounding components.

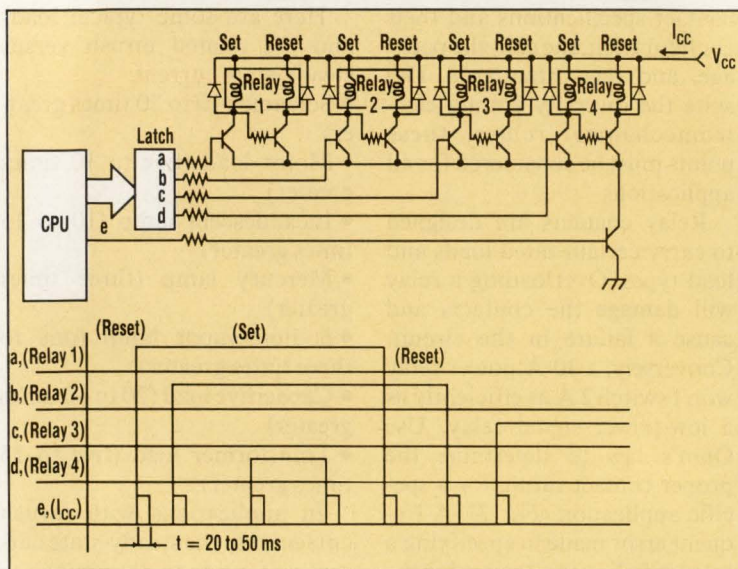



## ELECTROMECHANICAL RELAYS

that can be applied continuously to the coil without causing damage. The nominal voltage of a power relay might be 12 V, while the maximum allowable voltage is 16 V. The relay can probably take spikes of higher voltage, but check with its maker to be sure.

The coil resistance is the dc resistance of the coil at a given temperature, usually 20°C (68°F). Rising temperatures cause increased resistance. Every 1°C rise requires a 0.4% increase in pick-up voltage to operate the relay.

The temperature-rise specification tells how hot a relay coil can get and still function properly. As mentioned above, rising temperature increases resistance, requiring additional voltage to operate the relay. Temperature rise is affected by input power, the switching and carrying contact current, ambient temperature, and how often the relay operates. Most relays operate at ambient temperatures ranging from -40 to +85°C. Specialized high-temperature coils operate at up to 180°C.

Another critical factor in specifying relays is their packaging, which refers to options such as terminal type, mounting method, relay size, covering, and sealing types. All packages are not created equal.

Dust covers, which are standard on most relays, protect the relay's inner workings from damage from dust and other large particles. However, a covered relay is not the same as a sealed relay. Too often, a simple covered relay is run through wave soldering or a water cleansing and is ruined.

There are several different types of sealing available, which provide varying degrees of protection during pc-board processing. Flux-resistant types are suitable for automatic soldering. Their terminals are sealed or molded to the base. In addition, the point at which the cover meets the base is usually raised

3. Shown are the results of resistance tests comparing unsealed and sealed versions of two types of relays. The extra expense for sealed relays is more than offset by their durable performance in on-site and remote installations as well as the production savings gained by using automatic pc-board soldering and cleaning equipment.

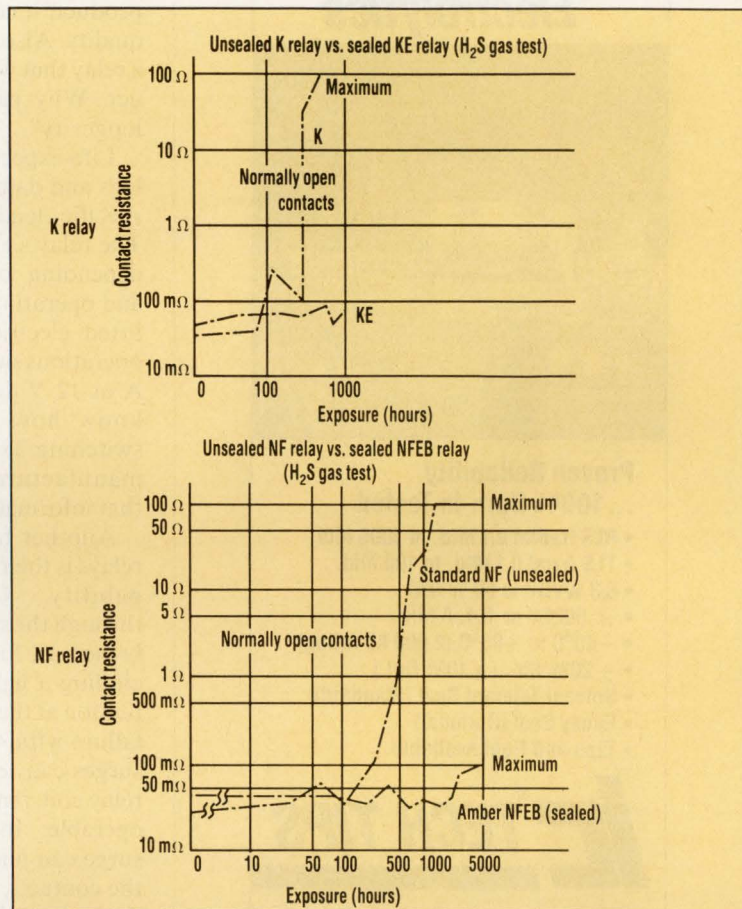

above the pc board to permit cleaning the board surface.

Sealed relays can go through automatic soldering and cleaning processes, although ultrasonic cleansing is not recommended. The relay is sealed with a resin, typically epoxy, to protect the contacts from dust and other contaminants. Hermetic sealing protects against all gas absorption. Metallic hermetic sealing is suitable for explosion-proof requirements.

Relays come with pc-board terminals, self-clinching terminals, quick-connect types, pc-board/quick-connect combinations, plug-in terminals, or screw terminals. The variety gives the designer multiple design-in options.

Using components that are certified by one or more standards bodies simplifies and reduces the cost of obtaining ap-

proval from UL, CSA, or one of the other testing organizations. Catalogs and data sheets should list all certifications. Check the ratings at which the relay was certified to see if the approval is relevant to an application.

In addition to the five points mentioned above, there are several other issues that need to be considered when selecting a relay. One of those is the relay's life expectancy. Most relay catalogs and data sheets list two types of life expectancy: mechanical and electrical. Mechanical life is the guaranteed number of times the relay can be operated under nominal conditions with no load on the contacts. Electrical life is the guaranteed number of times a relay will operate with a specific load on the contacts. Generally, relay life should be matched to the life of the product. If relay life is less

# IC<sup>®</sup> RLS/TLS

## Low Leakage Electrolytics



### Proven Reliability ...100% Burn-In Tested

- RLS Radial 0.1 Mfd. to 1000 Mfd.
- TLS Axial 0.1 Mfd. to 100 Mfd.
- 6.3 WVDC to 50 WVDC
- $\leq .002CV$  or  $0.4\mu A$  Min.
- $-40^{\circ}C$  to  $+85^{\circ}C$  (2,000 hr. rating)
- $\pm 20\%$  Std. ( $\pm 10\%$  Opt.)
- Solvent Tolerant Seal (Standard)
- Epoxy Seal (Optional)
- Tape and Reel Available

## IC<sup>®</sup> TECH TIPS

IC's Low Leakage RLS (radial) and TLS (axial) capacitors give premium (tantalum-like) performance at an aluminum electrolytic price—Perfect for new designs and retrofits for timing circuit applications, low noise, bypass and coupling modes. IC's RLS and TLS capacitors provide ideal frequency response for telecommunications circuitry and offer outstanding stability over time. The typical useful operating life at room temperature can easily exceed 10 years. Available on tape or reel for use on the latest automatic insertion equipment. Optional features: epoxy or solvent tolerant end seals for use with different cleaning systems. IC's Types RLS and TLS give the designer the freedom of choice.

©1988 ILLINOIS CAPACITOR, INC.

**ILLINOIS CAPACITOR, INC.**  
3757 West Touhy Avenue  
Lincolnwood, Illinois 60645  
(708) 675-1760  
Fax (708) 673-2850

## ■ ELECTROMECHANICAL RELAYS ■

than the expected life of the product, it could affect product quality. Also, there's no need for a relay that will outlive the product. Why pay for unnecessary longevity?

Life-expectancy data in catalogs and data sheets is given for specific loads and conditions. The relay's actual life may vary depending on the application and operating conditions. If the listed electrical life is 100,000 operations switching a load of 40 A at 12 V dc, and you need to know how long it will last switching 38 A at 14 V dc, the manufacturer should provide that information.

Another factor in specifying relays is their surge-handling capability. Current flowing through the system may suddenly increase for many reasons, including a lightning strike, fluctuation at the power station, or a failure within the system. These surges can severely damage the relay coil, rendering the relay inoperable. In some cases, the surge can jump from the coil to the contacts, causing damage to the load section of the circuit. If the load is connected to the telephone lines, the surge could damage equipment miles away.

FCC and REA requirements for telephone relays require protection from lightning surges up to 2500 V. For European-telecommunication applications, some relay manufacturers have begun adding a special molding to signal relays to insulate the coil and contacts from surges up to 4000 V. Power relays, because of their size, can typically withstand surges up to 5000 V. When switching inductive loads with a dc relay for relay-sequence circuits, dc motors, dc clutches and dc solenoids, diodes are used to absorb the surge.

Contact resistance is a key consideration. The most important characteristics of contact resistance are low initial resistance and stable resistance over time. Certain signal relays, like

those with low contact loads in the millivolt range, can only be switched with low resistance, typically less than 20 m $\Omega$ .

Although increased resistance cannot be prevented, certain developments in relay design limit the increase. Sealed relays play a major role in maintaining stable contact resistance because they prevent contaminants from fouling the contacts. Data for resistance tests comparing unsealed and sealed versions of two types of relays can be shown graphically (Fig. 3). In addition, matching the relay to the application by accounting for factors such as inrush current, surges, operating frequency, and others, will slow the rise of resistance. Check the data to ensure that a relay has prolonged stable resistance.

Specifications on vibration and shock resistance explain how much energy and force a relay can withstand and continue to function properly. Vibration resistance is expressed in both G force and frequency range. Functional vibration resistance refers to the amount of vibration that's tolerable during service without causing closed contacts to open more than a specified amount. For example, a relay rated at 4.4 G, 10 to 500 Hz can withstand the steady vibrations of an automobile engine. Destructive vibration resistance refers to the amount of vibration a relay can withstand during shipment, installation, or use without suffering damage.

*Blair Capriotti, assistant vice president and general manager of Aromat's Precision Components division, holds a BSEE from Pennsylvania State University.*

### HOW VALUABLE?

HIGHLY	CIRCLE 550
MODERATELY	CIRCLE 551
SLIGHTLY	CIRCLE 552

CIRCLE 162 FOR U.S. RESPONSE

CIRCLE 163 FOR RESPONSE OUTSIDE THE U.S.

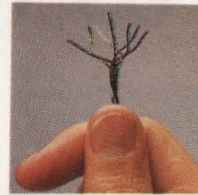
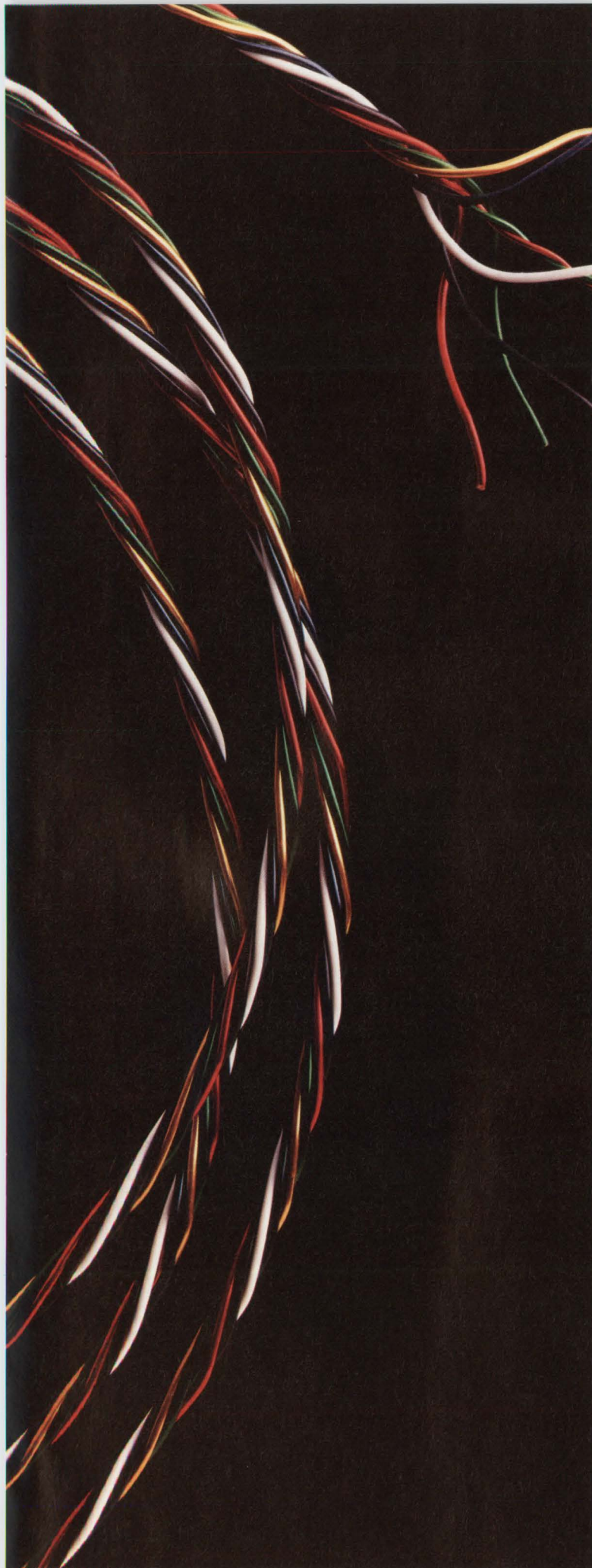

## **TWISTITE™** MAGNET WIRE

**For superior performance and tighter control over twisted wire construction.**

Developed for use in the production of custom toroid, ferrite or recording head coils, specialty audio and R.F. transformers, TWISTITE offers a number of distinct advantages.

TWISTITE is custom produced to offer a wider range of twisting construction. Manufacturing capabilities include:

- Up to 33 Twists Per Inch on fine wire.
- Twisting tolerance as tight as  $\pm 1\%$ .
- Tightly controlled capacitance, inductance and impedance characteristics.
- Up to 10 colors in some sizes for conductor identification.
- Huge selection of insulations: NEMA MW 1000, JW1177, 105–220°C (single through quadruple film builds).
- Wide range of sizes: 24 AWG and finer.
- Wide variety of conductor materials: copper, silver, plated conductors, and special alloys.

Call or write for your free copy of our new Technical Data and Capabilities Brochure. It contains valuable information on all wire produced and inventoried by MWS Wire Industries. Samples of TWISTITE are available upon request.



# **MWS**

## **Wire Industries**

31200 Cedar Valley Drive, Westlake Village, CA 91362

**CALL TOLL FREE 800 423-5097**

818 991-8553 FAX 818 706-0911

**CIRCLE 126 FOR U.S. RESPONSE**

TWISTITE is a trademark of MWS Wire Industries

**CIRCLE 127 FOR RESPONSE OUTSIDE THE U.S.**

# Introducing the only linears approved to meet IEC 950 and Level B EMI.

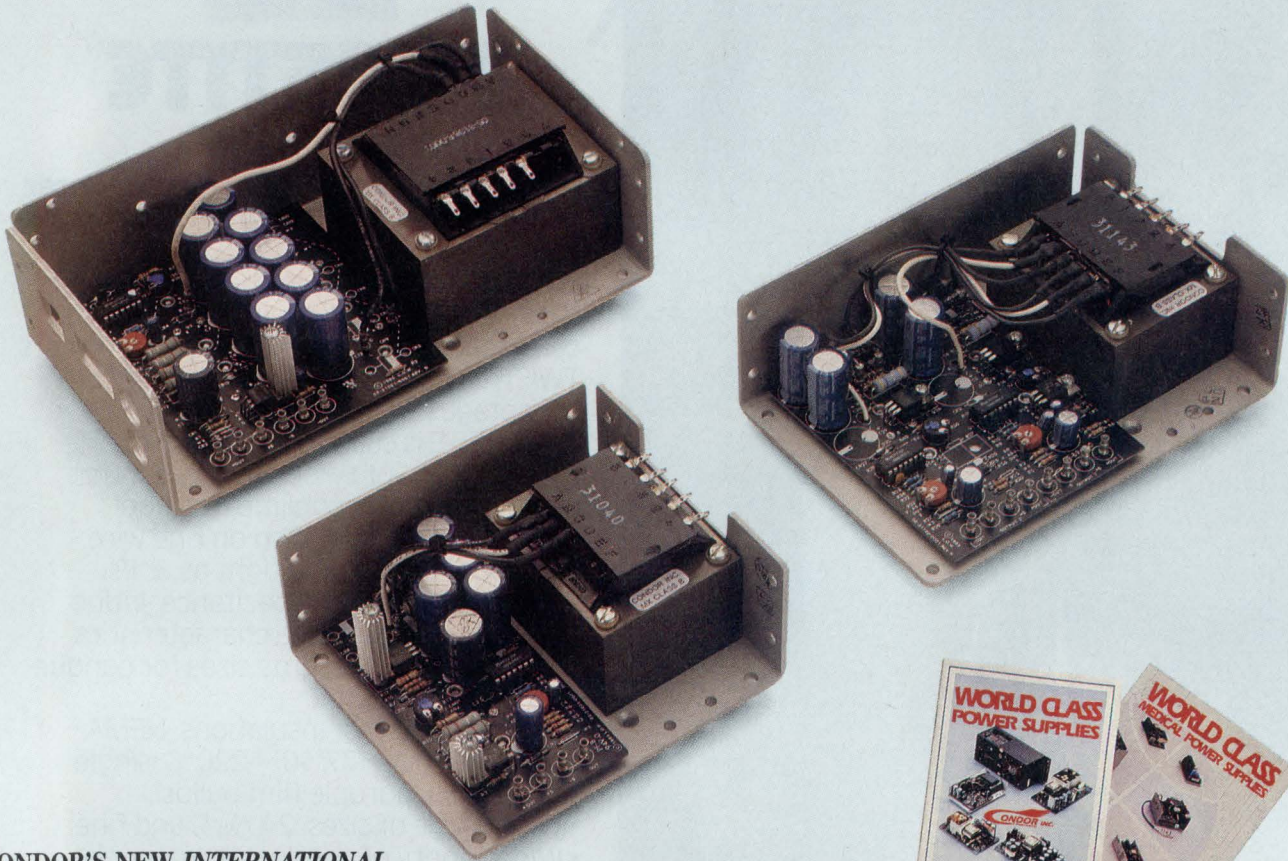

## CONDOR'S NEW *INTERNATIONAL PLUS* LINEAR D.C. POWER SUPPLIES MEET TOMORROW'S TOUGH STANDARDS TODAY!

Our International Plus linears offer you performance, price and one more important feature: the agency approvals you need for the 90's, including IEC 950 and VDE 0871 level B EMI. And Condor has more approved linears in stock than anyone in the industry (including more than 30 models in IEC 601 medical versions).

International Plus linears have what you're looking for:

- 115 models (single and multi-output)
- 7 power levels — 3 to 288W
- Worldwide AC input ranges
- OVP on all 5V outputs

- Hermetically sealed power transistors
- MTBF 200,000+ hours per Mil Hndbk 217E
- 2-hour burn-in with cycling (8 hours on medicals)
- Computerized testing (data sheets furnished)
- 3-year warranty — longest in the industry
- 30-day FREE evaluation (call us for samples)

If you need world class performance, quick turnaround, competitive pricing *and* full agency approvals, call Condor — the leader in linear D.C. power supplies.



Call for our  
FREE catalogs!

- 300+ power supplies
- Standard and medical
- Switchers and linears
- Open frame and enclosed
- Custom capability

**CONDOR**

Condor Inc. D.C. Power Supplies  
2311 Statham Parkway  
Oxnard, CA 93033 • (805) 486-4565  
CALL TOLL-FREE:  
1-800-235-5929 (outside CA)  
FAX: (805) 487-8911

**▼ WATERPROOF KEYPADS  
HAVE UP TO 16 KEYS**

Two series of environmentally sealed keypads have been upgraded to an immersion-proof rating. The KNM20 and KNM30 Series keypads are available in 1-by-4, 3-by-4, or 4-by-

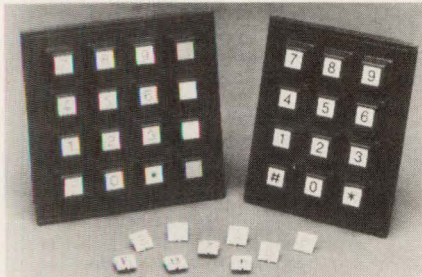

4 configurations with either raised or flush keys. Other features include dual gold-plated, two-finger contacts; springless magnetic return; and tactile feedback. Call for pricing and delivery.

**Interswitch**  
770 Airport Blvd.  
Burlingame, CA 94010  
(415) 347-7727

► **CIRCLE 775**

**▼ WASHABLE ROTARIES  
ARE HALF OTHERS' SIZE**

A series of washable, binary-coded DIP rotary switches is about half the size of competitive devices. The ND

series of switches, with their ultra-mini dimensions and long life, are well suited for many space-saving applications such as digital settings in computer peripherals and data entry for address encoding and presetting of microcomputers. The units, which are sealed with an O-ring between case and actuator, are rated at 100 mA at 5 V dc. Insert-molded terminals prevent contamination. Call for pricing and delivery.

**NKK Switches**  
7850 E. Gelding Dr.  
Scottsdale, AZ 85260  
(602) 991-0942

► **CIRCLE 776**

**SWITCH AND RELAY MANUFACTURERS**

**AMP Inc.**  
P.O. Box 3608  
Harrisburg, PA 17105  
(800) 522-6752  
(DP) (PC) (RK) (RO) (SL)  
(SA) (TH)  
**CIRCLE 600**

**AT&T Microelectronics**  
2 Oak Way, P.O. Box 610  
Berkeley Heights, NJ 07922  
(201) 771-2826  
(OI) (DR) (DS) (TE)  
**CIRCLE 601**

**AT&T Microelectronics**  
2525 N. 12th St., Box 13396  
Reading, PA 19612  
(215) 939-6264  
(AS) (DS) (OI)  
**CIRCLE 602**

**Advanced Components Industries**  
Gruner Div.  
1308 Sartori Ave. #105  
Torrance, CA 90501  
(213) 328-0060  
(CT) (FP) (HD) (HS) (ML) (PB)  
(PW) (TD)  
**CIRCLE 603**

**Aerospace Optics Inc.**  
3201 Sandy La.  
Fort Worth, TX 76112  
(817) 451-1141  
(IL) (PU)  
**CIRCLE 604**

**Allen-Bradley Co.**  
Industrial Control Group  
1201 S. Second St.  
Milwaukee, WI 53204  
(414) 382-2000  
(IL) (PH) (PX) (PU) (RK)  
(CT) (HD) (HS) (ML) (PW)  
(TD)  
**CIRCLE 605**

**American Electronic Components**  
P.O. Box 280, 1010 N. Main  
Elkhart, IN 46515  
(219) 264-1116  
(TG) (HS) (TD)  
**CIRCLE 606**

**American Research & Engineering**  
1500 Executive Dr.  
Elgin, IL 60123  
(708) 888-7245  
(DP) (SM)  
**CIRCLE 607**

**American Zettler Inc.**  
75 Columbia St.  
Aliso Viejo, CA 92656  
(714) 831-5000  
(AU) (FP) (HS) (PB) (PW)  
(TE)  
**CIRCLE 608**

**Amperite Co. Inc.**  
600 Palisade Ave.  
Union City, NJ 07087  
(201) 864-9503  
(CS) (HS) (TD) (VS)  
**CIRCLE 609**

**Annulus Technical Industries**  
1296 Osprey Dr.  
Ancaster, Ontario,  
Canada L9G 4G4  
(416) 648-8100  
(DP) (PC) (SL) (SA)  
**CIRCLE 610**

**Antex Electronics Corp.**  
16100 S. Figueroa St.  
Gardena, CA 90248  
(213) 532-3092  
(CT) (HD) (CS) (HS) (HF) (OI)  
(ML) (DS) (TD)  
**CIRCLE 611**

**Arcoelectric Corp.**  
9001 Canoga Ave.  
Canoga Park, CA 91304  
(818) 700-1933  
(IL) (PU) (RK) (SL) (TG)  
**CIRCLE 612**

**Ark-Les Corp.**  
3400 Yonkers Rd.  
Raleigh, NC 27620  
(919) 231-2000  
(PU) (RO) (SL)  
**CIRCLE 613**

**Aromat Corp.**  
629 Central Ave.  
New Providence, NJ 07974

(201) 464-3550  
(SA) (AU) (DR) (HS) (HF) (IO)  
(ML) (PB) (PW) (TE) (TD)  
**CIRCLE 614**

**Arrow Hart Components**  
Cooper Industries Inc.  
P.O. Box 9050  
Charlottesville, VA 22906  
(804) 974-5142  
(RK) (CT)  
**CIRCLE 615**

**Ash-Lan Components Inc.**  
14673 Midway, Suite 118  
Dallas, TX 75244  
(214) 851-4005  
(IL) (KB) (KL) (MB) (PU) (SA)  
**CIRCLE 616**

**Augat**  
Alcoswitch  
1551 Osgood St.  
North Andover, MA 01845  
(508) 685-4371  
(DP) (IL) (KL) (PC) (PU) (RK)  
(RO) (SL) (SA) (SM) (TH)  
(TG) (PB)  
**CIRCLE 617**

**Automatic Timing & Controls Co.**  
201 S. Gulph Rd.  
King of Prussia, PA 19406  
(215) 337-5500  
(PH) (TD)  
**CIRCLE 618**

**Balluff Inc.**  
8125 Holton Dr.  
Florence, KY 41042  
(606) 727-2200  
(PH) (PX) (RO)  
**CIRCLE 619**

**Bergquist Co.**  
Membrane Switch Div.  
5300 Edina Industrial Blvd.  
Minneapolis, MN 55439  
(612) 835-2322  
(MB)  
**CIRCLE 620**

**Black Box Corp.**  
Park Dr.  
Lawrence, PA 15055

(412) 746-6566  
(CO) (TG)  
**CIRCLE 621**

**Robert Bosch Corp.**  
Automotive Group  
2800 S. 25th Ave.  
Broadview, IL 60153  
(708) 865-5367  
(AU) (HD) (PB) (PW)  
**CIRCLE 622**

**W.H. Brady Co.**  
Xymox Div.  
8225 W Parkland Ct.  
Milwaukee, WI 53223  
(414) 355-8300  
(KB) (MB)  
**CIRCLE 623**

**Brentek International Inc.**  
150 Beaver St.  
Hallam, PA 17406  
(717) 755-8000  
(DS) (DR) (HS) (IO) (OI) (TD)  
(VS)  
**CIRCLE 624**

**Burgess-SAIA Inc.**  
Switch Div.  
1335 Barclay Blvd.  
Buffalo Grove, IL 60089  
(708) 215-9600  
(KL) (PC) (PX) (PU) (RO)  
(SA)  
**CIRCLE 625**

**C & K Components Inc.**  
15 Riverdale Ave.  
Newton, MA 02158  
(617) 964-6400  
(DP) (IL) (KL) (MB) (PC) (PX)  
(PU) (RK) (RO) (SL) (SA)  
(SM) (TH) (TG)  
**CIRCLE 626**

**C.A.M. Graphics Co. Inc.**  
15 Ranick Dr. West  
Amityville, NY 11701  
(516) 842-3400  
(IL) (MB)  
**CIRCLE 627**

**CRL Components Inc.**  
Switch Div.  
Highway 20 West

Fort Dodge, IA 50501  
(515) 573-1300  
(CO) (DP) (IL) (KB) (MB) (PC)  
(PU) (RK) (RO) (SA) (TH)  
(TG)  
**CIRCLE 628**

**CTS Corp.**  
Knights Div.  
400 Reimann Ave.  
Sandwich, IL 60548  
(815) 786-8411  
(SL) (TH)  
**CIRCLE 629**

**CTS Corp.**  
905 West Blvd. N.  
Elkhart, IN 46514  
(219) 293-7511  
(DP) (KB) (PU) (RK) (RO) (SI)  
(SA) (SM)  
**CIRCLE 630**

**CTS Corp.**  
Electromechanical Div.  
1142 W. Beardsley Ave.  
Elkhart, IN 46514  
(219) 295-3575  
(DP) (RO)  
**CIRCLE 631**

**CUI Stack Inc.**  
9640 S.W. Sunshine Ct.  
Beaverton, OR 97005  
(503) 643-4899  
(RO)  
**CIRCLE 632**

**CW Industries**  
130 James Way  
Southampton, PA 18966  
(215) 355-7080  
(IL) (PC) (RK) (RO) (SL) (SA)  
**CIRCLE 633**

**Carlingswitch Inc.**  
60 Johnson Ave.  
Plainville, CT 06062  
(203) 793-9281  
(IL) (KL) (PU) (RK) (RO) (SL)  
(SA) (SM) (TG)  
**CIRCLE 634**

(see p. 114 for key)  
(continued on p. 104)

## SWITCHES & RELAYS

### ▼ ROTARY SWITCHES OFFER COMPACT DESIGN

The SDB161 4- and 5-bit-output rotary-encoded switches are compact devices with a 0.827-in. diameter and a low 0.394-in. profile. The units address the need for absolute-reference digital output-panel controls. They replace expensive panel displays with simple panel markings.

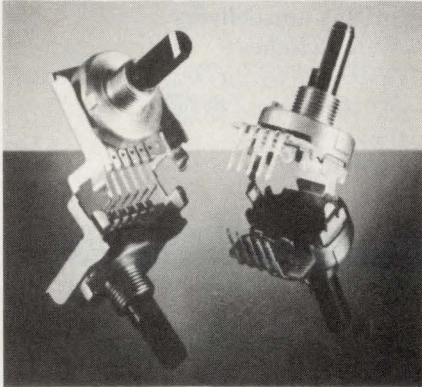

The 4-bit models offer 12 or 16 detented positions, and the 5-bit types have 24 or 32 positions. Pricing ranges from \$0.95 to \$1.20 each in lots of 10,000. Delivery is from stock.

**Noble U.S.A. Inc.**  
5450 Meadowbrook  
Industrial Ct.  
Rolling Meadows, IL 60008  
(708) 364-6038  
► CIRCLE 777

### ▼ MINI ROCKER SWITCH FITS PANEL CUTOUTS

The popular 19-by-13-mm panel cut-out is just right for the Types R9 and RA miniature rocker switches. The units come in single- or double-pole configurations, in lighted or non-

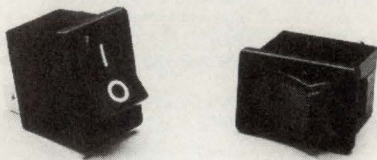

lighted versions, and with maintained or momentary functions. Pricing for non-lighted switches starts at \$0.91 for 500 pieces. Lighted versions start at \$1.45 in like quantities. Delivery is in eight to 10 weeks.

**Oslo Controls Inc.**  
328 Industrial Ave.  
Cheshire, CT 06410  
(203) 272-2794  
► CIRCLE 778

## SWITCH AND RELAY MANUFACTURERS

**Carroll Touch**  
P.O. Box 1309  
Round Rock, TX 78680-1309  
(512) 244-3500  
(TS)  
CIRCLE 635

**Cherry Electrical Products**  
3600 Sunset Ave.  
Waukegan, IL 60087  
(708) 662-9200  
(IL) (KB) (MB) (PX) (PU) (RO)  
(SA) (TH)  
CIRCLE 636

**Cole Instrument Corp.**  
2650 S. Croddy Way  
Santa Ana, CA 92704  
(714) 556-3100  
(KL) (PC) (RO) (ST) (SM)  
CIRCLE 637

**Communications Insts. Inc.**  
Box 520, Hwy. 74 E.  
Fairview, NC 28730  
(704) 628-1711  
(CX) (CC) (FP) (HS) (ML) (MI)  
(PB) (PW) (RT) (TE)  
CIRCLE 638

**Conductive Rubber Technology**  
22125 17th Ave. S.E.,  
Suite 117  
Bothell, WA 98021  
(206) 486-8559  
(IL) (KB) (MB) (PC) (PU) (RK)  
(SA) (SM)  
CIRCLE 639

**Contaq Technologies Corp.**  
15 Main St.  
Bristol, VT 05443  
(802) 453-3332  
(PX)  
CIRCLE 640

**Control Products Inc.**  
280 Ridgedale Ave.  
East Hanover, NJ 07936  
(201) 887-9400  
(PU) (SA) (TG)  
CIRCLE 641

**Coto Wabash**  
a Kearney-National Co.  
55 Dupont Dr.  
Providence, RI 02907-3105  
(401) 943-2686  
(CX) (DR) (HS) (HF) (ML)  
(MW) (PW) (TE) (VS)  
CIRCLE 642

**Cruzet Corp.**  
2445 Midway Rd.  
Carrollton, TX 75006-2503  
(214) 250-1647  
(AP) (PC) (PH) (PX) (PU)  
(RK) (SA) (SM) (TH) (TG)  
(AS) (CS) (DS) (IO) (PW) (TD)  
(VS)  
CIRCLE 643

**Crydom Co.**  
6015 Obispo Ave.  
Long Beach, CA 90805  
(213) 865-3536  
(AS) (DS) (FP) (IO) (OI) (PB)  
(PW) (TD)  
CIRCLE 644

**Detroit Controls**  
Div. of Deltronic Corp.

2745 S. 19 St.  
Milwaukee, WI 53215  
(414) 671-6800  
(HD) (ML) (TD)  
CIRCLE 645

**Dialight Co.**  
1913 Atlantic Ave.  
Manasquan, NJ 08736  
(201) 223-9400  
(PC) (SM) (IL) (PU) (TG)  
CIRCLE 646

**Dionics Inc.**  
65 Rushmore St.  
Westbury, NY 11590  
(516) 997-7474  
(AS)  
CIRCLE 647

**Douglas Corp.**  
620 12th Ave. South  
Minneapolis, MN 55415  
(612) 333-8911  
(MB)  
CIRCLE 648

**Douglas Randall Inc.**  
6 Pawcatuck Ave.,  
P.O. Box 506  
Pawcatuck, CT 06379  
(203) 599-2075  
(CS) (DS) (DR) (HF) (ML)  
(MW) (OI) (PB) (PW) (TD)  
(VS)  
CIRCLE 649

**Dreefs Switch Inc.**  
3782 Hawthorn Ct.  
Waukegan, IL 60087  
(708) 662-7667  
(IL) (PC) (PU) (RK) (RO)  
CIRCLE 650

**EAO Switch Corp.**  
198 Pepe's Farm Rd.  
Milford, CT 06460  
(203) 877-4577  
(IL) (KB) (KL) (MB) (PC) (PU)  
(SA)  
CIRCLE 651

**EEO Inc.**  
Electronic Keypad Div.  
5436 W. Latham St.  
Phoenix, AZ 85043  
(602) 272-5645  
(MB)  
CIRCLE 652

**EEO Inc.**  
1601 E. Chestnut Ave.  
Santa Ana, CA 92702  
(714) 835-6000  
(KB) (MB) (PC) (RO) (TH)  
CIRCLE 653

**Eaton Corp.**  
Aerospace & Commercial  
Controls  
4201 N. 27th St., Dept. H129  
Milwaukee, WI 53216  
(414) 449-7483  
(AP) (IL) (KB) (KL) (PC) (PU)  
(RK) (SL) (SA) (TG)  
(CT) (CS) (DS) (HD) (HS)  
(ML) (MI) (PW) (VS)  
CIRCLE 654

**Electro-Mech Components Inc.**  
1826 N. Floradale Ave.  
South El Monte, CA 91733

(818) 442-7180  
(IL) (PU)  
CIRCLE 655

**Electronic Components Group**  
26 North 5th St.  
Minneapolis, MN 55403  
(612) 375-9639  
(IL) (KB) (PC) (PU) (RK) (RO)  
(SL) (SM) (TG)  
CIRCLE 656

**Electronic Instruments & Specialty**  
Div. of Prime Technology  
Inc.  
P.O. Box 185, Twin Lakes Rd.  
North Branford, CT 06471  
(203) 481-5721  
(AS) (CS) (DR) (ML) (MW)  
CIRCLE 657

**Electronic Specialty Corp.**  
P.O. Box 3501  
Vancouver, WA 98668-3501  
(206) 574-5000  
(CX) (CT) (CC) (CS) (HS)  
(ML) (MI) (PB) (PW) (TD) (VS)  
CIRCLE 658

**Electroswitch Corp.**  
180 King Ave.  
Weymouth, MA 02188  
(617) 335-5200  
(KL) (PC) (RO) (SA) (PW)  
(RT)  
CIRCLE 659

**Elma Electronic Inc.**  
41440 Christy St.  
Fremont, CA 94538  
(415) 656-3400  
(DP) (IL) (KB) (KL) (MB) (PC)  
(PU) (RO) (TG)  
CIRCLE 660

**Erni Components**  
Div. of Odin  
520 Southlake Blvd.  
Richmond, VA 23236  
(804) 794-6367  
(PC) (PU) (TH) (DR) (TE)  
CIRCLE 661

**FR Industries Inc.**  
Celduc  
557 Long Rd.  
Pittsburgh, PA 15235  
(412) 242-5903  
(AS) (AU) (CT) (DS) (DR) (IO)  
(MW) (MI) (OI) (PB) (PW)  
(TE) (TD)  
CIRCLE 662

**Fifth Dimension Inc.**  
801 New York Ave.  
Trenton, NJ 08638  
(609) 393-8350  
(AC) (PX) (HS) (HF) (ML)  
(MW) (MI) (TE)  
CIRCLE 663

**Fujitsu Components of America**  
3545 N. First St.  
San Jose, CA 95134-1804  
(408) 992-9000  
(AU) (DR) (FP) (HD) (HF)  
(ML) (PB) (PW) (TE)  
CIRCLE 664

(see p. 114 for key)  
(continued on p. 108)

# POWER-ONE D.C. POWER SUPPLIES

## Not Only The Best...The Best Selection, Too

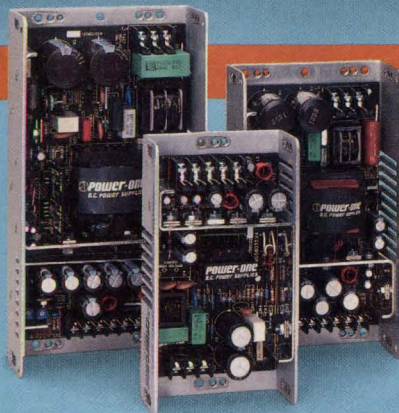

### SWITCHERS

POWER-ONE'S International Switcher Series incorporates the latest state-of-the-art switching technology while providing POWER-ONE's traditional high quality at low prices. With certification to the world's toughest safety agency requirements, the series is especially suited for products sold not only domestically, but internationally as well. • **85 models** . . . **40 watts to 400 watts** • **Efficient** . . . **reliable** . . . **economical** • **VDE construction** • **Up to 5 fully regulated outputs** • **Full international safety and EMI approvals**

### LINEARS

POWER-ONE'S International Linear Series is the world's undisputed leader in versatile, cost-effective linear power supply products. A long-time favorite of designers and engineers worldwide, the series is the most widely purchased power supply line through distribution in the industry. The most popular voltage and current combinations are available in a wide variety of off-the-shelf standard models. • **Popular industry standard packages** • **77 models** . . . **6 watts to 280 watts** • **± 0.05% regulation** • **Up to 4 fully regulated outputs** • **Worldwide safety approvals**

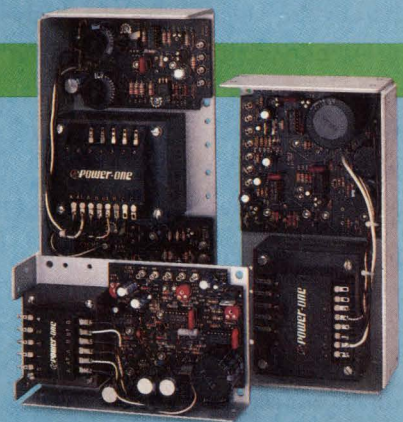

### HIGH POWER

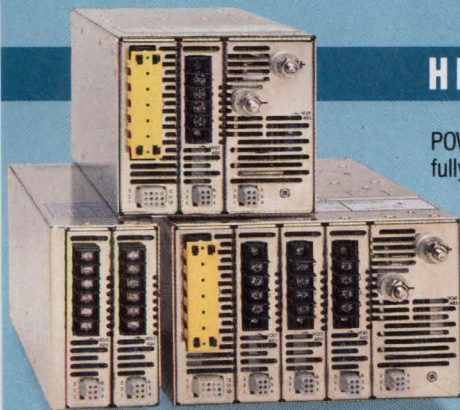

POWER-ONE'S International High Power Series is the industry's only true fully-modular high power product line. Specify a power system that meets your exact requirements from a wide selection of single, dual and triple output plug-in power modules. Virtually any combination of output voltage and current rating can be delivered from stock. • **500 watts to 1500 watts** • **Fully modular construction** • **Up to 15 fully regulated outputs** • **UPS battery backup option** • **Parallelable outputs with current sharing**

**TOLL-FREE  
LITERATURE  
HOT-LINE:  
(800) 678-9445**



POWER-ONE offers one of the largest selections of switcher, linear, and high power standard models in the world. So, whatever your D.C. power supply requirement calls for, make POWER-ONE your first choice and be sure you're getting the best—not only in quality, but selection and value as well. Call today for our new 1990 catalogs.

*"Innovators in Power Supply Technology"*  
**1 POWER-ONE**  
**D.C. POWER SUPPLIES**

POWER-ONE, INC.  
740 Calle Plano • Camarillo, CA 93012-8583  
Phone: (805) 987-8741 • (805) 987-3891  
TWX: 910-336-1297 • FAX: (805) 388-0476



CIRCLE 260 FOR U.S. RESPONSE

CIRCLE 261 FOR RESPONSE OUTSIDE THE U.S.

## Memories, ASICs, and Logic ICs Deliver High-End Performance.

**F**or high-end workstation and PC applications, Oki offers a range of ICs with the powerful performance features your high-level board designs demand.

**1-Meg Based VRAMs.** Oki's high-bandwidth video RAMs enable the up-front performance required for high-resolution graphic applications. Features include dual port memory and fast access times.

**0.8 $\mu$ m Gate Arrays.** Manufactured on our volume 4-Mb line, Oki's SOGs offer exceptional benefits: high-speed logic and I/O performance, high-density macro-functions, high pin count packages, and more.

**Field Memory.** There's no better solution for a frame grabber design than Oki's high-performing 1-Mb serial memory. Features include an internal self-refresh control circuit, making this device appear fully static to the user.

**Speech Synthesis.** For high-quality performance you can hear, no one matches Oki's RealVoice™ speech synthesizers. With on-chip filter and D/A, these chips reduce design time and IC count while increasing system reliability.

**16-Bit MCU.** Oki's nX family of fast MCUs combines a three-program instruction pre-fetch queue to lower overall CPU cycle time down to 200 ns. Features include a variety of I/O options plus 16K of 16-bit word ROM and 512 bytes of RAM.

Start packing more performance into your system with Oki ICs. Call 1-800-OKI-6388 for the details.

### Oki High-Performance ICs

Part Number	Description
MSM514252	High-bandwidth, 262,144 x 4-bit VRAM
MSM514221A	262,263-word x 4-bit, 1-Mb serial memory with self-refresh control circuit
MSM10S0000	0.8 $\mu$ m SOGs, true 82xx, UARTs, memories, standard 24ma drive, 300ps, >500MHz logic
MSM6388	Solid-state recorder/IM serial register I/F
MSM67620	16-bit MCU with 16KB ROM, 512B RAM, 56 I/Os, 3 x 16-bit timers, 2 x 8-bit timers



**TRANSFORMING TECHNOLOGY INTO CUSTOMER SOLUTIONS**



# PERFORMANCE UP FRONT STARTS WITH OKI ON BOARD.



**OKI**  
Semiconductor

785 North Mary Avenue  
Sunnyvale, CA 94086-2909  
1-800-OKI-6388

CIRCLE 130 FOR U.S. RESPONSE  
CIRCLE 131 FOR RESPONSE OUTSIDE THE U.S.

## SWITCHES & RELAYS

### ▼ MINI PUSHBUTTON COMES IN MANY STYLES

Square, round, and high-round-bezel versions are available for the Series 59 miniature pushbutton switches. The sealed units also come in three button colors and have gold contacts, solder terminals, and momentary-action switching. Switch bodies are

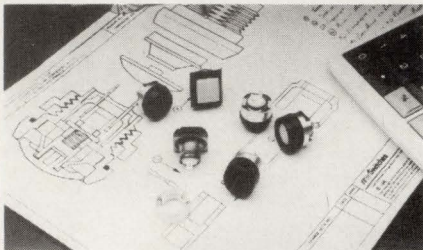

made of a non-sparking zinc alloy that's suitable for explosive atmospheres. Options include pc-board terminals and a chemical overboot. Call for pricing and delivery.

#### *ITW Switches*

6615 W. Irving Park Rd.  
Chicago, IL 60634  
(312) 282-4040

► CIRCLE 779

### ▼ SUBMINI PUSHBUTTON OFFERS MULTIPLE POLES

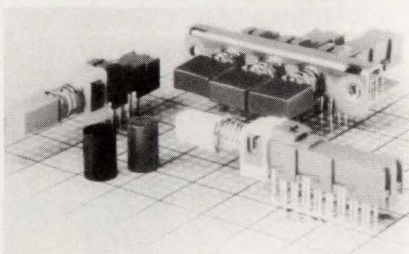

A choice of two-, four-, or six-pole double-throw switching is offered in a board height of less than 3/8 in. with the PHA series pushbutton switch. The subminiature device comes with single switch action in either push-push or momentary actions or up to seven switch stations with interlocking action. Pricing ranges from \$0.30 to \$0.50 depending on quantity and configuration. Delivery is from stock to 10 weeks.

#### *ITT Shadow Inc.*

8081 Wallace Rd.  
Eden Prairie, MN 55344  
(612) 934-4400

► CIRCLE 780

### ▼ LIGHTED PUSHBUTTONS OUTSHINE THE SUN

Superior sunlight readability, high reliability, and shallow depth behind the panel are features of the Series 584 5/8-in.-square lighted pushbutton switch. The units can be matrix or individually mounted for use in avionics systems and cockpit applications. The switch offers a proven snap-action design with up to four poles in a body just 1-1/2-in. long.

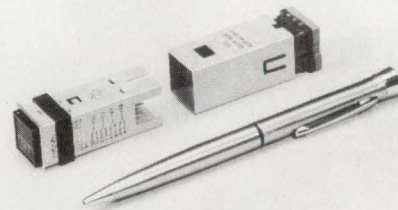

Call for pricing and delivery.

#### *Eaton Corp.*

*MSC Products*  
1640 Monrovia Ave.  
Costa Mesa, CA 92627  
(714) 642-2427

► CIRCLE 781

## SWITCH AND RELAY MANUFACTURERS

#### **GM Nameplate Inc.**

Intaq  
2040 15th Ave. West  
Seattle, WA 98119-2783  
(206) 284-5475  
(IL) (KB) (MB)  
CIRCLE 665

#### **General Instrument Corp.**

CP Clare Div.  
3101 W. Pratt Ave.  
Chicago, IL 60645  
(312) 262-7700  
(MR) (SM) (AS) (DS) (HR)  
(IO) (MW) (PB) (CX) (CS)  
(DF) (HD) (HS) (HF) (ML)  
(DR)  
CIRCLE 666

#### **Genicom Corp**

Relay Products Div.  
One Genicom Dr.  
Waynesboro, VA 22980  
(703) 949-1471  
(CC) (CS) (HS) (ML) (MI) (VS)  
CIRCLE 667

#### **George Risk Industries**

802 S. Elm St.  
Kimball, NE 69145  
(308) 235-4645  
(PC) (IL) (KL) (PU)  
CIRCLE 668

#### **Globtek Inc.**

7700 Marine Rd.  
North Bergen, NJ 07047  
(201) 861-0246  
(IL) (PU) (RK) (SL) (TG)  
(AS) (DS) (FP) (HD) (PB)  
(PW) (TD) (VS)  
CIRCLE 669

#### **Gordon Products Inc.**

67 Del Mar Dr.  
Brookfield, CT 06804  
(203) 775-4501  
(PX)  
CIRCLE 670

#### **Gordos Corp.**

1000 N. Second St.  
Rogers, AR 72756  
(800) 643-3500  
(HD) (DR) (DS)  
CIRCLE 671

#### **Grayhill Co.**

561 Hillgrove Ave.  
La Grange, IL 60525  
(708) 354-1040  
(DP) (KB) (KL) (PC) (PH) (PU) (AC) (IL) (KB) (MR) (PC) (PX)  
(RO) (SM) (AS) (DS) (IO) (OI) (PU) (SA) (SM) (CX) (CS)  
(PB) (PW)  
CIRCLE 672

#### **Grimes Co.**

115 S. Arovista Cir.  
Brea, CA 92621  
(714) 671-3931  
(PU)  
CIRCLE 673

#### **Guardian Electric Mfg. Co.**

1425 Lake Ave.  
Woodstock, IL 60098  
(815) 337-0050  
(CS) (HS) (DS)  
CIRCLE 674

#### **Hall Co.**

420 E. Water St.  
Urbana, OH 43078  
(513) 652-1376  
(MB)  
CIRCLE 675

#### **Hallmark Technologies**

1717 E. Lincoln Ave.  
Mt. Dora, FL 32757  
(904) 383-8142  
(MB) (PC) (SA)  
CIRCLE 676

#### **Hamilton Standard Controls**

131 Godfrey St.  
Logansport, IN 46947  
(219) 753-7521  
(CT) (CS) (HD) (TD)  
CIRCLE 677

#### **Hamlin/Electrol**

612 E. Lake St.  
Lake Mills, WI 53551  
(414) 648-3000  
(AC) (IL) (KB) (MR) (PC) (PX)  
(PU) (SA) (SM) (CX) (CS)  
(DR) (HS) (ML) (MW) (MI)  
(PB) (PW) (TE) (VS)  
CIRCLE 678

#### **Hasco Components Inc.**

247-40 Jericho Tpke.  
Bellerose Village, NY 11001  
(800) 852-5050  
(PX) (AU) (FP) (HD) (ML)  
(MW) (PB) (PW) (TE)  
CIRCLE 679

#### **Haydon Switch & Instrument Inc.**

1500 Meriden Rd.  
Waterbury, CT 06705  
(203) 756-7441  
(SA)  
CIRCLE 680

#### **Heinemann Electric Co.**

Brunswick Pike  
Lawrenceville, NJ 08648

(609) 882-4800

(PC) (PU) (TG)  
CIRCLE 681

#### **Hermetic Switch Inc.**

P.O. Box 1325  
Chickasha, OK 73018  
(405) 224-4046  
(PX) (MR) (HS)  
CIRCLE 682

#### **Hi-G Co.**

Struthers-Dunn  
Lambs Rd.  
Pitman, NJ 08071-0901  
(609) 589-7500  
(MI)  
CIRCLE 683

#### **IEE**

Planar Prods. Div.  
7740 Lemona Ave.  
Van Nuys, CA 91405  
(818) 787-0311  
(IL) (MB) (PU)  
CIRCLE 684

#### **ITT Components**

5 Jenner St.  
Irvine, CA 92718  
(714) 727-3001  
(DS) (FP) (HD) (HF) (ML) (PB)  
(PW) (TE) (VS)  
CIRCLE 685

#### **ITT Shadow Inc.**

8081 Wallace Rd.  
Eden Prairie, MN 55344  
(612) 934-4400  
(DP) (IL) (KB) (PC) (PU) (RK)  
(RO) (SL) (SM) (PB) (TE)  
CIRCLE 686

#### **ITW Switches**

6615 W. Irving Park Rd.  
Chicago, IL 60634  
(312) 282-4040  
(IL) (KL) (PC) (PU) (RK) (RO)  
(SL) (SA) (SM)  
CIRCLE 687

#### **IVO Industries Inc.**

201 Industrial Way W.  
Eatontown, NJ 07724  
(908) 542-5151  
(PX) (TH)  
CIRCLE 688

#### **Illinois Lock Co.**

Eastern Co.  
307 W. Hintz Rd.  
Wheeling, IL 60090  
(708) 537-1800  
(IL) (KL) (RO)  
CIRCLE 689

#### **Imtronics Industries Ltd.**

11930 31st Ct. N.  
St. Petersburg, FL 33716  
(813) 572-9010  
(DP) (IL) (PU) (RK) (RO) (SL)  
(TG)  
CIRCLE 690

#### **Inter-Market Inc.**

1946 Lehigh Ave.  
Glenview, IL 60025  
(708) 729-5330  
(SM) (IL) (PU) (TH)  
CIRCLE 691

(see p. 114 for key)

(continued on p. 110)

# Somewhere in the world a Sanyo battery is being "designed-in" to a high performance application.

## Right now.

Industry leaders select industry leaders.

**CADNICA.** In 1964 Sanyo's proprietary technology led to a breakthrough battery that withstands continuous overcharging and overdischarging...the sealed, rechargeable nickel cadmium Cadnica.

**LITHIUM.** Sanyo developed the technology for manganese dioxide compounds to be used in Lithium batteries which produced a cell with high voltage and high energy density characteristics.

**CADNICA EXTRA.** Sanyo's Cadnica E series incorporates high-density electrode plates in a new concept design for 40% greater capacity than conventional batteries and 1-hour charge capability via Sanyo's  $-\Delta V$  voltage sensor changing method.

**SOLAR.** Sanyo leads the development of solar cells with the application of amorphous silicon for physical flexibility and the ability to be fabricated into large-area cells.

**NiMH.** Sanyo's proprietary electrode manufacturing process and built-in resealable safety vent lead the development of high capacity, high performance rechargeable, Nickel Metal Hydride batteries.

If you're developing an industry leading product right now, perhaps you should contact Sanyo... right now.

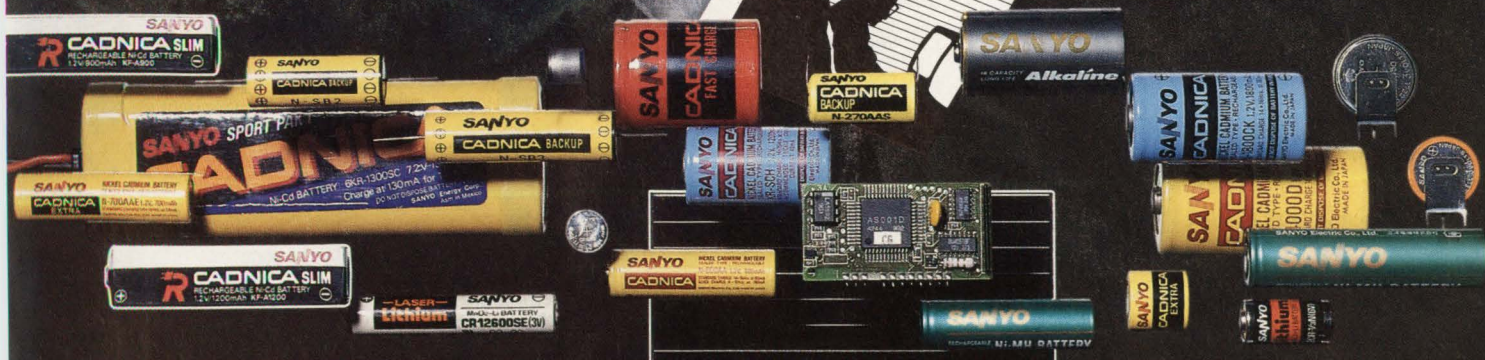

For specification and design assistance please contact your regional Sanyo sales office at the following address:

SANYO Energy (U.S.A.) Corporation  
2001 Sanyo Avenue  
San Diego, California 92173  
(619) 661-6620

In Florida: (904) 376-6711  
In Illinois: (312) 595-5600  
In New Jersey: (201) 641-2333  
In Georgia: (404) 279-7377  
In Dallas: (214) 480-8345

CIRCLE 236 FOR U.S. RESPONSE CIRCLE 237 FOR RESPONSE OUTSIDE THE U.S.



SANYO Energy (USA) Corporation

## SWITCHES & RELAYS

### ▼ SNAP-ACTING SWITCHES OPERATE WITH LOW FORCE

Forces as low as 15 grams (0.53 oz) are enough to actuate the TF-CC or CD Series snap-action switches. The units meet UL, CSA, and VDE requirements and are available in 1-A, 3-A, or 5-A ratings in SPDT and

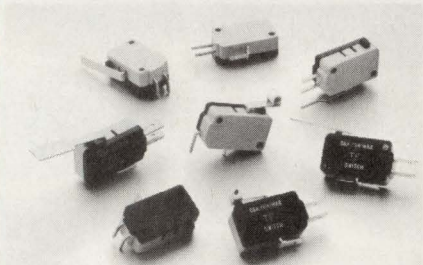

SPST configurations. Various actuators are available, including standard pin plungers, wide pin plungers, levers, and others. Volume pricing starts at under \$1. Delivery is in eight weeks. Samples are available immediately upon request.

*Unimax, A Division of C&K*

P.O. Box 152

Wallingford, CT 06492

(203) 269-8701

► CIRCLE 782

### ▼ LIGHTED KEYSWITCH CHANGES LEGEND EASILY

Interchangeable legend plates are featured in the MMT/MMS key-switches. Also featured are a low profile and medium-stroke contact travel of 3.2 mm. Switching action is momentary or maintained. A folded

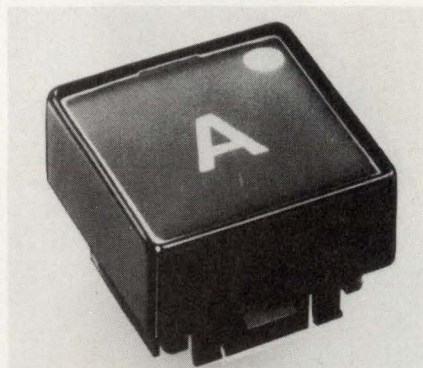

metal strip provides a smooth gliding, self-cleaning contact spring action. Prices range from \$1.74 to \$3.84 in lots of 100. Delivery is from stock to six to eight weeks.

*Schurter Inc.*

1016 Clegg Ct.

Petaluma, CA 94954

(707) 778-6311

► CIRCLE 783

## SWITCH AND RELAY MANUFACTURERS

### International Rectifier

233 Kansas St.  
El Segundo, CA 90245  
(213) 772-2000  
(HD) (OI) (DS) (TD)  
CIRCLE 692

### Interswitch

W.J. Purdy Co.  
770 Airport Blvd.  
Burlingame, CA 94010  
(415) 347-8217  
(RO) (TH)  
CIRCLE 693

### JAE Electronics Inc.

1901A E. Carnegie  
Santa Ana, CA 92705  
(714) 753-2600  
(DP) (IL) (KL) (PU) (RO)  
CIRCLE 694

### Janco Corp.

3111 Winona Ave.  
Burbank, CA 91504  
(818) 846-1800  
(PU) (RO)  
CIRCLE 695

### Key Tronic Corp.

P.O. Box 14687, M/S 143  
Spokane, WA 99214  
(509) 928-8000  
(MB)  
CIRCLE 696

### Kidde Inc.

Douglas Randall Div.  
P.O. Box 506  
Pawcatuck, CT 06379  
(800) 447-6799  
(CT) (CS) (DF) (HD) (HF)  
(ML) (OI) (DR) (DS) (TD)  
CIRCLE 697

### Kilovac Corp.

P.O. Box 4422  
Santa Barbara, CA 93140  
(805) 684-4560  
(CT) (DR) (HD) (HS) (HF)  
(ML) (MI) (PB) (PW) (VS)  
CIRCLE 698

### LSI Jennings

970 McLaughlin Ave.  
San Jose, CA 95122  
(408) 292-4025  
(AP) (CO) (PC) (CX) (CT)  
(HD) (HS) (HF) (ML) (MI) (PB)  
(PW)  
CIRCLE 699

### LVC Industries Inc.

Co-Ord Switch Div.  
23 Hanse Ave.  
Freeport, NY 11520  
(516) 868-1900  
(SL)  
CIRCLE 700

### Lamb Industries Inc.

P.O. Box 25110  
Portland, OR 97225  
(800) 824-9374  
(DP) (IL) (PC) (PU) (RK) (RO)  
(SL) (SA) (SM) (TG)  
CIRCLE 701

### Leach Corp.

6900 Orangethorpe Ave.  
Buena Park, CA 90622-5032  
(714) 739-0770  
(CT) (CS) (DS) (HS) (ML) (MI)

(OI) (PW) (RT) (TD) (VS)  
CIRCLE 702

### Leach Corp.

Relay Group  
5915 Avalon Blvd.  
Los Angeles, CA 90003  
(213) 232-8221  
(CT) (HD) (HS) (ML)  
CIRCLE 703

### Liberty Controls

500 Brookforest Ave.  
Shorewood, IL 60435  
(815) 725-2241  
(HD) (ML) (PW) (TE)  
CIRCLE 704

### Line Electric Products

Div. of General Electric  
P.O. Box 327  
Hartford, CT 06141  
(203) 659-3573  
(PC) (IL) (PU) (TG) (CT) (CS)  
(HD) (HS) (HF) (ML) (TE) (TD)  
CIRCLE 705

### Littelfuse-Tracor

800 E. Northwest Hwy.  
Des Plaines, IL 60016  
(708) 824-1188  
(PU) (TG)  
CIRCLE 706

### Lucas Ledex Inc.

P.O. Box 427  
Vandalia, OH 45377  
(513) 898-3621  
(IL) (KB) (KL) (PC) (PU) (RO)  
(ST) (SM)  
CIRCLE 707

### MORS/ASC

134 Water St.  
Wakefield, MA 01880  
(617) 246-1007  
(DP) (IL) (KL) (PC) (PU) (RK)  
(SL) (SA) (SM) (TH) (TG)  
CIRCLE 708

### Magnecraft Electric Co.

1910 Techny Rd.  
Northbrook, IL 60062-5376  
(708) 564-8800  
(AS) (AU) (CX) (CT) (CS)  
(DS) (DR) (FP) (HD) (HS) (HF)  
(IO) (ML) (MW) (MI) (OI) (PB)  
(PW) (TE) (TD) (VS)  
CIRCLE 709

### Mantex Corp.

1800 Metamora Rd.  
Oxford, MI 48051  
(313) 628-8200  
(KB) (MB) (PC) (PU)  
CIRCLE 710

### Marquardt Switches Inc.

Route 20E  
Cazenovia, NY 13035  
(315) 655-8050  
(PC) (IL) (PU) (SL) (TG)  
CIRCLE 711

### Master Elec. Controls

P.O. Box 25905  
Los Angeles, CA 90025  
(213) 452-1336  
(CX) (CT) (CS) (DF) (HD)  
(HS) (HF) (ML) (OI) (DR) (DS)  
(TE) (TD)  
CIRCLE 712

### McGill Mfg. Co. Inc.

1002 N. Campbell St.  
Valparaiso, IN 46383  
(219) 465-2200  
(IL) (TG)  
CIRCLE 713

### Memtron Technologies

1400 Weiss St.  
Frankenmuth, MI 48734  
(517) 652-2656  
(MB)  
CIRCLE 714

### Micro Switch

Div. of Honeywell Inc.  
11 West Spring St.  
Freeport, IL 61032  
(815) 235-5731  
(KL) (MR) (PH) (PX) (PU)  
(RK) (RO) (SA) (TG)  
CIRCLE 715

### Microavionics Corp.

3198 Airport Loop Dr. #K  
Costa Mesa, CA 92626  
(714) 957-6904  
(RO)  
CIRCLE 716

### Midtex Relays Inc.

9-B2 Butterfield Tr.  
El Paso, TX 79906  
(915) 772-1061  
(CS) (DR) (HS) (ML) (MW)  
(PW) (TD) (VS)  
CIRCLE 717

### Minelco Inc.

Talley Industries  
135 S. Main St.  
Thomaston, CT 06787  
(203) 283-8261  
(PC) (RO) (SL)  
CIRCLE 718

### Mini-Circuits

P.O. Box 350166  
Brooklyn, NY 11235-0003  
(718) 934-4500  
(PC) (SM)  
CIRCLE 719

### Molex Inc.

Switch Prods. Div.  
2222 Wellington Ct.  
Lisle, IL 60532  
(708) 969-4747  
(IL) (KB) (MB) (PU) (SA)  
CIRCLE 720

### NKK Switches Inc.

7850 E. Gelding Dr.  
Scottsdale, AZ 85260  
(602) 991-0942  
(IL) (PC) (PU) (RK) (RO) (SL)  
(SM) (TG)  
CIRCLE 721

### Noble USA Inc.

5450 Meadowbrook Ind. Ct.  
Rolling Meadows, IL 60008  
(708) 364-6038  
(DP) (PC) (PU) (RK) (RO)  
(SL) (SA) (SM)  
CIRCLE 722

(see p. 114 for key)

(continued on p. 112)

# Why our chip inductors are more attractive for your high frequency applications

Theirs.

Ours.

The point of this little demonstration is that Coilcraft surface mount inductors are made of ceramic. A decidedly non-magnetic material.

Most other chip inductors are made of ferrite. Which is great for demonstrating the principles of magnetism, but not so hot for high frequency magnetics.

Take self resonance, for example. SRFs on our coils are up to 3 times higher than equivalent ferrite chips. And located a safe distance away from your operating frequency.

The actual inductance you'll get with Coilcraft chips at higher

frequencies is very predictable and consistent. Not so with ferrites. Beyond the test frequency, their inductance curves rise steeply and vary significantly from part to part.

Coilcraft ceramic chips also have a low temperature coefficient of inductance: +25 to +125 ppm/°C, depending on inductance. TCLs on ferrite chips are often two to four times higher!

And if you need close tolerance parts, we offer even more advantages. Thanks to our computer - controlled manufacturing and ceramic's neutral properties, it's easier for us to make 5% or 2%

parts. We can even production-test at your operating frequency! Other chip makers have to cope with ferrite's permeability variations, so their yields are lower. Which means delivery can be unpredictable.

So next time you're selecting surface mount inductors, forget the ferrite and stick with Coilcraft ceramic chips.

For complete specifications and information on our handy Designer's Kits of sample parts, circle the reader service number. Or call 800/322-COIL.

*Coilcraft*

See our catalog in Vol. A, Section 1800  
CEM / electronic engineers master

1102 Silver Lake Rd., Cary IL 60013 800/322-COIL Fax 708/639-1469

CIRCLE 152 FOR U.S. RESPONSE

CIRCLE 153 FOR RESPONSE OUTSIDE THE U.S.

## SWITCHES & RELAYS

### ▼ MINI TOGGLE SWITCHES CAN'T BE TEASED

Non-teasible contact transfer is featured in the T3 Series of miniature toggle switches. The rugged, highly reliable devices weigh 25% less than competitive switches and offer a positive detent for safe operation. High contact pressure and superior wiping action let the T3 Series switch loads up to 5 A. One- or two-pole cir-

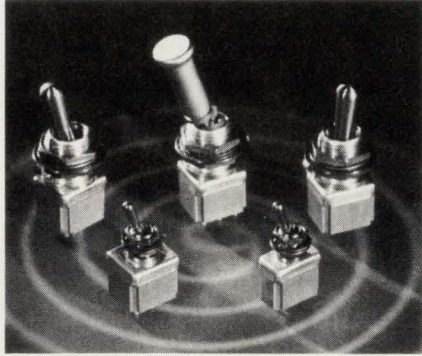

cuitry is available. Pricing starts at \$8 for a mini bat handle, 1/4-40 bushing model with DPDT contacts. Delivery is in four to six weeks.

#### **OTTO Controls**

2 E. Main St.  
Carpentersville, IL 60110  
(708) 428-7171

► CIRCLE 784

### ▼ SEALED SNAP SWITCH IS WORLD'S SMALLEST



The Turquoise line of sealed snap-action switches includes the ultra-mini ABJ1 Series, which at 12.8 mm by 6.0 mm by 6.5 mm is claimed to be the world's smallest sealed snap-action switch. Thanks to an elastomer double-molded sealing technology, the Turquoise switches cost up to 40% less than traditional epoxy-sealed switches, making them cost-competitive with unsealed switches. Call for pricing and delivery.

#### **Aromat Corp.**

629 Central Ave.  
New Providence, NJ 07974  
(908) 464-3550

► CIRCLE 785

### ▼ TRANSPARENT MEMBRANES ENHANCE INTERFACES

In serving as an ergonomically appealing interface, transparent membrane switches enhance the visual interface between non-technical operators and sophisticated software ap-



plications. The switches are totally sealed for use in most clinical or hazardous environments. Units can be designed with various sensitivities to avoid false or inadvertent data entries. Costly electronics and sensing devices are not required for operation. Call for pricing and delivery.

#### **Memtron Technologies Inc.**

1400 Weiss St.  
Frankenmuth, MI 48734  
(517) 652-2656

► CIRCLE 786

## SWITCH AND RELAY MANUFACTURERS

**Nytronics**  
Struthers Dunn/Hi-G  
Lambs Rd.  
Pitman, NJ 08071  
(609) 589-7500  
(MI)  
CIRCLE 723

**Nytronics Inc.**  
sub. Struthers-Dunn Inc.  
700 Orange St.  
Darlington, SC 29532  
(803) 393-5421  
(CT) (DR) (HD) (ML) (MW)  
(PB) (TD)  
CIRCLE 724

**OakGrigsby**  
100 S. Main St.  
Crystal Lake, IL 60014  
(815) 459-5000  
(IL) (KL) (PC) (PU) (RK) (RO)  
CIRCLE 725

**Omega Engineering Inc.**  
1 Omega Dr.  
Stamford, CT 06907  
(203) 359-1660  
(RO) (ML) (DS)  
CIRCLE 726

**Omron Electronics Inc.**  
Control Components Div.  
1 E. Commerce Dr.  
Schaumburg, IL 60173  
(708) 843-7900

(DP) (IL) (KB) (KL) (PC) (PH)  
(PU) (RO) (SA) (TH) (AS)  
(AU) (CT) (DS) (FP) (HD) (HS)  
(HF) (IO) (ML) (OI) (PB) (PW)  
(TE) (TD)  
CIRCLE 727

**Opto 22**  
15461 Springdale St.  
Huntington Beach, CA 92647  
(714) 891-5861  
(AS) (DS)  
CIRCLE 728

**Orbit Instrument  
of California**  
6431 Global Dr.  
Cypress, CA 90630  
(714) 527-0561  
(IL) (PU)  
CIRCLE 729

**Oslo Controls**  
328 Industrial Ave.  
Cheshire, CT 06410  
(203) 272-2794  
(IL) (KL) (PC) (PU) (RK)  
CIRCLE 730

**Otto Controls**  
2 E. Main St.  
Carpentersville, IL 60187  
(708) 428-7171  
(PC) (PU) (RK) (SL) (SA) (TG)  
CIRCLE 731

**Pass & Seymour Inc.**  
P.O. Box 4822  
Syracuse, NY 13221  
(315) 468-6211  
(IL) (KL) (TG)  
CIRCLE 732

**Philips Components**  
2001 W. Blue Heron Blvd.  
Riviera Beach, FL 33404  
(407) 881-3308  
(DP) (MR) (PC) (RO) (SM)  
CIRCLE 790

**Potter & Brumfield Inc.**  
200 S. Richland Creek Dr.  
Princeton, IN 47671-0001  
(812) 386-2316  
(AS) (AU) (CT) (CS) (DS)  
(DR) (FP) (HD) (HS) (IO) (ML)  
(MW) (OI) (PB) (PW) (RT)  
(TE) (TD) (VS)  
CIRCLE 733

**Preh Electronic Industries  
Inc.**  
470 E. Main St.  
Lake Zurich, IL 60047-2578  
(708) 438-4000  
(KB) (PC) (PU) (SL)  
CIRCLE 734

**Pres:Air:Trol Corp.**  
1009 W. Boston Post Rd.  
Mamaroneck, NY 10543  
(914) 698-2026

(AP) (PC) (PU) (SA)  
CIRCLE 735

**RLC Electronics Inc.**  
83 Radio Circle  
Mt. Kisco, NY 10549  
(914) 241-1334  
(CX) (ML)  
CIRCLE 736

**Regent Controls Inc.**  
39 Fanny St.  
Shelton, CT 06484  
(203) 934-2924  
(AS) (CS) (DS) (HF) (IO) (OI)  
(TD) (VS)  
CIRCLE 737

**SSAC Inc.**  
P.O. Box 1000  
Baldwinsville, NY 13027  
(315) 638-1300  
(AS) (CS) (IO) (OI) (TD) (VS)  
CIRCLE 738

**Sage Laboratories Inc.**  
11 Huron Dr.  
Natick, MA 01760-1314  
(508) 653-0844  
(CO) (TG)  
CIRCLE 739

**Satori Electric (America)**  
23717 Hawthorne Blvd.  
Torrance, CA 90505  
(213) 214-1791

(DP) (PC) (SM) (IL) (PU) (SL)  
(TH) (TG)  
CIRCLE 740

**Schrack North America Inc.**  
1995 Pond Rd.  
Ronkonkoma, NY 11779-7209  
(516) 737-0099  
(AU) (CS) (HD) (PB) (PW)  
(TE) (VS)  
CIRCLE 741

**Schurter Inc.**  
P.O. Box 750158  
Petaluma, CA 94975-0158  
(707) 778-6311  
(IL) (KB) (KL) (MB) (PC) (PU)  
(RK) (RO) (SA) (ST)  
CIRCLE 742

**Semiconductor Specialists  
Inc.**  
195 Spangler Ave.  
Elmhurst, IL 60126  
(708) 279-1005  
(DP) (OI) (DS)  
CIRCLE 743

**Shalloco Inc.**  
P.O. Box 1089  
Smithfield, NC 27577  
(919) 934-3135  
(DP) (PC) (RO) (SA)  
CIRCLE 744  
(see p. 114 for key)  
(continued on p. 114)

# Philips' Comprehensive Guide Opens Up Thousands of Choices In Discrete Semiconductors.



Design to production, Philips offers you more discrete semiconductor options.

For designers there's the flexibility of choosing from one of the industry's broadest ranges of discretes. Small signal products and power devices, optoelectronic, CATV, RF and microwave products—in standard surface mount, leaded glass, metal and plastic packages.

For specifiers and purchasers, we offer the economies and convenience of a stable long-term single source. And cost-cutting quality-assuring programs to help meet your production goals.

Self qualification, EDI, SPC, PPM, JIT, ship-to-stock. More discrete semiconductors, more design flexibility. More reason to trust Philips. Ask for your copy of our "Discrete Semiconductors Selector Guide and Cross-Reference" today!

**Philips Components  
Discrete Products Division**

2001 W. Blue Heron Boulevard  
P.O. Box 10330  
Riviera Beach, FL 33404

**1-800-447-3762**

*More Products. More Solutions.*

**Philips Semiconductors**



CIRCLE 156 FOR U.S. RESPONSE  
CIRCLE 157 FOR RESPONSE OUTSIDE THE U.S.

**PHILIPS**

## SWITCHES & RELAYS

### ▼ PC-BOARD SWITCHES MEET SCSI NEEDS

Designed to meet the unique requirements of the Small Computer System Interface system is the 3500 Series Micro-DIP switch. The unit features an eight-position, 3-bit binary output. The large numbers make settings easy. A compact low-profile design and integral top and bottom seals round out the features.

#### **EECO Inc.**

Switch Division  
1601 E. Chestnut Ave.  
Santa Ana, CA 92702-0659  
(714) 835-6000

► CIRCLE 787

### ▼ MINI ROCKER SWITCH IS RUGGED AND COMPACT

Designed to fit the standard panel cutout, the Elite miniature rocker switch is rated to 8 A at 125 V and 6 A at 250 V ac. The rugged, compact device carries UL, CSA, and VDE approvals. Lighted and non-lighted versions are available. Featured is a high inrush capacity of up to 100 A at 125 V ac for on-off circuits. Call for pricing and delivery.

#### **Arrow Hart Components**

P.O. Box 9050  
Charlottesville, VA 22906  
(804) 974-5100

► CIRCLE 788

### ▼ SEALED ROCKERS WITHSTAND CLEANING

Any need for a switch that must be flow or vapor-phase soldered, and then immersion cleaned, is met by the WT Series miniature rocker and lever switches. The panel- and pc-board-mounted switches are rated from dry circuit to 6 A at 125 V ac or 7 A at 30 V dc (resistive loads). Pricing for a single-pole model is \$2.50 in lots of 1000. Call for delivery data.

#### **American Switch Corp.**

134 Water St.  
Wakefield, MA 01880  
(617) 246-1007

► CIRCLE 789

## SWITCH AND RELAY MANUFACTURERS

**Shin-Etsu Polymer America Inc.**  
34135 7th St.  
Union City, CA 94587  
(415) 475-9000  
(IL) (PU) (SA)  
CIRCLE 745

**Shogyo International Corp.**  
287 Northern Blvd.  
Great Neck, NY 11021  
(516) 466-0911  
(DP) (IL) (KL) (PC) (PU) (RK)  
(RO) (SL) (TH) (TG)  
CIRCLE 746

**SoLiCo/MEC**  
75 Locust St.  
Hartford, CT 06114  
(203) 527-3092  
(IL) (KB) (PC) (PU) (SM) (TG)  
CIRCLE 747

**Solid State Electronics Corp.**  
18646 Parthenia St.  
Northridge, CA 91324  
(818) 993-8257  
(DS) (MI) (TD)  
CIRCLE 748

**Sprecher & Schuh**  
15503 W. Hardy St.  
Houston, TX 77060  
(713) 931-7000  
(CT) (ML) (PB) (TD)  
CIRCLE 749

**Square D Co.**  
Data Entry Products Div.  
302 3rd St. S.E.  
Loveland, CO 80537  
(303) 663-7337  
(KB) (MB)  
CIRCLE 750

**Square D Co.**  
Control Products Div.  
Hwy. 64 East  
Knightdale, NC 27545  
(919) 266-8335  
(AP) (CO) (IL) (KB) (KL) (MB)  
(PC) (PH) (PX) (PU) (RO)  
(SA) (SM) (TG) (AU) (CT)  
(CS) (HD) (HS) (ML) (PW)  
(TD) (VS)  
CIRCLE 751

**Staco Switch Inc.**  
1139 Baker St.  
Costa Mesa, CA 92626  
(714) 549-3041  
(PC) (SM) (IL) (PU)  
CIRCLE 752

**Standard Controls**  
P.O. Box 469  
Huntington, IN 46750-0967  
(CT) (CS) (HD) (ML)  
CIRCLE 753

**Standex Electronics**  
Standex International  
4538 Camberwell Rd.  
Cincinnati, OH 45209  
(513) 871-3777  
(CS) (HS) (HF) (ML) (DR)  
CIRCLE 754

**Struthers-Dunn**  
Lamb's Rd.  
Pitman, NJ 08071  
(609) 589-7500  
(MI) (TD) (VS)  
CIRCLE 755

**Switchcraft Inc.**  
Components Div.  
5555 N. Elston Ave.  
Chicago, IL 60630  
(312) 792-2700  
(IL) (PC) (PU) (RK) (SL) (TG)  
CIRCLE 756

**T-Bar Inc.**  
Data Switch Group  
One Enterprise Dr.  
Shelton, CT 06484  
(203) 926-1801  
(PU) (TG) (CX) (HS) (ML) (MI)  
CIRCLE 757

**Tansitor Electronics**  
P.O. Box 230, West Rd.  
Bennington, VT 05201  
(802) 442-5473  
(KL)  
CIRCLE 758

**Teledyne Microelectronics**  
12964 Panama St.  
Los Angeles, CA 90066  
(213) 822-8229  
(DP) (PC) (SM) (HS) (HF)  
(ML) (OI) (DS) (TD)  
CIRCLE 759

**Teledyne Relays**  
Teledyne Inc.  
12525 Daphne Ave.  
Hawthorne, CA 90250  
(213) 777-0077  
(HS) (HF) (ML) (MI) (PB)  
CIRCLE 760

**Teledyne Solid State**  
12525 Daphne Ave.  
Hawthorne, CA 90250  
(213) 777-0077  
(AS) (DS) (HS) (HF) (IO) (ML)  
(MI) (PB) (PW)  
CIRCLE 761

**Telemechanique Inc.**  
2002 Bethel Rd.  
Westminster, MD 21157  
(301) 876-2214  
(CX) (CS) (HD) (HS) (ML) (OI)  
(DS) (TE) (TD)  
CIRCLE 762

**Texas Instruments**  
Materials & Controls  
34 Forest St.  
Attleboro, MA 02703  
(508) 699-3800  
(MB) (CS) (DS) (TD)  
CIRCLE 763

**Toko America Inc.**  
1250 Feehanville Dr.  
Mount Prospect, IL 60056  
(708) 297-0070  
(KB) (PU) (RK) (AS)  
CIRCLE 764

**Topflight Corp.**  
Membrane Switch Div.  
P.O. Box 2847  
York, PA 17402-2847  
(717) 843-9901  
(IL) (MB) (SL) (SA)  
CIRCLE 765

**Transco Products Inc.**  
Sub. of Datron Systems Inc.  
1001 Flynn Rd.  
Camarillo, CA 93012-8706  
(805) 987-8007  
(CO) (CX) (HF) (MI)  
CIRCLE 766

**Tricon Industries Inc.**  
Electromechanical Div.  
2325 Wisconsin Ave.

Downers Grove, IL 60515  
(708) 964-2330  
(PU) (SA)  
CIRCLE 767

**Triridge Corp.**  
P.O. Box 12420  
Pittsburgh, PA 15231  
(412) 899-2288  
(HF) (ML) (DR)  
CIRCLE 768

**Unimax**  
A Div. of C & K  
Ives Rd., P.O. Box 152  
Wallingford, CT 06492  
(203) 269-8701  
(IL) (PC) (SA)  
CIRCLE 769

**Veetronix Inc.**  
P.O. Box 480  
Lexington, NE 68850  
(308) 324-4600  
(IL) (KB) (MR) (PU)  
CIRCLE 770

**Wabash Magnetics**  
55 Dupont Dr.  
Providence, RI 02907  
(401) 943-2686  
(PC) (CS) (HF) (ML) (DR)  
CIRCLE 771

**Westinghouse Electric Corp.**  
Control Div.  
P.O. Box 5715  
Asheville, NC 28813  
(704) 684-2381  
(PC) (PU) (SL) (TD)  
CIRCLE 772

**Wilbrecht Electronics**  
346 Chester St.  
St. Paul, MN 55107  
(612) 222-2791  
(PC) (PU) (SL)  
CIRCLE 773

**World Products Inc.**  
19654 8th St. E.  
Sonoma, CA 95476  
(707) 996-5201  
(AS) (AU) (DR) (FP) (MW)  
(PB) (PW) (TE)  
CIRCLE 774

#### KEY

#### Switches

(AC) Acceleration  
(AP) Air-pressure  
(CO) Coaxial  
(DP) DIP  
(IL) Illuminated  
(KB) Keyboard  
(KL) Keylock  
(MR) Magnetic reed  
(MB) Membrane  
(PC) Pc-mounted  
(PH) Photoelectric  
(PX) Proximity  
(PU) Pushbutton  
(RK) Rocker  
(RO) Rotary  
(SL) Slide  
(SA) Snap-action  
(ST) Stepping  
(SM) Surface-mounted  
(TH) Thumbwheel  
(TG) Toggle  
(TS) Touch screens

#### Relays

(AS) Ac solid-state  
(AU) Automotive  
(CX) Coaxial  
(CT) Contactors  
(CC) Crystal-case  
(CS) Current-sensing  
(DS) Dc solid-state  
(DF) Differential  
(DR) Dry reed  
(FP) Flat-pack  
(HD) Heavy-duty  
(HS) Hermetically sealed  
(HF) High-frequency  
(IO) Input/output  
(ML) Magnetic latching  
(MW) Mercury-wetted reed  
(MI) Military/aerospace  
(OI) Optical isolation  
(PB) Pc-board  
(PW) Power  
(RT) Rotary  
(TE) Telephone  
(TD) Time-delay  
(VS) Voltage-sensing



# All It Takes Is The *Right* Power



Unitrode Integrated Circuits announces the next generation of industry standard current mode PWM's. With increased demands on higher density/performance power supply designs, consider these features of the **UC3823A** and **UC3825A** family:

- ▶ Adjustable blanking of leading edge current noise
- ▶ Trimmed oscillator discharge for accurate frequency and dead time control
- ▶ Latched over current comparator
- ▶ Full cycle restart after fault
- ▶ Outputs active during UVLO
- ▶ Optional UVLO thresholds
- ▶ MHz+ performance

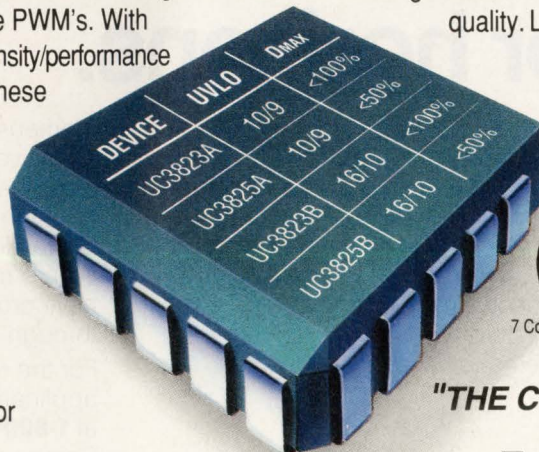

We guarantee a continued commitment to uncompromised quality. Look to Unitrode Integrated Circuits to provide unique solutions for your design needs. For more information on the **UC3823A** and **UC3825A** family, contact your Unitrode Representative or call:

## (603)424-2410

7 Continental Boulevard, Merrimack, NH 03054 FAX (603) 424-3460

**"THE CURRENT MODE PWM LEADER"**

**U** INTEGRATED  
CIRCUITS  
**UNITRODE**

CIRCLE 248 FOR U.S. RESPONSE

CIRCLE 249 FOR RESPONSE OUTSIDE THE U.S.

# SIEMENS

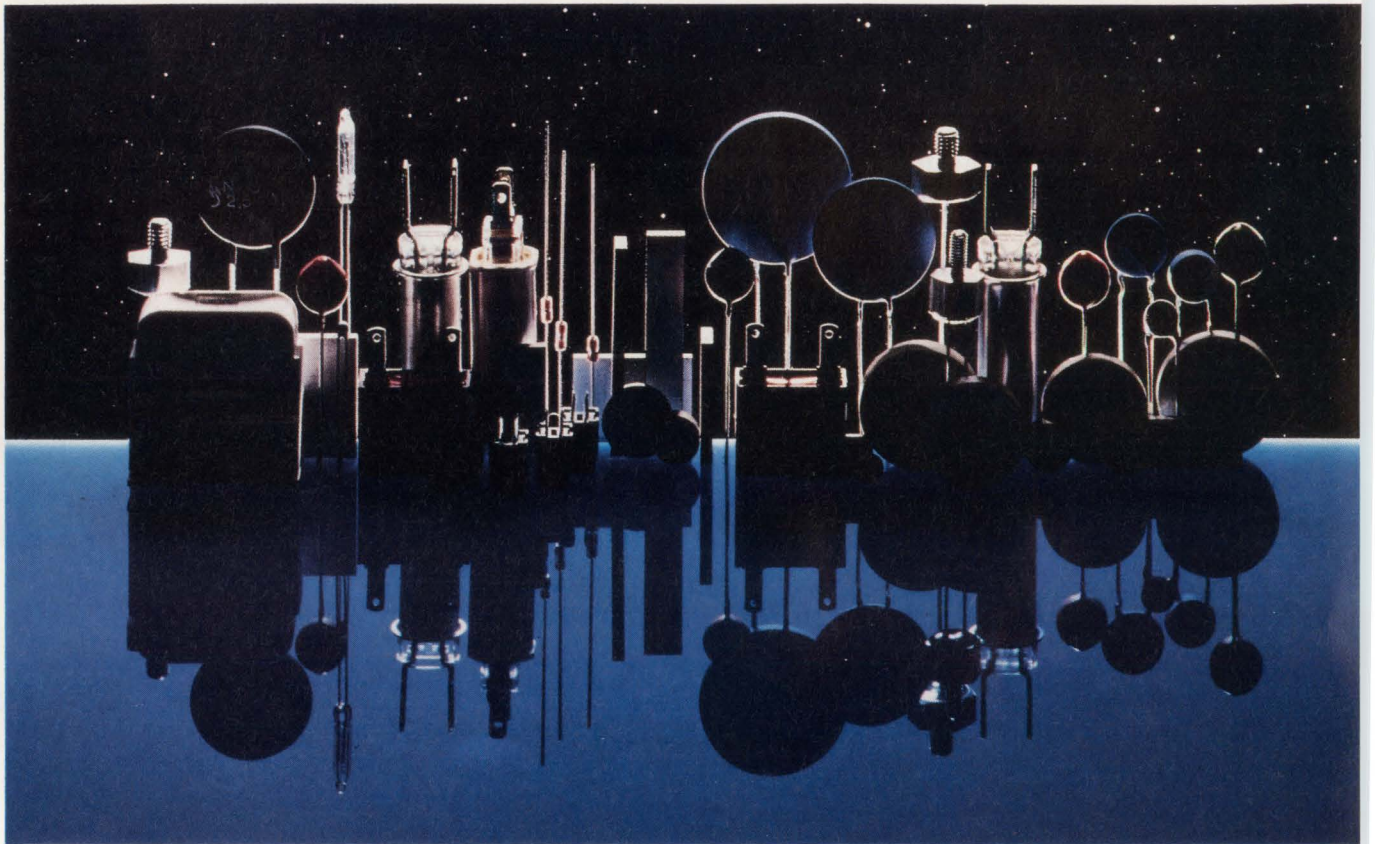

## Expand your thermistor horizons.

**Siemens offers a world of choice.**

Specify Siemens and select from a world of choice in NTC/PTC thermistors. Whether you need a thermistor to check or control temperature, protect against overloads or serve as an active heater, the Siemens spectrum includes standard or custom types to satisfy your most demanding applications.

Siemens thermistors are reliable, sensitive, and rugged. They consistently perform to your precise requirements in surface, air/gas or immersion sensing applications. What's more, Siemens thermistors have proven themselves world wide through high volume sales.

For the right thermistor for your application call Siemens today at **1-800-888-7729**. Siemens Components, 186 Wood Avenue South, Iselin, NJ 08830.

SCI-1012

CIRCLE 122 FOR U.S. RESPONSE  
CIRCLE 123 FOR RESPONSE OUTSIDE THE U.S.

▼ **10-A PC RELAY OFFERS LOW PROFILE**

Standard and sealed versions are offered of the 1715 Series 10-A pc-board-mounted relay. The low-profile relay comes in 1 Form C (SPDT) and Form A (SPST-NO) contact arrangements. Gold-flashed, silver-cadmium-oxide contacts make the relays suited for telephone, security-system, office-machine, consumer, and emergency-lighting applications. A wide range of coil voltages and sensitivities is available. The relays are UL recognized to a TV5 rating and are CSA certified. Call for pricing and delivery.

**Guardian Electric Mfg. Co.**

1425 Lake Ave.  
Woodstock, IL 60098  
(800) 762-0369

► **CIRCLE 791**

▼ **LATCHING RELAYS BOAST HIGH EFFICIENCY**

The 700 Series of polarized latching relays offers contact ratings from 16 to 35 A. A 20-ms impulse of 0.3 to 0.9 W is enough to actuate the relay. This results in high efficiency, energy savings, no heat influence on surrounding components, and shock and vibration resistance. Units are available with SPDT or DPDT contacts, both with ratings up to 35 A. Dimensions are 1.54 by 0.59 by 1.14 in. Pricing is \$4.08 in lots of 5000. Delivery is in from five to six weeks.

**Advanced Components Industries Inc.**

1308 Sartori Ave., Suite 105  
Torrance, CA 90501  
(213) 328-0060

► **CIRCLE 792**

▼ **TRANSIENT-PROOF SSR SUITS 480-V SYSTEMS**

The high-voltage spikes on 480-V systems have proved daunting to solid-state relays, but the transient-proof solid-state relay from Opto 22 senses line-voltage spikes and turns the relay on until the spike is harmlessly dissipated into the load. Units are available for 480- and 575-V systems with current ratings of 10, 15, and 45 A. Call for pricing.

**Opto 22**

15461 Springdale St.  
Huntington Beach, CA 92649  
(714) 891-5861

► **CIRCLE 793**

▼ **SOLID-STATE RELAY MOUNTS ON CHASSIS**

Loads up to 25 A at 240 V ac are switched by the EOMZ-240D25 chassis-mounted solid-state relay. The compact device's maximum steady-

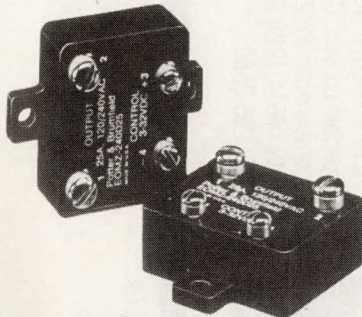

state output current derates linearly from 25 A at 25°C to 6.85 A at 80°C. A dv/dt snubber network across the relay's 1 Form A output protects against false triggering. Pricing is \$16.60 in single quantities. Delivery is from stock to eight weeks.

**Potter & Brumfield Inc.**

200 S. Richland Creek Dr.  
Princeton, IN 47671-0001  
(812) 386-2314

► **CIRCLE 794**

▼ **SOLID-STATE RELAYS OFFER TRIP INDICATOR**

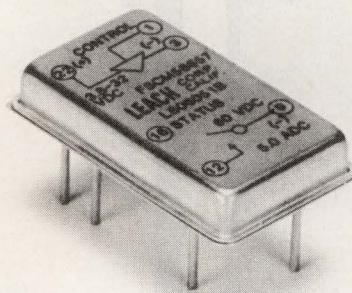

In both the solid-state relay (model LS06051B) and the solid-state true current-sensing relay (model LS06102C), an isolated status pin acts as a trip indicator. A low status indicates when the output has tripped off because of an over-current condition. Both relays feature integrated short-circuit, current-overload, and thermal-overload protection, and are housed in a hermetic metal package. Call for pricing.

**Leach Corp.**

P.O. Box 5032  
Buena Park, CA 90622-5032  
(714) 739-0770

► **CIRCLE 795**

▼ **TIMER-RELAY COMBO IS EASY TO USE**

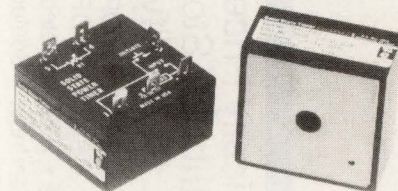

A solid-state relay and time delay combines in one package to make an easy-to-use control. The TH Series modules now comes in the N Series package, which measures just 2 by 2 by 1 in. and has a molded heat-transfer plate that improves the device's thermal characteristics. Three output ratings are available: 6, 10, and 20 A steady state with inrush ratings of 60, 100, and 200 A. Operating voltages are 24, 120, or 230 V ac. Call for pricing and delivery.

**SSAC Inc.**

P.O. Box 1000  
Baldwinsville, NY 13027  
(315) 638-1300

► **CIRCLE 796**

▼ **PLUG-IN RELAYS TAKE BROAD TEMPS**

A broad temperature range of -40 to +60°C won't faze the CH1 line of plug-in relays. Designed for low-current applications, the relays come with either 2 or 3 Form C changeover contacts that can be wired in either

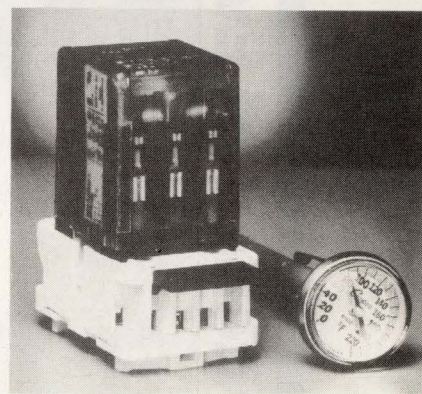

normally open or closed configurations. The relays operate from voltages of 24 to 240 V ac and from 24 to 110 V dc. Call for pricing and delivery.

**Sprecher + Schuh Inc.**

15503 W. Hardy St.  
Houston, TX 77060  
(713) 931-7000

► **CIRCLE 797**

# DIP Switches of Every Description

Economically Priced  
Distributor Stocked  
Reliability Tested

- CHOOSE:**
- SPST
  - DPST
  - 4PST
  - SPDT
  - DPDT
  - 4PDT
  - Right Angle
  - Side Actuated
  - Machine Insertable
  - Sealed Top/Bottom
  - Flush/Extended Actuators
  - Economy Styles
  - ESD Protected Designs

**ORDER FROM:** Your CTS Stocking Distributor  
or, for specials contact: CTS Corporation,  
Electrocomponents, 1142 W. Beardstley Ave.,  
Elkhart, IN 46514. (219) 295-3575.  
FAX: (219) 295-3580.

**CTS**

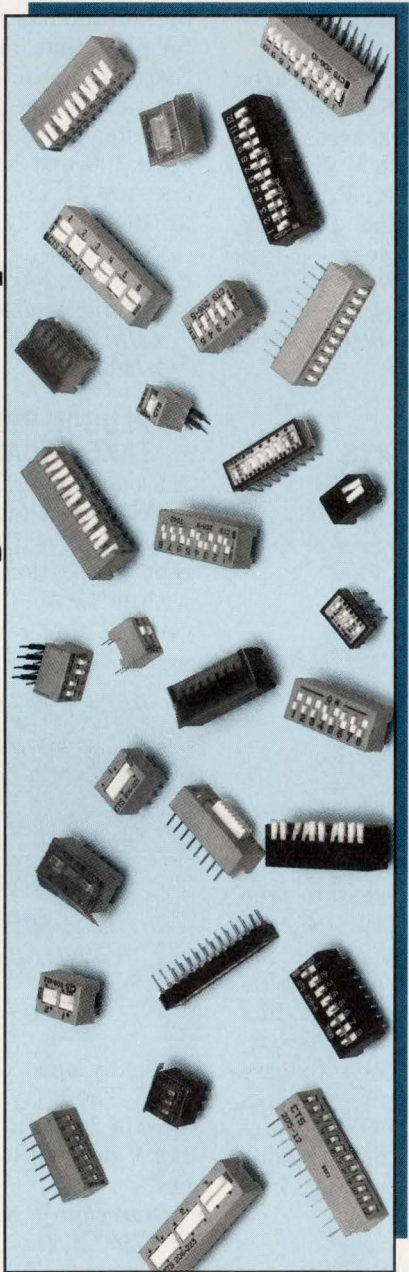

CIRCLE 287 FOR RESPONSE OUTSIDE THE U.S.

CIRCLE 286 FOR U.S. RESPONSE

## RELAYS

### ▼ POWER CONTROLLERS HANDLE LOADS TO 100 A

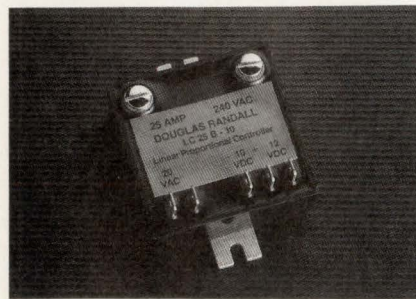

A line of thyristor-based power controllers uses dc analog control signals to proportionally control loads up to 100 A at 300 V rms. The LC Series controllers offer analog load control without need for time-consuming bias, gain, or calibration adjustments. Models are rated at 15, 25, 40, 70, and 100 A, and from 20 to 300 V ac. They accept input signals from zero to 5 V dc, 1 to 10 V dc, and 4 to 20 mA. In single quantities, pricing is \$220. Small lots are delivered from stock.

**Douglas Randall**  
P.O. Box 506  
Pawcatuck, CT 06379  
(800) 447-6799  
► CIRCLE 798

### ▼ HIGH-CAPACITY RELAYS SUPPORT HEAVY LOADS

Heavy-duty contacts rated to support large loads in full-load amps or locked-rotor amps and tungsten-load conditions at 120 and 277 V are featured in the G7L power relay. Avail-

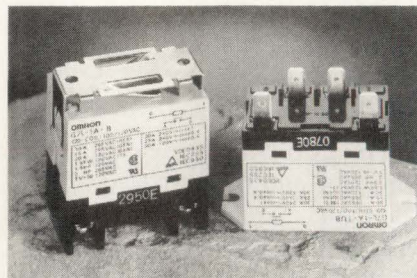

able with ac or dc coils, the relay's coil circuitry resists coil dropout or contact chatter during transient voltage drops. In quantities of 1000, the relay costs \$5.14. Delivery is from stock.

**Omron Electronics Inc.**  
Control Components Div.  
1 E. Commerce Dr.  
Schaumburg, IL 60173  
(800) 62-OMRON  
► CIRCLE 799

# Why Wait 5 Days?

## All Bud Products Are Available Today From Your Bud Distributor

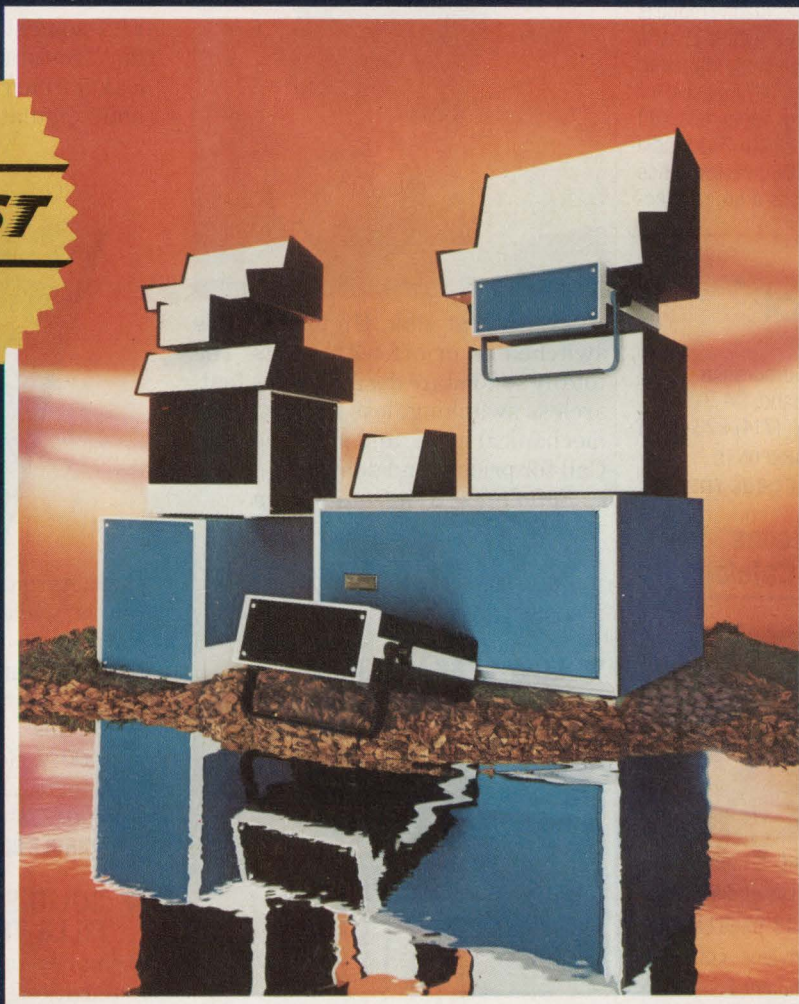

Over 2,500 styles, sizes and colors to meet your needs . . .  
immediately available from stock.  
Or let us design a special case for you.  
Call us for the name of your local Bud Distributor.

**Bud East, Inc.**  
4605 East 355th Street  
P.O. Box 431  
Willoughby, Ohio 44094  
(216) 946-3200  
FAX: 216-951-4015

**BUD**  
Bud Industries, Inc.

**Bud West, Inc.**  
7733 West Olive Avenue  
P.O. Box 1029  
Peoria, Arizona 85345-0350  
(602) 979-0300  
FAX: 602-878-5371

*When it comes to enclosures, we've got you covered.*

CIRCLE 198 FOR U.S. RESPONSE

CIRCLE 199 FOR RESPONSE OUTSIDE THE U.S.

## Spectrol's Model 63 Available in 12 Different Models

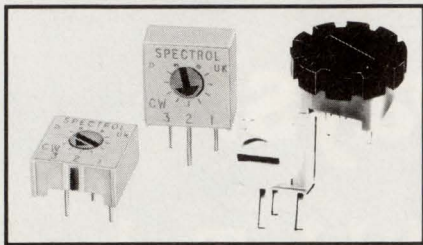

Spectrol's 3/8-inch square single-turn cermet trimmer, the Model 63 is offered in four terminal styles with pin configurations to suit any standard PCB application as well as two top-adjust and two side-adjust versions, and two different knob types. Quick adjustment is achieved with a multi-fingered wiper. Resistance range is from 10 ohms to 2 megohms with a  $\pm 10\%$  resistance tolerance. Features include improved solder-plated terminals, and an "O" ring seal for solvent and aqueous washing. Tempco is 100 ppm/ $^{\circ}$ C, and a CRV of 2% or 2 ohm. The Model 63 continues to provide excellent performance as the industry standard across a broad spectrum of applications.

**Spectrol**<sup>®</sup>

Spectrol Electronics Corporation  
4051 Greystone Drive, Ontario, CA 91761  
Phone: (714) 923-3313 Fax: (714) 923-6765  
CIRCLE 174 FOR U.S. RESPONSE  
CIRCLE 175 FOR RESPONSE OUTSIDE THE U.S.

## Potentiometers, Switches in New Easy to Use Catalog

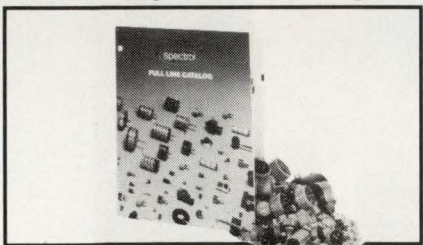

You'll find everything you need to know about trimmers, potentiometers, dials and switches in Spectrol Electronics' new 48-page catalog. Its easy-to-use format provides complete electrical and mechanical engineering data for the entire Spectrol line of products, as well as detailed information on trimmer accessories, and rotary and linear position sensors. Get all the facts on proven electro-mechanical designs which incorporate the full range of resistive element technologies. Request your Spectrol catalog today.

**Spectrol**<sup>®</sup>

Spectrol Electronics Corporation  
4051 Greystone Drive, Ontario, CA 91761  
Phone: (714) 923-3313 Fax: (714) 923-6765  
CIRCLE 224 FOR U.S. RESPONSE  
CIRCLE 225 FOR RESPONSE OUTSIDE THE U.S.

## RELAYS

### ▼ HIGH-POWER SSRs SWITCH 40 A AT 1000 V

Optoelectronic isolators and MOS-FET technology take the Series 8 solid-state relays beyond the electromechanical relays they replace. The devices switch up to 16 A steady state with no added heat sink and up to 40

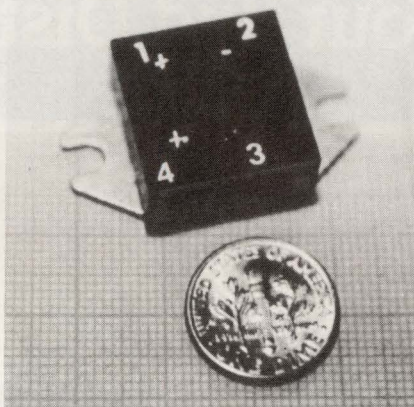

A with a heat sink. Up to 1000 V is switched on or off within 3  $\mu$ s. The totally solid-state design means fast, arcless switching, less EMI/RFI, no mechanical noise, and indefinite life. Call for pricing and delivery.

**Solid State Electronics Corp.**  
18646 Parthenia St.  
Northridge, CA 91324  
(818) 993-8257

► CIRCLE 800

### ▼ LOW-LEAKAGE SSRs FIT HIGH-SPEED ATE

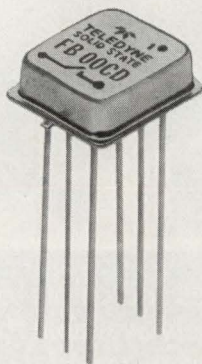

A family of low-leakage, high-voltage, fast solid-state relays meets the needs of high-speed ATE systems that require long relay life. The FB Series relays are bidirectional types in a low-profile 6-pin mini-DIP. Optical isolation protects input logic circuits from hazardous output-voltage transients and minimizes EMI generation. Pricing ranges from \$64.35

to \$65.90 in lots of 100. Delivery is stock to eight weeks.

**Teledyne Solid State**  
12525 Daphne Ave.  
Hawthorne, CA 90250-3384  
(213) 777-0077

► CIRCLE 801

### ▼ DC POWER-FET SSRs BOAST LOW LEAKAGE

Extremely low on-state resistance and off-state leakage current are features of the GF Series power-FET solid-state relays. With a "contact" resistance as low as 28 m $\Omega$  and leakage current less than 10  $\mu$ A, the units emulate most of the desirable



characteristics of electromechanical relays while providing longer life. Ratings are 10, 15, and 30 A with a 3-to-32-V dc input range. Call for pricing and delivery.

**Gordos**  
1000 N. Second St.  
Rogers, AR 72756  
(800) 726-0300

► CIRCLE 802

### ▼ SOLID-STATE RELAY FILLS TELECOM NEEDS

Primarily targeted for on/off-hook applications and dial pulsing in modems, the LH1298 solid-state relay is a single-pole, normally closed (1 Form B) relay. The device's optically coupled, single-chip construction provides fast, reliable, bounce-free switching while it saves space and power. Pricing is \$2.15 in lots of 100 for a model with 1500 V of I/O isolation. Call for delivery.

**AT&T Microelectronics**  
Dept. 52AL040420  
555 Union Blvd.  
Allentown, PA 18103  
(800) 372-2447

► CIRCLE 803

MODULAR POTS AND ENCODERS:

# We'll make your most imaginative designs fly.



We can furnish pots and encoders in 1/2"-square modular packages in virtually countless variations. No matter what your panel design, we thrive on solving problems. If yours looks impossible, call us. We'll give you all the design freedom you need.

**Encoders—the exciting new wave in panel-mount controls.**

Our 1/2"-square digital pots are the smallest on the market. Optical and mechanical types, with 1 or 2 modules. And you'll never need A/D converters again.



At 1/2"-square, it's the smallest panel-mount optical encoder on the market.

**Over a billion modifications—fast.**

Our local value-added centers will build prototypes of 1/2"-square pots with up to 4 stacks—in just a few hours. At the factory, we'll gang up to 8 modules, more than anyone else. We'll mix pots, switches, encoders, vary terminals and shafts—whatever makes your design work.

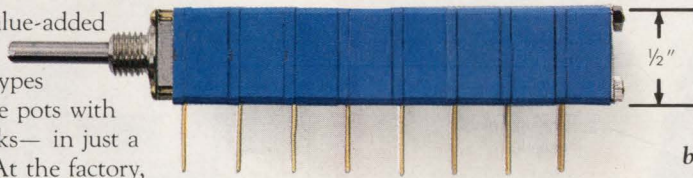

Squeeze 8 pots into one 1/2"-square space. That's more than anyone else can do.

Shaft springs back to center, automatically. No one else can do that.

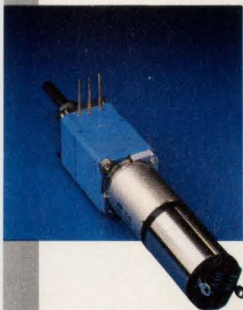

Four ganged pots with a gearmotor make remote adjustments smoother.

**Over a million new ways to reduce the cost of modular pots.**

Introducing Series 308-309. It's a new generation of 1/2"-square pots with an exclusive new unitized construction. Rugged, and smooth to rotate, it has fewer parts—and cuts costs while saving space. Made in 1 to 3 gangs, with pots, switches, and almost unlimited mechanical and electrical options.

With advanced laser trimming, we'll track up to four gangs with virtually perfect linearity.

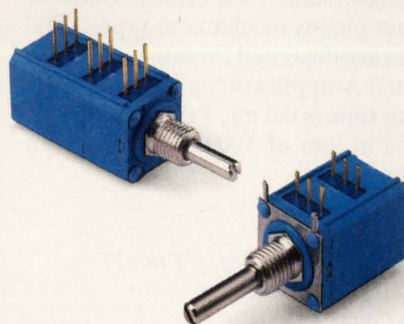
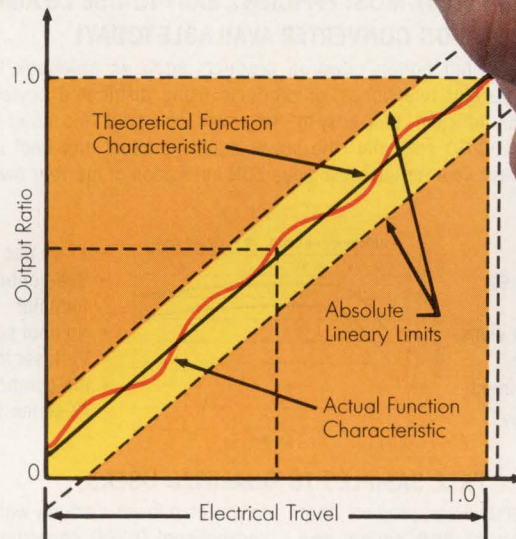

**Virtually unlimited standard pots.**

No one else has more pots. Modular. Board-washable. Wave-solderable. Wirewound. Conductive plastic. Cermet. Hot molded carbon. More. Send for catalog.

Unitized construction with fewer parts makes new Series 308-309 pots economical.



One Washington St.  
PO Box 1507  
Dover, NH 03820  
Tel: 603-742-1120  
Fax: 603-742-0481  
Toll free: 800-872-0042



CIRCLE 144 FOR U.S. RESPONSE

CIRCLE 145 FOR RESPONSE OUTSIDE THE U.S.

## RELAYS

### ▼ SMT CONSTRUCTION TAKES SSR TO 25 A

Thanks to surface-mounted assembly techniques, the Mini Puck solid-state relay is rated to 25-A switching capability while requiring only half the volume of a standard hockey-puck package. The reduced size sac-

rifices no operating life or efficiency. The relay's 250-A surge rating and 0.4 minimum power-factor design easily switches motor and inductive loads. Output-circuit characteristics include full transient protection, 400-V blocking voltage (120-V ac load voltage), and  $dV/dT$  of 3000 V/ $\mu$ s.

The optically isolated relay is logic-compatible. Pricing is \$17.10 in lots of 100. Production quantities are available immediately.

#### Grayhill Inc.

561 Hillgrove Ave.  
La Grange, IL 60525-0373  
(708) 354-1040

► CIRCLE 832

### ▼ HIGH-CURRENT RELAYS SUIT CONTROL BOXES

Uses in electronic control boxes or PC power boards can be found for the Type 690 power relay. Features include both ac and dc coils, high-current capability with low power con-



sumption, versatile termination, interchangeable mounting, and a wide operating-temperature range of -55 to +85°C. Call for pricing and delivery.

#### Emerson Electric Co.

White-Rodgers Division  
9797 Reavis Rd.  
St. Louis, MO 63123  
(314) 577-1300

► CIRCLE 805

### ▼ 16-PIN DIP REED RELAY REPLACES OTHER TYPES

For the first time, according to the manufacturer, a reed-relay design is available as a pin-for-pin, form-fit alternative to a popular electromechanical relay at a competitive price. The DC Series of 16-pin DIP reed relays offer electrical parameters that are significantly superior to those of 16-pin electromechanical types. The units are designed for low-level to 10-W, 0.5-A applications. Typical operating time is 0.5 ms. Pricing starts at \$1.55 in lots of 1000. Delivery is in eight weeks.

#### EI&S

P.O. Box 185  
North Branford, CT 06471  
(203) 481-5721

► CIRCLE 804

## INNOVATION OF THE YEAR AWARD WINNER

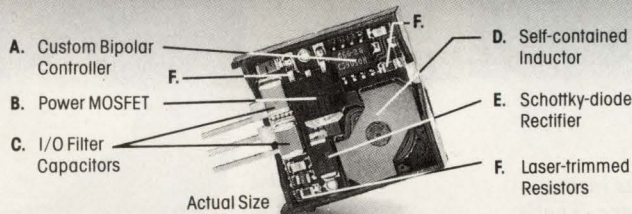

### THE SMALLEST, MOST EFFICIENT, EASY-TO-USE 1.5 AMP DC-DC CONVERTER AVAILABLE TODAY!

If you're designing battery-powered products such as notebook/laptop computers, cellular telephones, or products using distributed power—you need a small, efficient, and easy-to-use power converter. You need Power Trends' new DC-DC converter—the power supply product that beat out all competition last year for the prestigious EDN Innovation of the Year Award.

#### MOST EFFICIENT

#### SMALLEST

- 0.88" x 0.92" x 0.30"
- 35 to 100 watts/cubic inch
- Surface mount technology

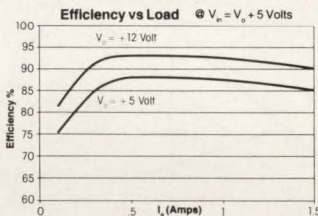

#### EASY TO USE

- Self-contained inductor
- No heat sinks
- V<sub>o</sub> laser trimmed
- Pin-compatible/78-series linears

### FREE SAMPLES TO QUALIFIED USERS.

This tiny innovative product that won the vote of EDN editors and its thousands of readers in 1990 has since proven itself in a diversity of end-product designs. And now this same breakthrough product is available

to you at a lower cost-per-watt than conventional DC-DC converter solutions. For more information or a free sample, call Power Trends today or FAX your request with your business card to the number below.

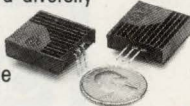

## POWER TRENDS

1101 North Raddant Road, Batavia, IL 60510 • 708-406-0900 • Fax 708-406-0901

CIRCLE 182 FOR U.S. RESPONSE

CIRCLE 183 FOR RESPONSE OUTSIDE THE U.S.

ELECTRONIC DESIGN ■ PIPS SPECIAL EDITORIAL FEATURE ■ JULY 25, 1991



**ATTENTION  
MARKETERS!**

**REACH  
DESIGN AND  
DEVELOPMENT  
ENGINEERS**



**ELECTRONIC DESIGN**

subscribers are  
highly educated engineers  
and managers in the  
electronics original equipment  
market.

Select by:  
Job Function, Type of  
Industry, Project  
Responsibility, Purchasing  
Influence, Employment Size  
and  
Geography

Guaranteed 99%  
deliverable  
100% BPA audited

**Call the List  
Department  
at 216(696)7000  
for your FREE  
catalog**

**Penton  
Lists**

*The  
Whole is  
the sum  
of its  
Parts.*



When you get involved in developing the parts for your product, you know that there is an art to parts that goes beyond engineering and design. The art of choosing the right material from the right supplier.

For nearly sixty years, Plenco Engineering Company has pioneered new applications in molding technology. We'll help you select the Plenco thermoset molding compound that's right for your part. We pay attention to cost as well as quality, finish as well as strength, special properties as well as application. All the parts that make your parts part of a successful whole.

The people of Plenco can help you gain a level of quality, product performance, and total cost savings that can help keep you competitive. You'll also get Plenco's first-rate service and on-time delivery that manufacturers and molders worldwide count on as a part of their success. Call 414-458-2121 for information, or write us at P.O. Box 758, Sheboygan, Wisconsin 53082-0758.

**PLENCO**  
THERMOSET PLASTICS

PLASTICS ENGINEERING COMPANY  
Sheboygan, WI 53082  
Since 1934

CIRCLE 164 FOR U.S. RESPONSE  
CIRCLE 165 FOR RESPONSE OUTSIDE THE U.S.

# The Most Diverse Family In Memory.

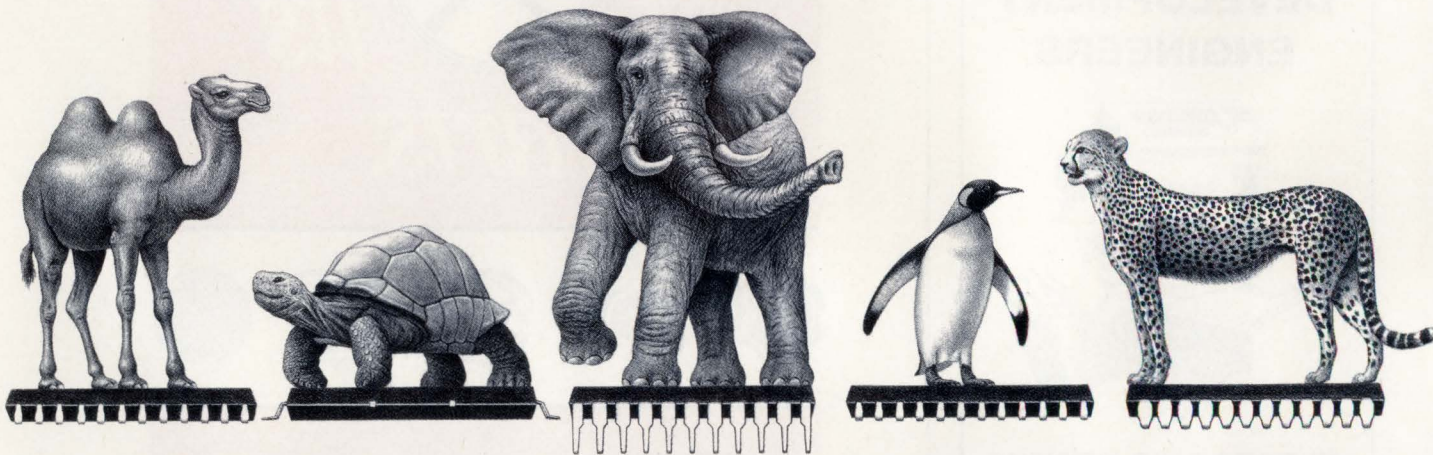

*Designs That Endure  
High Temperatures*

*Consistant Performance  
At Low Powers*

*Massive And Reliable  
Memory*

*Perfectly Suited For  
Cold Climates*

*High Speed Processing  
Performance*

## A Complete Line Of 1-Meg SRAMs.

Call Sony first. The largest selection of 1-Meg SRAM assures you can find the high performance, highly reliable memory you're looking for with just one call, so why go on a safari?

Fast or slow. Hot or cold. Even your massive memory requirements are right here.

And we can ship the package styles most in demand for your new designs today - and tomorrow. Our new production facility in San Antonio, TX will build on the reputation for timely delivery that has made us a breed apart.

## The Best Selection Of New SRAMs.

-40° to +85°c, 3 volts and X9.20 nsec

If your current designs incorporate the latest

technology, call us. Virtually every new idea in SRAM will be here at Sony first. And our U.S. design team (with their 0.8 & 0.5-micron CMOS technology) stands ready to get you the right product for your design; whether it's for a laptop or workstation.

## Call Sony First.

We've got the product, backed by the Sony commitment to quality and service. And at competitive prices that make us the King of the SRAM Jungle.

Call today 714.229.4190 or 416.499.1414 in Canada. Or fax us

your current requirements for a quick response from our technical staff  
714.229.4285 (fax) or  
416.497.1774  
(fax/Canada).

1-Meg SRAM						
Model	Speed (ns)	Packaging	Data Retention Current	Special Features	Availability	
128Kx8 -- CXK581000P	100/120	DIP 600mil	L/LL	B/X	Now	
-- CXK581000M	100/120	SOP 525mil	L/LL	B/X	Now	
-- CXK581100TM	100/120	TSOP (normal)	L/LL	B/X	Now	
-- CXK581100YM	100/120	TSOP (reverse)	L/LL	B/X	Now	
-- CXK581001P	70/85	DIP 600mil	L/LL		Now	
-- CXK581001M	70/85	SOP 525mil	L/LL		Now	
-- CXK581020SP	35/45/55	SDIP 400mil			Now	
-- CXK581020J	35/45/55	SOJ 400mil			Now	
128Kx9 -- CXK77910J	17/20	SOJ 400mil		Sync ASM	3/Q '91	
256Kx4 -- CXK541000J	25/30/35	SOJ 400mil			3/Q '91	

L = Low LL = Low,Low B = 3 Volt X = Extended Temperature

# SONY

Sony Corporation of America, Component Products Company, 10833 Valley View St., Cypress, CA 90630

Sony Canada, 411 Gordon Baker Rd., Willowdale, Ontario M2H 256

Prices and specifications are subject to change without notice. The purchase of products is subject to availability and Sony's standard terms and conditions of sale. Sony is a registered trademark of Sony Corporation.

CIRCLE 146 FOR U.S. RESPONSE

CIRCLE 147 FOR RESPONSE OUTSIDE THE U.S.

## ▼ LOW-COST SERVOAMP PUMPS $\pm 12$ A AT $\pm 75$ V

Model 303 PWM Servoamplifier

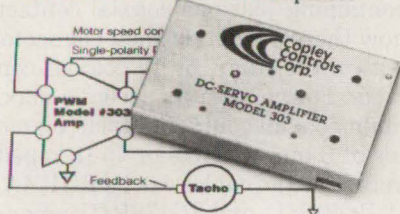

Designed for fractional-horsepower motion-control applications, the model 303 servoamplifier is a pulse-width-modulation device that operates from single-polarity dc supplies. The unit develops four-quadrant  $\pm 6$  A at  $\pm 75$  V continuously, and  $\pm 12$  A peak for fast motor acceleration. With its 22-MHz switching frequency, the amplifier puts motor hum beyond human hearing. A 3-kHz bandwidth maximizes servo accuracy. Pricing in lots of 100 is \$215.

**Copley Controls Corp.**

410 University Ave.

Westwood, MA 02090

(617) 329-8200

► CIRCLE 806

## ▼ LOW-THRESHOLD MOSFET COMES IN SOT-89

A drain-to-source breakdown voltage of 100 V minimum is featured in the TP2510N8 low-threshold P-channel MOSFET. The device, which

Typical Transfer Characteristics

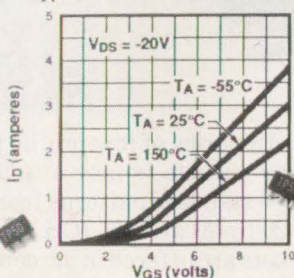

comes in an SOT-89 package, has an on-resistance of 3.5  $\Omega$  maximum specified at a  $V_{GS}$  of 10 V and an  $I_D$  of 1 A. The gate-threshold voltage is guaranteed at 2.4 V maximum. Pricing is \$0.53 in lots of 1000. Samples are available now and production lots take four to six weeks.

**Supertex Inc.**

1225 Bordeaux Dr.

Sunnyvale, CA 94088-3607

(408) 744-0100

► CIRCLE 807

## ▼ WIDEBAND AMPS ARE HIGHLY LINEAR

Two 10-MHz-to-1.2-GHz hybrid amplifiers are designed for linear operation in 50- $\Omega$  systems. The CA5900 and CA5915 devices are high-reliability, thin-film hybrid devices that provide excellent gain stability over a temperature range of  $-40$  to  $+100^\circ\text{C}$ . The amplifiers provide 15 dB of gain and typical output power of 1 W at 1-dB compression point. Typical third-

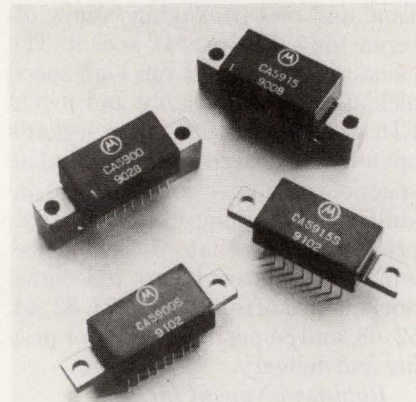

order intercept is 41 dBm. Pricing is \$91.30 in lots of 100.

**Motorola RF Division**

325 Maple Ave.

Torrance, CA 90503

(213) 783-5782

► CIRCLE 808

## ▼ SWITCHING SUPPLIES TAKE ANY INPUT

Inputs from 90 to 250 V ac won't faze the HV150 Series of switching power supplies. Output voltages are 5, 12,

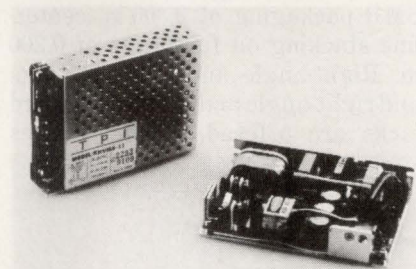

15, or 24 V dc. Line regulation is 0.1% and load regulation 2% typical. Ripple and noise are specified at 1% typical peak to peak. Pricing is \$76 for quantities of 100. Delivery is from four to six weeks.

**Total Power International Inc.**

418 Bridge St.

Lowell, MA 01850

(508) 453-7272

► CIRCLE 809

## ▼ NICAD BATTERY BOASTS HIGH CAPACITY

A 1.2-V, 2300-mAh nickel cadmium battery is capable of one-hour rapid charging. The P230SCS battery, which is based on the company's sponge-metal technology, has a 60%

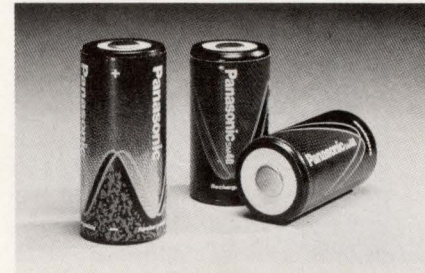

higher capacity level than conventional Nicads. It also introduces a new battery size. The unit has the same 22.5-mm diameter as current SC cells, but is 49.3 mm tall compared to the standard 42.5-mm height. Uses include audiovisual and communications equipment. Call for pricing and delivery.

**Panasonic Battery Sales Group**

Two Panasonic Way

Secaucus, NJ 07094

(201) 348-5266

► CIRCLE 810

## ▼ 10-W DC-DC CONVERTER CUTS NOISE IN HALF

Half the normal noise output expected from comparable units is produced by the models 48D12.400TC and 48D15.350TC dc-dc converters. The 10-W units put out  $\pm 12$  V at 400



mA and  $\pm 15$  V at 350 mA, respectively. Both feature an extra-wide input range of 20 to 60 V dc, suiting them for battery or unregulated-input uses. Sample quantities are delivered from stock and cost \$81.40 each in lots of 100.

**Callex Mfg. Co. Inc.**

3355 Vincent Rd.

Pleasant Hill, CA 94523

(800) 542-3355

► CIRCLE 811

## INTERCONNECTS

### ▼ RIGHT-ANGLE HEADERS STAY PUT FOR SOLDERING

A board-retention feature holds a low-profile, right-angle header in place for soldering. The Pegasus header sports an overall 0.198-in.

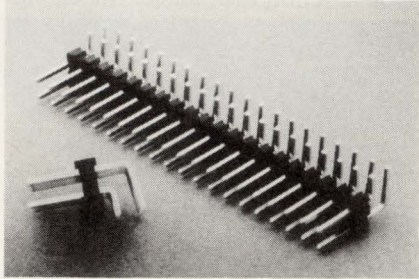

profile, which suits it for packaging applications where boards are stacked closely together. The header features 0.025-in. square contacts with bullet-nose tips. A 40-position, dual-row header with 15- $\mu$ m selective gold plating on 0.230-in. posts costs \$1.65 in lots of 1000. Delivery is in four weeks.

**Crane Electronics**  
4700 Smith Rd., Suite R  
Cincinnati, OH 45212  
(800) 676-7644

► CIRCLE 812

### ▼ CONVERTER PUTS TSOP IN 32-PIN DIP PROGRAMMER

A device packaged in a 32-pin, 20-by-8-mm TSOP package can now be programmed in a DIP-programmer socket thanks to a TSOP-to-DIP con-

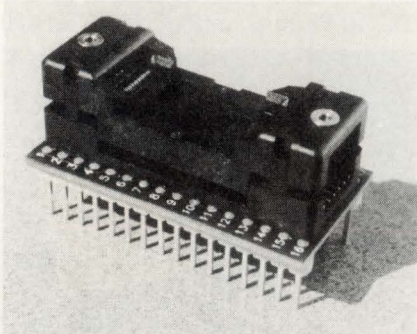

verter. The model 32-TSOP-DIP6-1-ZOW converter accepts parts such as an Intel flash memory or Mitsubishi SRAM and changes their footprint to a 100-mil-pitch DIP for insertion into a programmer socket. The converter costs \$90 in single quantities. Delivery is from stock to five days.

**EDI Corp.**  
P.O. Box 366  
Patterson, CA 95363  
(209) 892-3270

► CIRCLE 813

### ▼ PLCC SMT SOCKETS COME ON TAPE AND REEL

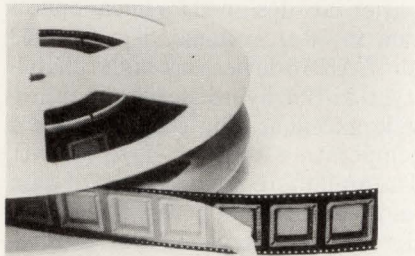

Tape and reel packaging is now offered for a PLCC SMT socket. The packaging is suited for high-speed pick-and-place assembly and meets EIA 481 specifications. The socket's open-frame design permits visual inspection of solder joints before installation of the chip carrier. Its footprint matches that of the device, which eliminates board redesigns. Sockets are offered in 20, 28, 32, 44, 52, 68, and 84 positions. Call for pricing and delivery.

**Robinson Nugent Inc.**  
800 E. Eighth St.  
New Albany, IN 47150  
(800) 338-8152

► CIRCLE 814

### ▼ SMALL CONNECTORS STACK INTERFACES ON PC BOARDS

A quick connect/disconnect interface with small size for efficient connector stacking on pc boards is available. The small-SMB (SSMB) connectors offer 0.200-in. centerline stacking with pc-board footprints on 0.100-in. centers, as opposed to standard SMB packaging of 0.300-in. centerline stacking on footprints of 0.200 in. Right-angle and straight plugs and right-angle and vertical pc-board jacks are offered. Pricing ranges

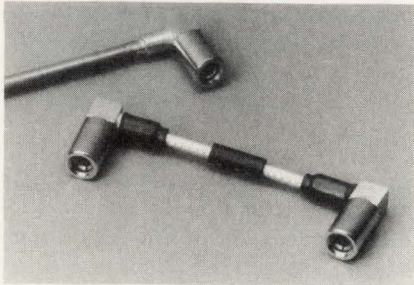

from \$2 to \$5 in lots of 1000. Delivery is from six to 10 weeks.

**AMP Inc.**  
P.O. Box 3608  
Harrisburg, PA 17105-3608  
(800) 522-6752

► CIRCLE 815

### ▼ MULTICOAX CONNECTORS HOLD UP TO 10 CONTACTS

Instead of multiple connectors, each containing just one coaxial contact, now there's a single-shell connector with three, four, or 10 coaxial contacts. The connectors accept a maximum coaxial-contact outside diameter of 3 mm with 50- or 75- $\Omega$  impedance. Coaxial cables can be RG174A/U, RG316/U, and RG178B/U, among others. Shells can be chrome-plated brass or environmentally resistant. Pricing in quantities of 100 is \$103.30 per mated pair. Delivery is stock to 18 weeks.

**LEMO USA Inc.**  
P.O. Box 11488  
Santa Rosa, CA 95406  
(800) 444-LEMO

► CIRCLE 816

### ▼ LOW-PROFILE SOCKETS COME IN 250 PATTERNS

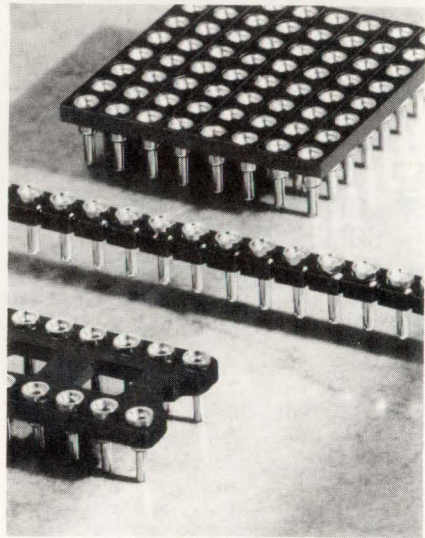

The MHAS Series of low-profile pin-grid-array sockets is now available in over 250 standard patterns from 2-by-2 to 20-by-20 arrays. ICH Series DIP sockets are offered in pin counts from eight to 40 with a choice of centerline spacings. Also, low-profile socket strips (SL and SDL Series) are offered in from one to 32 positions for single-row types and one to 36 positions for dual-row types. Pricing starts at \$0.028 per pin depending on lead style and quantity. Delivery is from stock to five working days.

**Samtec Inc.**  
P.O. Box 1147  
New Albany, IN 47151-1147  
(800) SAMTEC-9

► CIRCLE 817

▼ **THIN QUARTZ CRYSTALS BOAST HIGH STABILITY**

An extremely thin package houses a quartz crystal for use in portable, high-density applications such as pagers and cellular phones. The HC-

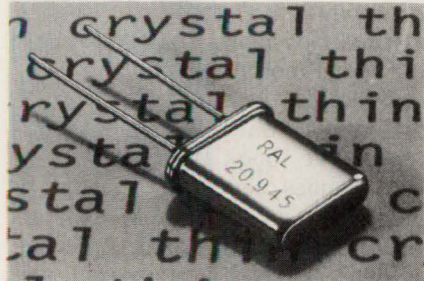

52/U (also known as the HC-45 Slim-Line) measures just 2.3 mm thick. Frequency stability with temperature is specified within  $\pm 2.5$  ppm from zero to  $+50^{\circ}\text{C}$ . Frequencies are available from 5 MHz to 360 MHz. Pricing ranges from \$1.90 to \$6 in lots of 10,000.

**Raltron Electronics Corp.**  
2315 N.W. 107th Ave.  
Miami, FL 33182  
(305) 593-6033  
► CIRCLE 818

▼ **SMT RESISTOR, R-C NETS OFFER LOW NOISE LEVEL**

Very high stability and exceptionally low noise are hallmarks of a line of SMT resistor and resistor-capacitor networks. The resistor networks

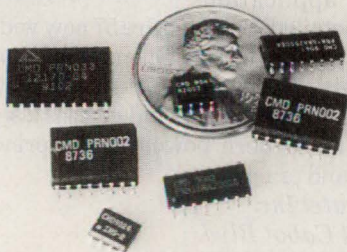

come in isolated, bussed, and dual-terminator configurations in 8-, 14-, 16-, and 20-pin plastic SOIC packages. Resistances range from  $10\ \Omega$  to 1 M $\Omega$  with tolerances to  $\pm 0.1\%$ . The resistor-capacitor networks function as low-pass filters and come in 20-pin packages. Typical capacitance range is 20 to 300 pF. Prices start at \$0.50 for lots of 1000. Delivery is in four weeks.

**California Micro Devices Corp.**  
215 Topaz St.  
Milpitas, CA 95035-5430  
(408) 263-3214  
► CIRCLE 819

▼ **ALUMINUM CAPACITOR FEATURES LOW LEAKAGE**

Designed for use in timing circuits and as an alternate to tantalum capacitors, the Series RLS aluminum-electrolytic capacitors feature a low leakage current of  $\leq 0.002\ \text{CV}$  or  $0.4\ \mu\text{A}$  minimum. The radial-lead devices come in a capacitance range of

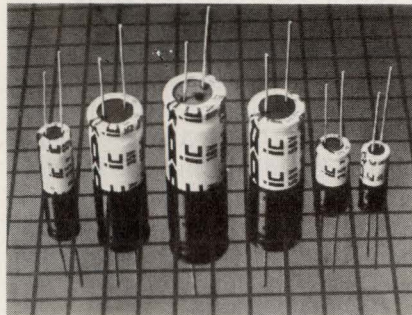

0.1 Mfd to 1000 Mfd. Working voltage range is from 10 to 50 V dc. Call for pricing and delivery.

**Illinois Capacitor Inc.**  
3757 W. Touhy Ave.  
Lincolnwood, IL 60645  
(708) 675-1760  
► CIRCLE 820

▼ **DOT-MATRIX TILES FORM LARGE DISPLAYS**

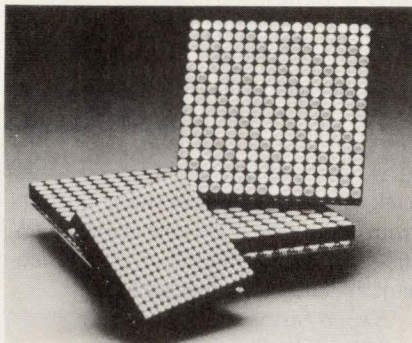

A square LED display is available that's capable of highly luminous, switchable red, green, or yellow output in each of its 256 pixels. The LU2563-5MU 16-by-16 dot matrix is meant for use in large graphic panels. The unit is designed as a subsystem that eliminates much of the costly pixel-level hardware development. Each tile is composed of T-1-3/4 LEDs of matched brightness. Pricing averages \$100 per module in lots of 1000. Delivery is in from six to eight weeks.

**ROHM Corp.**  
8 Whatney  
Irvine, CA 92718  
(714) 855-2131  
► CIRCLE 821

▼ **SAPPHIRE SPLIT-STATOR CAPACITORS AUGMENT LINE**

A series of sapphire-dielectric, split-stator trimmer capacitors has been added to the Surftrim line of SMT trimmer capacitors. The GPY Series devices have a protective O-ring seal that permits conventional cleaning methods. The capacitors are designed for reflow and flow soldering and are resistant to solder flux and solder baths. Four capacitance ranges are available from 0.4 to 2.0 pF to 0.5 to 5.0 pF. Dielectric withstanding voltage is 130 V dc and voltage rating is 63 V dc. Insulation resistance is  $10^4\ \text{M}\Omega$  minimum. Prices start at \$1.16 in lots of 5000. Delivery is from stock to eight weeks.

**Sprague-Goodman Electronics Inc.**  
134 Fulton Ave.  
Garden City Park, NY 11040  
(516) 746-1385  
► CIRCLE 822

▼ **FOUR-TERMINAL RESISTOR FEATURES HIGH STABILITY**

Tight tolerance, high stability, low TCR, and fast response time are attributes of the VPR247 precision power resistors. The four-terminal devices, which meet or exceed MIL-R-39009B environmental performance limits, range in value from  $0.05\ \Omega$  to 500  $\Omega$ . Tolerances are offered to 0.01% and  $\pm 5\ \text{ppm}/^{\circ}\text{C}$ . Power handling is rated at 10 W on a heat

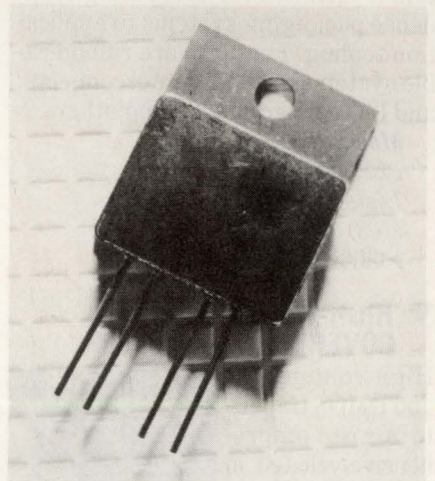

sink and 3 W in free air. Call for pricing and delivery.

**Vishay Bulk Metal Resistors**  
63 Lincoln Hwy.  
Malvern, PA 19355  
(215) 644-1300  
► CIRCLE 823

## NEW LITERATURE

### ▼ SWITCH, RELAY LINES FILL LARGE CATALOG

Extensive lines of relays and mechanical and optical switches are the subject of a 144-page catalog. Included are products designed for computer-peripheral, telecommunication, security, test and measurement, office-automation, and consumer-electronic applications. Product specifications and illustrations are given for many varieties of devices.

**Omron Electronics Inc.**  
Control Components Div.  
One E. Commerce Dr.  
Schaumburg, IL 60173  
(800) 62-OMRON  
▶ CIRCLE 824

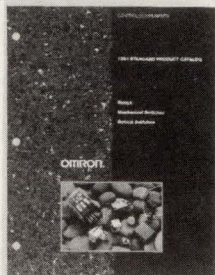

### ▼ INTERCONNECT BOOK SPANS 30,000 PRODUCTS

More than 30,000 interconnection products in 16 categories are covered in Molex's #910 full-line catalog. Product descriptions, specifications, photos, drawings, cross references, and ordering information is included for everything from dense packaging systems to application tooling. Featured are ribbon-cable systems, pc-board interconnects, and I/O connectors, among others.

**Molex Inc.**  
2222 Wellington Ct.  
Lisle, IL 60532  
(708) 969-4550  
▶ CIRCLE 825

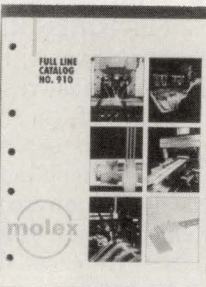

### ▼ HIGH-VOLTAGE ICs COVERED IN DATABOOK

High-voltage ICs and DMOS transistors are comprehensively listed in a 755-page databook. Cross-reference and selector guides, packaging sections, die topographies, and over 100 new products are detailed. Included are devices for use in commercial,

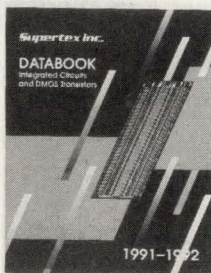

industrial, medical, and military markets.

**Supertex Inc.**  
1225 Bordeaux Dr.  
Sunnyvale, CA 94088-3607  
(408) 744-0100  
▶ CIRCLE 826

### ▼ SNAP-ACTING SWITCHES IN 148-PAGE CATALOG

A full line of snap-acting, metal-cased, pushbutton, and toggle switches are detailed in the 148-page Catalog No. U9003. An easier-to-use format, including Unimax's Build-A-Switch ordering system, make the catalog a highly informative resource. Literally millions of switch models are possible.

**C&K/Unimax Inc.**  
P.O. Box 152, Ives Rd.  
Wallingford, CT 06492-0152  
(203) 269-8701  
▶ CIRCLE 827

### ▼ SWITCHER CATALOG FEATURES NEW PRODUCTS

The #146-1739 switching-power-supply catalog provides expanded coverage of a full line of switch-mode products and power assemblies. Featured is the FPD Series of flat-pack dc-dc converters with outputs from 5 to 100 W. Also new are the FAW 100- and 150-W switchers. All pertinent specifications are included.

**Kepeco Inc.**  
131-38 Sanford Ave.  
Flushing, NY 11352  
(212) 461-7000  
▶ CIRCLE 828



### ▼ RELAYS AND SWITCHES COME IN WIDE VARIETY

A large array of electromagnetic relays, solid-state switches, reed switches, surge arresters, and display components are covered in the 68-page Catalog 220. Charts of specifications, illustrations, contact schematics, and characteristic charts are included.

**CP Clare Corp.**  
3101 W. Pratt Ave.  
Chicago, IL 60645  
(312) 262-7700  
▶ CIRCLE 829

### ▼ INDICATING LIGHTS BRIGHTEN UP DATA BOOK

High-brightness T-1 and T-1-3/4 blue LEDs are featured along with an expanded assortment of pcb- and panel-mounted indicators in a 224-page data book. The book also includes new additions to an extensive line of LED products. Technical data on LEDs, incandescent, and neon lamps is highlighted as well as illustrations and complete specifications.

**Industrial Devices Inc.**  
260 Railroad Ave.  
Hackensack, NJ 07601  
(201) 489-8989  
▶ CIRCLE 830

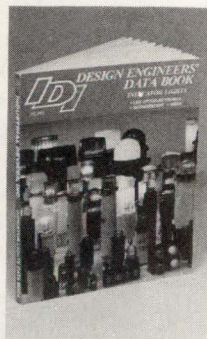

### ▼ POWER-CONVERTER BOOK COVERS 1-TO-30-W UNITS

Over 170 power-conversion products with outputs from 1 to 30 W are covered in a 148-page catalog. Complete specifications, data sheets, ordering guides and applications are detailed. Included are 57 new wide-range-input, high-efficiency dc-dc converters. A complete glossary of power-supply terms is included, as is a section on modern power-supply principles and practices.

**Datel Inc.**  
11 Cabot Blvd.  
Mansfield, MA 02048  
(508) 339-3000  
▶ CIRCLE 831



### ▼ QUARTZ CRYSTALS FILL 44-PAGE CATALOG

A wide range of quartz crystals, hybrid clock oscillators, and custom hybrids for wide application are featured in a 44-page databook. Included are illustrations and engineering data sheets.

**M-tron Industries Inc.**  
P.O. Box 630  
Yankton, SD 57078  
(800) 762-8800  
▶ CIRCLE 833

# National's new LDOs don't make batteries last forever. It just seems that way.

## Get longer battery life in portable applications.

When it comes to extending battery life in everything from mobile phones to laptop PCs, our new LP2952 family of 250mA LDOs doesn't know when to quit. Even as battery strength drops. Because the input voltage can fall to a level close to the output voltage and the LDO will still work well. Just take a look at the specs:

- Lowest dropout voltage: 60mV
- Lowest quiescent current: 90 $\mu$ A

## Get high precision with low power consumption.

National's LDOs are built with our proprietary deep-base PNP process developed especially for LDO regulators. This process sets a new standard for micropower regulators, and, combined with our innovative design, provides the following features:

- Output voltage tolerance of  $\pm 1\%$
- Reverse battery protection

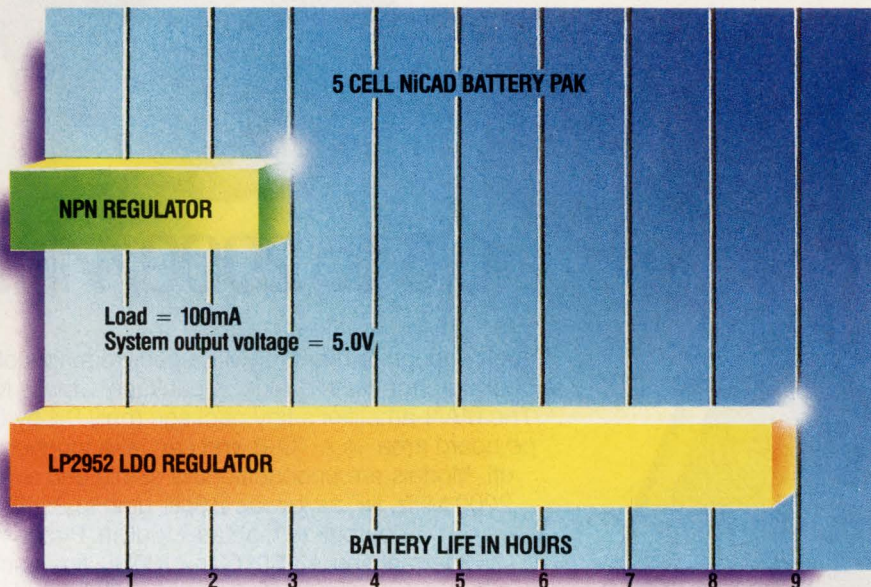

- Current-limiting feature protects against short circuits
- Thermal shutdown feature protects regulator against excessive heat
- Error flag indicates when output voltage drops out of regulation (LP2953 only)

## Get all the advantages of our LDO heritage.

When it comes to LDOs, you can't beat National's product

portfolio. We introduced the first LDO. And we've been leading the way ever since. With more LDOs in more output ranges than anyone else.

All available in multiple packages. Including 3-pin TO-220 and TO-92 plastic, surface-mount, metal can and 8-pin DIP. Plus, they'll be available with 883/SMD screening in early 1992.

## Get all the facts on longer battery life today.

For your design kit, write or call us: **1-800-NAT-SEMI, Ext. 131.** And make your batteries last longer than ever before.

Part	LM2936	LP2950	LP2951	LP2952	LP2953*	LP2954	LM2940	LM2941
I <sub>o</sub>	50mA	100mA	100mA	250mA	250mA	250mA	1Amp	1Amp
V <sub>o</sub>	5V	5V	1.23V to 29V	1.23V to 29V	1.23V to 29V	5V	5V, 8V, 9V, 10V, 12V, 15V	5V to 20V
Package	Z, M	Z	J, N, M, H	N, M	N, M	T	T	T

H = Metal Can  
J = Ceramic DIP  
M = Surface Mount  
N = Plastic DIP  
T = TO-220  
Z = TO-92

\* (with Additional Comparator)

©1991 National Semiconductor Corporation

# rugged plug-in amplifiers



0.5 to 2000 MHz from \$13<sup>95</sup> (10 to 24 qty)

Tough enough to meet full MIL-specs, capable of operating over a wide -55° to +100°C temperature range, in a rugged package... that's Mini-Circuits' new MAN-amplifier series. The MAN-amplifier's tiny package (only 0.4 by 0.8 by 0.25 in.) requires about the same pc board area as a TO-8 and can take tougher punishment with leads that won't break off. Models are unconditionally stable and available covering frequency ranges 0.5 to 2000 MHz, NF as low as 2.8dB, gain to 28dB, isolation greater than 40dB, and power output as high as +15dBm. Prices start at only \$13.95 *including* screening, thermal shock -55°C to +100°C, fine and gross leak, and burn-in for 96 hours at 100°C under normal operating voltage and current.

Internally the MAN amplifiers consist of two stages, including coupling capacitors. A designer's delight, with all components self-contained. Just connect to a dc supply voltage and you are ready to go.

### The new MAN-amplifiers series...

- wide bandwidth • low noise • high gain
- high output power • high isolation

MODEL	FREQ. RANGE (MHz)	GAIN dB		MAX PWR†	NF	ISOL.	DC PWR	PRICE
	$f_L$ to $f_U$	min	flat††	dBm	dB (typ)	dB (typ)	V/ma	\$ ea. (10-24)
MAN-1	0.5-500	28	1.0	+8	4.5	40	12/60	13.95
MAN-2	0.5-1000	18	1.5	+7	6.0	34	12/85	15.95
MAN-1LN	0.5-500	28	1.0	+8	2.8	39	12/60	15.95
◇MAN-1HLN	10-500	10	0.8	+15	3.7	14	12/70	15.95
MAN-1AD	5-500	16	.05	+6	7.2	41	12/85	24.95
MAN-2AD	2-1000	9	0.4	-2	6.5	28	15/22	22.50
MAN-11AD	2-2000	8	0.5	-3.5	6.5	22	15/22	29.95

††Midband  $10f_L$  to  $f_U/2$ ,  $\pm 0.5$ dB † 1dB Gain Compression ◇Case Height 0.3 in. Max input power (no damage) +15dBm; VSWR in/out 1.8:1 max.

Free...48-pg "RF/MW Amplifier Handbook" with specs, curves, handy selector chart, glossary of modern amplifier terms, and a practical Question and Answer section.

finding new ways ...  
setting higher standards

## Mini-Circuits

A Division of Scientific Components Corporation  
P.O. Box 350166, Brooklyn, New York 11235-0003 (718) 934-4500  
Fax (718) 332-4661 Domestic and International Telexes: 6852844 or 620156

CIRCLE 296 FOR U.S. RESPONSE  
CIRCLE 297 FOR RESPONSE OUTSIDE THE U.S.

C118 REV. F



# CIRCLE 521 SET COMPARATOR'S WINDOW LIMITS

FRANTISEK MICHELE

Barvicova 17A, CS 60200 Brno, Czechoslovakia.

**B**y combining a dual-buffered digital-to-analog converter with a four-input CMOS comparator, a comparison circuit with a digitally programmable window center and width can be produced. The circuit has three outputs, each indicating the logical states and whether the analog voltage is inside the window or above or below the window's limits (see the figure).

With the components shown, the center voltage of the window can be programmed from -10.24 to +10.235

V, and the window width from 0 to +20.47 V, both in 0.005-V steps. The two are fully independent of each other and the input,  $V_{in}$ .

In the circuit, the DAC (DAC-8222) and three op amps (OP-400) generate the voltages  $V_X$  (center voltage for LTC-1040) and  $V_Y$  (half of a window width) from binary data stored in DAC latches. DAC-A works in bipolar operation configuration and DAC-B works in a unipolar fashion. The DAC control signals  $\overline{DAC-A}$ / $\overline{DAC-B}$ ,  $\overline{LDAC}$  and  $\overline{WR}$  are generated from the microprocessor address

bus, because using a microprocessor control is the best way to program this circuit. The DAC links with popular microprocessors as shown in the manufacturer's data book (Precision Monolithics Inc., volume 10, 1990). REF-08 supplies a -10.24-V reference voltage to the DAC's  $V_{REF-A}$  and  $V_{REF-B}$  inputs.

The LTC-1040 consists of two sampling-mode comparators that drive the outputs of Out-1, Out-2, and Out-3. Out-1 will be high if the algebraic sum of the voltages at inputs  $A_{in1-in4}$  is positive with respect to the polarity of the LTC-1040 inputs:

$$V_{in} - V_X - V_Y > 0$$

Therefore,

$$V_{in} > V_X + V_Y$$

This means that Out-1 will be high if  $V_{in}$  is greater than the upper limit of the window ( $V_X + V_Y$ ). Also, Out-2

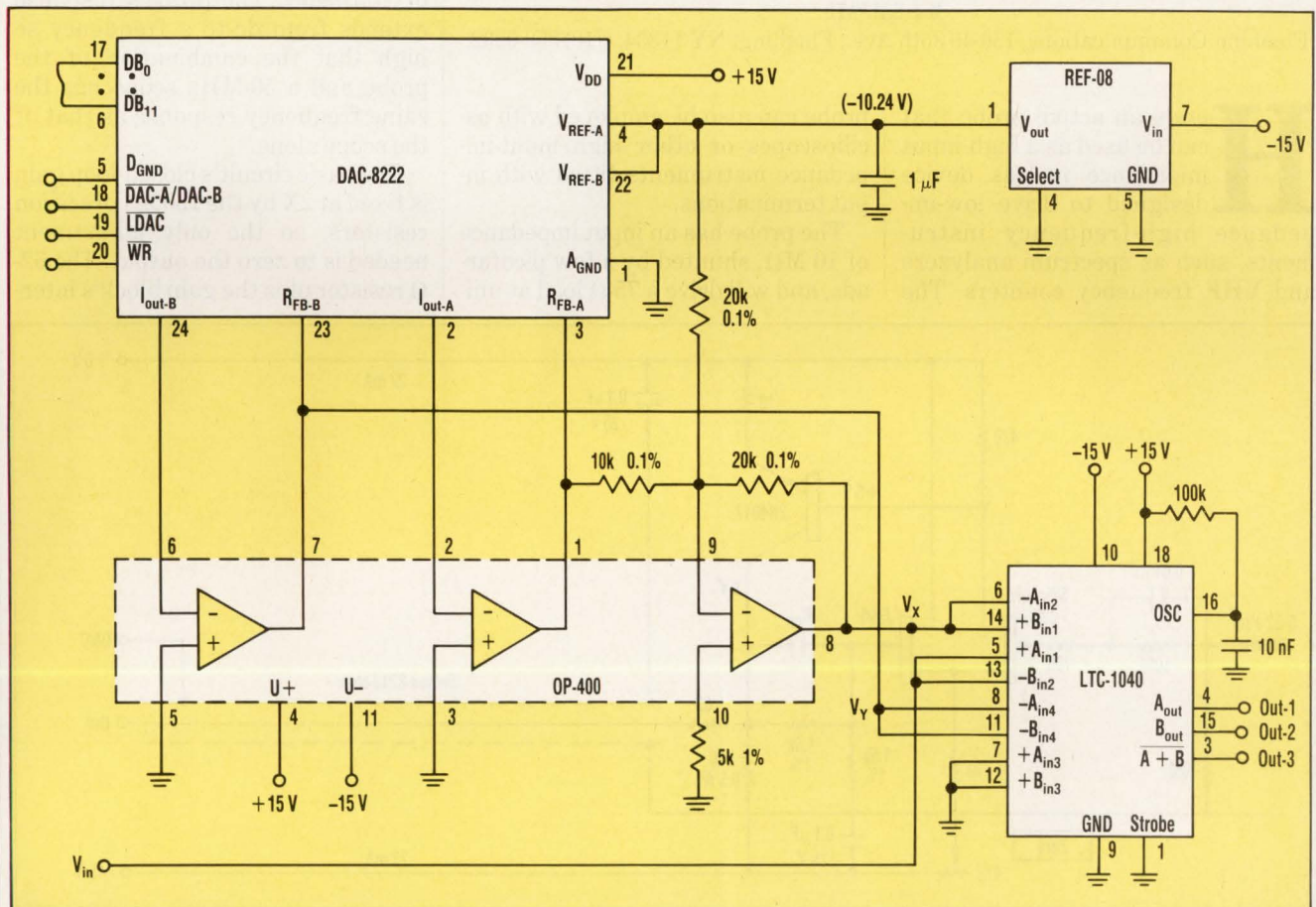

**A DUAL BUFFERED** digital-to-analog converter (DAC-8222) combines with a dual four-input CMOS comparator (LTC-1040) to form a comparator with digitally programmable window limits. The circuit's accuracy is within  $\pm 0.01$  V over the full ranges of  $V_X$  and  $V_Y$ .

will be high if the sum of the voltages at  $B_{in1-in4}$  is positive:

$$\begin{aligned} V_X - V_{in} - V_Y &> 0 \\ -V_X + V_{in} + V_Y &< 0 \\ V_{in} &< V_X - V_Y \end{aligned}$$

Out-2 will be high if  $V_{in}$  is lower than the window's bottom limit ( $V_X - V_Y$ ). Out-3 will be high if both Out-1 and Out-2 are low:

$$V_X - V_Y < V_{in} < V_X + V_Y$$

Consequently, Out-3 will be high if  $V_{in}$  is greater than the bottom limit and simultaneously lower than the window's upper limit. The R-C combination at the LTC-1040's pin 16 de-

## $V_X$ , $V_Y$ , AND THEIR DIGITAL EQUIVALENTS

Form of window	$V_X$	$V_Y$	Latched input data in DAC-A	Latched input data in DAC-B
+1V _____ -1V _____	0V	1V	1000 0000 0000 (decimal 2048)	0001 1001 0000 (decimal 400)
+2V _____ 0V _____	1V	1V	0111 0011 1000 (decimal 1848)	0001 1001 0000 (decimal 400)
+2V _____ -4V _____	-1V	3V	1000 1100 1000 (decimal 2248)	0100 1011 0000 (decimal 1200)

termines the circuit's sampling rate to about 1000 samples/s.

Some examples of  $V_X$  and  $V_Y$  show the digital equivalents that are stored in DAC-input-data latches for window creation in the circuit (see the table).

One attractive feature of this

high-precision, low-power circuit is that it needs no special calibration. Its accuracy error is a maximum of  $\pm 0.01$  V over the full range of  $V_X$  and  $V_Y$ . For higher-precision applications, follow the DAC calibration procedure recommended by the manufacturer. □

## CIRCLE 522 PROBE DRIVES LOW-IMPEDANCE INPUTS

M.J. SALVATI

Flushing Communications, 150-46 35th Ave., Flushing, NY 11354; (718) 358-0932.

Here's an active probe that can be used as a high-input impedance no-loss device designed to drive low-impedance high-frequency instruments, such as spectrum analyzers and VHF frequency counters. The

probe can also be employed with oscilloscopes or other high input-impedance instruments fitted with input terminations.

The probe has an input impedance of 10 M $\Omega$ , shunted by a few picofarads, and will drive a 75- $\Omega$  load at uni-

ty gain (see the figure). This eliminates the 20- or 40-dB loss characteristic of the passive probes commonly used in 50- and 75- $\Omega$  systems. It also maintains the scale factors of a scope or voltmeter. The probe's response extends from dc to a frequency so high that the combination of the probe and a 50-MHz scope has the same frequency response as that of the scope alone.

The basic circuit's closed-loop gain is fixed at 2X by the 1500- $\Omega$  precision resistors, so the only adjustment needed is to zero the output. The 62- $\Omega$  resistor plus the gain block's inter-

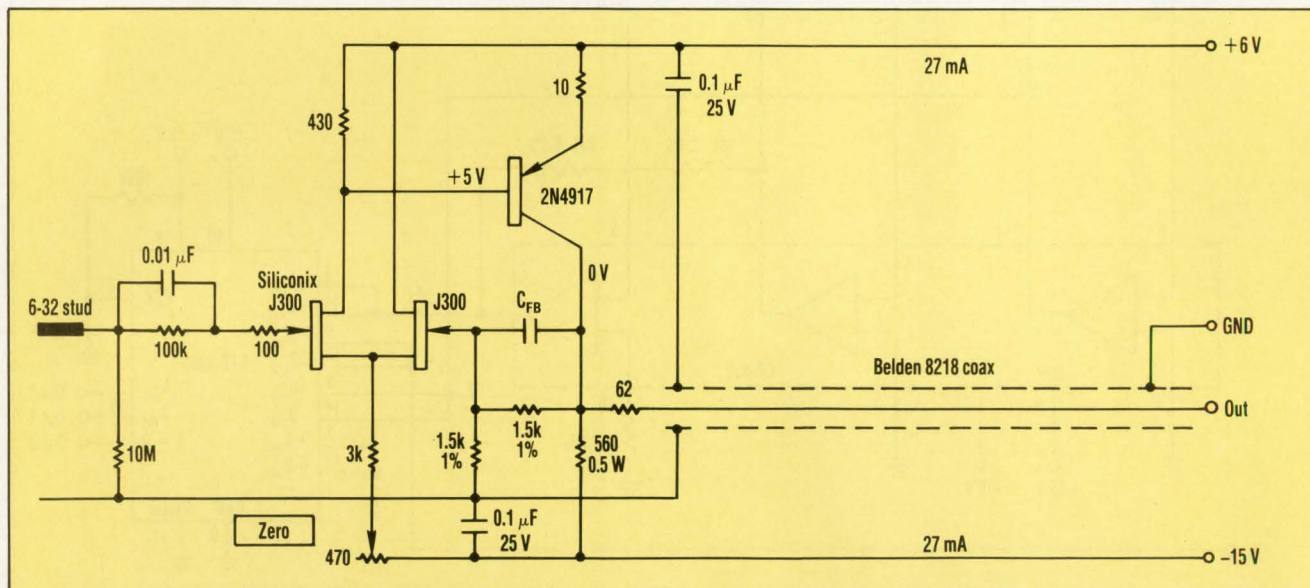

**THIS UNITY-GAIN ACTIVE PROBE**, with an input impedance of 10 M $\Omega$ , can drive low-impedance high-frequency instruments. The only adjustment needed for the circuit is to zero its output.

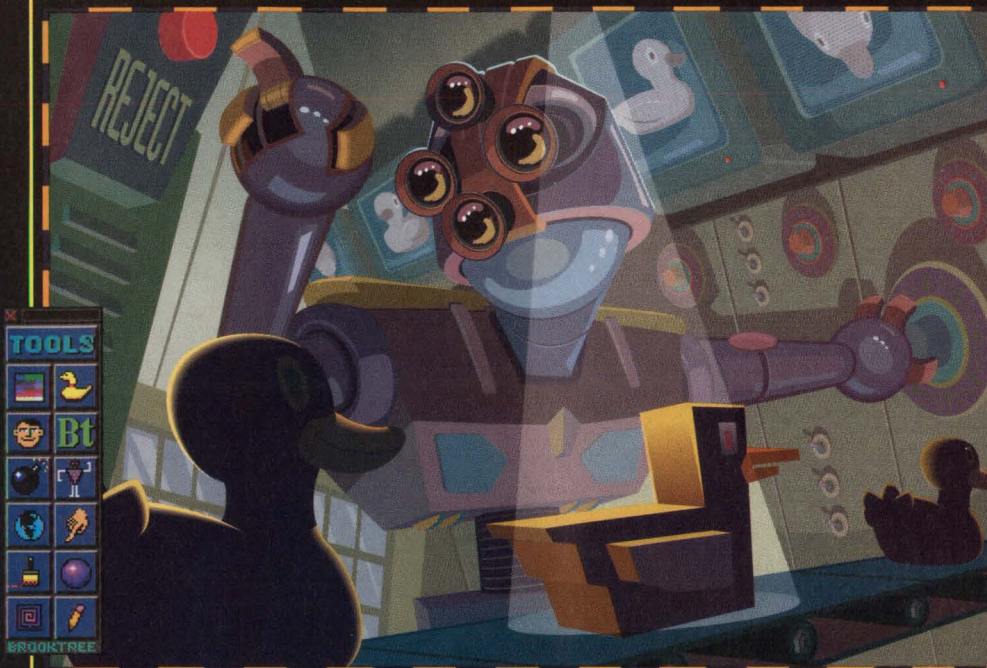

## Do Machine Visionaries Have Digit Eyes?

**I**f you're digitizing images for machine vision applications, you may have run into incorrect brightness and intensity problems created by hardware non-linearities. These shortcomings in cameras and monitors can be overcome if your image digitizer has an on-board lookup table to correct such **gamma error**—like Brooktree's new **Bt252** gray-scale image digitizer.

It was designed for machine vision applications. Pattern recognition, for example, often requires **multiple cameras** to

capture different data perspectives. The **Bt252** has an input mux to accommodate up to four image sources.

**Differing light levels** require the ability to control the reference levels where digitization begins and ends—and program these levels on the fly. That's an important feature of the **Bt252**.

Brooktree is committed to providing applications-oriented solutions to your machine vision imaging problems. Ask for technical literature on our family of fast A/Ds and support devices.

## Encoding and Decoding Digital Video? Brooktree is D1

**I**f your workstation or broadcast system sends, receives, manipulates or displays digital video, you've probably developed a preference for the **D1** video standard over the **D2** standard. No wonder. D2's digitization

of composite video can be quite "lossy." D1, on the other hand, uses a **4:2:2** video format which samples chrominance and luminance independently and at different rates, giving you greater flexibility while preserving video quality.

For more on D1, and Brooktree's chip sets that provide complete 4:2:2 digital video for point-to-point reception and transmission, ask for: **Bt291/294/296/297**.

## STAY TUNED FOR DESKTOP VIDEO

**I**f you've got multimedia on the mind—who doesn't?—you know that video is the most exciting part of the picture.

Full motion video in a window on a PC or workstation opens up a panorama of powerful new applications.

The relentless charge into video is driving the demand for true-color RAMDACs, like Brooktree's 32-bit, 170 MHz **Bt463**, designed for workstation applications, and 24-bit 85 MHz true-color RAMDAC, the **Bt484**. Ask for: **Bt463/484/473**.

## WHERE IT'S AT

**I**f your idea of a great work environment is with a company where innovation is encouraged, responsibility is welcomed and personal growth is fostered, go to where it's happening every day - Brooktree. The industry's leader in video ICs needs go-getters in these areas:

- IC Design Engineers
- IC Product Engineers
- IC Test Engineers
- Test Maintenance Technicians

Send your resume today, or

FAX **619/452-7294**.

We're an Equal Opportunity Employer. M/F/H/V.

Brooktree Corporation  
9950 Barnes Canyon Rd.  
San Diego, CA 92121

1-800-VIDEO-IC

Brooktree®

EDITORIAL CONTRIBUTIONS: TOM KOVANCIC and TOM RAMSTHALER

**NEW**

## 1553 Manchester Encoder/Decoder Set

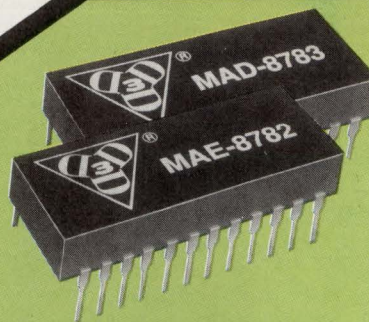

- Very stable
- 24 pins DIP
- 20 MBAUD
- TTL IN/OUT
- High speed optics
- Military/commercial aircraft application

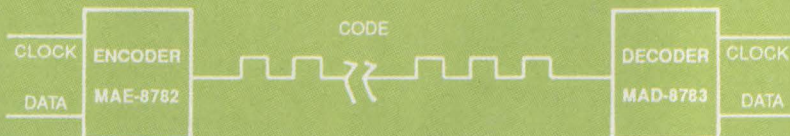

(201) 773-2299  
FAX (201) 773-9672  
Clifton, New Jersey 07013

**data delay devices, inc.**

CIRCLE 204 FOR U.S. RESPONSE  
CIRCLE 205 FOR RESPONSE OUTSIDE THE U.S.

Turn your  
**excess inventory**  
into a substantial tax break  
and help send needy  
**kids to college.**

Call for your  
**free guide**  
to learn how donating your  
slow moving inventory  
can mean a generous  
**TAX WRITE OFF**  
for your company.

Call **708-690-0010**

**Peter Roskam**  
Executive Director

**EAL**

P.O. Box 3021, Glen Ellyn, IL 60138  
Fax (708) 690-0565

*Excess inventory today...  
student opportunity tomorrow*

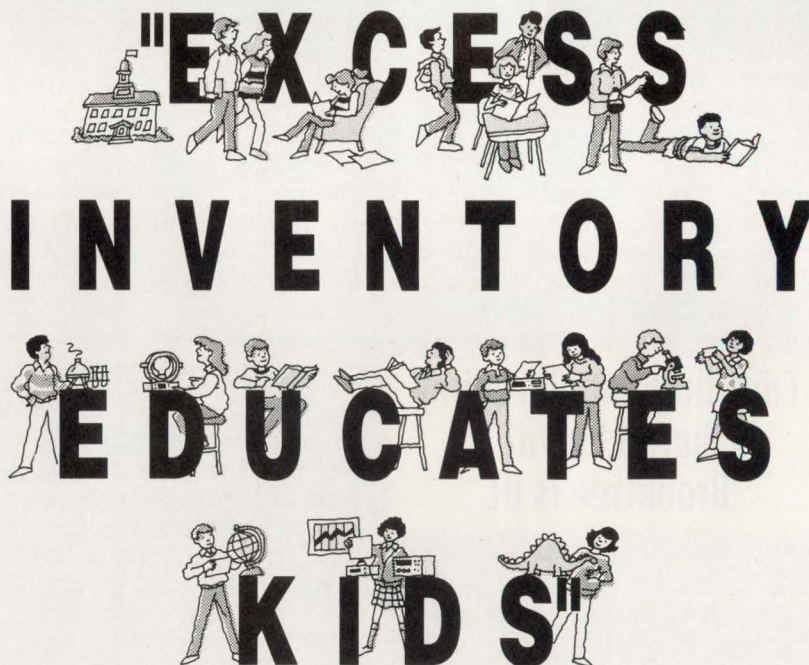



The Bettman Archive, Inc.

## It takes experience to handle both limpness *and* flexibility.

Small, lightweight, flexible--these are the requirements we meet often. But "*limp as a noodle?*" An appetizing challenge.

Texas Instruments came to us for a complete interconnect system for a gyroscope controlled guidance system. Application-engineered to extremely demanding weight and space requirements, this dynamic system also must endure constant flexing.

At Precision Interconnect, we're working every day to meet requirements like these. We manufacture microminiature cables with conductors as small as 42 AWG and terminate them to our standard line of Micro-D and linear strip connectors with .050" (1.27mm) centerline spacing. Custom and nano strip connectors with .025" (.64mm) spacing can also be assembled.

Our expertise, increasing with each unique problem we solve, ensures that all critical components of your interconnect system are designed in, built in, and tested. We begin by discussing your specific interconnect system problems.

Maybe over lunch?



**PRECISION  
INTERCONNECT**

16640 S.W. 72nd Avenue  
Portland, OR 97224  
(503)620-9400

Offices in San Francisco, Dallas,  
Wilmington, Düsseldorf and Tokyo.

*This ultra flexible harness for Texas Instruments terminates Nano Strip and Micro-D connectors to 43 conductors, 32 to 40 AWG.*

CIRCLE 252 FOR U.S. RESPONSE

CIRCLE 253 FOR RESPONSE

OUTSIDE THE U.S.

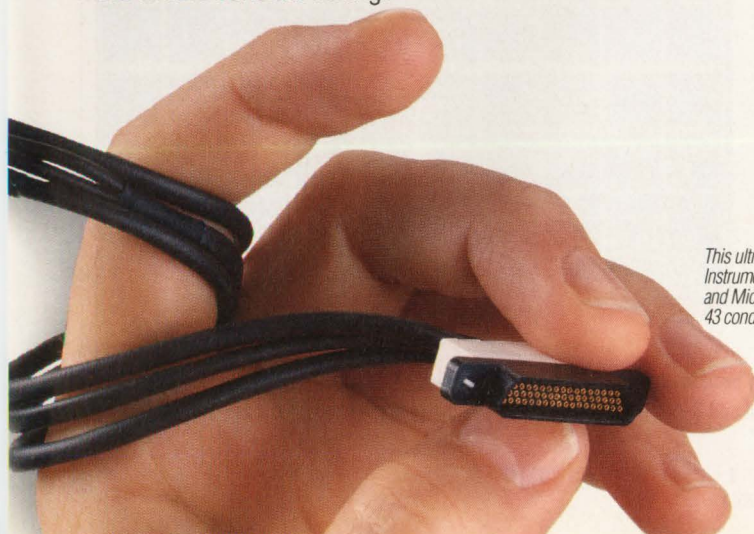

nal output impedance produces unity gain into a 75-Ω termination. For 50-Ω systems, a 36-Ω resistor and different coax should be used. The feedback capacitor value—which depends on circuit layout—is selected for flattest frequency response; in the author's case, a value of 1.8 pF did the job when the circuit was constructed.

Miniature parts and careful construction enable this unit to be packaged in a 5-in. length of 1-in.<sup>2</sup> aluminum tubing fitted with plastic end plugs. The probe is constructed with a 6-32 screw protruding from the input so that Tektronix probe-tip accessories to be used. The power leads are wrapped around the miniature coax. □

## IFD WINNER

IFD Winner for  
February 14, 1991

**M.S. Nagaraj**, ISRO Satellite Centre, Digital Systems Div., Airport Rd., Vimanapura P.O., Bangalore 560 017 India. His idea: "Add Sensing To LM317 Regulator."

## **CIRCLE** **523** VIEW LOW DUTY-CYCLE WAVEFORMS

D. BHANUMURTY

Defense Electronics Research Laboratory, Government of India, Hyderabad-500 005, India; 239061.

To observe very low duty-cycle pulse waveforms on a CRT, the CRT's intensity level must be increased almost to its maximum just to detect the pulse's presence. When this happens, the pulse's baseline is seen with a poorly illuminated pulse top (*see the figure, a*). If the baseline illumination is reduced by decreasing the intensity, the pulse top might not be visible.

Theoretically, a complete sweep, which includes the baseline and the

pulses, should appear with equal intensity. The waveform's baseline is divided into small segments, each equal in length to the pulse width. The electron beam lands on the CRT in what looks like a circle with a diameter that's several times greater than the pulse width. This situation arises when measurements are made on low duty-cycle waveforms. Shrinking the CRT dot to a certain size is a practical limitation. As a result, the CRT dot occupies several line segments of the baseline and

comes in contact with each segment for a period that's several times more than the pulse width. The CRT dot remains for a duration equal to the pulse width on the pulse top. The difference in contact time gives rise to the highly intensified baseline.

One way to improve the display is to reduce the baseline's illumination without affecting the pulse tops. This can be done by using the Z input, a feature found on most oscilloscopes. The waveform to be observed is applied to the vertical channel and the Z input simultaneously. The baseline illumination is reduced because its voltage is less than the pulse voltage. By keeping the intensity control at a convenient position, the baseline and the pulse tops can be displayed with equal intensity (*see the figure, b*). This technique is suitable for viewing single-event narrow pulses and glitches. □

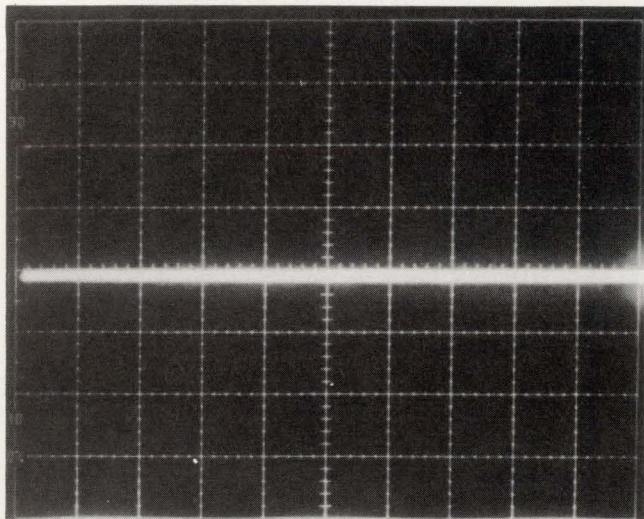

(a)

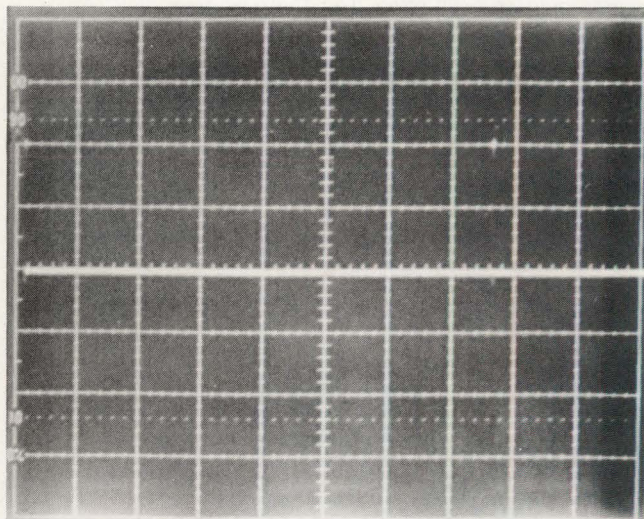

(b)

**A VERY LOW DUTY-CYCLE WAVEFORM** is typically hard to observe because it appears with a highly illuminated baseline (a). With the same waveform applied simultaneously to the scope's vertical and Z-axis inputs, waveform peaks are more visible because their intensity is much closer to that of the baseline (b).



# ULTIMATE CONTROL

No one can give you control of your GPIB test system like National Instruments can.

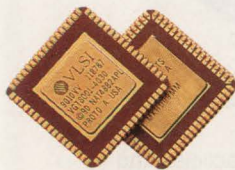

## PERFORMANCE

The NAT4882™ chip makes our GPIB controller boards completely IEEE-488.2 compatible. When the NAT4882 is teamed with the Turbo488® performance chip, you get the maximum IEEE-488 transfer rate of 1 Mbytes/sec for both read and write operations.

Use our industry-standard NI-488® software to control your GPIB instruments and give your test programs maximum throughput, regardless of your choice of personal computers or workstations.

## COMPATIBILITY

The NAT4882 controller chip is also compatible with the controller chips of the past, so you get the best of both worlds – complete compatibility with your existing applications and the ability to meet your future requirements.

And when your controller needs change, NI-488 programs are compatible across many different platforms and operating systems – without modification.

## UPGRADE PROGRAM

Existing PC, PS/2, and Macintosh customers can upgrade to the benefits of IEEE-488.2 and increased performance through a special upgrade program.

## TRAINING

Learn even more ways to improve your test system by taking our hands-on, IEEE-488 training course.

For more information on how you can have the ultimate GPIB control, call:  
 (512) 794-0100 or  
 (800) 258-7014  
 (Toll-free U.S. and Canada)



6504 Bridge Point Parkway  
 Austin, TX 78730-5039

AUSTRALIA (03) 879 9422 • DENMARK (45) 76 73 22 • FRANCE (1) 48 65 33 70 • GERMANY (089) 714 5093 • ITALY (02) 4830 1892  
 JAPAN (03) 3788 1921 • NETHERLANDS (01720) 45761 • NORWAY (03) 846 866 • SPAIN (908) 604 304 • SWITZERLAND (056) 45 58 80 • U.K. (0635) 523 545  
 Product names listed are trademarks of their respective manufacturers. Company names listed are trademarks or trade names of their respective companies. © Copyright 1991 National Instruments Corporation. All rights reserved.

CIRCLE 276 FOR U.S. RESPONSE

CIRCLE 277 FOR RESPONSE OUTSIDE THE U.S.

RELIABILITY YOU CAN DEPEND ON!

# MILITARY DC-DC CONVERTERS

## DC INPUT

18-300V for:  
28V  
48V  
155V  
270V  
BUS

## DC OUTPUT

to 110A  
2 to 300V  
1 to 8 outputs  
to 600 watts

**MULTI OUTPUT**  
EL2000 SERIES

# WE PUT IT ALL TOGETHER

## CONDITIONED INPUTS FOR LAND, SEA & AIR

- Surge and spike protection to input requirements of Mil-Std-1275A and Mil-Std-704D.

- Operation to Mil-Std-810D environments.

- High density designs to 24 watts/in.<sup>3</sup>.

- Efficiencies to 80%+.



Mil-Std-1275A

- Extended MTBF to >500,000 hours.
- Low EMI/RFI options available.

- Meets applicable requirements of Mil-E-5400T,

Mil-E-16400,  
Mil-E-4158E and  
Mil-Std-454J.

- Design and derating to NAVMAT P4855-1.



Mil-Std-704D

- Mil-I-45208A facilities and systems.

- Standard products for custom applications without NRE.

- Short lead times...deliveries in weeks not months.

For complete brochure and applications assistance please call **Toll Free 1-800-421-8181** (in CA 805/484-4221)

**ARNOLD**  **MAGNETICS**

## ARNOLD MAGNETICS CORPORATION

4000 Via Pescador, Camarillo, California 93012 • Phone: (805) 484-4221 • FAX: (805) 484-4113

CIRCLE 118 FOR U.S. RESPONSE

CIRCLE 119 FOR RESPONSE OUTSIDE THE U.S.



# ELECTRONIC DESIGN

# QUICK LOOK

EDITED BY SHERRIE VAN TYLE

## MARKET FACTS

**S**ales of computer graphics workstations are expected to grow a brisk 172% in five years, according to Frost & Sullivan International. The units' price-to-performance ratio is improving 50% a year, says the New York market researcher.

The U.S. market for graphics workstations, file servers, software, and services, worth \$10.2 billion last year, should amount to \$27.7 billion in 1995. With faster chips powering new workstations, a replacement market for older, slower workstations is ramping up.

File servers are especially hot. Their sales are expected to more than triple, from \$895 million last year to \$3.69 billion in 1995. Sales of computer platforms are forecast to increase 159% from \$8.08 billion in 1990 to \$20.9 billion in 1995. Revenues from software and services will increase 158% in that span, going from \$1.22 billion to \$3.14 billion.

As for the platforms, RISC workstations are coming on strong. They're expected to grab about two-thirds of dollars sales and unit volume by 1995. The commercial market is growing fastest, accounting for an 11% share last year, which should more than double to 25% by 1995. The telecommunication and computer sectors also are expected to show strong demand.

## WHO'S BUYING COMPUTER GRAPHICS WORKSTATIONS?

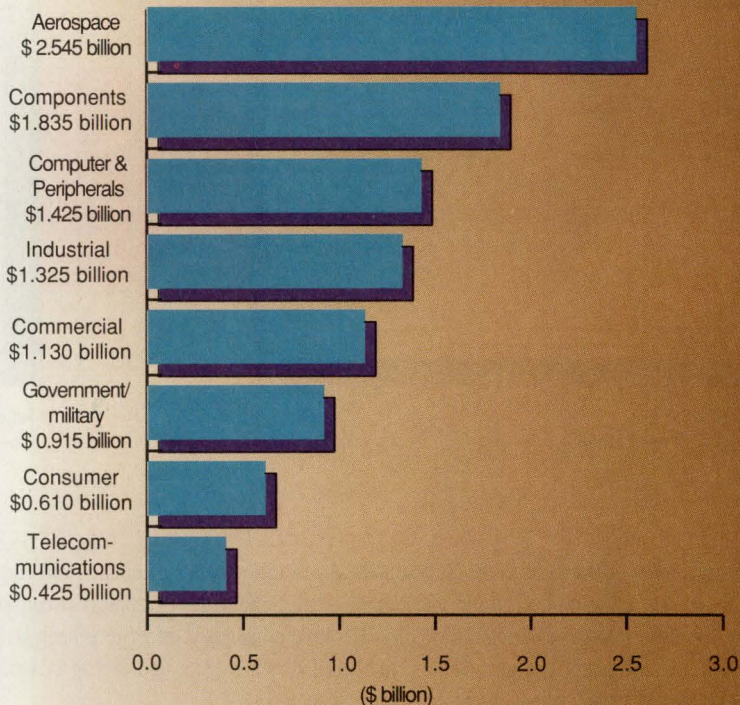

Source: Frost & Sullivan Inc.

Total 1990 market: \$10.19 billion

## TIPS ON INVESTING

**I**nvesting in the 90s is turning out to be very different from investing in the 80s. In the 80s back-to-back recessions took the core inflation rate to less than 4%, well below the 6%-plus inflation rate that prevailed in the mid-1970s. This phenomenon has significant implications for interest rates and investments in the 90s. As demand for credit slows and inflationary pressures abate, interest rates should trend lower.

Lower inflation and lower interest rates should make fixed-income investments, such as bonds, less attractive to investors while stocks should become more attractive. Investors accustomed to CDs, Treasury bills, and money market funds yielding 8% to 9% may not be able to find comparable yields when their investments mature. To maintain their returns, investors will return to the stock market, which has produced average annual returns of 10%.

Increased demand should cause stock prices to rise; stock market values could double over the next several years. Even conservative, income-oriented investors should consider blue-chip stocks with high

dividend yields. Unlike bonds, stocks earn dividends with some potential for growth. Dividends have grown steadily for many years, helping investors keep pace with inflation. In the 90s and beyond, fixed-income investments could produce less income while stocks should produce more. The Dow Jones industrial average could reach 4400 to 4600 by 1996, a 55% increase from today's levels, say experts. If 20% dividend accumulations are added to that 55% gain, equities could produce a total return (yield plus capital appreciation) of about 75%.

A professional investment manager can customize an engineer's portfolio according to the individual's investment goals. Equity portfolio managers are now available with \$50,000 minimum investment. Call or write to me for a free copy of *Professional Portfolio Management—Making the Right Choice*.

Henry Wiesel is a financial consultant with Shearson Lehman Brothers, 1040 Broad St., Shrewsbury, NJ 07702; (800) 631-2221 or (800) 221-0073 in N. J. Wiesel invites readers' questions.

# From Conception to Realization— We Have Your Circuit Design In Mind

Let MicroSim Corporation help you achieve your circuit engineering goals with our family of CAE packages— Genesis, Circuit Analysis, and Circuit Synthesis.

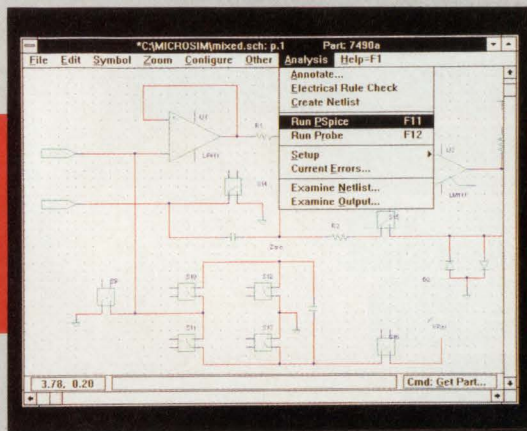

Schematics as a  
Windows 3.0 application

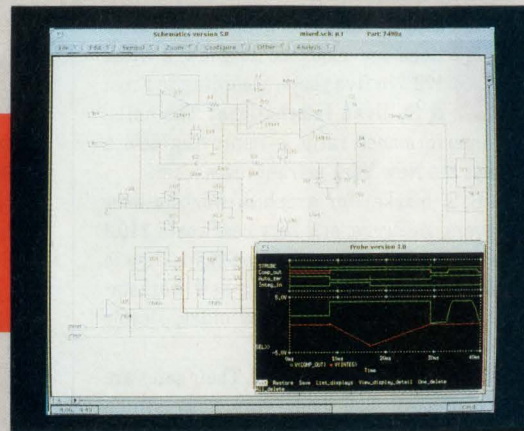

Schematics as an  
OpenWindows application

## Integrated Schematic Capture, Circuit Simulation, and Analysis

Our new Genesis package includes **Schematics**, a versatile schematic capture front-end to our popular Circuit Analysis programs, **PSpice** and **Probe**. Circuit definition is simple and flexible with Schematics' graphical circuit and symbol editors. Netlists for PSpice are generated automatically from the schematic drawing. Iterative adjustment of PSpice analysis parameters and invocation of PSpice simulations is convenient and direct through Schematics' pull-down menus and dialog boxes. Visual inspection of simulation results is just as straightforward since Probe is run directly from Schematics.

## New Schematic Capture Program

Schematic drawings are easy to create and edit with **Schematics**. Features include general attribute handling, auto-incrementing of names and labels, auto-repeat with stepping, rubberbanding of wires and buses, and electrical rule-checking. Any mix of analog and digital components can be used. The Schematics library contains symbols for all parts contained in the PSpice model libraries— over 3,500 analog and 1,500 digital components. An integrated symbol editor allows new symbols to be created and new part attributes to be defined while working on a schematic drawing. Whether you are running Schematics as a "native" Windows 3.0 application on the PC or as an OpenWindows application on the Sun-4 or SPARCstation, you can count on an easy-to-use system to capture, simulate, and analyze your circuit design.

## Expanded PSpice Analyses

**PSpice** and its options form an integrated package for analog and mixed analog/digital circuit analyses. Standard simulations include DC sweep, AC sweep, noise, and transient analyses which may be performed under varying temperature conditions.

**Probe** provides interactive viewing of PSpice simulation results with high-resolution graphics including these features: Performance Analysis (new!), multiple Y axes (new!), flexible plot control, simultaneous display of analog and digital waveforms, fast Fourier transforms, and more.

In-depth examination and processing of PSpice simulation results is more powerful than ever with Probe's new Performance Analysis feature. By applying any number of user-defined goal functions (such as pulse-width or overshoot) to multiple PSpice waveforms, a circuit's behavior

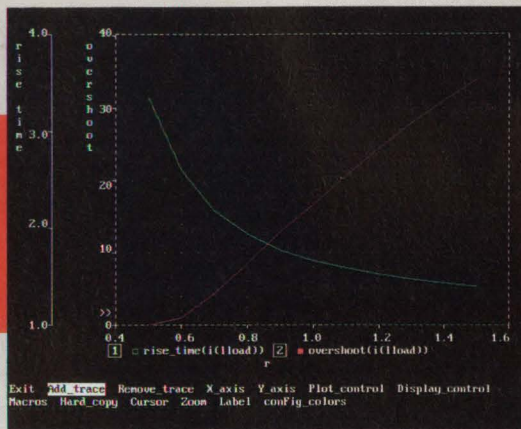

**Performance Analysis: rise time and overshoot derived from multiple waveforms with stepped resistance**

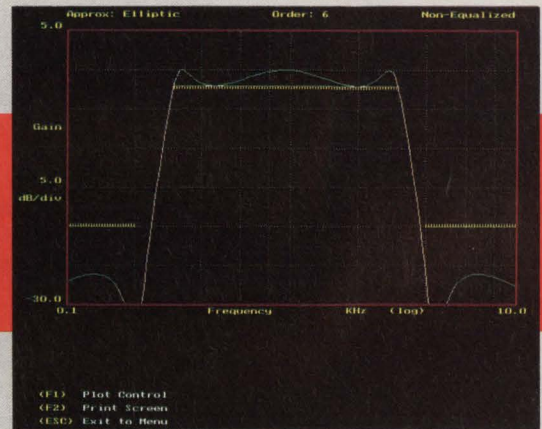

**Bode plot in Filter Designer**

can be tracked as a function of changing conditions (like temperature or model parameter values). Now it's easy to visualize trends in your circuit's performance by plotting quantities like delay versus temperature or pulse-width versus component value.

**Digital Simulation** supports mixed analog/digital circuit simulation including circuits with tightly coupled feedback between the analog and digital sections.

**Monte Carlo Analysis** performs statistical, sensitivity, and worst case analyses by accounting for component tolerances.

**Analog Behavioral Modeling** allows for the flexible definition of component models or entire circuit functions by formula or look-up tables.

**Parts** aids in the determination of model parameters from data sheet information for standard analog devices.

### Filter Synthesis Made Easy

Active RC biquad and switched capacitor filters are a breeze to design and evaluate with **Filter Designer** in our Circuit Synthesis package. Low pass, high pass, band pass, and band reject filters are synthesized using classical approximations. Advanced features include Sensitivity Analysis (new!), Delay Equalization, and Non-Standard Functions for the synthesis of filters for which there are no fixed mathematical recipes. Using results from Filter Designer, your filter circuit design can be simulated and further analyzed with PSpice and Probe.

For more information on MicroSim Corporation's family of products, call toll free at (800) 245-3022 or FAX at (714) 455-0554.



CIRCLE 158 FOR U.S. RESPONSE  
CIRCLE 159 FOR RESPONSE OUTSIDE THE U.S.

 **MicroSim Corporation**

*Expanding the Standard for Circuit Simulation*

# QUICKLOOK

## OFFERS YOU CAN'T REFUSE

**R**acal-Redac offers a demo disk of Cadstar, design software that runs on a PC. Cadstar, which has a Motif-style user interface, has interactive routines for placement, gate, and pin swapping, and routing. For a free disk, contact Racal-Redac Inc., 238 Littleton Rd., Westford, MA 01886-9984.

CIRCLE 500

**C**alculation software from MathSoft eases number-crunching. With an Windows 3.0 interface, Mathcad 3.0 handles routine calculations, such as averaging, as well as complex tasks, like fast Fourier transforms. An electronic handbook enables users to click and paste standard formulas and entire calculations into documents. Packages are tailored to electrical and mechanical engineering and advanced math.

For a free disk, contact MathSoft, 201 Broadway, Cambridge, MA 02139.

CIRCLE 501

**M**atrix<sub>x</sub> software from Integrated Systems Inc. handles engineering analysis, 2- and 3-D graphics, and nonlinear block diagram modeling and simulation. The software now supports extended memory now and has a PC Robust Control module. For a free demo disk, contact Integrated Systems Inc., 3260 Jay St., Santa Clara, CA 95054; (408) 980-1500; fax (408) 980-0400.

CIRCLE 502

**A** 120-page reference guide to PC bus data acquisition and control is free from Advantech. Among the problems and solutions addressed are signal conditioning, RS232,422,485 interfacing, 286,386,486 CPU cards, along with a-d and d-a conversion.

For a free copy, contact Advantech, 1310 Tully Rd., Suite 115, San Jose, CA 95122; (408) 293-6786; fax (408) 293-4697.

CIRCLE 503

**M**irostar Laboratories offers a free demo disk of the DAP 800, a data-acquisition system on a card. It has analog and digital input and output, and a 16-bit microprocessor for control and computation.

For a free disk, contact Mirostar Laboratories, 2265 116th Ave. NE, Bellevue, WA 98004; (206) 453-2345; fax (206) 453-3199.

CIRCLE 504

## DID YOU KNOW?

... that Taiwan is the third largest PC supplier in the world market. Annual exports grew 93.6% in 1987, 51.6% in 1988, 7.8% in 1989, and 7.6% in 1990, when Taiwan exported \$1.3 billion worth of PC products to the U. S.

*China External Trade Development Council*

... that EEs working in communications earn a median salary of \$62,000 a year while engineers in automotive areas make about \$51,000. In comparison, aerospace (non-defense) engineers earn about \$60,000; median salaries for engineers doing electrical/electronic manufacturing also are about \$60,000. Salaries for defense engineers (non-aerospace) come in at about \$58,000. Computers paid off in terms of pay increases, with engineers earning in that area earning a median increase of 14% from 1989 salaries.

*IEEE 1991 Salary Survey*

## K M E T S K O R N E R

### ...Perspectives on Time-to-Market

**BY RON KMETOVICZ**

President, Time to Market Associates Inc.  
Cupertino, Calif.; (408) 446-4458; fax (408) 253-6085



**E**ach manager and team member should create a number of simple reports. These reports, which complement their tools and the quality and quantity of information they can produce, further leverage their efforts. The project can be managed from the information detailed within the reports that follow:

**Individual to-do lists.** Each team member receives an individualized report that lists all their activities ordered by scheduled completion date. For each task on the to-do list, its scheduled start and finish dates are listed. Fields for actual start and finish dates are provided. Using the list becomes a simple matter of recording when work on each task has started and when it has completed. The individual does not have to provide any other data. As such, completing the to-do list may take a few minutes a week. By proper arrangement of the columns on the sheet, a graphical indication of progress to plan builds with the passage of time.

For the individual, the to-do list provides a view of what has been accomplished and what remains to be done. It becomes the communication vehicle between the person doing the work and the management team. When changes to plans have to be made, this list serves as the means by which the change is input to the computer system. As the system processes the modified data, an updated to-do list is generated. Manager and contributor discuss changes and alternatives and work to reach agreement on the revision. Agreed to revisions are accepted only after determination of their impact on the entire program. As such, no local decisions are made in a vacuum.

**Scheduled completion report.** This report sorts all activities by scheduled completion date, providing visibility of upcoming activities. It is used primarily by the program manager and managers working on functional aspects of the product's realization. Managers at the second level of the hierarchical tree use the report to determine if task completion is on target and in the determination of where problems exist.

Additionally, this management team uses the report to gain an understanding of what tasks need to be completed within the next week, month, and quarter. The report becomes their view into the project's future.

**Schedule exception report.** Of the two parts to the report, the first lists activities that are scheduled to start but have not begun, while the second part lists activities that are scheduled to be completed but are not finished. Team members responsible for each of these activities are listed too. The report guides the management team to potential problem areas.

After working with these reports, you're likely to stop the production of PERT and Gantt charts. Circulation of the new reports can be done electronically and their space requirements are minimal.

# Since other 12-bit ADCs need four times the space to go half as fast at twice the price, we use the term 'competition' lightly.



Maybe we are being a little boastful when we say that compared

to the AD671, every

other 12-bit monolithic A/D converter is a lightweight. But see if you don't agree.

The AD671 comes in a 24-pin skinny DIP package. (Other A/D converters are in double- and triple-wide DIPs, taking up to four times as much space on your board.)

The AD671 has a true conversion time of 500 ns. (Making it twice as fast as the nearest 'competitor'.)

The AD671 costs only \$65. (You can expect to pay at least double that amount for any other 'comparable' ADC.)

And the AD671 doesn't have calibration cycles, complicated interfaces, or specs that can't hold up over temperature and power supply variations. (But if you like these things, you can get them with other ADCs.)

To find out more about the A/D converter that has more weight behind it, get a data sheet on the AD671 by contacting Analog Devices at 1-800-262-5643. Or write to Analog Devices, P.O. Box 9106, Norwood, MA 02062-9106.

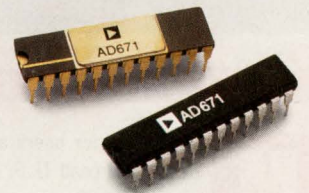

## AD671 500 ns A/D CONVERTER.

The AD671 is the fastest 12-bit monolithic A/D converter, converting in under 500 ns while consuming less than 500 mW. It accepts standard input signals of 0 to +10 V, 0 to +5 V or  $\pm 5$  V, and it outputs data in offset/straight binary or two's complement format. The AD671 offers the right combination of speed and resolution for imaging applications using charge coupled devices, infrared detectors or photomultiplier tubes, while its accuracy is ideal for multichannel data acquisition systems and communications systems.



CIRCLE 80 FOR U.S. RESPONSE  
CIRCLE 81 FOR RESPONSE OUTSIDE THE U.S.

# QUICKLOOK

## DRAM SURVEY

Which architectural memory scheme do you prefer?

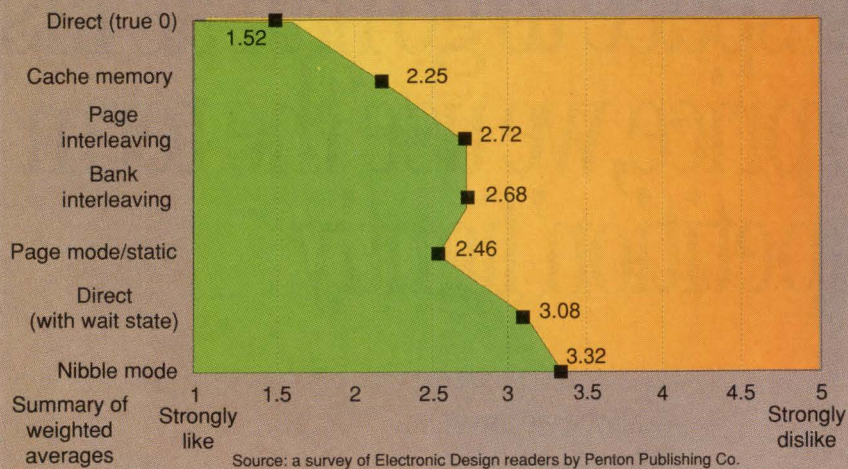

## QUICK NEWS: EDUCATION

A series of seminars will be offered by Digital Consulting Inc. in various U.S. cities through 1991. A Schussel & Yourdon CIO conference will be held Nov. 21-22 in Orlando, Fla. Ed Yourdon, a pioneer of structured design and analysis, has extended these concepts to incorporate information engineering, real-time systems design, and other paradigms.

Among the other DCI software development and CASE seminars are sessions on analyzing user requirements, application development technologies, improving software quality, prototyping and rapid application development, and software reusability.

A local area network seminar is being offered, along with sessions on CASE, X-Windows, imaging, data modeling and CASE. DCI also gives on-site seminars.

Course sites range from Boston and Toronto to San Francisco and Calgary. Fees start at \$795 and go to \$1395 for a two part seminar on improving software quality. Contact DCI at 204 Andover St., Andover, MA 01810; (508) 470-3880; fax (508) 470-0526.

CIRCLE 508

## QUICK REVIEWS

Many computer users are vaguely aware of the need for security, but few track down and read U.S. government guidelines. *Computer Security Basics* also covers complex concepts like trusted systems, encryption, and mandatory access control. At \$29.95, the 400-page book can be ordered from O'Reilly & Associates, 632 Petaluma Ave., Sebastopol, CA 95472; (800) 338-6887; (707) 829-0515.

CIRCLE 505

## HOT PC PRODUCTS

The Microref Smartpad from Educational Systems Inc. is a mouse pad with a cover that is lifted to insert templates. The templates give operating commands at a glance for popular PC software.

Templates are available for Windows 3 and WordPerfect 5.1. Templates are in the works for Excel for Windows PC 3.0, Lotus 1-2-3 Release 3.1, PageMaker PC 4.0, and Word for Windows. At 8.5 in. by 10 in., Smartpad costs \$9.95 to \$19.95 for various templates.

Contact Educational Systems, 3175 Commercial Ave., Northbrook, IL 60062; (800) 498-3780; fax (708) 333-0551.

CIRCLE 506

A tape backup system for DOS PCs and laptops works by using a computer's parallel printer port. It eliminates controller or adapter cards and special cables. The unit stores 160 Mbytes at 4.4 Mbytes per minute. The 6-lb unit can be moved from machine to machine.

The ADPI unit, which uses digital cassette tape, has a list price of \$1,555 from ADPI, P. O. Box 499, Troy, OH 45373; (513) 339-2241; fax (513) 339-0070.

CIRCLE 507

## EYECATCHER

Foreign share of the Japanese semiconductor market is expected to hit a minimum of 20% by the end of 1992. That's the goal of a new semiconductor trade agreement between the U.S. and Japanese governments. As a chart from the Semiconductor Industry Association shows, the first U.S.-Japan Semiconductor Trade Agreement was signed in mid-1986. Foreign share in the Japanese market stood at 8.6% amid plummeting prices for DRAMs and charges that Japanese companies were dumping chips. Foreign market share in Japan had reached 13.2% by the fourth quarter of 1990.

## FOREIGN SEMICONDUCTOR MARKET SHARE IN JAPAN

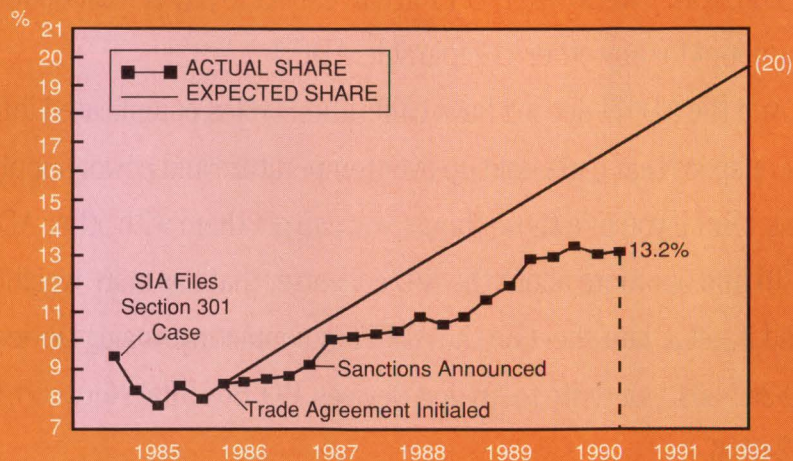

# T U R B O POWER CONVERTIBLES™

Tired of wasting board space on an expensive, space guzzling DC/DC Converter? Check-out the new HPR7XX Power Convertible. It is unbelievably small and sleek with 5 Watts of isolated output power. This is a



turbo charged SIP - only 2.22" long and .35" wide.

You get 16 Watts per cubic inches of unregulated power under the hood.

The HPR7XX is no big ticket item either. It is priced less than DC/DC Converters twice it's size and with less output power capacity - only \$20 in O.E.M. quantities. This high-performance model drives as great as it looks with an efficiency rating of 80%. Take it for a spin, you will have no trouble finding a parking spot on your board.

For the dealer near you:

Call 1-800-548-6132

Fax 1-602-741-3895

Write P.O. Box 11400 Tucson, AZ 85734

CIRCLE 234 FOR U.S. RESPONSE  
CIRCLE 235 FOR RESPONSE OUTSIDE THE U.S.

**BURR-BROWN®**



Your Partner in Quality

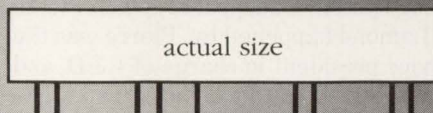

Power Convertibles is a trademark of Power Convertibles Corporation,  
an affiliate of Burr-Brown Corporation.

# WHAT'S ALL THIS WIDLAR STUFF, ANYHOW?

**W**hen we got the word that Bob Widlar had passed away on February 27 at the young age of 53 (heck, I'll be up there in a couple years, if I'm lucky....), we all began to bring out stories about things Widlar had done. There are *lots* of good Widlar stories, and many of them have been printed recently. I will just try to tell here the ones that nobody else has told.

First of all, Widlar did *not* bring in a goat to chew down the unmowed lawns at National (when the pay to the gardeners was cut back). That would be absurd. Widlar would not do that. What he brought in was a *sheep*. I can

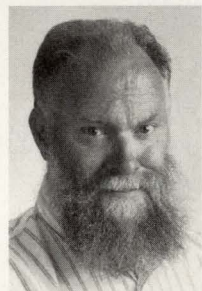

**BOB PEASE**  
OBTAINED A BSEE FROM MIT IN 1961 AND IS STAFF SCIENTIST AT NATIONAL SEMICONDUCTOR CORP., SANTA CLARA, CALIF.

prove it, because Fran Hoffart showed me a picture of the sheep. Widlar brought the sheep in the back seat of his Mercedes-Benz convertible. *That* would be nice to document with a photo, but Fran didn't get a photo of the sheep's arrival. However, Bob Dobkin told me that he drove up with Widlar and the sheep, after Widlar bought the sheep in Morgan Hill for \$60. Dobkin said that

after the sheep was tied up to a tree in front of National's headquarters, the news photographers only took 20 minutes to show up. At the end of the day, Widlar went over to a bar and took the sheep with him. He left the sheep with

the bartender.

That leads to another story, about the time Bob made the gardeners unhappy. Nobody remembers exactly what he did to make them so unhappy, but it must have been pretty good. One person said maybe that was the time Widlar could not find a good parking place, so he parked his convertible on the lawn—repeatedly. The gardeners retaliated by letting a sprinkler run into that area, and when he came out to go home, the car had several inches of water in it. Did Widlar retaliate after that? Nobody remembers, but even Widlar knew that sometimes, it's time to quit when you are over-matched.

Charlie Sporeck, (who has just retired as the president of National) told me about the first time he met Bob. He was in a hospitality suite of the IEEE in New York City back in 1966. He was reading in *Electronic News* that Raytheon had just brought out an RM709 as a second source to the Fairchild  $\mu$ A709. Bob, who was not pleased at being second sourced, came over and, uttering a generalized profanity, set fire to the newspaper. Charlie was astonished, and threw it into a metal wastebasket. Unfortunately the fire did not go out. As they tried to extinguish the fire, the smoke alarms went off and the fire department arrived. So much for first impressions...

When I first came out to National in February of 1976, I was in a good mood, and I set about my new work whistling cheerfully—until Widlar came by. Bob reminded me that my whistling was bothering people. In fact, my whistling was annoying *him*. He came by about six times that day to remind me, and each time I assured him I was *trying* to stop whistling as well as I could, but the

music (Mendelssohn's organ sonatas) was really circling around gloriously inside my head, trying to get out. He was as good-natured as he could be, and I finally broke the habit—after about a week of reminders.

There were just certain kinds of annoying sounds that he felt he didn't have to put up with, and to a large extent he was fair about that. Hacksawing large pieces of metal? Take it outside. Drilling many holes in a chassis? Wait till everybody went to lunch. Print out a huge print-out on the new line printer? Well, if Widlar could not get this noise delayed until "lunch time," Widlar would just go out to lunch with Dobkin or Mineo or both, right then. Whether it was 10 A.M. or 3 P.M., Widlar didn't need much aggravation to convince him it was "lunch time." Some days, he did indeed drink a lot of lunch. But that didn't prevent Bob from getting lots of good ideas done. It may have helped.

We still have a sign around our lab, "This is not a blacksmith shop." But there were times when Bob would discover he had wasted a day or two, just because one bad part had screwed up his circuit. He would bring this bad part—a capacitor, a pot, a transistor, an IC, or whatever—over to the vise and lay it on the anvil part. Then he would calmly, methodically beat it with a hammer until the smallest remaining part was indistinguishable from the dust on the floor. Then he would go back to work and get the right answer. He explained that it makes you feel much better if you do this, *and*, you know that bad part will never come around again and goof you up. He was right, and I recommend that you join me in doing this "Widlarizing" when a bad component fools you. You *will* feel a lot better.

One time Bob was standing up on a lab stool in the hall outside his office, taping a large firecracker to the paging system loudspeaker, when Pierre Lamond happened by. Pierre was the vice president in charge of R&D, and Bob loved to give him a hard time. Pierre asked, "What are you doing, Bob?" Bob replied, "I am going to blow out these damn speakers." Pierre used all of his Gallic aplomb and replied,



# BEND THE LIGHT, NOT THE LEADS.

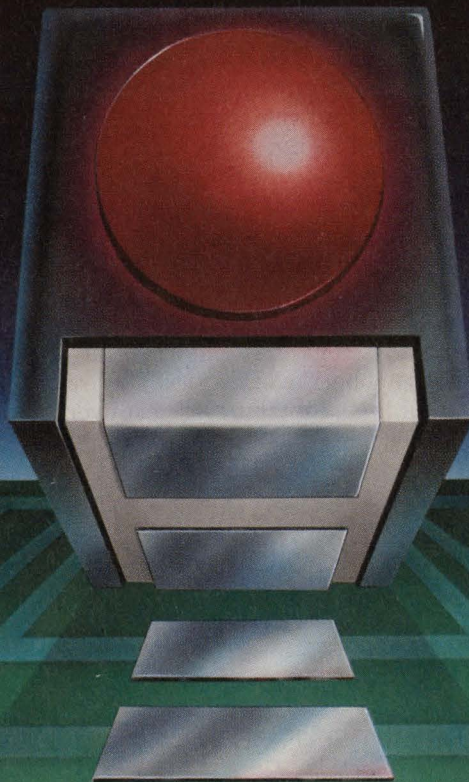

## INTRODUCING PRISM CBI<sup>SM</sup> THE FIRST TRUE SURFACE MOUNTABLE LED INDICATOR.

The new surface mount CBI from Dialight is another breakthrough idea whose time has come. Instead of bending the leads on a through-hole version to make it look like a surface mount device, Dialight uses a patented high transmission prism and clear lens to bend the light from an upwards-facing surface mount LED. This approach offers a uniform illumination of the lens over a wide viewing angle. Finally, a truly leadless indicator developed for reflow-soldering and compatible with a wide variety of pick and place equipment.

The PRISM CBI is available in T-3/4 (1mm), T-1 (3mm) and T-1 3/4 (5mm) lens sizes. This unique product is offered in package sizes of 0.130 x 0.098 x 0.138 for the T-3/4, 0.240 x 0.185 x 0.200 for the T-1 and 0.250 x 0.245 x 0.282 for the T-1 3/4 size.

The introduction of the PRISM CBI means there is one less component on the board that has to be through-hole mounted because now a reliable surface mount version exists. Using this approach, an extremely high "post-process" reliability rate can be achieved.

Available in red, yellow or green, packaged in ESD-shielded tape on EIA standard 7" or 13" reels, the PRISM CBI is ready for a whole spectrum of demanding SMD applications.

For more information, contact:  
Dialight Corp., 1913 Atlantic Ave.,  
Manasquan, NJ 08736; Tel.: (908) 223-9400  
Fax: (908) 223-8788.

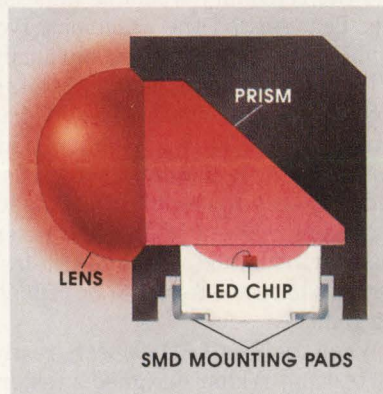

ALL INDICATIONS ARE  
**DIALIGHT**

CIRCLE 86 FOR U.S. RESPONSE  
CIRCLE 87 FOR RESPONSE OUTSIDE THE U.S.

## PEASE PORRIDGE

"Oh," and turned and walked back out the door. Widlar lit off the fuse and hopped down. Then an M-84's blast ripped the cone out of the speaker. Bob had to repeat the blast to get the paging system to stop making noises in his lab. And poor Pierre must have been under great stress to realize Bob was setting such a bad example, but Pierre could not let on that it was bothering him.

So, Widlar was not averse to fighting noise with noise. One of the celebrated things Widlar did was to put a "hassler" in his office. When a person came in to his office and spoke loudly, this circuit would detect the audio, convert the audio to a very high audio frequency, and play back this converted sound. The louder you talked, the lower the pitch would come down into the audio spectrum, and the louder it would play. So if you really hollered, it would make sort of a ringing in your ears. Of course, if you noticed this "ringing" in your ears, and stopped for a while to listen, the "hassler" circuit would shut up. He gradually got people to stop yelling at him. I mean, Bob really was almost always a soft-spoken person. He didn't have to yell or shout to get his message across. When he did speak, and softly at that, people would soon realize that it was a good idea to listen to him.

One night Bob left the "hassler" on. The next morning, his secretary tried to do some typing, and every time she hit a key, the "hassler" would chirp. It drove her nuts until Widlar came in and turned it off.

One thing that would have made Bob gripe was to see "consultant" in his obituaries. Bob never failed to point out that he was NOT a consultant. Consultants get paid for showing up. Bob was a contractor, and contractors get paid for making things that *work*. Bob *did* get paid because his circuits *did* work. Of course, sometimes it took several masksets, and several years, because Bob was doing tasks that weren't easy.

Let me correct another error in the obituaries. The first story we heard was that Bob died while jogging on the beach, a story that got into all of the papers. Actually, he had been running up on a high ridge, and was apparently descending a steep trail down from this

ridge when the heart attack hit him, and he fell in a dive and died. Not just an easy jog along the beach. Bob was, in recent years, pretty much into fitness, and he worked hard at his running. Recently, he had apparently cut down a lot on his drinking, too. Maybe the alcohol had chased away the coronaries, and the lack of alcohol contributed to the heart attack? I'm no doctor. But he did not die drunk, which may have amazed a number of his colleagues.

One time Bob was out drinking beer with his friends and he told his friend Ken Craft that he could drink a mug of beer faster than Craft could throw a mug of beer over his shoulder. At the word GO, Ken flung his beer over his shoulder in about one second flat. Widlar just stood there and smiled, and then slowly raised his mug to his lips, saying, "you win."

What technical things did Bob accomplish? Well, in addition to the op amps and the bandgap references, Bob also brought out the industry's first high-power voltage regulator, the LM109. A couple of people reminded me that in the fall of 1967, there had been a big controversy about whether it would be possible for anybody to build a high-power regulator on one monolithic chip. There were little letters to the editor in several magazines, pro and con. Finally, Widlar settled the argument by writing an authoritative-sounding letter. It pointed out that the thermal gradients on a chip would make it impossible to make a high-power chip with good performance, and the features would be impossible, and the reliability would be impossible. That settled the argument. Everybody shut up, because obviously Widlar knew what he was talking about. Then two months later, Widlar introduced the 20-W LM109, and it included all those features that Widlar had said were impossible. All of the IC engineers realized Widlar had taken them for a ride, and that he had the last laugh. What a master of the art of playing games!

When the first LM109s were ready for testing, Widlar designed a tester, and Ken Craft built it up. Widlar came over to try it out. He griped, "It works OK, but the START pushbutton is on

the left side, and it ought to be on the right side." The next day, Widlar came by the box and there was a big arrow, "PUSH to test," pointing at a blank area on the right side of the top of the box. Widlar, being a curious sort, decided to PUSH where it was indicated. Immediately the test sequence began and cycled through, with a green light going on. What the heck?? There was no pushbutton there, *but* every time Widlar pushed that spot on the panel, the test sequence occurred. Ken had cut away the copper foil at that place and installed a sensitive light-detector under the epoxy pc-board material. When you put your finger on that spot and blocked off the light, it would trigger the tester as a conventional pushbutton would do. Widlar was pleased that his guys would come up with a sneaky, ingenious scheme like that.

What other technical things did Widlar do? Even to the end of his career, Bob eschewed Spice and similar computer simulations. He preferred to use breadboards, all sorts of breadboards, and also "the Mexican computer." Namely, he used Teledeltos paper to make resistive analogues and simulate the two-dimensional flow of current. How many of you guys have used it? I recall we used it in school, 32 years ago, and I still use it every other year. You sketch the shape of your resistive pattern onto this resistive paper, at about 400  $\Omega$  per square (give or take 4 or 5 dB). You cut out the outlines, and paint on silver conductive paint at the border where current comes and goes. Then, after the paint dries, you shove in some currents and read the voltages and see if the ratios seem right. If not, it's cut-and-paste time again. Bob used this technique a lot to get some measure of how currents would flow. I don't think he ever actually *did* any of this work in Mexico, but I guess he could have if he had to. He never did any breadboarding or measuring down in Mexico; he would write in his notebooks and decide what circuits to try, and then come up to Santa Clara and try them. He kept very neat notebooks, and he also wrote neat script when it came to writing technical papers—some day I intend to show that George Philbrick's penmanship and Widlar's

# THE BRAINS OF YOUR OPERATION DESERVE THE BEST HARD HAT YOU CAN FIND.



Like it or not, your plant is dependent on its electronics. If they go down, so does your operation.

That's why you need a Hoffman. A Hoffman enclosure can protect your electronics from all the harsh abuse a



plant floor can dish out. The heat, the dust and the dirt.

For outstanding protection and easy access to your controls, specify our DesignLine enclosure with the new Swing-Out Rack Mounting Frame.

For the name of your local distributor and a free brochure, write Hoffman Engineering, 900 Ehlen Drive, Anoka, MN 55303-7504, or call 612-422-2177, or FAX 612-422-2179.

**Hoffman**<sup>®</sup>

A Pentair Company

CIRCLE 114 FOR U.S. RESPONSE  
CIRCLE 115 FOR RESPONSE OUTSIDE THE U.S.

## PEASE PORRIDGE

Now up to  
100V DC Output

# PICO DC-DC Converters

Wide Input Range  
5 to 72V DC



Regulated 5 to 30 Watts

- 365 Standard Models
- Single, Dual & Triple Output
- Remote Disable Pin Standard
- Up to 100V DC Output now Standard
- 500V DC Isolated Input to Output
- All Units Shielded

### MIL-STD-883 UPGRADES AVAILABLE

- Expanded operating temp. (-55°C to +85°C)
- No Heat Sink Required
- Stabilization Bake (125°C ambient)
- Temperature Cycle (-55°C to +125°C)
- Hi temp., full power burn in (100% power, 125°C case temp.)

PICO also manufactures over 850 standard DC-DC converters and over 2500 ultra-miniature transformers, inductors and new AC-DC power supplies.

Delivery—  
stock to  
one week

See EEM or  
FAX 914-699-5565  
or send direct for  
FREE PICO Catalog

# PICO Electronics, Inc.

453 N. MacQuesten Pkwy. Mt. Vernon, N.Y. 10552

Call Toll Free 800-431-1064  
IN NEW YORK CALL 914-699-5514

CIRCLE 172 FOR U.S. RESPONSE

CIRCLE 173 FOR RESPONSE OUTSIDE THE U.S.

were uncannily similar.

Of course, the stories about Widlar in a light mood were almost as bizarre as they were true. He would sometimes go to the airport, walk up to a ticket counter, and ask the clerk, "What time does your next plane leave?" The clerk would mention the time and the destination. "Our next departure is at 5:20 P.M., flight 772 to Vancouver." Then Widlar would haul out his wallet and peel off some bills and buy a round-trip ticket to this random place from the astonished clerk. In a few days, Widlar would return from his surprise vacation.

Sometimes, Widlar took one of his secretaries and picked her up by the ankles and lowered her head into a fountain. She seemed to like it. (Jim Dunkley told me this. He said her name was Nancy....)

I gave a paper at a conference in March of 1970 in Paris. Widlar also gave a paper. I recall that at the end of lunch, Widlar made sure that he got a full bottle of wine to bring back with him into the conference hall, in addition to the wine he had enjoyed with his lunch. When it was time for Bob to give his talk, he had knocked the level of the wine bottle down quite low. He always said he didn't find it easy to give a big lecture, unless he had some tranquilizer in his stomach. At this conference, Bob was well tranquilized, and he was giving a good lecture about his new circuits. But the translator (English into French) was having difficulty keeping up with all of the obscure technical phrases that Widlar was tossing off so easily and rapidly. A couple times, the translator begged somebody to get Widlar to slow down. But nobody could slow him down. Finally, the translator gave an anguished cry of distress and walked out. Bob just kept on explaining his circuits, without slowing down or speeding up. Afterwards, when conference chairman Jerry Eimbinder told Widlar he would have to speak more slowly the next time, Widlar responded, "The next time I talk here, you'd better get better interpreters..."

A year ago, Jim Williams was compiling the book "Analog Circuit Design: Art, Science and Personalities".<sup>1</sup> I asked Widlar if he would like to write

a chapter or two. Bob gave a shrug of disinterest and kept on with what he was doing. I asked if he would like to just talk into a tape recorder and we could get it typed. No, not interested. I asked, well, surely there must be a story that ought to be told, shouldn't you tell it? He explained, with weary patience, that he really had no interest in telling any such stories. I knew better than to try to argue with a guy who obviously knew what he didn't want to do. Maybe I should have invented a trick—taken a tape recorder down to a bar and let the tape run? Obviously, if you can predict when you're going to lose a legend like Widlar, you would resort to a trick like that. But, we just saved all of the good stories we could...and the ones printed here are less than half of the good printable ones, not to mention all of the ones that could never be printed...

Obviously, there will never be another engineer like Widlar. He led the linear IC industry in many amazing new directions. I think every circuit designer has looked at one of Widlar's new circuits and said, "Good heavens. You can do that? If that works the way he says it does, then I could use some of these ideas to improve my circuits..." I found several places where I could correct or improve some of Bob's applications circuits, where he added resistors and capacitors around the IC. But I never found places to improve his ICs. This fall there will be a technical paper published in the IEEE Journal of Solid State Circuits, on the topic of substrate current flow in ICs. And everybody will read it and say, "But, of course he's right. Why didn't I think of that myself, first?" I'm not sure if Bob Widlar ever designed an obvious circuit in his life.

All for now. / Comments invited! /  
RAP / Robert A. Pease / Engineer

Address:  
Mail Stop C2500A  
National Semiconductor  
P.O. Box 58090  
Santa Clara, CA 95052-8090

<sup>1</sup>Published June 1991 by  
Butterworth-Heinemann, Stoneham,  
Mass.

Because you're  
thinking fast...

# Now, the price and performance you want in 15V video op amps.

Here's great news for designers of 15V systems. Comlinear now offers its technology in monolithic, 15V video op amps. And, at a very attractive price.

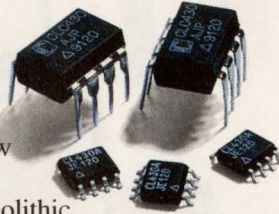

## Better video specs... lower price.

Immediately available, and priced at just \$2.54\* in 1000s, the new 55MHZ CLC430 offers a lower-cost alternative for professional video applications. What's more, it delivers differential gain/phase of 0.02%/0.04°, plus superior multiple-load performance to meet the demanding standards of composite video... reliably and consistently.

It gives designers of high-speed signal processing systems a fast 2000V/us slew rate and 35ns settling time to 0.05%. Plus a high-speed disable/enable feature, making it ideal for video switching and multiplexing applications. All in an industry-standard DIP pinout, or a space saving 8-pin SOIC package.

So take advantage of the latest in Comlinear's growing family of video products. Call today for details.

\*U.S. price only

CIRCLE 250 FOR U.S. RESPONSE

CIRCLE 251 FOR RESPONSE OUTSIDE THE U.S.

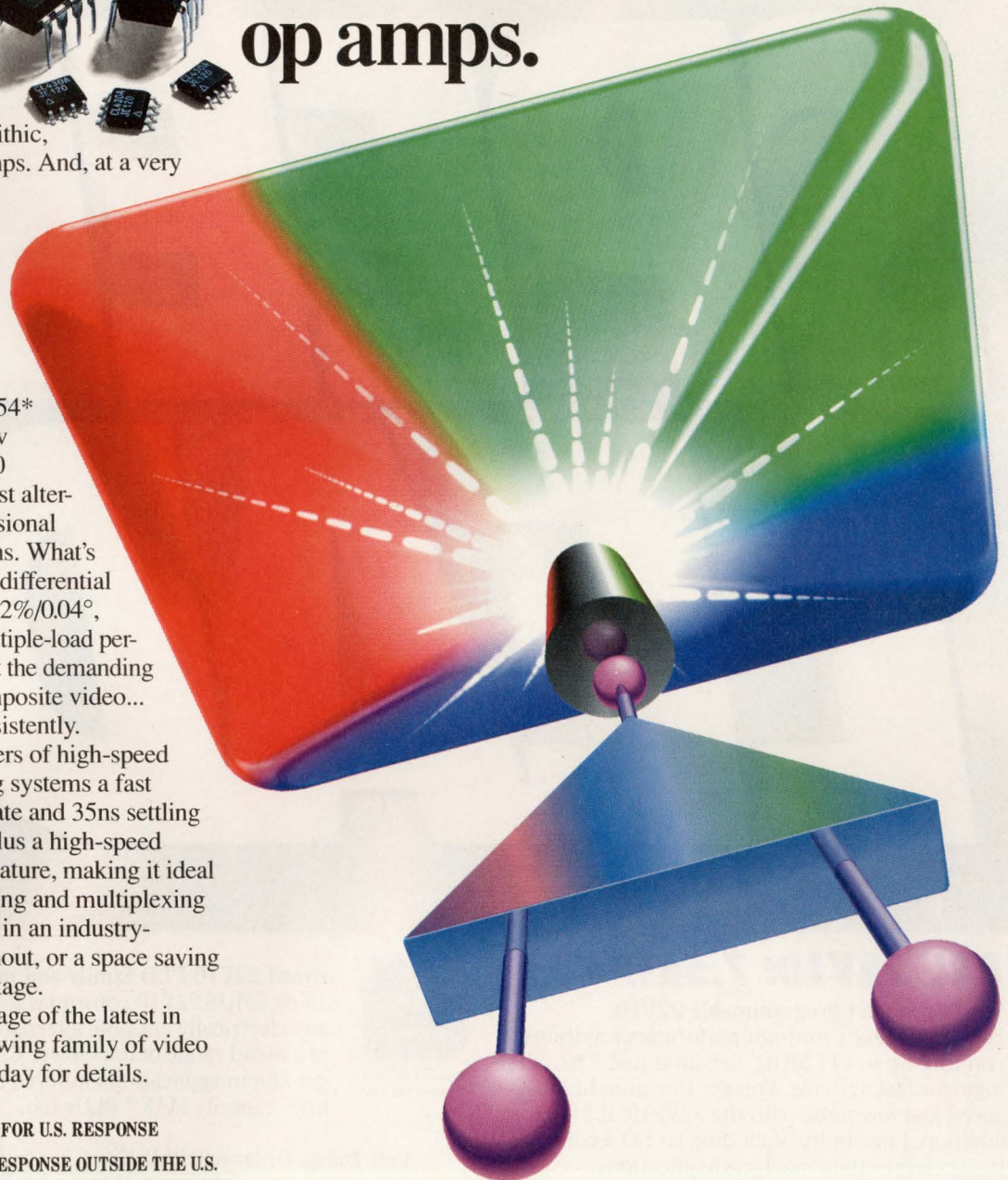

 Comlinear  
Corporation

*Solutions with speed*

4800 Wheaton Drive  
Fort Collins, CO 80525  
(303) 226-0500  
1-800-776-0500 (USA)

# TAKE THE SPEED LEAD.

## **PAL™ 22V10: 7.5ns.**

### **World's fastest programmable 22V10.**

Here is the logic for high-performance systems running up to 111 MHz. Set-up is just 3 ns. Fast logic for fast systems. You get the same high speed and low noise with the 22VP10. It offers additional flexibility, including an I/O feedback path to accelerate state machine applications.

**BiCMOS.** The first BiCMOS 22V10, from the company that delivered the first CMOS 22V10. ECL core path for record-setting performance. CMOS logic outside the speed path, for low power. The speed of smaller PLDs, the convenience of the popular, flexible 22V10 and field programmable too.



*The new 7.5 ns field programmable, PLD.*

**Broad 22V10 PLD family and more.** Cypress's 15 ns CMOS 22V10 consumes less power than any electrically erasable alternative. It's just one of a broad range of low-power CMOS PLDs. Also get 28-pin applications-tailored PLDs, and our high-capacity MAX™ PLDs too.

**Call Today.** Order our PLD Kit and we'll ship it right away. Why wait?

**Hotline: 1-800-952-6300.\***  
**Ask for Dept. C3Q.**



\*1 (800) 833-0306 in Canada. (32) 2-652-0270 in Europe. ©1991 Cypress Semiconductor, 3901 North First Street, San Jose, CA 95134. Phone: 1-(408) 943-2600, Telex: 821032 CYPRESS SNJ UD, TWX: 910-997-0753. Trademarks: PAL, Advanced Micro Devices, Inc. MAX, Altera Corporation.



**CYPRESS**  
SEMICONDUCTOR

HOUSED IN BUTTON-SHAPED METAL CANS, DIGITAL MEMORIES OFFER ELECTRONIC IDS FOR SECURITY, PARTS TRACKING, AND MORE.

# MEMORY-BASED IDENTIFIER TAG PROVIDES DIGITAL ID

DAVE BURSKY

A unique combination of the one-signal plus ground memory chip technology unveiled by Dallas Semiconductor earlier this year, and an industrial-strength stainless-steel button-type packaging scheme, gives designers a nonvolatile equivalent of a self-sticking note. The DS199X series or "Touch Memory family" contains devices that pack nonvolatile memories consisting of either ROM or ROM plus battery-backed RAM. The memories and the battery are sealed in a 16-mm-diameter steel package. The memory's contents can be read or written with just one signal line and a ground connection.

The Touch Memory shares some of the same end market with bar codes, serving as an identifier on a pc board or some other product. However, unlike a bar code, which typically contains limited information and can't be updated, the DS199X devices can be updated (with password protection if desired) with upgrade-modification data, repair data, or other types of data. The simple interface gives the devices much of their ruggedness because there are no pins or leads to get damaged. Similar to the button-battery cases, the steel shell that holds the chip has two isolated sections, one that forms the ground contact; the other, referred to as the lid, is the signal interface (Fig. 1a). The MicroCan package can withstand over 1 million mechanical operations with-

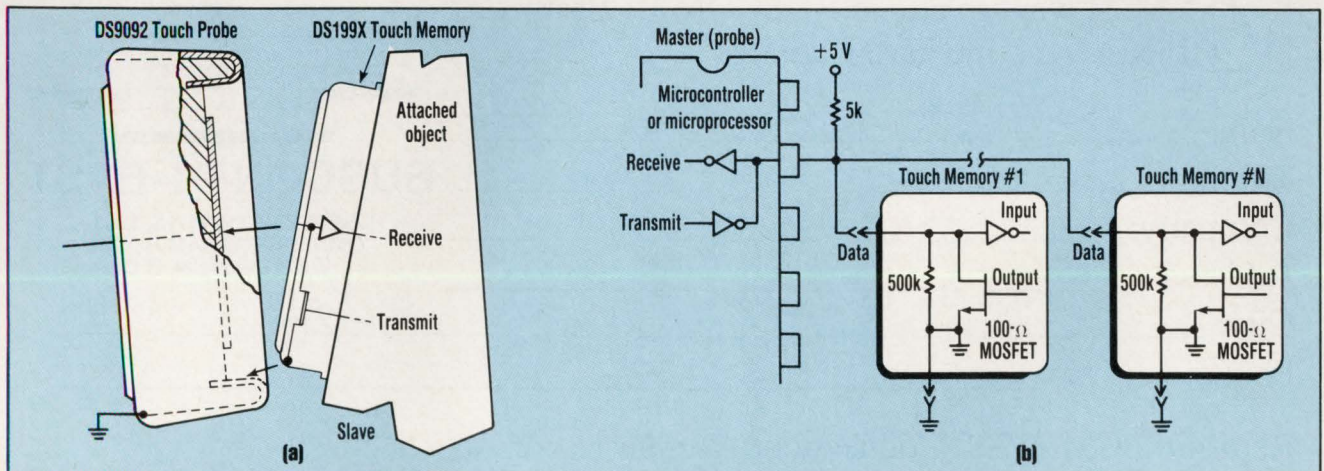

**1. A SIMPLE BUTTON-SHAPED** metal can houses the Dallas Semiconductor Touch Memory chip and a tiny lithium battery, giving the chip its nonvolatile RAM-based storage (a). A pull-up resistor on the single-wire bidirectional data-line interface makes it possible for the master (or probe) to control the state of the interface to the Touch Memory devices (b).



# Attend BUSCON '91 East - A Capitol Idea Comes To Washington, DC.

BUSCON '91 East, the nation's leading trade show and technical conference for board and systems level technology is coming to Washington, DC for the first time.

BUSCON '91 East is the one place to see, test and compare the newest products and technology from hundreds of leading vendors.

Get an inside track on technical developments you can use now at the

industry's premier seminar program. Learn what is new from the people actually developing the technology.

It's all at BUSCON '91 East, September 11-13 at the Omni Shoreham Hotel, Washington, DC.

For more information about attending BUSCON '91 East,

just complete and return the coupon below or call (800)243-3238 (in Connecticut call (203)852-0500).



© CMC, 1991 A CMC EVENT



**YES, I want to attend BUSCON '91 East.**  
Please send me all the details.

Name: \_\_\_\_\_

Title: \_\_\_\_\_

Company: \_\_\_\_\_

Address: \_\_\_\_\_

City: \_\_\_\_\_ State: \_\_\_\_\_ Zip: \_\_\_\_\_

Phone: (     ) \_\_\_\_\_

Return to: CMC, 200 Connecticut Avenue  
Norwalk, CT 06856-4990  
Or fax to: (203)857-4075



**BUSCON/91-EAST**

SEPTEMBER 11-13, 1991  
OMNI SHOREHAM HOTEL  
WASHINGTON, D.C.

BE14



# BUTTON ID TAGS

out appreciable wear and tear.

Applications for such a simple-to-use memory abound—production control in manufacturing is exploring many options with these storage devices to track products along the manufacturing line. On-the-spot information about where a product or subassembly was made, its test history, revisions, and so on, can be read from the device. This either ensures that it matches what was expected, or traces back some incorrect shipping or assembly. Other applications include facility-access control, hospital-patient ID (with medication history and warnings), and asset management. As a beta test in its own facility, Dallas put the Touch Memory MicroCans on all of its employee photo-ID badges and probe-controlled locks on doors and even on

one computer keyboard, thus instituting a security tracking system.

On-chip (in-button) data storage will range from 64 bits for simple tasks up to 4096 bits for more complex records—that's as much as 100 times the amount of data a bar code can provide. The read/write memory portion will remain nonvolatile for a minimum of 10 years. Other functions, such as a real-time clock, can also be housed in the same button-like steel case (the MicroCan). With the real-time clock, readings from or data being sent to the memory in the MicroCan can be time-stamped, for accurate storage records.

The button-battery-like case provides a sealed environment. The large surface area of the contact regions forgives many of the misaligned connections due to human in-

teraction or an automated manufacturing line. In addition, the button shape guides and wipes contacts, ensuring a reliable connection. The curved edge of the MicroCan helps guide a probe, simplifying alignment. The MicroCans can be mounted with a self-sticking adhesive, a press-fit retaining flange, or either a clip or snap pc-board mounting.

There will initially be five Touch Memory "buttons" available: the DS1990 touch serial number, the DS1991 touch multikey, the DS1992 1024-bit touch memory with a 256-bit scratchpad, and the DS1993 4-kbit memory with a 256-bit scratchpad. The touch-serial-number unit contains a unique 48-bit serial number, an 8-bit cyclic-redundancy-check (CRC) code for data integrity, and an 8-bit family identifier code. Contents can be read in less than 5 ms.

All the other chips in the family also contain an unchangeable 48-bit serial number. In addition to that number, the DS1991 contains a secure 1152-bit read/write nonvolatile memory that requires using a 64-bit password to decrypt. The memory is partitioned into three blocks of 384 bits each. Each block has its own 64-bit password and identifier field. A 512-bit scratchpad ensures data integrity for all memory writes.

Offering 1024 or 4096 bits of unsecured memory, the 1992 and 1993, respectively, serve as simple data carriers. The DS1992 has a more complex architecture. Its 1024 bits are split into four 256-bit pages. The chip also contains a 256-bit scratchpad memory to ensure data integrity during a page transfer. The S1993 is similar except that its 4096 bits are split into 16 pages of 256 bits each.

Accessing the memory's contents requires that all commands, addresses, and data be transmitted over the single, bidirectional communication line. And unlike bar codes or paper, which first require translation into computer-readable data, the electrical probe that contacts a Touch Memory MicroCan directly reads or transmits the binary information over the interface. The proprietary single-wire multiplexing scheme can be decoded with just some software and a

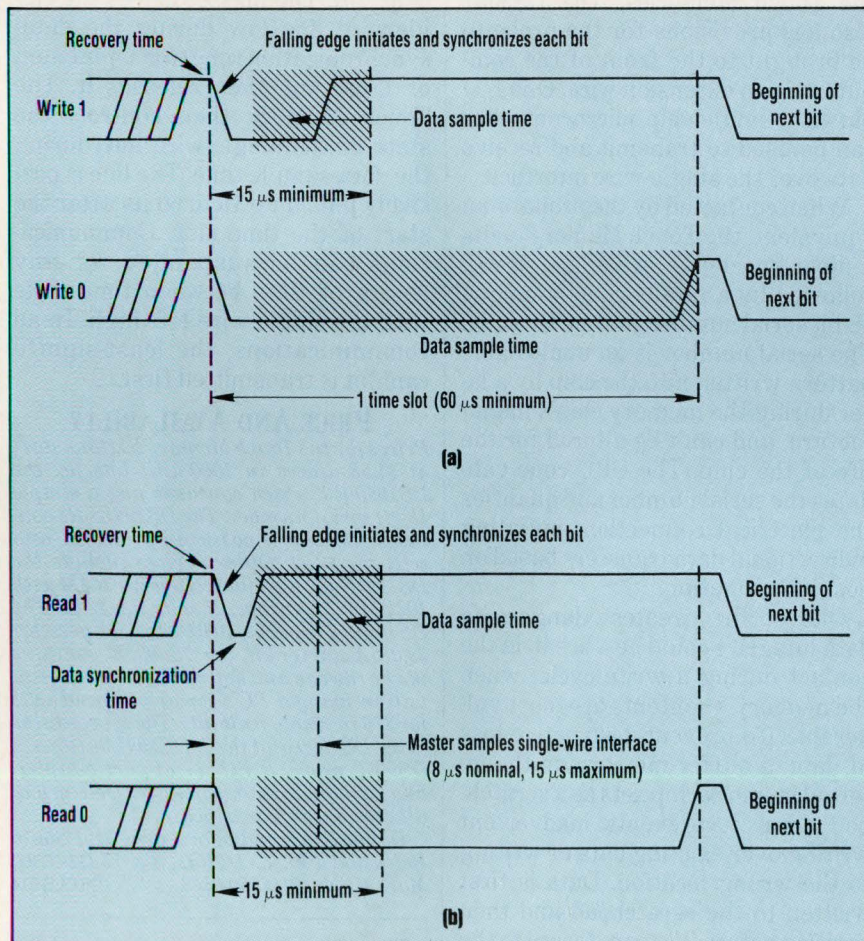

**2. A SORT OF MORSE CODE** consisting of long and short pulses is used over the single-wire interface to control the Touch Memory chip. The Write operation is initiated by the falling edge of the line as it's pulled low (a). A Read operation starts the same way, but the sample time is shortened from the 15 μs used for a Write operation to about 8 μs (b).

## BUTTON ID TAGS

**CALL  
NOW!**

TOLL FREE (800) 235-4144  
IN CALIF. (805) 544-3800

**EC<sup>2</sup> engineered components  
company**

P.O. Box 8121  
San Luis Obispo, CA 93403-8121

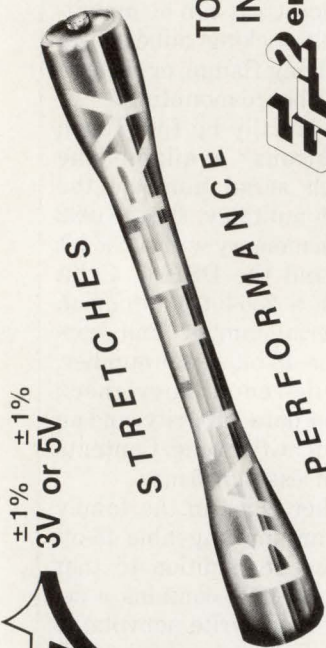

**PRECISION VOLTAGE REGULATOR MODULE**

CIRCLE 229 FOR RESPONSE OUTSIDE THE U.S.

CIRCLE 228 FOR U.S. RESPONSE

minimal amount of hardware that must either compress the address, data, and memory control signals all onto one pin, or demultiplex the signals (Fig. 1b). Error-free data is sent at 16.6 kbits/s using long and short pulses, akin to Morse code.

The probe that reads the memory can be patterned after the DS9092 Touch Probe, a mechanical assembly consisting of two stamped metal pieces separated by an insulator. The end of the probe is shaped to fit right on top of the button-shaped Micro-Can, with the probe's recessed center region serving as the data contact, and the rim as the ground contact. A special adapter, also designed by Dallas, can connect to any PC's serial port by using the DS9097 communication port adapter so that the PC can directly communicate with the Touch Memories. The DS9097 also has provisions for the probe to be brought to the front of the computer via an extension wire. One I/O pin on a single-chip microcontroller can be used to transmit and receive data over the single-wire interface.

When contacted by the probe or an equivalent, the Touch Memory emits a door-knock-like wake-up signal, followed by a family code, a unique 48-bit serial number, and a CRC code. The serial number is an unalterable pattern written into the chip by a laser during the memory chip's manufacture, and can't be altered for the life of the chip. The CRC code validates the serial number and qualifies the electrical connection, initiating bidirectional data transfers based on host interrogation.

One of the greatest dangers to data integrity could be a break in the contact during a write cycle, when the memory's contents are most vulnerable. To prevent destructive loss of data, a buffer memory on the internal memory chip acts as a scratchpad area. It prevents inadvertent writing over existing data or writing to the wrong location. Data is first written to the scratchpad and then verified before it's transferred to the main memory in the chip. Once the transfer is initiated, a copy of the scratchpad data is faithfully reproduced, even if the contact is broken.

Data is transferred on the single bidirectional line in discrete time intervals called time slots (typically about 60  $\mu$ s). Short or long active pull-down times within a time slot represent 1s or 0s. The host system initiates every bit transfer through the probe. To write a logic 1, the single-wire line must return high within the data sample window—a time period following data synchronization for a bit. To write a logic 0, the single-wire line must remain low for the entire data sample window (Fig. 2a). Synchronization of the timing is achieved on the falling edge of the time-slot signal that's driven by the host (the probe), which must hold the single-wire line low for at least 1  $\mu$ s.

For a read cycle, the ideal time for the master to sample the data is 8  $\mu$ s from the beginning of the time slot (Fig. 2b). The master drives the single-wire line low during the data-synchronization time (for a minimum of 1  $\mu$ s) and then releases it. The Touch Memory then controls the state of the single-wire line during the data-sample time. The line is passively pulled up 15 to 60  $\mu$ s after the start of the time slot. Communications can be suspended for any length of time between time slots with the single-wire left high. In all communications, the least-significant bit is transmitted first. □

### PRICE AND AVAILABILITY

Prices for the Touch Memory buttons start at \$1.58 apiece in 1000-unit lots for the DS1990-R3, which contains just a simple 48-bit serial number. The DS1991S-R3 contains 1152 bits, is password protected, and sells for \$3.71. Other devices include the DS1992S-F5, a serial read/write RAM with 1024 bits of storage. It sells for \$2.81. The DS1993S-F5 packs 4096 bits and goes for \$3.38. A starter kit, the DS9092K, contains the hardware and software for quick evaluation using a PC's serial port and sells for \$75 in single-unit lots. The kit contains three DS1990 and three DS1991 buttons, a DS9092 probe, a PC serial-port adapter, and demonstration software. Delivery of all versions is from stock.

Dallas Semiconductor Corp., 4401 South Beltwood Pkwy., Dallas, TX 75244-3292; Mark Glick, (214) 450-0448. CIRCLE 514

### HOW VALUABLE?

HOW VALUABLE?	CIRCLE
HIGHLY	559
MODERATELY	560
SLIGHTLY	561

# The Ideal Cure

## FOR YOUR HIGH-SPEED SYSTEM NOISE HEADACHES

### FCT 2000 Logic Series With On-Chip Resistors

#### FCT 2000 Logic Series with Built-in Resistors Solves System Noise Headaches & Saves Space at the Same Time.

The perfect high-speed FCT logic family is now available from Quality Semiconductor. Our on-chip resistors, which guarantee clean signals, coupled with our QCMOS™ process give you the fastest speeds. You'll also eliminate ground bounce, reflection, crosstalk, and other system noise. And by removing external resistors you save scarce board area.

#### Quality Semiconductor is Your Full-line FCT Supplier.

Quality's FCT 2000 series comes in FCT/A/B/C speeds and in all standard packages. And our logic in ZIP and the ultra-small QSOP saves over 70% board area compared to DIP or SOIC. In addition to the FCT 2000, we also offer a complete family of high performance FCT logic, even in D speeds. The entire line is designed with controlled output swings of 0 to 3.5V to eliminate ground bounce. So you can take advantage of the fastest speeds, consume less power and run cooler than Bi-polar or BiCMOS.

#### Cleaner, Smaller & Faster Logic.

When you need the perfect solution to your high-speed design challenges, you need the FCT 2000 logic series. With on-chip resistors we are the cleanest, with QSOP we are the smallest, and with QCMOS™ we have the fastest line available. For your copy of our high-performance CMOS Data Book call today, (408) 450-8026.

#### Quality Products

##### THE 74 FCT SERIES

2151	2251	2543	2827
2153	2257	2544	2828
2157	2258	2573	2833
2158	2273	2574	2834
2161	2299	2640	2841
2163	2373	2646	2843
2191	2374	2648	2845
2193	2377	2651	2854
2240	2533	2652	2861
2241	2534	2821	2862
2244	2540	2823	2863
2245	2541	2825	2864

##### THE 29 FCT SERIES

2052	2053	2520	2521
------	------	------	------

Available in A, B, and C speeds

#### Quality Semiconductor, Inc.



851 Martin Avenue ■ Santa Clara, CA 95050

Tel: (408) 450-8026 ■ Fax: (408) 496-0773

QCMOS and QSFC are trademarks of Quality Semiconductor Inc.

CIRCLE 242 FOR U.S. RESPONSE

CIRCLE 243 FOR RESPONSE OUTSIDE THE U.S.

# It's nice when your customers think the world of you.



Recently, the purchasing experts at several hundred of the world's largest electronics companies were asked by Dataquest, a leading international research firm, to rate semiconductor suppliers. The rating applied to the very specific and demanding areas of price, on-time delivery, quality, technical support and attention to customer service.

Of all the mid-size suppliers these people could have chosen as best in all five areas, one company consistently came out on top - Analog Devices.

We're proud of that, and of the Dataquest Globe that symbolizes being named Supplier of the Year.

But we're not resting on our laurels. We're working just as hard as ever to keep our customers happy. Because after all, they mean the world to us.



Analog Devices, Inc., One Technology Way, P.O. Box 9106, Norwood, MA 02062-9106. Headquarters: (617) 329-4700. Offices, applications support and distribution available worldwide.

**CIRCLE 188 FOR U.S. RESPONSE**

**CIRCLE 189 FOR RESPONSE OUTSIDE THE U.S.**

# MIXED-SIGNAL LIBRARY USES BREADBOARD AND SIMULATION

A "HEAVY ON THE ANALOG," MIXED-SIGNAL STANDARD-CELL LIBRARY IN CMOS OFFERS SILICON TO BREADBOARD AND SPICE MODELS FOR SIMULATION.

FRANK GOODENOUGH

It wasn't that long ago when virtually every supplier of analog and mixed-signal arrays and standard-cell libraries wanted to put simulation tools into the hands of system designers—regardless of their expertise. Today, many of these suppliers have pulled back. However, Bob Chao and his team from Advanced Linear Devices (ALD) took a different tack. After five years, they're just now announcing a cell library and its Spice models for customers. They started out by developing a family of high-performance, standard-product analog ICs using a 3- $\mu$ m silicon-gate CMOS process technology. These CMOS ICs include op amps, comparators, 555-type timers, and bandgap voltage references. But from the start, ALD also made it clear that every standard product represented a cell in a growing library that also included standard CMOS logic, n-channel and p-channel MOS transistors, diodes, resistors, and capacitors.

From the start, you could have created a pc-board design based on ALD's standard analog ICs and standard CMOS logic, knowing that ALD could then put that design on a future chip. Alternatively, you could have breadboarded a design with the company's ICs and then simulated it. When both you and ALD were satisfied that the design worked, ALD could have integrated it for you. Presently, their development kit, containing a broad and a deep selection of their standard products, sells for just \$185 (*see the table*).

The standard parts in the kit are in contrast to the so-called "kit parts" some other analog and mixed-signal ASIC suppliers provide. Kit parts are essentially bonded-out array macros or library cells and aren't in volume production. Potential bugs that only turn up if these ICs are fabricated in volume may await your design. In addition, some "kit parts" aren't well characterized, and detailed data sheets for some are nonexistent.

ALD now has simulation software, along with its ICs, that can be put into the hands of the individual user. Assuming you have access to at least a 286-based PC (preferably a 386-based PC) and a Spice simulator (such as Microsim Corp.'s PSpice), ALD can provide you with a complete library of Spice macromodels for an additional \$49.94. It represents all of the proprietary cells (ALD's standard products) in the company's library and design kit. The models can be used with Spice for either of two purposes: to assist in the design of a low-volume or very-simple circuit for pc-board mounting (using standard parts), or to assist in the design of a chip. In either case, the user has the option of starting with a breadboard, or starting with simulation. However, at some point in time, a good designer will be moving comfortably between both. Like the breadboard, the simulator is a tool; it doesn't do the design for you.

An example of a real chip integrated by ALD conditions analog signals and performs special-purpose digital-signal processing (*see the figure*). In addition to the digital-signal processing, the chip contains six op amps, two comparators, several matched-FET pairs, and matched resistors and capacitors that also track with temperature.

The library's models take into account both ALD's enhanced CMOS pro-

# MIXED-SIGNAL ASIC CELL LIBRARY

cess and the unique characteristics of its cells (their standard products). For example, all of their op amps are designed for single-supply operation. They sport unique, low-bias-current, complementary input stages that can handle input voltages which include both supply rails combined with output stages that swing close to the rails (*see "A unique model for unique op amps," below*). Additional macromodels

represent p- and n-channel transistors, diodes, ion-implanted and polysilicon resistors, and oxide capacitors available to the chip from the process. Parasitic active devices and capacitances are included in the passive models. The recently announced micropower ALD4706 op-amp circuit represents a good example of an ALD op amp (*ELECTRONIC DESIGN, June 13, p. 135*).

Two models for each device exists

in the library. One represents its use in a breadboard with all of the extra wiring, the other represents it as integrated. Passive parts from the process aren't included in the development kit (you use off-the-shelf discrete devices). ALD's breadboard models act the way off-chip parts work, while the on-chip equivalent models account for the often very different characteristics of the silicon devices. Differences between

## A UNIQUE MODEL FOR UNIQUE OP AMPS

**A**n op-amp macromodel is the equivalent of an op amp. It consists of several devices connected together to form a subcircuit that emulates the behavior of the actual op amp. ALD's op-amp macromodels take into account the following parameters and their effects on a signal:

- Input-voltage range
- Input-bias currents
- Input clamp diodes (protection)
- Input impedance
- Differential (signal) and common-mode gain
- Open-loop gain and phase shift versus frequency
- Open-loop gain and phase shift versus load
- Output impedance
- Output voltage and current limiting
- Dc power drain
- Large-signal behavior
- Small-signal rise and fall times
- Overshoot

ALD's op amps possess several characteristics that demanded the creation of macromodels significantly different from those available in generic Spice. To begin with, they have MOSFET input stages that handle input voltages ranging from the positive to the negative supply rail. The input circuit of generic Spice op-amp models use a bipolar-transistor differential pair. The very-low-bias currents of the ALD FETs could be modeled with very-high-beta (current-gain) bipolar devices. How-

ever, for superior model accuracy, particularly for ac characteristics, ALD replaced the bipolar models with MOSFET models (*see the figure, top left*).

These op amps, like most CMOS ICs, have clamp diodes on the input-stage FET gates for protection. When a real input signal that exceeds either supply-rail voltage

Unlike the output stage of a typical bipolar op amp, which may suffer from an overhead of 1 to 3 V (the output saturates and clips the signal when it gets within 1 to 3 V of the plus rail), these MOSFET-output devices swing to within a few tens of millivolts of both supply rails. The output of the typical model is represented

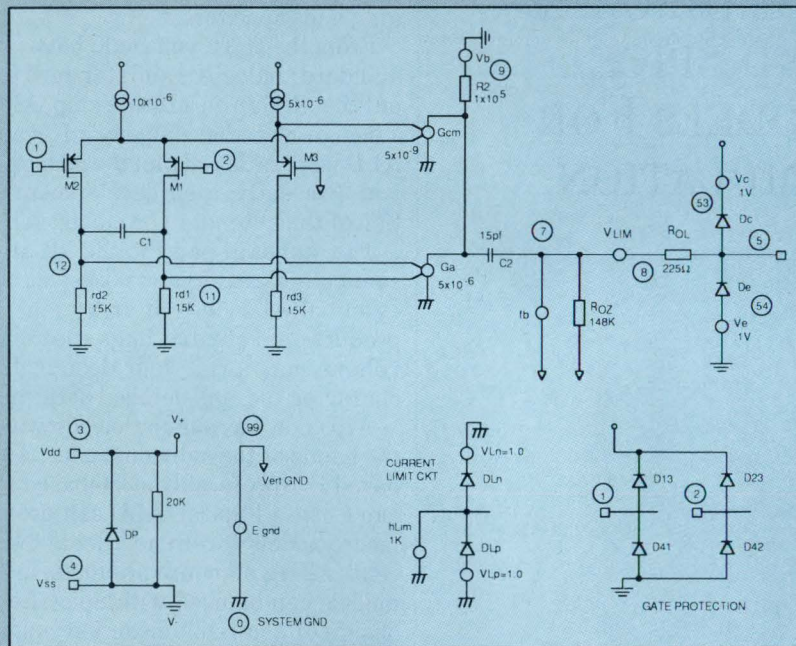

by more than a diode drop is applied to a real op amp, it's clamped to the supply rail—whether the model knew it or not. The typical generic model doesn't know about the clamp. To avoid this "simulation trap," ALD added the diode clamps to their model (*see the figure, bottom, far right*).

by a voltage source stacked over a diode. To simulate actual performance, ALD developed a special diode model that clamps at about 100 mV (*see the figure, top, far right*). This model also simulates the FETs, continually increasing roll-off in gain as the signal approaches the clamping level.

# Generate precise sinewaves with just one chip.

Now just one chip does the work of many.

Micro Linear's ML2035 and ML2036 are the industry's first integrated programmable sinewave generators. They're easily programmable from DC to 25kHz (ML2035) or 50kHz (ML2036). Each delivers better than  $\pm 0.75\text{Hz}$  frequency resolution, and  $-45\text{dB}$  harmonic distortion.

Absolute error gain over the frequency range is better than  $\pm 1\text{dB}$ . And the frequency reference of the sinewave output is derived from either an external crystal or clock input.

The ML2035 is housed in an 8-pin DIP while

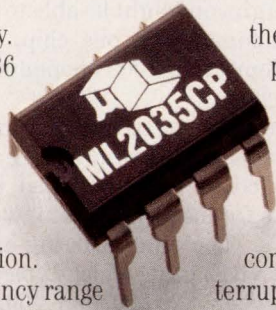

the full featured ML2036 is available in a 14-pin DIP or 16-pin SOIC.

At prices starting at \$5.95\*, the low-cost ML2035 and ML2036 are the perfect single chip solutions to efficient, precise sinewave generation.

So whether your application is in telecommunications, modems, motor control, uninterruptible power supplies, or any other, call Al Tremain at (408) 433-5200. Or write to Micro Linear, Dept. SWG, 2092 Concourse Drive, San Jose, CA 95131.

And ask for your copy of our 1991 Data Book, too.

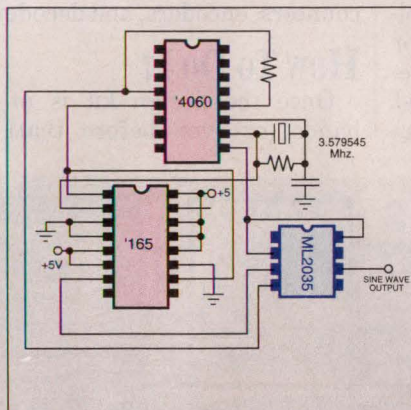

**60Hz Sinewave Output Using NTSC Color Burst Crystal**

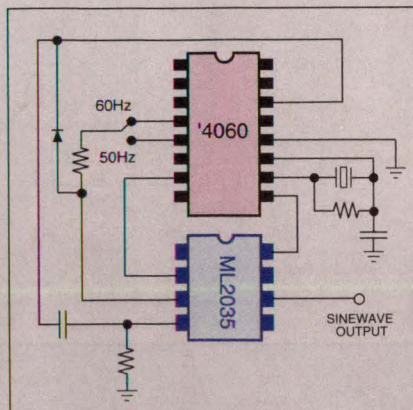

**Generating Fixed 50Hz and 60Hz Sinewaves**

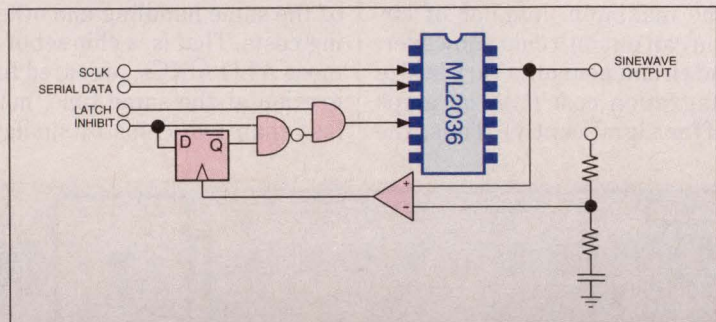

**Generating Precise Phase Controlled Sinewaves**

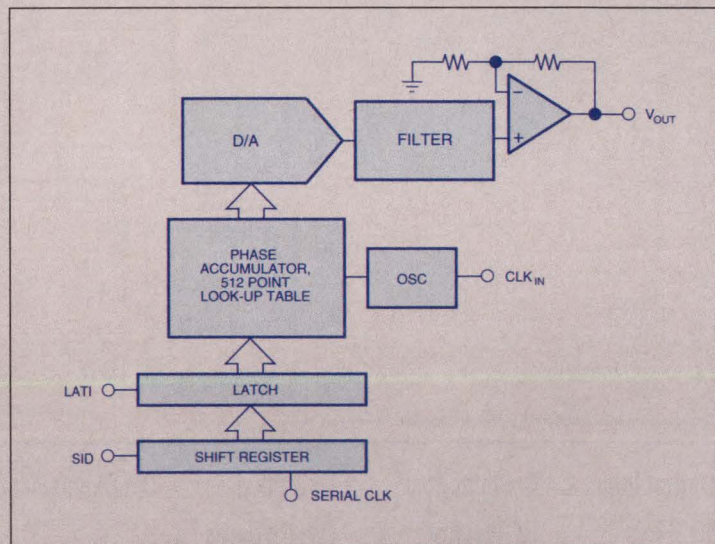

**ML2035 Block Diagram**

CIRCLE 116 FOR U.S. RESPONSE

CIRCLE 117 FOR RESPONSE OUTSIDE THE U.S.

 **Micro Linear**

\*Based on lots of 100. © 1991 Micro Linear.





## MIXED-SIGNAL ASIC CELL LIBRARY

must decide on power-supply voltage (12 V maximum), signal frequency range, noise level, output drive, and power dissipation. You must also consider packaging and the number of pins.

Although the chip's FETs are limited to handling 12 V, the polysilicon resistors can be laid down on a thick, field oxide. One end can be pinned out and connected to a higher voltage, while the on-chip end becomes the load resistor for an on-chip open-drain FET. Alternatively, the on-chip end of the resistor can be connected to a 6.2-V, on-chip Zener diode to deliver a regulated supply voltage. Two resistors and two Zener diodes provide internal  $\pm 6.2$ -V regulated supply rails.

As a typical example, assume your circuit needs 20 op amps, 20 transistors, 20 diodes, 20 resistors, 20 capacitors, and 20 digital gates. After comparing the circuit's needs with the ALD data sheets, you determine that two of the op amps will have to be separate ICs: one must offer low-noise performance, and the other must offer output power. However, you think the remaining 28 can go ALD CMOS. Next you examine the transistors and find that several 2N2222 transistors must be connected to +24 V, 12 V more than the basic chip can take, so your final design must also include discrete devices. However, models are available for the transistors, and potentially for both op amps (if models are not available, it may be possible to modify a generic op-amp model). Consequently, the models can be incorporated in both the simulation and the breadboard. On-chip CMOS transistors will handle the rest of the jobs.

Now examine passive-part requirements. Any capacitor of more than about 1000 pF in value should probably be off the chip. But the capacitor can also be simulated.

It may be possible to put all of your

resistors on the chip. You can have ion-implanted resistors whose values can range from 1 k $\Omega$  to 1 M $\Omega$  at 20% accuracy. If greater accuracy is needed, resistor pairs can be obtained that match to within 0.2%, and match over temperature to within 20 ppm/ $^{\circ}$ C. The polysilicon resistors run from 10  $\Omega$  to 10 k $\Omega$  with a 20% accuracy. Matching can be within  $\pm 0.5\%$  for selected pairs.

the breadboard could be built first to prove functionality (in other words, that you didn't forget something) or it could be built if you're more comfortable with hardware. This option is particularly useful if your circuit will be used with non-semiconductor devices, such as sensors, relays, motors or displays.

ALD suggests the following versatile approach to breadboard construction: Put all of the on-chip parts on a daughter-board that can plug into a socket on a motherboard containing all of the off-chip parts. The socket should match the pinout of the selected package, if that has been determined. When first silicon appears, it can be immediately plugged into the socket on the breadboard for verification. Any idiosyncrasies appearing at that point in the design, such as oscillation or inadequate drive due to an earlier oversight, will have an excellent chance of surfacing in the breadboard, either early on or after first silicon.  $\square$

### PRICE AND AVAILABILITY

As noted previously, NRE for integration ranges between \$20,000 and \$50,000 depending on chip complexity. Production device costs run between \$1 and \$50 each, depending on volume and complexity. Complexity not only is a function of chip size, but also of the relative amount of analog and digital functions, the number of active and passive parts, and the precision demanded of analog specifications. The last factor includes offset voltages of op amps and comparators and matching of resistors and capacitors. ALD also has the ability to trim both active and passive devices—for example the offset voltage of an op amp or the ratio of the resistors in a divider. Turnaround time from ALD's receipt of schematic to the customer's receipt of prototype typically runs 16 weeks.

Advanced Linear Devices, Inc., 1180 Miraloma Way, Sunnyvale, CA 94086-4606; Bob Chao, (408) 720-8737. **CIRCLE 513**

### EXAMPLES OF CELLS IN ADVANCED LINEAR DEVICES' LIBRARY

- Rail-to-rail MOSFET input op amp

Supply voltage = 5 V  
Offset voltage = 0.9 mV  
Open-loop gain = 94 dB  
Bias current = 20 pA  
Output voltage = 4.9 V (load = 10 k $\Omega$ )  
Unity-gain bandwidth = 2.1 MHz  
Slew rate = 5 V/ $\mu$ s  
Quiescent current = 5 mA

- CMOS comparator functionally equivalent to the 339

Supply voltage = +5 V  
Response time = 400 ns (5-mV overdrive), 120 ns (TTL input)  
Input common-mode voltage range = -0.3 V to 3.5 V  
Offset voltage = 5 mV  
Voltage gain = 30,000  
Quiescent current = 250  $\mu$ A  
Fanout = 30 LSTTL loads

- CMOS, low-voltage, 555-type timer

Supply voltage = 1 V  
Supply-voltage range = 1 to 12 V  
Quiescent current = 70  $\mu$ A  
Output-voltage low = 0.02 V  
Output-voltage high = 0.8 V  
Maximum frequency in astable mode = 0.5 MHz  
Rise/fall time = 300/100 ns

Note: all specifications are at 25 $^{\circ}$ C

As a result, the chips can form voltage dividers accurate to within 0.25%, and op-amp gain-setting resistors accurate to within 1%. Non-critical resistors, such as pull-ups, naturally go on chip, while devices more precise than 0.2% do not. If digital-circuit needs are limited to a 4-stage counter, a 4-bit latch, several NAND gates, and an exclusive OR gate, all can be integrated.

Now the circuit is captured, including both on- and off-chip components, and simulated. After successful simulation, if you're satisfied that the circuit works under various conditions, you build what ALD calls a "hardware simulator"—the breadboard—with the parts from the ALD design kit and the additional digital ICs and passive parts. Alternatively,

HOW VALUABLE?	CIRCLE
HIGHLY	553
MODERATELY	554
SLIGHTLY	555

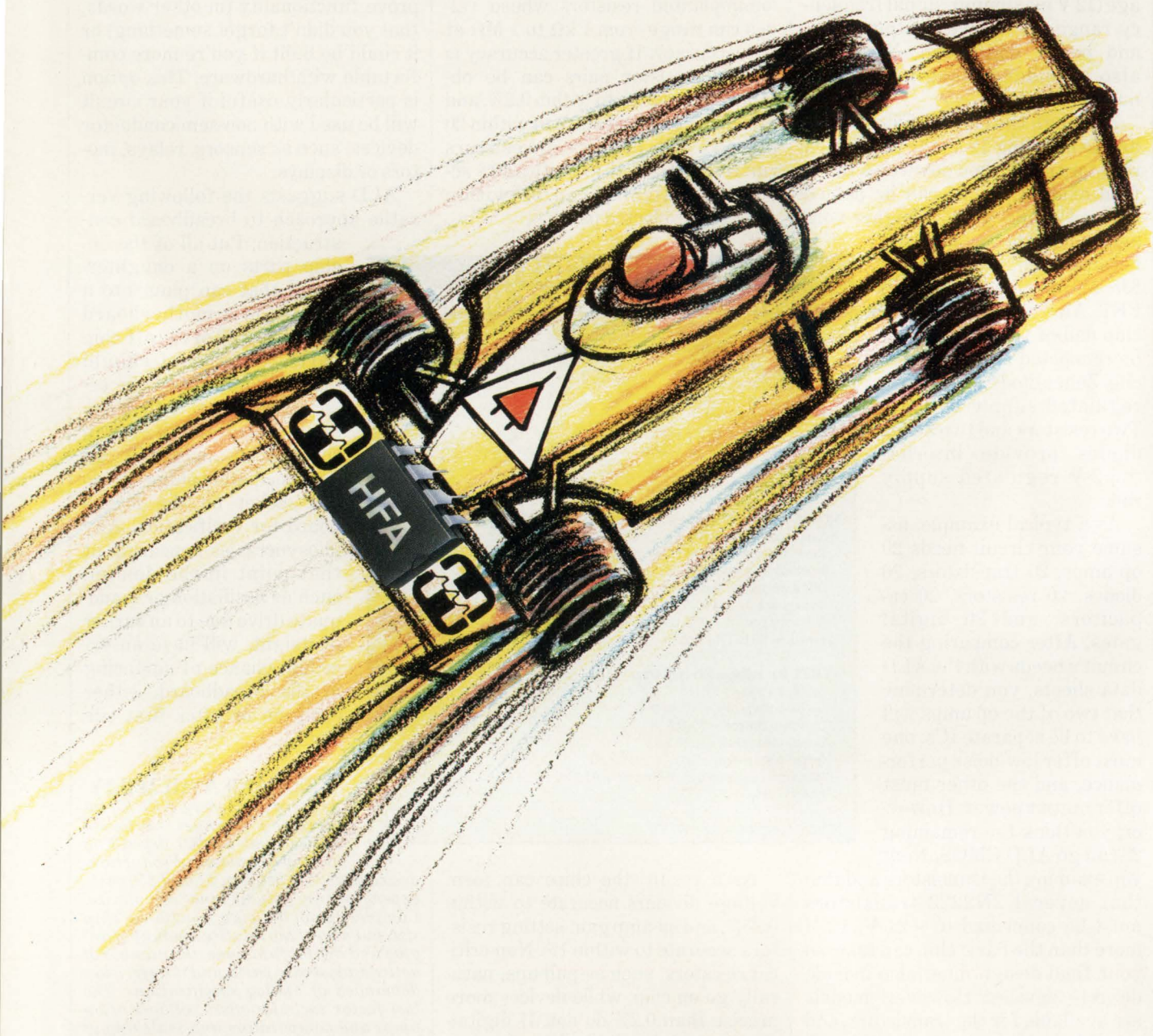

## Harris presents the world's fastest monolithic op amp.

Gentlemen, start your engines!  
The world's fastest monolithic op  
amp is coming down the track.

It's the Harris HFA family,  
with speeds significantly faster

than any other competitor.

Our HFA-0001 leads the  
race. With 350 MHz unity gain  
bandwidth, 25 nanosecond  
settling time, and a 1000 V/ $\mu$ sec  
slew rate. Other models  
are available for high  
output drive and high  
precision, too.

But whatever  
the model, Harris

monolithic designs make the  
age-old problems of hybrids go  
away. Reliability goes up. Cost  
goes down.

So find out more about the  
#1 fastest op amp from the #1  
linear supplier. Call 1-800-4-  
HARRIS, ext. 1101 today.

	Bandwidth	Slew Rate	Settling Time
HFA-0001	Unity Gain: 350 MHz	1000 V/ $\mu$ s	25 ns
HFA-0002	High Gain: 1 GHz	250 V/ $\mu$ s	50 ns
HFA-0005	Unity Gain: 300 MHz	420 V/ $\mu$ s	20 ns

 **HARRIS**  
SEMICONDUCTOR

CIRCLE 268 FOR U.S. RESPONSE

CIRCLE 269 FOR RESPONSE OUTSIDE THE U.S.

# X-TERMINALS EVOLVE TO NEXT LEVEL: NO ENCLOSURE BOX

ASIC ELIMINATES  
ENOUGH COMPONENTS  
TO ALLOW CONTROLLER  
BOARD TO FIT INSIDE  
MONITOR BOX.

**RICHARD NASS**

**X**-terminals are now on the verge of advancing to the next performance plateau. With the recent introduction of the XQC-8200 ASIC X-Window Controller from Doctor Design Inc., San Diego, Calif., X-terminal makers can significantly cut their manufacturing costs and time to market. Though the part offers some of the highest-performance benchmarks in the industry, Doctor Design's engineers wanted to plunge further.

The result was two new ASICs: the DDI-4029 and the DDI-4129. These two parts supply enough fuel that's sufficient to propel X-terminals to a previously unattainable level of performance.

The 4029 and 4129 were developed for embedded microprocessor applications that use the Am29000 microprocessor from Advanced Micro Devices, Sunnyvale, Calif. The differences between the parts are two-fold and involve resolution and clock rate.

First, the 4129 supports color resolutions up to 1280 by 1024 pixels, while the 4029 supports color resolutions up to 1024 by 1024 pixels. Second, the 4129 supports a dot/pixel clock rate up to 120 MHz, while the 4029 supports a dot/pixel clock rate up to 80 MHz. The 4129's higher clock speed is needed to maintain the higher refresh rates and resolution levels the 4129 provides.

An X-terminal controller board designed with a DDI-4029 or DDI-4129 chip can be placed directly inside the monitor housing. This eliminates the need for a separate enclosure box.

Because the two ASICs replace so many other components, the controller board becomes small enough to fit into the cavity of the monitor. Moreover, Doctor Design engineers have come up with a board-shielding process that eliminates any problems due to the excessive noise generated by the monitors.

Disposing of the enclosure and associated hardware results in a considerable cost savings. In addition, because the ASICs supplant numerous devices on the present controller board, the component and board costs drop considerably.

Doctor Design priced out the cost of a system that's based on the XQC-8200 ASIC versus the cost of a system that's based on the DDI-4029 ASIC, and came up with a savings of \$310 or 47%. The breakdown includes \$335 for component costs (including memory) versus \$513, only \$7 for the board versus \$69, and no cost for the enclosure box and power supply versus \$70. The sum result is \$342 for a DDI-4029-based system versus \$652 for an XQC-8200-based system (these prices are estimates based on large-quantity distribution pricing).

When the external peripherals, such as a monitor, a keyboard, and a mouse, are added in, as well as a standard manufacturer's price multiplier, Doctor Design sees a cost savings of about \$1000 passed on to the end user. X-terminals using the two new ASICs will most

# X-TERMINAL CONTROLLERS

likely start to appear either at the end of this year or by the beginning of 1992.

The 22,000-gate ASICs replace or reduce 78 chips on the controller board. These include all of the PAL and GAL devices; serial-port, keyboard, and memory controller chips; some static RAM; and about 90% of the glue logic that's needed for the microprocessor to work with the memory and the external interfaces. In addition, some of the boot and code ROM is reduced. A monochrome controller board using the DDI-4029 and a 16-MHz Am29005 processor needs a total of about 16 parts and some resistors, capacitors, and diodes (see the figure).

The 4029 and 4129 pass on more than just a cost savings. When coupled with a 16-MHz Am29005 processor and server code from Advanced Graphic Engineering (AGE), San Diego, Calif., a monochrome design will supply over 100,000 Xstones, and a color design will supply about 50,000 Xstones.

Both ASICs are highly configurable to support many architectural and memory options. The ASICs can be configured with either a combined instruction and data bus to minimize parts cost, or separate instruction and data buses to maximize performance. Each chip supports up to four banks of RAM, with each RAM configurable using 1, 2, or 4 Mbytes of memory. Also, single-bank video-RAM support is supplied for high-resolution monochrome or color monitors.

Network support is supplied through a direct connection to the Lance chip set for Ethernet networks from Advanced Micro Devices. The Lance chip set offers a complete interface module for an Ethernet network. It's buffered internally to allow fast DRAM accesses. All address latching, word shifting, and interfacing to the microprocessor are done internally.

The two ASIC chips supply all of the control lines needed for various peripheral devices. The devices include keyboards, a mouse, speakers, and serial ports.

The keyboard interface features

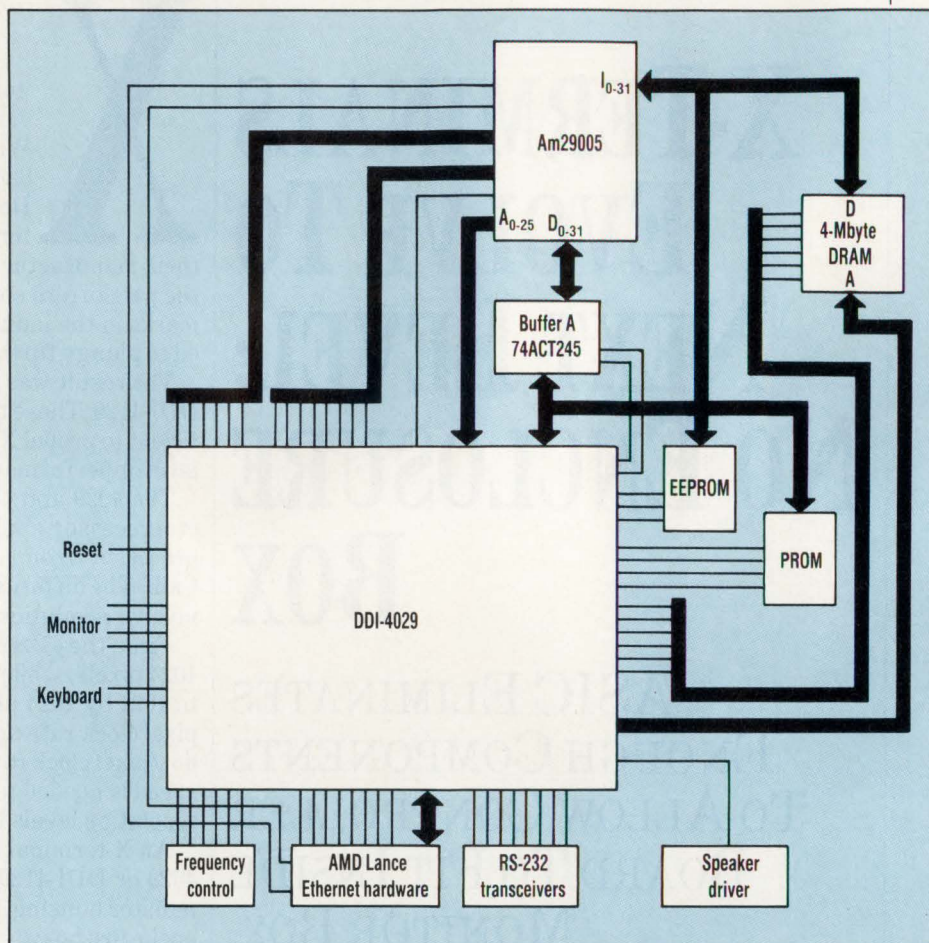

**A BASIC MONOCHROME X-TERMINAL CONTROLLER BOARD** can be built around a DDI-4029 ASIC controller chip from Doctor Design. When all of the necessary logic is included, the fully functional pc board requires just 16 chips and some resistors, capacitors, and diodes.

bidirectional clock and data-line support. A standard serial mouse can be connected using the mouse interface. Transfer rates up to 38.4 kbaud are supported through the serial ports. Also, a standard 8-Ω speaker can be connected with a minimal amount of external hardware.

The chips also allow other custom peripherals to be added. This is accomplished by using the ASICs' spare decoded Chip Enable signal that can be employed by external control logic.

Doctor Design will build and license out different configurations of X-terminals. This will make it easy for OEMs to get into the X-terminal business with state-of-the-art designs.

According to Marco Thompson,

founder and president of Doctor Design, "Our goal at Doctor Design is to become the Chips and Technologies of X. We want to be a company that vendors will come to buy an off-the-shelf solution."

## PRICE AND AVAILABILITY

Samples of the DDI-4029 and DDI-4129 are now available. They're housed in 208-pin plastic quad flat packs (PQFPs). Production is scheduled for the fourth quarter. In large quantities, the 4029 costs \$34 each and the 4129 sells for \$44 each.

Doctor Design Inc., 5415 Oberlin Dr., San Diego, CA 92121; Craig Schmidt, (619) 457-4545.

CIRCLE 512

## HOW VALUABLE?

HIGHLY  
MODERATELY  
SLIGHTLY

## CIRCLE

556  
557  
558

## RECHARGEABLE-BATTERY SYSTEM MEETS NEW ENVIRONMENTAL LAWS

DAVID MALINIAK

**M**any manufacturers of rechargeable products, from handheld tools to laptop computers, face costly redesign of their products to meet the requirements of new environmental laws. As of July 1993, any and all automatically rechargeable products sold in Connecticut and Minnesota must contain batteries that can easily be removed to facilitate proper disposal and/or recycling of their heavy-metal content. In addition to those states, five others (New York, New Jersey, Vermont, Michigan, and Rhode Island) are considering similar legislation, and others are sure to follow. To address this requirement, Gates Energy Products has introduced its IntelliLink System, a battery-to-device interface that enables manufacturers to make batteries easily removable and replaceable.

The IntelliLink System also handily addresses another concern of manufacturers that must make their rechargeable cells removable. Many consumers are heedless of the dangers of attempting to recharge throwaway alkaline cells, which can at least rupture and destroy the charging device (such as a cordless phone), and may explode in extreme cases. The key feature of the IntelliLink System is a mechanical configuration that locks throwaway cells out of the charging circuit in the device, thereby removing the risk of inadvertently recharging them.

To lock non-IntelliLink-compatible batteries out of the system's charging circuit, the charging device has two contact terminals: a center contact point and an outer contact ring. This provides two separate power paths into the device. The terminal on top of a compatible battery is in the shape of a ring.

The ring terminal on the battery mates with the outer contact ring in the device, which is connected to a charge-discharge circuit. This enables the battery to be recharged

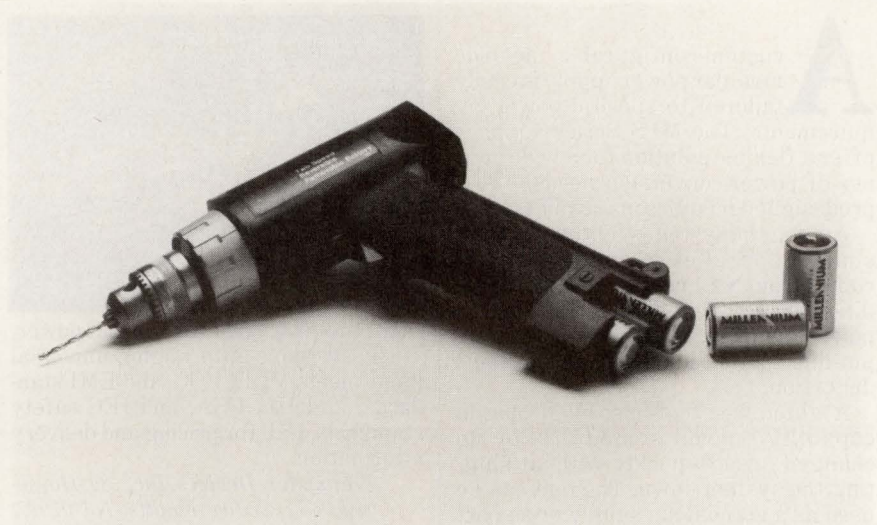

when the device is plugged into an electrical outlet. The outer contact ring also provides a path for battery power to flow into the device.

In the case of a throwaway battery, the standard flat-button terminal would mate with the center contact point in the device. The power path from the center point would bypass the charging circuit. The center point would only discharge the battery, allowing the device to operate normally. Because the outer contact ring is recessed, the throwaway cell doesn't make contact with it and can't become part of the charging circuit. In effect, the throwaway cell is physically locked out of the charging circuit.

### LOWER DESIGN COSTS

Several benefits are associated with the IntelliLink System. Besides simple compliance with the new environmental laws and keeping dangerous wastes out of landfills, the system minimizes the costs associated with product redesigns. Not only that, products that don't presently offer automatic recharging can have this feature added inexpensively without danger to consumers if throwaways are used instead of rechargeables. The use of standard-size batteries also eliminates the

costs of custom-designed battery packs. In the worst case for applications that require special high-power batteries or use a non-standard size, a one-time design expense would result in substantial savings in future design time and costs. Yet another benefit of the system is that manufacturers can offer IntelliLink-compatible products for retail sale without batteries, lowering their initial cost to consumers.

With the IntelliLink System, rechargeable products operate on standard-size batteries (AA, C, and D). Initially, all of the company's Millennium nickel cadmium batteries will be compatible with the system. The technology will be made available on other well-known brands of rechargeable batteries in the near future. Gates will also private-label IntelliLink batteries for manufacturers who wish to market the system under their own name. All Millennium batteries come with a lifetime replacement guarantee, which creates a closed-loop environmental program for rechargeable batteries. Call for pricing and delivery information.

*Gates Energy Products, U.S. Hwy. 441 North, P.O. Box 147114, Gainesville, FL 32614-7114; Kim Edwards, (904) 462-3911. CIRCLE 834*

## NEW PRODUCTS

POWER

### MODULAR POWER SUPPLIES OFFER BROAD FLEXIBILITY

A custom-configurable, ac-to-dc modular power supply is easily tailored to specific power requirements. The MPS Series supplies offer a flexible solution for a wide variety of power-conversion needs. Many predesigned modules are available.

Among the system's features is load-sharing parallel redundancy that comes from N+1 configurations. In addition, each 5.25-in.-high module offers power-factor correction for reduced input-line current and low-line harmonic distortion.

A glitch-free, hot-bus, blind plug-in capability permits modules to be changed on-site quickly without shutting the system down. The unit can be used as a standalone supply or as part of a modular power rack. Combinations of single- and multiple-output modules can be configured into a 19-in.-wide

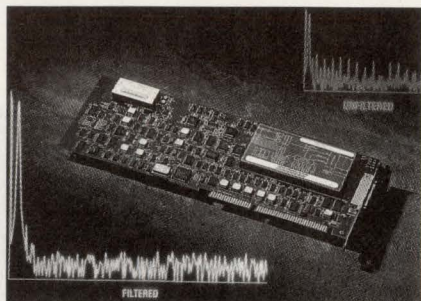

rack with up to 3000 W of output power.

The system's autoranging universal input meets VDE, FCC, and EMI standards, and UL, CSA, and IEC safety standards. Call for pricing and delivery information.

*Transistor Devices Inc., 85 Horsehill Rd., Cedar Knolls, NJ 07927; Ronald Zeman, (201) 267-1900.*

**CIRCLE 835**

■ DAVID MALINIAK

### DC-DC CONVERTERS AIMED AT LAN APPLICATIONS

A new family of dc-dc converter modules offers power conversion, voltage regulation, and isolation in Ethernet and Cheapernet local-area-network transceiver applications. These 2.25-W modules have 2500-V dc minimum input-to-output isolation and operate up to 70°C without derating.

The family comprises four modules, each providing a regulated -9-V output with a maximum output current of 250 mA. The GS-2I5-9 operates from a standard 5-V input and the GS-2I12-9 and GS-2I12-9A operate from nominal 12-V inputs. The GS-2IX-9 operates from 5-to-15-V inputs.

All four modules incorporate short-circuit protection. Input filters reduce reflected input current to low levels.

The devices are available now. Unit prices are \$10 for the GS-2I5-9, \$12 for the GS-2I12-9, \$10 for the GS-2I12-9A, and \$11 for the GS-2IX-9.

*SGS-Thomson Microelectronics, 1-20014 Agrate, Brianza, Italy; (0039) 39-6035-597. CIRCLE 836*

## THERMOMETRICS INC.

*The Source of Thermistor Expertise*

IS PLEASED TO ANNOUNCE  
THE ADDITION OF

**POSITIVE  
TEMPERATURE COEFFICIENT  
THERMISTORS  
(PTC)**

TO ITS LINE OF  
QUALITY NTC THERMISTORS

FOR FURTHER INFORMATION  
CALL, FAX OR WRITE



**THERMOMETRICS INC.**  
*The Source of Thermistor Expertise*  
808 U.S. HIGHWAY 1, EDISON, N. J. 08817  
(908) 287-2870 FAX (908) 287-8847

CIRCLE 208 FOR U.S. RESPONSE  
CIRCLE 209 FOR RESPONSE OUTSIDE THE U.S.

### CRT POWER SUPPLIES

CUSTOM DESIGNED  
MULTI OUTPUT  
SHORT CIRCUIT PROTECTED  
REVERSE POLARITY PROTECTED

MONOCHROME  
PENETRON  
SHADOW MASK  
HEAD UP DISPLAYS

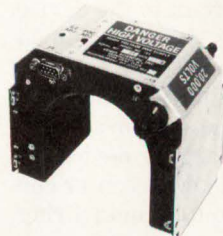

### MILITARY / COMMERCIAL / MEDICAL POWER SUPPLIES

• "Off-the-Shelf" Availability • Competitive Pricing

#### Ferranti Venus

399 SMITH STREET, FARMINGDALE, N. Y. 11735  
(516) 293-4100 • TWX: 510-224-6492 • FAX: (516) 752-7976

CIRCLE 210 FOR U.S. RESPONSE  
CIRCLE 211 FOR RESPONSE OUTSIDE THE U.S.

# 486-BASED DESKTOP PC RUNS AT 50 MHz

JON CAMPBELL

**A** new Extended Industry Standard Architecture (EISA)-based desktop PC uses the Intel 486 processor with an integrated 387-compatible numeric coprocessor to achieve a clock speed of 50 MHz. The processor chip provides on-chip memory management and an integrated cache-memory controller with eight kbytes of cache memory. Combined with advanced memory, input/output (I/O), and disk-drive capabilities, the Compaq Deskpro 486/50L provides 50% greater performance over

multiuser Unix, and accounting/transaction processing.

Compaq system engineers tested the computer with more than 500 hardware and software products—including those of its integration agreement partners, Banyan, Microsoft, Novell, and the Santa Cruz Operation (SCO)—to make certain the computer can integrate multivendor hardware and software solutions in connected environments.

Three models of the Compaq Deskpro 486/50L will be available in the third quarter: Model 120 with a



the fastest 33-MHz 486-based PCs and is the company's most powerful personal computer. A 256-kbyte second-level cache based on "write-back" technology enables the computer to have a 99% cache hit rate for microprocessor-to-memory requests.

The computer was developed primarily for design engineers who use calculation-intensive CAD/CAE applications, software developers who compile huge amounts of data, and scientists or researchers who require quick analysis. Other potential users include MIS managers and departmental network managers to run such applications as databases,

120-Mbyte hard-disk drive, Model 340 with a 340-Mbyte hard-disk drive, and Model 510 with a 510-Mbyte hard-disk drive. The 120-Mbyte drive has an average access time under 19 ms; the 340- and 510-Mbyte drives have average access times of 12 ms.

All three models have a 256-kbyte second-level write-back cache memory, eight Mbytes of 64-bit 80-ns enhanced-page internal memory (expandable to 104 Mbytes), advanced VGA graphics for 256-color support, and seven available EISA slots (all bus masters).

Software security features include power-on password, keyboard password, and network-server

mode. Hardware security features include the EISA configuration lock and diskette write control.

The Model 510 is the first Compaq product to incorporate a high-performance 510-Mbyte hard-disk drive. The new drive, with an average access time of 12 ms, is also optionally available in 1.02-Gbyte drive pairs using Intelligent Drive Array (IDA) technology. The Compaq Deskpro 486/50L may be configured to store more than 2 Gbytes internally and more than 20 Gbytes when combined with external storage—equivalent to 10 million typewritten pages.

The company also has announced the immediate availability of its own release of MS-DOS version 5. According to Compaq, its new and enhanced version of the MS-DOS operating system features a utility that quickly installs the operating system into Compaq PCs, as well as other capabilities that take advantage of Compaq product features. LicensePaq, which is designed for users who don't require documentation or a diskette, is a licensing agreement and warranty for MS-DOS version 5 as published by Compaq and is currently available.

The Model 120 is priced at \$11,299; the Model 340 at \$12,999; and the Model 510 at \$13,999. The Compaq version of MS-DOS version 5 is priced at \$99, and LicensePaq is priced at \$71. Customers of earlier releases of MS-DOS from Compaq may upgrade to the new version for \$50 and may purchase the LicensePaq upgrade for \$35.50.

The company also announced new suggested retail prices on four of its best-selling 386-based desktop PCs. The Compaq Deskpro Model 386N M0 is now \$1,499, the 386N M1 is \$1,599, and the 386N M40 is \$1,999 (unchanged). The 386s M1 is \$1,999, the 386s M40 is \$2,299, the 386s M84 is \$2,599, the 386s/20 M1 is \$2,099, the 386s/20 M60 is \$2,599, and the 386s/20 M120 is \$2,999. The 486-/33L M120 is \$8,999, the 486-/33L M320 is \$10,599, and the 486-/33L M650 is \$11,599.

Compaq Computer Corp., 20555 State Highway 249, P.O. Box 692000, Houston, TX 77269. CIRCLE 860

## NEW PRODUCTS

INSTRUMENTS

### IEEE-488



Control any IEEE-488 (HP-IB, GP-IB) device with our cards, cables, and software for the PC/AT/386, EISA, MicroChannel, and NuBus.

### CALIBRATORS COVER FULL RANGE OF DMMs

A family of programmable multifunction calibrators covers the gamut of digital-multimeter (DMM) calibration tasks. The top-of-the-line Model 4808 offers 3-ppm/yr. performance on dc voltage (DCV). The Model 4800 DCV performance is 6.5 ppm/yr., suitable for DMMs with up to 7-1/2 digits. The economical Model 4805 calibrates DMMs with up to 5-1/2 digits. All three units have a built-in 1000-V power amplifier. The 4808 and 4800 have a modular architecture so users can buy the minimum functions needed and upgrade at a later date. The Model 4808 costs \$29,995 and is configured with DCV to 200 V, ac voltage to 200 V, a current converter for dc and ac internal, and resistance. The Model 4800 costs \$21,995 and is similarly equipped, and the Model 4805 goes for \$14,845. Delivery is in 6 weeks.

*Wavetek San Diego Inc., Datron Instruments, 9045 Balboa Ave., San Diego, CA 92123; (619) 279-2200.*

**CIRCLE 838**

### PCM ANALYZER HAS DUAL FRAME MODES

The PA-10 PCM performance analyzer is a handheld instrument for field use during installation, maintenance, and servicing of 2048-kbit/s networks. It offers two modes: framed and unframed. In the framed mode, the PA-10 monitors and evaluates PCM-30, PCM-30/CRC and PCM-31 bit streams. It also allows bit and block-error ratio measurements, analysis of a pseudo-random bit sequence, simultaneous monitoring of 16 error and alarm types, PCM decoding with audio output, demultiplexing of a single time slot, and real-time display of signaling information. In the unframed mode, end-to-end

error performance can be measured and evaluated with functions like block-error ratio measurements. Also, analysis using selectable test patterns can be performed, and so can simultaneous monitoring of eight error and alarm types.

Thanks to the softkey, menu-driven interface, the battery-powered PA-10 is quick and simple to operate. Price is available on request.

*Wandel & Goltermann GmbH, P.O. Box 1262, D-7412, Eningen, Germany; (0049) 7121-861851. **CIRCLE 841***

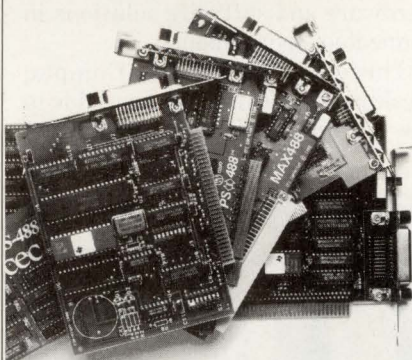

You get fast hardware and software support for all the popular languages. A software library and time saving utilities are included that make instrument control easier than ever before. Ask about our no risk guarantee.

### LOGIC/OSCILLOSCOPE USES EXTERNAL PC HOST

A lower-cost version of the Model 1600 Logic/Oscilloscope takes advantage of the user's existing PC. The Model 1620 maintains the specifications of its more-expensive sibling, but uses the keyboard, display, disk storage, and processing power of the external PC host. The instrument comes with an interface card that plugs into a full-length slot in the PC. The host must be 80286/386SX/386/486-based with an AT-type bus and 16-MHz speed, 2 Mbytes of RAM, a floppy drive, a hard drive, and EGA or VGA graphics. System software is installed on the hard disk, which can also store instrument setups and acquired data. The Model 1620 Logic/Oscilloscope costs \$14,950 with delivery within 90 days.

*Outlook Technology Inc., 200 E. Hacienda Ave., Campbell, CA 95008; (408) 374-2990. **CIRCLE 840***

### FAST DATA-ACQUISITION BOARD FITS VXI MODULE

The DBS8701 module is designed to meet the need for real-time data acquisition in the VXI environment. The module, built on a single-wide C-size board, features 16-bit digitizing at a measurement rate of 400,000 conversion/s. The 8 differential analog-input channels are multiplexed to an instrumentation amplifier, which is followed by a high-performance programmable-gain amplifier (PGA). Users can select gain dynamically on a channel-by-channel basis without degrading system accuracy. The DBS 8701's common-mode rejection ratio at 60 Hz is better than 100 dB. A 1000-word FIFO memory ensures data continuity in the event of DMA data-transfer gaps caused by processor latencies. The module features an intelligent sequence controller that permits continuous data acquisition without host intervention. The sequence controller has its own precision clock and a 2-kbyte RAM for storing channel number, scan sequence, and PGA gain information, as well as sampling rate and trigger mode selection. The DBS 8701 costs \$4800 in single quantities, with quantity prices available. Delivery is within 6 weeks after receipt of an order.

*Analogic Corp., Measurement and Control Div., 8 Centennial Dr., Peabody, MA 01960; (508) 977-3000.*

**CIRCLE 839**



Free:  
Informative  
catalog 800-234-4232  
Applications help (617) 273-1818

**cec**

**Capital Equipment Corp.  
Burlington, MA. 01803**

CIRCLE 200 FOR U.S. RESPONSE  
CIRCLE 201 FOR RESPONSE OUTSIDE THE U.S.



## NEW PRODUCTS

INSTRUMENTS

### TIMING LOGIC ANALYZER BOASTS 1-NS RESOLUTION

Specifically designed for hardware debugging, the K1000 portable timing logic analyzer features data-capture rates to 1 GHz, which translates to 1-ns resolution on single-shot timing measurements. The 16-channel analyzer has a 2-ksample data-capture memory and a channel-to-channel skew of less than 1 ns. Active probes with a 500-MHz bandwidth ensure that the unit can capture pulses as



narrow as 1 ns. The probes' 1-M $\Omega$ , 5-pF input impedance allows a 6-ft.-long probe-to-instrument cable.

With the K1000's two-level triggering, users can identify a sequence of patterns even if each pattern exists only for 1 ns. Pattern detection is performed by two independent 16-channel, 1-ns word recognizers. Each recognizer can be set to a pattern of 1, 0, or "don't care" bits, or as characters in hex, octal, and ASCII radices. Users can define and uniquely name 64 patterns. The patterns may be ORed.

Two counters and a timer enhance triggering. The delay counter positions the data captured from 2 ksamples pre-trigger to 128 ksamples post-trigger. The 64-ksample loop counter can be coupled to either or both recognizers to capture path-dependent events. Using the filter timer, operators can set the time a pattern must be present—from 1 to 127 ns—before it is valid.

An integral 286-based PC performs all user interface and display functions. To help make operation intuitive, major functions, such as run, display timing, state, setup, compare, and cursor movement, are performed with dedicated keys. A knob lets users scroll through the data-display screens. Parameter choices are highlighted and

scrolled using the Next and Previous keys. Screen-specific choices are expanded with pop-up menus and soft keys. Users enter channel and pattern names through the ASCII section of the keypad.

As an introductory offer, the K1000

costs \$9995, including an internal floppy drive, which is usually a \$395 option. Delivery is within 90 days.

**Biomation Corp.** 19050 Pruneridge Ave., Cupertino, CA 95014; (800) 538-9320. **CIRCLE 842**

■ JOHN NOVELLINO

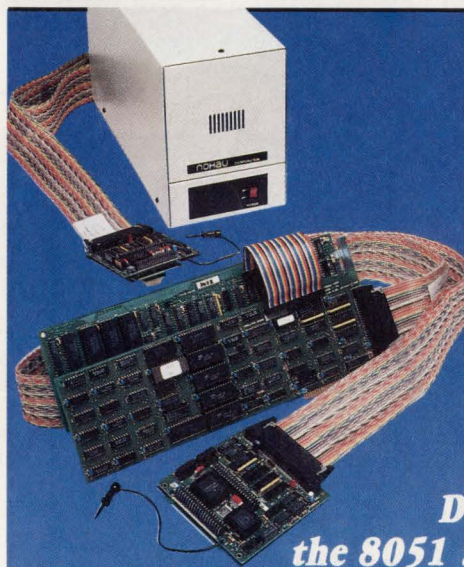

## 8051 & 68HC11

PC-Based  
In-Circuit Emulators

**Nohau**  
Covers All Your  
Development Needs for  
the 8051 and 68HC11 Families!

### Free Demo

You can start your debugging with this **FREE** demo simulator. You can load up to 512 bytes of code, assembler, C, or PL/M and do full debugging/simulation in assembly and source level. A great way to get started for **FREE**. Fantastic for schools! Just call and we'll send it!

### Full Simulator

The full-blown simulator is an extension of the DEMO. You can load up to 64K of code and use 64K of XDATA space. You can program an "external environment" to interact with your code to simulate your target system. The emulator is the hardware extension of the simulator!

### In-Circuit Emulation

The 30MHz real-time emulator has been the industry standard for years. With its complex breakpoint logic and advanced trace, nobody can beat it for performance. Plug-in or RS-232 configuration. All 8051 derivatives are supported!

**NOHAU**  
CORPORATION

51 E. Campbell Avenue, Campbell, CA 95008  
(408) 866-1820 • FAX (408) 378-7869

Call Nohau's 24-hour information center to receive info on your FAX 408-378-2912

Australia (02) 654 1873, Austria (0222) 38 76 38, Benelux +31 1858-16133, Canada (514) 689-5889, Czechoslovakia 0202-2683, Denmark (42) 65 81 11, Finland 90-452 1255, France (01)-69 41 28 01, Germany 08131-25083, Great Britain 0962-73 31 40, Greece 01-862-9901, Hungary (1) 117 6576, Israel (03) 48 48 32, Italy (011) 771 00 10, Korea (02) 784 784 1, New Zealand (09) 392-464, Portugal 01-80 9518, Norway 02-649050, Singapore (065) 284-6077, Spain (93) 217 2340, Sweden 040-9224 25, Switzerland (01) 740 41 05, Taiwan (02) 7640215, Thailand (02) 281-9596, Yugoslavia 061 621066.

**CIRCLE 178 FOR U.S. RESPONSE**  
**CIRCLE 179 FOR RESPONSE OUTSIDE THE U.S.**

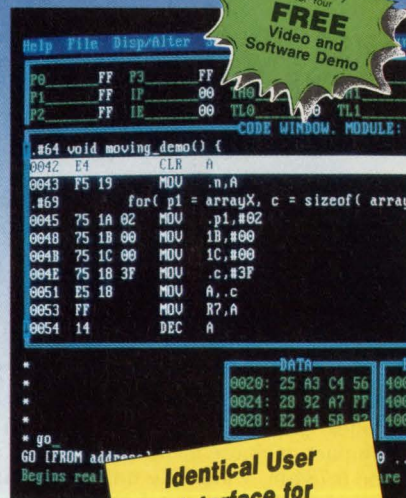

## RF MONOLITHIC AMPLIFIERS MEET COMMERCIAL, HIGH-REL NEEDS

**A**pplications in the communication, consumer, military, and instrumentation markets can be filled by ten series of silicon-bipolar Darlington RF amplifiers. Five series (20 devices) are RF monolithic amplifiers for commercial users, and five series (10 devices) are high-reliability versions for military tasks. The 50- $\Omega$  matched amplifiers are fabricated using HP's locally oxidized, ion-implanted, and self-aligned bipolar process.

The highest-gain device is the HPMA-08XX series with gain as high as 22 dB at 1 GHz. The HPMA-06XX and -07XX have operating voltages as low as 3.5 and 4 V, respectively, while the HPMA-0910, which is housed in a 100-mil hermetic stripline package, has a 3-dB bandwidth up to 6 GHz. The HPMA-99XX series provides external resistive and reactive feedback, which gives designers flexibility to build various gain blocks.

The high-reliability amplifiers offer a diverse selection of performance characteristics over a temperature range of  $-55$  to  $+125^\circ\text{C}$ . Each is avail-

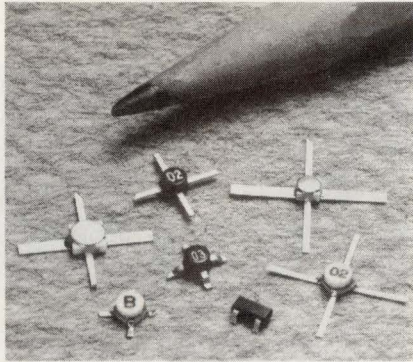

able in bare-chip form. For surface-mounted applications, they come in a metal-ceramic 70-mil stripline package screened to MIL-STD-883.

In lots of 100 to 499, pricing ranges from \$1.50 to \$8.30 each for commercial devices in an SOT-143 package. High-reliability amplifiers range from \$21.75 to \$87 each in lots of 10 to 99. Small quantities are delivered from stock.

*Hewlett-Packard Co., 19310 Pruneridge Ave., Cupertino, CA 95014; (800) 752-0900. **CIRCLE 843***

■ DAVID MALINIAK

## SMART DISPLAY STACKS BOTH WAYS

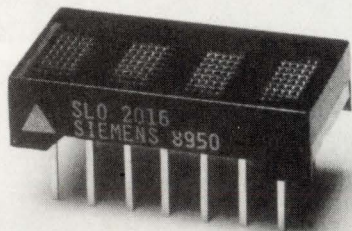

The industry's first four-character, X/Y-stackable intelligent display is the model SL(X)2016, which comes in a compact package measuring 0.4-in. tall and 0.784-in. wide. The unit's 0.186-in.-high, 5-by-7 dot-matrix LED characters couple with built-in CMOS drive circuitry to display 128 special ASCII characters. Red displays cost \$20.35 each; green, high-efficiency red, and yellow units go for \$20.90 each. Prices are for quantities of 100. Small lots are delivered from stock.

*Siemens Components Inc., Optoelectronics Div., 19000 Homestead Rd., Cupertino, CA 95014; Rick Walton Smith, (408) 725-3423. **CIRCLE 844***

## ALL-WELDED MIXERS WITHSTAND 250°C HEAT

Thanks to their all-welded internal and external construction, the TUF Ultra-Rel mixers can withstand  $250^\circ\text{C}$  for five minutes with no performance loss. Models TUF-1 and TUF-1SM span from

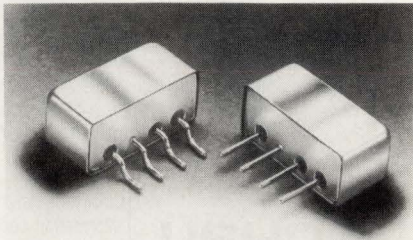

2 to 600 MHz LO-RF with 6-dB conversion loss and 42-dB L-R isolation, and cost \$3.95 each in lots of 10. Models TUF-2 and TUF-2SM span 50 to 1000 MHz with 6.6-dB conversion loss and 47-dB L-R isolation, and cost \$4.95 each in like quantities. Delivery is from stock.

*Mini-Circuits, P.O. Box 350166, Brooklyn, NY 11235-0003; (718) 934-4500. **CIRCLE 845***

## THICK-FILM RESISTORS OFFER 50-PPM TCS

A family of surface-mounted flat chip resistors features 50-ppm temperature coefficients, a breakthrough for thick-film resistors whose TC has thus far been limited to 100 ppm. The RC03G family has a tolerance of 0.5% and consists of nearly 300 type-1206 resistors rated between 100  $\Omega$  and 100 k $\Omega$ .

The flat chips are easy to mount and are available in blister tape for use in dust-free environments. Their high stability and narrow tolerance make the devices attractive in data processing, communications, and test and measuring equipment.

The 50-ppm TC ensures that the resistors maintain their 0.5% tolerance and stability over a  $-55$  to  $+125^\circ\text{C}$  temperature range. The 0.125-W devices measure 3.0 by 1.5 by 0.6 mm. Available within 6 to 8 weeks, the RC03G resistors cost below \$0.05 in medium and large quantities.

*Philips Components, P.O. Box 218, NL-5600 MD, Eindhoven, The Netherlands; (0031) 40-724324. **CIRCLE 846***

## RUBBER KEYPAD COMES AS COMPLETE UNIT

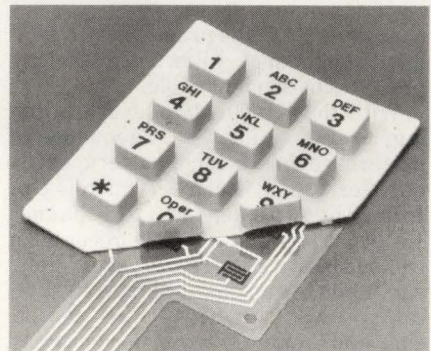

The RC+ Assemblies line of custom rubber-keypad-module assemblies consists of a rubber keypad with or without conductive contacts and a one- or three-layer flexible membrane switch with a suitable connector. Standard FR-4-type circuit boards are also available. An advanced adhesive system ensures a moisture- and dust-resistant seal. Sharp, custom keytop legends are applied with silicone-based inks that provide excellent abrasion and environmental resistance. A variety of connectors is available. Pricing and delivery depend on requirements and quantities.

*Shin-Etsu Polymer America, 34135 7th St., Union City, CA 94587; Bill Hanebuth, (415) 475-9000. **CIRCLE 847***

## LOGIC SIMULATOR COMBINES SPEED, ACCURACY, AND CAPACITY

The Simetri logic simulator from Evaluations Per Second (EPS) boasts accuracy, speed, and high capacity. EPS claims that proprietary simulation algorithms make Simetri an order-of-magnitude faster than current simulation software. Additional speed gains come from a compact circuit-data representation that uses cache memory efficiently. Benchmarks show that Simetri can run at 270,000 events/s on 486-class machines. Sparcstation, IBM, and parallel-processing versions of the simulator will offer even higher performance.

Simetri uses a two-list, event-driven, timing-wheel algorithm to yield high accuracy with full timing information. There are no event-ordering dependencies that plague simulators relying on one-list algorithms. Simetri's accuracy is particularly important for systems with flip-flops, feedback paths, and potential race conditions.

Innovative data structures allow millions of gates to be simulated on desk-

top computers. The company ran a benchmark of Simetri at a memory efficiency of 64 bytes/primitive, which is 2 to 18 times more than today's simulators. On a computer with 128 Mbytes of physical memory, Simetri can simulate nearly two million gates without memory paging.

The product's user interface has pull-down menus, multiple windows, and on-line context-sensitive help. Multiple overlapping output windows display state information in tabular, event-trigger, snap-shot, and waveform representations.

Simetri will ship in the third quarter on 80386- and 80486-based computers, and in the fourth quarter on the IBM and Sparcstation workstations. Future plans include a mini-supercomputer version that will apply distributed parallel processing to simulation runs. Call the company for pricing.

*Evaluations Per Second Inc., 100 Fifth Ave., First Floor, Waltham, MA 02154; (617) 487-9959. CIRCLE 848*  
■ LISA MALINIAK

## DIGITAL SIMULATOR PERFORMS DYNAMIC TIMING ANALYSIS

Engineers can now perform dynamic timing verification in an integrated environment with the RapidTime simulator from Valid Logic Systems. RapidTime addresses the growing demand for worst-case timing analyses that's required to verify the performance of complex printed-circuit boards or systems containing high-speed ASICs.

The simulator runs in Valid's Logic Workbench digital-simulation environment, sharing the same user interface, libraries, and analysis tools as the com-

pany's logic and fault simulators. Engineers can exploit multiple modeling techniques, including more than 140 ASIC design kits and various behavioral and hardware models. And because the same engine drives both RapidSim and RapidTime, engineers can move back and forth between logic and worst-case timing simulation without performing translations.

Users have the option of viewing data stored by time, error type, signal name, or path name. Errors are presented in on-screen tables or printed reports, and can be cross-highlighted in Valid schematics for debugging.

The RapidTime simulator is available now. It can be purchased with the Logic Workbench starting at \$27,000. Existing Logic Workbench users can purchase RapidTime separately starting at \$20,000. Both Logic Workbench and the RapidTime simulator run as a network resource on DEC, IBM, and Sun workstations.

*Valid Logic Systems Inc., 2820 Orchard Pkwy., San Jose, CA 95134; (408) 432-9400. CIRCLE 849*  
■ LISA MALINIAK

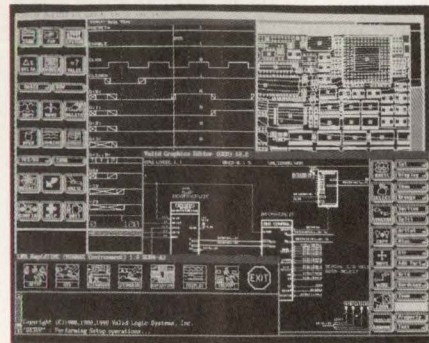

## PCB PACKAGE ADDS USER-REQUESTED FEATURES

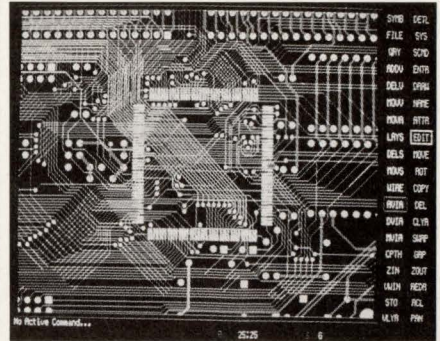

Release 5.0 of P-CAD's Master Designer pc-board design software adds more than 100 user-requested enhancements, including extended memory, user-configurable menus, and real-time, on-line design-rule checking. With extended memory, Master Designer 5.0 can handle up to four times larger designs than previous versions. The use of extended memory is transparent to users. Also, users can now customize menus to incorporate frequently used commands on the interface to speed the design process. The on-line DRC program automatically checks design rules as traces are edited on the board. Master Designer 5.0, which will ship by the end of the summer, runs on 80286- and 80386-based PCs. It costs \$8495.

*P-CAD, Cadam's EDA div., 1290 Parkmoor Ave., San Jose, CA 95126; (408) 971-1300. CIRCLE 850*

## MODEL SERVICE AIDS SYSTEM SIMULATION

The Model Bank service will help embedded-systems engineers exploit high-speed simulation techniques by supplying accurate structural models. In the past, these same engineers have depended on such techniques as behavioral modeling, in-circuit emulation, and physical modeling. Protocol already has signed agreements with Integrated Device Technology, LSI Logic, and MIPS to market structural models of their respective chips. Model Bank will be available for beta testing in the third quarter. Initial access to the service will be provided at Protocol's design center in New Jersey, or through remote dial-in access. Model subscription pricing will begin at \$5000. A customer-licensed on-site version of Model Bank is planned for mid 1992.

*Protocol, a div. of Zycad Corp., 500 International Dr., Mt. Olive, NJ 07828; (201) 347-7900. CIRCLE 851*

## NEW PRODUCTS

COMPUTER-AIDED ENGINEERING

### ANALYZE INTERCONNECTS AND INDUCTANCE IN 3D

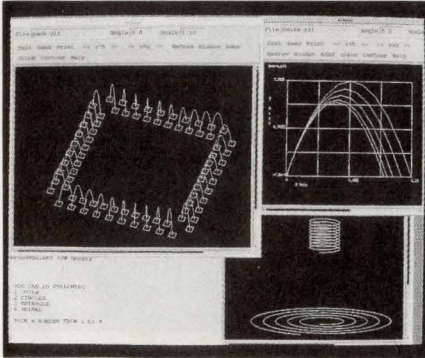

With two new software packages, engineers can now analyze designs in 3D. Metal Version 1.4 is a collection of programs for 2D and 3D modeling of interconnect parasitics from ICs, pc boards, multichip modules, and hybrids. These parasitics are then used to predict interconnect delay and crosstalk in a given circuit. Metal reports the predicted parasitic resistances, capacitances, inductances, and mutual capacitance and inductance for both regular and irregular interconnect geometries. Henry is a 3D inductance simulator for calculating self- and mutual-inductance of complex structures in non-magnetic media. It uses the mathematical definition of inductance and mutual inductance based on the energy stored or shared between magnetic circuits for the necessary calculations. Both products are shipping now on Mips and Sun workstations. Single-user licenses start at \$40,000. Multiuser licenses and network pricing are also available.

**OEA International Inc., 3235 Kifer Rd., Suite 300, Santa Clara, CA 95051; (408) 738-5972. CIRCLE 852**

### IMPROVED DESIGN TOOLS SMOOTH DATA FLOW

Version 2.2 of the Synopsys simulation and synthesis tools can produce a smoother flow of data throughout the design cycle over previous versions. This is accomplished with a tighter link that lets the Design Compiler synthesis tool write VHDL timing reports that can be read directly by the simulator for gate-level simulation with synthesized logic timing. The synthesis tools also provide links to physical layout data from such place-and-route tools as Cadence's Gate Ensemble software. Another enhancement is timing-driven resource sharing. It extends the architectural-optimization capability by making it possible to share complex

functions, like adders, subtractors, and multipliers, based on timing and area constraints. Also, other features new to Version 2.2 deliver a higher level of automation and boost a designer's productivity. Version 2.2 will begin shipping in November.

**Synopsys Inc., 1098 Alta Ave., Mountain View, CA 94043; (415) 962-5000. CIRCLE 853**

### SOFTWARE ACCURATELY MODELS INTERCONNECTS

The Raphael software accurately simulates the parasitic effects associated with interconnects and bonding wires. The simulator was developed through a cooperative effort between Hewlett-Packard and Technology Modeling Associates (TMA). Raphael can model arbitrary 2D and 3D interconnect structures, which lets engineers understand the electrical impact of layout and metalization. It provides detailed analysis of capacitive, resistive, and inductive effects. Users fill in parameterized interconnect templates to specify simulation structures. In addition, structures can be passed from a metalization simulation like TMA's Depict-2. Following simulation, electrical characteristics are visualized with Raphael's 2D and 3D graphics, and models are automatically generated for use in Spice circuit analysis. Raphael, which will ship by the end of the third quarter, can be used in the company's Studio graphical interface. Call the company for pricing.

**Technology Modeling Associates Inc., Third Floor, 300 Hamilton Ave., Palo Alto, CA 94301; (415) 327-6300.**

**CIRCLE 854**

### TIMING-DIAGRAM TOOL ADDS OVER 20 FEATURES

Over 20 features have been added to Release 3.0 of Doctor Design's dV/dt Timing Diagram Accelerator, a tool that automates the drawing of timing diagrams. The two biggest additions are PostScript printer output and support for the company's Test Vector Generator tool, which lets users export their timing diagrams in PLD simulator test-vector formats. Some of the other key additions include a short-grid option for clearer screen display, binary and text file formats for fast I/O transfer, and the ability to attach timing-display information to signals and have the information move automatically when the signal is moved. dV/dt Release 3.0 is shipping now. Pricing is set at \$695 for the Macintosh and standard DOS versions, and \$795 for the ex-

tended-memory DOS version. The Test Vector Generator costs \$495 alone and \$995 bundled with the Timing Diagram Accelerator.

**Doctor Design Inc., 5415 Oberlin Dr., San Diego, CA 92121-1716; (619) 457-4545. CIRCLE 855**

### ASIC TOOLS RUN ON A VARIETY OF PLATFORMS

The L-Edit ASIC-layout editor has two new tools, a layout-extractor module and an ASIC design-rule-checker module, that run on Sparc, HP-9000, PC, and Macintosh platforms. The layout-to-net-list extractor outputs to Spice-simulation and NTK net-list comparison formats. A domain-decomposition algorithm lets users extract large designs with time increasing only  $n \times \log(n)$  with design size. The design-rule-checker module offers user-definable Boolean layer operations and user-programmable rules. Designers can define a layer as the union, intersection, and/or negation of other layers. These layers can then be used in any of the design-rule-checker rule types, which include minimum width, exact width, minimum spacing, and minimum surround. The layout-extractor and design-rule-checker modules cost \$995, \$1495, and \$3950 on the PC, Macintosh, and Unix workstation, respectively. Both products are shipping now.

**Tanner Research Inc., 444 N. Altadena Dr., Pasadena, CA 91107; (818) 795-1696. CIRCLE 856**

### ORCAD SOFTWARE RUNS ON SUN WORKSTATIONS

Popular pc-based design software from OrCAD now runs on Sun workstations under the Unix operating system. The company's Release IV product line and the ESP Framework will use the Open Look graphical user interface, which is standard on all Sun machines. OrCAD's Release IV products include tools for design, verification, and layout of pc boards and programmable logic devices. Its ESP Framework is a graphical interface that eases tool selection and file management. The Unix versions of the tools use a 32-bit database, which is faster than the 16-bit database used by the PC versions. Release IV tools and the ESP Framework for the Sun will ship in the third quarter. Pricing ranges from \$1395 for the schematic tools with the framework to \$4495 for the PCB tools.

**OrCAD, 3175 N.W. Aloclek Dr., Hillsboro, OR 97124; (503) 690-9881.**

**CIRCLE 857**

## NEW PRODUCTS

COMPUTER BOARDS

# DATA-ACQUISITION BOARDS ELIMINATE ALIASING

A pair of PC/AT data-acquisition boards from Data Translation Inc., the DT3831 and the DT3831-G, prevent antialiasing. The boards eliminate the effects of undersampling input signals and noise from the environment that introduce spurious, undesirable frequency components in the signals being measured.

The DT3831 has a throughput of 50 kHz while the DT3831-G has a throughput of 250 kHz. Also, the DT3831 has a total harmonic distortion of 82 dB and a signal-to-noise ratio of 71 dB, both at 10 kHz. The DT3831-G, on the other hand, has a total harmonic distortion of 78 dB and a signal-to-noise ratio of 70 dB, both at 40 kHz.

Tight integration of the analog input circuitry and antialiasing filters reduces the distance between the board's signal conditioning and analog-to-digital converter. These software-confi-

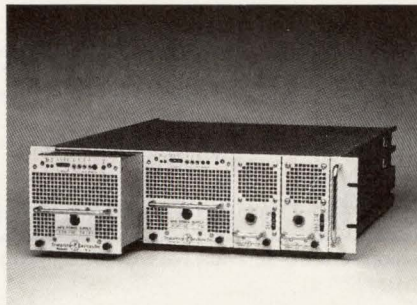

gurable R-C filters within the ADC module introduce less noise and distortion than alternative switched-capacitor configurations. In addition, integrating a four-pole Butterworth filter reduces the effects of undersampling, which adds aliasing errors caused by sampling noise or unwanted high-frequency components. The low-pass filter is software-selectable and supplies rapid attenuation of unwanted fre-

quencies at a rate of 24 dB/octave, while adding less than 0.25-dB ripple. For added flexibility, three software-configurable corner frequencies can be selected, or the antialiasing filter can be bypassed completely.

The boards also contain a real-time error-prevention circuit that adds on-the-fly calibration of any and all combinations of channel range and gain values. As a result, the rated accuracy is retained throughout the acquisition run to within  $\pm 0.5$  LSB, even as the gain setting changes.

The boards require just one slot in the PC's backplane. Both are available immediately. Included with the boards are the Series Driver, the ToolKit, and the Gallery. The DT3831 sells for \$3695 and the DT3831-G costs \$4395.

*Data Translation Inc., 100 Locke Dr., Marlboro, MA 01752; (508) 481-3700. **CIRCLE 859***

■ RICHARD NASS

# Feel The Power Of The Press

## Dynamic 320 Series Tactile Pushbutton Switches

Offering flexibility for single key or keyboard layouts.

- Momentary SPST or SPDT
- 8 Standard Colors
- Custom Printing Available

- Gold-plated Dome-style Contacts
- 15 Cap Styles
- Custom Cap Designs Welcome

Tested to over 1 million actuations, they're ideal for instrumentation, test equipment and professional audio gear. Their small size ( $\frac{1}{2}$ " square) makes them suitable for small hand-held equipment.

Put the Power of the Press at your fingertips with 320 Series Switches.

Read all about them in our catalog - **Advanced Switch Technology.**



 **ELECTRONIC COMPONENTS GROUPE**  
26 North Fifth Street • Minneapolis, MN 55403  
Phone: 612/375-9639 • FAX: 612/375-1905 • Toll-free: 800-677-8719

CIRCLE 170 FOR U.S. RESPONSE

CIRCLE 171 FOR RESPONSE OUTSIDE THE U.S.



# ELECTRONIC DESIGN

## DIRECT CONNECTION ADS

New Products/Services Presented By The Manufacturer.  
To Advertise, Call JEANIE GRIFFIN At 201/393-6080

Just \$495!\*



### ABEL-PLD: Logic design for less.

- 150 PLD architectures supported (more than 4000 devices)
- Uses ABEL™ Hardware Description Language (ABEL-HDL™)
- Intelligent synthesis and optimization
- Upgradable to full-featured ABEL Design Software

Call for your **FREE** ABEL-PLD™ Design Software start-up kit!  
1-800-3-DataIO (1-800-332-8246)  
*\*U.S. list price only.*

**DATA I/O**  
Corporation

DATA I/O CORP.

CIRCLE 407

Now \$1495!\*



### Save \$1000 on our entry-level logic system.

- Includes the 212 Multi Programmer with logic module, ABEL-PLD™ and PROMlink™ Ltd. PC Interface Software
- Supports 20- and 24-pin CMOS logic devices
- Full-hex keypad for extensive editing
- Compatible with JEDEC standard programming files
- Optional EPROM and microcontroller modules

Call today to order!  
No-risk, money-back guarantee!

1-800-3-DataIO (1-800-332-8246)  
*\*U.S. list price only.*

**DATA I/O**  
Corporation

DATA I/O CORP.

CIRCLE 408

### Analog Circuit Simulation SPICE FOR THE PC

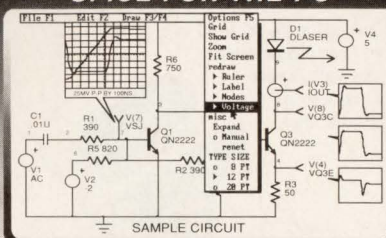

- Schematic Entry • SPICE Simulation
  - Model Libraries • Waveform Graphics
- Intusoft has it all at an Affordable Price!**

INTEGRATED, EASY TO USE SIMULATION ENVIRONMENT, FEATURING: A powerful SPICE (IsSPICE) simulator performing AC, DC, Transient, Noise, Fourier, Distortion, Sensitivity, Monte Carlo, and Temperature analyses. Extensive model libraries, Schematic entry, and Waveform processing. Starting at \$95 for IsSPICE, complete systems are available for \$815.

Call Or Write For Your Free Demo and Information Kit!  
**intusoft** P.O. Box 710 San Pedro, CA 90733-0710  
Tel. 213-833-0710 Fax 213-833-9658

INTUSOFT

CIRCLE 411

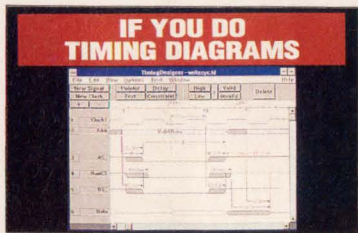

### YOU NEED TIMINGDESIGNER®

\*TimingDesigner is the fast, accurate way to draw and analyze timing diagrams. \*Calculates timing margins and instantly highlights timing violations. \*Automatically generates complete, clear, standardized timing documentation. \*Runs under Windows™ 3.0, which means it supports hundreds of printers, plotters, and graphics cards.

Call 1-800-800-6494 and find out how to get a free demonstration.

**Chronology Corporation**  
2721 152nd Ave. NE Redmond, WA 98052  
(206) 869-4227 Fax: (206) 869-4229

ORDER NOW FOR \$995  
CHRONOLOGY CORP.

CIRCLE 410

### Interactive/Real-Time

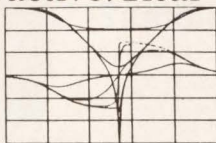

ECA-2

### Analog Circuit Simulation

ECA-2 Electronic Circuit Analysis offers: • AC, DC, Transient, Fourier, and Temperature Analysis with Nominal, MonteCarlo and/or Worst-Case component values • Interactive or batch modes • Full nonlinear simulation • Sine, Pulse, PWL, SFFM, and Exponential generators • IBM PC/Mac • Multiple plots • On-line real time graphics - 2 to 50 times faster than SPICE • Over 500 nodes • Advanced component parameters • Component optimization sweeping • Full editing, built-in or external • New detailed 424 page manual

Call for **FREE DEMO!**

**Tatum Labs, Inc.**  
3917 Research Park Dr. B-1, Ann Arbor, MI 48108  
313-663-8810

TATUM LABS

CIRCLE 415

### HAND HELD TERMINAL \*\$199.

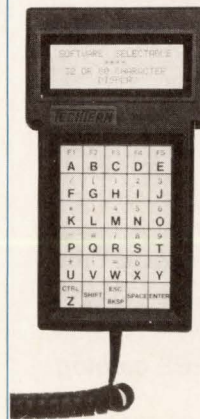

- 80 character display
- 30 or 45 keys
- RS 232 or RS 422
- Low power
- ST-32 Compatible
- Standard or custom overlay
- Single 5V or 8-12V supply
- 15 Programmable function keys
- Simple menu set-up
- 300-9600 baud
- 7 or 8 data bits
- Even, odd, mark, space
- 7 1/2" x 4" x .9"
- 8 ounces

Internal Batteries and Built in Charger—Optional  
**TWO TECHNOLOGIES, INC.**  
419 Sargon Way, Horsham, PA 19044  
215-441-5305

\*SINGLE PIECE OEM OR VAR PRICE

TWO TECHNOLOGIES

CIRCLE 405

**"Tango gives us more than just great CAE/CAD tools."**

"We love using every one of the programs in the Tango design suite. But owning Tango tools means more than getting high performance and quality output at an affordable price. It also means getting that extra measure of value with ACCEL's excellent service and support."

With each Tango design tool for schematic entry and PCB and PLD design, you'll get: thorough documentation; friendly customer service; affordable updates; reliable technical support; BBS; user newsletter; and a 30-day guarantee.

Manfred Koch  
President, O.E.M. manufacturer

**Tango**

See for yourself. Call today for information or a free evaluation package.

**800 488-0680**

619 554-1000 • FAX: 619 554-1019

ACCEL Technologies, Inc.  
6825 Flanders Drive • San Diego, CA • 92121 • USA  
Contact us for the representative nearest you.

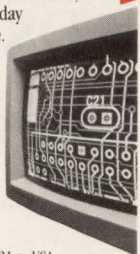

ACCEL TECHNOLOGIES

CIRCLE 400

**TESLA** formerly TESS  
**PC Block Diagram Simulator**

30-day money back guarantee!

Modems, DSP, satcom, nav, controls...

Times are tough: shorter schedules, fewer engineers. TESLA can help you:

- Detect problems before breadboarding.
- Do proposals that sell with perf. data.
- Find the best design alternatives fast.
- Bring specs to life in a working model.
- Show junior engineers the big picture.
- Put a lab in your laptop for just \$695!

Demo disk. 404-751-9785 Fax: 404-664-5817  
TESOFT Inc. Box 305, Roswell, GA 30077

TESOFT

CIRCLE 416

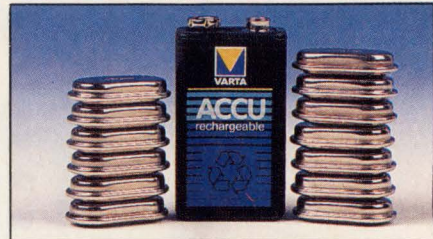

**One 9-volt rechargeable: Your choice of guts**

Choose the V6/8R with six 110-mAh cells and get **30% more capacity** than from 9-V batteries built with 80-mAh cylindrical cells. Or choose the V7/8R with **seven 110-mAh cells**, get **30% more capacity** and **add 1.2-V** to enhance performance. The V6/8R is cost competitive; the V7/8R more than justifies its price. Contact Varta Batteries, 1-800-431-2504, Ext 270.

**VARTA**

VARTA

CIRCLE 414

**NoiseKen**

Connected to the AC or DC lines, the Noise Checker detects pulse voltages with the duration of 300ns to 10µs.



**NOISE CHECKER**  
model **NCC-532**

U.S.A. WATAHAN NOHARA INTERNATIONAL, INC.  
TEL (800)366-3515

NOISE LAB

CIRCLE 403

**IF YOU USE HIGH PERFORMANCE PLDs ...**

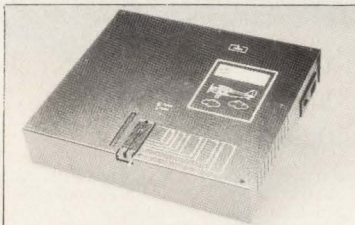

If you need trouble-free programming and functional testing, then the PILOT-U40 is for you. Many programmers just cannot handle the demands of today's high speed CMOS devices. We currently support 5ns bipolar PALs, 7ns GALs, all MACH devices, EP-1800, Xilinx, E/EPROMs, PROMs, micros, etc. Starting from \$1,095. Made and supported in USA. Please call us at:

408-243-7000, 800-627-2456, Fax 408-736-2503



**ADVIN SYSTEMS INC.**

1050-L E. Duane Ave., Sunnyvale, CA 94086

ADVIN

CIRCLE 409

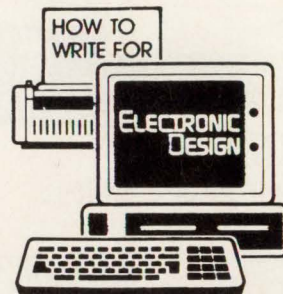

**ELECTRONIC DESIGN AUTHOR'S GUIDE**

Thinking of writing a technical article for publication in Electronic Design? This 12-page brochure contains just about everything you need to know about the process: submitting the outline, tips on writing the manuscript, preparing the artwork, and more.

**ELECTRONIC DESIGN**

611 Route #46 West  
Hasbrouck Heights, NJ 07604

ELECTRONIC DESIGN

**IEEE 488.2**

Hardware for IBM PC/AT, Micro Channel, Sun, Macintosh, DEC, and NeXT.

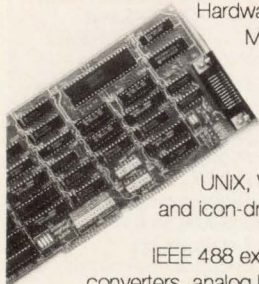

Software for DOS, UNIX, VMS, menu-driven and icon-driven environments.

IEEE 488 extenders, analyzers, converters, analog I/O, and digital I/O.

Call for your free IEEE catalog

**IOtech**

IOtech, Inc. • 25971 Cannon Road  
Cleveland, Ohio 44146 • (216) 439-4091

IOTECH

CIRCLE 412

**Communications Problems?**

The compact Protocol Switch™ is designed to solve special communications problems. There are 4 serial ports configurable in different ways: RS485 ports for long distance, synchronous ports for high speed and RS232 ports for IBM-PC interface. 2 parallel ports (32 bits) provide high speed bidirectional communications with the IBM-PC or standard PC printers. The Protocol Switch is easy to program with our low cost, interactive C development system. Battery backed memory, time of day clock, EEPROM. Use our box or embed the PC board in your product. Off-load PC communications using 80,000 byte per second transfer via parallel port. Applications: Change serial / parallel protocols. Implement another layer of security. Use for industrial control with our Opto 22 software support. From \$295.

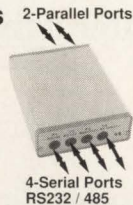

4-Serial Ports  
RS232 / 485

**Z-World Engineering**

1340 E. Covell Blvd.  
Davis, CA 95616

Tel: (916) 753-3722 Fax: (916) 753-5141

Automatic Fax: (916) 753-0618

(Call from your fax, request data sheet #19.)

Z-WORLD ENGINEERING

CIRCLE 406

**YOUR AD HERE**

Here's all you have to do:

- Send a B/W or 4C glossy photo.
- Include 13 lines of copy. (37 characters per line)
- Write a headline of 32 characters or less.

**We do all the rest. No production charges.**

We also accept camera-ready art. Ad size 2 3/16" wide x 3" deep.

ELECTRONIC DESIGN



## PRE-ASSEMBLED COAX CABLES

L-com stocks over 800 different types of coaxial cables for immediate delivery. Emphasis is on pre-assembled cables with molded ends and high quality U.L. Listed coax. Standard lengths are from one to 100 feet.

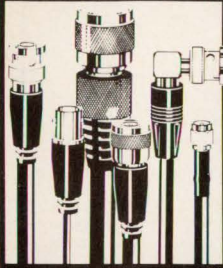

L-com can service immediate requirements & long term OEM quantities. Our quality and service are exceptional, our prices reasonable. We ask that you give us the opportunity to service your needs. We want to be your number one source of supply!

Send for our NEW 1991 Catalog.



1755 Osgood St., N. Andover, MA 01845  
Inquiries 508 682-6936 FAX 508 689-9484  
Toll Free Ordering 800 343-1455

L-COM

CIRCLE 404

### AGENTS WANTED

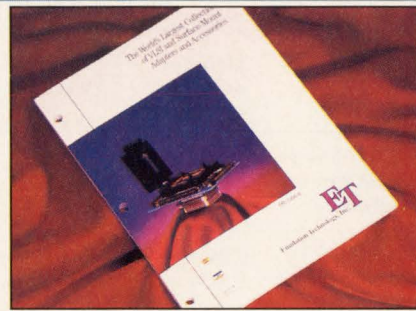

## Free Catalog

The World's Largest Collection of Adapters & Accessories for VLSI/Surface Mount Devices

- Emulator Pods & Adapters
- Debug Tools
- Programming Adapters
- Socket Converters
- Debugging Accessories
- Prototyping Adapters
- Custom Engineering

Emulation Technology, Inc.  
2344 Walsh Ave. Santa Clara, CA 95051  
Phone: 408-982-0660 FAX: 408-982-0664



EMULATION TECHNOLOGY

CIRCLE 413

## LOW COST Data Acquisition Cards for PC/XT/AT



### 12 Bit A/D & D/A [PCL711S] \$295

- A/D converter: 8 single-ended channels; Uses AD574 device; Conversion time is less than 25 $\mu$ sec; Input range:  $\pm 5V$ ; Software Trigger Mode only.
- D/A converter: 1 channel; 12 bit resolution; 0 to  $\pm 810V$  Output Range.
- Digital I/O: 16 In/Out (TTL compatible); External Wiring Terminal Board incl.
- Utility Routines and Demo/Sample Programs for BASIC and Quick-BASIC.

### 12 Bit A/D & D/A [PCL812] \$395

- A/D converter: 16 single ended inputs; Uses AD574; Conversion time less than 25 $\mu$ sec; Built-in programmable pacer; Input Ranges:  $\pm 10V$ ,  $\pm 5V$ ,  $\pm 1V$ .
- D/A converter: 2 channels; 12 bit resolution; Output Range 0-5V.
- Digital I/O: 16In/Out (TTL compatible); Programmable Counter/Timer (8254).
- DMA and interrupt capability. Utility software and sample program in BASIC.

### Fast 12 Bit A/D/A [PCL718] \$795

- A/D converter: 16 single ended or 8 differential channels; 12 bits resolution; Programmable scan rate; Built-in Interrupt and DMA control circuitry; Conversion speed 60,000 samples/sec (standard), 100,000 samples/sec (optional).
- Input Ranges: Bipolar:  $\pm 10V$ ,  $\pm 5V$ ,  $\pm 2.5V$ ,  $\pm 1V$ ,  $\pm 0.5V$ ; Unipolar: 10.5, 2, 1V.
- D/A converter: 2 channels; Resolution: 12 bits; Settling time: 5 $\mu$ sec;  $\pm 5V$ .
- Digital I/O: 16In/Out (TTL compatible); Programmable Counter/Timer (8254).
- Software: Utility software for BASIC & QuickBASIC included. Sample prgm. Supported by LabDAS, ASSYST, LABTECH, UnkeScope.

### 6 Channel 12 bit D/A [PCL726] \$495

- Output Ranges: 0 to  $\pm 5V$ , 0 to  $\pm 10V$ ,  $\pm 5V$ ,  $\pm 10V$ , or sink 4-20mA.
- Settling time: 70 $\mu$ s. Linearity:  $\pm 1/2$ bit. Voltage output drive capacity:  $\pm 5mA$ .
- Digital I/O: 16 digital input and 16 digital outputs (TTL compatible).

MC / VISA / AMEX

Call today for datasheets!



B&C MICROSYSTEMS INC.  
750 N. Pastoría Ave., Sunnyvale, CA 94086 USA  
TEL: (408) 730-5511 FAX: (408) 730-5521

B&C MICROSYSTEMS

CIRCLE 417

Attention All Device Programmer Users:

**FREE** A \$24.95\* VALUE!

## Data I/O Wall Chart

FAX us the name and serial number of your device programmer, and you'll qualify for a FREE copy of Data I/O's 1991 Wall Chart, listing more than 4,000 devices in 12 device categories.



To qualify, FAX the form at right.

\*U.S. list price only.



DATA I/O CORP.

CIRCLE 401

Attention All Device Programmer Users:

## FAX this Form

To: Data I/O FAX #: (206) 869-7423  
Subject: My FREE Wall Chart

Name: \_\_\_\_\_  
First M.I. Last

Title: \_\_\_\_\_

Company: \_\_\_\_\_

Address: \_\_\_\_\_

Mail Stop: \_\_\_\_\_

City/State/Prov.: \_\_\_\_\_

Zip/Postal Code: \_\_\_\_\_

Phone Number: (\_\_\_\_\_) \_\_\_\_\_  
Area Code

Brand/model of my programmer\*\* \_\_\_\_\_

Serial number \_\_\_\_\_

Or call 1-800-3-DataIO (1-800-332-8246).

\*\*We'll accept any brand of device programmer.



DATA I/O CORP.

CIRCLE 402

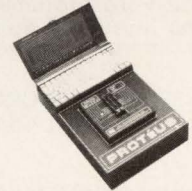

## PROTEUS - UNIVERSAL DEVICE PROGRAMMER from \$995

- Programs virtually all Memory & Logic Devices on the market
- 40 pins standard; Upgradeable internally to 104 pins, and via external adapter module to a total of 296 pins; DAC generated programming voltages
- Interfaces to any IBM-PC/XT/AT/PS2 via parallel port (cable included)
- Optional snap-in palmtop PC for stand-alone operation
- User friendly menu driven software with built-in full screen memory, fuse map and test editor; Fully integrated Algorithm Development Environment allows users to add parts to the device library or modify existing devices
- Powerful Macro Language allows for Batch Mode Operation
- True State Machine Testing capability (all pins clocked simultaneously)
- Fully overcurrent & overvoltage protected pin drivers (risetime < 100ns)
- Reads / Programs 1MB EPROMs in 10 / 35 seconds (using 16MHz PC)
- Gang / Set / Split programming capability; Register preload for logic devices
- Software selectable pin decoupling capacitors and clock sources
- True 100% Hardware Self-Calibration & Diagnostics via built-in A/D converter with 25mV resolution
- Device insertion detection (detects reversed and shifted insertions)
- Adapter Modules for GANG, PLCC, JEIDA Cards; Device Handler Interface
- Additional Adapter Modules and Software Packages allow reconfiguration as (PCB) Tester, Data Logger, Controller, Programmable Power Supply

MC / VISA / AMEX

Call today for datasheets!



B&C MICROSYSTEMS INC.  
750 N. Pastoría Ave., Sunnyvale, CA 94086 USA  
TEL: (408) 730-5511 FAX: (408) 730-5521

B&C MICROSYSTEMS

CIRCLE 418

# ELECTRONIC DESIGN

## DIRECT CONNECTION ADS

### 1991 SCHEDULE

Issue Date:	Ad Close	Issue Date:	Ad Close
July 11	June 14	Oct. 10	Sept. 13
July 25	June 28	Oct. 24	Sept. 27
August 8	July 12	Nov. 7	Oct. 11
August 22	July 26	Nov. 21	Oct. 25
Sept. 12	Aug. 16	Dec. 5	Nov. 8
Sept. 26	Aug. 30	Dec. 19	Nov. 20

To Advertise, Call JEANIE GRIFFIN At 201/393-6080

# CLASSIFIEDS

## EMPLOYMENT OPPORTUNITIES

### POWER SUPPLY ENGINEERS

SR. PROJECT ENGINEERS CA. You will design AC/DC, and DC/DC switching P/S's, with mechanical layout, no, and breadboard testing.

SR. DESIGN ENGINEERS AZ. You will be responsible for designing high level commercial P/S's with a variety of Topologies.

LEAD ENGINEERS Mid-Atlantic. Your Analog and Power Supply exp's will be used for designing Military Avionics Mil-Std 704, 461, P-4855, and navmat.

SR. DESIGN ENGINEERS (NW). You will design to Military dod 1000, and 100. Must have layout and PCB exp's.

TRANSFORMER ENGINEERS (NE). Must have UL and CSA Certification.

CIRCUIT DESIGNERS (NW). Must have board mounted high density DC/DC Converter exp's.

Must have five years exp's with a MS/BS Degree. Send your resume or fax's it to:

**POWER SUPPLY RECRUITERS**  
**P.O. BOX 420209**  
**Houston, Texas 77242-0209**  
**Fax's 713-977-4121**

## BUSINESS SERVICES

### HARDWARE AND SOFTWARE DEVELOPMENT SERVICES

- We specialize in developing microprocessor/FPGA based products/systems and embedded software development.
- Custom Windows V3.0 and networking software development.
- Can help with part of or handle the entire project.
- Full Microprocessor Development Systems, i<sup>2</sup>C, CAD/CAM, and PCB layout system.
- Development for LAN, Multibus, VME, PC, MCA, and STD.

**Applied Computer Techniques, Inc.**  
 Tel. (407) 851-2525 Incorporated 1978

## CONSULTANTS

**PRODUCT ENGINEERING & Mfg., Inc.**  
**Over 25 Years Of Experience**  
**We can save you TIME and MONEY, YOU do the ELECTRONICS and we'll do the REST**  
**CONTRACT DESIGN & PROTOTYPING**  
 • ENCLOSURES • INDUSTRIAL DESIGN  
 • MECHANISMS • AutoCAD - AutoPCB  
**MANASSAS, VA 703-754-1508**

# INDEX OF ADVERTISERS

ADVERTISER	READER SERVICE U.S. / OUTSIDE U.S.	PAGE NUMBER	ADVERTISER	READER SERVICE U.S. / OUTSIDE U.S.	PAGE NUMBER
ACCEL Technologies	400	178	MicroSim	158, 159	140-141
Advanced Micro Device	266, 26	10-11	Mini-Circuits Laboratory, a Div. of Scientific Components Corp.	272, 273	15
Advin Systems	409	178		270, 271	20-21
AMP	186, 187	42-43		296, 297	130
Analog Devices	264, 265	50-51		274, 275	Cover III
	80, 81	143	Motorola Computer Group	154, 155	80-81
	188, 189	158	Motorola Semiconductor	∅	6-7
Apex Microsystems	190, 191	27*, 101**		∅	30-31
Applied Microsystems	82, 83	24-25	Multibus Manufacturers Group	∅	77
Arnold Magnetics	118, 119	138	MWS Wire Industries	126, 127	101*
AT&T	206, 207	38-39*	National Instruments	276, 277	137
Avantek	128, 129	94, 95	National Semiconductor	∅	129
AVX	132-135	73	NEC	226, 227	88-89
B&C Microsystems	417	179	Nohau	178, 179	171
	418	179	NoiseKen	403	178
Brooktree	196, 197	12-13	OKI Semiconductor	130, 131	106-107*
	194, 195	133	Omation	258, 259	8
Bud Industries	198, 199	119	Opus Systems	∅	44*, 102**
Burr-Brown	120-121	19	Philips Discrete	156, 157	113
Buscon '91	90, 91	154	Philips Semiconductor	262, 263	27-29**
Capital Equipment Corp.	200, 201	170	Philips Test & Measurement	∅	44**
Chronology Corp.	410	177		∅	93**
Cirrus Logic	∅	9	Pico Electronics, Inc.	172, 173	18, 150
Clarostat	144, 145	121	Pioneer	180, 181	70
Coilcraft	152, 153	111*	Plastics Engineering	164, 165	123
Comlinear	250, 251	151	Power Convertibles	234, 235	145
Condor	192, 193	102*	Power-One	260, 261	105
Contraves Intersys	168-169	122**	Power Trends	182, 183	122
CTS Corp.	286, 287	118	Precision Interconnect	252, 253	135
Cybernetic Micro Systems	202-203	14	Programmed Test Sources	142, 143	35
Cypress Semiconductor	∅	152	Qualidyne	124, 125	79
Data Delay Devices	204, 205	134	Quality Semiconductor	242, 243	157
Data I/O Corp.	401	179	Samsung Semiconductor	278, 279	74-75
	402	179	Sanyo Energy	236, 237	109
	407	177	Siemens Corp.	122, 123	116*
	408	177	Siliconix	∅	37
Data Translation	184, 185	82	Sipex	240, 241	87
Dialight	86, 87	147	Sony Semiconductors	146, 147	124
Digital Equipment	∅	52	Spectrol	174, 224	
EG&G Vactec	246, 247	78		175, 225	120
Electronic Components Groupe	170, 171	175	Tatum Labs	415	177
Emulation Technology	413	179	Tektronix	294, 295	16-17
Engineered Components Corp.	228, 229	156		148, 150	
Expocoon	∅	176		149, 151	96
Ferranti Venus	210, 211	168	Tesoft	416	178
Harris Semiconductor	268, 269	69	Texas Instruments	∅	48A-48D*
	102, 103	164	Thermometrics	208, 209	168
Hewlett-Packard Co.	284, 285	2-3	TRW	280, 281	64-65
	230, 231	28-29*		282, 283	66-67
	244, 245	40-41	Two-Technologies	405	177
	110, 111	93*	Unirode Integrated	248, 249	115
Hoffman Engineering	114, 115	149	UTMC	238, 239	71
Illinois Capacitor	162, 163	100	Varta Batteries	414	178
Integrated Device Technology	∅	33	Vicor	140, 212	85
Intel Microcomputer	112, 113	1		141, 223	52
International Rectifier	232, 233	22	Z-World Engineering	406	178
Intusoft	411	177			
IOtech	412	178			
J.W. Miller	166, 167	8			
L-Com	404	179			
Linear Technology	106, 107	Cover IV			
Maxim	288, 289	Cover II			
	290, 291	55			
	292, 293	57			
Micrel	254, 255	58-59			
Micro Linear	116, 117	161			

\* Domestic Advertiser Only

\*\* International Advertiser Only

The advertisers index is prepared as an extra service. Electronic Design does not assume any liability for omissions or errors.

# incredible!

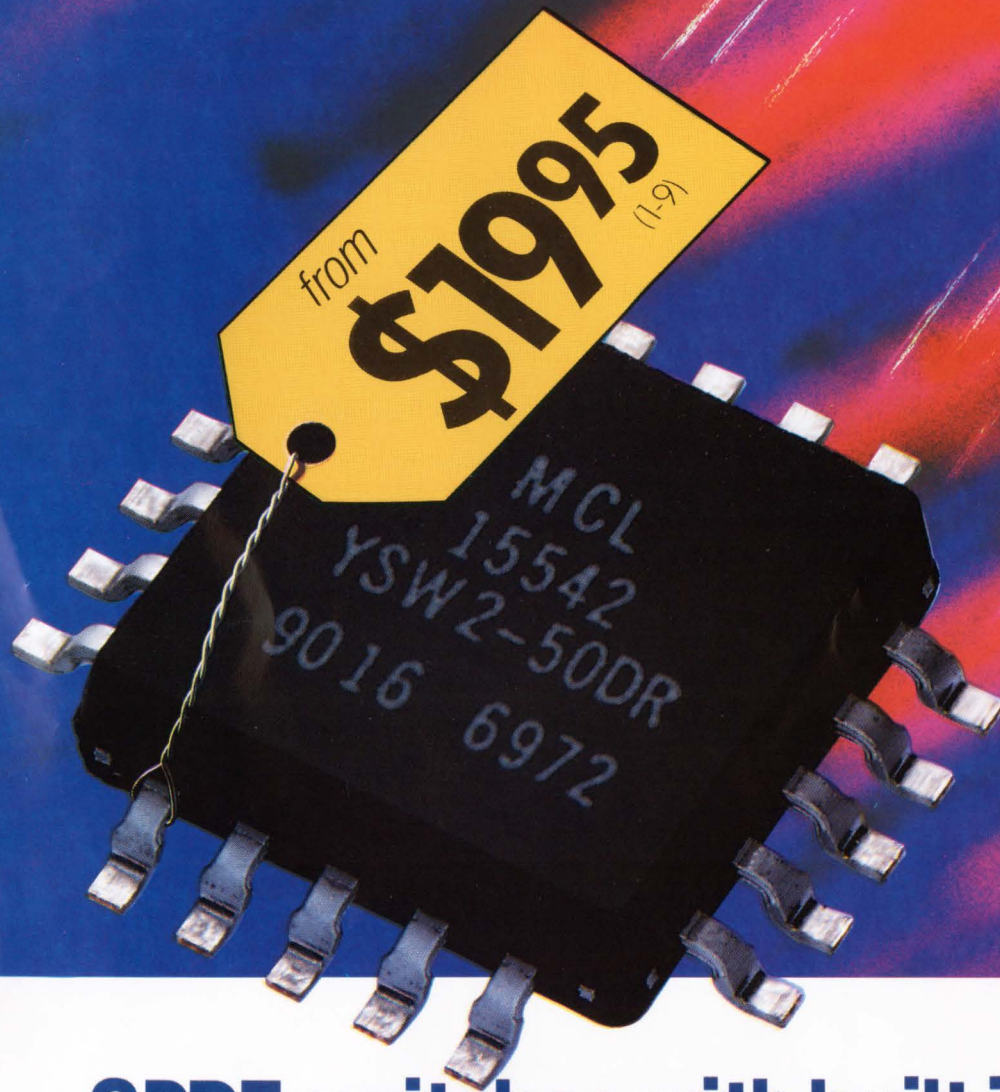

## SPDT switches with built-in driver absorptive or reflective dc to 5GHz

Truly incredible...superfast 3nsec GaAs SPDT reflective or absorptive switches with built-in driver, available in pc plug-in or SMA connector models, from only \$19.95. So why bother designing and building a driver interface to further complicate your subsystem and take added space when you can specify Mini-Circuits' latest innovative integrated components?

Check the outstanding performance of these units...high isolation, excellent return loss (even in the "off" state for absorptive models) and 3-sigma guaranteed unit-to-unit repeatability for insertion loss. These rugged devices operate over a -55° to +100° C span. Plug-in models are housed in a tiny plastic case and are available in tape-and-reel format (1500 units max, 24mm). All models are available for immediate delivery with a one-year guarantee.

finding new ways...  
setting higher standards



**Mini-Circuits**

P.O. Box 350166, Brooklyn, New York 11235-0003 (718) 934-4500 Fax (718) 332-4661 Telexes: 6852844 or 620156

### SPECIFICATIONS

Price (1-9 qty)	YSW-2-50DR (pin)	Absorptive	\$19.95
	ZYSW-2-50DR (connector)		\$59.95
	YSWA-2-50DR (pin)	Reflective	\$23.95
	ZYSWA-2-50DR (connector)		\$69.95

Frequency, (MHz)	50	100	dc-500	1000	500-2000	2000-5000
Insertion loss, typ(dB)	0.9	1.1	0.9	1.1	1.3	1.4
Isolation, typ (dB)	65	54	50	37	40	28
1dB compression, typ (dBm @ in port)	20	42	20	18	20	24
RF input, max dBm (no damage)	22	22	22	22	22	26
VSWR (on), typ	20	20	20	20	20	20
Video breakthrough to RF, typ(mV p-p)	1.4	1.25	1.4	1.35	1.4	1.5
Switching speed, typ (nsec)	3.0	3.0	3.0	3.0	3.0	3.0

# Pretty & Simple

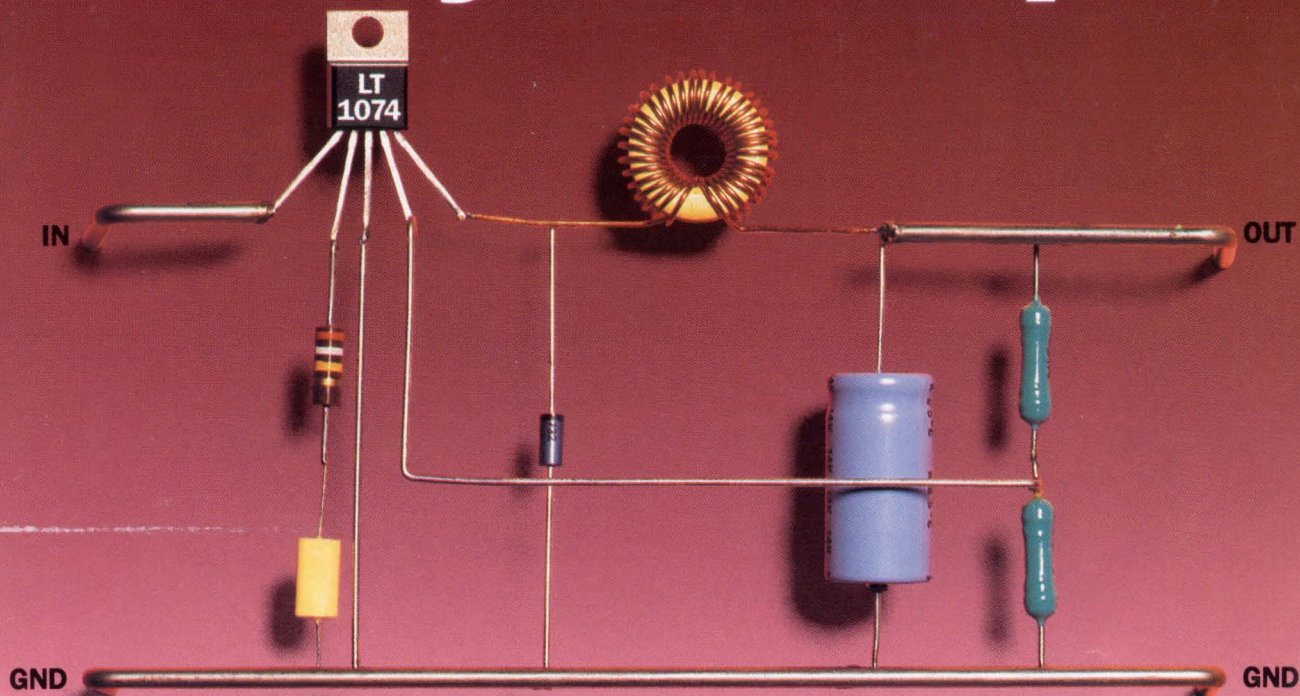

## 5A positive or negative stepdown or positive to negative voltage conversion.

Talk about easy. Linear's new LT1074 is a simple, elegant solution for your stepdown and inverting switching regulator applications. It's a 5 amp monolithic bipolar regulator with up to 200kHz switching frequency and internal adjustable current limiting. Power switch, oscillator and control circuitry and output monitor are also on the chip. It's a positive "buck" (stepdown) converter with several LTC innovations that also allow the device to be used as a positive to negative converter, a negative boost converter, and a flyback or forward converter.

As a stepdown converter, the LT1074 input voltage range is 8V to 60V. The switch out-

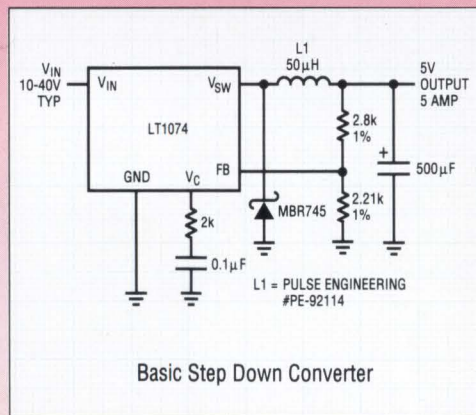

put can swing 40V below the ground, a feature that permits the regulator to perform positive to negative conversion with inputs down to 4.5V. It also allows the use of a tapped inductor for output currents up to 10A with no external switching transistor. A true analog multiplier in the feedback loop lets it respond quickly to input voltage fluctuations. The LT1074 is available in either a 5-lead TO-220 package or an 11-lead single-in-line package at \$5.25 and \$6.45, respectively, in 100-unit quantities. For a data sheet and applications note contact: Linear Technology Corporation, 1630 McCarthy Blvd., Milpitas, CA 95035 or call 800-637-5545.

 **LINEAR**  
TECHNOLOGY

TOUGH PRODUCTS  
FOR TOUGH APPLICATIONS.

CIRCLE 106 FOR U.S. RESPONSE

CIRCLE 107 FOR RESPONSE OUTSIDE THE U.S.