

# Electronic Design

FOR ENGINEERS AND ENGINEERING MANAGERS

VOL. 21 NO.

# 1

JAN. 4, 1973

**A/D and D/A converters** unite the worlds of the analog and digital design engineer. However, familiar specs are hard to find. Conversion time, resolution and

coding are mixed with settling time, accuracy and linearity. The converters come in many shapes and sizes. To clarify an often confusing subject, turn to p.56.

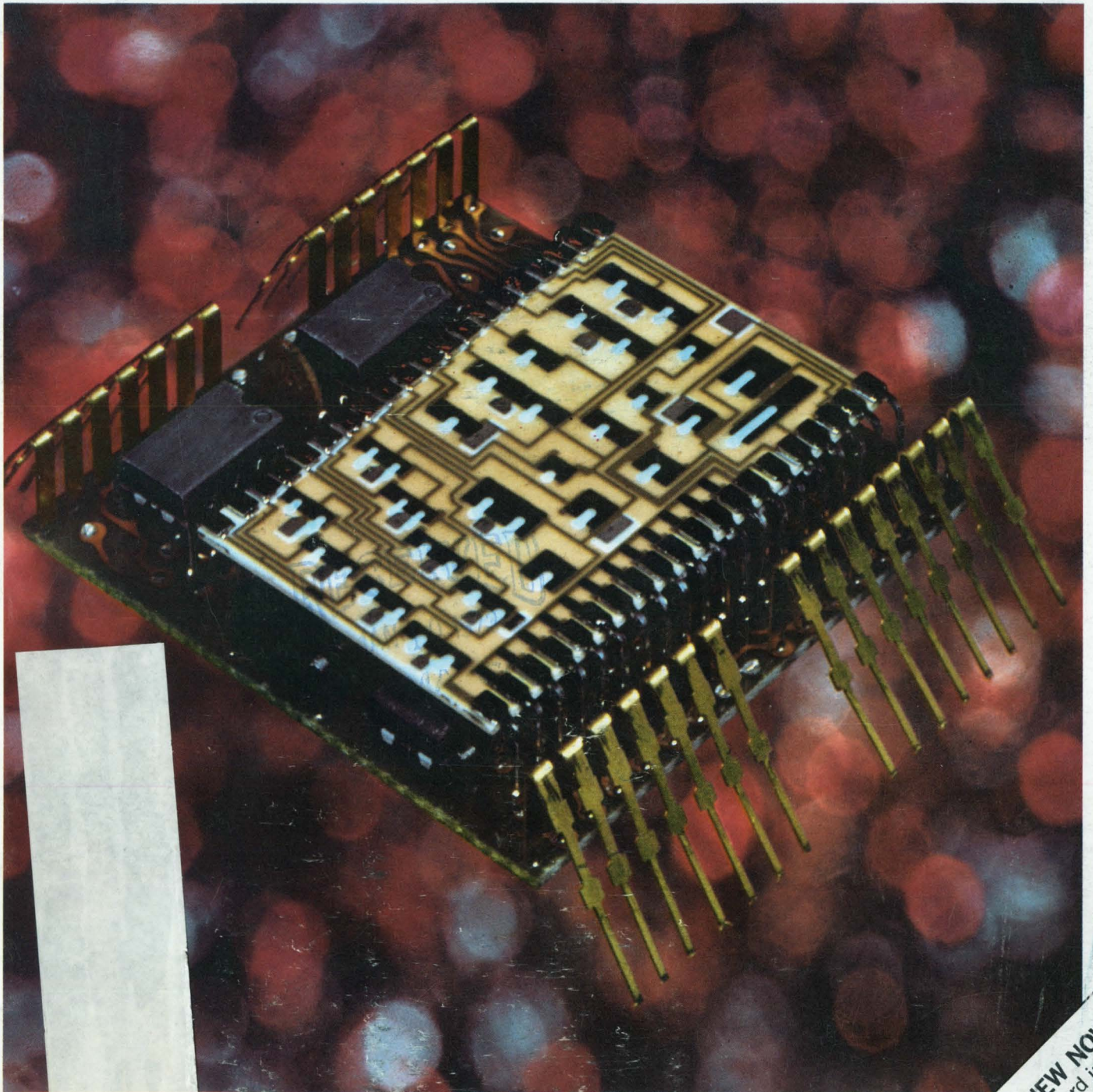

**RENEW NOW!**  
Use card inside  
front cover



# digital readout connectors

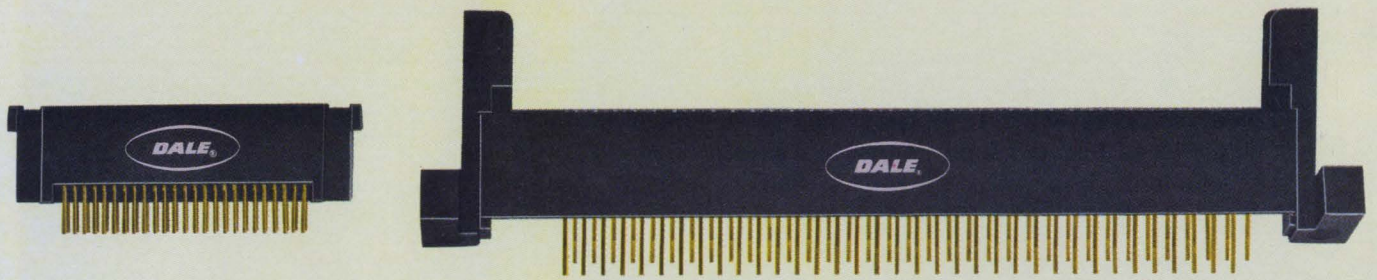

**...custom tailored to your case at standard prices**

Don't let a connector dictate your case design. Dale *Customline* .050" and .100" edgeboards give you extra design flexibility to cope with case contours. They'll help you produce an easy-to-read product with lots of eye appeal whether you're working with a calculator, a panel meter, a counter ...or other digital display application. Our unique design and manufacturing process lets us deliver custom body and contact configurations *below* the price of conventional high density edgeboards. And, if you're talking about any volume at all, the tooling will be amortized in the bargain. This is no

theoretical system. Dale *Customline* edgeboards are in use now mounting liquid crystal and LED displays in high volume calculator and panel meter applications. They're not limited to digital displays, either. They'll give you budget and design freedom wherever a low cost, reliable high density edgeboard is called for...the new leadless ceramic MOS packages, for example.

Make us prove it. Write for *Customline* Design Folder or call 605-665-9301 for Application Engineering Assistance.

INFORMATION RETRIEVAL NUMBER 242



TO: Dale Electronics, Inc., East Highway 50, Yankton, S. D. 57078

Send  Custom Edgeboard Design Outline  
 Information on Standard Edgeboards  Have Representative call.

NAME \_\_\_\_\_ TITLE \_\_\_\_\_ COMPANY \_\_\_\_\_  
 CITY \_\_\_\_\_ STATE \_\_\_\_\_ ZIP \_\_\_\_\_



## Until you try HP's new IC Troubleshooting Partners, you'll never know how simple logic circuit testing can be.

Just push a button on the Pulser on the left, and let the Probe on the right automatically monitor the response downstream.

How? HP's new 10526T Logic Pulser injects a single 300 nanosecond pulse anywhere in your TTL and DTL circuitry. Low nodes are momentarily forced high, high nodes automatically pulled low. There's no unsoldering or trace cutting. Just press the button and the pulse is there. \$95.

And HP's new 10525T Logic Probe checks the result. A single, unambiguous light at your fingertips tells you exactly what's going on. If no pulse is detected, something's wrong.

The Probe may be used to look for much more than just pulses. Highs, lows, bad levels, open circuits and pulse trains to 50 MHz are faithfully displayed. Even single shot events as quick as 10 nanoseconds are captured and stretched. And high impedance won't load even low power TTL, yet the Probe is fast enough to keep up with Schottky. \$95. (We also have a high threshold level version, Model 10525H, also \$95.)

For other applications, the HP 10528A Logic Clip monitors all pins of DIP TTL/DTL IC's simultaneously. Use the Clip with the Pulser — the Pulser injects clocks, transfers, shifts, etc. HP 10528A Clip, \$125.

All three troubleshooters team up as the 5015T Troubleshooters Kit for \$285 which gives you a 10% discount and a handy carrying case to boot.

For more information on these and other IC Troubleshooters call your local HP field engineer or write Hewlett-Packard, 1501 Page Mill Road, Palo Alto, California 94304; Europe: P.O. Box 85, CH-1217 Meyrin 2, Geneva, Switzerland; Japan: Yokogawa — Hewlett-Packard, 1-59-1, Yoyogi, Shibuya-Ku, Tokyo, 151.

**HEWLETT**  **PACKARD**

02206

---

# THE SMALLEST

---

## 5 AMP

---

# GENERAL PURPOSE

---

## RELAY

---

**Available now, Teledyne's  
new Mini-T.**

This industrial, heavy-duty 120 volt 5 amp relay features a life expectancy of over 10 million dependable operations. The space-saving 2PDT Mini-T with transparent dust cover has a full line of complementary sockets and hold down clips for P.C. board or chassis mounting. This Teledyne relay employs an unusual shaded pole design that permits direct AC operation without the need for rectifying diodes. Available with either AC or DC coils and demonstrating cost effectiveness that's hard to beat, the United States-manufactured Mini-T is truly worth its one-half ounce weight. The Mini-T . . . another finely-crafted relay from Teledyne. Call our nearest distributor today.

---

3155 West El Segundo Boulevard  
Hawthorne, California 90250  
Telephone (213) 679-2205



**TELEDYNE  
RELAYS**

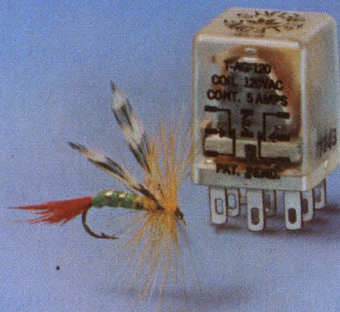

---

## NEWS

- 27 **News Scope**
- 30 **With LSI, you'll get more instrument performance** in a much smaller package at a lower price.
- 31 **NMOS and CMOS are surging to the front** in a drive to dominate the semiconductor scene.
- 32 **The minicomputers:** faster, sophisticated and a choice of MOS or bipolar memories.
- 34 **Color TV swinging over to in-line tubes,** while more complex ICs widen the consumer market.
- 36 **Charge-coupled devices:** First commercial uses seen in 1973.
- 44 **Technology Abroad**
- 47 **Washington Report**

---

## TECHNOLOGY

- 56 **Focus on a/d and d/a converters:** A special report on the commercially available units and a comprehensive look at the problems in specifying them.
- 68 **Engineering jobs: What, why and where?** All indicators point to more jobs, more money and a major shortage of engineers in the near future.
- 76 **Get perfect linearity in CRTs** when using resonant-recovery circuits with large screens and large deflection angles. A straightforward circuit provides the correction.
- 84 **'Celerate' the digital stepping motor** and overcome limitations of the maximum start/stop rate. You'll get maximum synchronous slew frequency.
- 90 **Check before you freeze that design!** Here's a master checklist that just might ward off disaster some day. Use it while you work.
- 96 **Ideas for Design:** Integrate-and-hold circuit gives electrochemical measurements . . . Analog multiplication or amplitude modulation are provided by a single MOSFET . . . 8-line digital multiplicity encoder uses MECL . . . Retriggerable one-shot prevents false triggering of PLL tone detector.

---

## PRODUCTS

- 105 **ICs & Semiconductors:** Flexible power switch/amp IC delivers 10 W of peak power.
- 118 Data Processing
- 128 Components
- 136 Modules & Subassemblies
- 142 Instrumentation
- 148 Microwaves & Lasers
- 154 Packaging & Materials

---

## Departments

- 53 **Editorial:** Stop the computer. I want to get off.
- 7 Across the Desk
- 160 Evaluation Samples
- 161 Design Aids
- 162 Application Notes
- 164 New Literature
- 170 Vendors Report
- 174 Advertisers' Index
- 176 Product Index
- 176 Information Retrieval Card

**Cover:** Photo of 12-bit DAC, the ZD 432, by Concord Photography Studio, courtesy of Zeltex Inc., Concord, Calif.



**hp** 34740 A DISPLAY

OFF ON

--- 19.999

**hp** HEWLETT • PACKARD 34702A MULTIMETER

INPUT V HI 3200V MAX

LO 500V MAX

DCV ACV OHM

INPUT Ω 350V MAX

500V MAX

100Ω 1 10 V/kΩ 100 1000 10MΩ

Detailed description: The image shows the front panel of a Hewlett-Packard 34702A digital multimeter. At the top left, there is a label for the '34740 A DISPLAY' and a power switch labeled 'OFF ON'. The central digital display shows the number '19.999' in red LEDs. Below the display, the brand name 'HEWLETT • PACKARD' and model '34702A MULTIMETER' are printed. The control panel features several rotary dials and push buttons. On the left, there are two input jacks labeled 'HI' and 'LO' for voltage measurements, with '3200V MAX' and '500V MAX' ratings. In the center, there are three function buttons for 'DCV' (Direct Current Voltage), 'ACV' (Alternating Current Voltage), and 'OHM' (Resistance). Below these are six range selection buttons for voltage: '100Ω', '1', '10', '100', '1000', and '10MΩ'. On the right, there are two more input jacks for resistance measurements, with '350V MAX' and '500V MAX' ratings. The entire device is housed in a light-colored plastic casing.

# The New Snap-On...

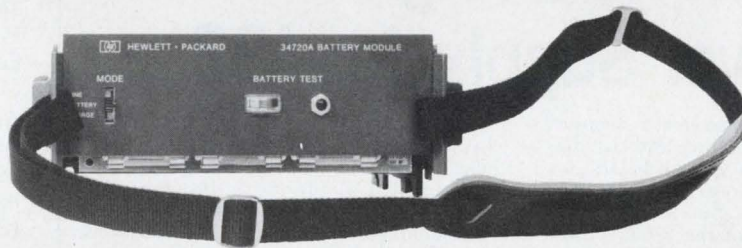

## Low-Cost, 4-Digit Measurement System 3470.

- Bright LED Display section has 100% overranging.
- AC/DC/OHMS snap-on with display. (\$600 complete)
- DC snap-on with display. (\$475 complete)
- Snap-together expandibility with sandwich centers — battery pack (\$200); BCD (\$175).
- H-P's exclusive self-test accessory reduces down time (\$50).

If you need one of these low-cost DMM's, there's no time like the present. Pick up the phone and call your nearest H-P Representative, now. Or, write to Hewlett-Packard, Palo Alto, California 94304; Europe; P.O. Box 85, CH-1217 Meyrin 2, Geneva, Switzerland. In Japan: YHP, 1-59-1, Yoyogi, Shibuya-Ku, Tokyo, 151.

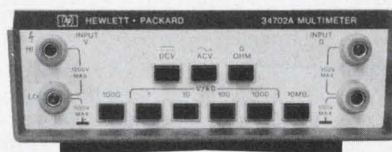
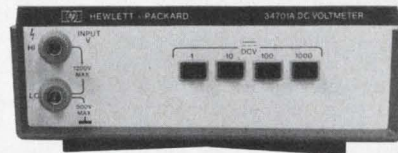

HEWLETT  PACKARD

DIGITAL VOLTMETERS  
INFORMATION RETRIEVAL NUMBER 4

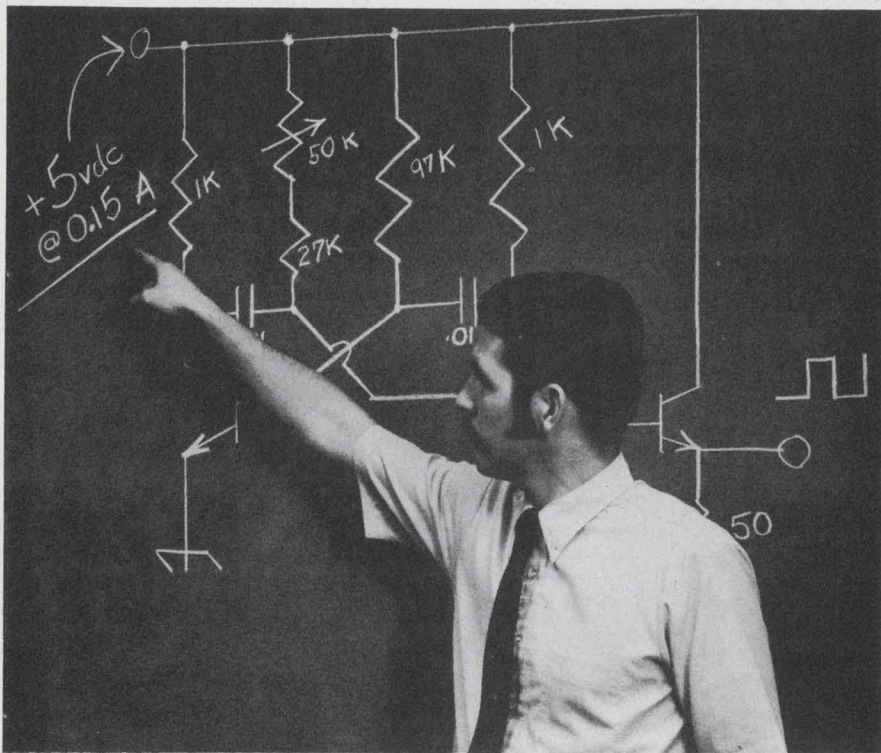

## How to Design Your Power Supply for \$83

You get the **complete schematic diagram, and parts list** with operating and installation instructions when you spend \$83 for an Abbott Model "R" power supply. Two years in development, this model represents the latest state of the art in power module design. It features close regulation ( $\pm 0.05\%$ ), low ripple (0.02%), automatic short circuit and complimentary overvoltage protection and continuous operation in a 160°F ambient.

Abbott Engineers followed specific design criteria in engineering these modules. First, the electrical design was carefully engineered to insure that all components operate well within their limits, under "worst case" operating conditions. Second, the thermal design, including case construction, was carefully made to insure that the maximum temperature limits of all components are never exceeded. Then the size and weight of these modules were controlled to a minimum, without sacrificing reliability. Finally these units were thoroughly tested to make certain that all design and performance specifications were met.

So, you can build your own power supply using our schematic diagram if you want to—but we think we can build it more

reliably and for less cost, simply because we have been doing it for ten years. Put our power supply in your system first and try it. Examine its performance. We think you will be pleasantly surprised at the quality, adherence to specifications, and the reliability you find in the Abbott Model "R"

Any output voltage from 5 to 100 volts DC with current from 0.15 to 20 amperes is available. **Many of the popular voltages are carried in stock for immediate delivery.** Please call us for attractive O.E.M. discount prices.

Abbott also manufactures 3,000 other models of power supplies with output voltages from 5.0 to 3,650 volts DC and with output currents from 2 milliamperes to 20 amperes. They are all listed **with prices** in the new Abbott catalog with various inputs:

- 60 A to DC, Hermetically Sealed
- 400 A to DC, Regulated
- 28 VDC to DC, Regulated
- 28 VDC to 400 A, 1 $\phi$  or 3 $\phi$
- 24 VDC to 60 A, 1 $\phi$

Please see pages 618 to 632 of your 1971-72 EEM (ELECTRONIC ENGINEERS MASTER Catalog) for complete information on Abbott modules.

**Send for our new 56 page FREE catalog.**

**abbott transistor**

**LABORATORIES, INCORPORATED**

5200 W. Jefferson Blvd./Los Angeles 90016  
(213) 936-8185

1224 Anderson Ave./Fort Lee, N.J. 07024  
(201) 224-6900

INFORMATION RETRIEVAL NUMBER 5

### Vice President, Publisher

Peter Coley

### Editors

Editorial Offices  
50 Essex St.  
Rochelle Park, N.J. 07662  
(201) 843-0550  
TWX: 710-990 5071  
Cable: Haydenpubs Rochellepark

**Editor-in-Chief:** George Rostky

### Managing Editors:

Ralph Dobriner  
Michael Elphick

### Associate Editors:

Jules H. Gilder  
Richard Lee Goldberg  
Morris Grossman  
Seymour T. Levine  
John F. Mason  
Stanley Runyon  
Edward A. Torrero  
Richard L. Turmail

### Contributing Editor:

Peter N. Budzilovich

### Editorial Field Offices

#### East

Jim McDermott, Eastern Editor  
P.O. Box 272  
Easthampton, Mass. 01027  
(413) 527-3632

#### West

David N. Kaye, Senior Western Editor  
2930 West Imperial Highway  
Inglewood, Calif. 90303  
(213) 757-0183

#### Washington

Heather David, Bureau Chief  
2506 Eye St., N.W.  
Washington, D.C. 20037  
(202) 338-3470

### Editorial Production

Marjorie A. Duffy

### Art

**Art Director, William Kelly**  
Richard Luce  
Anthony J. Fischetto

### Production

**Manager, Dollie S. Viebig**  
Helen De Polo  
Maxine Correal  
Anne Molfetas

### Circulation

**Manager, Nancy L. Merritt**  
Ron Deramo

### Information Retrieval

Peggy Long

### Promotion

**Manager, Jeffrey A. Weiner**  
Karen Kerrigan



## across the desk

### Printer/plotter article ruffles some feathers

The article "Need a Hard-Copy Peripheral?" (ED 18, Sept. 2, 1972, p. 54) should be useful to the prospective printer/plotter customer, but a potential buyer of an electrostatic plot device should consider several points not mentioned.

The electrostatic plotter is, by its design, limited to paper movement in one direction only. Thus a plot must be completely composed and stored prior to the output of the "picture"—not as coordinate pairs but as a binary bit for each spot. An 8 × 10-in. plot with 80/in. resolution requires 32,000 16-bit words of mass storage.

The "up to 10 seconds" figure quoted as time to produce a typical plot is apparently output time only. Not mentioned was the core-time required to convert program-supplied data into picture data—a factor not present in direct pen plotters. The inclusion of required compute time into this figure considerably reduces the time savings claimed for the electrostatic devices.

I recently completed a real-time software package for an electrostatic plotter/printer (the Varian Statos 21) on the CDC 1700. A comparison of start-to-finish times for this device and a standard direct pen plotter show time savings factors of from 5 to 10. Disc storage is used for picture data and plots over 200 in. long may be generated. The programming effort was extensive.

*Tom Markle*

Computer Sciences Corp.  
3065 Rosecrans Pl.  
San Diego, Calif. 92110,

### The author replies

Mr. Markle is correct in his general statements about generating plots on large computers for elec-

trostatic printer/plotters; however, other methods are available to generate plots. Both pen and electrostatic plotters require the same routines and computer time, except that pen-plotter routines must also include mechanical pen positioning instructions (pen up, down, etc.). But Mr. Markle's "core-time required to convert program-supplied data into picture data" can virtually be eliminated for electrostatic plotters. Varian has developed software for use in 16-bit mini-computers that sorts, by magnitude, the same vector-end-point data used by pen plotters, then converts the data to raster format and starts the output through an on-line electrostatic printer/plotter within a few seconds. This software can typically maintain plot output at rates comparable to 10 sec. for an entire 8-1/2 × 11-in. plot. Plot speed, of course, varies inversely with plot density. In addition Fortran vector generation routines are available to generate complete plots with a minicomputer of only 12-k memory.

The article "Need a Hard Copy Peripheral?" contains obvious factual errors and is laced with advertising in favor of electrostatics. The A.B. Dick Videojet series of ink-jet printers have been on the market since 1968. Models are available at 250 characters/sec. and 750 characters/sec. Both employ a single nozzle. These facts were ignored by the author, who would have your readers believe that single-jet devices are speed-limited at 100 characters/sec. and that less reliable, multiple-jet systems are needed to reach speeds of 200 characters/sec.

The author writes with equal "expertise" and accuracy about imaginary problems that plague jet systems. She alludes to environmental conditions that make lit-

*(continued on page 16)*

Electronic Design welcomes the opinions of its readers on the issues raised in the magazine's editorial columns. Address letters to Managing Editor, Electronic Design, 50 Essex St. Rochelle Park, N. J. 07662. Try to keep letters under 200 words. Letters must be signed. Names will be withheld on request.

# THIN-TRIM<sup>®</sup> CAPACITORS FOR HYBRID-CIRCUIT DESIGNERS



ACTUAL SIZE



**THIN-TRIM** capacitors are a new development in miniaturized variable capacitors for application in circuits where size and performance is critical. The Thin-Trim concept provides a variable device to hybrid circuit designers which replaces fixed tuning techniques and cut and try methods of adjustment.

#### FEATURES

- Low profile for HYBRID CIRCUIT applications.
- High capacity values for BROADBAND applications.
- High Q - low capacity values for MICROWAVE applications.

U.S. Patent 3,701,932

*Johanson*

MANUFACTURING CORPORATION

ROCKAWAY VALLEY ROAD  
BOONTON, N.J. 07005  
PHONE (201) 334-2676  
TWX 710-987-8367

containing  
electrical energy  
is a little more  
complex

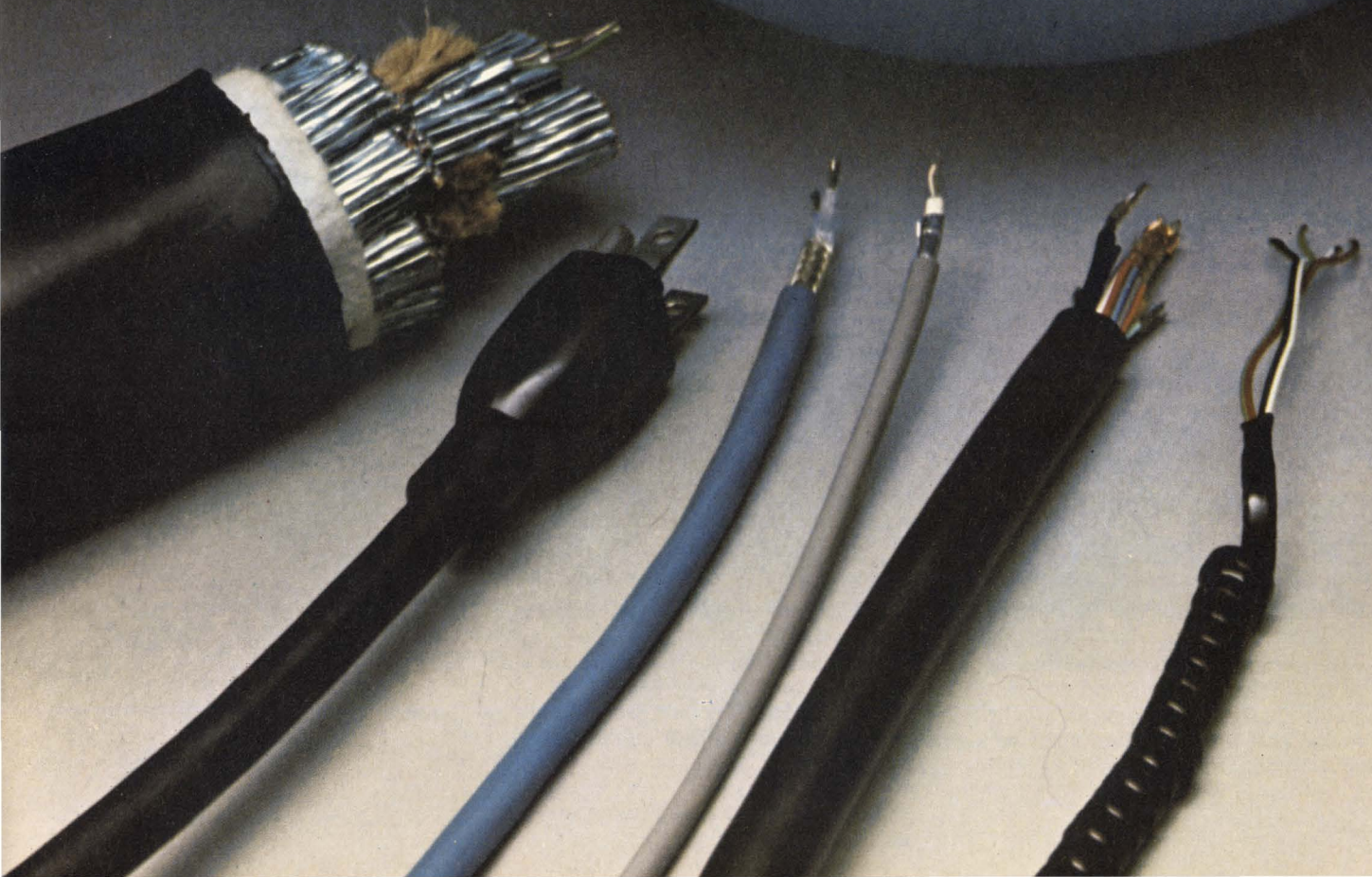

How a cable copes with the problems of voltage safety; frequencies; current; attenuation; capacitance; velocity of propagation; inductance; electrostatic and electromagnetic interference, depends heavily on what surrounds the conductors:

The coating, insulation, shielding, jacketing materials. And how they are applied. Belden has the ways and means. Material answers that can help you cope with both the electronic and physical environment your cable works in. The design and production know-how to give you the right combination of quality, reliability and performance your application demands.

Talk to your Belden wire specialist. He has more than 8,000 standard cable items to draw from. Knows what modifications are possible. What the tradeoffs are. The costs involved. He can give you a complete cable package tailored to your needs. You won't find a better source for know-how, understanding or results.

Write for a copy of the Belden Electronic Wire and Cable Catalog. Belden Electronic Division, P. O. Box 1100, Richmond, Indiana 47374. Phone (317) 966-6681.

8-5-2

INFORMATION RETRIEVAL NUMBER 234

**BELDEN**



We want your cable business  
and are out to prove...

Belden covers wire with performance,  
service and ingenuity

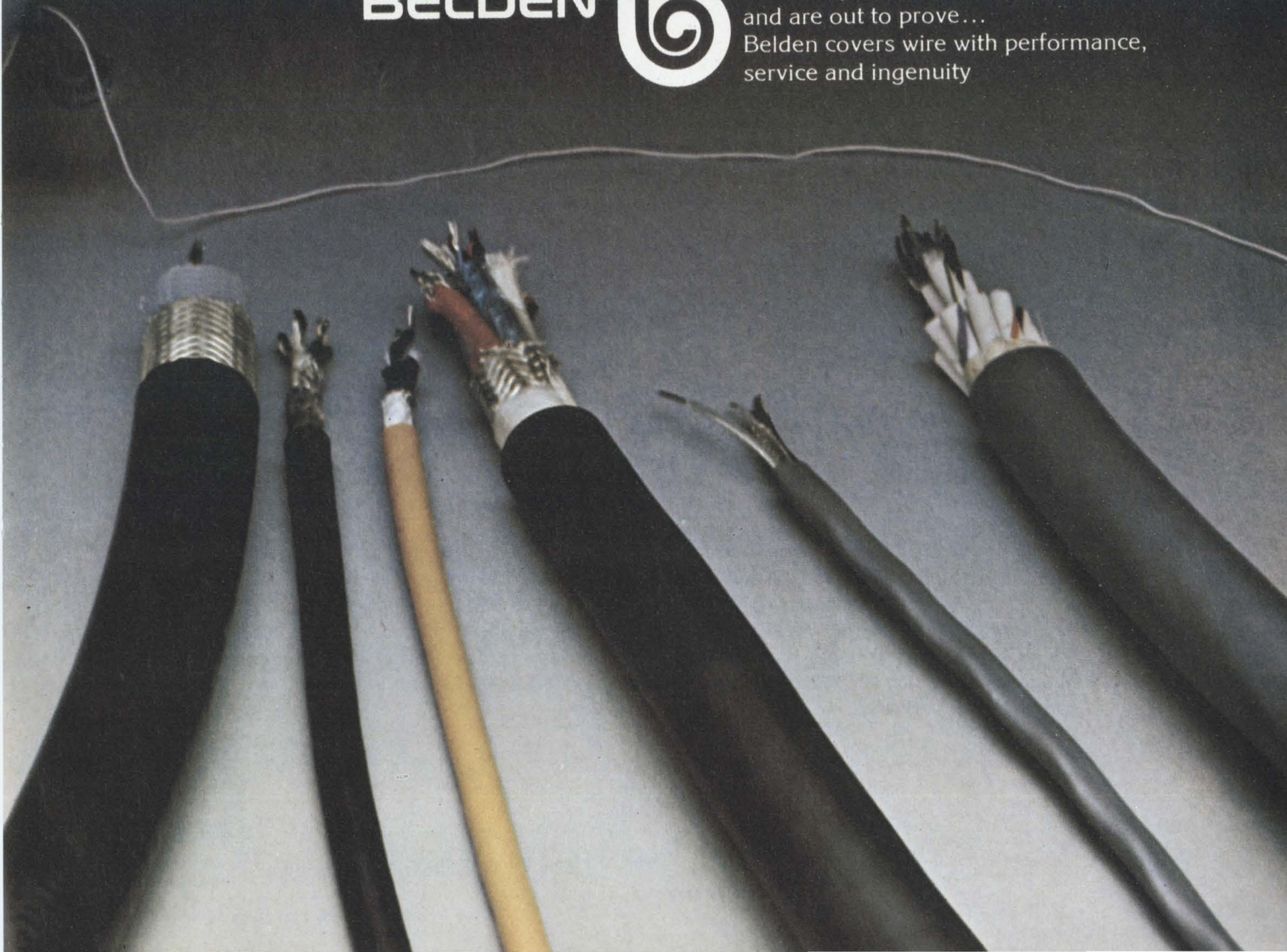

**If you thought you had an MPF headache...**

# calm down

No need to redesign! General Instrument's new MEM 620/621/622 Plastic RF MOSFETS are direct pin-for-pin replacements for our competition's MPF 120/121/122's.

And our MEM's offer superior performance, lower cost, and most importantly, are available now . . . and from now on. So, calm down.

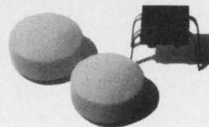

ACTUAL SIZE

If you're outside New York State and want an evaluation sample and data sheets (you won't need the aspirin), or if you want any information on the subject of MOSFETS, ours, or other people's, call

# 800-645-1247 [TOLL FREE]

If you're in New York State call collect: 516-733-3037 or write: Dept. MOST, General Instrument Corporation, 600 West John Street, Hicksville, N.Y. 11802, or call, in New York: 516-733-3333; in Chicago: 312-338-9200; in Los Angeles: 213-641-7411. In Canada, call or write: General Instrument Canada, Ltd., 61 Industry Street, Toronto 337, Ontario, Canada, Tel: 416-763-4133. In Europe, write: General Instrument Europe S.P.A., Piazza Amendola 9, 20149 Milano, Italy. In the U.K., write General Instrument Microelectronics Ltd., 57/61 Mortimer Street, London, W1N7TD, England: In the Far East, write General Instrument of Taiwan Ltd., P.O. Box 22226, Taipei, Taiwan.



GENERAL INSTRUMENT CORPORATION • 600 WEST JOHN STREET, HICKSVILLE, L. I., NEW YORK

INFORMATION RETRIEVAL NUMBER 7

INFORMATION RETRIEVAL NUMBER 8 ►

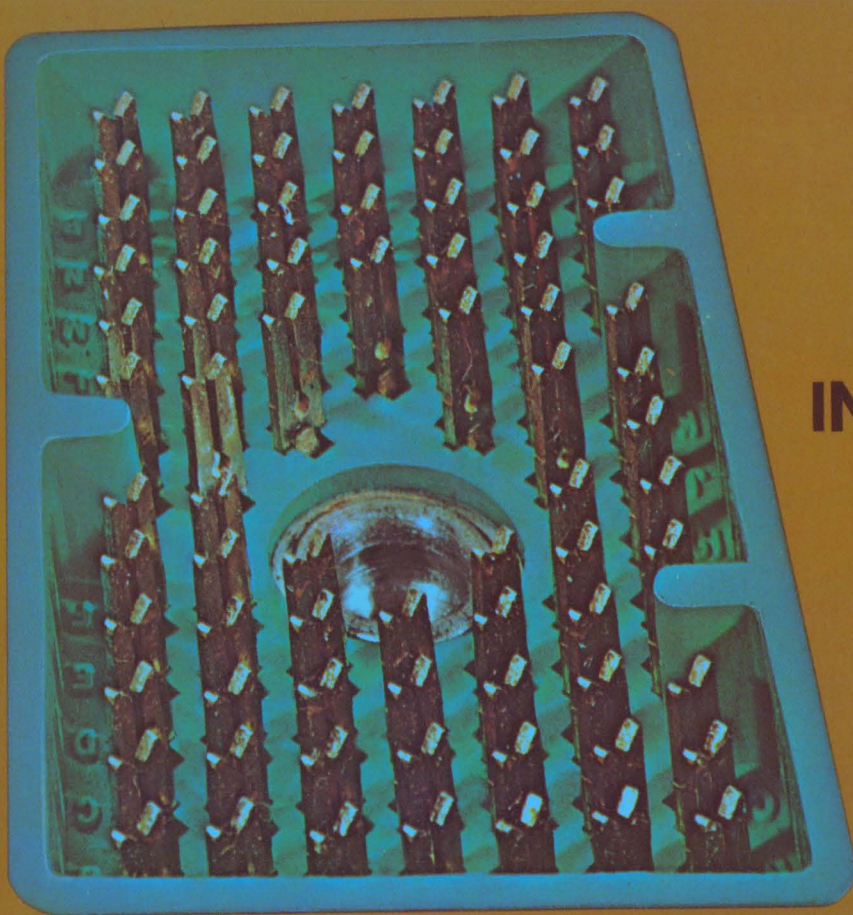

## PACKS TWICE THE CONTACTS IN THE SAME SPACE AT ABOUT HALF THE COST

Elco's solution to the escalating packaging squeeze and packaging costs in electronic circuitry. A line-up of I/O rack and panel and cable-to-cable connectors with contact spacing on .100" and .125" centers.

On a performance/price basis, these high density connectors are your best buy. Quality is equal to or better than, and published prices are much less than those of their pin-and-socket counterparts.

Take the Series 8026 R/P and cable-to-cable connector that's equipped with the Elco high-reliability crimp-and-insert mini Varilok™ contact. Team a Series 8026 117-contact plug with its corresponding receptacle, and you have a 117-contact connector that's in the same envelope as a 56-contact connector on .150" spacing. But packing more than twice the contacts in the same space.

The 75-contact 8026 connector will fit in the same space as a 38-contact connector on .150" spacing. And the 8026 33-contact connector is one of the smallest 33-contact R/P connectors you've ever seen. For back-up, we offer Series 8026 connector with 55 and 79 contacts on .125" square grid.

For full details on these new connectors from Elco, contact your local Elco representative or distributor, or: Elco, Willow Grove Division, Willow Grove, Pa. 19090 (215) 659-7000 • Elco, Pacific Division, 2200 Park Place, El Segundo, Calif. 90245, (213) 675-3311.

For your I/O back-panel applications, Elco Series 5540 connectors are available in the same sizes as the 8026, but use the field-proven Varicon™ contact with .025" square wire-wrappable posts. They incorporate—as do the 8026's—a new female turnable jackscrew that eliminates any possibility of damage to plate contacts in difficult or blind mating situations. Both series use standardized polarizing hardware and keying hardware to prevent unmatched plugs and receptacles from being mated.

And by no small coincidence, hardware standardization and using one contact for both sides lets you minimize your in-house and field stocking requirements, and allows you to use the same manufacturing set-up to assemble all sizes.

Besides helping you cope with your close-order circuits, these connectors will help you effect other cost economies. Like using your existing 8016 panel punches. Reducing inventory because they can do duty in R/P and cable-to-cable applications as well as be used as an I/O.

There's one more bonus. Immediate availability. Both series. All sizes. Another service in keeping with CONNECTRONICS, Elco's Total Connector Capability.

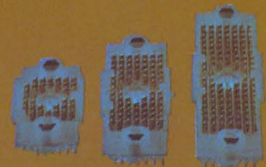

Series 5540 input-output plate receptacles with or without polarizing hardware. On .100" grid with 33, 75 and 117 contacts. On .125" grid with 55 and 79 contacts.



Polarizing hardware provides 36 polarization combinations per connector pair.

Metal covers for 33, 55, 75, 79 and 117-contact connectors have top and side cable entries.

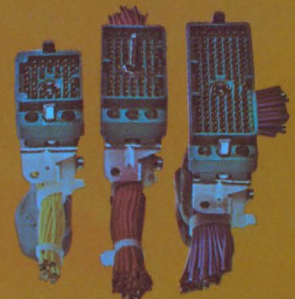

Cable strain relief clamps are adjustable for small and large cable bundles, can be mounted on plug and/or receptacle.



# ELIMINATE RESISTOR STOCKPILES

## WITH... BOURNS

# SFR™

### SELECTABLE FIXED RESISTOR\*

## 90 SELECTABLE RESISTANCE VALUES IN 1 TINY UNIT.

Model  
4002

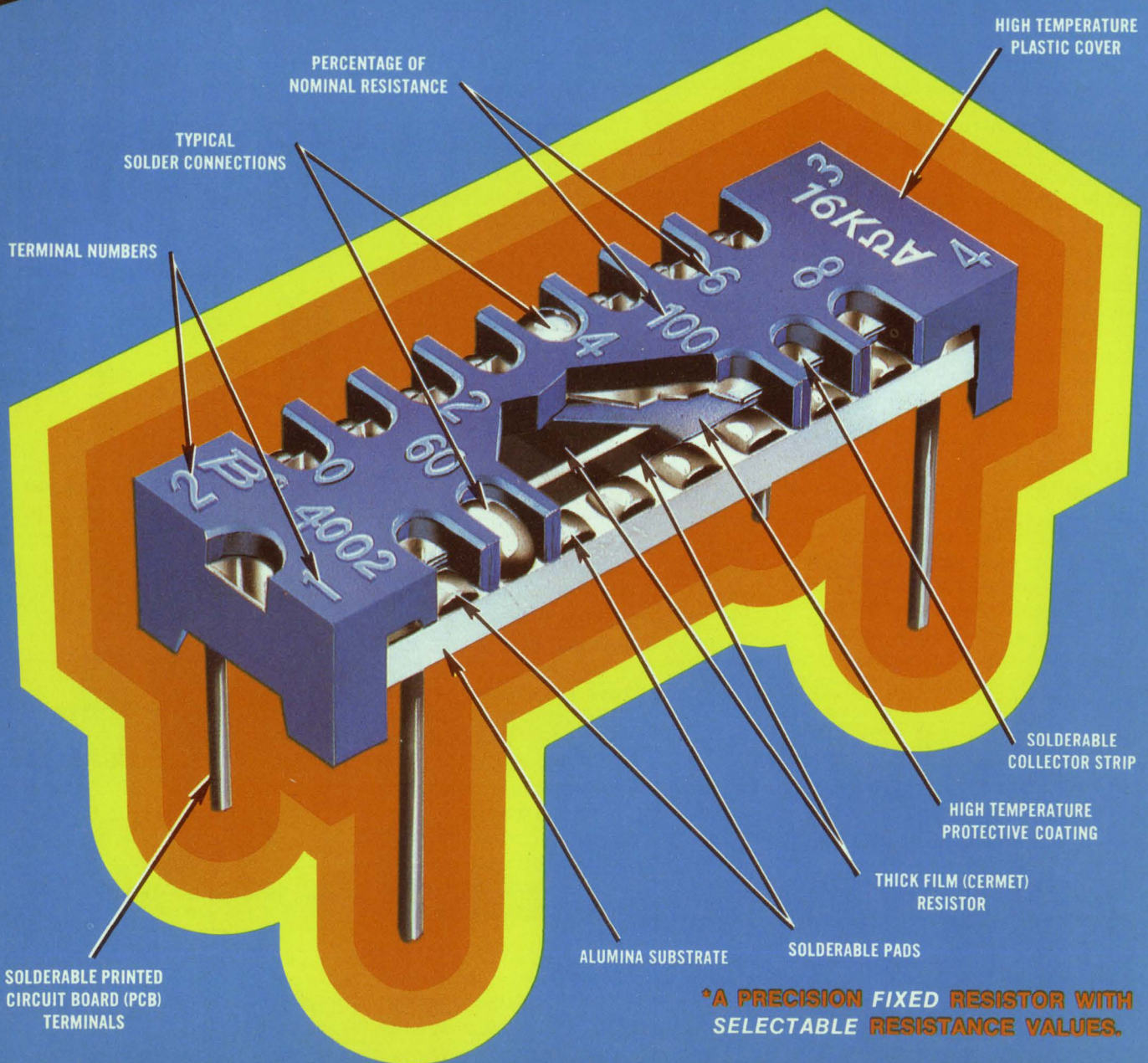
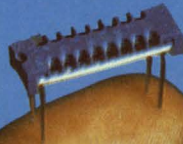

\*A PRECISION FIXED RESISTOR WITH SELECTABLE RESISTANCE VALUES.

# BOURNS NEW... UNIQUE CONCEPT IN RESISTIVE COMPONENTS ALSO OFFERS

- \* 33 ohm to 1.25 megohm combined resistance range over 15 units
- \* Selectability within  $\pm 1\%$  of required resistance value over the entire range

**BOURNS**  
**SFR**<sup>TM</sup>  
SELECTABLE FIXED RESISTOR

- ... IS A STABLE, THICK-FILM, FIXED RESISTOR WITH ADJUSTABILITY OF  $\pm 1\%$  OR BETTER
- ... REPLACES STANDARD FIXED RESISTORS IN APPLICATIONS WHERE FINAL RESISTANCE VALUE REQUIRED CAN'T BE PRECISELY DETERMINED AT THE DESIGN STAGE
- ... REPLACES "ONE-TIME ADJUST" VARIABLE RESISTORS IN APPLICATIONS REQUIRING LONG-TERM STABILITY
- ... RESISTANCE VALUE IS SELECTED, THEN PERMANENTLY, RELIABLY SET BY SOLDERING

## LOOK AT THE \$\$ YOU SAVE ON INVENTORY!!

**FOR EXAMPLE:** Your application requires selection of individual resistance values from 550 ohms to 1000 ohms, or 40 different resistors at 10¢ each. One Model 4002 provides the same resistance selection within  $\pm 1\%$  at 76¢\*.

Result: 40 different resistor values: 40 x 10¢ = \$4.00  
One Model 4002: 1 x 76¢ = .76

**YOU SAVE... \$3.24!!**

\* 1,000 piece quantity price U.S. dollars, F.O.B., U.S.A.

*it's easy to use*

After mounting on PCB; probe the COARSE and FINE adjustment taps (Figures 1 and 2) to determine the precise resistance required. Solder the selected taps (Figure 3) and the SFR RESISTOR is permanently set.

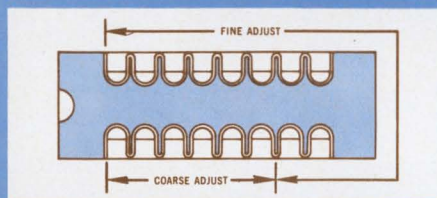

Figure 1



Figure 2

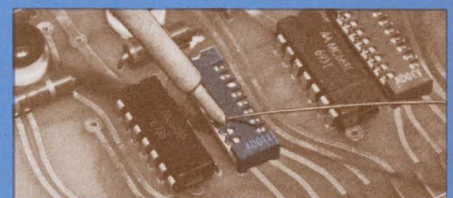

Figure 3

FOR COMPLETE DETAILS AND A BROCHURE:

- CALL SFR RESISTOR SALES COLLECT (714) 781-0270
- CONTACT YOUR LOCAL BOURNS REPRESENTATIVE.

FOR A FREE SAMPLE... write to the factory answering the following on your company letterhead.

- (a) My application for the Bourns SFR Resistor is . . .
- (b) It will replace (number) of fixed resistors in my inventory
- (c) Approximate anticipated annual quantity usage: (number)



"SFR" is a trademark of Bourns, Inc. Patents Pending

BOURNS, INC., TRIMPOT PRODUCTS DIVISION • 1200 COLUMBIA AVE., RIVERSIDE, CALIF. 92507

INFORMATION RETRIEVAL NUMBER 9

# New from Amphenol's Spectrum

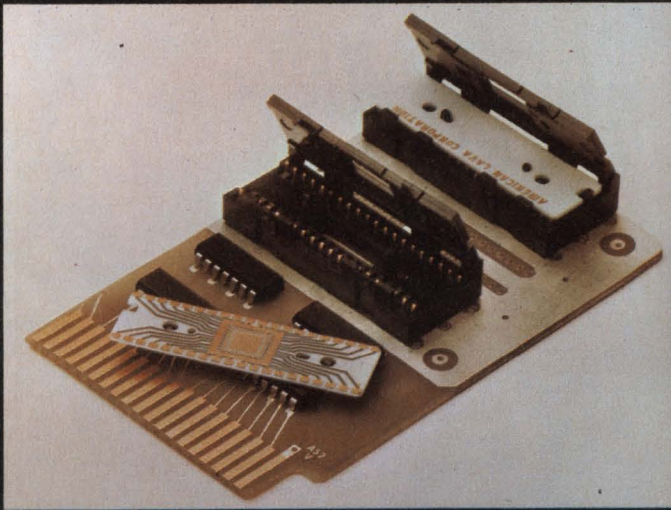

**level 1** MOS/LSI Planar Plug-In connectors (above) for leadless, flat mount ceramic substrates. Permits fast, easy replacement of IC package, no screws, has snap-down lid. ■ Free-standing terminal (below) terminates IC's to PC boards for lowest total systems cost.

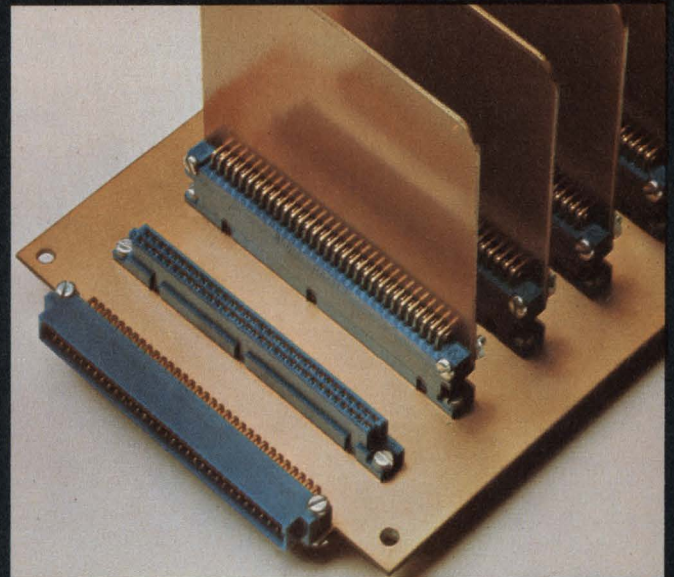
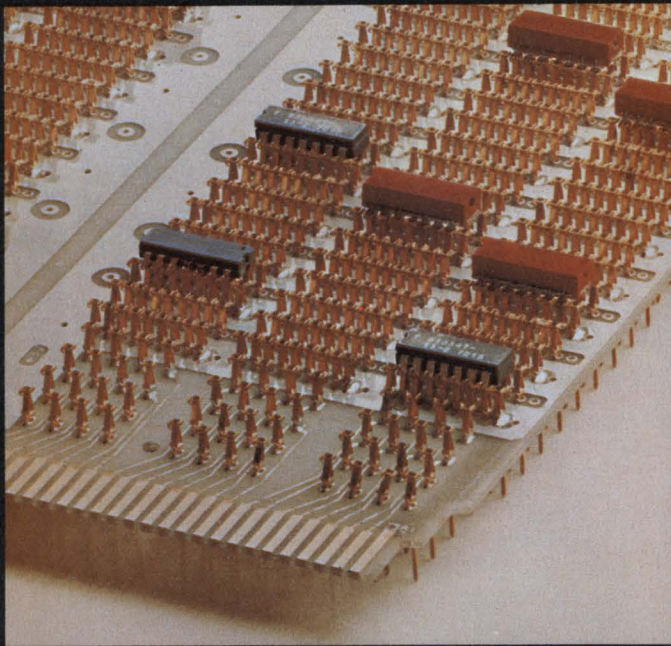

**level 2** Box contact connectors (above) intermate with .025" square or round contacts. Low insertion force. Terminations for crimp, wire wrapping or wave solder. ■ Zero insertion force connectors (below) improve PC board and connector life by eliminating strain and wear.

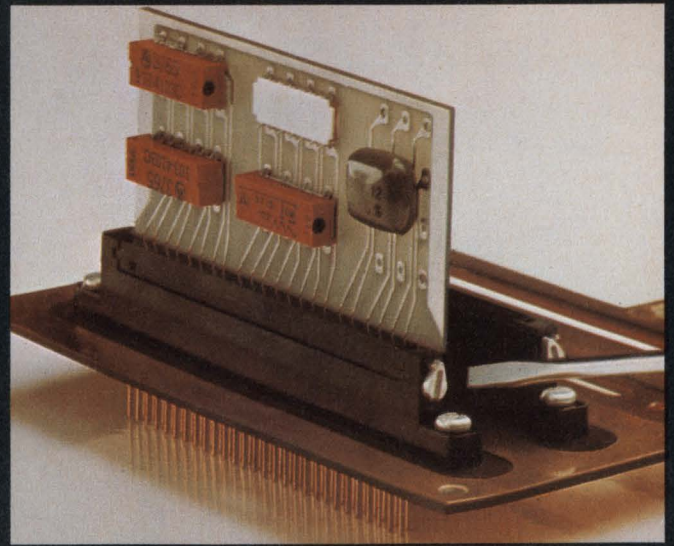

Above are seven new ideas from Amphenol Industrial Division's Spectrum of interconnection capability.

Amphenol's SPECTRUM offers you *all four* levels of interconnections from our unmatched breadth of product line:

**Level 1 . . . DEVICE TO BOARD OR CHASSIS.** We offer interconnections for components such as tubes, relays, transistors, IC packages, trimmers, resistors or capacitors to a PC board or chassis.

**Level 2 . . . BOARD TO MOTHERBOARD OR BACK PLANE.** We offer interconnections for PC boards or

other sub-circuit modules to a motherboard or to a back plane.

**Level 3 . . . MOTHERBOARD OR BACK PLANE WIRING.** We offer interconnections for levels to each other and to other sub-circuits with multi-layer circuit boards, wire wrapping, clip terminations, jumper techniques and dip-soldering.

**Level 4 . . . INPUT/OUTPUT CONNECTIONS.** We offer interconnections for power and signals to and from a system. This interface may be between sub-assemblies within the same enclosure or between individual units.



# of interconnections.

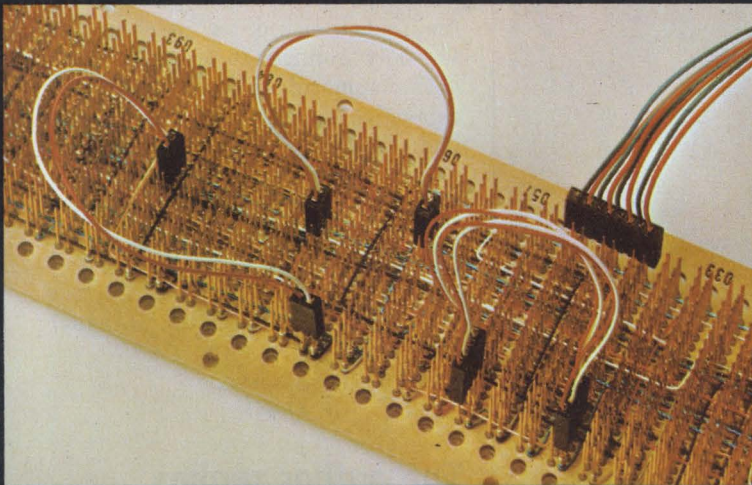

level **3**

Low cost strip connectors (above) are used as jumpers in back plane wiring. Intermates with .025" square or round posts. ■ Circuit Concentration Bay (below) consists of wire wrappable panels that are five times as compact as the telephone distribution frames they replace.

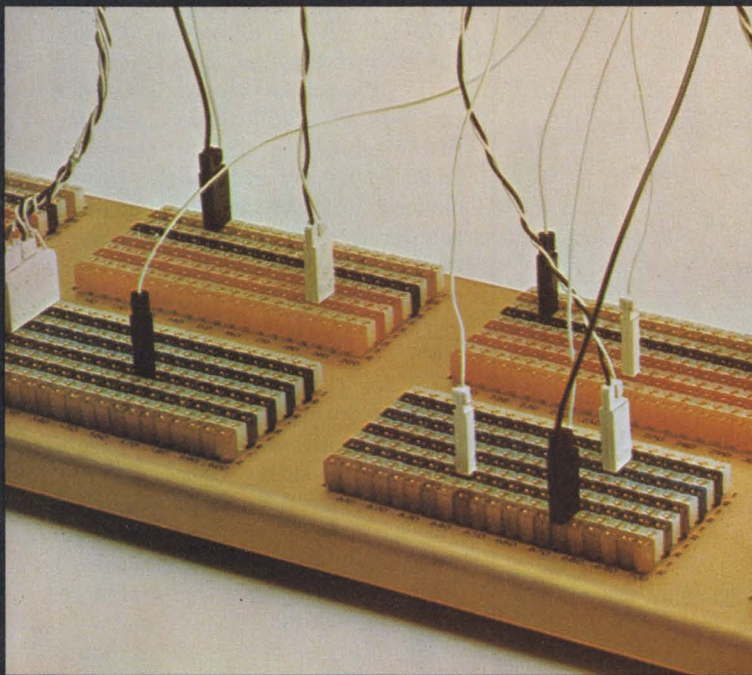

level **4**

Modular Integral Connector concept lets you make your own pin & socket connector to fit your needs. Five contact sizes, thousands of combinations. Sufficient components for six connectors in handy MIC-KIT. Design and assemble your own prototypes.

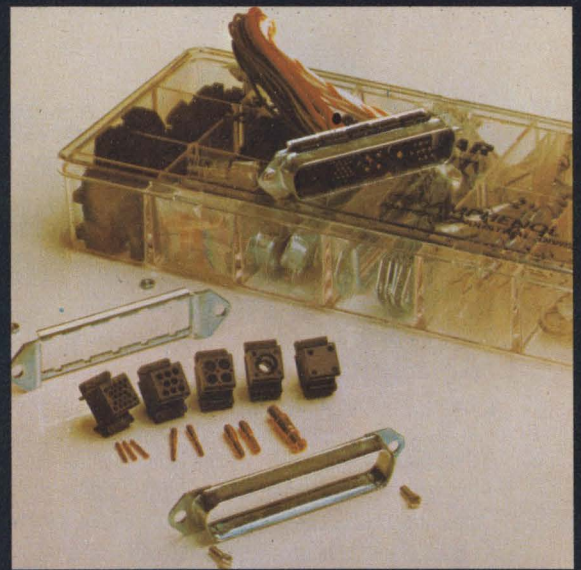

From the simple tube socket—to a myriad of electrical/electronic connectors—to complete and complex termination systems . . . SPECTRUM.

But SPECTRUM is far more than products. It is a depth of capability in engineering, manufacturing and quality control. Amphenol's SPECTRUM is a new height of service, availability and distribution backed by seven Amphenol interconnection-oriented divisions.

Amphenol can fulfill your total interconnection requirements because we are not limited to specifics such as one or two product lines, one or two levels.

Therefore we approach your interconnection needs with complete open-mindedness.

For more new ideas and specific information, write for your copy of "SPECTRUM." Amphenol Industrial Division, Bunker Ramo Corp., 1830 South 54th Ave., Chicago, Illinois 60650.

**BUNKER  
RAMO**

**AMPHENOL**

*(continued from page 7)*

tle sense—for example, “humidity can shift dots”—and are not experienced in the field. She ignores the fact that ink-jet printers are the only nonimpact printers available commercially that utilize inexpensive and widely available plain paper. She conveniently glosses over the disadvantages of electrostatics—proprietary paper that is expensive and needs a liquid for image developing.

*George E. Marton*  
Marketing Manager

A.B. Dick Co.  
5700 W. Touhy Ave.  
Chicago, Ill. 60648.

### The author replies

No specific Videojet information was at my disposal when the article was written. A very recent article from *IEEE Transaction on Computers* (Ernbo, Arne, September, 1972, No. 9, Vol. c-21, pp. 942-947) only hints at speeds of 250-750 characters/sec. for single jet units. Therefore my article rated ink jets at 15-300 characters/sec. in the table on p. 59. But the higher speed hardly affects the ink-jet devices' relative over-all position compared with the other techniques. Not delving into Videojet details—which is obviously state of the art—was surely an oversight on my part.

As for those “imaginary” problems plaguing jet systems, CRT-type aberrations and air-current-induced dot shifts were very real to members of Varian's engineering staff who viewed them—admittedly on another manufacturer's device, an Inktronic unit—at a recent trade show.

Mr. Marton is correct in pointing out that the article failed to mention that ink-jet devices can use inexpensive, plain paper.

*Jill Peters*

Varian Data Machines  
611 Hansen Way  
Palo Alto, Calif. 94303.

### The joys of starting a company extolled

Congratulations on the editorial “Get Enriched (If Not Rich) with  
*(continued on page 21)*

## When it comes to Synchro Converters, if we don't make it... you won't find it.

Fact is, we've got the broadest line of synchro converters on the market. Single and “building-block” modules with errorless tracking . . . single and multi speed converters of high resolution . . . multiplexed converters going D/S or S/D . . . synchro to linear converters . . . DC angle or invariant sin/cos. Chances are, the very device you need is sitting right here on the shelf. But let's face another fact. Could be, you've got a problem application that a standard product won't meet. That's where our technical staff comes in. Ready to work with you. To design an individual module, or a total system to solve your digital or analog interface requirement. And more times than not, simple modification of existing products will do the job.

You see, if we don't have it, we'll make it. That's the attitude that made us “Number One” in the Synchro Conversion field.

For product or technical applications information, write or call Steve Muth or Jim Sheahan. They're engineers, so they talk your language.



**ILC DATA DEVICE CORPORATION**

100 TEC STREET, HICKSVILLE, N. Y. 11801 • PHONE: (516) 433-5330



## Just born. The littler trimmer.

### Meet our new microminiature ceramic variable capacitor.

It provides maximum adjustable capacity for a given size—plus high reliability at low cost.

The DVJ5014 trimmer, with a height of .070 inches above the mounting surface, is only .245 inches in diameter yet matches the electrical performance of other capacitors many times its size. This trimmer features a slotted adjustment head.

Also available is the DVJ5009 series (with a height of only .045 inches above the mounting surface) featuring a flush adjustment head. In applications where cost rather than height is the prime consideration, use of the DVJ5014 is recommended.

Rotors for both models are constructed with a monolithic embedded electrode in a special pro-

prietary ceramic material and a stator body made from high alumina ceramic. These features provide a larger  $\Delta C$ , and higher reliability than previously available, as well as complete environmental stability.

The new JFD microminiature ceramic variable capacitors are well suited for printed or hybrid circuit mounting as well as other applications involving ceramic substrates, microminiature crystal oscillators, stripline assemblies, multiplex transceivers, telemetry oscillators and transmitters, frequency multipliers, and other subminiature electronic circuits.

That's quite a lot for a little trimmer.

Why trade off performance to get lower prices? For full details write or call us or your local JFD field engineer.

Model	ACTUAL SIZE	DVJ5014 Capacitance Picofarads Min.-Max.
DVJ5009/10		
DVJ5014/10		3-10
DVJ5009/15		
DVJ5014/15		3.5-15
DVJ5009/20		
DVJ5014/20		4-20
DVJ5009/30		
DVJ5014/30		5-30

No special tools required for adjustment.

# JFD

A Rikar-Maxxon Subsidiary  
**JFD Electronics Corporation**  
 18th Ave. at 82nd Street  
 Brooklyn, N.Y. 11219  
 Phone (212) 831-1000

# As components become more sophisticated, the versatility of silicones is more evident.

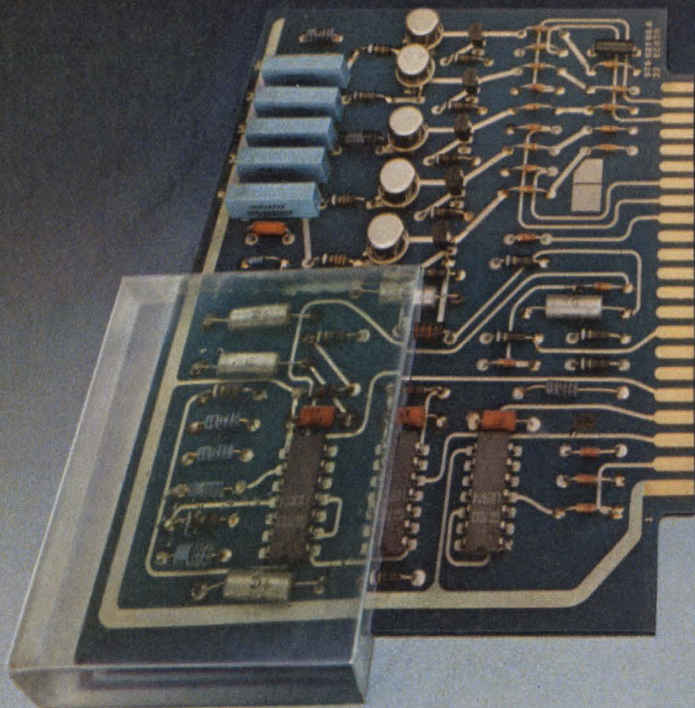

For see-through protection, encapsulate with this clear, resilient silicone resin. Self-extinguishing, it guards against humidity, heat, cold, radiation, thermal shock and vibration. Information retrieval number 221.

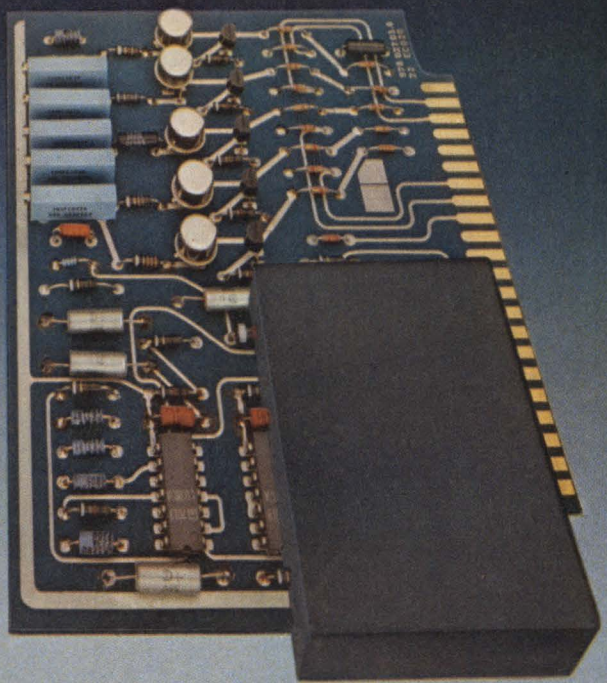

For added safety, specify this flame-retardant, pourable silicone elastomer. Uses for this low-cost packaging material include coating, potting and encapsulating. Information retrieval number 222.

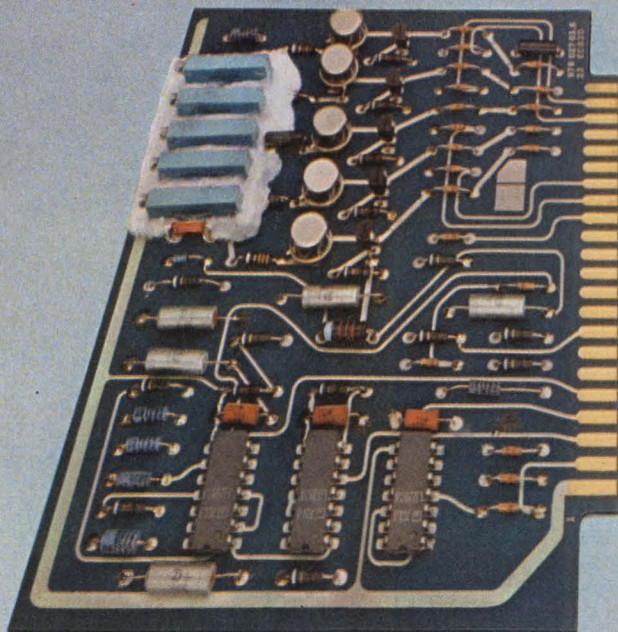

For excellent adhesion to corrosion-prone metals such as copper, use this new noncorrosive, one-part Dow Corning sealant. Cure mechanism produces no exothermic heat or acetic acid. Information retrieval number 223.

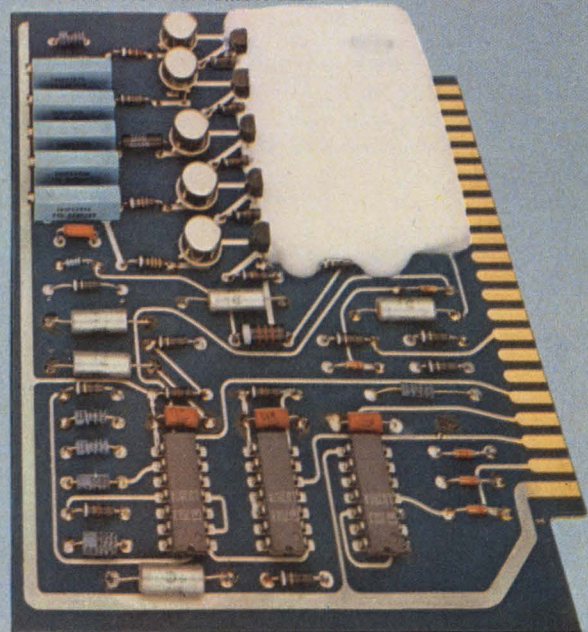

For protection against moisture, dirt, ozone, radiation and many solvents and chemicals, select this conformal coating. It flows on easily and cures at room temperature to a tough silicone rubber with excellent dielectric properties. Information retrieval number 224.

Silicones are unusual in the number of ways they protect. They resist change in hostile environments where other materials are unstable. They have excellent dielectric properties. With the electronic industry's concentration on higher performance and smaller components, the application areas where only silicone materials

can ensure design integrity have increased dramatically. Here are some of the newest examples. Many others are described in our Silicone Electronic Materials brochure available from your Dow Corning distributor. His name appears on the following page. Or write Dept. A-2202, Midland, Michigan 48640.

*Electrical/electronic materials from*

**DOW CORNING**

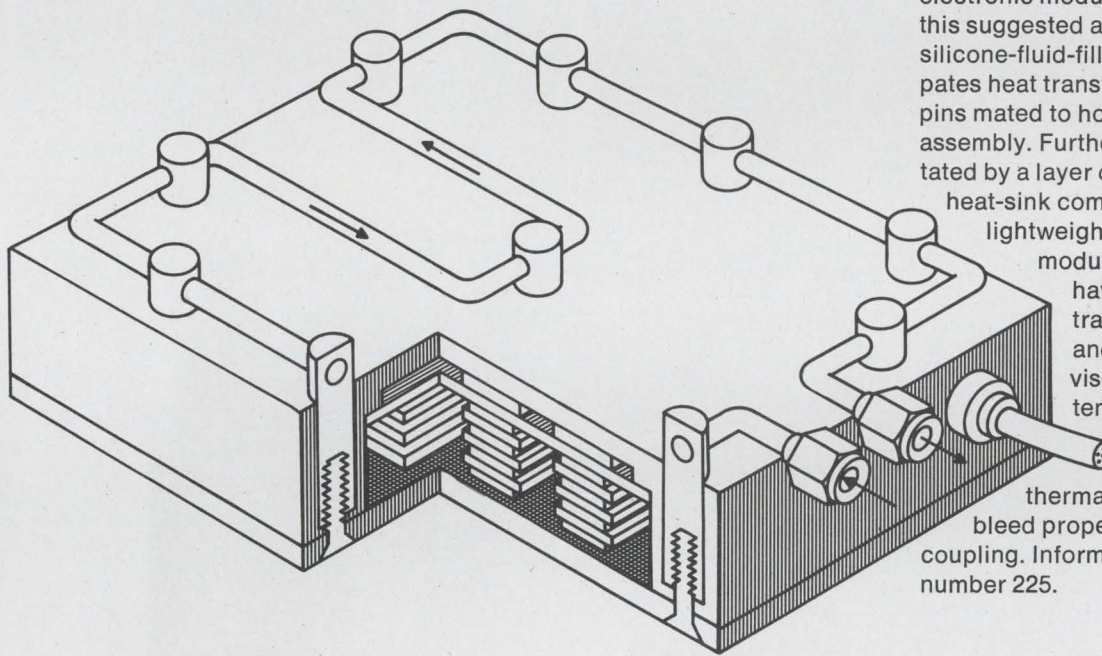
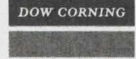

**Silicones for cooling high-density modules.** More efficient cooling of electronic modules is possible with this suggested assembly design. A silicone-fluid-filled coolant tube dissipates heat transferred to it from dowel pins mated to holes in the module assembly. Further conduction is facilitated by a layer of Dow Corning® heat-sink compound between a lightweight cold plate and module base. Silicone fluids have excellent heat-transfer properties and maintain constant viscosity over a wide temperature range. The heat-sink compound has high thermal conductivity and low bleed properties for long-term coupling. Information retrieval number 225.

**Silicones add durability to Ominimite\* transducer.** This magnetostrictive device converts electrical energy into sound for ultrasonic cleaning systems. It is insulated with Dow Corning silicones. Bendix Instruments and Life Support Division uses coil forms fabricated from a Dow Corning silicone resin bonded glass laminate. Finished coils are dipped in Dow Corning® 997 varnish and baked. Silicones help add the physical and electrical stability required for long-term performance. Information retrieval number 226.

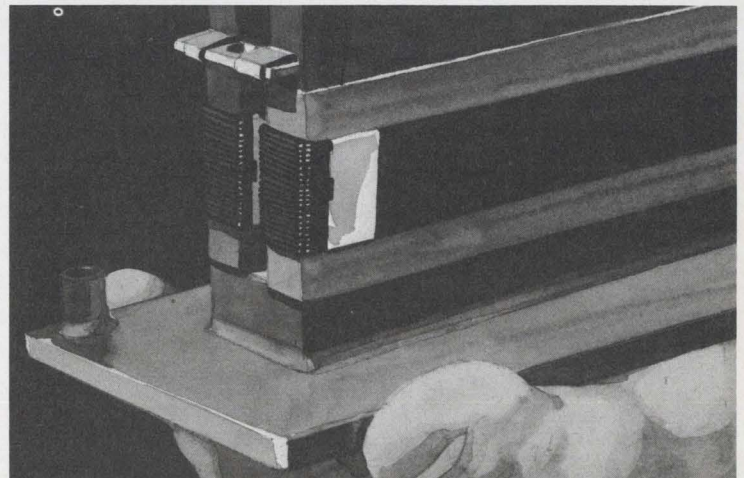

\*TM, Bendix Corporation

# This is no time for popcorn noise...

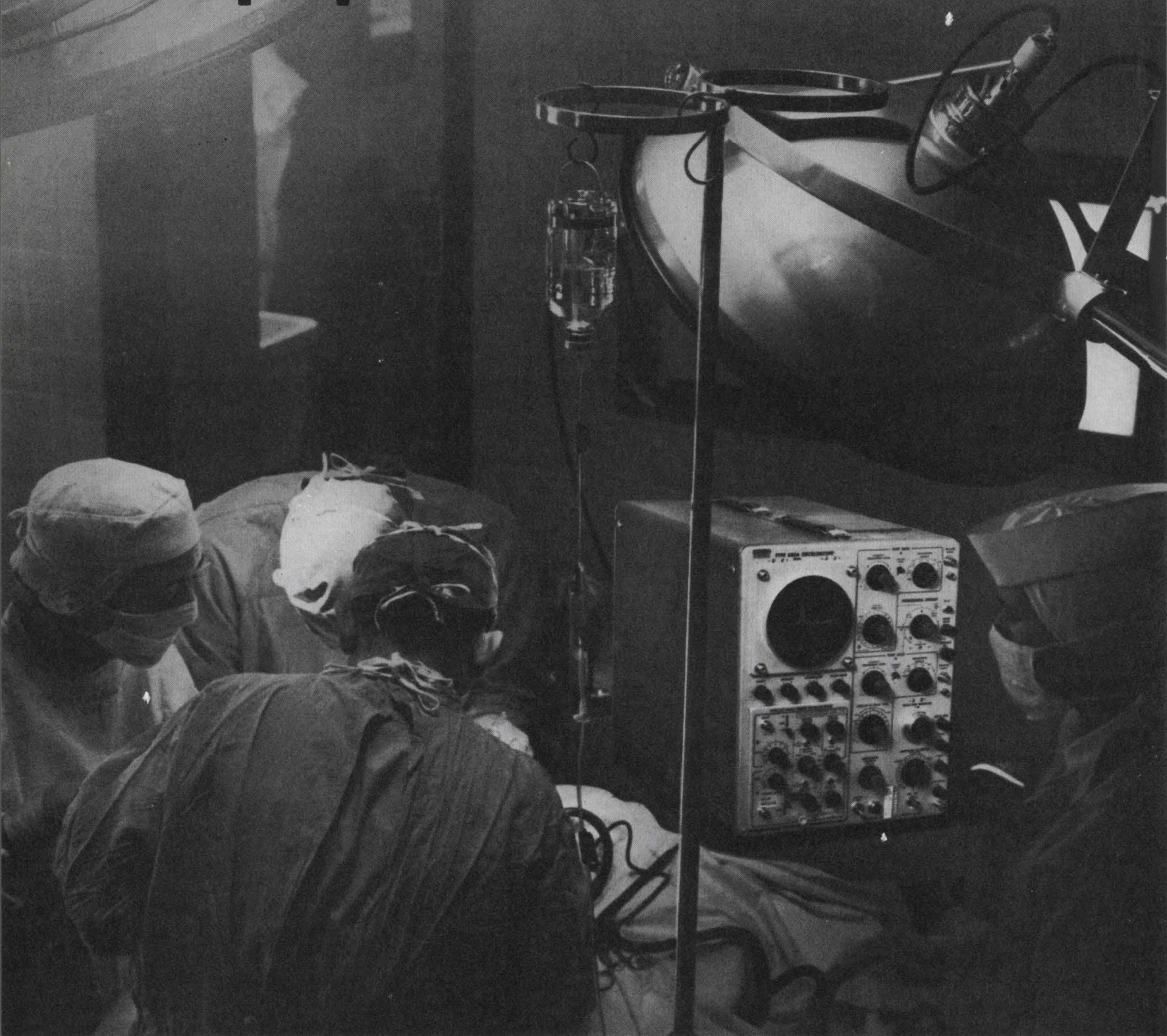

In fact, no time is acceptable for Popcorn (burst) noise, if you're designing a system to handle extremely small signals.

So RCA is announcing a new micropower, low noise operational amplifier. It's a designer's dream.

Our unique process gives you a monolithic silicon op amp that not only exhibits low burst noise but operates from a single 1.5-volt cell with a power consumption of 1.5 microwatts.

How low is the noise? Every CA6078AT op amp that leaves RCA must operate with equivalent

input burst noise less than 20uV (peak) at  $R_s=200,000$  ohms.

That's not all, the CA6078AT features output short-circuit protection through built-in output resistors, input voltage range ( $\pm 15V$  max. for  $\pm 15V$  supply) wide dif-mode range ( $\pm 6V$ ), and low offset-voltage nulling capability.

So go ahead! Design the CA6078AT into your system...and relax. Because you can be certain that with the new RCA micropower op amp, no time is acceptable for popcorn (burst) noise.

Want more data on the  
INFORMATION RETRIEVAL NUMBER 192

CA6078AT or CA3078AT (the low cost version of the CA6078AT for less critical applications) or the CA6741T, RCA's low-burst-noise 741? See your RCA Representative or Distributor and ask for Technical Bulletins, File No. 530 and 592 and Application Note ICAN-6732. Or write RCA Solid State, Box 3200, Somerville, N.J. 08876. Phone (201) 722-3200.

**RCA** Solid State  
products that make products pay off

# Silicone Protectors

A full line of silicone encapsulating, insulating, sealing, coating and dielectric materials is available from Dow Corning Distributors at the following warehouse locations:

## ALABAMA

**Birmingham**  
Electrical Insulation Suppliers  
205 252-9046  
**Mobile**  
Brownell Electro, Inc.  
205 479-5405

## ARIZONA

**Phoenix**  
Essex International Inc.—IWI Div.  
602 278-8568

## CALIFORNIA

**Berkeley**  
C. D. LaMoree  
415 841-0601  
**Culver City**  
E. V. Roberts & Associates, Inc.  
213 870-9561  
**Gardena**  
Specialized Products Co.  
213 532-1230—213 770-8186  
**Los Angeles**  
Essex International Inc.—IWI Div.  
213 264-7000  
C. D. LaMoree  
213 225-5666  
Brownell Electro, Inc.  
213 532-1150  
**Mountain View**  
K. R. Anderson Company, Inc.  
415 961-6007  
**San Diego**  
A. E. Yale Enterprises  
714 296-6148  
**San Francisco**  
Essex International Inc.—IWI Div.  
415 626-5351

## COLORADO

**Denver**  
Waco Enterprises, Inc.  
303 322-7708

## FLORIDA

**Orlando**  
Cramer/Florida, Inc.  
305 841-1550  
Brownell Electro, Inc.  
305 424-5634  
Electrical Insulation Suppliers, Inc.  
305 855-7100  
**Tampa**  
Essex International, Inc.—IWI Div.  
813 245-1651

## GEORGIA

**Atlanta**  
Electrical Insulation Suppliers, Inc.  
404 355-1651  
Essex International Inc.—IWI Div.  
404 691-8520  
**Chamblee**  
Prehler Electrical Insulation  
404 451-4266  
**Hapeville**  
Brownell Electro, Inc.  
404 762-5181

## ILLINOIS

**Chicago**  
Prehler Electrical Insulation  
312-384-6100  
**Mt. Prospect**  
Magnuson Electronics, Inc.  
312 956-0700  
**Niles**  
Essex International Inc.—IMC/IWI Div.  
312 647-0044

## INDIANA

**Fort Wayne**  
Essex International Inc.—IWI Div.  
219 742-7441  
**Hammond**  
Electric Supply Corp.  
219 932-8840

## IOWA

**Marion**  
EnSCO Distributing Corporation  
319 377-6313

## KENTUCKY

**Louisville**  
E & H Electric Supply  
502 587-0991

## LOUISIANA

**New Orleans**  
Williamson Distributing Corp.  
504 486-5584  
**Shreveport**  
Williamson Distributing Corp.  
318 424-6638

## MARYLAND

**Baltimore**  
Essex International Inc.—IWI Div.  
301 644-0140  
Pytronic Industries, Inc.  
301 539-6525

## MASSACHUSETTS

**Cambridge**  
Brownell Electro, Inc.  
617 864-7500  
**Newton**  
Cramer Electronics, Inc.  
617 969-7700  
**Peabody**  
Essex International Inc.—IWI Div.  
617 531-7100

## MICHIGAN

**Detroit**  
Essex International Inc.—IMC/IWI Div.  
313 921-6000  
**Madison Heights**  
McNaughton-McKay Electric  
313 399-7500  
**Southfield**  
Sheridan Sales Co.  
313 358-3333

## MINNESOTA

**St. Paul**  
Magnuson Electronics, Inc.  
612 227-8495  
Prehler Electrical Insulation  
612 622-1541—612 622-1542

## MISSOURI

**Kansas City**  
Essex International Inc.—IWI Div.  
816 842-1613  
**St. Louis**  
EnSCO Distributing Corp.  
314-542-3935  
Essex International Inc.—IWI Div.  
314 371-2616

## NEW JERSEY

**Livingston**  
Robert McKeown Co., Inc.  
210 922-0700 or 212 267-9264 (NYC)  
**Moonachie**  
Essex International Inc.—IWI Div.  
201 641-4400 or 212 695-7495 (NYC)  
**North Bergen**  
Electrical Insulation Sales  
201 864-2376 or 212 564-6273 (NYC)

## NEW MEXICO

**Albuquerque**  
Waco Electronics, Inc.  
505 268-2409  
Williamson Distributing Corp.  
505 344-3564

## NEW YORK

**Buffalo**  
Summit Distributors, Inc.  
716 884-3450  
**New York City**  
Brownell Electro, Inc.  
212 619-7900 or 212 924-6000

## NORTH CAROLINA

**Charlotte**  
Brownell Electro, Inc.  
704 394-4341  
Electrical Insulation Suppliers, Inc.  
704 392-2306  
Essex International Inc.—IWI Div.  
704 394-1315  
**Winston-Salem**  
Cramer/E. W. Winston-Salem  
919 725-8711

Electrical / electronic materials  
from

# DOW CORNING

DOW CORNING

## OHIO

**Cincinnati**  
Cramer/Tri States, Inc.  
513 771-6441  
Electrical Insulation Suppliers, Inc.  
513 771-4073  
Sheridan Sales Co.  
513 761-5432  
Essex International Inc.—IMC/IWI Div.  
513 771-6500  
**Cleveland**  
Essex International Inc.—IMC/IWI Div.  
216 781-2310  
Prehler Electrical Insulation  
216 267-2650  
Sheridan Sales Co.  
216 524-8210  
**Columbus**  
McGraw-Edison Co.  
National Electric Coil Division  
614 488-1151

## OKLAHOMA

**Oklahoma City**  
Essex International Inc.—IWI Div.  
405 236-5411

## OREGON

**Portland**  
Essex International Inc.—IWI Div.  
503 655-0138  
C. E. Riggs, Inc.  
503 226-3286

## PENNSYLVANIA

**Harrisburg**  
Pytronic Industries, Inc.  
717 233-6591  
**Montgomeryville**  
Pytronic Industries, Inc.  
215 643-2850  
**Philadelphia**  
Brownell Electro, Inc.  
215 632-3030  
Essex International Inc.—IWI Div.  
215 236-7100  
Prehler Electrical Insulation  
215 725-5014  
**Pittsburgh**  
Essex International Inc.—IMC/IWI Div.  
412-242-5560

## TENNESSEE

**Memphis**  
Brownell Electro, Inc.  
901 323-8554  
Electrical Insulation Suppliers, Inc.  
901 947-4176

## TEXAS

**Dallas**  
Essex International Inc.—IWI Div.  
214 339-8346  
Specialized Products Company  
214 358-4663  
Williamson Distributing Corp.  
214 741-5831  
**Houston**  
Essex International Inc.—IWI Div.  
713 227-6358  
Williamson Distributing Corp.  
713 672-1715

## UTAH

**Salt Lake City**  
Hyer/Cramer Electronics  
801 487-3681

## WASHINGTON

**Seattle**  
Atlas Packing & Rubber Co.  
206 623-4697  
Essex International Inc.—IWI Div.  
206 763-8650  
C. E. Riggs, Inc.  
206 623-5707

## WISCONSIN

**Milwaukee**  
Essex International Inc.—IMC/IWI Div.  
414 342-3927

B-2200

# Centralab perspectives

FOR USERS OF ELECTRONIC COMPONENTS

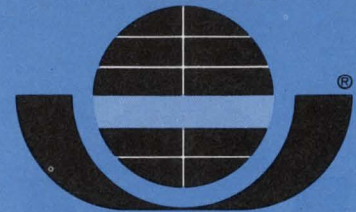

CENTRALAB

Electronics Division  
GLOBE-UNION INC.

5757 NORTH GREEN BAY AVENUE  
MILWAUKEE, WISCONSIN 53201

## Covering Detroit's needs for thick film hybrids is a big order.

Whether you're in autos, computers, music, data processing, business machines, telecommunications or industrial electronics . . . Centralab can now provide the thick film hybrid circuits you need.

Tight schedules. Exacting specs. Volume orders for millions of pieces. Anyone who has supplied the nation's auto manufacturers with component parts knows this is the kind of mission he faces.

Centralab has run this fast track for some years, providing assembly plants throughout the U.S. with thick-film hybrid circuits for Detroit end use. These have included circuits for car radios, stereo tape players, fuel controls, headlight dimmers and dashboard instrumentation such as tachometers and sequential turn controls.

Why Centralab hybrids? Obviously, the auto makers are getting the high performance specs they ordered, and in the enormous quantities they demand.

Take the specs, for example. Package power up to 4 watts per square inch. Rugged ceramic substrates with special form factors. Compare resistor tolerances as low as  $\pm 0.5\%$  and TC of  $0 \pm 100$  PPM/ $^{\circ}$ C and you get an idea of the customized circuitry Centralab thrives on. Capacitor dielectrics range through NPO & N5250 to Hi K. Designs include plastic and glass encapsulated transistors and diodes, as well as chip devices.

Happily, this type of spec is also

required in other industries. Manufacturers of musical instruments, sound equipment, radio and TV come regularly to Centralab for custom hybrids. Typical circuits produced are tuner, IF, color and audio-circuitry. Electronic organ manufacturers are using Centralab thick-film circuits for staircasing networks, passive filters, keyers, frequency dividers, amplifiers, MOS protection and tone control circuitry.

Among the fastest growing fields is data processing. Here Centralab has produced such circuits as pull-up networks, voltage regulators, dis-

play drivers, one shot, multi-vibrators, hammer drivers and interface devices.

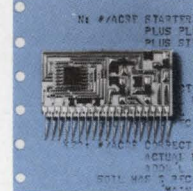

Centralab's programmed for thick-film usage in computers.

Also worth singling out are business machine and point-of-sale equipment manufacturers who specify circuits such as clock drivers,

video amplifiers, high voltage bleeders, and motor speed regulators.

The list goes on and on. Telecommunications and the requirements for attenuator pads, passive filters and mixing networks. Industrial electronics and circuits such as motor speed control, solid state switches and frequency control networks.

But you get the idea by now. You set the spec. Centralab will set the precedent. It's virtually that easy when you deal with a leader. If you've a special application for hybrids, or you'd like to consider their adoption in your line, get in touch. Write A. R. Wartchow, Marketing Manager, Electroceramic Products. Ask for Centralab Bulletin No. 1429H.

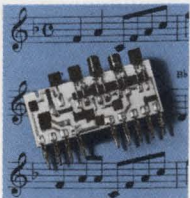

Hybrids sound good to music makers, too.

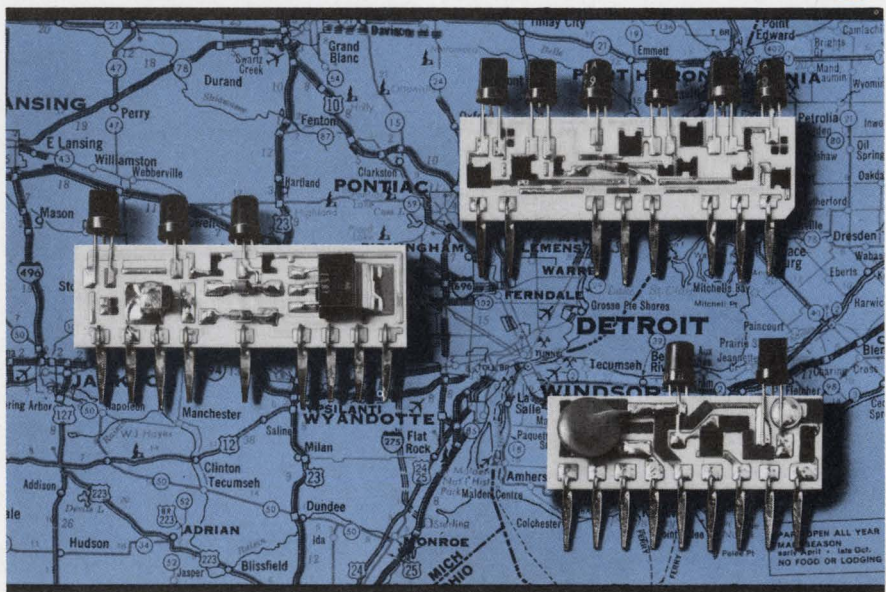

INFORMATION RETRIEVAL NUMBER 193



**Centralab  
perspective:**

**Ceramic  
Substrates/  
ScoreStrates.®**

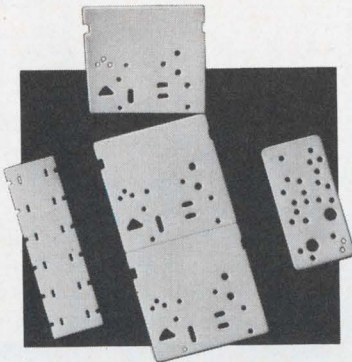

**Get your circuits  
started right.**

Need ceramic substrates for your hybrid circuits? For resistor networks? Capacitor networks? Centralab's got them in every shape and size. In aluminas of 99.5% and 95%. Plain or metallized. With holes, slots, notches, scorelines or plain. With accurate dimensions and a surface finish compatible with your particular needs.

The pay off with Centralab is high performance reliability right from the start. So start right and specify Substrate/ScoreStrate ceramics from Centralab. You'll end up with the same high reliability substrate found in Centralab thick-film circuits (we're using them at the rate of 50 million per year).

For assistance on specifications, price and delivery, call Chuck Thompson, 414/228-2942 or write Centralab for Bulletin No. 1057TC.



**Centralab  
perspective:**

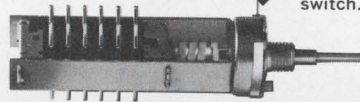
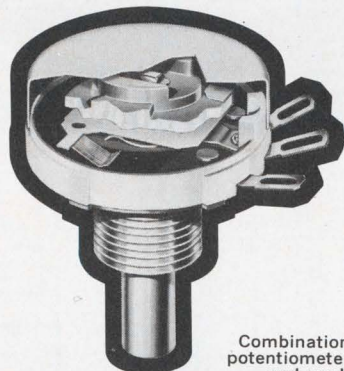

Combination  
potentiometer  
and push  
button  
switch.

**ULTRA-ONE™ pots.  
The quiet one  
is also  
the quick one.**

One look inside the Ultra-One 5/8-inch potentiometer tells you why it's the quiet one. The improved resistor system uses a smooth *conductive plastic element* and a *multi-fingered contact*. Result: CRV is virtually immeasurable throughout the long life of the pot.

The Ultra-One industrial potentiometer sets a new standard for design flexibility. The Quiet Pot. Quick delivery. Quite a combination! Other features include:

- 0.5% maximum noise through 100,000 ~
- ±250 PPM/°C
- 1/2 watt at 40° C
- 500 volts DC
- Δ R < 10% after load life
- Δ R < 10% after 100,000 ~

Write Centralab for Bulletin No. 1526P.

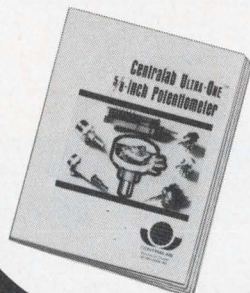

**Centralab  
perspective:**

**Ultra-Kap™  
capacitors.  
Low dissipation.  
High insulation.**

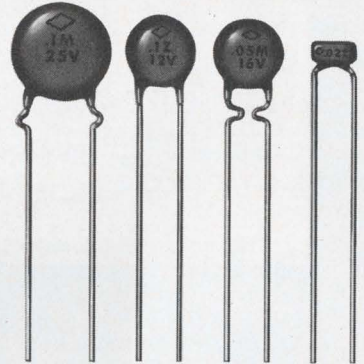

A dissipation factor as low as 3 percent maximum and high insulation resistance up to 1,000 megohms are only two critical design parameters met by Centralab Ultra-Kap capacitors. Also important is Y5F stability which is a maximum capacitance change of ±7.5% from +25° C over a temperature range of -30° C to +85° C.

Centralab Ultra-Kap capacitors cost far less than Mylar® and multi-layer monolithic types. With all the function you want. In substantially smaller space, too. For example, you can get a .05 μFD, 16 V capacitor in a .375 diameter disc.

Ultra-Kap capacitors are available in voltage ratings of 3, 12, 16, 25, and 50 V, with a choice of lead size and configuration, and in a selection of coating controls. Ask about the ratings, sizes and shapes you need.

Write Centralab for Bulletin No. 1106CA.

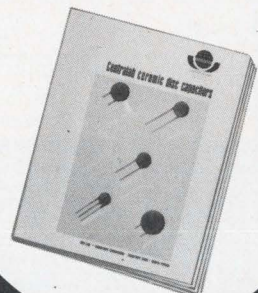

# If you can't find the lowest-cost optical coupler, relay, switch, translator or interface you want here...

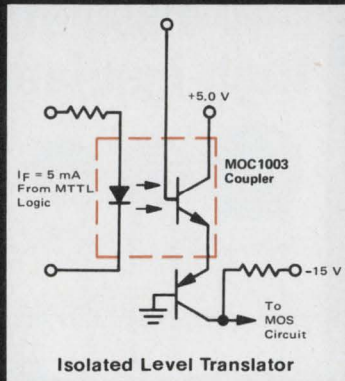

**Isolated Level Translator**

Type: MOC1003 Coupler  
Price: 99¢  
Features: 500 V Isolation  
30% Transfer Ratio

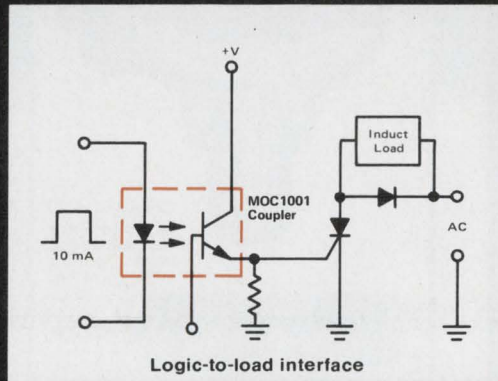

**Logic-to-load interface**

Type: MOC1001 Coupler  
Price: \$1.95  
Features: 2,500 V Isolation  
60% Transfer Ratio

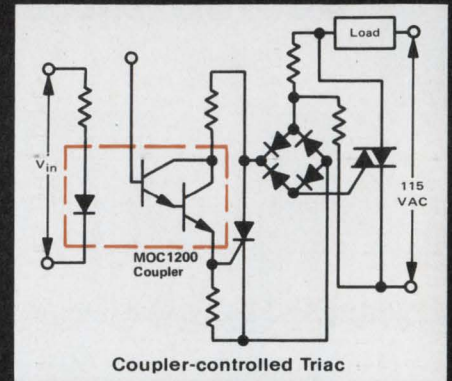

**Coupler-controlled Triac**

Type: MOC1200 Darlington Coupler  
Price: \$1.95  
Features: 1,500 V Isolation  
200% Transfer Ratio

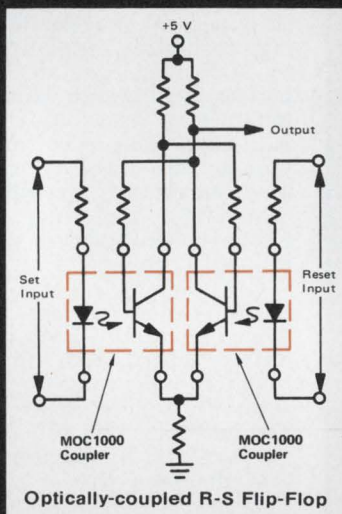

**Optically-coupled R-S Flip-Flop**

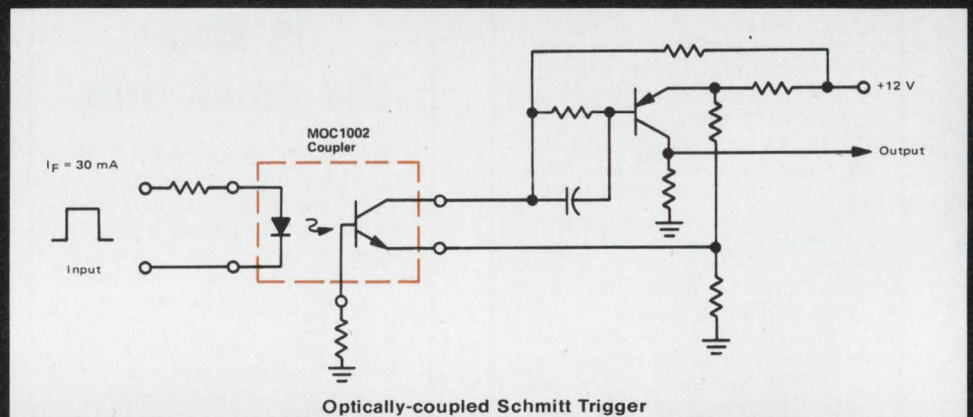

**Optically-coupled Schmitt Trigger**

Type: MOC1000 Coupler  
Price: \$1.75  
Features: 1,500 V Isolation  
60% Transfer Ratio

Type: MOC1002 Coupler  
Price: \$1.50  
Features: 1,500 V Isolation  
30% Transfer Ratio

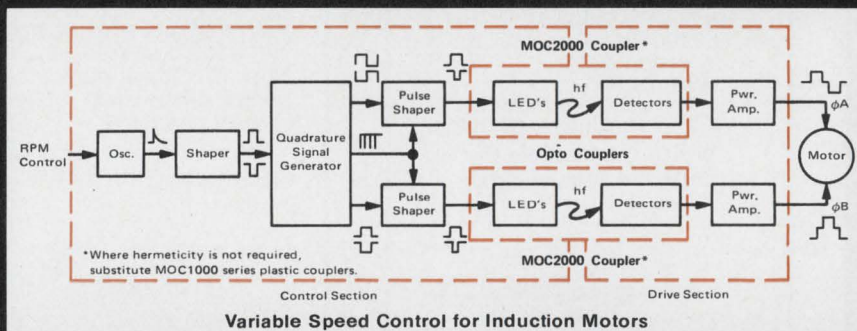

**Variable Speed Control for Induction Motors**

Type: MOC2000 Hermetic Coupler  
Price: \$3.10  
Features: 1,500 V Isolation  
3.0% Transfer Ratio

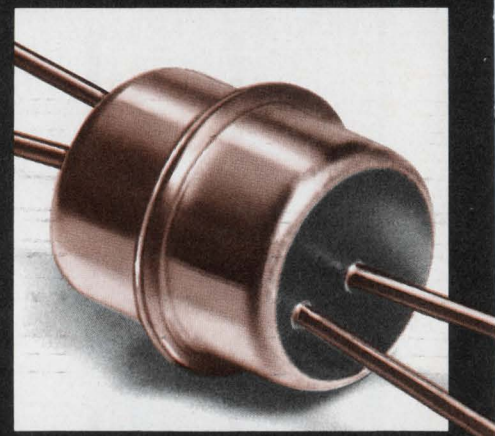

# better have your isolation examined.

Optical couplers offer design engineers new freedom in designing circuits and systems. They're the only devices around that transfer, relay, couple, switch or isolate an electrical signal through the medium of light. They offer excellent input/output isolation . . . 100 billion ohms . . . and up to 2,500 V isolation voltage.

Call them what you will, they're versatile, quick, simple, reliable. And more economical than ever — Motorola prices now start at just 99¢, 100-up!

Problems such as ground loop isolation, common mode noise rejection, voltage level translation and many more can be solved or simplified using couplers.

In electro-mechanical relay replacement they offer unbeatable advantages. With no contacts,

they're immune to arcing and pitting and provide half the size and 1,000 times the speed of relays. There's no shock or vibration problems and they can be mounted in any position. Their inherently high isolation voltage permits operation in interface systems at different voltage levels and they're compatible with integrated circuits such as MOS, TTL, op amps and regulators.

Various responses can be achieved through linear modes of operation with feedback possible for inductive and reactive loads such as make/break timing designs. And with non-degrading solid-state operation, they're truly lifetime circuit performers.

Although of closed construction, they're simplicity itself. Coupler input is connected to a light emitter

and the output is a photodetector transistor. The elements are separated by a transparent insulator and housed in a light excluding package. Once assembled, the device is completely electronic in nature, eliminating the designer's need for knowledge of optics.

For information about how they can fit into your system designs, write on your company letterhead to Motorola Semiconductor Products Inc., Box 20912, Phoenix, AZ 85036. We'll send three just-published design aids: OPTOELECTRONICS AT WORK, AN571 — Isolation Techniques Using Optical Couplers and AN575 — Variable Speed Control System For Induction Motors. Circle the reader number for data sheets.

All prices shown are 100-999.



## **MOTOROLA COUPLERS** *— lighten your industrial load*

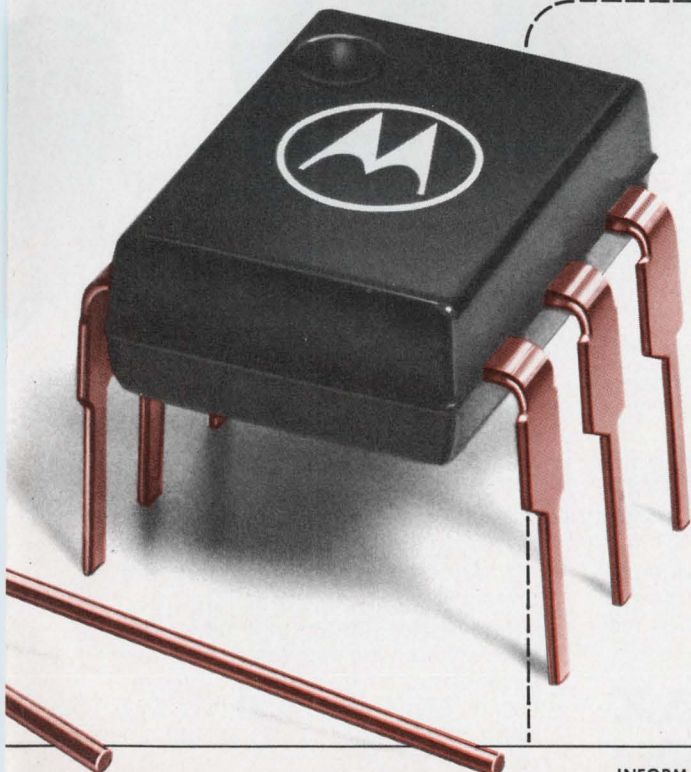

### **1 FREE OPTICAL COUPLER**

. . . is yours when you contact the Motorola distributor nearest you. Call him or send the coupon for a free MOC-1003 optical coupler ready for evaluation and prototyping — do it now!

To (distributor) \_\_\_\_\_

Send me my free Motorola MOC1003 optical coupler immediately!

Name \_\_\_\_\_

Title \_\_\_\_\_

Company \_\_\_\_\_

Div. \_\_\_\_\_

Address \_\_\_\_\_

City \_\_\_\_\_

State \_\_\_\_\_ Zip \_\_\_\_\_

(Offer expires January 31, 1973)

# There's more to a Unimax product than meets the eye.



More quality. More reliability. More choice. More service.

When it comes to switches, you'll find that our models cover almost any conceivable snap-acting switch requirement.

BASIC PRECISION switches that are the first choice of the volume OEM users.

The most complete GENERAL PURPOSE line in the industry.

All styles of MINIATURE, SUBMINIATURE, and MINIATURE SUBMINIATURE types.

Big, rugged, METAL-CASED LIMIT

switches. Thousands of specials in minimum turn-around time, at minimum cost.

And to see the light, ask about our ILLUMINATED PUSHBUTTON CONTROLS. They offer you the broadest variety of styles in the business—in the widest choice of displays, colors, illuminations and actuations. From simple pilot light applications to the most

sophisticated multi lamp—multi switch—multi legend control, you'll find a Unimax LPB to meet your requirements. At a competitive price.

You'll also find special key lock or mushroom cap models. Mountings that are simplicity itself. Electrical and mechanical performances that are uniformly high.

Let us give you more. Write for detailed information concerning your applications to Unimax Switch Corporation, a Riker-Maxson Subsidiary, Ives Road, Wallingford, Conn. 06492. Or call (203) 269-8701.

 **Unimax**  
We give you more.

INFORMATION RETRIEVAL NUMBER 198

If you're trying to create logic functions with your own hardwired circuitry, there's an easier way to go. Don't look now, but minicomputer state-of-the-art (and state-of-the-price) just caught up with your application.

The Naked Mini 8 is a computer that's a component. A powerful, fully-operational, byte-oriented, 8-bit computer. Completely tested and easy to interface. Ready to drop into your system like a simple component.

All you add is the power supply and control panel. Everything else is already there. A 1600 nanosecond cycle time, 4K core memory (expandable to 32K), fully-parallel broad-

side I/O, three vectored priority interrupts, two direct memory channels, and an unconditional one-year warranty — the longest in the business.

In 200 unit OEM quantities, you get all of this and more for \$1450. For full specs and price lists, write today: Computer Automation, Inc., 18651 Von Karman, Irvine, California 92664. (714) 833-8830. TWX 910-595-1767.



**COMPUTER AUTOMATION, INC.**  
the NAKED MINI company

## The computer that's a component.

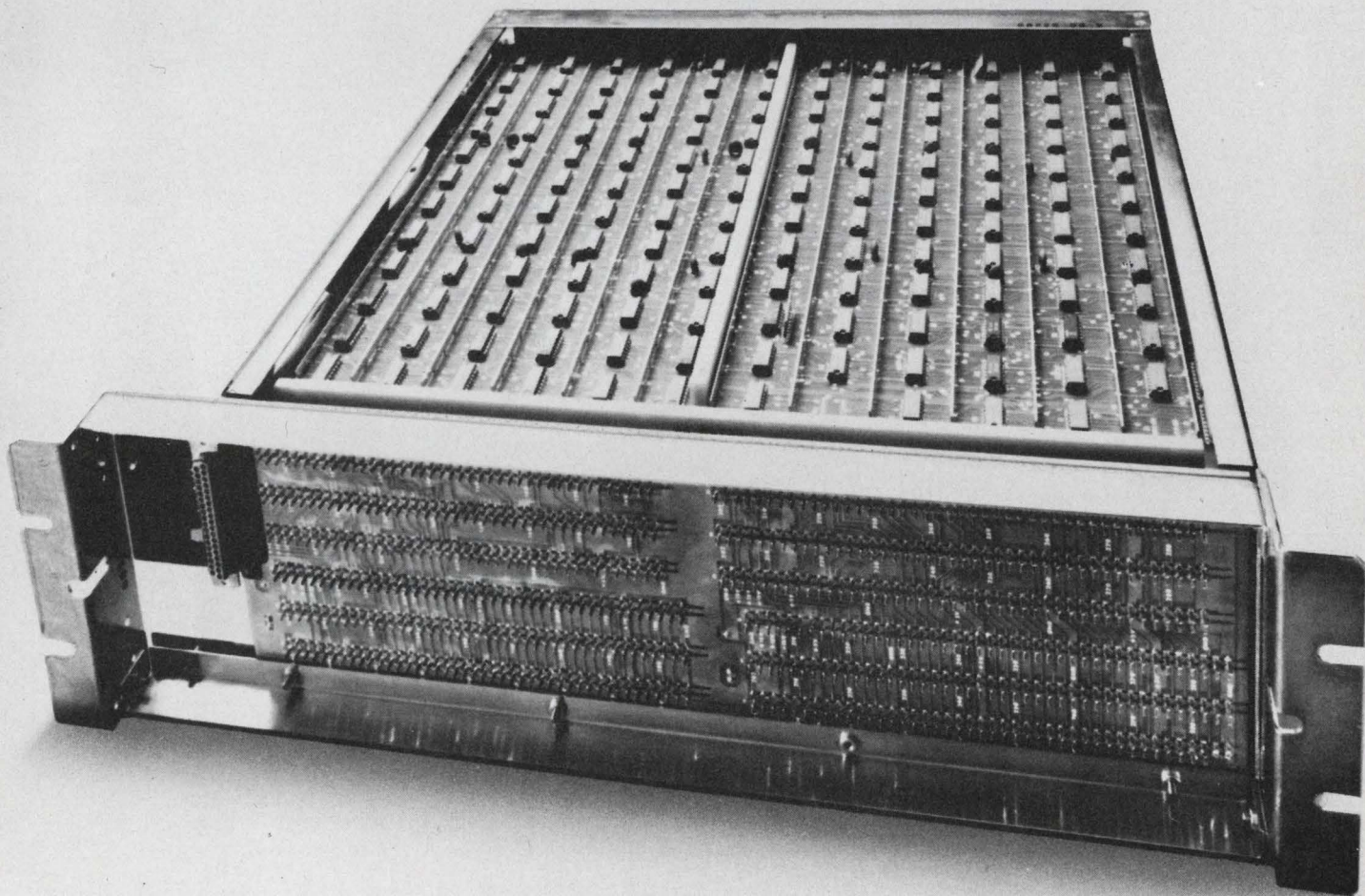

**The NAKED MINI,<sup>TM</sup>**  
**\$1450.**

# Model 501

## 5MHz Function Generator with trigger/gate.

### \$395



**If you find that hard to believe, you know a lot about function generators.**

But do you know about our modular solid state Model 501? And what it can do? It can make sine waves, square waves or triangles with variable offset or with DC. With symmetry control it can make pulses or ramps — and at rates to 5 MHz with our 1000:1 voltage generator control.

You can start and stop Model 501 as you choose with trigger /gate for one-pulse, tone bursts or synchronous timing. And you can add in your own signals to our built-in, input-summing, high-output wide-band amplifier.

What more could you ask for \$395?

If you're skeptical, that's fine. Because we'd like you to take Model 501 home with you and test it till your heart's content. Write or call today. Find out what Model 501 can do for you. And if you'd like the complete story on function generators, write for our "Free-folding, function generator guide."

We're making this offer because we have a theory—the more you know about function generators, the better for us.

**WANT TO TEST MODEL 501? WRITE OR CALL AILTECH TODAY.**

THE GOLD LINE SERIES FROM

**AILTECH**   
A CUTLER-HAMMER COMPANY CONTROL

EAST COAST OPERATION • 815 BROADHOLLOW ROAD • FARMINGDALE, NEW YORK 11735 • TELEPHONE: (516) 595-6471  
WEST COAST OPERATION • 19535 EAST WALNUT DRIVE • CITY OF INDUSTRY, CA. 91748 • TELEPHONE: (213) 965-4911

INFORMATION RETRIEVAL NUMBER 200

OTHER SOLID GOLD PRODUCTS FROM AILTECH INCLUDE SPECTRUM ANALYZERS, NOISE MEASUREMENT EQUIPMENT, RF POWER SOURCES, OSCILLATORS AND TRANSDUCERS.

Fluke problem solvers

# The new multimeter with advanced L.S.I. for more function power. 26 ranges, 5 functions.



## \$299...

## Fluke's new 8000A,

## Try one for fifteen days, no obligation.

Now you can put the unmatched quality of Fluke instrumentation to work for you at the price of an ordinary multimeter.

Here's the DMM with more function power. Its got 26 ranges, including five ranges of ac and dc volts, five

ranges of ac and dc current, and six ranges of resistance. Push button control gives you the simplest most reliable error-free operation possible. The new Fluke 8000A is the only multimeter using an A-to-D converter with inherent self-zeroing to com-

pletely eliminate offset uncertainty.

More details are on the next page, but we think you'll want to try this low-priced measurement system now. Fill in the coupon; we'll do the rest.

Circle 240 for more information

Ship me a Fluke 8000A for \$299 plus \$\_\_\_\_\_ for additional options checked below. I prefer the following payment option:

Charge my  Master Charge,  BankAmericard, or  American Express account for the full amount plus \$5 shipping and handling.

If using Master Charge, please indicate the 4 digit number appearing above your name

Bill against the attached company purchase order for the full amount plus \$5 shipping and handling.

Cash Order. My check for the full amount is enclosed. Fluke pays shipping and handling.

(Washington state residents add 5% sales tax.)

Return within 15 days for full refund if not delighted.

**Add the following options:**

- |   |   |
|---|---|
| <input type="checkbox"/> Rechargeable Battery — \$50* | <input type="checkbox"/> Carrying Case — \$15             |
| <input type="checkbox"/> BCD Data Output — \$75*      | <input type="checkbox"/> Dust Cover — \$8                 |
| <input type="checkbox"/> RF Probe — \$75              | <input type="checkbox"/> Rack Kit-Center — \$30           |
| <input type="checkbox"/> AC Probe 20A & 200A — \$50   | <input type="checkbox"/> Rack Kit — 1/2 Rt or Left — \$30 |
| <input type="checkbox"/> HV Probe — \$25              | <input type="checkbox"/> <b>Send me literature only</b>   |
| <input type="checkbox"/> Deluxe Test Leads — \$5      |   |

\*Choose BCD data output or battery pack; both cannot be ordered in the same instrument.

Name \_\_\_\_\_

Company/Institution \_\_\_\_\_

Address \_\_\_\_\_

City & State \_\_\_\_\_ Zip \_\_\_\_\_

Credit Card No. \_\_\_\_\_ Phone \_\_\_\_\_

(Signature authorizing charge to credit card)

**For even more convenience, let your nearby Fluke sales office handle the details. For location, dial toll-free 800-426-0361.**

**FLUKE**<sup>®</sup>

# When you look inside you'll find the same high technology and quality we put in our \$3000 DVM's.

Take a look inside. The LSI chips, equivalent to over 3,000 circuit elements, are the most advanced proven semiconductor devices on the market today. Fluke is the only manufacturer using **both analog LSI and digital LSI** to give you increased reliability at lower cost with fewer parts. The Fluke 8000A has only 1/3 the number of parts used in a typical 3 1/2 digit multimeter.

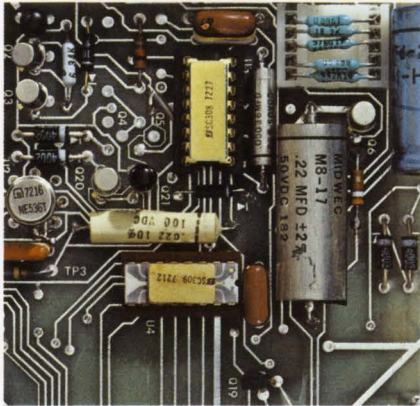

## A simple guarantee

You can understand our 12-month guarantee. It's straightforward and honest. And you can believe we live up to it. If anything happens to your 8000A, take it or send it to your nearest factory service center. We'll give you 48-hour turnaround service in the U.S., Canada, Europe and the Far East.

## Specs to work by

The new Fluke 8000A has a dc accuracy of 0.1% when you buy it. We guarantee it will still measure within that accuracy without recalibration a year later.

The case is rugged and tough. Drop this multimeter from a bench. Nothing happens to the works inside. We guarantee it.

## Wide range of measurements

Measurement flexibility is broad enough to meet all the situations you're likely to encounter. The Fluke 8000A gives you 26 ranges to measure ac and dc voltages from 100 microvolts to 1200 volts, currents from 100 nanoamps to 2 amperes; and resistance from 100 milliohms to 20 megohms.



## Wide choice of options

For a few dollars more, you can add a rechargeable battery pack to give you completely portable operation for over eight hours. And when you're back on the line, the batteries will recharge automatically. Other options include digital printer output, deluxe test leads, high voltage probe, rf probe, 200-amp ac probe, carrying case and rack mount kits.



## A complete digital multimeter

But with or without options, the Fluke 8000A comes complete with test leads and spare fuses. It all adds up to an instrument you can count on day after day, year after year. Isn't this what you want in a digital multimeter at any price? Fluke thinks so.

FIRST CLASS  
Permit No. 5464  
Seattle, Wash.

## BUSINESS REPLY MAIL

No Postage Stamp Necessary If Mailed in the United States

Postage Will Be Paid By



John Fluke Mfg. Co., Inc.  
P.O. Box 7428  
Seattle, Wash. 98133

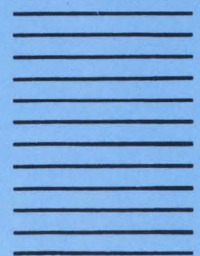



# ...it's SUPERDAC!

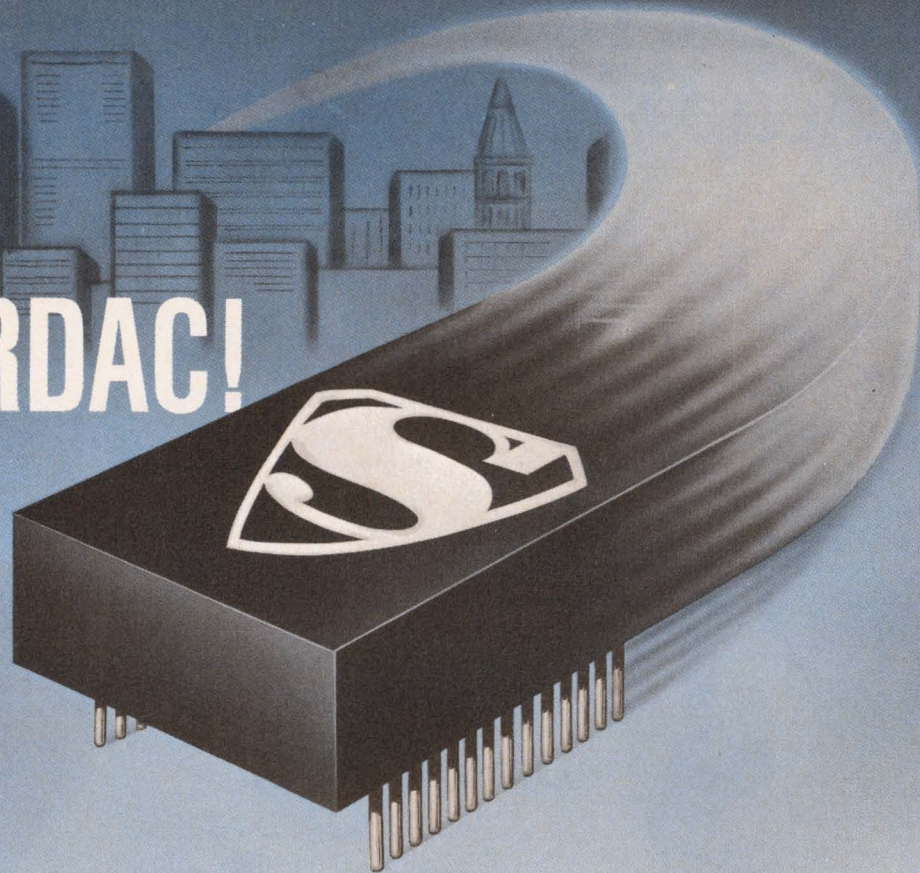

There are quite a few manufacturers of D/A Converters today. Some large, some small. They come and they go. But there aren't many who can give you the benefits of seven years of experience in this technology . . . benefits such as reliability, long life, stability.

Sprague SUPERDACs from 8 to 12 bits with settling times to 2  $\mu$ s are in full production. Reference voltage adjustable to +18V. They're priced competitively with discretely—with this difference: the performance, precision, and stability inherent in a well-engineered product are free. Here's your chance to gain from Sprague's sophistication in D/A Converter design and manufacture.

**UP WITH PERFORMANCE . . .** All internal devices hermetically-sealed and designed to meet the most stringent environments or exceed MIL-STD-883 requirements.

**UP WITH PRECISION . . .** Voltage offsets less than 5 mV. Resistors laser-adjusted to achieve typically  $\pm 0.1\%$  resistance tolerance and matching to within  $\pm 0.01\%$ . Proprietary monolithic IC ladder switches and buffer amplifiers are also featured.

**UP WITH STABILITY . . .** Operating temperatures are  $-55$  C to  $+125$  C for  $\pm 1$  LSB accuracy, or  $-25$  C to  $+100$  C for  $\pm 1/2$  LSB accuracy.

**. . . AND AWAY WITH DISCRETE PRICES . . .** Compare Sprague's price/performance/size with those of any other manufacturer. Prices are as low as \$2.50/bit. Then choose SUPERDAC . . . for signal processing, servo position, process control, and modems, to name a few applications.

Sprague Catalog Number	Resolution	Settling Time to $\pm 1/2$ LSB ( $\mu$ s)	External Reference Voltage	Full Scale Output	Temp. Coeff. <sup>(1)</sup> (ppm/ $^{\circ}$ C)	Unit Price (1-24)
<b>FIXED REFERENCE</b>						
UHM-532A	12-bit/3-digit	15	-10	-10	1	\$42.20
UHM-533A <sup>(3)</sup>	12-bit/3-digit	15	-10	$\pm 10$	3	50.40
UHM-503A	10-bit	2	-10	-10	1	36.00
UHM-506A <sup>(3)</sup>	10-bit	2	-10	$\pm 10$	3	42.20
UHM-523A	8-bit/2-digit	2	-10	-10	1	28.80
UHM-526A <sup>(3)</sup>	8-bit/2-digit	2	-10	$\pm 10$	3	36.00
<b>4-QUADRANT MULTIPLYING <sup>(2) (3) (4)</sup></b>						
UHM-412	12-bit/3-digit	20	$\pm 10V/20V$ p-p	$\pm 10$	3	86.33
UHM-409	10-bit	20	$\pm 10V/20V$ p-p	$\pm 10$	3	71.92
UHM-408	8-bit/2-digit	20	$\pm 10V/20V$ p-p	$\pm 10$	3	57.53

(1)  $\pm 1/2$  LSB Linearity  
(3) Includes Op Amp

(2) DTL/TTL/CMOS (Neg. Logic) Input Compatible

(4) Multiply D/A Output Swing Adjustable to  $\pm 18V$  Max.

**Standard Size:** 1 1/2" x 2" (1" x 1 1/2" Available on Special Order).

**Inputs Available:** Binary, BCD and on Models with Op Amp, Offset Binary.

**Power Supply:**  $\pm 15V$  (Fixed Reference DACs Available with +4, -20V supply), Multiplying D/A Accept Reference Variable to  $\pm 18V$ .

The same technology that makes this series provides a complete family of successive approximation A/D converters, with current-summing capability and custom engineering as well.

For complete information, call or write Ron Beck, Semiconductor Division, Sprague Electric Co., 115 Northeast Cutoff, Worcester, Mass. 01606. Tel. 617/853-5000.



Analog Products for Signal Processing

# What the industry taught us about cheap OEM minicomputers.

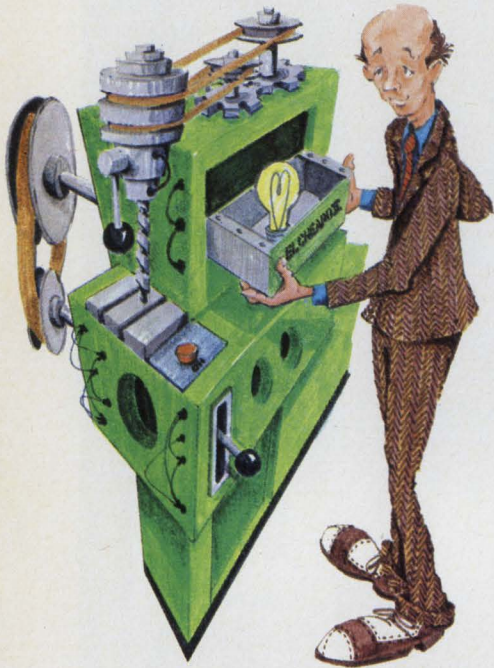

## Stripped for action.

Here's a familiar approach. El Cheapo II. In reality, it's the good old Mod X stripped of all the stuff that made the old Mod X good. Instructions. Memory. I/O facilities. Everything. But it's cheap. It's really cheap. Only the hum remains.

## Dressed to kill.

Here's the same machine in disguise. Now it's hiding behind all the things you have to hang on it to make it work. Like a power supply and a memory and some sort of I/O kluge so your system can talk to it.

Also hidden, of course, is the cost. And it isn't so cheap any more.

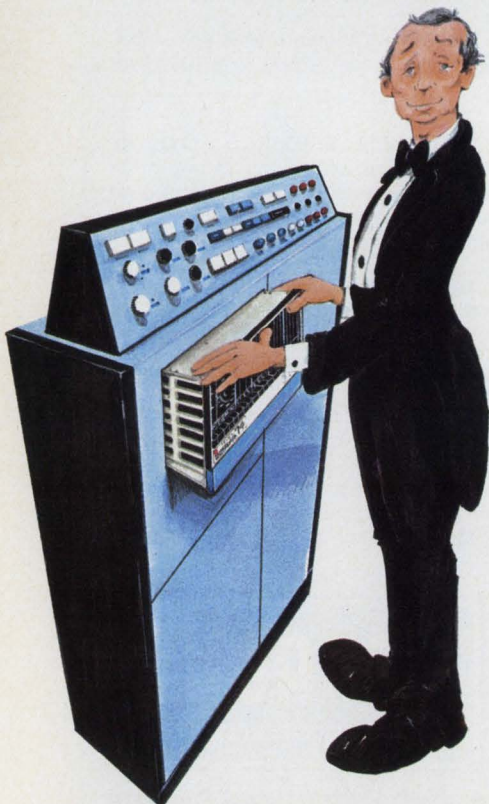

## Introducing the \$3600 Interdata Model 74. What you need is what you get.

Here's a new approach.

A \$3600\* general-purpose OEM minicomputer with the much-copied third generation architecture of the Interdata New Series family of minicomputers.

And that \$3600 — lowest in its class — includes hardware multiply/divide, 16 general registers, directly addressable 8KB core expandable to 64KB, an 80-ns solid-state Read-Only-Memory and a multiplexor that provides an I/O system for communicating with up to 255 peripheral-oriented device controllers.

We've even made the display panel optional because most OEMs don't need it. And what you need is what you get.

At \$3600, maybe we'll teach the industry a thing or two.

**INTERDATA®**

2 Crescent Place, Oceanport, New Jersey 07757 (201) 229-4040. Atlanta — (404) 288-7000. Boston — (617) 890-0557. Chicago — (312) 437-5120. Dallas — (214) 238-9656. Detroit — (313) 356-5515. Houston — (713) 783-1830. Los Angeles — (213) 640-0451. Palo Alto — (415) 969-1180. Washington — (703) 525-4806. Toronto — (416) 678-1500. United Kingdom — Uxbridge 51483. Sydney — NSW 439-4155. West Germany — 0811/160031. Tokyo — 270-7711.

\*Basic 8KB Model 74 list.  
With OEM discount, quantity of 18 — \$2,520.00.

## ACROSS THE DESK

(continued from page 16)

those High Flyers," (ED 23, Nov. 9, 1972, p. 51). As one of the guys you're talking about in a fledgling company, it is easy to verify your remarks.

During the last two years many engineers have been crying about unemployment, loss of pension rights when changing companies and other things of a less critical nature. For people who had to work long and hard to get that paper attesting that they are engineers, it seems they have lost their drive. Your editorial points out an experience they should have: There is no better way to gain an understanding of the problems of management than to get into the thick of the battle to start and mature a new company.

The easy thing is to complain. From personal experience, it is much harder to crack the nut of a new company.

*Harold F. Shultz*

*Vice President, Marketing*

Emhiser Rand Industries

7721 Convoy Court

San Diego, Calif. 92111.

## About those keyboards by Donnelly Mirrors . . .

Your article on keyboards in the Nov. 9 issue ("Focus on Keyboards," ED 23, p. 54) made reference to Donnelly Mirrors keyboards as an elastic diaphragm type with high contact resistance and a spongy touch. It also related them to low-cost pocket and desk-top calculators.

In fact, Donnelly Mirrors keyboards employ gold-plated, hard contacts with their associated low contact resistance, have a touch comparable to the most expensive solid-state keyboards and have application mostly in computer-related equipment. The keyboards do employ an integral, laminated switch structure, from which they gain their low profile and competitive price.

*Derek J. Hatley*

*Manager of Electronic Development*

Donnelly Mirrors, Inc.

Electronics Div.

611 Ottawa Ave.

Holland, Mich. 49423.

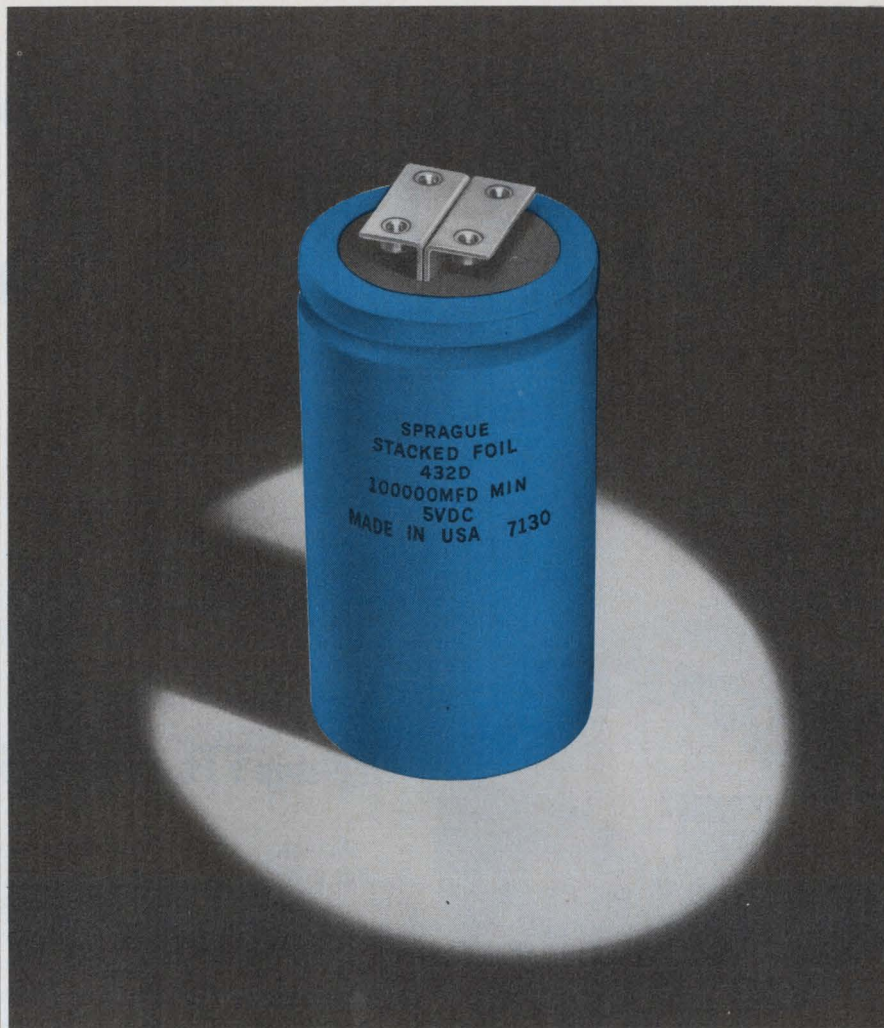

## Stacked...with beautiful curves!

(stacked-foil construction with ultra-low impedance, ultra-low ESR, ultra-low inductance)

Revolutionary new Type 432D COMPULYTIC® Aluminum Electrolytic Capacitors offer capacitance values to 100,000  $\mu$ F with equivalent series resistance of typically less than 0.001 ohm and inductance of only 1 nH in a 3" x 5 $\frac{1}{8}$ " case. This same capacitor will handle 93 amperes of ripple current at 65 C and 1 kHz.

Impedance limits at 10 kHz are as low as 0.001 ohm with typical values of only half of the specified limits.

Terminals are ideal for use with laminated-bus power distribution systems found in modern EDP equipment, where the low ESR and impedance of Compulytic capacitors help insure continued operation of logic circuits even during momentary power outages.

Sprague Type 432D Capacitors are available in nine voltage ratings from 5 to 50 volts d-c, and are designed for operation over the temperature range from -40 to +85 C.

For complete technical data, write for Engineering Bulletin 3443 to: Technical Literature Service, Sprague Electric Co., 347 Marshall St., North Adams, Mass. 01247.

THE BROAD-LINE PRODUCER OF ELECTRONIC PARTS



INFORMATION RETRIEVAL NUMBER 14

# SCHOTTKY ON



## One-stop TTL shopping for 74S MSI, SSI...

At last. Available now, all in one place. The whole mix in Schottky logic—to match every high speed TTL function in demand today. Signetics

broad line of 74S circuits. Plus our compatible 82S series of enhanced MSI devices that help Schottky give you a competitive step-up in speed, in design-ease, in versatility... and of course, in MSI complexity.

And you get it where you want it, when you want it. Fast service directly from distributor stock. Signetics knocks off the waiting list tie-ups, the multi-stop shopping. After all, how can we encourage you to boost system speed by replacing TTL with Schottky equivalents, if you can't get the circuits to work with? All the parts you need—without delays, without runarounds, without making six calls when one should do the job.

Here's where Signetics makes the difference. One call does the job. Completely. SSI Schottky to cover full function range:



### SSI SCHOTTKY 74S TTL

74S00	Quad 2-Input NAND Gate
74S03	Quad 2-Input NAND Gate (Open Collector)
74S04	Hex - Inverter
74S05	Hex - Inverter (Open Collector)
74S10	Triple 3-Input NAND Gate
74S11	Triple 3-Input Positive AND Gate
74S15	Triple 3-Input Positive AND Gate (Open Collector)
74S20	Dual 4-Input NAND Gate
74S64	4-2-3-2-Input AND/OR/INVERT Gate
74S65	4-2-3-2-Input AND/OR/INVERT Gate
74S74	Dual D-Type Edge-Triggered Flip-Flop
74S112	Dual J-K Edge-Triggered Flip-Flop
74S113	Dual J-K Edge-Triggered Flip-Flop
74S114	Dual J-K Edge-Triggered Flip-Flop
74S40	Dual 4-Input NAND Buffer
74S140	Dual 4-Input NAND Line Driver

You can make the same call encompass MSI too. Signetics 74S MSI circuits offer the same volume availability as SSI, as well as the same total TTL compatibility—pin-for-pin fits with standard TTL and low-power Schottky. Ten MSI devices in stock now, with more to be announced in the next few months.

### MSI SCHOTTKY 74S TTL

74S151	8-Input Data Selector/Multiplexer
74S153	Dual 4-Input-to-1-Line Selector/Multiplexer
74S157	Quad 2-Line-to-1-Line Data Selector/Multiplexer
74S158	Quad 2-Line-to-1-Line Selector/Multiplexer (Inverting)
74S174	Hex D-Type Flip-Flop w/Clear
74S175	Quad D-Type Flip-Flop w/Clear
*74S181	Arithmetic Logic
*74S194	4-Bit Bidirectional Shift Register
*74S195	4-Bit Parallel Access Shift Register
74S251	8-Input Data Selector/Multiplexer w/tri-state
74S253	Dual 4-Input-to-1-Line Selector/Multiplexer w/tri-state
74S257	Quad 2-Line-to-1-Line Data Selector/Multiplexer w/tri-state outputs
74S258	Quad 2-Line-to-1-Line Selector/Multiplexer (Inverting) w/tri-state

\*January-February announcement

Complementing 74S, Signetics 82S series MSI circuits offer significant advantages in sophisticated Schottky systems designs. The conventional TTL input circuit found in all Schottky logic, other than Signetics 82S, suffers from low input impedance.

Signetics advanced PNP structure produces significantly higher input impedance. You can drive far more devices from one output since input current is one-fifth that of standard Schottky inputs. With Signetics 82S MSI you need not worry about noise when driving long lines since, in addition to 10 PNP loads, a termination resistor can be accommodated when needed without fan-out reduction.

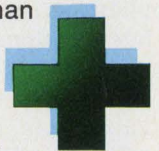

# THE DOUBLE.

...and now optimized 82S MSI too.

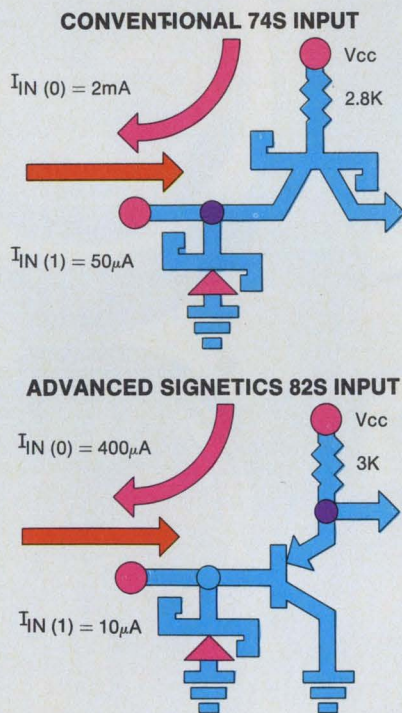

The growing line of 82S includes ultra high speed pin-for-pin replacements for the popular 8200 series MSI. In addition, the 82S90/91 100 MHz counter will replace the 74196/197, and the 82S70/71 70 MHz shift register will replace the 74178/179 in systems requiring improved speed performance.

The BCD arithmetic unit 82S82 replaces at least six MSI packages previously needed for the same function while at the same time operating speed is improved by a factor of 3. For BCD applications that only require addition, the 82S83 adder will replace three MSI circuits, and double operating speed. The 82S62 parity generator/checker is unsurpassed in speed.

Of course the 82S MSI line interfaces with 74S logic directly, operating in the same design environment as all 7400 circuitry but with the added advantage of direct replacement without violating fan-out rules.

MSI SCHOTTKY 82S TTL		SPEED
82S30/31/32	8-Input Digital Multiplexer	15 ns
82S33/34	2-Input, 4-Bit Digital Multiplexer	15 ns
82S41/42	Quad Exclusive-OR/Quad Exclusive-NOR	5 ns
82S50/52	Binary-to-Octal/BCD-to-Decimal Decoder	12 ns
82S62	9-Bit Parity Generator / Checker	17 ns
82S66/67	2-Input, 4-Bit Digital Multiplexer	15 ns
82S70/71	4-Bit Shift Register	70 MHz
82S82	BCD Arithmetic Unit	20 ns
82S83	BCD Adder	20 ns
82S90/91	Presetable Decade/Binary Counter	100 MHz

74S/82S Schottky TTL. Just one call to one of our distributors, reps or salesmen. And Signetics puts it on the line. Your line.

Signetics-Schottky 811 East Arques Avenue Sunnyvale, California 94086		
High speed response requested on Schottky TTL data, specs, applications and delivery for 74S SSI, 74S MSI and 82S MSI.		
Name		
Title		
Company		
Address		
City	State	Zip
Telephone		
<small>Signetics Corporation, a subsidiary of Corning Glass Works.</small>		

**signetics**

# The 5 fastest ways to make better inverters.

## 1 The new 81RM — fastest 125 Amp inverter SCR around.

It has  $20\mu\text{S}$  turn-off, through 1000V, with efficiency that cuts filtering, commutating and snubbing costs up to 30% in new designs. Plugged into existing circuits, it can increase overload capability or power rating by 50%. Its 30% lower switching losses let you operate efficiently at 10KHz. And for today's circuits, a guaranteed turn-off time of  $25\mu\text{S}$  with an antiparallel diode gives unequalled speed. The best "soft recovery" in the business assures the lowest RFI generation, minimizes false triggering and improves reliability. Voltage ratings from 100-1000V.  $dv/dt$  is  $200\text{V}/\mu\text{S}$ , and  $di/dt$  is  $800\text{A}/\mu\text{S}$ .

## 2 New 35 Amp IR140/141's. None faster. Lowest switching losses.

At  $15\mu\text{S}$  and  $10\mu\text{S}$  turn-off, there are no faster SCRs in their range. But what really sets them apart is the 30% lower switching loss for unequalled efficiency at high frequencies. No derating to 4KHz, and 50% of the rated current at 20KHz. Excellent as commutating SCRs. Conforms to JEDEC 2N3649-58. Reapplied  $dv/dt$  is  $200\text{V}/\mu\text{S}$ , and  $di/dt$  is  $400\text{A}/\mu\text{S}$ . Voltage ratings: 50-400V.

## New — The fastest Turn-Off ( $10\mu\text{S}$ ) high-current inverter SCRs available!

These low-frequency inverter SCRs turn off four times faster than others at their power level. You can reduce commutating component size and cost  $\frac{1}{3}$  and still increase inverter ratings with greater reliability. Higher surge ratings give you bigger safety margins, easier fuse selection. To top it off, you can choose from three package types in 50-600V ratings to optimize your design.

3 New 430 Amp (RMS), 275RF Series. The only stud-mounted 430 Amp (RMS) inverter SCR available. 7000 Amp surge rating.  $200,000\text{A}^2\text{Sec}$ .  $I^2t$  rating.

4 New 710 Amp (RMS), 450PF Series. Rated 710 Amp (RMS), this ceramic "Hockey Puk" has a surge rating of 9000 Amps and  $I^2t$  of  $340,000\text{A}^2\text{Sec}$ .

5 New 710 Amp (RMS), 451PF Series. For maximum economy, the first and only plastic encapsulated 710 Amp (RMS) "Hockey Puk" SCR. Surge rating: 9000 Amps.  $I^2t$  is  $340,000\text{A}^2\text{Sec}$ .



To get our Inverter SCR "Data pack" fast, write Dept. ED

International Rectifier  
233 Kansas Street  
El Segundo, CA 90245

# International Rectifier

...the innovative power people 

# Kurz-Kasch Digital Logic Instruments\*



... complete logic systems analysis through the logic-probe concept

Rugged, all solid-state, Kurz-Kasch logic probes are designed for fast, accurate testing of logic levels in all types of integrated circuit systems. A simple readout system indicates "true", "zero", or "pulse" readings precisely through color-coded visual electronic readouts in the probe tip. Absence of logic levels is indicated by all readouts remaining OFF.

**Applications** Logic levels can be accurately tested in virtually any (DTL, TTL, RTL) IC system including desk calculators, business machines, N/C devices, computers or telephone systems. Power is derived from the unit under test allowing use in the field or in the lab.

#### Specifications

Readout Light Red=Logic "1"  
Readout Light White=Logic "0"  
No Readout Light="infinity"

High input impedance prevents loading of circuit under test.  
Size  $\frac{5}{16}$ " dia., 6" long,  $26\frac{3}{4}$ " leads with pin terminals

A pulse detection feature is available on most models of logic probe. A third readout is provided to display high speed pulse trains or a single cycle pulse of less than 50 nanoseconds on the standard Model LP-520. Overload protection to +50, -20 volts DC is also available.

**Standard Probes** Logic probes are presently available in five standard models. MODEL LP-500 for use in testing 4.75-5.0 V DC logic systems. MODEL LP-510 for testing 4.75-5.0 V DC systems . . . includes overload protection to +50, -20 V DC. MODEL LP-520 . . . for 4.75-5.0 V DC logic systems . . . includes overload protection and pulse detection features. MODEL LP-530 for testing of 12-15 V DC logic systems . . . includes overload protection to +50, -20 V DC. MODEL LP-540 . . . for 12-15 V DC systems . . . includes overload protection and pulse detection features.

**Add these options: G-S-M: Gating Feature (-G)**— 3 Channel input for timing. Pulse indicator displays only when probe tip and gate/gates are in coincidence. **Memory & Stretch (-M)**— Push-pull switch for selecting stretch or latch mode. Stretch mode detects high speed pulse and displays blue "P" lamp for 200 mS. Latch mode captures high speed pulse/trains and latches blue "P" on until reset. **5 Nano-second capability (-S)**— Allows detection of pulses up to 10 x faster than standard probes. Each option \$10.00.

**Special Probes** As a routine service, Kurz-Kasch will custom design logic probes to user specifications. Custom designs can include: both positive and negative logic levels from 50 to 30 volts . . . special pulse detection characteristics . . . floating or grounded cases . . . custom power supply requirements . . . power lead reversal protection . . . and your choice of logic crossover parameters.

Kurz-Kasch logic probes provide all the information you need to quickly and accurately evaluate all logic systems . . . and they are the most economical logic testing instruments available. Standard Models range in price from \$39.95 to \$69.95. Write today for complete details on all standard and special logic probes.

\*Patent #3,525,939 applies, others pending.



**Kurz-Kasch, Inc.**

Electronics Division

1421 S. Broadway  
Dayton, Ohio 45401

Telephone(513)223-8161

INFORMATION RETRIEVAL NUMBER 17

THE MOST COMPLETE LINE OF

# DIP

DUAL-INLINE-PACKAGED REED RELAYS

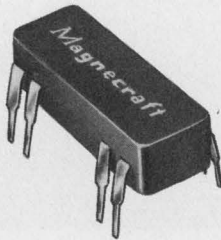

Magnecraft is proud to announce its new DIP (dual-inline-package) line of 8 and 14-pin reed relays. These new relays are designed not only to be compatible with the standard packaging developed for integrated circuits, but to offer Magnecraft quality at a low cost. This unique design gives further savings by offering the user the optimum in automated insertion and other economical installation techniques associated with printed circuit applications.

These fantastic new epoxy molded reed relays are ideal for use in circuits where high density packaging is essential. The 5VDC IC compatible versions of these relays will operate directly from TTL or DTL circuits.

Other standard coil voltages are available from stock in 6, 12, and 24VDC as well as contact configurations in 1 form A, 2 form A, 1 form B, and 1 form C. Most versions are also offered with a choice of an internal clamping diode.

**Magnecraft**<sup>®</sup> ELECTRIC COMPANY

5575 NORTH LYNCH AVENUE • CHICAGO, ILLINOIS 60630 • 312 • 282-5500 • TWX-910 221 5221

# FREE!

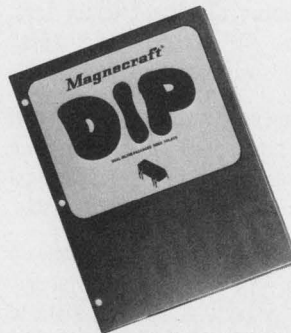

# DIP CATALOG

This 12-page catalog offers the most complete listing of DIP reed relays in the entire industry. Including four all new position-free mercury wetted types; plus eighteen others. Specifications, dimensions, prices, and all other pertinent data necessary to specify is given.



## Which semis for cars? Panel to debate issues

It's widely predicted that the automobile industry will be using semiconductors in voluminous quantities before long. But what kind of semiconductors—custom or off-the-shelf, digital or linear? Questions like these will stir controversy next month at a panel discussion at the 1973 IEEE International Solid-State Circuits Conference.

One member of the panel—Tom Frederiksen, head of National Semiconductor's Automotive Linear Integrated Circuit Dept. in Santa Clara, Calif.—says that off-the-shelf building blocks are a logical choice. Because of legislative and competitive pressures and because system design is subject to change during the development cycle, he notes, such standard ICs offer flexibility and short turn-around times that would be difficult to achieve with custom devices.

Another panel member—Peter Ansbro, manager of automotive programs for Philco-Ford, Dearborn, Mich.—disagrees. While conceding longer turn-around times and less flexibility, he argues that the advantages of custom ICs outweigh the disadvantages. He cites lower cost, easier assembly and a lower parts count.

Ansbro sees the building-block technique being used only as a stopgap for optional equipment. But once a feature becomes standard equipment on all cars, it is a lot cheaper to develop a custom IC to do the job, Ansbro asserts.

As far as which semiconductor technology to use—bipolar or CMOS—Ansbro says the automobile manufacturer doesn't really care: He merely orders a "black box" that meets certain requirements and either of the two competing technologies are satisfactory.

Whatever technology is used, the

potential size of the automotive market is staggering, Frederiksen says, "Even if all the semiconductor manufacturers got along well and cooperated to the fullest," he notes, "it would be hard to meet the volume demand of the automotive industry."

Quoting generally accepted estimates of the number of cars produced annually and estimating 10 ICs per car, Frederiksen predicts that about 120 million ICs will be needed each year—two to four times what the semiconductor industry is producing today. This means, he points out, that a tremendous expansion must take place.

Another topic that the panel will investigate is how to achieve compatibility between the emerging electronics and the noisy electrical environment of the car. The chairman of the session—Will Steffe of Fairchild Semiconductor, Mountain View, Calif.—favors a systems engineering approach. This way, he says, problems such as 250-V transients which are sometimes produced by the alternator can be eliminated at the source and not at each individual piece of electronic equipment.

Ansbro agrees and says that a systems approach will likely emerge in two to three years.

The conference is being held Feb. 14-16 in Philadelphia, and the panel discussion the evening of Feb. 14.

## AF automates watch on celestial events

To speed predictions of celestial events that can disrupt or black out military communications around the world—like solar flares—the Air Force has acquired a new Automated Astrogeophysical Data Processing System.

The new system, developed by the Air Force Cambridge Research Laboratories scientists and the Air Weather Service, uses 26 programs that have taken several years to write. The system will be used at the Global Weather Central Station, Offutt Air Force Base, Nebraska, to sort, decode, analyze and display the outputs of many space monitoring instruments.

"By eliminating many of the manual plotting and updating chores, the forecaster will be free to analyze the data more accurately and react faster to critical conditions," says Robert A. Skrivanek, a member of the space forecasting group who helped prepare the new program at the Cambridge Laboratories.

A basic problem with previous forecasting of celestial events has been that data from observation stations and ground-based sensors have been delivered in widely varying forms of time and magnitude not related to one another. By the time forecasters have been able to decipher and evaluate the data and reduce it to meaningful form, the event may already have passed.

Among the diverse information that the new system will digest are X-ray and particle data from monitors on the Vela satellite, ground-based optical data from telescopes monitoring the sun and from telescopes, and data from ionosons, or ground-based sounders, that indicate the state of the ionosphere.

## UV process speeds photoresist removal

A new "ultraviolet depolymerization" process is reported to speed and simplify the removal of plastic photoresist material from semiconductor wafers.

Current widely used methods for removing photoresists call for either soaking the polymer film in a solvent that causes it to swell, after which it is shaken or abraded off, or dipping the film in an acid solvent, which destroys it.

In many cases, however, a semiconductor manufacturer would prefer to remove the photoresist without subjecting the substrate to solvents or acids. This is particularly important where soft metal

overlays are present and they would be damaged by abrasion or corrosive solvents, or where carbon contaminants would interfere with subsequent fabrication steps.

The new process developed by Dr. Donald A. Bolon, a scientist at the General Electric Research and Development Center in Schenectady, N.Y., uses intense ultraviolet light in the presence of air to break down and vaporize the photoresist material.

A typical plastic film—depending upon the composition and thickness—can be completely removed from a semiconductor wafer in 25 to 30 minutes, according to Bolon.

This process, he notes, is the first that lends itself to the continuous removal of excess photoresist. All other known techniques require the processing of wafers in batches and are therefore inherently slower. Also, Bolon says, his is the first dry-process technique that operates at atmospheric pressure and at modest temperatures (about 250 C).

Tests at the GE Research and Development Center show that ultraviolet removal of photoresists proceeds at a rate of about 1000 Å per minute. However, Dr. Bolon points out, the process can be made to operate 10 times faster by the injection of about 2% ozone gas into the processing chamber.

## Laser airspeed meter being tested by NASA

A laser airspeed indicator accurate to within 0.1%—10 times more precise than the best systems now in use in commercial aircraft—is being tested by the National Aeronautics and Space Administration at its Ames Research Center, Mountain View, Calif. It will be used in aircraft research programs where small performance changes caused by subtle design changes must be evaluated.

The system, developed by Honeywell's Systems and Research Center in Minneapolis, focuses a carbon-dioxide laser beam 20 meters ahead of the aircraft, where the air is undisturbed by the bow wave of the fuselage. The system's infrared sensor detects backscatter from aerosols—particles of moisture—in the atmosphere and measures a

doppler shift in frequency that is proportional to the aircraft speed.

Tests conducted in clear air with a visibility of 30 miles gave accurate readings at speeds of 10 to 520 mph at altitudes up to 10,000 feet.

The system itself consists of the carbon-dioxide laser, an optical system made up of a co-linear transmitting and receiving telescope, an infrared window, an infrared detector and electronics for tracking the frequency shift and presenting results digitally.

## BART system problems under close scrutiny

Hearings are currently underway at the California Public Utilities Commission to get to the bottom of allegations that Bay Area Rapid Transit (BART) system is unreliable and unsafe. The hearings come two months after the accident last October 2 in which a BART train ran off an embankment.

Critics of BART have noted that the system seems to have insufficient redundancy or backup capability and is incapable of detecting a "dead" or disabled car on the track.

Although, not part of the contract, dead car detection is currently under study by the prime contractor for train control on Bart, Westinghouse Electric Co. of Pittsburgh.

Contacted by ELECTRONIC DESIGN, Howard Miller, the division engineering manager for Westinghouse in Emeryville, Calif., admitted: "We have had some problems with reliability in the train control, propulsion and other electronic systems. Besides the malfunctioning crystal that caused the accident, we've found several other minor problems that are now being corrected. As in all electronic systems, problems pop up that were never anticipated theoretically and in laboratory tests."

Miller pointed out that typical of the problems is a diode used for transistor protection which has been burning out due to noise spikes. This diode is being replaced.

Other problems have involved connectors shielding and various other components. Miller emphati-

cally states that none of the problems so far detected, other than the malfunctioning crystal that caused the train accident, can compromise system safety.

Inability to detect a dead car—one that is drawing no third rail power—results from a rust film buildup on the wheels of the car and on the tracks. This film increases the shunt impedance that the car presents across the track from a few milliohms to a few ohms.

Car detection is by a conventional fixed block technique, a block being a given number of feet of track. At the beginning of the block a transmitter sends a coded ac signal down the track to a receiver at the end of the block. A train in the block shunts the track and keeps the signal from ever reaching the receiver. Since the ballast impedance of the track can be as low as 5 ohms in certain types of weather, the train must present an impedance substantially lower than that. The standard in the industry is 0.06 ohms.

Miller told ELECTRONIC DESIGN that several types of corrections are being considered. They include: scrubbers on the wheels to clean the rust off; stainless steel beads on the track to increase the surface area of the wheel-track interface and an additional contact that would drop from the car to the track in case of power failure.

## Extra line feeds speed telescope's data input

The National Science Foundation has increased the data-handling capabilities of its 1000-foot-diameter radio telescope near Arecibo, Puerto Rico, by connecting 10 line feeds to the telescope instead of the usual one. The speed of data collection has been increased by a factor of 10.

This technique cannot be used on all radio-telescopes, however—only on those that are spherical in shape. A spherical reflector can have many simultaneous feeds, each mounted on a different radial line.

The feeders for the Arecibo telescope are arranged in two rows of five lines each and operate at 611 MHz.

GENERAL  ELECTRIC

# OPTOELECTRONIC COUPLER LINEUP

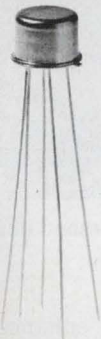
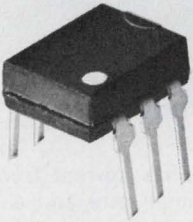
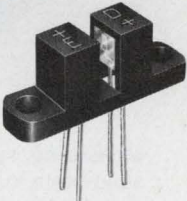
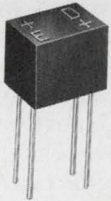
			
<p><b>H10 SERIES COUPLERS</b></p> <ul style="list-style-type: none"> <li>• 3 hermetically packaged models offer choice of SSL-Photo-transistor, SSL-Photo-darlington and SSL-light sensitive SCR</li> </ul>	<p><b>H11 SERIES COUPLERS</b></p> <ul style="list-style-type: none"> <li>• 6 models offer interchangeability with popular industry types</li> <li>• H11A1 and H11B1 offer 50% and 500% min current transfer ratios respectively</li> <li>• 2,500V isolation</li> </ul>	<p><b>H13 SERIES INTERRUPTER MODULES</b></p> <ul style="list-style-type: none"> <li>• 4 models offer "no contact" switching for use with shaft encoders, counters, position sensing, keyboards and limit switch application</li> </ul>	<p><b>H15 SERIES COUPLERS</b></p> <ul style="list-style-type: none"> <li>• 4000V isolation</li> <li>• 4 low cost models for pulse transformer replacement, SCR and TRIAC triggering</li> <li>• Solid State reliability at low cost</li> </ul>

OUR NO. 1 GOAL:  
TO MAKE  
GENERAL ELECTRIC  
YOUR BEST BUY



**AVAILABLE NOW FROM  
YOUR AUTHORIZED  
GENERAL ELECTRIC  
DISTRIBUTOR**

## THE OUTLOOK FOR 1973

# With LSI, you'll get more instrument punch in a much smaller package at a lower price

**Stanley Runyon**  
Associate Editor

This year will be the year of the miniature, low-cost instrument. The reason? The use of LSI, introduced in instruments last year, should increase dramatically in 1973. And just in time, too. Soaring sales of digital, data-processing, communication and medical and industrial electronics equipment have increased demands for field service and for small, portable instruments.

At the same time executive engineers in the industry see major growth at the opposite end of the size/cost scale—in instrument systems.

John Zevenbergen, president of the Fluke Manufacturing Co., Seattle, says his company is incorporating LSI in instruments wherever practical. He feels that in addition to portability LSI offers the best of two worlds: lower cost and increased performance. And with the newer commercial and industrial markets demanding better field service, Zevenbergen says that LSI offers another benefit—greater reliability.

John Young, vice president and executive head of the Hewlett-Packard Electronic Products Group, Palo Alto, Calif., agrees that increased use of LSI plus other new technology—such as CMOS—will contribute to important changes in instrument design.

Young expects a growing need for instrument systems to replace technicians. Such systems, he suggests, can start out as compatible,

The 1973 outlook for military, space and industrial electronics will appear in the January 18 issue of *Electronic Design*.

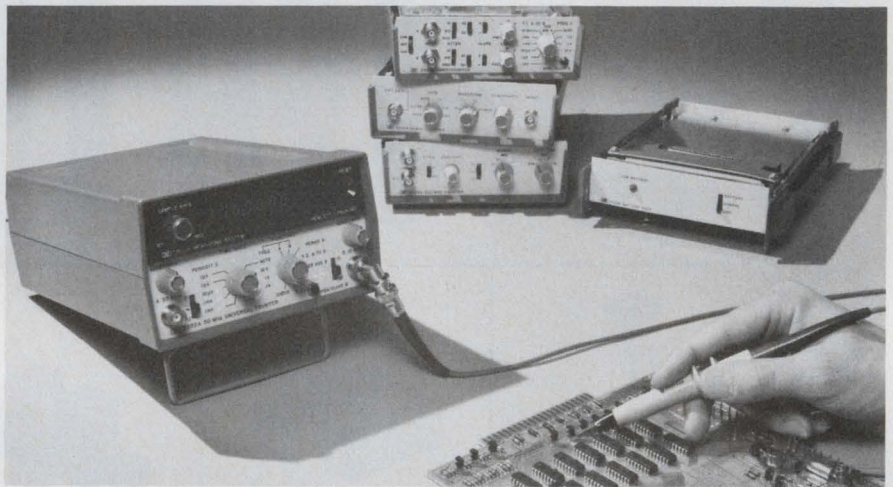

Measuring system typifies current trends in instrument design: LSI circuitry, solid-state displays, small size and easy servicing.

calculator-based units and be upgraded or integrated into larger computer-based systems.

William Walker, vice president of engineering at Tektronix, Inc., in Beaverton, Ore., agrees. He sees growth of the systems concept as one of two major instrument trends. The second trend, he says, is toward simpler instruments.

### Two types of systems

Walker splits systems into two categories: The first is the large, dedicated system with at least a PDP 11 either chewing up the measurement information or controlling the system. At the opposite end of the spectrum is Tek's integrated systems concept, which first ties together various measurement functions—such as counters, DVMs and scopes—and then adds a calculating or computing capability.

Spurring the trend toward systems, Walker continues, is the fact that a United States advisory committee is reported close to agreement on a standard for interfacing

that will enhance instrument use in data-acquisition systems. The standard, to be adopted by the International Commission for Electrical Standards, is basically a byte-serial, bit-parallel scheme that permits interconnection of instruments by plug-in cables.

Walker also sees increasing use of LSI. "It lends itself to doing a lot more for less cost," he explains. "Whenever you can use, say, MOS LSI in a particular section of instrumentation, the prices come rolling down."

A few years ago, when Government contracts were in abundant supply, engineers were buying more sophisticated instruments than they really needed to do the job. Today there is a tight check-rein on this tendency. Walker, HP's Young and Zevenbergen of Fluke agree that instrument buyers have become more cost-conscious. They want simplicity in instruments and just enough accuracy to do the job well.

In addition many new markets for instruments—vocational education, automobile manufacturing

and servicing and the medical field—can't stand long down-times, Zevenbergen notes; the new instruments must be geared for fast service.

What specific new instruments will we see in 1973? The instrument makers aren't saying. But HP's Young suggests a broad area that is under investigation:

"The trend to digital has produced large-scale troubleshooting problems. When a fault develops on a circuit board with something

like 60 IC packages on it, you can't afford to discard it, and maybe you can't afford a duplicate while the factory finds the fault for you. When something like that happens on a circuit under design, you need a way to find out if the fault is in the over-all design or on a chip somewhere."

Tek's Walker expects a trend toward getting more out of a measurement. He says: "There will be some major steps taken to deal with waveforms and signals to ex-

tract more information from them." When asked if this meant a possible tie-in with a computer, he replied: "That could be a piece of it, but not all of it."

Tektronix, Walker continues, is also taking a look at some measurements now made mechanically with transducers. It hopes to come up with instruments that will see what's going on in real time. Thus, Walker hints, the user will be able to see pressure, temperature, force or strain in a transient way. ■■

## NMOS and CMOS are surging forward in drive to dominate semiconductor scene

**Edward A. Torrero**  
Associate Editor

While complementary MOS (CMOS) will continue to make major inroads in applications once dominated by TTL—especially where low power is required—n-channel MOS (NMOS) should come into its own this year with the introduction of 4-k RAMs.

It figures: In virtually every year since the invention of the transistor, components have tended to become smaller—and therefore denser—and faster.

Most industry observers believe the 4-k RAM will become the next standard RAM, following the 1-k 1103 (originally introduced by Intel). In the competition between semiconductor memories and core, the 1103 signaled that memory chips were available with the right density and speed for mainframe applications.

Two companies are offering random-access memories with 4096-bit, n-channel chips as the basic building block. Microsystems International Ltd. of Quebec, Canada, has a memory system—the RAM 4A—that consists of ten 4096 chips on a single card. It consumes just 150  $\mu$ W/bit, compared with 1 mW/bit for equivalent core and 300  $\mu$ W/bit for 1103 types. The RAM 4A's initial price is 1¢/bit, but the company says it expects to cut this in half within two years.

Standard Microsystems of Sunnyvale, Calif., has the other entry: its COPLAMOS process. The com-

pany is reporting speed/density advantages over the standard n-channel process and says it has achieved a read access time of 180 ns. Other companies believed to be working up a 4-k, n-channel RAM are Intel, Mostek, American Microsystems and Motorola.

Meanwhile CMOS will also continue to enter new markets. Though RCA's CD 4000A series should still predominate, the ICs of other manufacturers will probably penetrate such areas as the automotive industry.

In fast logic, Schottky TTL and ECL 10,000 will continue to compete. But watch for more second-sourcing of Motorola, TI and Fairchild fast logic.

### Bipolar MSI logic gains

Though MOS will continue to grow in use, Advanced Micro Devices of Sunnyvale, Calif., expects bipolar MSI logic to outsell any other type of logic. The use of PROMs should also increase.

Digital subsystems on a chip are continuing their drive toward higher complexity in 1973, filling demands in areas other than calculators and microprocessors.

Linear ICs should also grow in complexity and number of functions. The faster comparators that will be appearing will be TTL as well as ECL-compatible. The quad op amps from Motorola in Phoenix, Ariz., and National Semiconductor of Santa Clara, Calif., will be better and faster than discrete op

amps, and they will lower the price of a single op amp to a new low.

Refinements in the manufacturing processes of components will contribute to density increases. Fairchild's Isoplanar, Raytheon's V-ATE and Motorola's VIP processes—now turning out bipolar ICs—may be expanded to MOS. Fairchild is reported working on an Isoplanar process for MOS devices.

The action in passive components is focusing on thick-film and hybrid circuits. Thick films will expand in function from continuously variable resistors to quasi-active switches and other areas. Hybrids will penetrate the automotive industry and other markets as better manufacturing techniques lower their cost. And more ion implantation is foreseen.

Ceramic thermal switches will appear during 1973 for de-current control applications. Avalanche devices will control large currents of several amps compared with only microamps at present. The new devices are expected to threaten relays.

Because of their attractive price, more molded tantalum capacitors will be used in 1973, according to Sid Chertok, manager of information services for Sprague in North Adams, Mass.

And connectors will seek to match the improved density and cost of components. Watch for non-noble contact platings to become more popular. ■■

*(continued on page 32)*

# The new minicomputers: Faster, sophisticated and a choice of MOS or bipolar memories

**Jim McDermott**  
Eastern Editor

"The emphasis in the minicomputer industry has traditionally been on price and performance, but today the industry is developing faster electronics."

That's one major trend that Andrew Knowles, vice president of the Digital Equipment Corp. in Maynard, Mass., sees for 1973. Others he says, include these:

- Faster logic.
- Both MOS and bipolar memories.
- Multiple bus systems.
- Multilayer boards.
- MSI and LSI in microprogramming.
- Increasing manufacturer costs, and emphasis on software rather than hardware.

As an example of developments aimed at increasing computer speed, Knowles points to the DEC 1145.

"This machine," he says, "uses the highest-speed TTL that we could find—Schottky devices from Texas Instruments."

The 1145 also uses both MOS and bipolar memories, the latter to accommodate the fast memory.

"In addition," Knowles explains, "the 1145 is a multibus unit. It has a fast-memory bus, a slow-memory bus and an in-out bus that is combined with the slow-memory bus."

This type of design, he points out, reflects the tendency of computer manufacturers to distribute the computer power among several buses—much as they did with the advent of the third and fourth generations of large systems, when they used multibuses and multipoint memories. The development of minis is toward the architecture of larger systems and faster equipment.

One of the newest design features is that of multilayer boards. "Instead of simple two-sided boards," Knowles notes, "we're

using multilevel boards of three and four discrete layers."

The use of microprogramming techniques is definitely on the increase in the minicomputer field. Here, Knowles says, the minis are making heavy use of MSI and LSI either for the execution of the instruction set or for user microprogramming.

The result, the DEC president points out, is better performance with lower costs.

With such microprogramming substituting in many cases for additional hardware, the emphasis in mini system design is more and more on software instead of hardware, Knowles says.



**Next year's minicomputers** are expected to offer faster logic and supporting electronics along with MOS and bipolar memories.

The tendency among mini manufacturers now, he believes, is to spend more money on systems monitors that allow the peripherals to interplay with the central processor and thereby handle much traffic and scheduling formerly done by the programmer.

As a result, operation of the machines is becoming substantially simpler. Originally, Knowles points out, a programmer had to be a near scientist; now grammar-school

children can program these machines. But software costs are gradually rising higher than the hardware as a result, the DEC executive says.

While today the so-called virtual memory is associated with large computers, like IBM and Burroughs machines, Knowles predicts that minicomputers will use the technique eventually.

The virtual memory is provided essentially by the use of rotating memories, like discs, to store address information ordinarily considered to be in the main core memory. When the user runs out of address space in the core, the disc file provides added memory space that can be accessed faster.

"When our miniprogramming and our monitors run out of core," Knowles notes, "then virtual programming will be the next step."

No spectacular breakthroughs are likely in peripherals this year, according to Robert Schuck, director of OEM marketing for the Mohawk Data Sciences Corp., King of Prussia, Pa. He sees the present third generation of peripherals—those with the latest mechanical approach and full TTL electronics—going through a refinement.

## More efficient tape drives

Tape drives are becoming more efficient and easier to service, he says, pointing to the Mohawk 4025, which provides a tape speed of 125 inches per second in a rack mount.

For both printers and card readers, the trend, Schuck says, is toward greater reliability and easier maintenance. Cassette cartridges, for example, are headed for greater use as memories. Mohawk has chosen the 3-M cassette, Schuck reports, because data can be loaded onto it at about 1600 bpi, with a resolution of at least one bit in  $10^8$ . This performance is produced on 1, 2, 3 and 4-track recordings. ■■

(continued on page 34)

# Putting innovation to work.

**One  
GaAsLITE,  
two  
colors.**

## Think what you can do with our new bi-color and AC GaAsLITEs:

We've taken two light-emitting diodes and put them in one pop-in panel mounting package. Result? A tri-state device (*red, green, and off*) that is a nifty nulling circuit all by itself. Or a battery charge-discharge indicator. Or a self-contained polarity meter. Or whathaveyou.

ON DISTRIBUTORS' SHELVES:

**MV 5094**  
AC RED 0.8 mcd @ 20 mA (typ.)

**MV 5491**  
RED/GREEN  
1.5 mcd @ 20 mA (typ.) RED  
0.5 mcd @ 20 mA (typ.) GREEN

AVAILABLE ON FACTORY ORDER:

**MV 5591**  
RED/YELLOW

**MV 5691**  
YELLOW/GREEN

**MV 5291**  
AC GREEN

**MV 5391**  
AC YELLOW

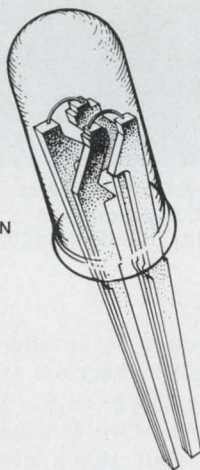

## AC GaAsLITEs

By putting two red, green or yellow chips in the package, we give you the world's first line of AC light-emitting diodes. Run them with up to 110 V and a simple resistor. No flicker. Prices start at 99¢ (1,000's).

So call your distributor for your first quantities or the data sheet.

**Monsanto Commercial Products Co.**  
Electronic Special Products  
10131 Bubb Road  
Cupertino, California 95014  
Phone: (408) 257-2140

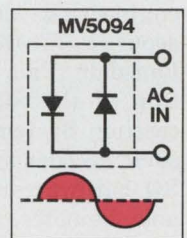

Distributed by: Alta Electronics, Elmar Electronics, Hammond Electronics, Kierulff Electronics, Kierulff/Schley, Liberty Electronics, Schweber Electronics, Semiconductor Specialists, Wesco Electronics, Western Radio; Canada: Canadian Dynamics, Ltd., Cesco Electronics, Ltd.

# Monsanto

INFORMATION RETRIEVAL NUMBER 20

## Color television swinging to in-line tubes as complex ICs widen consumer market

**Jim McDermott**  
Eastern Editor

Greater use of new short, in-line-gun color tubes, the inclusion of more automatic circuits and increased emphasis on all-electronic varactor station tuners are developments in color television that Dan Schuster, Sylvania's vice president of engineering in Batavia, N.Y., sees over the next two years.

An increasing number of portable color TV sets will incorporate the in-line tubes, Schuster says. The reason? Lower ultimate costs. While the in-line tubes cost about the same as present comparable units, the in-line system permits simplification of the convergence circuitry. In-line tubes are also shorter, so a slimmer cabinet can be used. And Schuster notes that these tubes can be more easily adjusted at the factory and in the field.

For consumer entertainment sound systems, Richard F. Wood, engineering manager of electroacoustics for the Philco-Ford Corp., Lansdale, Pa., looks for incorporation of the SQ (Columbia Broadcasting System) type of quadra-sonic decoder system this year. The SQ hardware is now readily available, he notes, and there are a relatively large number of SQ records on the market.

But within two or three years, Wood feels, discrete four-channel recordings and playback systems will be the next step.

### Increased use of ICs seen

Norman Doyle, consumer applications manager for Fairchild Semiconductor, Mountain View, Calif., says that the next area of development in ICs for television will be that of the video channel. In AM/FM radios and sound systems, he sees many different IC circuits being produced. And Doyle sees ICs being used in systems for the new video recorder-players.

Automobile and camera manufacturers will be using newly developed ICs this year, Doyle continues. Predictions are, he notes, that by 1980 the automotive IC market will be worth \$1-billion annually, while cameras will account for more than \$300-million in sales.

The trend, Doyle points out, is toward more complex ICs. "Our customers want more and more of the external components built onto one chip," he says. As a result, chip sizes are increasing. For consumer ICs, Doyle notes, Fairchild now has 10,000-square-mil chips.

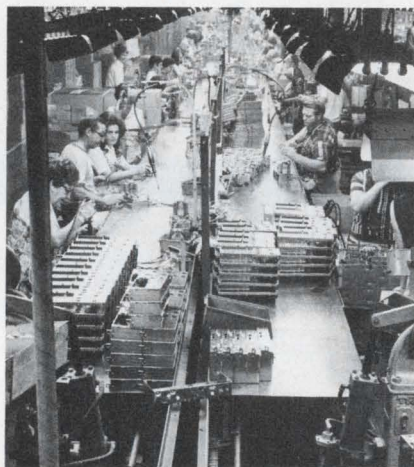

Television receivers are assembled on the production line at RCA's TV facility in Bloomington, Ind.

Power is an important area in which IC barriers are being pushed back, Doyle says. "Right now," he reports, "we can make 10-W audio ICs. But that's probably as high as we're going to go in the foreseeable future."

Frequency response is also being increased, Doyle says. For present devices, the gain-bandwidth product is about 150 MHz. "But by applying the isoplanar process to ICs," Doyle says, "we can see an increase in the bandwidth product by an order of magnitude. And another advantage is that this process

gives increased circuitry density on a chip, leading to a more cost-competitive end product."

Arthur M. Liebschutz, market planning manager for RCA's Solid State Div. in Somerville, N.J., sees 1973 as the year in which high demand for ICs will curtail their development. Semiconductor manufacturers will be too busy filling orders to divert too much effort to R&D, he explains.

The reasons for high demand, he says, include these:

- Overseas markets are expanding.
- The use of automotive ICs in large quantities is beginning, with ICs to be used in seat-belt sensor systems for 1974 cars.
- ICs in television receivers are on the rise.

The replacement of conventional off-the-line ac power supplies with miniature, high-frequency supplies is not far off, says Leo Lehrer, product manager for power transistors at Motorola Semiconductor in Phoenix, Ariz. He sees what he calls the "20-kHz revolution."

He expects these low-voltage, high-current power supplies to replace high-voltage, low-current supplies in solid-state entertainment products.

Within five or six years, Lehrer says, 5-V, 200-A supplies delivering 1 kW may operate toasters. Shock hazards will be substantially reduced.

In electronic watches—a rapidly growing consumer area—there will be more of an evolution than a revolution, according to Richard Kaury, marketing product manager for Micro Power Systems, Inc., Santa Clara, Calif. For power sources, he sees production use in a few years of 1.5-V and 15-V lithium batteries. The 15-V unit, he says, will be able to operate liquid-crystal displays directly, thus eliminating the step-up converter now required with 1.5-V batteries ■■



# Nothing can loosen our new connector.



## Nothing but an easy pull straight up.

The secret's in the "Chinese finger" design of the receptacle contacts. The more you vibrate them or the harder you pull on their terminated wires, the greater their grasp on the mated posts.

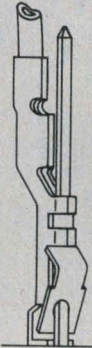

So the only way to unmate our new Locking Clip Connector is to give the housing a gentle pull straight up.

Retention is excellent, with average insertion and withdrawal forces.

*Unique contact design principle provides maximum retention, with minimum insertion and withdrawal forces.*



The Locking Clip Connector mates with .025" posts on a true grid. Receptacle contacts are tin-over-nickel plated by a unique process which makes them approach the performance of gold. The connector is available in 4-, 10- and 20-position configurations and will accept #26 to #30 AWG wire. Contacts can be terminated by high-speed, automated machines for uniform reliability at low applied cost.

For more information on the AMP Locking Clip Connector, circle bingo number 35, or write AMP Industrial Division, Harrisburg, Pa. 17105.

# AMP

INCORPORATED

# 3 years after birth, CCDs head for first commercial applications

Charge-coupled devices (CCDs) have always been a technology to watch. Because they have a minimum of diffusions and metal substrate contacts, they are capable of high packing densities, low power dissipation, high yields, increased complexity and low costs.

**Jules H. Gilder**  
Associate Editor

According to most experts in the field, 1973 will see significant CCD developments and the first commercial applications of these devices. Since their introduction in 1970, much has been written about their promise, but only with recent advances in CCD technology has it been possible to turn the promise into reality.

Among the advances expected

this year are these:

- Commercially available CCD image-sensor arrays.

- Inexpensive black-and-white television cameras for use in security and surveillance systems.

- High-quality black-and-white and color television cameras for broadcasting studios.

- CCD serial computer memories.

- CCD analog signal processors.

Much of the work being done on charge-coupled devices is in the area of imaging. This has been spurred by support from the military, which is interested in low-light television applications.

Brown Williams, manager of the electro-optics laboratory in the RCA Electronic Components Div., Princeton, N.J., says that CCD image sensors will be used not only to replace electron-beam-scanned camera tubes but also to replace other solid-state imagers. And, because they will be relatively inexpensive, CCD sensors will turn up in home-security and home-entertainment systems, he adds.

In pointing out the advantages of CCD imagers, Williams compared them with the presently used image sensors. He noted that vidicons—the most widely used device—need a high voltage to operate and have many bulky components, such as deflecting coils. In addition they are fragile.

CCDs, Williams points out, can operate from low voltages—10 to 15 V typically—and since the sensors are inherently self-scanning, there is no need for bulky deflecting coils. This self-scanning property also gives CCDs an edge over silicon-diode-array image sensors, which require complex scanning circuitry.

Another advantage of CCDs over silicon diodes is that they are easier to manufacture, Williams



Color image formed by Bell Labs' CCD television camera reveals that the principle is sound but the resolution is poor. Higher-resolution cameras are expected to be available before the end of the year.

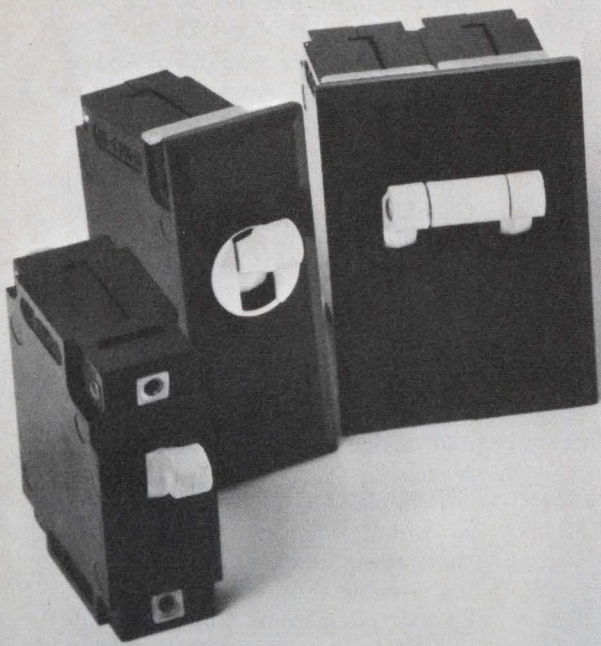

Toggle handles in white. Rocker handles in white, gray, black, or custom colors. Rectangular pushbuttons, lighted green for ON, white for OFF. Cylindrical pushbuttons, not lighted at all. An environment-protected model with a sealed bat handle. A model for fast snap-in mounting.

Our Type J line.

Circuit breakers have never looked so good before.

You don't have to settle for homely circuit breakers anymore.

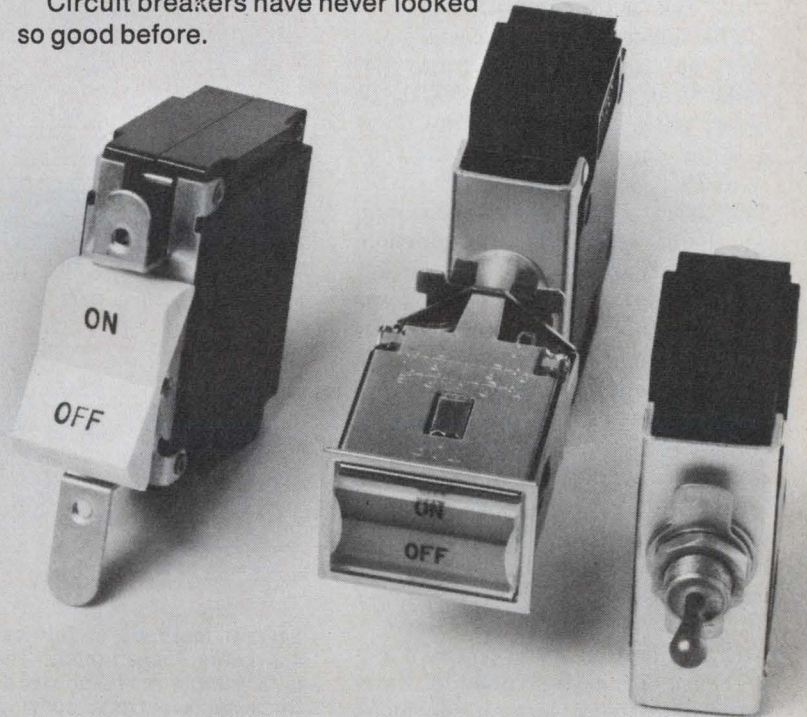

They're hydraulic-magnetic, of course, and therefore offer you exceptional performance capabilities: precise, temperature-stable current ratings and trip points; a choice of time-delay characteristics (or non-time-delay operation); the option of a half-dozen special-function internal circuits.

All are available for operation on any of the commonly used DC or AC voltages (60Hz or 400Hz). In any current rating from 0.020 to 30 amp.

All are reasonably priced. Even in modest OEM quantities.

We'll be glad to send you detailed technical literature. Just tell us to whom and to where. Heinemann Electric Co., 2616 Brunswick Pike, Trenton, N.J. 08602.



**HEINEMANN**

INFORMATION RETRIEVAL NUMBER 22

says. The charge-coupled devices do not require any diffusions to form the sensing elements, whereas silicon diode arrays require a few hundred thousand diffusions.

Last year both Bell Telephone Laboratories and RCA demonstrated that it was technically feasible to build television cameras with charge-transfer devices.

The approach taken by Bell used charge-coupled devices to produce a color television camera, while RCA used a bucket brigade—another type of charge-transfer device—to construct a black-and-white television camera.

The bucket-brigade sensor, however, has limitations that may not make it as popular as the CCD. To begin with, bucket brigades have a lower charge transfer efficiency—99.9% vs 99.999% for CCDs. They also have a lower maximum operating frequency. In addition, notes RCA's Williams, the bucket brigades require four diffusions for each element, whereas CCDs require none. The bucket brigade does have one advantage, however: Since it is essentially an integrated version of a discrete circuit, any company capable of manufacturing MOS integrated circuits would have very little trouble making them. The devices will probably find application in filters and delay lines, Williams says.

RCA, like General Electric, Westinghouse, Texas Instruments, Fairchild and others, sees an enormous market for CCD imagers in the next two years. These manufacturers believe that home-entertainment systems, such as portable video tape cameras, will use large quantities of the devices. One company goes so far as to say that in two years it expects to see a repeat of the calculator craze, with everyone buying miniature television cameras this time.

In an attempt to capture a large share of the CCD imager market, General Electric at Schenectady, N.Y., has switched its operations from memory-oriented devices. William Engler, a member of GE's research and development staff, says the company will have a CCD imaging chip on the market before the end of the year.

While most industry estimates indicate that CCD television cameras with commercial resolution

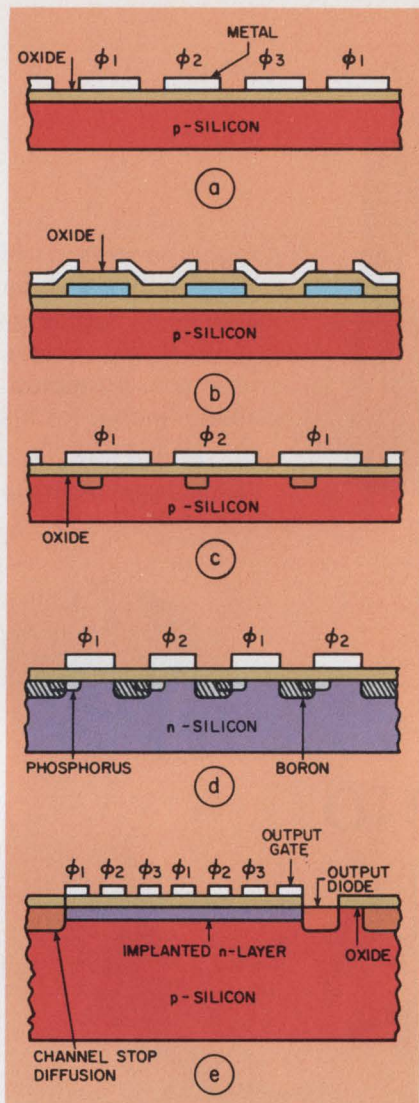

Several methods of fabricating CCDs are being investigated. The first (a) is a simple three-phase device, but the close electrode spacings are difficult to produce. Two-level metalization CCDs, either two-phase or four-phase devices, (b) eliminate spacing problems. Two-phase operation can also be obtained by using an ion-implanted-barrier CCD (c). And an improvement over the implanted-barrier device is the conductively connected CCD (d) which also alleviates the spacing problem. The buried-channel CCD (e) eliminates the trapping effects of interface states and promises a more efficient device.

will be available in two years, at least one manufacturer is pushing to have one developed by the second half of this year.

Most of the funding for current work in CCD imagers is being done by the military. Edwin N. Myers, staff specialist in electronic science for the Director of Defense Research and Engineering in the Pentagon says:

"We'd like to have a completely

solid-state imager that is within a factor of 10 as sensitive as the intensified silicon-diode camera tube used in low-light-level TV."

He adds: "We would like a spectral response that would enable us to pick up neodymium laser illumination."

The Navy Electronics System Command is coordinating all military CCD work. Plans are to invest a total of \$3-million for research and development of CCD imagers. Fairchild, RCA and Texas Instruments are the recipients of the Navy money and each must deliver a 100-by-100 element array and a 500-by-1 element array by March.

Progress in CCDs is advancing so rapidly, however, that by the time these devices are delivered, it's possible that larger devices will be near completion. Both Fairchild and RCA are working on larger devices that should be finished by the second half of 1973.

### CCDs challenge serial memories

It looks as if CCDs will provide some tough competition for computer memories, says Dean Toombs, director of group engineering for Texas Instruments in Dallas. Since the devices are basically shift registers, he notes, their applications in memories will be limited to serial memories.

Toombs points out that CCD memories are potentially cheaper than presently available systems, and he sees them finding application as replacements for disc and drum types. CCDs, he says, can be used wherever MOS shift registers are presently in use.

The advantages of CCDs, notes Toombs, are a two to fivefold increase in density, simpler processing and lower cost.

IBM agrees that CCDs have great potential in memory applications, and it has even constructed an experimental memory using them (see "Charge-Coupled Devices Await Mass Application by Industry," ED 6, March 16, 1972, p. 27).

More recent work by IBM has shown that with conventional processing, high density, very long (128-bit) p-channel CCD structures can be produced. These devices are capable of being clocked

# Bendix printed circuit board connectors put an end to close order drilling.

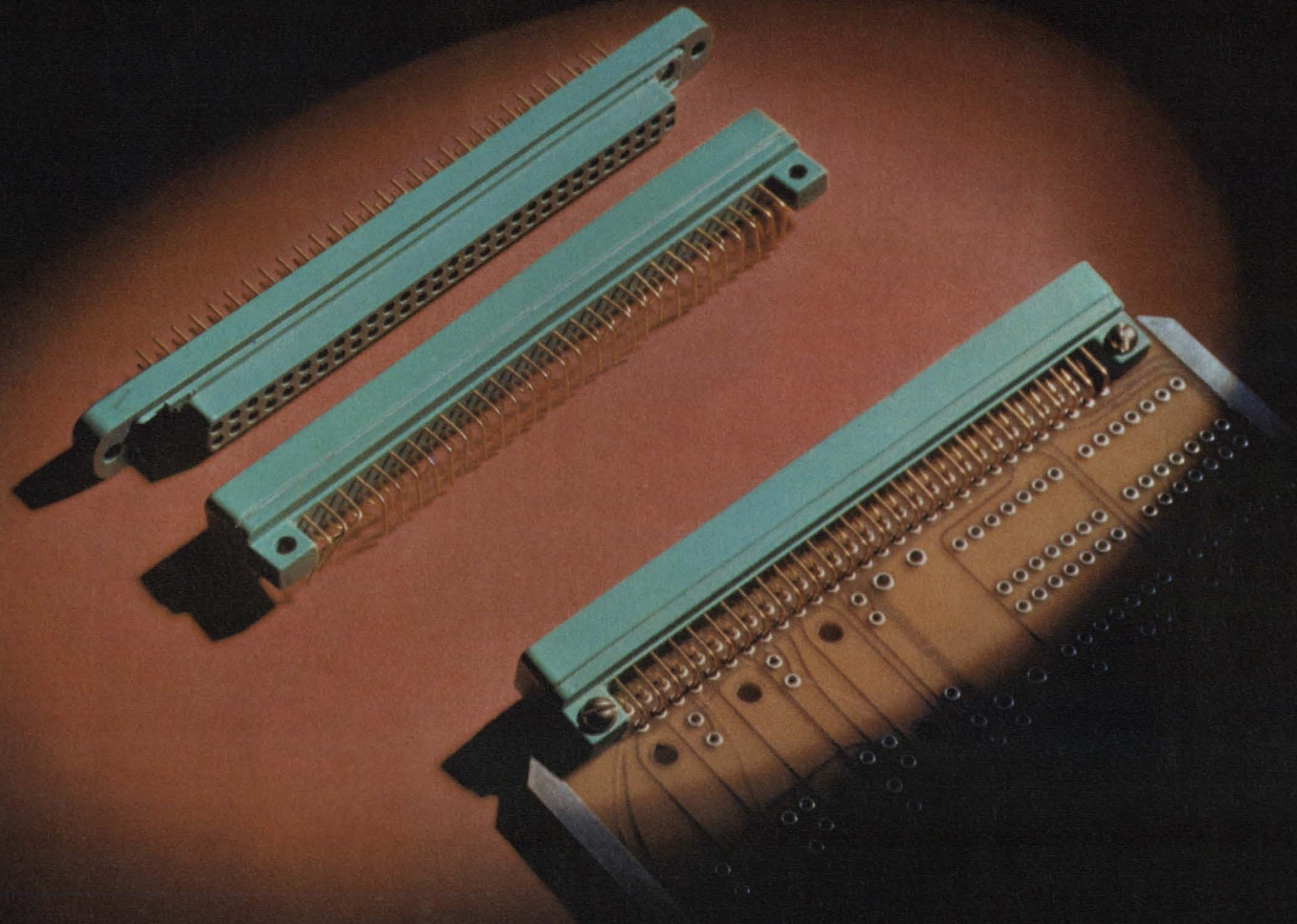

You know close order drilling. It's what's called for to produce ultraprecise hole locations in printed circuit boards. Eliminate this need and you'll cut costs for sure. Bendix P.C.B. connectors help you do precisely that. Their optional floating pin terminations "give" enough to make it easier to align pins with the printed circuit board holes.

Bendix boasts other features, too. Options like solderless wrap or solder ter-

minations. Straight or right angle. Insertable crimp contacts.

Applications? Wherever printed circuit boards are used, such as switching circuits, computers, business machines, process controls, etc.

Chances are, Bendix Printed Circuit Board connectors can help you. Why not find out. The Bendix Corporation, Electrical Components Division, Sidney, New York 13838.

**Bendix**

in the 10 to 20 MHz range. One major problem noted by IBM researchers is that very large, high-density CCD arrays require driving power densities that are difficult to provide. As a result, the development of a nonoverlapped-electrode, gapless CCD may be integral to the density-performance capability of these devices.

James Carnes, a member of the

technical staff at RCA, says that for CCD memories to be viable, they must break the 0.1-cent-per-bit barrier. The area required for each bit should also be less than 1 square mil per bit, he adds.

In visualizing the size of future CCD memories, Carnes says that a 200-by-200-mil chip should contain a memory of between 30 and 50 kilobits, while a 500-by-500-mil

chip should be able to accommodate memories of 250 kilobits.

An interesting point made by Carnes is that the same basic masks used to make an imager can be used to make a memory device.

When asked when he thought CCD memory chips would be available, Carnes said that they probably would be developed by the end of 1973. ■■

## The CCD and the BBD: They're unlike semiconductors

Charge-transfer devices are fundamentally different from the semiconductors that most engineers are familiar with. They use the controlled movement of electric charge to perform their functions, and they are generally classified two ways: as *charge-coupled* devices and as *bucket-brigade* devices. The general operation of both is similar, but there are important differences in fabrication.

**Charge-coupled devices** (CCDs) are simple in structure and consist of three layers: the semiconductor material, an oxide layer and the metal electrodes. They are basically junctionless devices, except for small, diffused p-n junctions at the input and output of the CCD shift register. In addition long registers may contain refresh cells, which also require diffusions.

The operation of a CCD requires that electrical charge in the form of minority carriers be transferred from the region under one electrode to another. The charge represents information and is moved by control of the voltage applied to the electrodes.

When information (negative voltage) is applied to the input gate, a channel in the n-type material opens up and draws positive charges from the input p-n junction to the region under the gate (Fig. a).

When a negative voltage is applied to electrode 1, evenly distributed electrons in the n-type material are driven downward, away from the electrode, leaving a region of depleted electrons just below the oxide

layer. This depletion region produces a potential well (Fig. b).

Positive charges passing through the channel under the input gate are drawn to electrode 1 and stored in the potential well, provided that the electrodes are close enough to allow coupling.

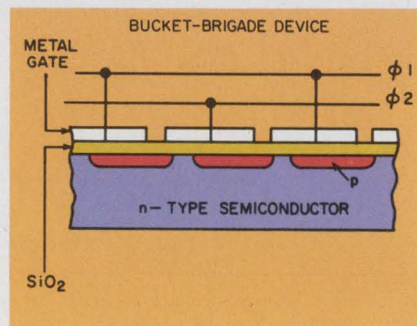
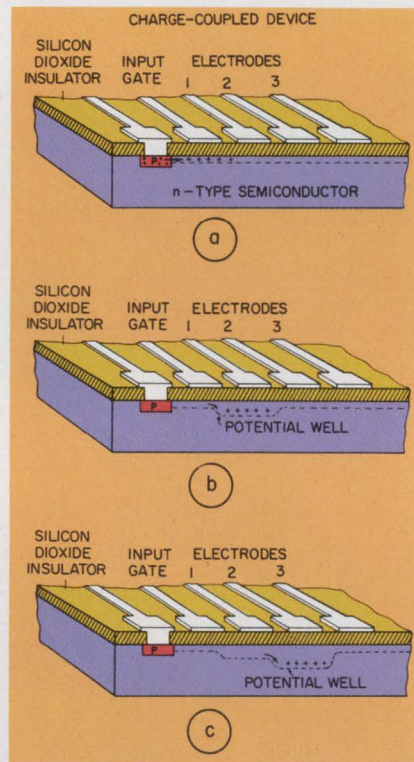

The information—positive charge—can be transferred from electrode 1 to electrode 2, by application of a negative voltage to electrode 2 and reduction of the voltage on electrode 1. This transfer voltage forms a deeper potential well under electrode 2, and the information flows to the well under electrode 2. Thus by proper manipulation of electrode voltage, information can be transferred (Fig. c).

The simplest CCD is a three-phase device in which electrodes 1, 2 and 3 form a single memory cell. Information is stored under only one electrode while the two others provide isolation.

**Bucket-brigade devices** differ from the CCDs in that they can be constructed from discrete components. Information is stored as majority carriers and transferred as minority carriers. Storing occurs in an array of capacitors as charge deficit. Charge-transfer circuits consisting of MOS transistors allow the charge deficit to move from one capacitor to the next.

The structure of the bucket brigade (lower figure) reveals that charge is stored in offset p-regions under MOS capacitors and that it is a two-phase device. When a negative voltage is applied to an electrode, the diffused area underneath it becomes reversed-biased and inverts the channel between this diffusion and the next one. By application of the appropriate clock signals to the device, excess charge is transferred from the source of one FET to the drain of the next via the inverted channel.

# Now tin makes better pluggable IC connections than gold.

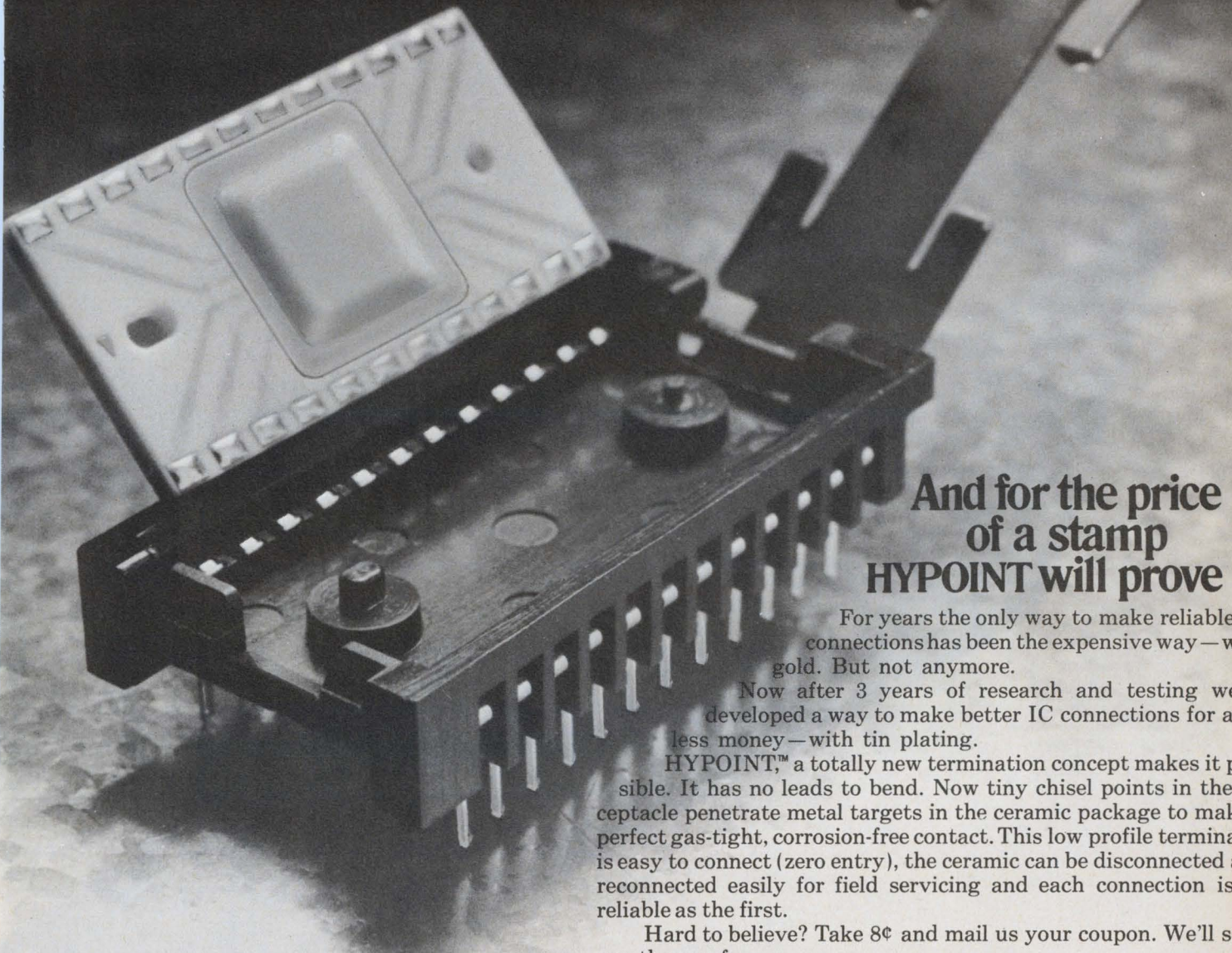

**And for the price  
of a stamp  
HYPOINT will prove it.**

For years the only way to make reliable IC connections has been the expensive way — with gold. But not anymore.

Now after 3 years of research and testing we've developed a way to make better IC connections for a lot less money — with tin plating.

HYPOINT™ a totally new termination concept makes it possible. It has no leads to bend. Now tiny chisel points in the receptacle penetrate metal targets in the ceramic package to make a perfect gas-tight, corrosion-free contact. This low profile terminator is easy to connect (zero entry), the ceramic can be disconnected and reconnected easily for field servicing and each connection is as reliable as the first.

Hard to believe? Take 8¢ and mail us your coupon. We'll send you the proof.

Please send me detailed information on your new HYPOINT tin IC terminators. Please include, too, your complete test data on its performance as compared to gold.



Name \_\_\_\_\_ Title \_\_\_\_\_  
Company \_\_\_\_\_  
Street \_\_\_\_\_  
City \_\_\_\_\_ State \_\_\_\_\_ Zip \_\_\_\_\_

Burndy Corporation  
Norwalk, Connecticut 06856

**BURNDY  
CONNECTS**

International Sales Headquarters & Manufacturing Facilities: Canada/England/Belgium/Mexico/Brazil/Australia/Japan. Sales Offices in major cities.

# NEW . . . and so simple any genius could have designed it.

# CHERRY electronic data entry

# KEYBOARD



## A NEW KIND OF KEYBOARD

with a uniquely simple design that utilizes scanning technique. Key depression causes a matrix connection between decoder and multiplexer. The LOW output of the decoder appears at the corresponding multiplexer terminal. When the counter reaches the appropriate key code, cross matrix continuity is sensed. The multiplexer then provides a HIGH output to the monostable multivibrator causing a 1 millisecond pulse. This inhibits the clock and stops the counter on the desired code.



## A NEW KIND OF KEY

with gold "crosspoint" contacts that eliminate the two main causes of contact failure—(1) formation of insulating chemical film on contact surfaces and (2) mechanical interference of foreign particles on contacts. This proven design concept (Gold prisms at right angles to each other) provides high force per unit of contact area and virtually eliminates contact closure interference from foreign particles.

# 10

### IMPORTANT "MOST WANTED" FEATURES

- 1 Low cost
- 2 Long life
- 3 Low profile
- 4 Inherent 2 key rollover
- 5 Wire "OR"able output
- 6 Low power (1.5 watt max.)
- 7 Custom designs
- 8 True typewriter sequencing
- 9 Only one power level input
- 10 High reliability

REST POSITION

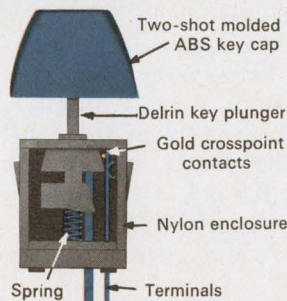

OPERATED POSITION

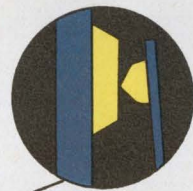

**Gold "crosspoint" contacts for unexcelled reliability**

Mechanical life in excess of 10 Million operations

FOR TECHNICAL DATA: TWX 910-235-1572 . . . or phone (312) 689-7600 ext. 7717. OR write:

# CHERRY



**CHERRY ELECTRICAL PRODUCTS CORP.**  
3600 Sunset Avenue, Waukegan, Illinois 60085

Makers of patented Leverwheel/Thumbwheel Switches, Matrix Selector Switches, Snap-Action Switches and Keyboards.

INFORMATION RETRIEVAL NUMBER 25

## technology abroad

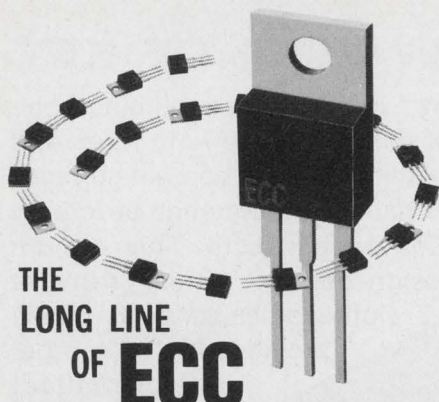

THE  
LONG LINE  
OF **ECC**

# THERMOTAB® & THERMOPAK\* TRIACS

World's leading  
Triac producer offers  
fast delivery,  
electrical isolation  
and competitive pricing.

#### THERMOTAB and THERMOPAK TRIACS (Electrically isolated tab)

- Wide current range  
 $I_{T(RMS)}$  0.8 - 16 amps
- High voltage capability  
 $V_{DROM}$  200 - 800 volts
- High surge current ratings  
 $I_{TSM}$  20 - 150 amps
- Sensitive gate triggering  
 $I_{gt}$  I, III 3, 5, 10, 25, 50 ma

All ECC triacs feature heavily glass passivated junctions for high reliability. They are available from your nearest ECC Sales Representative or Authorized Distributor.

\* trademark of ECC

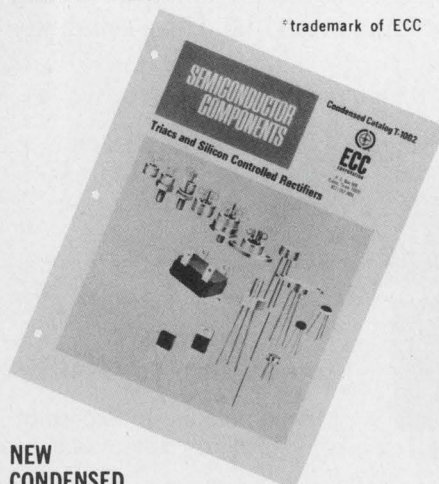

**NEW  
CONDENSED  
CATALOG** contains technical data on these  
and other ECC semiconductors.

To receive your copy, circle No. 246.

**ECC**  
CORPORATION

P. O. Box 669 • Euless, Texas 76039  
817/267-2601

The effectiveness of radio-frequency systems for pinpointing the position of aircraft and for guiding helicopters and vertical takeoff craft to safe landings in bad weather is being investigated by the Royal Aircraft Establishment, Farnborough, England. A Honeywell 316 minicomputer is part of a system set up for the studies. Using an rf interferometer, the system can cover a complete hemisphere rather than just a narrow sector. As a result, it can produce curved-line profiles needed to guide helicopters and vertical takeoff aircraft. To eliminate ambiguity of position, the interferometer incorporates additional pairs of antennas that uniquely define a position in space.

CIRCLE NO. 201

A complete AM radio receiver on a single silicon chip, using collector-isolation-diffusion processing techniques, has been produced by Ferranti of England. The circuit, which is packaged in a standard three-lead transistor, can incorporate an age network. The receiver operates over the frequency range of 200 kHz to 1.5 MHz. The radio is completed by the addition of a battery, antenna, two resistors, a variable capacitor, two fixed capacitors and a loudspeaker. The power requirement is 1.5 V at 0.5 mA. Over-all gain is on the order of 70 dB.

CIRCLE NO. 202

A system that permits television receivers to display on demand information such as weather reports, motoring and travel news, sports results, and stock market prices is being developed by the British Broadcasting Company. The system will superimpose the data on the regular TV signal.

The information will be removed from the picture by a data collection and storage unit at the receiver. The information will be stored in the form of pages that will be updated upon receipt of new information. The viewer, upon selecting a page of information, will be able to override the TV picture and present the page on the TV screen. A demonstration is to be held by mid-1973 in addition to field trials to evaluate different methods of instrumentation for the system.

CIRCLE NO. 203

A high-frequency monolithic quartz crystal filter with reduced volume and improved aging stability has been developed by AEG-Telefunken of West Germany. The filter consists of a quartz disc with several acoustically coupled resonators, plus a capacitor chip. The center frequencies of these filters are 10.7 and 15.3 MHz. Nominal bandpass is 20 to 25 kHz. The ultimate limit for the new design is calculated to be about 300 MHz.

CIRCLE NO. 204

A miniature synchronous motor reported to be of lower cost and several times more power than any previous unit of its kind has been produced by collaboration between the Electric Remote Control Co., the National Research Development Corp. and Sheffield University, all of Britain. The mini-motor, which is 32 mm in diameter by 16 mm deep, rotates at 375 rpm with 50 Hz excitation. Maximum running torque is 9400 gm-cm. Its ferrite rotor has 16 poles. The stator is composed of soft-steel precision stampings. The stator winding is embedded in glass-filled polyamide plastic.

CIRCLE NO. 205

more semiconductor measurement capability  
*at lower cost...*

if you use linear ICs  
or other semiconductors  
you need to evaluate them

The new TEKTRONIX 577 Curve Tracer offers a better way . . . Measurements of both linear ICs and discrete semiconductor devices can now be made with this single, versatile, self-contained system.

This extended capability is contained in a small, modular package consisting of storage or non-storage display modules, easy to use mainframe and versatile plug-in test units.

Many previously difficult measurements become convenient to make with split screen storage display capability. For instance, you can compare the characteristics of one device with another, or view changes in a device's characteristics while varying operating conditions or temperature.

The 177 Standard Test Fixture plug-in adapts the 577 mainframe to display characteristic curves of devices such as: transistors, FETs, tunnel diodes, SCRs and Zener diodes.

Measuring parameters of linear ICs such as

op-amps, diff-amps, comparators and regulators becomes an inexpensive, simple task when using the plug-in 178 Linear IC Test Fixture.

Think about the value of IC characteristic curves, quickly plotted over a range of inputs, not just one point. These curves with their thermal effects, phase-shift and noise are dynamically pictured on the CRT; not hidden from you as with metered testers, digital readouts or go, no-go indicators. System prices; from \$1850 to \$3200.

For technical data and measurements information contact Tektronix, Inc., Box 500, Beaverton, Oregon 97005 or call 503-644-0161.



**TEKTRONIX®**

committed to  
technical excellence

INFORMATION RETRIEVAL NUMBER 26

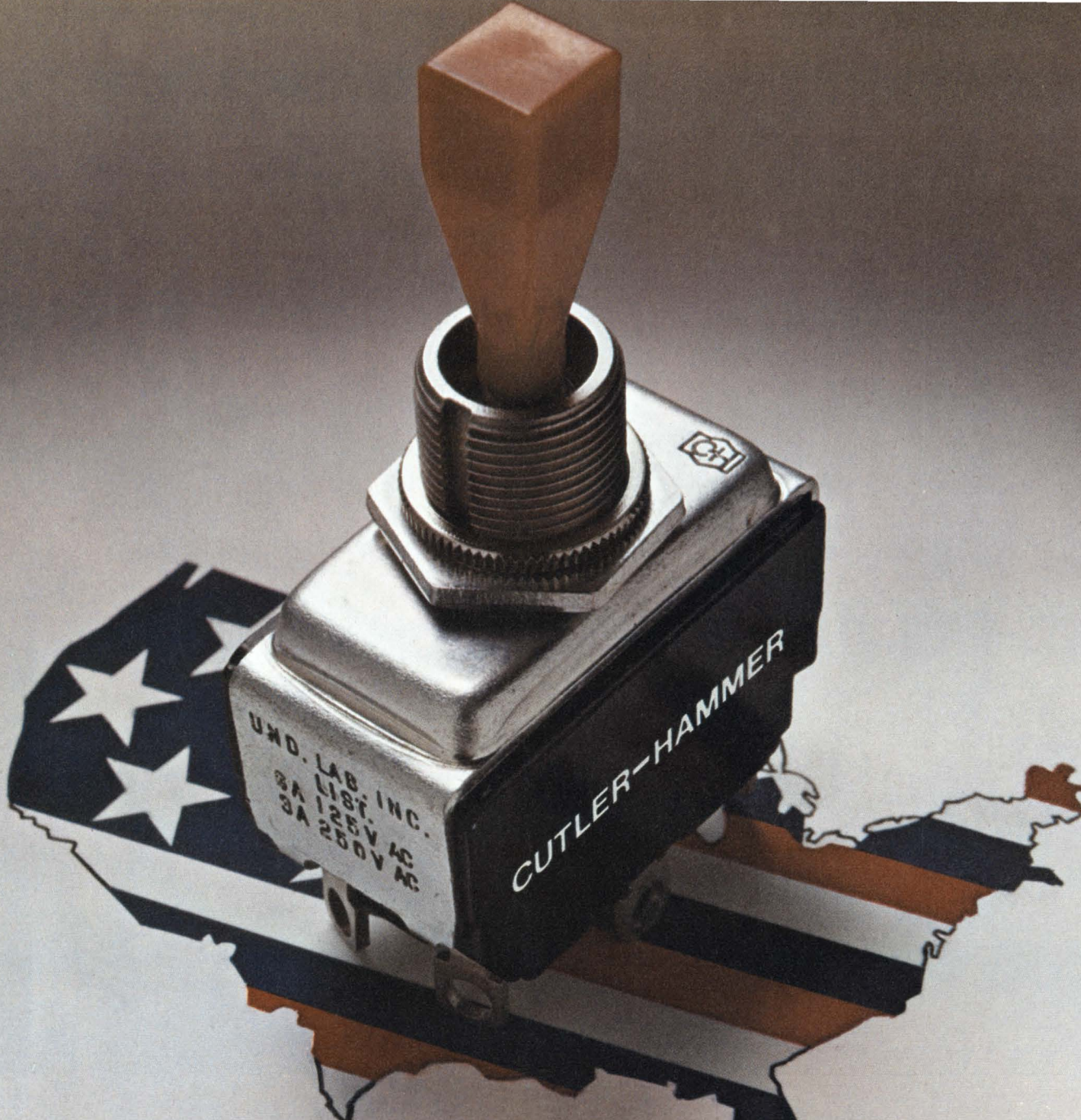

# TOGGLE TERRITORY.

It's anywhere you are in the whole land.

It's anywhere you have to put your hands on exactly the right toggle switch to complete your design.

Especially if you need extraordinary design flexibility, distinctive appearance and proved performance in your toggle switches.

Cutler-Hammer not only provides the broadest line of toggle switches available, but offers you the greatest selection of ratings, terminations,

hardware, toggle shapes, materials and colors.

AC-rated. AC/DC. Low energy. Dry-circuit capability, or up to 25 amps. One, two and four poles. Select Cutler-Hammer Designer Line, miniature, slow-make/slow-break or hesitation switches from the complete Cutler-Hammer line. We have thousands of varieties ready for delivery. And if the toggle you need isn't among those thousands, we'll work with you to build exactly what you want.

You needn't look very far to get the finest quality in toggle switches. Wherever you are in the U.S.A., get the toggle you want. Because we cover Toggle Territory best. With

more distributors than anyone else. Call your Cutler-Hammer Sales Office or Stocking Distributor. Or write for full-line catalog LD-110A.

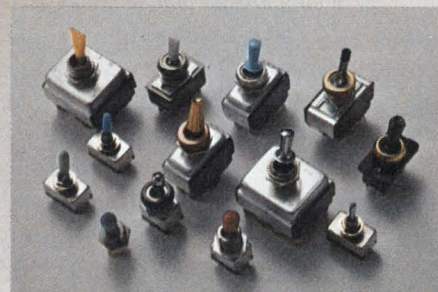

Switch  
to No.1

More than just switches;  
prompt availability,  
field help, innovation,  
quality assurance, too.

INFORMATION RETRIEVAL NUMBER 27



**CUTLER-HAMMER**  
SPECIALTY PRODUCTS DIVISION, Milwaukee, Wis. 53201

# washington report



Heather M. David  
Washington Bureau

## **Congress tackles the F-14 problem**

The Navy-Grumman dispute over whether or not the company should be held to its contracted cost figures for the F-14 carrier aircraft has moved to the Congressional arena. Hearings have begun on the cost of the fighter plane's weapons systems before Senator William Proxmire's (D-Wis.) joint economic subcommittee, and investigations are planned in the House and Senate Armed Services and Appropriations Committees. New York State's Senators, Jacob Javits and James Buckley, both say they will introduce legislation to keep Grumman from going out of business.

Congressional reaction thus far is mixed, some influential military-affairs committee members are tired of rising costs in weapons and fearful of an avalanche of contractor defaults if Grumman's plea to renegotiate fees is heeded. Privately these Congressmen indicate they are in favor of canceling the F-14 program. Others, with strong Navy ties, are expected to back Grumman, since the F-14 is seen as the major justification for the Navy's aircraft-carrier fleet.

Insiders say that actually Grumman will not be in default of its contract for at least a year and that the current announcements by the Navy and the company are designed to smoke out Congressional opinion and force action on the problem. The F-14 reportedly is performing well in tests, including its AWG-9 weapons fire-control system, built by Hughes Aircraft.

## **FTC vs Xerox: A hearing seems likely**

The next step in the battle between the Federal Trade Commission and the Xerox Corp. over the FTC's allegation that the company has illegally monopolized the office-copier machine industry apparently will be a hearing before an administrative law judge of the commission. Xerox officials say they will fight the FTC charge and take the suit to a Federal Court if the hearing judge rules against the company. Among other things, the Federal agency is considering punitive action to force Xerox to give free licenses on all present patents as well as any developed in the next 20 years.

## **A ruling due on television-tube dumping**

The Tariff Commission will report to the Treasury Dept. this month as to whether the U.S. television-tube industry has been injured by Japanese dumping. If the answer is yes—and the Electronic Industries Association has testified to that fact—the Treasury Dept. will begin examining re-

cords to assess levies. The department is now collecting levies on an earlier antidumping decision against Japanese color-television imports. Meanwhile Japanese manufacturers of electronic consumer goods have voluntarily moved to limit the export of such items as stereos, monochrome and color-TV tubes, tape recorders and civilian communications equipment.

On the other side of the import-export coin, the National Export Expansion Council's Industry Advisory Committee has called for elimination of domestic and foreign impediments to the export of computer equipment and office machines. The committee says it doesn't need Federal curbs on imports, just less restrictions on sales abroad.

## **Postal Service to expand its electronic aids**

The U.S. Postal Service will invest in some new electronic equipment in the near future and will be looking for contractors to bid on 28 multi-position machines. The units will have solid-state computer equipment to sort mail for the 277 Zip Code destinations in the United States. The Postal Service has been buying equipment to automate the handling of packages, but it finds the electronic handling of letters a more difficult problem. The service will commit about \$102-million in R&D funds this fiscal year, including \$15-million for general research, \$59-million for applied research, \$23-million for engineering and \$4-million for administrative support.

## **U.S. help for budding investors on the way**

The National Science Foundation has started an experimental R&D incentives program to enable designers of technical inventions to have their designs verified in Government laboratories. The program is aimed at encouraging innovations in the civilian sector. Laboratories of the National Aeronautics and Space Administration and the Dept. of Defense will be the first to participate in the program. Foundation officials say the tests should help successful inventors attract venture capital to their projects by proving the feasibility of their ideas. To apply to have an original design verified write for instructions to the NSF Project Officer, Mr. Evan D. Anderson, National Science Foundation, 1800 G. St. NW, Washington, D.C. 20550.

**Capital Capsules:** U.S. industry R&D expenditures will increase 25% between 1972 and 1975, to a record \$14-billion, according to the National Science Foundation. Employment of scientists and engineers also will rise, from 240,000 last year to 260,000 in 1975, the foundation predicts. . . . **The uptrend in business capital expenditures will continue in 1973**, the Commerce Dept. says. A survey by the Bureau of Economic Analysis says the communications industry will have an increase in investment of more than 10%. . . . The General Accounting Office's latest tally of defense weapons systems shows that 47 major systems had a cost growth of \$1-billion in the three-month period from March to June. . . . The Electronic Industries Association continues to expand its trade activity. It has appointed **Ralph E. Van Hoorn** of ITT to head the association's new International Business Council. . . . The Air Force recently demonstrated a **radio-controlled balloon system** that, it says, could be used to carry instruments for a number of electronic missions.

# a tool kit full of measurement solutions...

Now there's a 3-pound scope that can be carried in your tool kit, suitcase, briefcase, coat pocket, glove compartment . . . almost anywhere.

It's the 211, our first laboratory-quality mini-scope. Size is only  $3 \times 5\frac{1}{4} \times 9$  inches. Bandwidth is 500 kHz. A lot of scope in a small package.

The 211 is easy to use. You spend your time solving measurement problems, not studying scope operation. Deflection factors from 1 mV/div and sweep rates from  $5 \mu\text{s}/\text{div}$  are read out from controls easily related directly to the CRT. One rotary control does all the triggering.

Ever wanted to float a scope? Here's one that floats to 500 volts RMS when operated from its internal batteries.

Price? It's lower than you might expect. Only \$545, FOB Beaverton, Oregon.

For a demo, just contact your local Tektronix Field Engineer. He probably has a 211 in his briefcase. Ask him for complete information or write Tektronix, Inc., P.O. Box 500, Beaverton, Oregon 97005. In Europe, write Tektronix Ltd., P.O. Box 36, St. Peter Port, Guernsey, C. I., U. K.

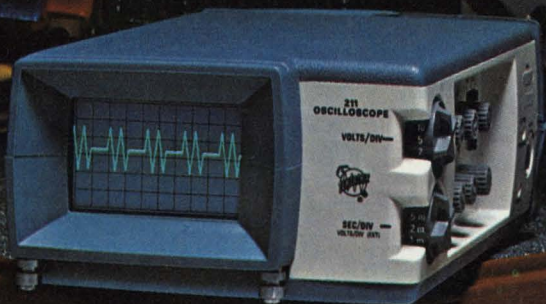

**TEKTRONIX®**

committed to  
technical excellence

# WHAT'S IN PLESSEY'S MNOS SANDWICH? ADVANCED TECHNOLOGY. THE SPECIALTY OF THE HOUSE.

There's only one Metal-Nitride-Oxide-Silicon sandwich commercially available now. And Plessey has it.

The Plessey MNOS transistor is a non-volatile electrically-alterable semiconductor memory. It is specifically designed to meet the most difficult user requirements. Like small memory applications where it is necessary to achieve long-term data retention in power-off conditions... for a hundred years.

They come many ways. Single, dual and quad transistors. And together in arrays. They can be used in a wide variety of applications—micro-programming, numerical control, data logging, domestic control systems, automatic repertory dialers, frequency synthesizers, and airborne systems, etc.

As more and more users are finding out, it pays to specify Plessey.

## PLESSEY SEMICONDUCTORS

1674 McGaw Avenue, Santa Ana  
California 92705 (714) 540-9945

Please send me a complete literature packet.  
Now.

- I would like information only at this time.  
 I would like to talk to your representative personally.

Name \_\_\_\_\_

Title \_\_\_\_\_

Firm \_\_\_\_\_

Address \_\_\_\_\_

City \_\_\_\_\_ State \_\_\_\_\_ Zip \_\_\_\_\_

Phone No. \_\_\_\_\_

Minneapolis, Minnesota  
(612) 835-2717

Framingham, Massachusetts  
(617) 879-7920

San Diego, California  
(714) 295-2500

Los Altos, California  
(415) 941-4080

Houston, Texas  
(713) 462-4077

Farmingdale, New York  
(516) 694-7377

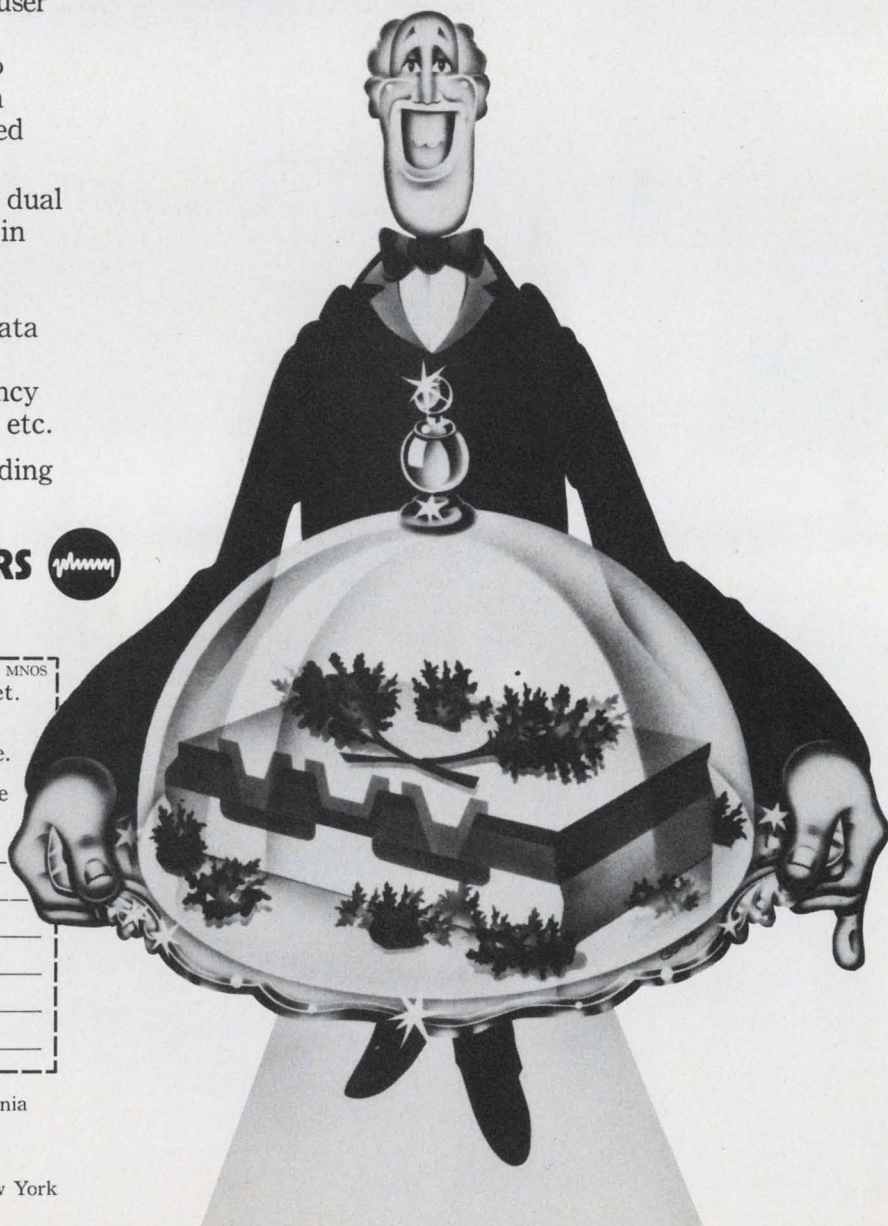



# The dependable Helipot trimmer goes automatic.

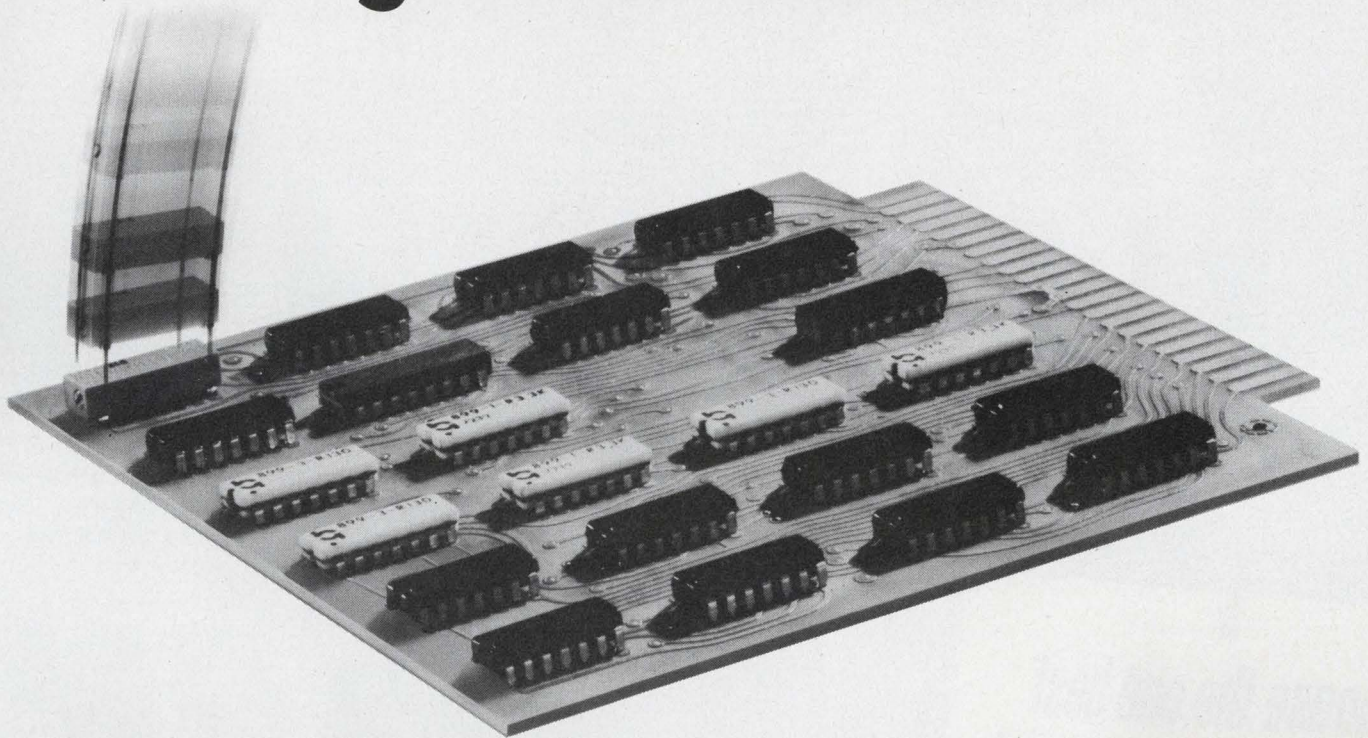

Now, the Helipot Model 86 Trimmer comes in standard DIP configuration (TO-116) for compatible, fast insertion by automatic equipment.

Our Model 86 line features cermet resistance elements, essentially infinite resolution, and 19 standard resistance values from 10 ohms to 2 megohms. Sealed for board washing, they're leak-tested with 70°C water for one minute.

And temperature

coefficient is a low  $\pm 100$  ppm/°C.

These trimmers are made for both industrial and commercial applications, and their price is really right: just \$1.61 each in the 1,000 quantity, \$2.30 each for one to nine.

Your local Beckman/Helipot distributor stocks the Model 86 in depth. To order or to request technical data, call him today. Or write to Helipot Division, 2500 Harbor Boulevard, Fullerton, California 92634.

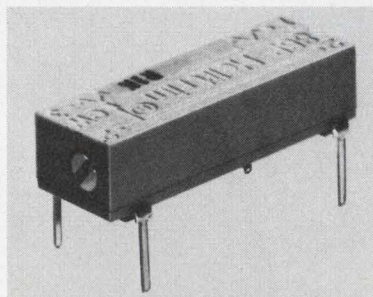

**Beckman**

INSTRUMENTS, INC.

INFORMATION RETRIEVAL NUMBER 153

# Solid State vs.

**Your  
Guardian Angel  
puts it  
all together!**

Control confusion? Contact Guardian. Perhaps the solution will be a solid state device. Or, an electromechanical relay. Or, a money-saving assembly combining both! Our vast experience in solid state, hybrid and electromechanical devices assures you the most effective possible solution.

**Choose the one best  
solution to your control  
design problems:**

- Solid State
- Hybrid
- Electromechanical
- All of the above
- None of the above
- Ask your Guardian Angel!

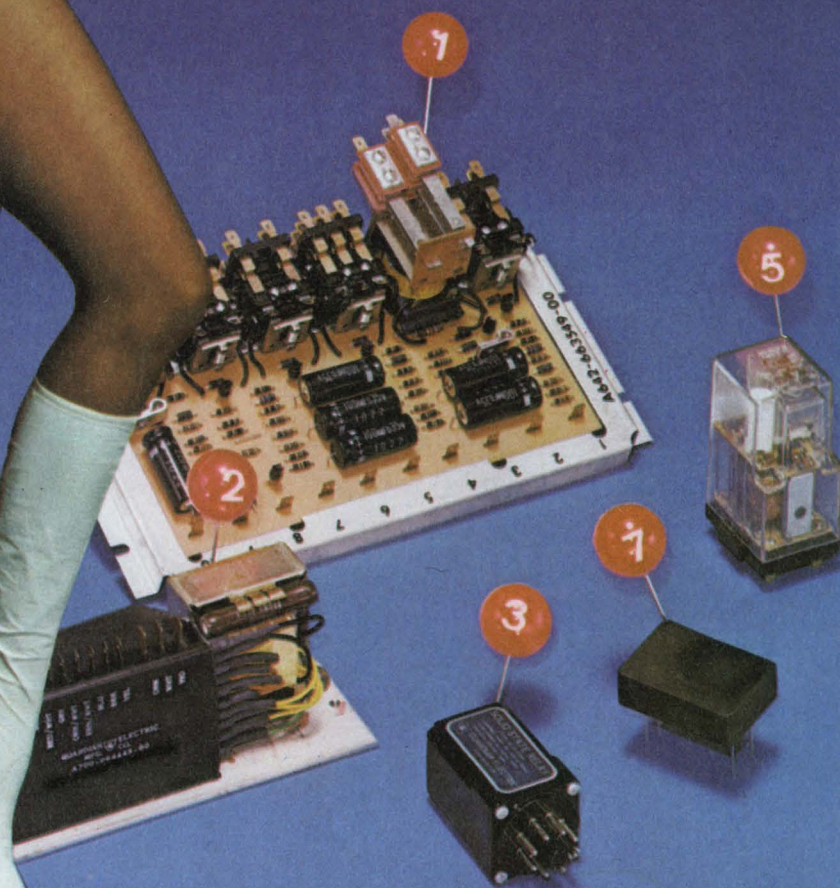

# Hybrid vs. Electromechanical?

**1** CUSTOM CONTROL PACKAGES for sequential switching at precise intervals. In most cases, numerous standard Guardian solid state devices could do the job. But, to lower total cost, Guardian can combine electromechanical and solid state into a single package. The result? Unique solutions to specific control problems demanding adjustable time delay, priority logic, voltage sensing, circuit isolation, or virtually *any* switching problem your system might demand.

**2** CUSTOM SOLID STATE CONTROL PACKAGES that put a dozen functions ranging from temperature sensing to time delay and voltage regulation in a single, miniaturized, low-cost module.

**3** SOLID STATE RELAYS that perform the function of electromechanical relays with total isolation between control circuit and switching output. Standard designs for most applications—custom designs at near-standard prices!

**4** SOLID STATE TIME DELAYS in just about any size, shape, form or delay range your application can demand. Need 30 minute delay? Guardian's got it. A 25 millisecond delay? We've got that, too. And they're yours right-off-the-shelf or in custom designs.

**5** HYBRID TIME DELAYS AND RELAYS for low-cost, dependable solutions to perplexing design problems. At Guardian they're yours in standard and custom designs.

**6** SOLID STATE VOLTAGE SENSORS that protect other controls and motors from the damaging effects of under-voltage or phase loss during power outages and "brown outs."

**7** ELECTRONIC "ZERO CROSSOVER" SWITCHES that form an electrical "cushion" between signal input and load power by switching at  $0.0VAC \pm 10V$ .



COMPLETE APPLICATION DATA IS IN THESE TWO FREE CATALOGS.

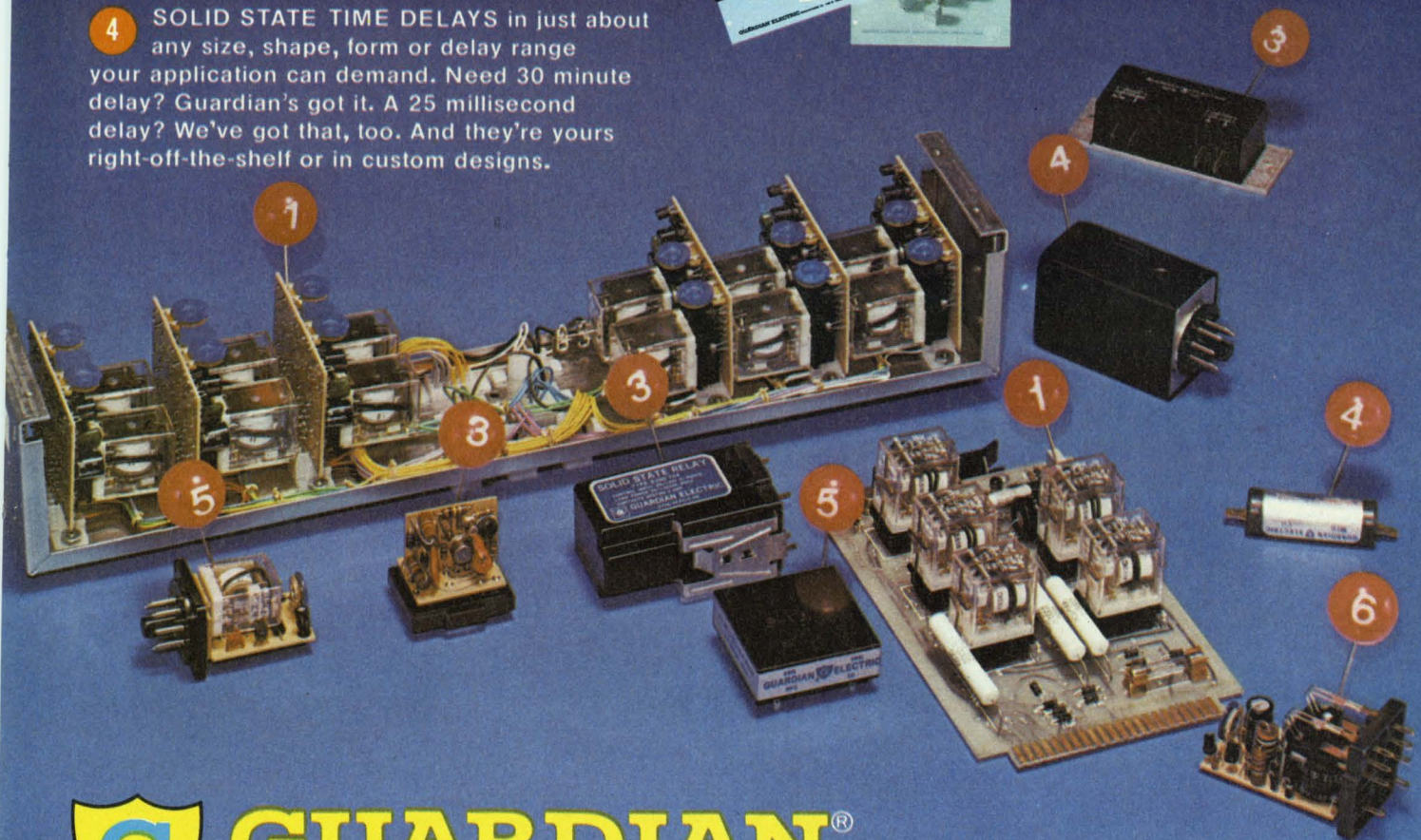

## GUARDIAN®

GUARDIAN ELECTRIC MANUFACTURING CO. • 1550 W. Carroll Ave. • Chicago, Illinois 60607

# Reliability is staggered steps and a hunk of DAP.

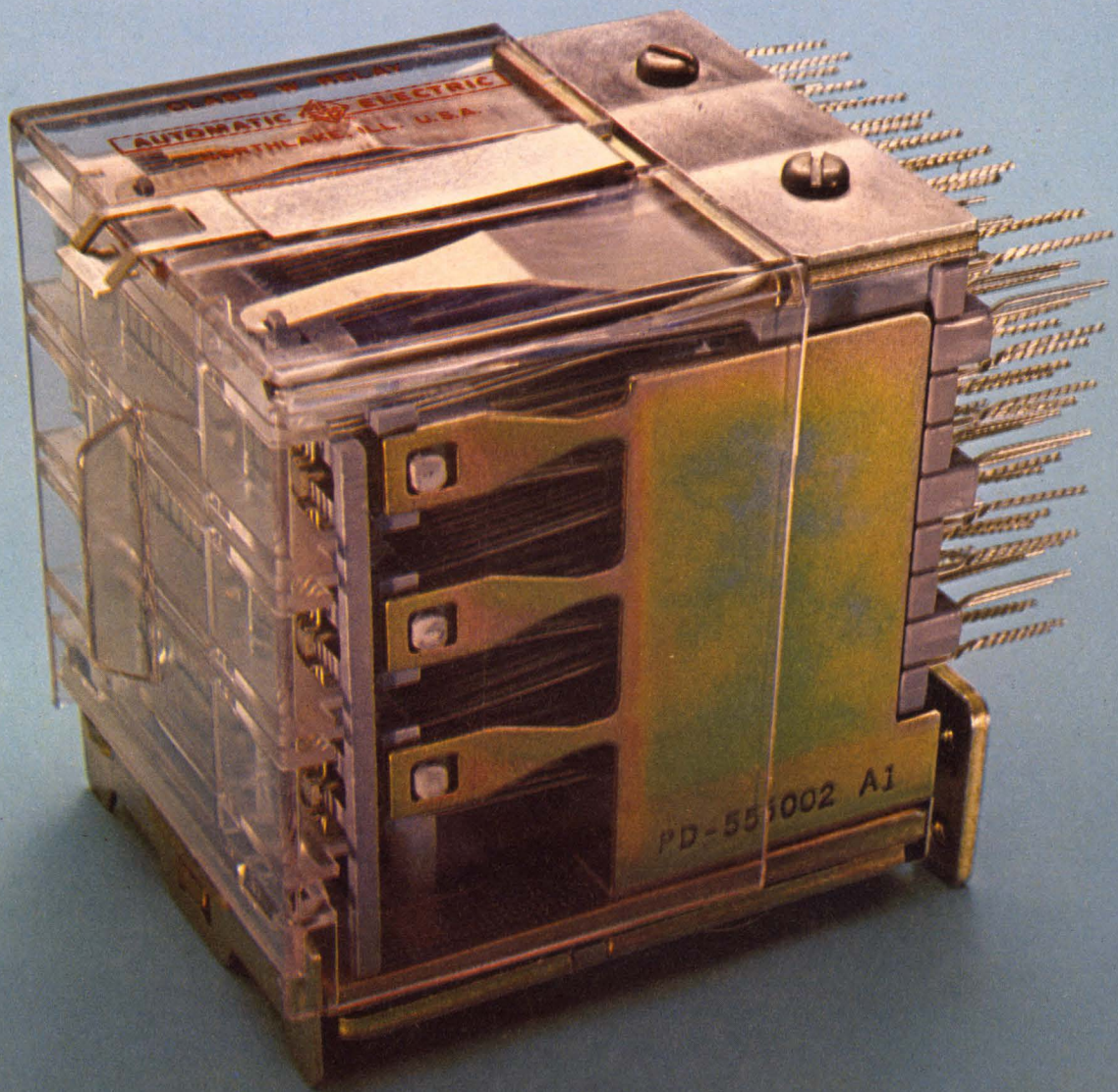

### **Expect over a billion operations.**

Our Class W wire-spring relay is different. In fact, there's nothing like it in the entire industry. Where else can you find a relay with lots of contacts and a mechanical life of more than a billion operations! That's about two and a half times the life of the best conventional relay around.

Another nice thing about our Class W is that it takes up a lot less space and costs less than using a bunch of other relays. That's because we build our Class W relay with one, two or three levels of contact assemblies, with 17 form C combinations per level. By the way, they're available with gold contacts for low-level switching.

### **Making it tough on creepage.**

All those staggered steps you see on the side were put in to raise the breakdown voltage between terminals. These molded steps add extra creepage distance between the terminals. This really counts for high voltage testing, or when using our Class W in unfavorable ambient conditions.

These steps, and all the molding compound used for insulating the contact springs, are made from

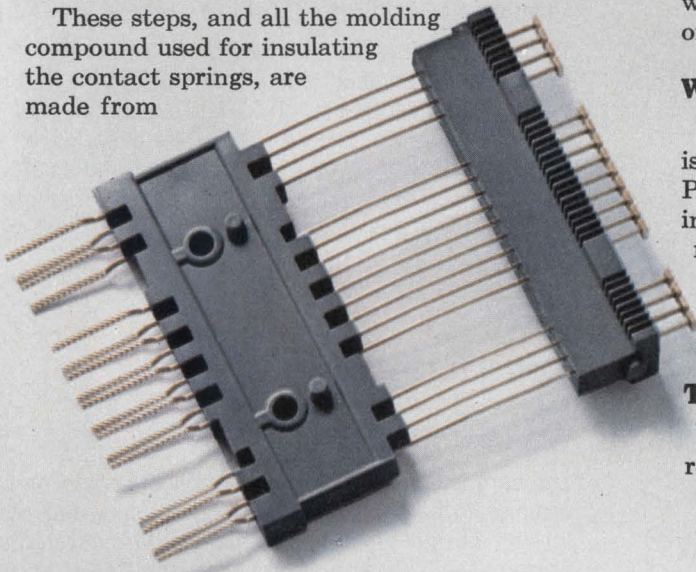

diallyl phthalate. (They call it DAP for short.) It has great insulating properties and it wears like iron. Even if the humidity is high, you have excellent protection.

### **Redundancy—two springs are better than one.**

Each of our long wire-spring contacts has an independent twin with the same function. One tiny particle of dust could prevent contact on other relays. Not with our Class W. You can be sure one of the twins will function. That's back-up reliability.

The twin contacts are twisted together at the terminal end. Then we give them a spanking (you might call it swedging) to provide solderless wrap.

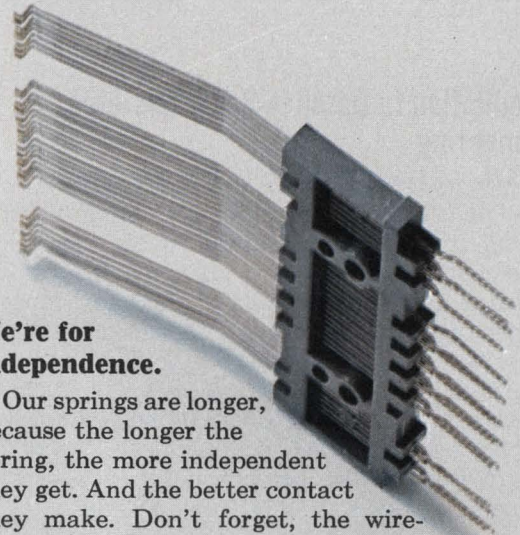

### **We're for independence.**

Our springs are longer, because the longer the spring, the more independent they get. And the better contact they make. Don't forget, the wire-spring relay is the most reliable way to get a permissive make or break contact. You can rely on it.

The middle contact springs have to be stationary. To make sure they stay that way forever, we actually mold them between two thick pieces of DAP on both ends. Just try to move one.

### **When we say flat, it's flat.**

Each frame, banged out by a gigantic machine is extra thick and extra flat. Then they're planished. Planishing is another step we go through in forming the frame to add strength and stability by relieving surface strain.

We've made our spring-loaded pile-up clamp extra thick, too. Once it's tightened down, the whole pile-up is nice and tight, and stays tight.

### **There's more.**

We could tell you a lot more about our Class W relays. Like how the tough high-temp molded

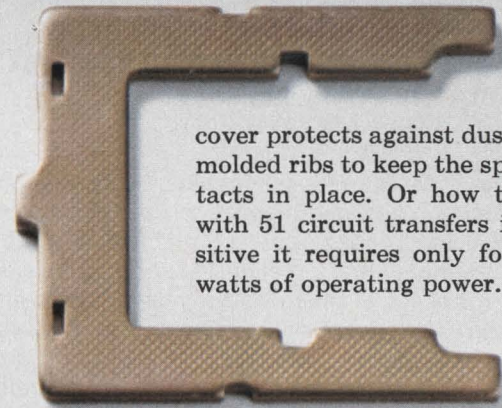

cover protects against dust and has molded ribs to keep the spring contacts in place. Or how this relay with 51 circuit transfers is so sensitive it requires only four to six watts of operating power.

But why don't you let us prove how much reliability we put into our Class W? We'll be waiting to hear from you. GTE Automatic Electric, Industrial Sales Division, Northlake, Ill. 60164.

**GTE AUTOMATIC ELECTRIC**

# New and recent Spartan Books . . .

## Introduction to Defense Radar Systems Engineering

JAMES N. CONSTANT, *President, RCS Associates, Inc.*

*Just Published!* The first book to bring together all aspects of radar systems and integrate them in a systematic and logical pattern offers all the background needed to specify a system for a given application. Each chapter presents analyses and equations in engineering terms. Among this comprehensive volume's many unique features are: the most extensive treatment of the effects of Electronic Counter Measures (ECM); coverage of the theory of trajectory predictions and array theory; and an in-depth treatment of data processing in radar systems. 260 pp., 6 x 9, *illus.*, #9194, cloth, \$20.00

## Checklists for Management, Engineering, Manufacturing, and Product Assurance

W. B. ROSSNAGEL, *Rossnagel and Associates*

Technically accurate and ready to be applied, these checklists are an excellent means to ensure that a given specification, contract, design, etc., is complete in every respect.

### Volume I, Management Checklists

22 checklists cover computers, engineering, finance, labor relations, manufacturing, marketing, personnel, product assurance, proposals, publications, small business, and other subjects. 192 pp., 6 x 9, *illus.*, #9178, cloth, \$14.00

### Volume II, Electrical and Electronic Checklists

22 detailed lists encompass cables and connectors, communication radios, multi-coders, lasers, microelectronics, integrated circuits, and much more. 192 pp., 6 x 9, *illus.*, #9181, cloth, \$14.00

## Vibration and Acoustic Measurement Handbook

MICHAEL P. BLAKE, *Development Engineer, and*  
WILLIAM S. MITCHELL, *Vibration and Acoustical Consultant, both of Lovejoy, Inc.*

This original 700-page illustrated guide closes the great technological gap between theory and operations in the field. Developed through years of practical testing, it demonstrates the value of vibration and acoustic measurement in terms of actual situations and machine problems. It clearly shows how these measurements can give warning months in advance of 90 percent of equipment problems, allowing time to take corrective action before trouble starts. The net-result: less production stoppage, fewer lost man-hours, better quality control, and lower maintenance costs. 656 pp., 6 x 9, *illus.*, #9195, cloth, \$30.00

## Analysis of Plates

D. E. McFARLAND, B. L. SMITH, *and*  
W. D. BERNHART, *Wichita State University*

This comprehensive text presents both classical and computer-oriented solutions for the analysis of thin plates for stresses, strains, and lateral deflections. The coverage includes orthotropic plates, continuous plates, various shapes, plates on elastic foundations, large deflections, and laminated plates. The authors add new insight to the variational approach to plate theory, including many illustrative examples. Although intended as a text in mechanical engineering, the book should be of great interest to engineers in industry. 296 pp., 6 x 9, *illus.*, #9191, cloth, \$18.50

## Control Theory, Volume 1

### Elements of Modern Control Theory

ARTHUR L. GREENSITE, *Convair Division of General Dynamics*

The first of these two volumes on flight control provides the practicing engineer and advanced student with a comprehensive, modern, and up-to-date exposition of all facets of modern control theory. Based on a series of monographs written for NASA, it is recommended as a primary or supplementary reference text. Extensive sample problems and exercises included. 896 pp., 6 x 9, *illus.*, #9154, \$29.95

## Control Theory, Volume 2

### Analysis and Design of Space Flight Vehicle Control Systems

The companion volume treats applications to aerospace vehicles in detail. It examines techniques and methods for the design of launch vehicle control systems, and presents an analytical framework for the study of the performance of satellite attitude control systems. 752 pp., 6 x 9, *illus.*, #9163, cloth, \$29.95

## Modeling of Thinking and the Mind

N. M. AMOSOV, *Academy of Medical Science, U.S.S.R.*

An exciting work on the theory and techniques of simulating the functions of the human intellect by one of the Soviet Union's leading cyberneticists and Lenin Prize winner. Presenting his original hypothesis concerning programs of man's psychic functions, the author outlines methods for modeling these on the computer. 208 pp., 6 x 9, *illus.*, #9147, cloth, \$12.00

SPARTAN BOOKS / HAYDEN BOOK COMPANY, Inc., New York

# ... now available from Hayden

## Pattern Recognition

M. BONGARD, *Translated from the Russian by T. Cheron;*  
*Edited by J. K. Hawkins, Robot Research*

Although primarily directed toward specialists in computers and artificial intelligence, this volume is of importance to engineers and others attempting to understand such brain functions as the ability to "find similarity," "create abstract ideas," and "act by intuition." The Soviet scientist clarifies the meaning of pattern recognition and problem solving. 256 pp., 6 x 9, illus., #9195, cloth, \$12.95

## The Future of Science

MORRIS GORAN, *Roosevelt University*

A provocative, well documented investigation of the scientists' relationships with society, government, and money. It examines three current problems of the scientists: communication, education, and financing. Throughout, discussions are supported by facts rather than moralistic statements. 168 pp., 6 x 9, #9190, cloth, \$8.50

## Technology Gap in Perspective

### Strategy of International Technology Transfer

DANIEL LLOYD SPENCER, *Morgan State College*

An original strategy for visualizing and coping with the technological variants of the modern world. Presenting a novel systems vision, the author deals with the problems of incessant waves of technological impact, and holds that we must view them as a world technology system. 192 pp., 6 x 9, illus., #9180, cloth, \$10.00

## Character Readers and Pattern Recognition

Edited by V. A. KOVALEVSKY, *Institute of Cybernetics, Kiev, U.S.S.R.*

This collection of articles focuses on problems of pattern recognition and computer simulation of various algorithms

and recognition systems. All methods discussed and all work examined are based on procedures used in the development of actual equipment at the Institute of Cybernetics. 280 pp., 6 x 9, illus., #9150, cloth, \$12.00

## Durability and Reliability in Engineering Design

GILBERT KIVENSON

This thought-provoking work places at your disposal highly relevant findings from a variety of technical areas. It examines materials properties, breakdown mechanisms and phenomena, and failure modes along with steps to counter them; provides a capsule course in reliability theory; relates design considerations to the user's needs. 200 pp., 6 x 9, illus., #5851-9, cloth, \$9.95

## Materials Science and Technology for Design Engineers

Edited by ALEX E. JAVITZ

The fundamentals of materials integrated with the hard facts of day-to-day engineering practice. The coverage offered you ranges from basic structure and behavior through new materials and applications, to environmental effects, reliability concepts, and cost effectiveness. 560 pp., 6 x 9, illus., #5640-0, cloth, \$23.95

## The Successful Engineer-Manager

### A Practical Guide to Management Skills for Engineers and Scientists

Edited by ROBERT C. HAAVIND and RICHARD L. TURMAIL

A well-organized, realistic guide to the critical areas of technical management — career, decisions, people, projects, finances, and communications. Articles carefully chosen from *Electronic Design* offer you valuable pointers on financial analysis, person-to-person dealings, project scheduling, promoting new ideas, and much more. 176 pp., 7½ x 9¾, illus., #5879-9, cloth, \$8.95

## 15-DAY FREE EXAMINATION

Please send the book(s) circled on 15-day free examination. At the end of that time, I will remit payment, plus postage, or return the book(s) with no further obligation.

9194	9195	9163	9150	5851-9
9178	9191	9147	9190	5640-0
9181	9154	9195	9180	5879-9

### Save Money!

**Payment Enclosed.** Publisher will pay all shipping and handling charges — same 15-day guarantee.

Name \_\_\_\_\_

Firm \_\_\_\_\_

Address \_\_\_\_\_

City/State \_\_\_\_\_ Zip \_\_\_\_\_

**\$10.00 minimum for free exam orders.** Because of higher billing and collection costs, we must ask for payment in full with any order for less than \$10.00. Same 15-day guarantee.



**HAYDEN BOOK COMPANY, INC., 50 ESSEX STREET, ROCHELLE PARK, N.J. 07662**

ISBN Prefix 0-8104

72-87

# Take a hard look-

## These new cores may mean dozens of profitable new markets & products for you.

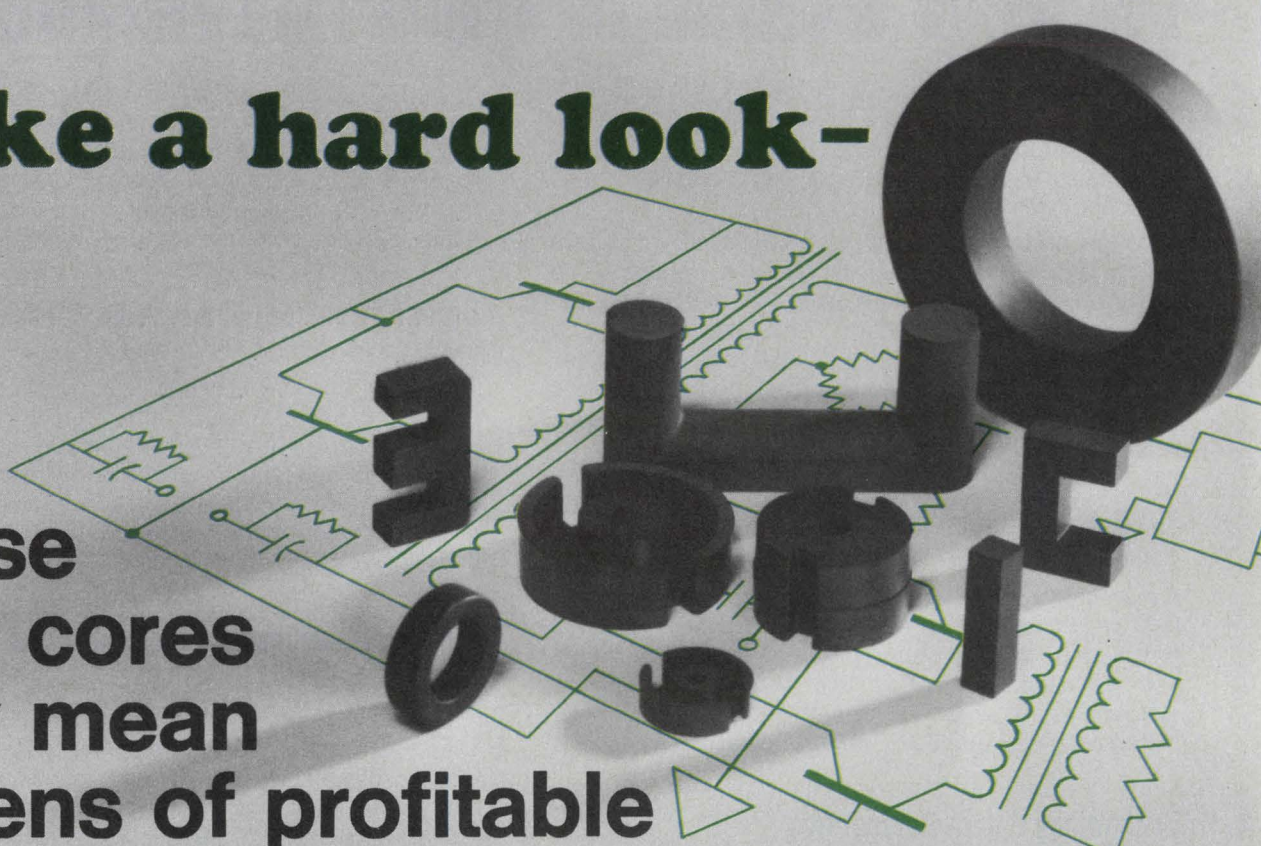

That's right, they're just ferrite cores. But they're made of **Ferroxcube's new 3C8** — a material that opens up a whole new vista of applications for high-frequency circuit designs. Even if you've never designed an inverter or other high-frequency power device, you owe it to yourself and your company to read on. . .

3C8 is a remarkable advancement in the state of the ferrite art. It offers a combination of electrical, mechanical, and magnetic properties that formerly were only selective *trade-offs* among several ferrite materials. We mould it into cores of all sizes and shapes — including pot cores, E-I and U-I cores, and toroids.

For high-frequency inverters, 3C8 gives you high flux density, *even at elevated temperatures*, and low losses, *even at high excitation levels*. We'll provide 3C8 in practical-sized cores — up to kilowatt power levels. And ferrite cores cost only a small fraction of their laminated equivalents, despite lower losses and freedom from mechanical loss of permeability.

Perhaps you haven't considered the markets for a HF inverter designed around a low-loss ferrite core. Starting with DC, you can go almost anywhere, by inverting, transforming up or down, then using the AC directly or rectifying it to DC.

(In some applications, of course, you may wish to rectify and filter the power line, to get the DC.)

High-frequency AC is great stuff, by the way. . . Take fluorescent lamps, for example. They don't have to operate at 60Hz. They operate beautifully up to 3KHz. . . and, as the frequency goes up, the ballast gets much smaller, and lighter, and cheaper.

Take strobe light devices — highway warning markers; harbour buoy flashers, airport guidance systems; and the like. Using high-frequency inverters, their HV circuitry becomes much simpler and cheaper.

How about high-speed motors? Certain motor types, fed directly from a high-frequency source, shrink *startlingly* in size, and don't need gearing.

And don't forget the hundreds of devices operated from rechargeable batteries — radios, shavers, recorders, DVM's, 'scopes, etc, etc. At 5KHz, the charger circuit gets smaller than the battery.

Finally, 3C8 makes great power oscillators, power amplifiers, and ultrasonic generators. . . and don't forget induction heating applications!

Interested? Challenged? Write, or call your local Ferroxcube office **today** — and get started on 3C8!



**FERROXCUBE CORPORATION / SAUGERTIES, N. Y.**

**NORTH AMERICAN PHILIPS COMPANY**

INFORMATION RETRIEVAL NUMBER 144

**"Distributed through North American Philips Electronic Components Corporation"**



# Who's Been Building Function Generators Longer Than Anyone?

## Wavetek? Guess Again

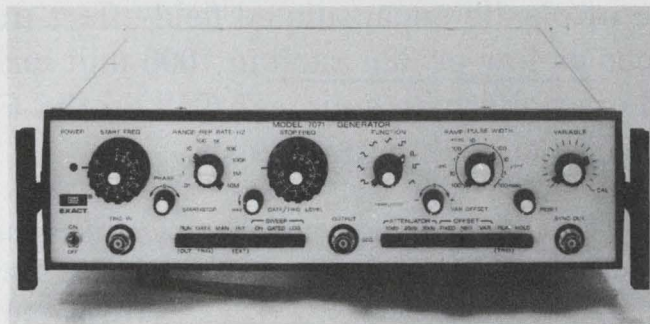

**Model 7071 Lin/Log Sweep Function Generator**

In 1957 a group of people left Tektronix to form Exact Electronics and Exact has been building the finest function generators available ever since. So don't miss a bet when looking for a function generator. Compare Exact's performance per dollar,

broad line of instruments and years of experience with anyone else and stand by for a surprise. Circle the bingo number and we'll send you a catalog or better yet, call the nearest sales office listed below and we'll rush a generator over.



Box 160 Hillsboro, Oregon  
97123 Tel. (503) 648-6661  
TWX 910-460-8811  
**electronics, inc.**

A subsidiary of Danalab, Inc.

An Affiliate of **DANA** Laboratories, Inc.

Toronto, Ontario, Canada — Atlas Elec. Corp — (416) 781-6174  
Montreal, Quebec, Canada — Atlas Elec. Corp — (514) 489-8495  
Orlando, Florida 32803 — BCS Associates, Inc. — (305) 843-1510  
Huntsville, Alabama — BSC Associates, Inc. — (205) 881-6220  
Greensboro, North Carolina 27405 — BCS Associates, Inc. — (919) 273-1918 —  
Denver, Colorado 80226 — Barnhill Three, Inc. — (303) 934-5505  
Albuquerque, New Mexico 87112 — Barnhill Three, Inc. — (505) 299-7658  
Scottsdale, Arizona 85251 — Barnhill Three, Inc. — (602) 947-7841  
Houston, Texas — Barnhill Two, Inc. — (713) 621-0040  
Richardson, Texas 75080 — Barnhill Two, Inc. — (214) 231-2573  
Farmington, Michigan 48024 — Carter, McCormick and Peirce, Inc. — (313) 477-7700  
Cleveland, Ohio 44126 — Carter, McCormick and Peirce, Inc. — (216) 333-5650  
Dayton, Ohio 45414 — Carter, McCormick and Peirce, Inc. — (513) 278-5873  
Pittsburgh, Pa. 15235 — Carter, McCormick and Peirce, Inc. — (412) 824-3760  
Palo Alto, California 94303 — Coherent Marketing Associates — (415) 327-2217  
Kensington, Md. 20795 — Electronic Marketing Associates — (301) 881-5300 (Wash. area)  
Kensington, Md. 20795 — Electronic Marketing Associates — (301) 744-7700 (Balt. area)  
King of Prussia, Pa. — Electronic Marketing Associates — (215) 265-1600 (King of P. area)

King of Prussia, Pa. — Electronic Marketing Associates — (215) 248-5050 (Phila. area)  
North Hollywood, Calif. 91601 — Feeger, Lucas, Wolfe, Inc. — (213) 877-5518  
Newport Beach, Calif. 92660 — Feeger, Lucas, Wolfe, Inc. — (714) 540-4412  
San Diego, Calif. 92117 — Feeger, Lucas, Wolfe, Inc. — (714) 277-0993  
Seattle, Washington 98103 — Hayes Technical — (206) 763-2210  
Hamden, Conn. 16518 — Pat Jenks Associates, Inc. — (203) 281-0810  
Wakefield, Mass. 01880 — Pat Jenks Associates, Inc. — (617) 246-1590  
New Hartford, N.Y. 13413 — KLM Associates — (315) 735-8525  
No. Syracuse, N.Y. 13212 — KLM Associates — (315) 458-6214  
Rochester, N.Y. 14600 — KLM Associates — (716) 442-0820  
Great Neck N.Y. 11020 — Measurement Technology, Inc. — (516) 482-3500  
Chicago, Illinois 60645 — Pivan Engineering, Inc. — (312) 539-4838  
Indianapolis, Indiana 46260 — Pivan Engineering, Inc. — (317) 253-1681  
Minneapolis, Minn. 55422 — Pivan Engineering, Inc. — (612) 537-4501  
Brookfield, Wisconsin 53005 — Pivan Engineering, Inc. — (414) 786-1940  
Manchester, Mo. 63011 — Pivan Engineering, Inc. — (314) 227-3501  
Shawnee Mission, Kansas 66202 — Pivan Engineering, Inc. — (913) 772-1030

INFORMATION RETRIEVAL NUMBER 30

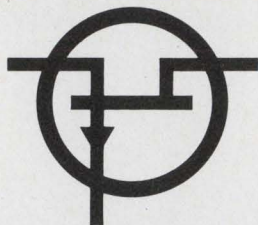

P-Channel  
JFET

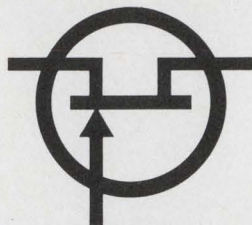

N-Channel  
JFET

Since 1962, Siliconix has evolved FET technology and applied it to a complete line of singles, duals, arrays, and ICs. So what's new?

# Economy Epoxy FETs

Siliconix, the world's leading supplier of FETs, now brings you a full line of plastic encapsulated field-effect transistors—at economy prices as low as 32c each in 1000-unit quantities. Why be concerned over alternate sources? Call on the FET leader for quality devices at rock-bottom cost.

The Siliconix line of epoxy products includes

- FETs for general purpose amplifiers
- FETs for VHF/UHF amplifiers and mixers
- FETs for switches, choppers, and commutators
- FET pairs for differential amplifiers
- FET diodes for current limiters and regulators

Use these new epoxy FETs with the same confidence you have placed in Siliconix products in the past—they are typed, manufactured, and tested specifically for the industrial and commercial markets.

A copy of our new epoxy FET cross-reference guide and full line catalog is yours for the asking. Just circle the bingo card number or call your nearest Siliconix distributor.

## Write for Data



**Siliconix incorporated**

2201 Laurelwood Road, Santa Clara, California 95054

INFORMATION RETRIEVAL NUMBER 31

ELECTRONIC DESIGN 1, January 4, 1973

# Stop the computer. I want to get off.

There's something impressive about a computer that helps us land guys on the moon. I'm even impressed by a machine that can tell me in New York, within seconds, that seat 14A is available on the 2 p.m. United Flight from Denver to Seattle next Tuesday. But most of us are so jaded that we take such accomplishments for granted. We accept them as casually as we accept flying across the country in five hours—and finding our baggage on the other end.

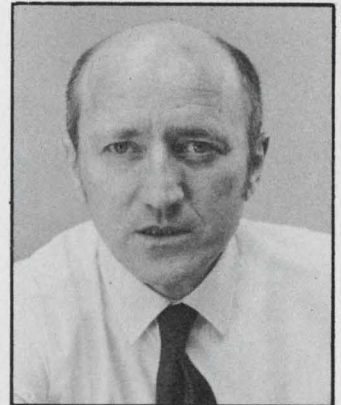

And there's the trap. We're so casual that we may give the computer too much authority. At some point when we're not looking we may unwittingly let it take over—despite warnings from the science-fiction writers. I'm not an alarmist, but I sometimes wonder if it's not beginning.

When I was younger, everybody in my neighborhood would always say, "Let George do it." Today everybody's saying, "Let the computer do it." That's understandable because the computer has a sensational batting average. It processes millions of payroll checks with hardly an error. It zips through millions of bank statements with scarcely a slip.

But when it slips, it can really pull a corker—one that's not easily undone. In the old days, when your grocer sent you the wrong bill, you could call and say, "Hey Jack. You sent me Mulligan's bill by mistake." And he'd say, "Gosh, I'm sorry. I'll fix it right away." Try to get that kind of action today if you find an error on your credit-card statement. It can take months to get a computer to admit it made a mistake.

Often it's not the computer's fault. It's ours. We design for the convenience of the machine instead of man. The whole mess hit me one night in Philadelphia when I needed a room. I telephoned the nearest hotel—the Sheraton—and got a friendly chap who said: "Sorry, we can't book you. Call our toll-free number in St. Louis and get your room through our computerized reservation system." I didn't mind; it wasn't my nickel. IT&T (Sheraton's parent) paid AT&T for the call. But it did seem ludicrous to place a 900-mile call to book a room half a mile away. Are we going to get sillier?

A handwritten signature in cursive script that reads "George Rostky".

GEORGE ROSTKY  
Editor-in-Chief



# Think Twice:

## When is a portable really portable?

### HP's 1700 Series Portable Scopes Always Are...

They're tough go-anywhere scopes: weatherproof, dustproof, completely self-contained. Not the kind of "portable" that's gently moved from bench to bench, trailing a power cord. With a 1700 Series scope you don't worry about the rain. Or the rough ride. Or whether, when you get there, you'll find ac or dc power—or no line power.

An HP portable gives you features you'd expect only in a big lab scope. Like a large, bright CRT that lets you see even difficult signals in high ambient lighting, ECL trigger circuits and a trigger hold-off control, and sweep linearity over the full 10 divisions of horizontal display—ideal for maximum resolution in making those critical timing measurements.

But that's just the beginning. Then the 1700 Series allows you to pick the specific features you need for your field service application: conventional or variable-persistence storage CRT; bandwidths of 35, 75, or 150 MHz; sweep speeds as fast as 2 ns/div; delayed or non-delayed sweep; selectable input impedance; bright-scan viewing mode; and a built-in rechargeable bat-

tery pack for complete measurement independence.

And we're just as proud of the things you don't get with a 1700 Series portable. No heat sinks. No fans. No ventilation holes to let in dust and moisture. That's because our circuits are designed for very low power consumption—and for long, trouble-free operation. And there's no challenge in servicing our portables. In fact, you can completely recalibrate some models in an hour or less, even if all the internal adjustments are misaligned. It's not very sporting, but this ease of servicing quickly adds up to impressive savings.

So before you choose a scope, check your requirements. Then think twice about costs and benefits. Remember, Hewlett-Packard portables let you make any measurement you need—and they cost from \$100 to \$250 less than comparable scopes. These 1700 Series portables are priced from \$1475 to \$2300 for non-storage models and from \$2375 to \$2725 for models with variable-persistence storage. For help in choosing the HP portable that's best for you, send for a free copy of our "No-Nonsense Guide to Oscilloscope Selection." Or contact your local HP field engineer. Hewlett-Packard, Palo Alto, California 94304. In Japan:

Yokogawa—Hewlett-Packard, 1-59-1, Yoyogi, Shibuya-Ku, Tokyo 151, Japan. In Europe: HPSA, P.O. Box 85, CH-1217 Meyrin 2, Geneva, Switzerland.

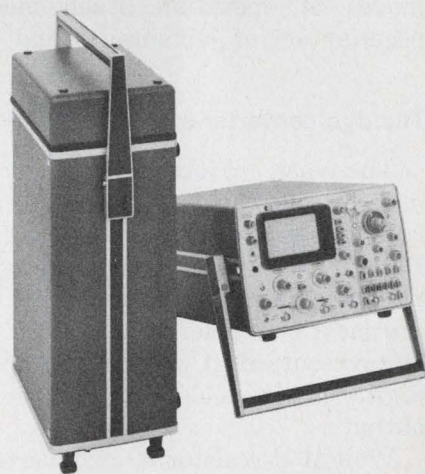

Scopes Are Changing;  
Think Twice.

083/1

HEWLETT  PACKARD

OSCILLOSCOPE SYSTEMS

# FOCUS

on  
A/D and D/A  
converters

Analog and digital circuit designers live in two different worlds.

Analog-to-digital (a/d) and digital-to-analog (d/a) converters bridge the gap between those worlds. Suddenly digital designers have to cope with specifications like linearity, offset voltage, settling time and slew rate. Likewise analog designers must grapple with quantizing error, switching time and bit resolution.

That wouldn't be so bad if the a/d and d/a manufacturers used standardized definitions for converter specs. Not only don't the specs always mean the same thing; often they don't even appear on data sheets.

Converters come in many forms: monolithic or hybrid integrated circuits, potted modules, circuit boards or rack-mounted instruments. Each class also comes in versions for several different modes of operation. Each mode has its own peculiar set of advantages and disadvantages.

## The d/a converter and how it works

The vast majority of d/a converters on the market today use two basic circuits: the weight-resistor network and the R-2R configuration. Both terms relate to the type of resistive ladder network used in the converter. These two types are most conveniently described for the case of a voltage-output d/a—that is, the case where a digital input yields a discrete voltage level at the output.

Weighted-resistor d/a converters include a reference voltage source, a set of switches, a set of binary-weighted precision resistors and an operational amplifier. Each binary bit of the digital input word controls its own switch. If the bit value is a binary ONE, the switch closes. If it is

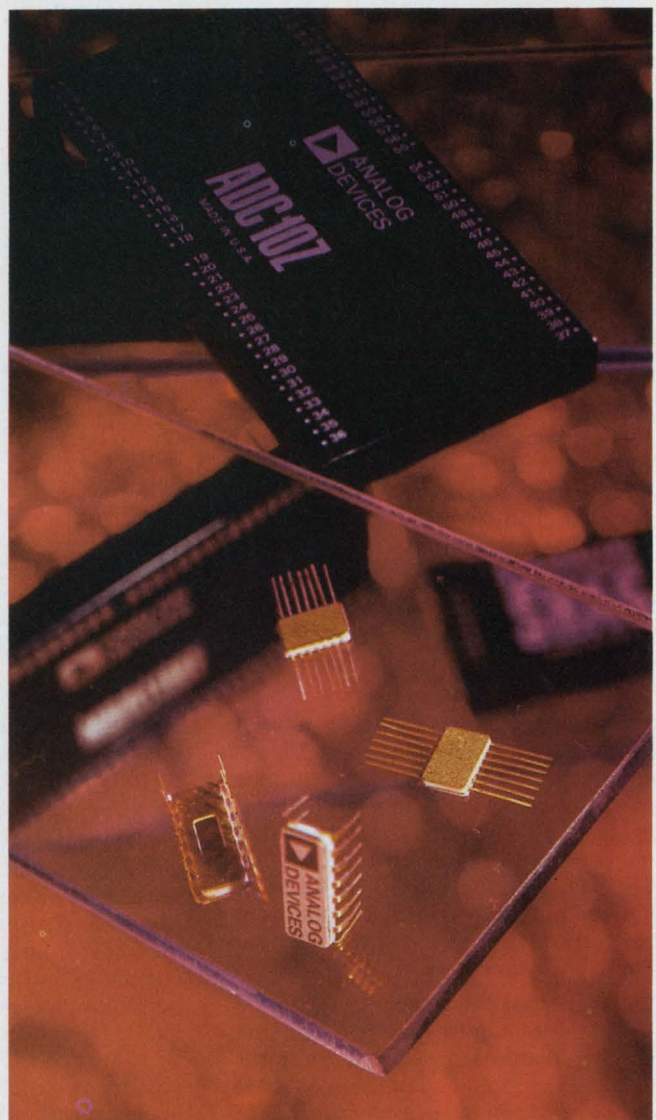

Analog Devices' high-speed, low-cost a/d converter is called the ADC-10Z. It is a 10-bit, 18- $\mu$ s, device. The company will soon have IC a/d's.

David N. Kaye  
Senior Western Editor

a binary ZERO, the switch stays open. When the switch closes, the reference voltage is impressed across the weighted resistor in series with the switch, and a current flows into a summing bus. When the currents from all of the legs of the weighted-resistor ladder network are summed in the amplifier, the output voltage of the amplifier is proportional to the total current and therefore to the value of the digital input code.

The R-2R d/a converters also contain a reference voltage source, a set of switches and an op amp. However, instead of a set of binary-weighted resistors, they contain two resistors per bit. One in series with the bit switch, and the other, valued at one-half the series resistor, is in the summing line, so that the combination forms a pi network in conjunction with succeeding stages (Fig. 2). With the least significant bit (LSB) of the digital input code farthest from the amplifier and the most significant bit (MSB) closest, it

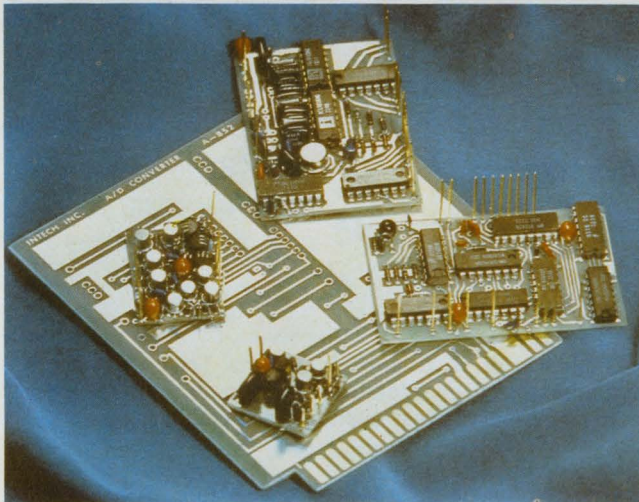

Intech's A-852, 12-bit a/d converter has a 4- $\mu$ s conversion speed, an accuracy tempco of  $\pm 10$  ppm/C and a price tag of \$420 in 1-9 quantities.

can be seen that current flowing in any leg of the ladder gets divided by two at each junction of the ladder on its way to the amplifier. Of course, all other legs of the ladder should be grounded through their respective switches at the time each bit current flows.

Weighted-resistor d/a converters are in general, easier to make than R-2R converters. In the R-2R all resistors and switches must be perfectly matched and must track each other over temperature. The R-2R is best made by monolithic integrated-circuit techniques, and its main advantage is that only two values of resistance are needed. The weighted-resistor converter requires a different value of resistance for each bit of the input digital code. Since the resistance values are binary weighted, the range of resistance values

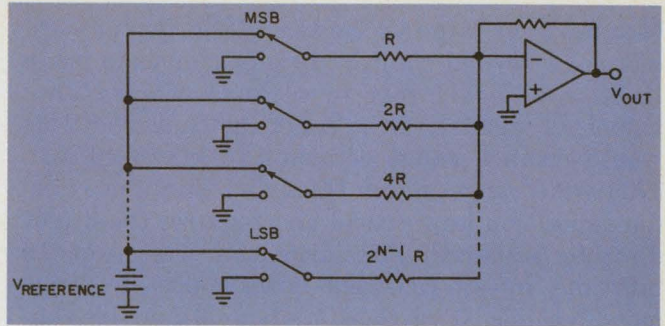

1. Weighted-ladder d/a converter uses binary weighted resistors in each bit line and sums the currents in an output amplifier.

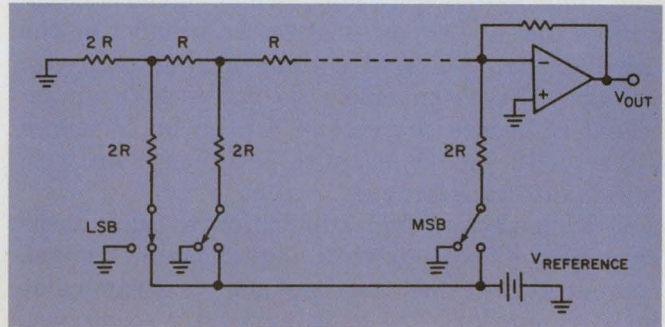

2. R-2R D/A converter has the same current in each bit line. But as the current moves to the amplifier, it gets divided by two at each node.

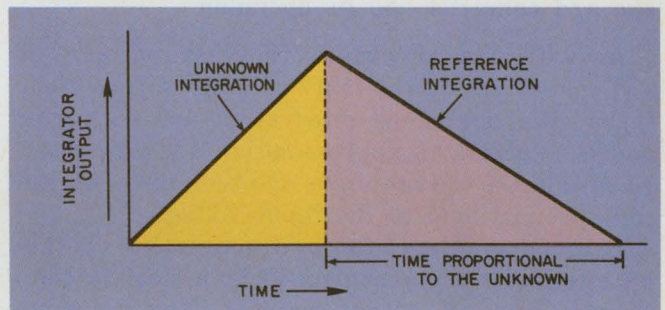

3. Dual-slope integration requires that the unknown signal be integrated for a fixed time. An opposite-polarity reference is then attached, and the time it takes the integrator output to return to zero is proportional to the value of the unknown.

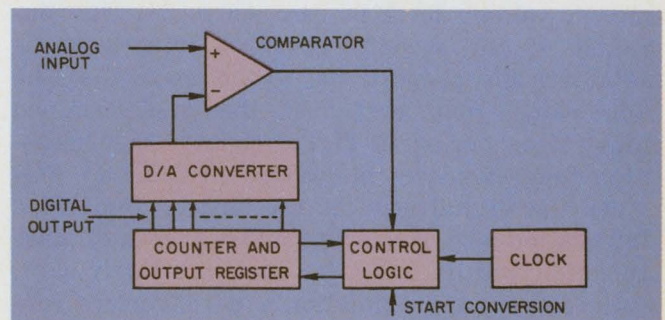

4. Successive approximation a/d converters work in a fashion similar to a chemical balance. They weigh each bit against the unknown, starting with the most significant bit and working down to the least significant.

becomes very large as the size of the digital word increases beyond eight or 10 bits. For example, a 12-bit d/a would require a range of resistance values of 4096:1. In a practical converter this would mean a range of about 10 k $\Omega$  to 40 M $\Omega$ . This wide range makes thick and thin-film resistor deposition impractical and requires the use of discrete resistors. For large converters—of 16 bits and up—a cascaded quad approach seems more feasible. It cascades individual four-bit converters via 16:1 current attenuators. The result is up to 16 bits of resolution in four-bit increments.

Other d/a configurations use similar types of ladder networks. One important type of d/a is the multiplying converter, which generates an output that is proportional to the product of the input digital code and a time-varying reference voltage. These converters do not include an internal reference source and can be implemented either with ladder network techniques or with taped autotransformers.

D/a converters find application in such areas as analog display driving, digital motor control, computer-controlled testing and programmable instrumentation. The multiplying d/a seems well suited to such applications as graphic displays, where vector multiplications must often be generated.

### The a/d converter and its operation

As with d/a converters, the vast majority of a/d converters on the market comprise two basic types: the dual-slope integration a/d converter and the successive approximation a/d converter. Each takes a voltage input and puts out a digital code proportional to the input voltage.

Dual-slope integration a/d converters contain an integrator, some control logic, a clock, a comparator and an output counter. The unknown voltage is fed into the integrator for a predetermined period of time, as measured by the clock. Then a reference input voltage of opposite polarity is switched to the integrator. As the integrator processes the reference voltage, the output of the integrator decreases from the unknown voltage level to zero (Fig. 3). The duration of the second period of integration is automatically proportional to the average of the unknown signal level over the predetermined integrating period. A digital counter then measures the reference integration period and provides the digital code at the output. Dual-slope integration a/d converters offer excellent noise rejection and linearity, but they are fairly slow.

Successive approximation a/d converters contain a comparator, a d/a converter, a shift register, an output register and some control logic (Fig. 4). The input voltage is fed to one input of the comparator, while the output of the inter-

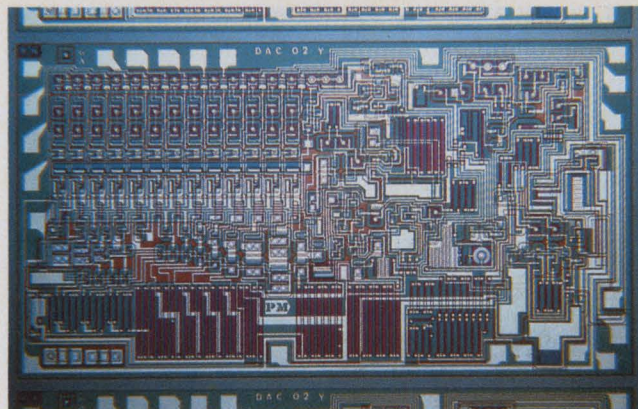

Precision Monolithics' MonoDAC-02 is the first 10-bit monolithic d/a to hit the market. It has a diffused R-2R network and dissipates only 500 mW.

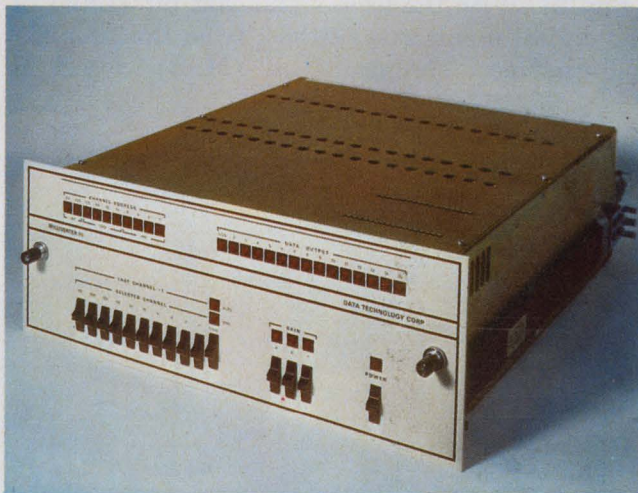

The Milliverter II, produced by Data Technology as an amplifier-per-channel data-acquisition system. A 15-bit a/d for automatic test systems is included.

nal d/a converter goes to the other input. Each bit line in the d/a converter corresponds to a bit position in the output register. When a conversion command is applied, the converter is cleared and the MSB output of the d/a is fed to the comparator to be tried against the unknown input level. The MSB output is, of course, equivalent to one-half the converter's full-scale range. If the unknown is greater than the MSB, a ONE is inserted in the MSB position in the output register. If the unknown is less than the MSB, a ZERO is inserted. Then the circuit tries the next bit in the d/a. If this bit doesn't exceed the input, a ONE goes into its position in the output register. If it does, a ZERO is positioned. The procedure continues through to the LSB, at which stage the conversion is completed. The procedure is similar to a chemical balance in which one weight is added at a time. The main advantage of the successive approximation a/d is speed. Accuracy is primarily determined by the accuracy of the internal d/a.

In addition to the two most widely used



schemes, there are many other types of a/d converters on the market. These include single-slope integrator, triple-slope integrators, voltage-to-frequency converters, voltage-to-pulse rate converters, parallel-series converters and straight parallel converters.

The various types of a/d converters are used primarily in data-acquisition systems and modems. Parallel-series and straight parallel converters are used primarily where extremely high speed is required.

### Specmanship and the d/a

Almost all manufacturers give typical specs and sometimes maximum or minimum room temperature—either 25 or 23 C. And most give all specs at nominal power-supply voltages. Temperature range and response to power-supply variation are two of the most important factors to consider in d/a's and a/d's. Temperature coefficients are usually given only for a few specs and sometimes not given at all. Susceptibility to power supply variations is only rarely stated, and often in confusing terms.

The most easily misunderstood d/a specs are resolution, accuracy and speed. Resolution is almost always stated in terms of bits—6, 8, 10, 12 or 16. This is immediately misleading. Resolution is an output quantity that refers to the difference between two voltage levels generated by the application of adjacent input digital codes, such as 000001 followed by 000010. Therefore resolution should be stated as a voltage, generally in mV. It is derived by taking the full-scale voltage range and dividing it by  $2^n$ , where  $n$  is the number of bits accepted in the input digital code. Thus if the full-scale range is 10 V and the converter accepts a 10-bit code, the resolution would be  $10/1024$ , or 9.75 mV. Another way of looking at resolution is to regard it as the voltage value of one LSB.

When figuring a converter's resolution distinguish carefully between full-scale range, full-scale voltage and just "full-scale." In a bipolar converter with, for example, an output range of  $\pm 10$  V, the full-scale range is 20 V, the full-scale voltage is 10 V, and full scale is whatever makes the manufacturer's spec sheet look better. Some manufacturers have been known to use full-scale range on one data sheet and full-scale voltage on another.

Accuracy is often confused with resolution. In fact, the two specs are only loosely related. Whereas resolution gives the size of an output step, accuracy gives the relationship of the specific voltage of any given step to the National Bureau of Standards standard volt. This figure is occasionally called absolute accuracy.

Sometimes accuracy is stated in terms of the

relationship of the actual value of the voltage to the resolution. When so defined, it is usually quoted as a portion of an LSB. A widely quoted, but misleading, figure is  $\pm 1/2$  LSB. This merely guarantees that the voltage at the output of the converter at some nominal temperature, like 25 C, is somewhere within the resolution of the converter. It doesn't say anything about what happens if the temperature varies. Accuracy is rarely stated for a temperature range; either the manufacturer says nothing about temperature or he gives a separate temperature coefficient accuracy (tempco). With fragmented specs, the user must do the calculation to find out how much the temperature must move before the  $\pm 1/2$  LSB figure no longer holds. This temperature range may be only a few degrees.

Since accuracy relates to an analog quantity, it would be better stated as percentage deviation. Also, purists point out that it should really be called "inaccuracy."

When a tempco is given, it should also be given in percent per degree centigrade. This would allow the engineer to calculate easily the variation in accuracy over a temperature range. Unfortunately most manufacturers prefer to give the figure in ppm (parts per million) Centigrade. This is quite easily converted to percent per degree C, but why should it be necessary to convert? Specs should be given consistently in the first place. Note also that specified tempcos are often just typical figures. Few manufacturers take the trouble to measure it accurately for many units and to come up with a reliable maximum tempco figure.

Absolute accuracy consists of several components. Included are scale factor, linearity, offset voltage and power-supply rejection, to name just a few of the most important. Scale factor relates to the actual output voltage when the input calls for a full-scale output. The deviation from the desired level is the scaling error. This should be given as a percentage of full scale, but it rarely is. When a line is drawn from the actual full-scale value down through zero, the deviation from that line is sometimes called the relative accuracy. It is also sometimes called the linearity of the d/a, but shouldn't be because when the input code calls for zero output, the resulting output is usually a finite voltage. The latter is called the offset voltage.

To get true linearity—or, more correctly, non-linearity—of the converter, the line should be drawn from the actual full-scale reading to the offset voltage. Now, deviations from that line are the true nonlinearity of the converter.

Power-supply voltage changes will often cause the full-scale voltage to vary. Thus the linearity—and, in turn, the accuracy—will vary. Sometimes, but not often, a term called power-supply

rejection is offered. It is usually in terms of “% per %.” Only in rare cases is the engineer told exactly what this means. It usually means percent change in scale factor for a 1% change in power-supply voltage. Sometimes, though, it means percent change in accuracy for a 1% change in power-supply voltage. It is also sometimes called power-supply sensitivity. This particular spec appears more commonly in a/d converter data.

Since accuracy is made up of all of these factors, it could be important to know how each varies. Variations occur with both temperature and time. Sometimes scale-factor errors and offset voltage can be nulled with external potentiometers. But other error sources aren't so easily corrected.

Linearity is the most important individual spec. Unless it is always within  $\pm 1/2$  LSB, the converter may be nonmonotonic—that is, when the input code calls for a small increase in the output, the output may go down instead. Most users of d/a's are in bad shape if their converters aren't monotonic. Bad things happen—like oscillation in feedback systems.

Each factor affecting accuracy varies differently with temperature. A well-written spec sheet will give separate tempcos at least for linearity, scale factor and offset voltage. Also the tempcos should be maximum figures, not typical. In fact, max/min figures should be given for all specs. “Typical” figures have been the cause of many cost overruns. If the d/a has a zener-diode reference—and not all do—the reference voltage must be recalibrated occasionally. It varies with time, causing variations in the scale factor. But how often it should be calibrated is rarely indicated on data sheets.

Long-term linearity variations are caused by variation in the resistive ladder network. Thick-film resistors can change as much as 0.1% a year. Wirewound resistors are better, but they cost more and respond slower. In addition resistor values can be affected by thermal and electrical stress during use. Variation of specs with time affects the repeatability of the d/a. Some d/a's carry the term “precision.” Precision means repeatability. Yet few manufacturers give the engineer any way of knowing how their converters will respond to the same code a day later, a month later or a year later.

Over-all accuracy specs are usually averages of the various classes of error. Sometimes the “accuracy” is an RMS average. Sometimes it is a measured value.

Many users expect a 12-bit d/a to be accurate to 0.01% over the full quoted temperature range of the converter. This is  $\pm 1/2$  LSB for 12 bits. More likely it will be accurate to  $\pm 1/2$  LSB for some window around 25 C and then accurate to



A two-channel d/a made by Perkin-Elmer, the only company to produce a multiplying d/a that uses an auto-transformer rather than a resistive ladder network.

$\pm 1/2$  LSB for 11 bits for a while and then 10 bits and then nine bits.

For some applications, this may be all right. But, when it isn't, the engineer doesn't find out until it's too late. It is possible for a 12-bit d/a to have only 10-bit accuracy to  $\pm 1/2$  LSB, and it is possible to have 14-bit accuracy to  $\pm 1/2$  LSB. Remember, resolution and accuracy are independent quantities. In most feedback control systems, resolution and monotonicity are much more important than accuracy. If they are for you, tell the vendor. He can usually get you a cheaper unit.

#### Settling time vs slewing rate

Do d/a's settle or slew? In fact, they do both. Both are often specified, and they should be, so the designer can know how fast the d/a actually converts.

Settling is often given as the time that it takes the output voltage to move from one stable level to the next, to within  $\pm 1/2$  LSB, while the input changes from one code to the next adjacent one. At other times it is given for a change from zero to full scale on the output when the input code calls for the change. The time required for a full-scale change is the maximum conversion time and the more important of the two. Sometimes both figures are given. If settling time is given only for a one-LSB change, the converter will seem to be much faster than it actually is. Settling time may also vary, depending upon whether the unit is a voltage-output d/a or a current-output d/a. Additional confusion is caused by the fact that settling time is often specified to within 0.1%, 0.05% etc., of full scale. These figures may or may not correspond to  $\pm 1/2$  LSB.

Slewing rate is the rate of change in  $V/\mu s$  that the output is capable of attaining. It is controlled by the output amplifier.

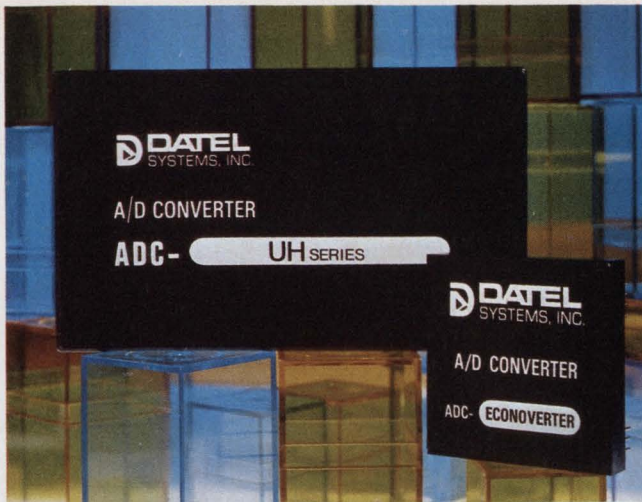

Datel's ADC-UH8B an eight-bit a/d, has a conversion rate of 10 MHz. The ADC-Econoverter is a six-bit a/d that sells for only \$22.95.

Sometimes switching time is given. This is the settling time less the period of damped oscillation after the output has completed its initial ramp and overshoot the desired value.

#### Noise a problem with high resolution

As the quoted resolution of the d/a converter gets above 11 or 12 bits, noise becomes of considerable concern. It takes two forms: internally generated noise in the converter and external noise picked up from the power supply or other adjacent circuitry. Internal noise can be specified by the manufacturer as either an rms value,  $3\text{-}\sigma$  noise or peak noise over the bandwidth of the converter. It rarely is given for d/a's, but sometimes is given for high-resolution a/d's.

Sometimes common-mode, or normal-mode, rejection are given as well. These specs relate mainly to external noise. Often there is enough pickup from the power supply to throw the converter out of its rated accuracy. An even more common problem, once the resolution gets up to 16 bits, is caused by the resistance of even short runs of conventional wiring. For example, consider the case of a 16-bit d/a with a 10-V, full-scale range. Just 15 mA—the full scale current output of a typical d/a of this type flowing through two feet of 18 gauge wire—will drop approximately  $165\ \mu\text{V}$ , or the equivalent of slightly more than 1 LSB for this converter. This raises the entire converter to a finite common-mode voltage—large enough to seriously degrade the converter's accuracy.

Noise problems such as these can be relieved by careful shielding of the converters, the use of decoupling networks at the power-supply ports of the converter and other techniques of careful circuit design. Some manufacturers build in such features; others don't. The only sure way to



A differential d/a, the Model 840, made by Computer Central. It gives an analog-signal output that is proportional to the difference between two parallel BCD inputs.

know whether a converter will work in your equipment is to get one and try it.

A slightly different type of noise problem in d/a's is that of voltage spikes on the output caused by the closing of the switches within the converter. These glitches can easily be several LSBs in magnitude, and they can cause problems in the external circuitry. Some converters have built-in deglitchers—sample-and-hold circuits that hold the output of the converter constant during each switching period and then let it go to the next value. But these circuits add to the price of the converter and are not necessary in many applications.

Many options are available with d/a's. You can usually specify the input code to the converter. Most popular of the available codes are straight binary, binary-coded decimal, gray, ONEs-complement binary, TWOs-complement binary, sign-magnitude, offset binary and a variety of other modified or complementary codes. The converter may or may not have an output buffer amplifier. It may or may not have an internal reference; for very high accuracy, it is better to provide your own external reference. The converter may have a variety of output voltage or current ranges. Finally it may come with a variety of operating temperature ranges. When comparing prices, make sure the options are all the same.

#### A/d specs are similar to d/a specs

Most everything said for d/a specs also holds for a/d specs. These also are often typical rather than max/min specs, and they may be given only at a nominal temperature and power-supply settling. A main difference is that the output of an a/d is a series of digital codes. Therefore accuracy and resolution, as well as most other specs, should be given in digital terms rather than ana-

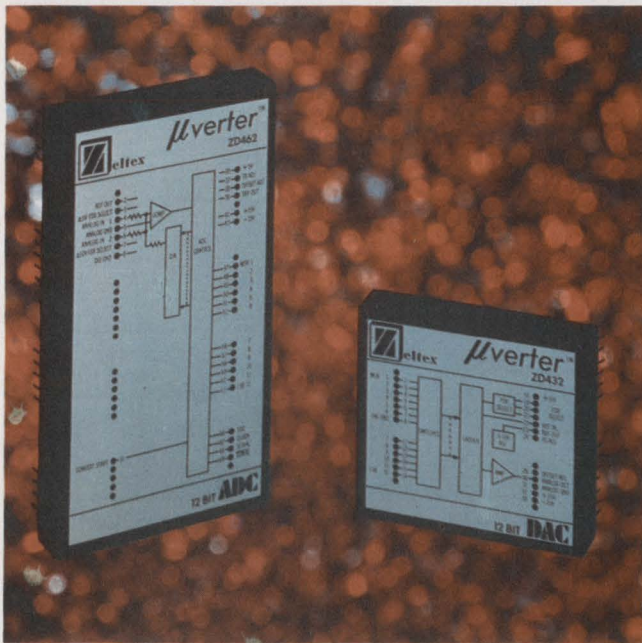

A pair of economy 12-bit products produced by Zeltex. The ZD462 is an a/d that sells for \$99 (1-99). The ZD432 is a d/a that sells for \$49 (1-99).

log. For example, resolution is in bits. Since the number of bits defines the number of discrete output codes that the input analog signal can be broken into, it is fair to talk of an 8, 12 or 15-bit a/d converter.

Accuracy must also be given in terms of bits. Therefore the terminology  $\pm 1/2$  LBS is fair. Four additional factors enter into accuracy that are not called out for d/a converters. They are quantizing error, missing codes, aperture error and differential linearity.

Quantizing error refers to the fact that a range of analog voltages are represented by a discrete digital code. The width of that range is 1 LSB. Since an a/d converter inherently breaks up a linear signal into discrete steps, it is quantizing the signal. The inherent quantization error of every a/d converter is  $\pm 1/2$  LSB. This is over and above any other errors that contribute to the inaccuracy of the converter.

Missing codes come about when the input voltage passes through a range that is supposed to be represented by a particular code and that code is not there. In its place is the code either directly before or directly following the desired one. Some converters guarantee no missing codes; most do not. If missing codes can exist, the stated resolution of the converter is also in question.

Aperture error arises from converter indecision as to the proper input voltage to convert, if the input varies by more than equivalent 1 LSB during the conversion time of the converter. For example, should the output code represent the signal at the beginning of the conversion time or the signal just before the end of the conversion time? Most converters give the code cor-

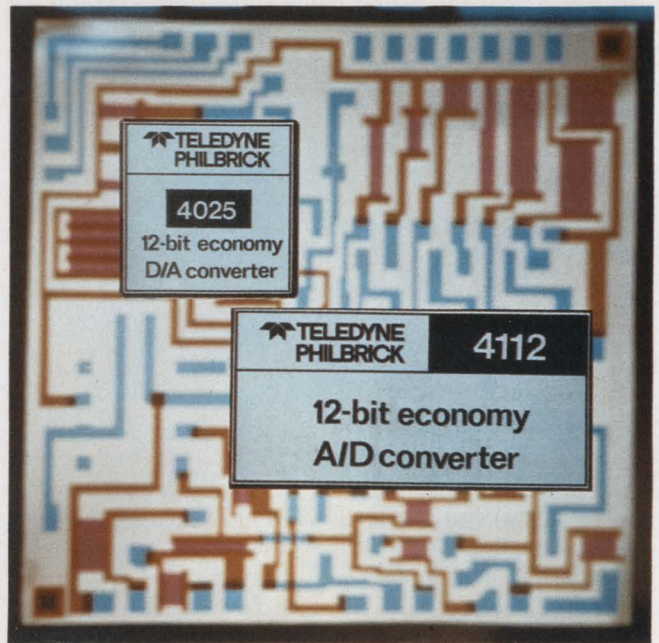

Teledyne-Philbrick's pair of economy 12-bit units. The 4112 is an a/d that sells for \$109 (1-9). The 4025 is a d/a that sells for \$69 (1-9).

responding to the signal at the beginning of the conversion time. Others do not. Only a very few manufacturers acknowledge aperture error with a spec on the data sheet.

Differential linearity is the difference in the size of the quantum steps represented by the digital output codes. For example, if one code represents 10-mV of input range and another only 8-mV, the differential linearity is 2 mV. If an LSB is 10 mV, the differential linearity would probably be stated on the spec sheets as  $\pm 1/10$  LSB. This is fair, since the output of the converter is digital and errors in it should be expressed digitally.

Other errors—such as linearity, offset voltage and scaling or gain error—also exist. The same problems occur with a/d's as, we saw earlier, with d/a's. This is true for errors, tempcos and noise.

#### How fast an a/d?

Speed in an a/d converter is really the number of conversions that can be made in a unit time. It is best given as a conversion rate or throughput rate. Sometimes speed is given as a conversion time. This is misleading. There is a necessary dead period between conversions called the reset time. It is the time that it takes the system to absorb a conversion and reset its amplifiers. This is rarely given, but usually it is on the order of a few hundred nanoseconds. It must be added to the conversion time before the reciprocal can be taken to derive the conversion rate.

Similar options exist for a/d's as for d/a's. The differences lie in the fact that voltage ranges

apply to the input, while the output is a digital code. An additional option that is sometimes offered is a parallel-serial converter for the output. Most a/d's do not have input buffer amplifiers, but they are offered as options.

### What's available in the field

There are so many manufacturers of d/a's and a/d's that it is difficult to pick out the best unit for an application. No monolithic a/d's are on the market yet. However, several manufacturers make six or eight-bit monolithic d/a converters, among them Precision Monolithics, Harris Semiconductor, Motorola, Fairchild and Siliconix. Only Precision Monolithics, with its Mono DAC-02, has a 10-bit monolithic DAC on the market at present. This unit has a diffused R-2R ladder network and a settling time to  $\pm 0.05\%$  of  $1.5 \mu\text{s}$ . Analog Devices will soon introduce a competing 10-bit d/a that will also be monolithic and will feature a thin-film R-2R network. Motorola is offering six and eight-bit multiplying d/a's. These monolithic units can usually be specified over a MIL temperature range of  $-55$  to  $+125$  C.

Most commercial units are for the range of  $0$  to  $70$  C. Aside from the monolithic units and some of the hybrid, few converters will work over the full MIL temperature range.

Among the fastest d/a's on the market are the eight-bit DAC 371-8 from Hybrid Systems, which settles in  $950$  ns; 10-bit MDS-1020 from Computer Labs which settles in  $20$  ns; 14-bit MP-1914A from Analogic, which settles in  $3.5 \mu\text{s}$ ; 15-bit 1535 from Tustin, which settles in  $1 \mu\text{s}$ ; and 16-bit 20255 from Lancer, which settles in  $15 \mu\text{s}$ . Other manufacturers with very fast d/a converters include Analog Devices, Burr-Brown, Inter Computer Electronics, Optical Electronics, Zeltex, Function Modules, Cycon and Data Device Corp.

Many manufacturers also produce economy d/a converters that don't have outstanding specs but are cheap. Some examples of these are the 12-bit 4025 from Teledyne-Philbrick, which sells in small quantities for \$69; eight-bit 371-8 from Hybrid Systems, \$9.90; 12-bit ZD432 from Zeltex, \$49. Of the 16-bit DACs on the market, one of the cheapest is the DAC 45 from Burr-Brown, at \$350. Several other manufacturers are aggressively promoting low-cost d/a converters—Datel, Function Modules, Cycon, Analog Devices and Micro Networks.

A/d's come in all shapes and sizes—from rack-mounted instruments like the Data Technology 15-bit Milliverter II, and comparable units from Xerox and Preston Scientific, to economy modules and hybrids from Zeltex, Datel and Hybrid Systems.

Among the more unusual converters on the

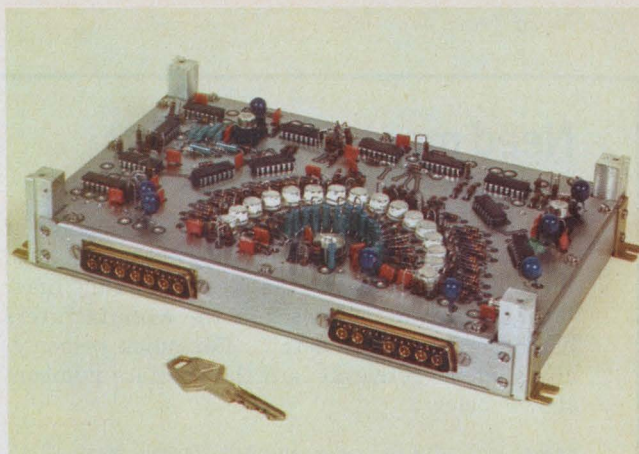

The MOD-4100, four-bit a/d made by Computer Labs is a parallel unit with a 100-MHz conversion rate. It sells for about \$2000 and is the fastest a/d on the market.



Singer-Kearfott's SKC-2950 is an eight-bit militarized a/d converter. It features a 25-ns conversion time and has two channels.

market are the DD/A 840 from Computer Central. It is a differential d/a that gives an analog output proportional to the difference between two parallel BCD inputs.

Another interesting product is the Perkin-Elmer Varidac series—one, two and four-channel d/a converters that do not use a resistor network but taps on an autotransformer for extremely stable operation over a wide temperature range. These d/a's are of the multiplying type.

D/a's and a/d's are getting faster, smaller and cheaper. The trend seems to be towards packing more and more electronics into small packages. Instead of just getting an a/d in a module, you can now get a whole data-acquisition system, including a/d, multiplexer, sample-and-hold amplifier and logic. Often even memory and buffer amplifiers are included. This field is still in its infancy. As it matures, a more standard means of specifying converters may appear. ■■

(continued on page 64)

## Need more information?

The products cited in this report have, of necessity, received only cursory coverage. And they don't represent the vendors' full lines. Readers may wish to consult the manufacturers listed here for more details. For quick response, circle on the retrieval card the boldface numbers shown below:

- Adage, Inc., 1079 Commonwealth Ave., Boston, Mass. 02215. (617) 783-1100. (Rod Stotz, Marketing Manager). **Circle 316**
- AD Data Systems, Inc., 830 Linden Ave., Rochester, N.Y. 14625. (716) 381-2370. (Harry Turner, President). **Circle 317**
- AIL, Div. Cutler Hammer, Inc., Comac Rd., Deer Park, N.Y. 11729. 595-6471. (John McMurray, Business Development). **Circle 318**
- Aim Electronics, Ltd., the River Mill Stives, Huntingdonshire, England. **Circle 319**
- American Astrionics, 291 Kalmus Dr., Costa Mesa, Calif. 92626. (714) 557-8480. (Phillip Harms, Project Engineer). **Circle 320**
- American Electronic Laboratories, Inc., P. O. Box 552, M/S 1123, Lansdale, Pa. 19446. (215) 822-2929. (A. Rosset, Manager Advertising). **Circle 321**
- Analog Devices, Inc., P.O. Box 280, Norwood, Mass. 02062. (617) 329-4700. (Martin Dross, Sales Manager). **Circle 322**
- Analogic Corp., Audubon Rd., Wakefield, Mass. 01880. (617) 246-0300. (Fred Molinari, Director of Marketing). **Circle 323**
- Applied Devices Corp., 60 Plant Ave., Hauppauge, N.Y. 11787. (516) 234-4000. (Saul Seigel, Director of Engineering). **Circle 324**
- Astro-Systems, Inc., 6 Nevada Dr., Lake Success, N.Y. 11040. (516) 328-1600. (N.I. Wheatcroft, Vice President Marketing). **Circle 325**
- Austin Electronics, 450 First Ave., Roselle, N.J. 07203. (201) 241-3300. (J. F. Donnelly, Sales and Estimation). **Circle 326**
- Baldwin Electronics, P.O. Box 3838, Little Rock, Ark. 72203. (501) 375-7351. (Herb Weise, Advertising Manager). **Circle 327**
- Beckman Instruments, Inc., 8475 Artesia Ave., Buena Park, Calif. 90620. (714) 521-3700. (Lyle Pittruff, Sales Supervisor). **Circle 328**
- Burr-Brown Research Corp., International Airport, Industrial Park, Tucson, Ariz. 85706. (602) 294-1431. (Tom Fern, Vice President Marketing). **Circle 329**
- CAE Electronics Ltd., Box 1800, Montreal, Quebec. **Circle 330**
- California Instruments Corp., 5150 Convoy St., San Diego, Calif. 92111. (714) 297-8620. (Walt Hanford, Product Manager). **Circle 331**
- Canadian Research Institute, 85 Curlew Dr., Don Mills, Ontario. **Circle 332**
- Canberra Industries, 45 Gracey Ave., Meriden, Conn. 06450. (203) 238-2351. (Ben Compo, Assistant Marketing Manager). **Circle 333**
- C & A Products, Inc., 28-17 33th St. Astoria, N.Y. 11102. (212) 721-6220. (R. Bogin, Sales Manager). **Circle 334**
- Chuo Electronics Co., Ltd., No. 1-9-9 Motohonomachi Hachijai-shi, Tokyo, Japan. (M. Yoshiwara). **Circle 335**
- Coleman Systems, 18842 Teller Ave., Irvine, Calif. 92664. (714) 833-1810. (Mrs. Hopkins, Sales Office Manager). **Circle 336**
- Columbia Components Corp., 60 Madison Ave., Hempstead, N.Y. 11550. (516) 483-8200. (Tom Reiersen, Marketing Manager). **Circle 337**
- Computer Central, P.O. Box 804, Gaithersburg Md. 20760. (301) 948-5557. (Robert Kearns, Marketing Manager). **Circle 338**
- Computer Conversions Corp., 6 Dunton Court, E. Northport, N.Y. 11731. (516) 261-3300. (Steve Renard, Sales Manager). **Circle 339**
- Computer Labs, 1109 S. Chapman, Greensboro, N.C. 27403. (919) 292-6427. (Don Brockman, Sales Manager). **Circle 340**
- Computer Products, Inc., 1400 N. W. 70th St., Fort Lauderdale, Fla. 33307. (305) 974-5500. (Larry Buck, Marketing Manager). **Circle 341**
- Conrac Corp., 1600 S. Mountain View Ave., Duarte, Calif. 91010. (213) 359-9141. (Steve Millard, Sales Administrator). **Circle 342**
- Cycon, Inc., 1080 E. Duane Ave., Sunnyvale, Calif. 94086. (408) 732-8311. (Wendy Benjamin, Marketing Administrator). **Circle 344**
- Data Technology Corp., 20700 S. Fairview, Santa Ana, Calif. 92704. (714) 546-7160. (Robert Carr, Product Marketing Manager). **Circle 345**
- Datawest Corp., 7503 E. Osborn Rd., Scottsdale, Ariz. (602) 947-4295. (Mike Fishberg, Vice President). **Circle 346**
- Datel Systems, Inc., 1020 Turnpike St., Canton, Mass. 02021. (617) 828-6395. (John Gallagher, Vice President Marketing). **Circle 347**
- Digilin, Inc., 1007 Airway, Glendale, Calif. 91201. (213) 240-1200. (R. Hibbs, President). **Circle 349**
- Digital Equipment Corp., 146 Main St., Maynard, Mass. 01754. (617) 897-5111. (Alan Schulman, Public Relations). **Circle 350**
- Disc Instruments, Inc., 2701 S. Halladay St., Santa Ana, Calif. 92705. (714) 549-0343. (Everett McElroy, Product Sales Manager). **Circle 351**
- Doric Scientific Corp., 7601 Convoy St., San Diego, Calif. 92111. (714) 277-8421. (Tom O'Rourke, Manager Marketing Service). **Circle 352**
- Dynalex, Inc., 855 Front St., Burbank, Calif. 91502. (213) 849-2221. (John Molinski, Manager of Advertising Planning). **Circle 353**
- Dynamco, Div. DCA, East Mains Industrial Estate, Broxburn, W. Lothian, Scotland. **Circle 354**
- Dynamic Systems Electronics Corp., 1310 W. 23rd St., Tempe, Ariz. 85281. (602) 272-6489. (Brad Ormsby, Operations Manager). **Circle 355**
- Dynatronics Instruments, 4800 Evanswood Dr., Columbus, Ohio 43229. (614) 885-3303. (Robert Rush, Office Manager). **Circle 356**
- E-H Research Labs, Inc., P.O. Box 1289, Oakland, Calif. 94604. (415) 834-3030. (Earl Olsen, Systems Sales Manager). **Circle 357**
- Electronic Associates, Inc., 185 Monmouth Parkway West, Long Branch, N.J. 07764. (201) 229-1100. (Ken Craven, Senior Market Support Engineer). **Circle 358**
- Electronic Processors, Inc., 5050 S. Federal Blvd., Englewood, Colo. 80110. (303) 798-9305. (Robert C. Derschang, Vice President Marketing). **Circle 359**
- EMI Electronics & Industrial Operation Blyth Rd., Hayes Middlesex, England. **Circle 360**
- EMR Telemetry, Box 3041, Sarasota, Fla. 33578. (813) 958-0811. (S. D. Bass, Marketing Manager). **Circle 361**
- Fairchild Hiller Corp., Space & Electronics Support Div., Fairchild Dr., Germantown, Md. 20767. (301) 428-6000. (Bob Rafaels, Product Manager). **Circle 362**
- Fairchild Semiconductor, 464 Ellis Dr., Mountain View, Calif. 94040. (415) 962-2211. (Bob Ricks, Marketing Manager). **Circle 363**
- Fairchild Space & Defense Systems, 300 Robbins Lane, Syosset, N.Y. 11791. (516) 931-4500. (Ruth D. Miller, Manager Public Relations). **Circle 364**
- Ferranti, Ltd., Hollinwood, Lancashire, England. **Circle 365**
- Fifth Dimension, Inc., P.O. Box 483, Princeton, N.J. 08540. (609) 924-5990. (John Pohlke, Manager Telemetry Sales). **Circle 366**
- Flight Research, Grotel Co., P.O. Box 1-F, Richmond, Va. 23201. (703) 222-0163. (Melvin Swartz, Marketing Manager). **Circle 367**
- Fluidyne Instrumentation, 470 27th St., Oakland, Calif. 94612. (415) 444-2376. (Roger Jennings, President). **Circle 368**
- Function Modules, 2441 Campus Dr., Irvine, Calif. 92664. (714) 833-8314. (Skip Osgood, Marketing Manager). **Circle 369**
- Gap Instrumentation, 110 Marcus Blvd., Hauppauge, N.Y. 11787. (516) 273-0909. (Walter Soboleski). **Circle 370**
- General Automation, Inc., 1055 S. East St., Anaheim, Calif. 92805. (714) 778-4800. (Donald Allen, Manager Public Relations). **Circle 371**
- General Dynamics, Electro Dynamics Div., P.O. Box 2566, Orlando, Fla. 32802. (305) 834-1000. (H. E. Paul, Manager Marketing Administration). **Circle 372**
- General Instrument Corp., 600 W. John St., Hicksville, N.Y. 11802. (201) 485-2100. (Max Fox, Sales Manager). **Circle 373**
- Gralex Industries, 155 Marine St., Farmingdale, N.Y. 11735. (516) 694-3607. (Michael Neidich, Marketing Manager). **Circle 374**
- Harris-Intertype Corp., 55 Public Square, Cleveland, Ohio 44113. (216) 861-7900. (Meryl Burns, Manager Marketing Electronics). **Circle 375**
- Harris Semiconductor, Melbourne, Fla. 32901. (305) 727-4496. (Jack Kompan, Marketing Communications Manager). **Circle 376**
- Hybrid Systems Corp., 87 Second Ave., Burlington, Mass. 01803. (617) 272-1522. (Carl Kramer, Sales Manager). **Circle 377**
- Hy Comp, Inc., P.O. Box 250, Maynard, Mass. 01754. (617) 897-4578. (Norman S. Palazzini, Vice President). **Circle 378**
- ILC Data Device Corp., 100 Tec St. Hickville, N.Y. 11801. (516) 433-5330. (Stephen Muth, Senior Application Engineer). **Circle 379**
- Innovatek Enterprise, Smithfield Rd., Millerton, N.Y. 12546. (914) 373-9122. (P. F. Fitts, Sales Manager). **Circle 380**
- Intech, Inc., 1220 Coleman Ave., Santa Clara, Calif. 95050. (408) 244-0500. (Bobbie Fikes, Marketing Services). **Circle 381**
- Inter Computer Electronics, Inc., P.O. Box 507, Lansdale, Pa. 19446. (215) 855-0922. (James D. Raby, Marketing Manager). **Circle 382**

- Intronics, Inc., 57 Chapel St., Newton, Mass. 02158. (617) 332-7350. (Allen Kizer, Director of Marketing). **Circle 383**
- Kearfott Div., Singer General Precision, Inc., 1328 Main Ave., Clifton, N.J. 07015. (201) 256-4000. (Walter Hughes, Marketing Manager). **Circle 384**
- Kelk, Ltd., George 48 Lesmille Rd., Don Mills, Ontario, Canada. **Circle 385**
- Kepeco, Inc., 131-38 Sanford Ave., Flushing, N.Y. 11352. (212) 461-7000. (Charles Parrish, Sales Engineer). **Circle 386**
- Lancer Electronic Corp., 1416 W. Main St., Norristown, Pa. 19401. (215) 539-4410. (David G. Aiken, Sales Engineer). **Circle 387**
- Lear Siegler, Inc., Instrument Div. 4141 Eastern Ave. S. E., Grand Rapids, Mich. 49508. (616) 241-7000. (Hal Walton, Manager Product Information). **Circle 388**
- Le Croy Research Systems Corp., 126 North Route 313, W. Nyack, N.Y. 10994. (914) 358-7900. (Mike Beddesen, Marketing Manager). **Circle 389**
- Megadyne Industries, Inc., 1665 Buffalo Rd., Rochester, N.Y. 14624. (716) 328-4242. (Abe Terpening, Director of Operations). **Circle 390**
- Micro Networks Corp., 5 Barbara Lane, Worcester, Mass. 01604. (617) 756-4635. (Bruce Smith, Marketing Manager). **Circle 391**
- Monitor Labs, Inc., 10451 Roselle St., San Diego, Calif. 92121. (714) 453-6260. (John Carley, Application Engineer). **Circle 392**
- Monitor Systems, Aydin Co., 401 Commerce Dr., Fort Washington, Pa. 19034. (215) 646-8100. (J. T. Adair, Marketing Manager). **Circle 393**
- Montedel Div., Laben Via Eldorado Bassini 15, Milan, 20133, Italy. **Circle 394**
- Moore, Inc., 8158 Orion St., Van Nuys, Calif. 91406. (213) 787-5559. (John Kauke, Vice President Marketing). **Circle 395**
- Motorola, Government Electronics Div., 8201 E. McDowell Rd., Scottsdale, Ariz. 85252. (602) 273-4571. (Bob Novascone, Public Relations). **Circle 396**
- Motorola Semiconductor, 5005 E. McDowell, Phoenix, Ariz. 85008. (602) 962-2292. (Ron Campo, Linear IC Manager). **Circle 397**
- MPC Products Corp., 4200 W. Victoria Ave., Chicago, Ill. 60646. (312) 583-5100. (F. M. Steinwandtner, Advertising Manager). **Circle 398**
- Nano Fast, 416 W. Erie St., Chicago, Ill. 60610. (312) 943-4323. (Carl Vespa, General Manager). **Circle 399**
- NES, Inc., 7N662 Route 53, Itasca, Ill. 60143. (312) 773-0370. (Robert Martin, Sales Manager). **Circle 400**
- Norden Div. United Aircraft Corp., Norwalk, Conn. 06856. (203) 838-4471. (John Cronen, Product Manager). **Circle 401**
- North American Rockwell, Autonetics ASD, 3370 Miraloma Ave., Anaheim, Calif. 92803. (714) 632-8111. (Stan Robertson, Marketing). **Circle 402**
- North Atlantic Industries, Inc. 200 Terminal Dr., Plainview, N.Y. 11803. (516) 681-8600. (Peter Wittenberg, Sales Manager). **Circle 403**
- Northern Precision Laboratories, Inc., 202 Fairfield Rd., Fairfield, N.J. 07006. (201) 227-4800. (Mike Nigro, Director of Engineering). **Circle 404**
- Northern Scientific, Inc., 2551 W. Beltline Highway, Middleton, Wis. 53562. (608) 836-6511. (John W. Orth, Marketing Manager). **Circle 405**
- Nuclear Enterprises, Ltd., Bankhead Crossway, S. Edinburgh, Scotland. **Circle 406**
- Nuclear-Chicago, 2000 Nuclear Dr., Des Plaines, Ill. 60018. (312) 298-6600. (Dick Beers, Advertising Manager). **Circle 407**
- Nuclear-Data, Inc., 100 West Golf Rd., Palatine, Ill. 60067. (312) 529-4600. (Tom Tendarvis, Marketing Manager). **Circle 408**
- Optical Electronics, P.O. Box 11140, Tucson, Ariz. 85706. (602) 624-8358. (S. Day, Sales Manager). **Circle 409**
- Perkin-Elmer Corp., Industrial Products Div., Danbury Road., Wilton Conn. 06897. (203) 762-1000. (Larry Kovaravic, Manager Marketing). **Circle 410**
- Phoenix Data, Inc. 3384 West Osborn Rd., Phoenix, Ariz. 85017. (602) 278-8528. (Bob Nelson, Vice President Marketing). **Circle 411**
- Pivan Data Systems, 6955 N. Hamlin Ave., Lincolnwood, Ill. 60645. (312) 676-0790. (Shari Becker, Office Manager). **Circle 412**
- Plessey Co., Vicarage Lane, Ilford, Essex, England. **Circle 413**
- Precision Monolithics, 1500 Space Park Dr., Santa Clara, Calif. 95050. (408) 246-9225. (Jerry Zis, Product Marketing Manager). **Circle 414**
- Preston Scientific, Inc., 805 E. Cerritos Ave., Anaheim, Calif. 92805. (714) 776-6400. (Bernard Spear, Vice President Marketing). **Circle 415**
- QDC Corp., 3568 U.S. Route 22, Somerville, N.J. 08876. (201) 534-2900. (M. Leff, Chief Engineer). **Circle 416**
- Ragen Precision Industries, 9 Poreta Ave., North Arlington, N.J. 07032. (201) 997-1000. (James Hobbs, Marketing Manager). **Circle 417**
- SCI Electronics, Inc., 8620 S. Memorial Parkway, Huntsville, Ala. 35802. (205) 881-1611. (Ron Warner, Marketing Manager). **Circle 418**
- Siemens Corp., 186 Wood Ave., S. Iselin, N.J. 08830. (201) 494-1000. (Martin Weitzner, Marketing Manager). **Circle 419**
- Signet Controls, Inc., 7611 E. 42nd Pl. Tulsa, Okla. 74145. (918) 622-6670. (James Worden, Chief Engineer). **Circle 420**
- Signal Analysis Industries Corp., 595 Old Willets Path, Hauppauge, N.Y. 11787. (516) 234-5700. (Frank Kasper, Sales Manager). **Circle 421**
- Signetics Corp., 811 E. Arques Ave., Sunnyvale, Calif. 94086. (408) 739-7700. (Roy Twitty, Public Relations). **Circle 422**
- Siliconix, Inc., 2201 Laurelwood Rd., Santa Clara, Calif. 95054. (408) 246-8000. (Robert Landon, Publicity Director). **Circle 423**
- Sinclair Radio Laboratories, 122 Rayette Rd., Maple, Ontario, Canada. (W. M. Peace, Sales Administration). **Circle 424**
- Solid State Electronics Corp., 15321 Rayen St., Sepulveda, Calif. 91343. (213) 894-2271. (Edward Polit, General Manager). **Circle 425**
- Sprague Electric Co., 125 Marshall St., N. Adams, Mass. 01247. (617) 853-5000. (Ron Beck, Hybrid Circuit Marketing Manager). **Circle 426**
- SRC Div. Moxon, Inc., 2222 Michelson Dr. Newport Beach, Calif. 92664. (714) 833-2000. (Jerry Heyer, Vice President Marketing). **Circle 427**
- Struthers-Dunn, Inc., Lambs Rd., Pitman, N.J. 08071. (609) 589-7500. (Larry Davis, Advertising Manager). **Circle 428**
- Summit Engineering Corp., P.O. Box 938, Bozeman, Mont. 59715. (406) 587-0636. (Jim Drain, Vice President). **Circle 429**
- Superior Manufacturing and Instrument Corp., 19-36 38th St., Long Island City, N.Y. 11105. (212) 932-1800. (Arthur Metch, Contracts Manager). **Circle 430**
- Systems Engineering Labs, 6901 W. Sunrise Blvd., Fort Lauderdale, Fla. 33313. (305) 587-2900. (Ted Swift, Director of Communications). **Circle 431**
- Takeda Riken Industry Co., Ltd., 1-32-1 Asahi-Cho-Ne/ima Ker, Tokyo, Japan. **Circle 432**
- Teledyne Crystalonics, 147 Sherman St., Cambridge, Mass. 02140. (617) 491-1670. (Joel Cohen, Director of Engineering). **Circle 433**
- Teledyne-Gurley, 514 Fulton St., Troy, N.Y. 12181. (518) 272-6300. (Jack Newton, Marketing Manager). **Circle 434**
- Teledyne Philbrick, Allied Dr. at Route 128, Dedham, Mass. 02026. (617) 329-1600. (Walter Patstone, Product Manager). **Circle 435**
- Teledyne Systems Co., Lewisburg Div., Industrial Park, Lewisburg, Tenn. (615) 359-4531. (Ralph Mann, Manager of Future Programs). **Circle 436**
- Teledyne Telemetry Co., 1901 S. Bundy Dr., Los Angeles, Calif. 90025. (213) 478-0211. (Mark McMougel, Manager Advertising Marketing). **Circle 437**
- Texas Instruments, Inc., 12201 Southwest Freeway, Stafford, Tex. 77477. (713) 494-5115. (Gerald McGee, Product Marketing). **Circle 438**
- Theta Instruments Corp., 24 Dwight Pl. Fairchild, N.J. 07006. (201) 227-1700. (Tom Villano, Sales Manager). **Circle 439**
- Tohoku Metals Industries, Ltd., 13-10 7-Chome, Ginza Chuo-ku, Tokyo, Japan (K. Suzuki). **Circle 440**
- Toledo Scale Co., Div. Reliance Electric Co., 5225 Telegraph Rd., Toledo, Ohio 43612. (419) 478-5811. (J. Robert Terry, Advertising Manager). **Circle 441**
- Tranchant Electronique, 19 Rue MME De Sanzillion, 92 Clichy, France. **Circle 442**
- TRW Systems Group, BCRI Space Park, Redondo Beach, Calif. 93278. (213) 536-1977. (Hank Dimond Program Development). **Circle 443**
- Tustin Electronics, 2103 S. Grand, Santa Ana, Calif. 92705. (714) 835-0677. (Jim Buchanan, Marketing Manager). **Circle 444**
- Varian, 611 Hansen Way, Palo Alto, Calif. 94303. (415) 326-4000. (Joe DePaolo, Product Manager). **Circle 445**
- Vega Precision Labs, 239 Maple Ave., W. Vienna, Va. 22180. (703) 938-6300. (Larry Cooper, Director Technical Services). **Circle 446**
- Vernitron Corp., 300 Marcus Blvd., Deer Park, N.Y. 11729. (516) 586-5100. (Jerry Moonellis, Marketing Manager). **Circle 447**
- Westinghouse Electric Corp., Westinghouse Bldg., Pittsburgh, Pa. 11222. (412) 255-3319. (J. M. Dravillas, Manager Industrial Information). **Circle 448**
- Wyle Laboratories, 128 Marland St. El Segundo, Calif. 90245. (213) 948-4251. (George Gruel, Marketing Manager). **Circle 449**
- Xerox, 701 S. Aviation, M/S M1-63, El Segundo, Calif. 90245. (213) 679-4511. (Dean Van Peurse, Marketing Manager, Logic & Analog). **Circle 450**
- Zeltex, Inc., Sub Redcor Corp., 1000 Chalomar Rd., Concord, Calif. 95420. (415) 686-6660. (Russ Ferreira, Marketing Services). **Circle 451**

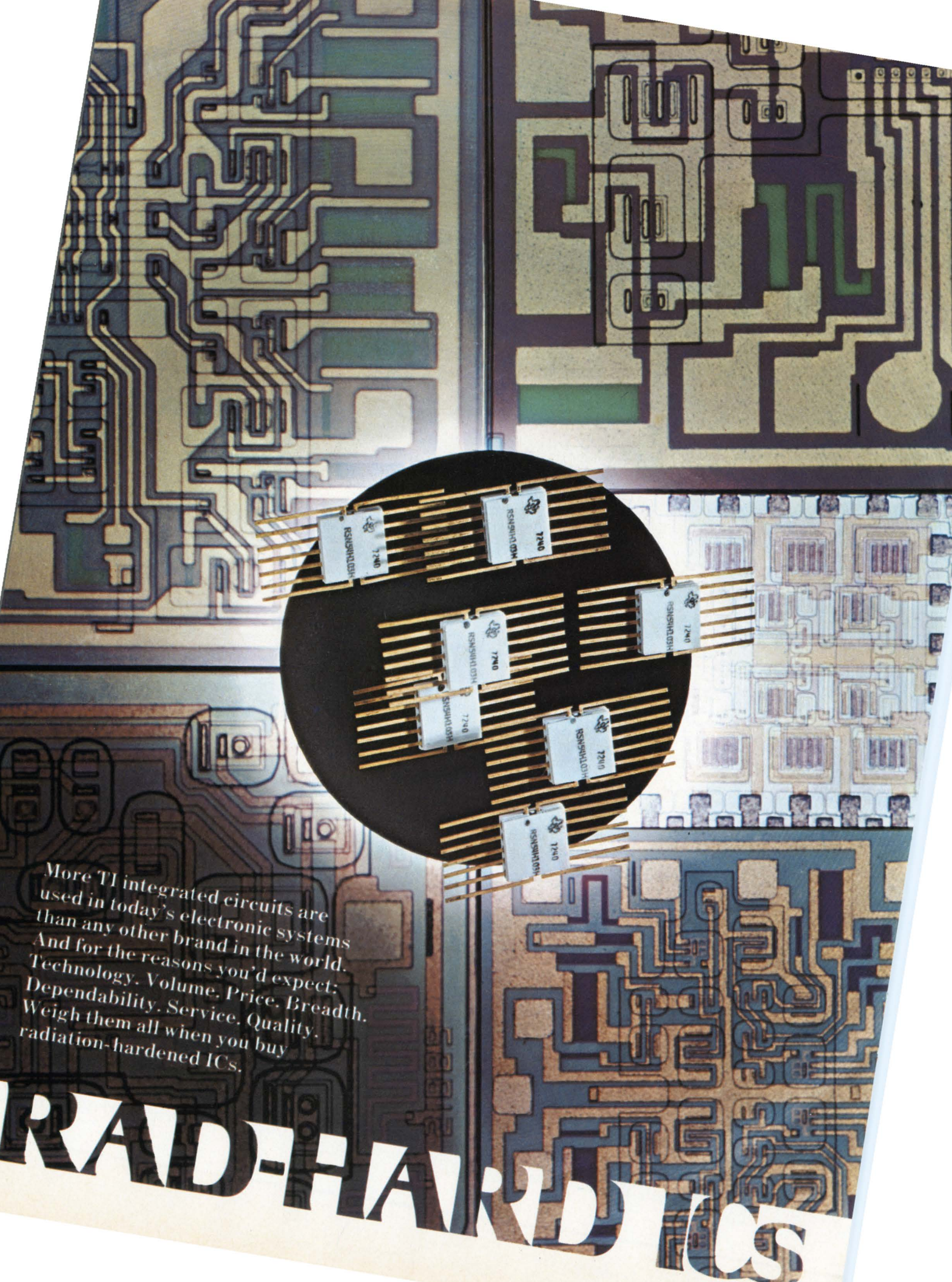

More TI integrated circuits are used in today's electronic systems than any other brand in the world. And for the reasons you'd expect: Technology. Volume. Price. Breadth. Dependability. Service. Quality. Weigh them all when you buy radiation-hardened ICs.

# RADIATION ICs



# If your system calls for radiation-tolerant ICs, TI can provide full-service support.

**49 standard digital and linear functions.  
Custom capability backed by more than a decade  
of "rad-hard" R&D and production experience.  
Computer-aided design. Comprehensive documentation.**

## Full service.

From materials technology to product design, manufacturing experience and capability, support data and program management—Texas Instruments can supply everything you need to meet the most challenging system and program requirements.

TI has been solving radiation effects problems for more than 10 years ... and is a major supplier of radiation-hardened devices for strategic defense systems.

## Technological strength— now and in the future

TI is thoroughly experienced in all technologies basic to radiation-tolerant integrated circuits, including dielectrically isolated substrates, thin-film resistors, minimum-size transistor geometries, narrow base widths, various packaging options and photocurrent compensation, where required.

Computer-aided design is now a matter of routine for both the design and layout of TI radiation-tolerant integrated circuits.

And TI will continue to extend its technological capability by combining radiation-hardening expertise with in-depth knowledge of MSI, beam leads and low-power Schottky TTL. (In addition, TI has depth experience in "rad-hard" discrete devices—both power and small-signal—and offers a broad line.)

## Complete custom capability

In addition to its standard rad-hard line, TI has complete facilities, personnel and know-how—including all necessary R&D back-up—for the design of radiation-tolerant devices to your specifications and program requirements. A top-secret facility and storage security clearance, as well as provisions for comprehensive documentation, further strengthen TI's ability to provide full-service support.

## Industry's broadest standard line

TI today offers industry's broadest line of standard rad-hard ICs—49 digital and linear functions, with more to come.

## Digital ICs

	1mW/30ns	10mW/10ns	20mW/7ns	DTL
	TTL	TTL	TTL	
Quad 2 NAND	RSN54L00	RSN5400	RSN54H00	-
Hex inverter	-	RSN5404	RSN54H04	-
Triple 3 NAND	RSN54L10	RSN5410	RSN54H10	RSN15962
Dual 4 NAND	RSN54L20	RSN5420	RSN54H20	RSN15930
Single 11 NAND	-	RSN5431	RSN54H31	-
Dual 4 buffer	-	RSN5440	RSN54H40	RSN15932
Dual 4 power gate	-	-	-	RSN15944
Dual 2-wide AOI	-	RSN5456	RSN54H56	-
Single 4-wide AOI	RSN54L57	RSN5457	RSN54H57	-
Single 2-wide AOI	-	RSN5458	RSN54H58	-
Dual 3-2 AOI	-	-	RSN54H66	-
RS flip-flop	RSN54L71	-	-	-
JK flip-flop	RSN54L72	-	-	RSN15945
Dual D flip-flop	RSN54L74	RSN5474	RSN54H74	-
Dual J-K flip-flop	-	-	RSN54H103	-
One shot	RSN54L122	-	-	-
Dual 3 NAND	RSN54L130	-	-	-
Dual 3 NAND w/expander	RSN54L131	-	-	-
3-to-8 decoder	-	-	RSN54H149	-

## Linear, Interface ICs and Monolithic Arrays

Standard operational amplifier	RSN52709
High-performance operational amplifier	RSN52800
2-channel/capacitor-coupled plated-wire sense amplifier	RSN55900/55910
4-channel/DC-coupled plated-wire sense amplifier	RSN55920
Dual 500mA word switch	RSN14026
Quad JFET interface driver	RSN21890
7-diode array	RSN14925
16-diode array	RSN14097
Quad 30mA NPN transistor array	RSN21885
Quad 100mA NPN transistor array	RSN21886

## For more information

For price and availability, call your local TI sales office. Or call Gerd Noebel, in Dallas, (214) 238-3025. For a copy of TI Bulletin CB-146, "Radiation and Semiconductors," circle 250 on the Reader Service card. Or write Texas Instruments Incorporated, P. O. Box 5012, M/S 308, Dallas, Texas 75222.



**TEXAS INSTRUMENTS**  
INCORPORATED

## Engineering jobs: What, why and where?

All indicators point to more jobs, more money and a major shortage of engineers in the near future.

Richard L. Turmail, Management Editor

Like the sign of the absentee merchant, "Back in ten minutes—already been gone five," engineering employment seems to be returning almost before it left. Despite impressions to the contrary, a number of jobs are unfilled in the electronics industry, according to a recent survey by ELECTRONIC DESIGN.

From this study of 30 representative companies and from other sources, the following highlights emerge:

- Four of every five electronics companies surveyed by ELECTRONIC DESIGN reported many openings for engineers.
- The demand for engineers and scientists has nearly doubled in the last year.
- A major shortage of engineers is expected in three to four years, with shortages reported even now in some fields.
- Some 1500 job openings for aerospace engineers, and 12,200 electrical engineers in general are expected annually throughout the decade.
- Company reservations for college recruiting are up after a two-year decline.
- The over-all rate of unemployment among engineering graduates is only about 3%, or about half the national average.

### Survey reveals job openings

The employers in ELECTRONIC DESIGN's survey, which was conducted in the last quarter of 1972, reported job openings in a wide variety of engineering disciplines, with logic, digital and circuit designers, processor engineers and systems and industrial engineers leading the demand. Digital Equipment Corp. of Maynard, Mass., reports that it is becoming a total systems house and will need 600 domestic field-service engineers over the next year.

Specialized engineering skills, including designers of biomedical, spacecraft-power and command and control systems, are also in demand but on a smaller scale. Few of the companies sur-

## Bachelor's Degrees in Engineering, All U.S. Schools

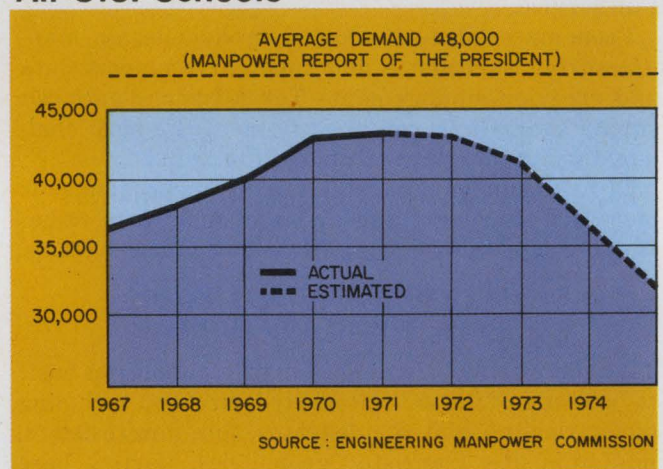

veyed, perhaps one in 10, reported that they were phasing out engineering disciplines. For the industry as a whole, there does not appear to be any engineering category that is obsolete.

Following is a breakdown of engineering openings turned up by the ELECTRONIC DESIGN survey. Salary ranges are included where reported. The companies were asked what jobs would be available now and in the next six months. Most indicated that most of the jobs would be available through March, 1973:

- Computer Products, Fort Lauderdale, Fla. (computers): Digital design engineer (10 to 15 k); project engineers (14 to 18 k); field engineer (9 to 12 k).
- Digital Equipment Corp., Maynard, Mass. (computers): Electronic engineers; logic and circuit design engineers; field engineers.
- Data General, Southboro, Mass., (computers): Logic designers; power supply engineers; circuit designers; memory-core engineer.
- North Electric Co., Galion, Ohio (communications): Systems test engineer; principal engineer; switching design engineer.
- Fairchild Semiconductor Products, Mountain

## A Model of Engineering Employment—1972

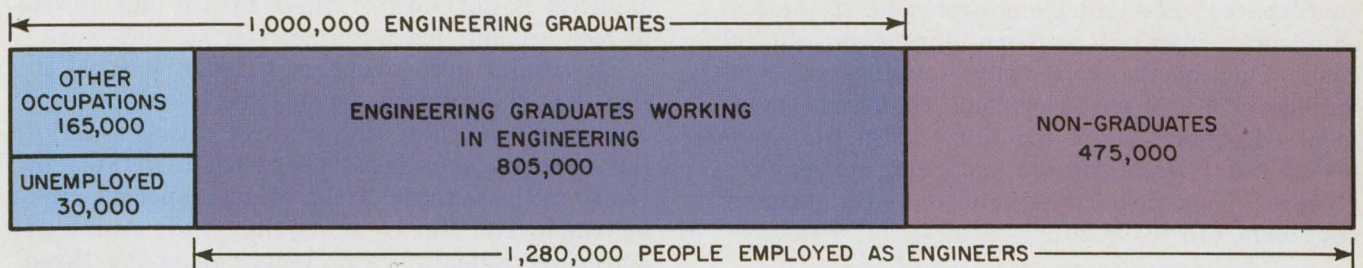

SOURCE: ENGINEERING MANPOWER COMMISSION

## Engineering Unemployment as a Function of Education

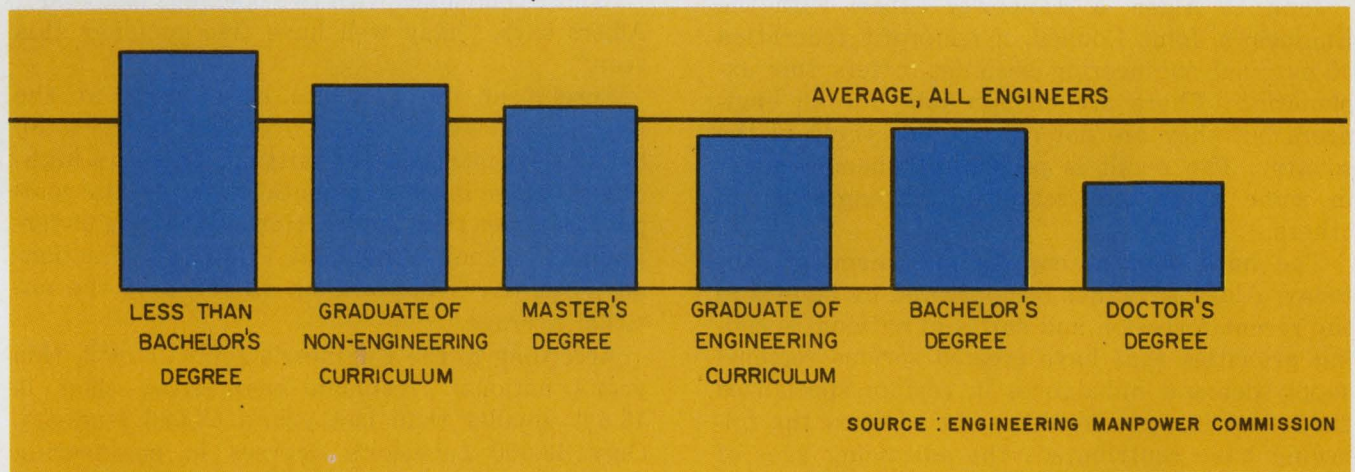

SOURCE: ENGINEERING MANPOWER COMMISSION

View, Calif.: Digital and linear circuit designers; process engineer; product engineer (all 12 to 20 k).

■ Motorola Semiconductor Div., Phoenix, Ariz.: Product engineers; process engineers: R&D staff members (all 12 to 20 k).

■ Teradyne, Boston, Mass. (test measurement): Field-service engineers; test engineers; applications engineers; circuit designer; hardware-oriented EEs; software development engineers.

■ Jet Propulsion Laboratory, Pasadena, Calif.: 10 openings for EE, ME, math or physics (12.6 to 16.3 k).

■ Stanford Research Institute, Menlo Park, Calif.: Senior systems engineers; senior research engineers.

■ Computer Identics Corp., Westwood, Mass. (systems): Project engineers, logic design and minicomputer interface (10 to 12 k).

■ Trump/Ross Industrial Controls, North Billerica, Mass. (systems): Senior electromechanical engineer (14 to 18 k).

■ Corning, Corning, N.Y. (consumer): Electrical process engineer; control engineer.

■ Du Pont, Wilmington, Del. (consumer): Engineers of all technologies.

■ RCA, New York, N.Y. (consumer): Telephone engineers (up to 15 k); satellite engineers (up to 18 k); solid-state engineers (up to 20 k); circuit-design engineers (up to 20 k); industrial engineers (up to 14 k); test equipment engineers (up to 18 k).

■ Burr-Brown, Tucson, Ariz. (components): Hybrid lab manager (16 k); applications engineer (16 k).

■ Electro Scientific Industries, Portland, Ore. (components): Product manager (13 to 18 k); programmer; EE.

■ Ballantine Laboratories, Boonton, N.J. (instruments): Circuit design engineer (10.5 to 15 k); product engineering section manager (13.6 to 17 k).

■ Hewlett-Packard, Loveland, Colo. (instruments): BSEE or MSEE, R&D (10.5 to 13.2 k); BSEE, R&D circuit-design production; BSME, R&D; process engineer.

■ Delco Electronics, Kokomo, Ind. (instruments): Semiconductor process engineer; integrated-circuit product engineer.

▪ Ground Data Corp., Fort Lauderdale, Fla. (instruments): EE (14.5 k); junior engineer (12 k); design/draftsman (13 k).

▪ North American Rockwell, Anaheim, Calif. (aerospace): Electronic engineers; electro-optical engineers; infrared systems engineers; digital design engineers; microwave engineers; communications systems; electronic countermeasure engineers; thick and thin-film circuit engineers; radar circuit design and radar systems engineers; laser field; microminicomputer memory engineers (15 to 30 k).

### Recruitment up—enrollment down

With so many jobs available, why does it seem that engineering jobs are scarce?

John D. Alden, a manpower expert with the Engineer's Joint Council, a nonprofit federation of national engineering societies, offers this explanation: There are enough jobs for all engineers but they are not distributed evenly in the country. The result is pockets of unemployment in some areas and scarcities of engineers in others.

The hard core of engineering unemployment today, Alden says, has been created by layoffs in the recent recession and shifts in national spending priorities that have created serious regional supply-demand imbalances in certain specialized fields and in some localities. In addition the following have contributed: the advancing ages of some engineers, technological obsolescence, the lack of mobility of many engineers who lost their jobs and a lack of formal educational credentials. Few engineering graduates of 1971 and 1972 have been unable to find suitable jobs, Alden says.

The Newark College of Engineering in New Jersey reports, for instance, that of the students who registered for placement services last year, 72.5% found suitable employment by June 30.

"We had good job openings in the summer for the rest of the graduates," says Richard Albers, the college's director of placement, "but we've discovered that a small, but consistent, group of students is not sure of their future and choose to 'look around' instead of actively seeking work."

Electronics jobs were reportedly hardest to find, but the referral list has increased.

Albers says that company recruiting reservations are up over last year, with a notable increase in the number of electronics concerns seeking employees. He also notes that while senior engineering students are no longer receiving three, four and even five job offers, as was often the case prior to the recent recession, the number of openings is expected to be higher than in the last couple of years.

"Those companies with two openings last year," Albers says, "may well have five openings this year."

Enrollment for graduate engineering at the Newark College is up 4% over last year's total, but student interests are shifting. There's a higher percentage in environmental work and the computer sciences than before. However, in the undergraduate school, enrollment is up only fractionally. But that's better than the drop of the national average.

According to the Engineer's Joint Council, this year's national freshman engineering class is 13.6% smaller than last year's 58,566 students. Only 43,000 bachelor's degrees in engineering were awarded in 1972, and with normal attrition, fewer than 29,000 engineers will be graduated in 1976—a total far short of the 48,000 that the Presidential Manpower Commission has predicted will be the yearly need through the end of the decade.

The U.S. Labor Dept.'s Bureau of Labor Statistics agrees that engineering opportunities for the college graduate are growing, and that in-

## Engineering Unemployment as a Function of Age

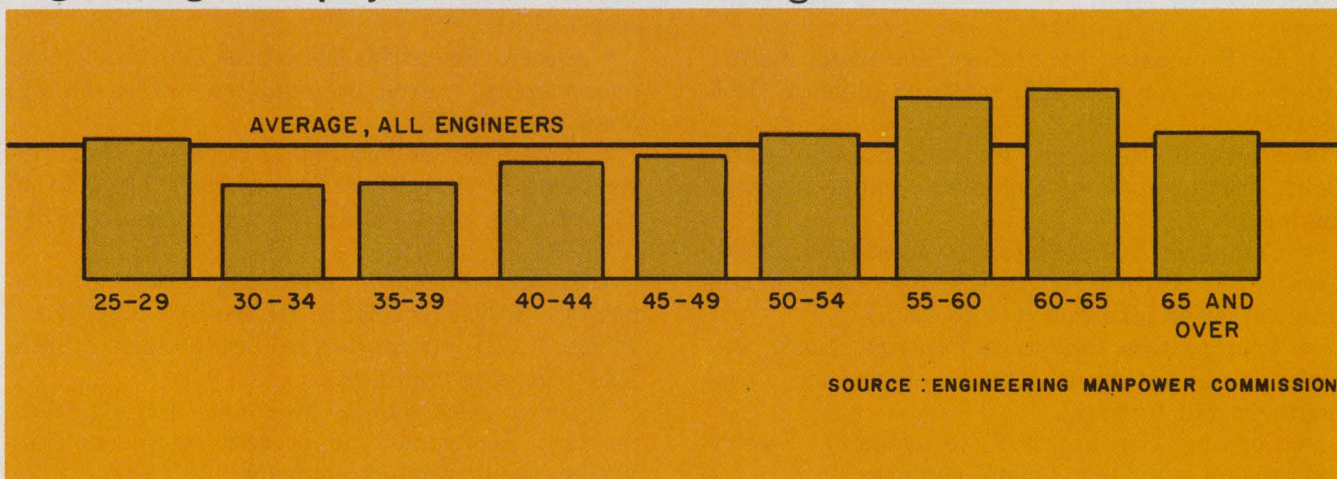

cludes career shifts and advancement to managerial spots.

According to the bureau, the long-run outlook in aerospace is favorable, but the 1500 annual openings it predicts over the next seven years may fall short of the number of engineers who are seeking employment in that field. Helping to pick up the slack, the bureau says, will be about 12,200 openings annually for electrical engineers in the rest of the industry.

### Why there are openings

Note, too, that engineering graduates are eligible for such related jobs as industrial designers, programmers, systems analysts, technical writers and urban planners. Others use their engineering background to enter the professions of patent law, medicine, business administration, science and college teaching.

Helping to spur growth in engineering employment is the demand for electrical equipment to automate and mechanize production processes, especially for such items as computers and numerical controls for machine tools. Demand for electrical and electronic consumer goods is up, too.

And even though the Government has cut back on its massive effort in aerospace, the Defense Dept. budget for fiscal 1973 is shaping up as comparable to the one in 1972. There's still a great deal of funding for such projects as the Trident submarine, the B-1 bomber, the F-14 and F-15 aircraft, the space shuttle and the usual R&D for weaponry.

The job situation is also brightened by a recent College Placement Council report that starting engineering salaries in 1972 increased for the first time in years by nearly 2% over those of the previous year. The average starting salary for an electrical engineer is \$888 a month. Engi-

### Average starting salaries, 1972 graduates

Degree level	% Change from 1971	Dollars per month
Associate Degree in Technology (ECPD Schools)	+1.6	\$ 647
Bachelor's Degree in Technology	+1.9	\$ 825
Bachelor's Degree in Engineering	+1.7	\$ 892
Master's Degree in Engineering	+1.4	\$1024
Doctor's Degree in Engineering	+4.2	\$1396

Source: Engineering Manpower Commission

neers topped practically all other occupations in starting salaries reported by the council.

What about engineering jobs this year and beyond? A quick look at engineer demand figures of recent years shows that 1961 was a more or less normal year of demand. Deutsch, Shea & Evans, Inc., a technical manpower agency, uses it as a median of 100 in an employment index that it keeps. Its engineering-scientist demand index

### Engineers Demand Index—1972

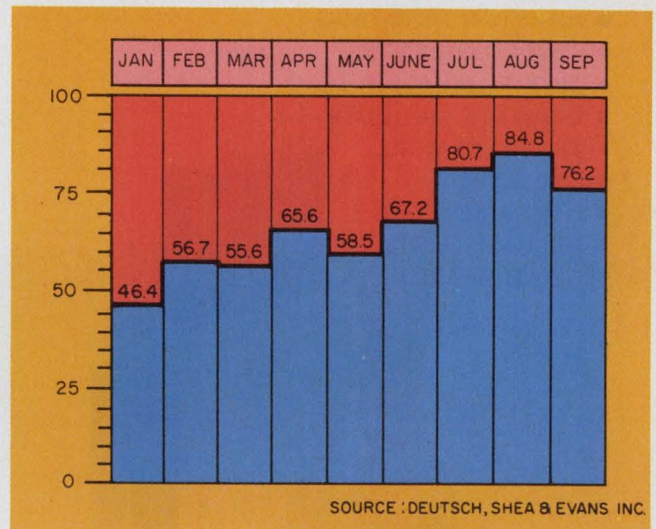

### The big picture to 1980, as painted by the U.S.

The following assumptions are made by the Bureau of Labor Statistics in arriving at its job projections to 1980:

The international climate will improve. The United States will no longer be fighting a war, but guarded relations between the major powers will permit few major reductions in armaments.

The strength of armed forces will drop to about the same level that prevailed in the pre-Vietnam escalation period.

The institutional framework of the American economy will not change radically.

Economic, social, technological and scientific trends—including values placed on work, education, income, and leisure—will continue.

Fiscal and monetary policies will achieve a satisfactory balance between unemployment and relative price stability without reducing long-term economic growth.

All levels of government will join to meet a wide variety of domestic requirements, but Congress will channel more funds to state and local government.

There will be fewer births in the country than there have been in the recent past.

# LOOKING FOR SHELLS?

We offer over 1600 Precision Molded Standard Encapsulation Shells and Headers for:

- D/A CONVERTERS
- RESISTOR NETWORKS
- SEMI-CONDUCTORS
- THIN FILM MODULES
- DISCRETE MODULES
- TRANSFORMERS
- CAPACITORS
- POWER SUPPLIES
- DELAY LINES
- OP AMPS, ETC.

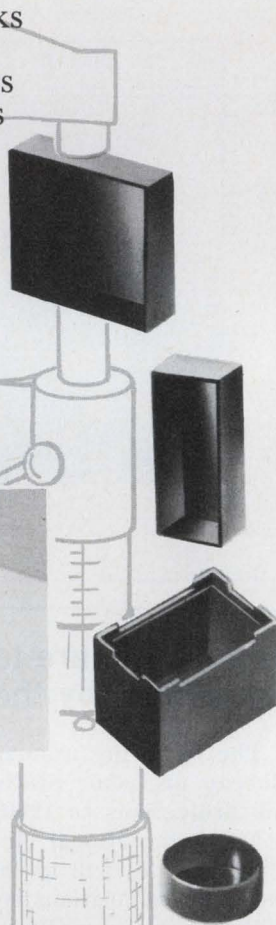
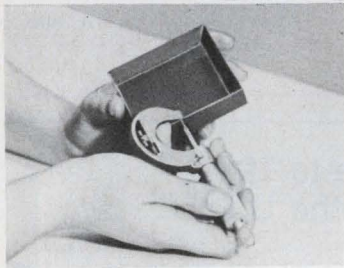

As the major supplier to the Electronics Industry (over 800 customers), we guarantee fast delivery from inventory, and short lead times for new shells. Four styles are available; Round, Oblong, Square and Module. Shells are precision molded of black flame-proof glass-fibre filled Diallyl Phthalate, conforming to MIL-M-14, type SDG-F. NO CUSTOMER TOO SMALL OR TOO LARGE!

For NEW 32-page FREE catalog write or call:



**ROBISON ELECTRONICS, INC.**

2134 West Rosecrans Avenue,  
Gardena, California 90249  
Phone (213) 321-0080, 327-5661

INFORMATION RETRIEVAL NUMBER 32

is based on a study covering over 40 publications in 20 major markets and technical journals.

The demand for any particular kind of manpower is made of three major components—replacement, transfer and growth. The demand for engineers and scientists in the U.S. reached a peak in the second and third quarters of 1966 that may never be equaled, according to Deutsch, Shea & Evans. After swooping to a precarious perch of 219 in May, 1966, the demand for engineers over the next half dozen years dived to a low of 37.4 in January, 1971. For 18 months—from mid-1970 to the end of 1971—the demand figure hovered around 40 to 45.

Now Deutsch reports an increasing demand for engineering talent in 1972. The average of 65.7 for the first nine months of 1972 is some 25 points higher than the 1971 average of 41. A year ago the demand figure was stagnating at 46.4—less than half the annual demand figure of 108.5 for 1969, the last year before the recent recession. According to Deutsch, the demand figure started to rise in earnest six months ago, and by last September it had risen 30 points since the start of 1972.

## The scenario for jobs to 1980

Technical recruiting, then, is definitely up. More companies are hiring more engineers. According to Deutsch, technical employers are placing a smaller total of recruitment ads than, say, a year ago, but they're buying more space, indicating perhaps a multiple listing of available jobs.

As for demand for technical employees beyond 1973, there are two views really, and they both hinge on what the Government does or doesn't do. A spokesman for one company covered in the ELECTRONIC DESIGN survey thought that the future depended largely on the ability and willingness of the Government to stimulate R&D work. He said that most electronics companies could not support new development work out of earnings, given the present tax and investment climate. To put it another way, fewer and fewer private investors are willing to subordinate present earning to future possibilities. He concluded that in the absence of greater incentives for private R&D, the implications for the electronics engineer could be ominous.

In some areas companies are starting to plan products that will not be dependent on Government R&D and Government contracts. Such companies, planning to compete in both the domestic and international marketplace, should be in a position to offer employment to engineers without the hidden guarantee of a layoff every three to seven years. ■■

# **This is it !**

**THE SUPER CONTEST  
OF ALL  
SUPER CONTESTS  
FOR**

**(1) Electronic Design READERS**

**(2) ADVERTISERS & THEIR ADVERTISING AGENCIES**

**Electronic Design's**

**1973 SUPER  
TOP TEN CONTEST**

*TURN THIS PAGE  
TO SEE THE  
VALUABLE  
PRIZES THAT  
CAN BE YOURS*



# WOULD YOU LIKE A CAREFREE WEEK FOR TWO IN THE BLUE CARIBBEAN?

Relax or lend a hand, swim, scuba dive, or just put your feet on the rail. Visit exotic tropical islands and foreign ports. It's the vacation for thinking people with a spirit of adventure. Sail in air conditioned comfort on big, safe windjammers. Choice of Bahamas, Virgin Islands, Windward or Leeward islands cruises. Pick your own departure dates. It's a trip you'll always remember. AND it's only part of the big first prize offered this year.

## PLUS: \$1,000 IN CASH!

Everyone can use some extra money—especially on a cruise. Use it for babysitters, tropical clothes, shop the free ports, bank it or spend it. It goes along as an extra bonus to the lucky first prize winner who picks the Top Ten ads in the January 4 issue.



### LAST YEAR'S TOP PRIZE WINNERS TELL HOW TO DO IT

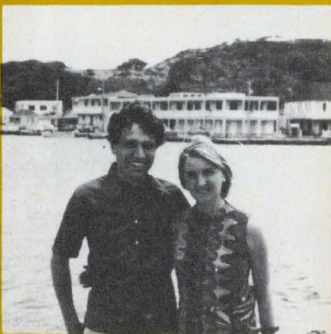

**Ronald S. Newbower**  
*Bio Engineering Division  
Harvard Anesthesia Center  
Massachusetts General Hospital*

Dr. Newbower looked through the contest issue with particular attention to general interest advertisements. He assumed that those ads with appeal to a large fraction of readers would place in the Top Ten. He also tended to choose ads for products that were (a) new (and of general interest), or (b) had their logos emphasized. The result: Dr. Newbower sailed off with first prize. He and his wife enjoyed their windjammer cruise; sent *Electronic Design* an enthusiastic note from the Caribbean island of Saint Lucia.



**William R. Austin**  
*Senior Engineer  
Singer, Simulated Products Division  
Binghamton, New York*

Mr. Austin selected 37 ads which he considered potential winners. Then he made a chart, assigning points to each ad for esthetic appeal, copy approach, usefulness, etc. — six rating categories in all. The final results were then modified using a purely subjective approach. His system must be a good one. Two or three hours of work paid off with second prize.



**Arthur L. Moorcroft**  
*E.E.  
Naval Underwater Systems Center  
New London, Connecticut*

Mr. Moorcroft first selected the 15 to 20 ads that he considered exceptional. Then culled them to pick the Top Ten. He leaned heavily toward new advertisements, new products, or new features in making his choices. The system worked well enough to make him one of the three big reader winners in last year's contest.

# Electronic 1973 SUPER TOP

TRY YOUR LUCK — ENTER THE CONTEST —



## AND: FREE JET TRANSPORTATION

This really makes the 1st prize complete. Think about it! The cruise . . . the \$1,000 in cash, AND free round-trip tickets for two on



regularly scheduled jets to the cruise's point of departure. It all adds up to the vacation of a lifetime. AND, you can be the lucky winner!

## AND: YOU CAN WIN VALUES UP TO \$4,500—OR MORE—FOR YOUR COMPANY

Another big feature of the Top Ten Contest is the free advertising you can win for your company. Here's what your company can win if it has an ad in the January 4 issue:

**A FREE RERUN . . .** for each of the ads that are voted in the Top Ten by *Electronic Design's* readers.

**A FREE RERUN . . .** if one of your company's engineers wins any one of the first 3 prizes — whether or not your ad placed in the top ten.

**A FREE RERUN . . .** if one of your company's advertising or marketing people, or your advertising agency, wins any of the first 3 prizes.

Suppose you are one of the first three prize winners. If your company has a full page, 2-color ad in the January 4 issue, your company will receive a free rerun worth \$2,165. But suppose it is a 4-color spread. You've just racked up space worth \$4,500 for your top brass.

Be sure to alert your advertising or marketing manager to these possibilities. Urge him to schedule your company's ad in the January 4 issue . . . It's an opportunity no company can afford to miss.

## PLUS 99 OTHER VALUABLE PRIZES

There are two separate Top Ten Contests, one for *Electronic Design's* engineer-readers, and one for advertisers and their advertising agencies.

### PRIZES (Reader Contest)

- 1st Prize: Windjammer cruise for two.  
Jet transportation for two.  
\$1,000 cash.  
Free ad rerun.
- 2nd Prize: Portable color TV.  
Free ad rerun.
- 3rd, 4th & 5th Prizes: Bulova timepieces.  
Free ad rerun (3rd Prize only).
- 6th thru 100th Prizes: Technical books.  
(Title to be announced.)

### PRIZES (Advertiser Contest)

- 1st Prize: Windjammer cruise for two.  
Jet transportation for two.  
\$1,000 cash.  
Free ad rerun.
- 2nd Prize: Portable color TV.  
Free ad rerun.
- 3rd Prize: Bulova timepiece.  
Free ad rerun.

## NO STRINGS, NO GIMMICKS ... HERE'S ALL YOU HAVE TO DO TO ENTER

- (1) Read the January 4th issue of *Electronic Design* with extra care.
- (2) Select the ten advertisements that you think will be best remembered by your 78,300 fellow engineer readers.
- (3) Identify the advertisements by company name and *Information Retrieval Number* (Reader Service Number) on the entry blanks bound in the issue. Mail before midnight February 15.

## THIS IS THE CONTEST ISSUE LOOK FOR RULES ON PAGE 178

Entry blanks are bound inside the front and back covers of this issue.

# Design

# TEN CONTEST

COMPLETE INSTRUCTIONS ON PAGE 178

# Get perfect linearity in CRTs when using resonant-recovery circuits with large screens and large deflection angles. A straightforward circuit provides the correction.

With rapidly rising demand for precision graphic and alphanumeric CRT displays, the linearity of CRT deflection amplifiers becomes more important. While for small deflection currents class-A deflection amplifiers are quite adequate, their low efficiency precludes their use with the larger CRTs; so-called resonant-recovery deflection circuits must be used. A problem here is that the inherent waveform of most resonant-recovery circuits does not meet even modest CRT linearity requirements. The solution is to correct the waveform.

This can be done with a relatively straightforward circuit that achieves high resolution and linearity. The resonant recovery and the correction circuit will put out the S-shaped deflection current needed to produce linear spot deflection.

## Why S-shaped current is needed

Magnetic deflection of a CRT beam inevitably produces some degree of geometric distortion, or so-called "pincushion distortion," especially if the CRT has a flat face. For example, the pin-cushion error at the edge of a flat-faced CRT with

a  $\pm 35^\circ$  deflection angle is  $\pm 18\%$  at full deflection.

Figure 1a indicates why a linear deflection current produces nonlinear spot deflections for any CRT that has other than a spherical face. Figure 1b shows that the deflection current must be nonlinear to produce linear spot deflection. And Fig. 1c depicts the deflection-current waveform—an elongated S-shape that produces a linear spot deflection.

In general, perfect linearity correction at all CRT screen locations requires a cross connection between the horizontal and vertical deflection amplifiers so that a small portion of the corrected vertical deflection signal is added to the horizontal input and vice versa. This approach, however, is both costly and complex. A more practical solution is to use electrical means to provide accurate on-axis correction in the horizontal and vertical directions, and to use external magnets to correct for off-axis distortion.

In TV displays the vertical deflection is relatively slow and requires relatively low currents. In this case a class-A amplifier can be used. The horizontal deflection, however, requires high speed at high currents, and it is here that the resonant-recovery system can be used to best advantage. In the following analysis, it is assumed that the purpose of correcting the linear resonant-recovery waveform is to provide an on-

Alfred E. Popodi, Fellow Engineer, Westinghouse Electric Corp., Baltimore, Md. 21203.

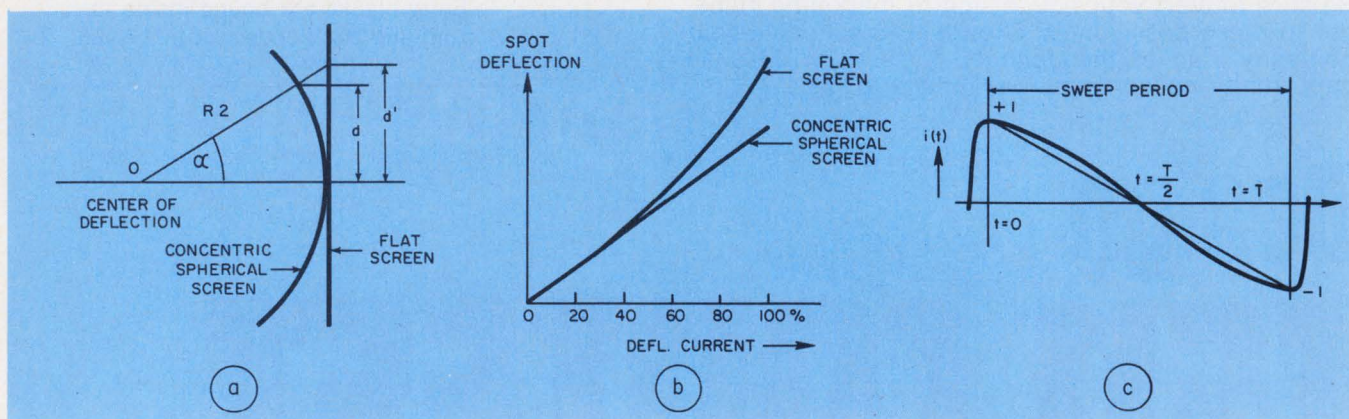

1. Large linearity errors caused by radius changes, occur in CRTs that have any screen other than a sphere (a). The nonlinearity in the spot deflection is illustrated

in b. The ideal S-shaped deflection current waveform needed to produce linear spot deflection in a CRT is demonstrated in c.

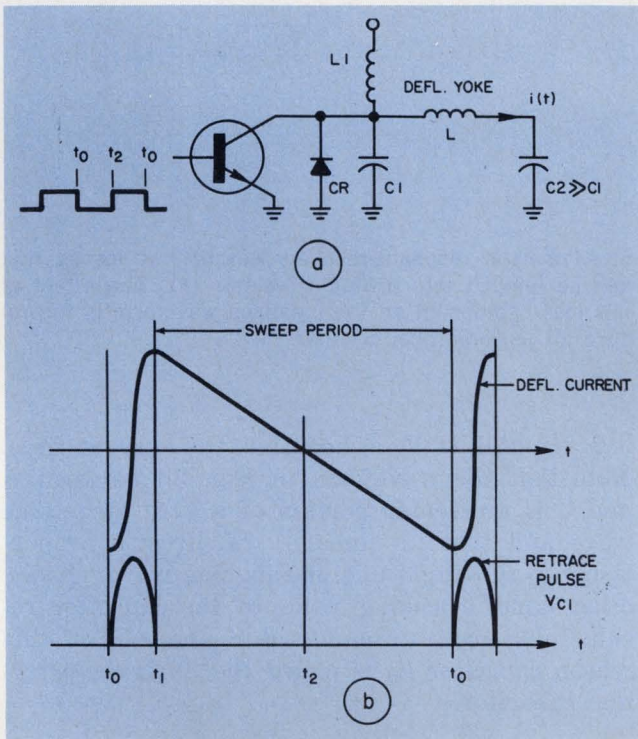

2. The basic resonant-recovery sweep circuit is simple and functional (a), but the waveform that it produces is linear (b) and doesn't correct scanning errors.

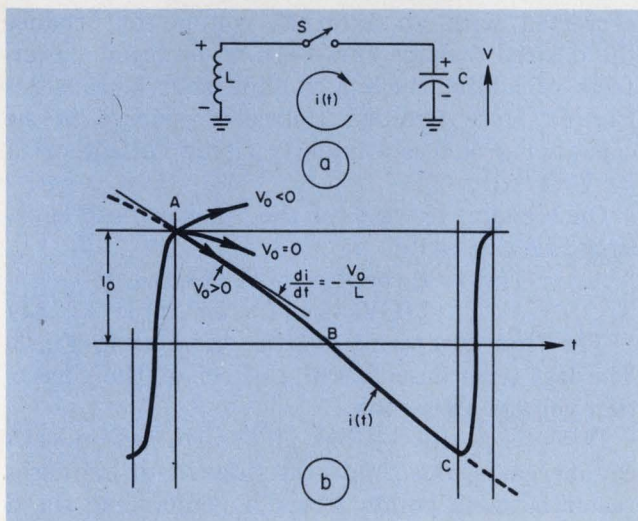

3. Operation of the resonant-recovery circuit becomes clear when we analyze its lossless equivalent circuit (a). The latter circuit produces a waveform that is slightly S-shaped (b) to produce linear deflection.

axis, S-shaped current waveform:

For a flat-faced, magnetically deflected CRT, the linearity correction factor,  $k$ , is defined by<sup>1</sup>

$$k = i_c/i_u = 1/\sqrt{1 + p^2 \tan^2 \alpha}, \quad (1)$$

where  $i_c$  is corrected deflection current,  $i_u$  is uncorrected deflection current,  $\alpha$  is maximum deflection angle at the tube edge,

and  $p$  is relative input amplitude varying between zero and one.

Thus the expression for a time-varying deflection current that is linearity corrected and that varies between  $-I$  and  $+I$  during the sweep is

$$i(t) = \frac{I_0 [-(2t - T)/T]}{\sqrt{1 + [(2t - T)/T]^2 \tan^2 \alpha}}, \quad (2)$$

where  $T$  is sweep time

and  $I_0$  is the uncorrected deflection current at time  $t = 0$ .

The curve shown in Fig. 1c is a plot of Eq. 2, and it represents the ideal, on-axis waveform of the deflection current corrected for pincushion distortion. The sweep generator must ultimately deliver current that has this waveform to the deflection yoke, if a linear spot deflection is desired.

### Analyze the resonant-recovery circuit

The basic resonant-recovery circuit (Fig. 2a) consists of the deflection yoke,  $L$ ; a retrace capacitor,  $C_1$ ; an S-curve correction capacitor,  $C_2$ , and a damper diode,  $CR$ . Inductor  $L_1$  is a charging choke with high inductance. The switching signal at the base of the transistor controls the timing.

Figure 2b depicts the characteristic current and voltage waveforms of this circuit. During the second half of the sweep period the transistor conducts and  $C_2$  acts as the energy source. When at time  $T_0$  (end of sweep) the deflection current reaches its negative peak, the transistor is cut off and the retrace period begins. The stored energy in the yoke inductance builds up a sinusoidal voltage of several hundred volts across the small retrace capacitor,  $C_1$ . When this voltage reaches zero (at time  $t_1$ ), diode  $CR$  begins to conduct and the actual sweep begins. The energy

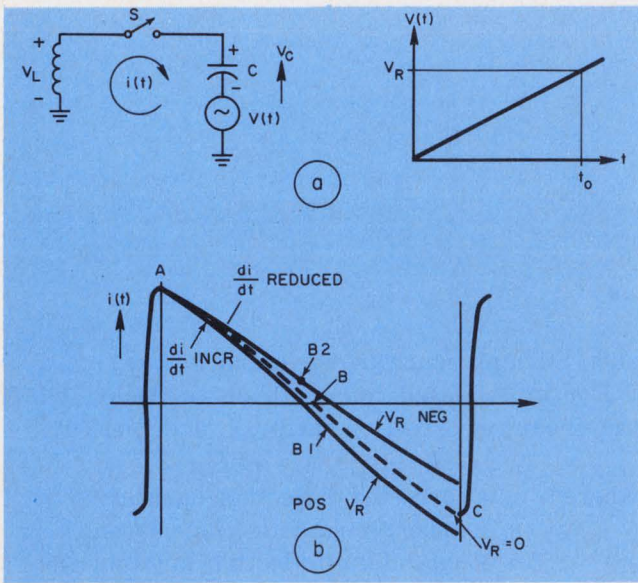

4. One way to correct the resonant-recovery waveform is to add a time-varying voltage source in series with the deflection coil (a) and thus gain control over the current-waveform slope (b).

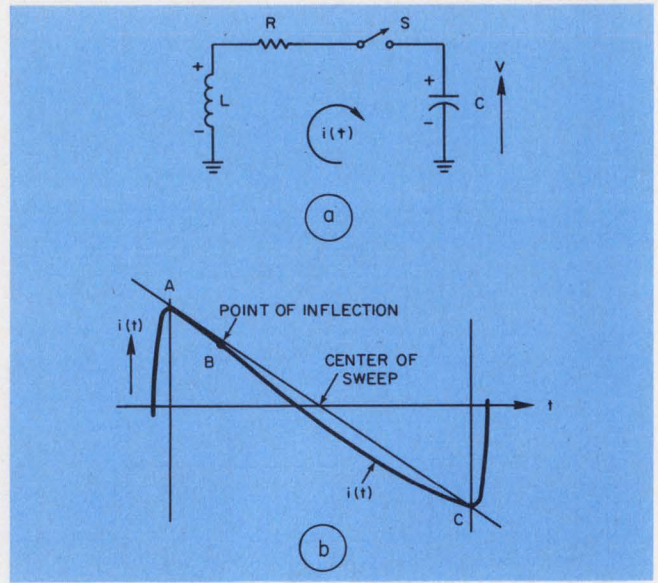

5. A realistic resonant-recovery circuit has losses that can be lumped into a single resistor (a). The effect of this loss component on the idealized waveform is to produce an asymmetrical S curve.

source is again the deflection yoke. At time  $t_2$  current polarity reverses, the diode stops conducting, and the transistor starts conducting until the end of the sweep. Capacitor  $C_2$  is now the energy source until time  $t_0$ .

When, at time  $t_1$ , the sweep begins, the equivalent lossless circuit of the sweep generator is as shown in Fig. 3a. The deflection current is a maximum at time  $t_1$  (Fig. 2a) with the inductor acting as the energy source. Capacitor  $C$  has a positive charge that opposes the current flow (hence the open switch in Fig. 3a). The lower terminal of choke  $L_1$  can be assumed to be at ground potential during the sweep, since either the diode or the transistor conduct during this time.

When switch  $S$  closes, the voltage across capacitor  $C$  is  $V = V_0$ , and the current is  $i(t) = I_0$ . Since the inductor  $L$  is the energy source, we have

$$V = -L(di/dt)$$

and

$$i = C(dV/dt).$$

Thus, if we omit the well-known intermediate equations, we can write the final expression for the current:

$$i(t) = I_0 \cos \omega t - [(V_0/Z) \sin \omega t], \quad (3)$$

where  $Z = \sqrt{L/C}$ .

The plot of Eq. 3 indicates (Fig. 3b) that the current varies sinusoidally from A to C with the initial slope  $(di/dt) = (V_0/L)$ . The slope is independent of the capacitor size. Zero-crossing point B lies exactly at the midpoint between A and C. If  $V_0$  is more positive, the current will decay faster. If  $V_0 = 0$ , the initial tangent,  $di/dt$ ,

is horizontal. If  $V_0$  is negative, the current rises. Note that the waveform in Fig. 3b between A and C is the center portion of a very large sine wave and that its linearity is directly proportional to the amplitude of this sine wave. On the other hand, a smaller value of the capacitor results in a more pronounced S shape. For this reason capacitor  $C_2$  is called the S-curve correction capacitor.

#### Add a correction voltage to resonant recovery

As was briefly mentioned earlier, the current waveform of a resonant-recovery circuit must be corrected with an external voltage to produce the desired S-shape curve. To understand the effects of adding such a voltage source, consider Fig. 4a. Here a voltage source in series with the capacitor produces a linearly rising voltage,  $v(t) = V_R(t/t_0)$ .

Once again, if we omit the intermediate equations, we can write

$$i(t) = I_0 \cos \omega t - [(V_0/Z) \sin \omega t - [(CV_R/t_0)(1 - \cos \omega t)]. \quad (4)$$

The first two terms are the same as in Eq. 3. The last term describes the effect of the correction voltage (Fig. 4b).

If  $V_R$  is positive—that is, the correction voltage increases with time—the slope  $di/dt$  increases faster between points A and B, enhancing the S shape during the first half of the sweep. The point of inflection,  $B_1$ , lies now below the zero-current line, and the waveform is no longer symmetrical. The second part of the sweep be-

comes more linear.

If  $V_R$  is negative, the first part of the sweep is more linearized and the second part more S-shaped. The point of inflection,  $B_2$ , is now shifted above the zero-current line.

This illustrates how the current waveform can be shaped by a time-varying signal that is injected into the resonant-recovery circuit. The actual waveform of the correction signal depends on the desired current waveform. In general, a positive correction signal causes a faster increase of  $di/dt$  of the deflection current. A constant dc level will have no effect on the current waveform.

We can now turn our attention to a more realistic case—a resonant-recovery circuit with normal circuit losses. If we assume that all the circuit losses can be represented by the resistor,  $R$ , the equivalent circuit is as shown in Fig. 5a. When the switch is closed, the voltage across the capacitor is  $V = -L(di/dt) - iR$ , so that

$$i(t) = -LC(d^2i/dt^2) - RC(di/dt). \quad (5)$$

Solving this equation, we get

$$i(t) = (e^{-t/2T_L}) \{ I_0 \sin[\omega \sqrt{1 - (T/4T_L)t + \psi}] - (V_0/Z) \sin \omega \sqrt{1 - (T/4T_L)t} / \sqrt{1 - (T/4T_L)} \}, \quad (6)$$

where  $T = RC$

$$T_L = L/R$$

$$\omega^2 LC = 1$$

$$Z = \sqrt{L/C}$$

$$\sin \psi = \sqrt{1 - \xi^2}$$

$$\xi = R/2Z, \text{ and } \xi > 90^\circ.$$

The term in the figure brackets represents a symmetrical, sinusoidal currents waveform, just as in the lossless case. When this term is multiplied by an exponentially decaying function, the result is an asymmetrical waveform with the point of inflection to the left of center (Fig. 5b). The first portion of the sweep looks like a straight line, with the slope gradually decaying towards the end of the sweep. In terms of display linearity, this means that the CRT spot velocity in the first half of the sweep is too high compared with the second half. This results in expansion of the video image in the first half and compression in the second half. And this is the inherent waveform of a resonant-recovery circuit. It deviates considerably from the ideal, symmetrical S-shaped curve.

### Choosing the right correction method

Whenever a resonant-recovery sweep generator is used, the purpose of the waveform correction is not only to correct for the unsymmetrical waveform of the sweep generator but also to provide the S-shaped current needed for the pincushion correction. The most accurate method is to compare the differentiated deflection current with the differentiated reference input that has

been shaped to correct for the pincushion error.

Depending on the linearity requirements, one of these four methods can be used:

1. *No correction amplifier.* For tubes with small deflection angles or in cases where the linearity needs are not very demanding ( $\pm 5\%$ ), a correction signal can be generated externally and added to the sweep circuit with a transformer. Another way is to use a properly biased saturable reactor in series with the deflection yoke (or with a transformer) to partly restore waveform symmetry.

2. *Open-loop correction amplifier.* In this case better CRT linearities can be obtained than with the previous method. The correction voltage is derived from the deflection current itself. For instance, a current transformer can be connected in series with the yoke. Its output is amplified and is added to the sweep circuit (Fig. 6a). The voltage across the yoke is given (with use of the

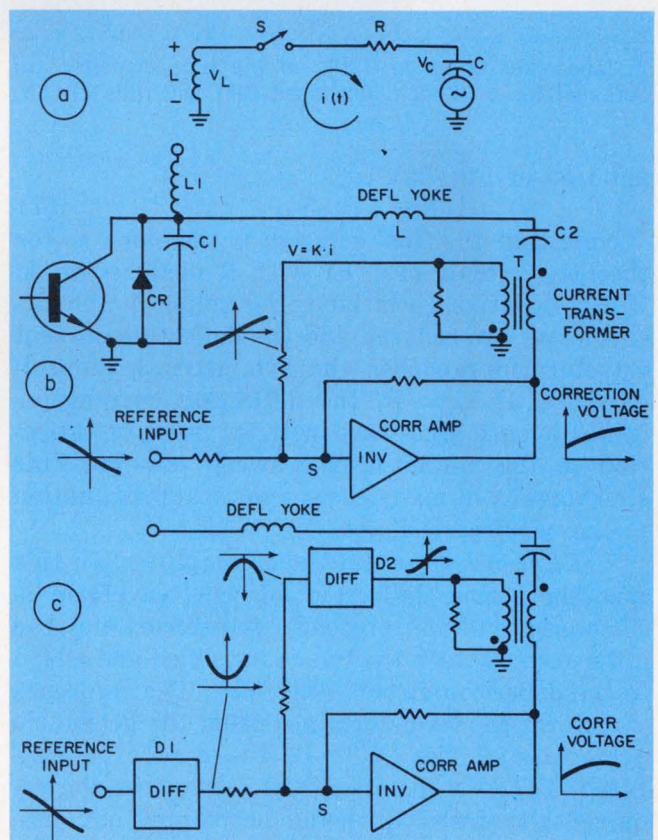

6. The desired degree of linearity determines the type of correction method to be used. A not too stringent system can use a scheme in which a correction voltage is derived from deflection current and then injected in series with the deflection coil (a). Adding a first-order feedback (b) improves the degree of linearity obtainable. The most accurate correction scheme uses a second-order feedback system in conjunction with a correction amplifier (c). Waveforms are shown for key points.

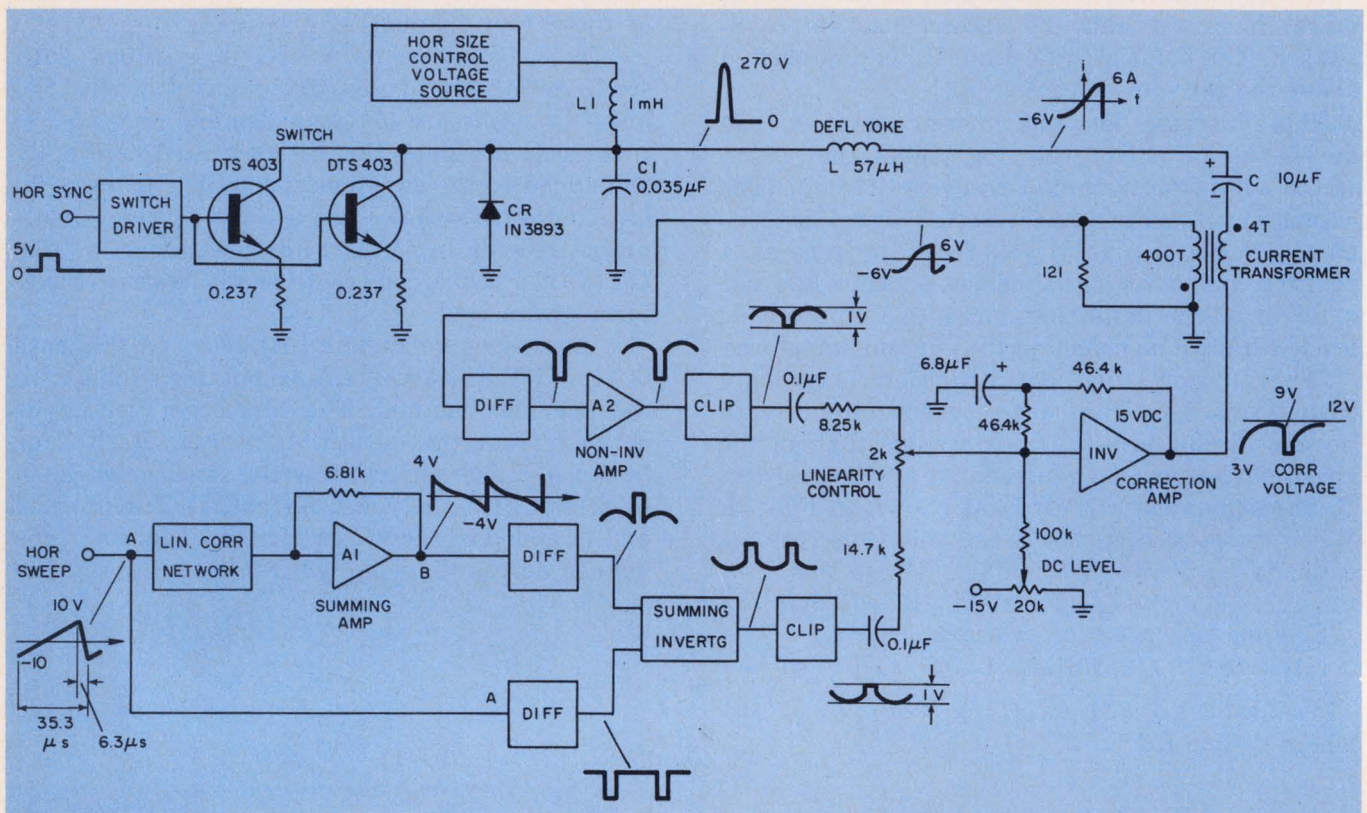

7. Linearities of up to 0.2% of the tube diameter are obtained for a 22-inch, flat-faced CRT with this circuit.

Without correction circuits, total linearity error (pin-cushion plus the sweep-circuit distortion) was 54%.

notation of Fig. 6a) by

$$v_L = i(R + k) + v_c. \quad (7)$$

Note that the final solution is the same as for the lossy circuit (Eq. 6) with  $R$  modified by  $k$ . If  $k$  is negative (positive-going voltage), the circuit losses are reduced and the deflection current waveform approaches the symmetrical, sinusoidal case. If  $k = R$ , the deflection current becomes a pure sine wave with its point of inflection in the middle of the sweep interval. This sine wave is in many cases a good approximation to the required S shape.

3. *First-order feedback with amplifier.* In this case the actual deflection current waveform is compared with a reference waveform, and the difference between the two is amplified and added to the deflection circuit (Fig. 6b). The reference waveform can be determined from the geometric properties of the CRT. In the case of a flat-faced CRT, for instance, Eq. 2 describes the required waveform. It should be pointed out here that this is not a true feedback system, since the correction signal is not required for the sweep generation; it only modifies its waveform.

Referring to Fig. 6b, we see that the reference signal and the feedback signal must have opposite phase at the summing point, S, of the inverting op amp. The reference input is larger than the feedback input. Since the correction sig-

nal must be positive-going, the reference input must be negative-going.

The drawback of this circuit is the time lag between the correction signal and coil current, because the latter is proportional to the integral of the applied voltage. Now assume that, because of a parameter change in the deflection circuit, a sudden slope change occurs. With plain current feedback, the correction voltage changes its slope. A slope change of the correction voltage, however, cannot correct for a slope change in current. Only a step function can do this, and it is not provided by this circuit. Thus this approach is useful for many applications but not for large deflection angles.

4. *Second-order feedback with amplifier.* In a second-order feedback system (Fig. 6c), a sample of the differentiated deflection current is compared with the differentiated reference input, and the difference between the two is amplified, inverted and applied to the sweep circuit. This provides time-lag-free correction with better accuracy than the other methods, and it is satisfactory for large displays with stringent linearity requirements (better than  $\pm 0.5\%$ ). The differentiators can be simple RC networks followed by a single-stage amplifier. The output of the current transformer is a voltage that is proportional to the deflection current. This voltage is then differ-

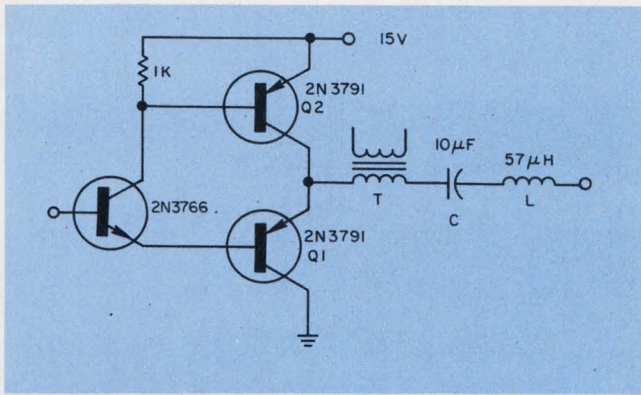

8. The correction-amplifier output stage must be able to handle full deflection current. This is achieved by letting each output transistor conduct during alternate halves of the sweep cycle.

entiated in  $D_2$ . Both the transformer and  $D_2$  can be replaced by a differentiating voltage transformer.

A complete and more detailed functional horizontal deflection circuit is shown in Fig. 7. The reference input at point A is a linear ramp. The linearity correction network is a function generator consisting of biased diodes and resistive voltage dividers. Its output current is converted into voltage by an op amp,  $A_1$ . After the signals are differentiated, they are added, clipped and applied to the comparator via the linearity control potentiometer.

The correction amplifier has low gain, and its output stage must be capable of absorbing the full deflection current (Fig. 8). During the first half of the sweep, when the yoke is the energy source, transistor  $Q_1$  conducts; during the second half, transistor  $Q_2$  conducts.

The circuit of Fig. 7 was used with a 22-inch, flat-faced CRT having  $\pm 35^\circ$  deflection angle. The horizontal-deflection yoke inductance is  $57 \mu\text{h}$ , and the deflection current is  $\pm 6 \text{ A}$ . Non-linearity due to the CRT geometry was originally 18% at the edge of the tube. The total sweep nonlinearity due to this pincushion error and sweep-waveform distortion was 54%. After application of the correction circuit in Fig. 7, the maximum on-axis deviation from linearity became less than 0.2% of the CRT diameter. The linearity was measured by comparing a digitally generated video grating pattern with an accurate overlay. The output swing of the correction amplifier is only 6 V peak to peak. ■■

#### Acknowledgement

The author wishes to thank J.W. Ensor for his contribution.

#### References:

1. Popodi, A. E., "Linearity Correction for Magnetically Deflected Cathode Ray Tubes," *EDN*, January, 1964.

Is your problem  
knowing what caused  
your problem  
after  
your problem occurred?

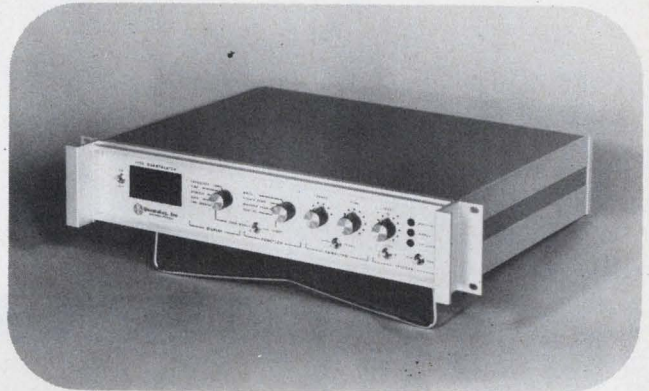

then you need the  
**QuantaLatch**

A major factor in pinpointing the causes of a problem is having an accurate record of signal history(s) readily available to determine specifically what did occur.

With the QuantaLatch you can continuously monitor an electrical signal, until a predetermined trigger freezes the signal history surrounding the trigger instant. With this memory capability, you can now analyze the data to determine causes of machine malfunction or failures, quality defects or any transient deviation from normal.

QuantaLatch memory data is presented on a simple front-panel LED, 3 digit display; as well as a single or repetitive scan analog signal for use by an ordinary oscilloscope or chart recorder; or in parallel or serial (ASCII) digital form for use with a tape punch or directly into a computer.

We'd like to tell the complete story about how our new QuantaLatch can save you time and money in problem solving. For your copy of our latest specification sheet, simply fill out the coupon below and drop it in the mail to us.



**QuantaLog, Inc.**

Box 1523, Ann Arbor, Michigan 48106

THE DATA TRANSFORMERS

Yes, I want more information about the QuantaLatch.

Name: \_\_\_\_\_

Company Name: \_\_\_\_\_

Street Address: \_\_\_\_\_

City: \_\_\_\_\_ State: \_\_\_\_\_ Zip: \_\_\_\_\_

Mail to: QuantaLog, Inc.

Dept. ED-2, Box 1523, Ann Arbor, Michigan 48106

Phone: (313) 769-4936

INFORMATION RETRIEVAL NUMBER 36

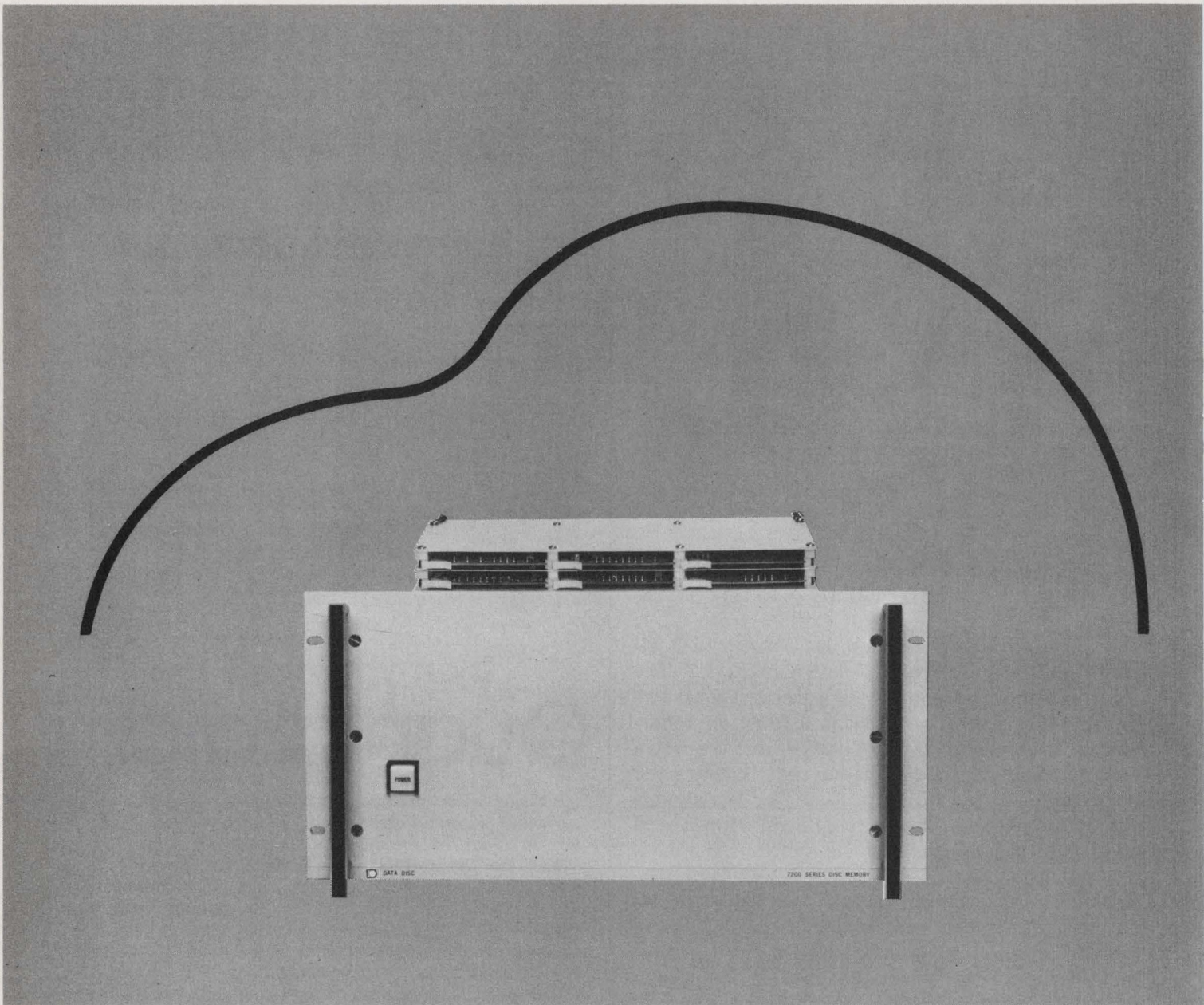

## We share a common philosophy with a certain imported car.

**What was wrong, we fixed —  
what was right, we kept.**

Experience taught us this. When you put a disc memory into your system, you want to be sure it is reliable.

But a disc memory with a low proven error rate cannot be designed overnight. It takes exhaustive testing in a variety of environments and applications; the design must be proven in field use.

It takes time, and Data Disc has been perfecting this disc memory for 7 years.

And like the Volkswagen people, we change something only when we

can improve performance, but we keep what has been proven. Our reliable read/write head design is basically the same as we patented years ago; we've only improved it.

Then, to be doubly sure that the memories we deliver are reliable, we put each unit through an extensive 7-day series of reliability tests; the Data Disc memory you put into your system is factory certified to have passed. Furthermore, it's backed by a 2-year warranty.

And we have a memory just right for your system—memories with capacities ranging from 32k to 4200k

words for DEC, for Interdata, for Data General, for HP, for Varian, and for most other minicomputers.

To find out more about the disc memories with the reliable philosophy, call your Data Disc representative or contact us at 686 West Maude Avenue, Sunnyvale, California 94086; (408) 732-7330. With our experience, we will deliver what you need—you can rely on that.





# If the world's fastest analog switch won't help you...

Our CAG14 FET analog gate switches up to 10-volt signals in 20 nanoseconds *maximum!* On-resistance is 50 ohms *maximum!* This ultra-high performance hybrid operates directly from TTL. It is used as a high speed sample-and-hold circuit or a general purpose analog gate.

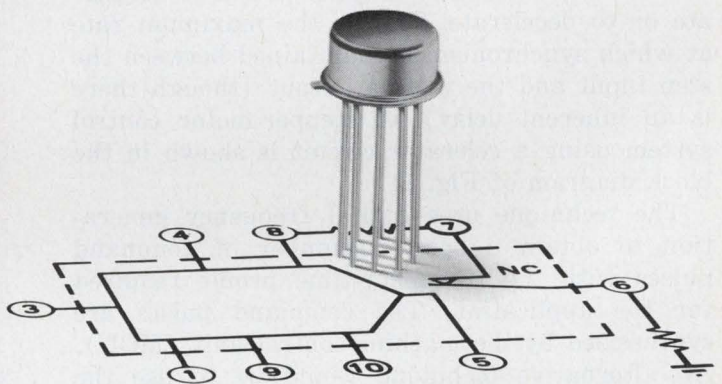

## ...Joel Cohen will.



Joel has many things going for him . . . and for you. He has more than 100 standard hybrid switch circuits which he can apply toward the solution of your problem. Joel can also meet your specialized needs through our custom hybrid facility. In either case, standard or custom, he will work closely with you on your design to give you best value. Joel and his associates have the world's most extensive applications experience in high accuracy analog switching. They assist many hundreds of analog switching customers each year. As a result, we have files bulging with circuit designs. Should one of these designs be pertinent to your needs, Joel can have a copy on its way to you within an hour. If necessary, we'll design a circuit for you. For your Hi-Rel requirements, you'll find no better supplier. We supply circuits and devices to MIL-STD 883, Level A for many military and NASA programs.

## Call (617)491-1670

 **TELEDYNE**  
**CRYSTALONICS**

147 Sherman St., Cambridge, Mass. 02140

INFORMATION RETRIEVAL NUMBER 38

# 'Celerate' the digital stepping motor

and overcome limitations of the maximum start/stop rate.  
You'll get maximum synchronous slew frequency.

The performance of stepper motors as digital motion transducers is limited by their maximum start/stop stepping rate. But the limits can be overcome by a "celerator" circuit.

The celerator (from "acceleration" and "deceleration") causes the stepper motor to accelerate or to decelerate. This is the maximum rate at which synchronism is maintained between the step input and the motion output (though there is an inherent delay). A stepper-motor control system using a celerator circuit is shown in the block diagram of Fig. 1.

The technique uses digital frequency generation to obtain a specific number of command pulses with the frequency-time profile required for the application. The command pulses are synthesized by the machine-control unit (MCU). An alternative technique would be to use the arithmetic approach of digital differential analysis (DDA). Frequency generation is preferred because it makes the internal data representation identical to the external representation. It is also remarkably easy to do.

## Use a digital rate multiplier

All machine-control units that generate frequencies digitally use a common logic element—the digital rate multiplier—at the heart of the design. The rate multiplier generates an output frequency that is the product of the input frequency and a digital fraction determined by the binary-coded multiplier. The rate multiplier converts a binary or BCD data-input word to a frequency representation.

Subfrequencies of the input frequency, generated by a counter, are selectively combined as controlled by the multiplier. The net effect is a periodic removal of pulses from the input stream. The period of any cycle is thus not constant. But the average of all cycle periods is.

If a more uniform output is desired (to approach spectral purity in the frequency domain), the output can be initially generated at a higher

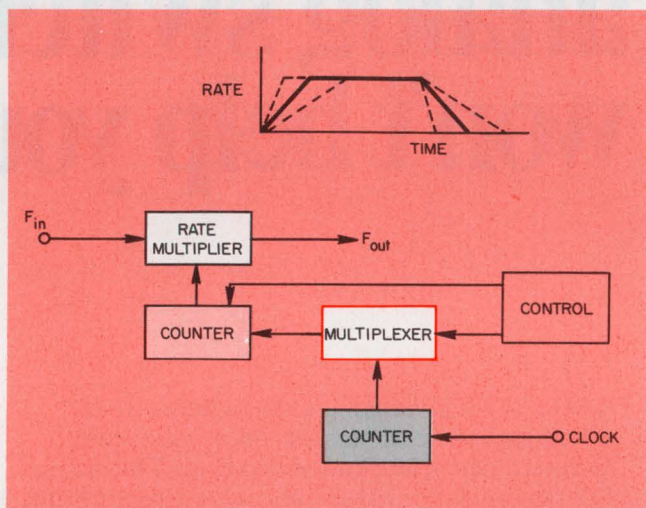

1. Linear celerator allows stepper motor to be accelerated or decelerated, thus providing higher average speeds without loss of accuracy. A rate multiplier is programmed to produce the required linear ramps in the output pulse rate.

frequency than desired and then divided down. The divider, or counter, then acts as a low-pass filter. The amount of remaining jitter, or side bands, is expressed by:

$$\frac{F_{IN}}{2N}, \quad (1)$$

where  $F_{IN}$  is the maximum stepping frequency, and  $N$  is the cycle set of the counter. Suitable digital rate multipliers are available as ICs. The one used in the circuit of Fig. 2 is the SN7497 binary rate multiplier.

## How the celerator circuit works

The celerator circuit is basically a rate multiplier controlled by an up-down counter. Additional rate multipliers in the celerator may be cascaded to provide greater output resolution.

If the binary inputs are labeled A through F, for the least to the most significant, the relationship of the output to input rates is given by the expression

$$F_{OUT} = F_{IN} \frac{2^5F + 2^4E + 2^3D + 2^2C + 2B + A}{64} \quad (2)$$

To illustrate how frequency generation is typically used, consider a situation where a digital

T. A. Seim, Computers and Control Section, Battelle, Pacific Northwest Laboratories, Battelle Blvd., Richland, Wash. 99352.

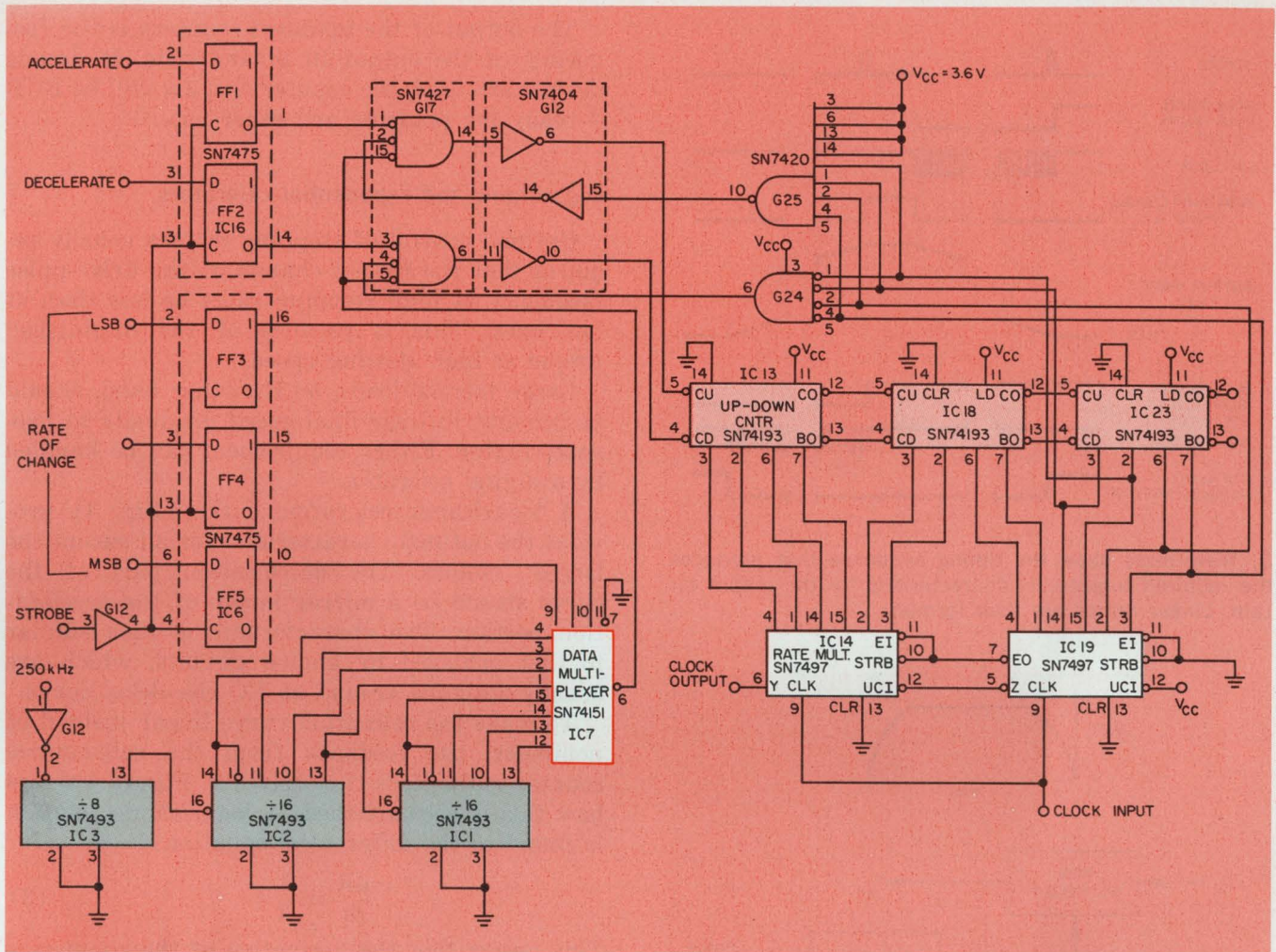

2. The complete linear celerator circuit uses two cascaded rate multipliers, IC<sub>14</sub>, and IC<sub>19</sub>, which are driven

by up-down counters IC<sub>13</sub>, IC<sub>18</sub>, and IC<sub>23</sub>. Counters IC<sub>1</sub>, IC<sub>2</sub> and IC<sub>3</sub> generate the different clock rates.

command causes a linear rise or fall in the output frequency at a rate that is also under digital command. Fig. 1 shows the logic needed to perform this function. Rate  $F_{IN}$  is the maximum stepping frequency, and  $F_{OUT}$  is the rate applied to the stepping motor translator.

Up-down counters IC<sub>13</sub>, IC<sub>18</sub> and IC<sub>23</sub> (Fig. 2) generate the linear ramp required to produce constant celeration, and this is then multiplied by the input rate. A second series of counters, IC<sub>1</sub>, IC<sub>2</sub> and IC<sub>3</sub>, together with multiplexer IC<sub>7</sub>, generates the different clock rates needed to select the ramp slope. Gates G<sub>12</sub>, G<sub>17</sub>, G<sub>24</sub> and G<sub>25</sub>, driven by the counters, inhibit the up-down clock, IC<sub>7</sub>, preventing the counter from overflowing or underflowing. Figure 3 shows the timing of the pulse trains and their effect on the output rate.

The multiplexer, IC<sub>7</sub>, selects the counting rate, which is directed through gating to either the up or down clock input of three cascaded SN74193 binary counters. Gating decodes the four most significant bits to halt celeration at the required limits, so that the ratio between the high and low limits is about 16 to 1. Note that the counting rate does not go to zero, but it

can be made to do so by further decoding. The lower limit can be set to any value, including zero, provided that it is algebraically less than the high limit. In the circuit of Fig. 2 the lower limit is not zero because only the four most significant bits are decoded. Thus the binary counters stop at binary 000011111111, which is convenient for an application in which the stepper motor continues moving regardless of the state of the celerator. If the application requires the stepper motor to stop when the celerator so dictates, the limit should be made zero.

Celeration is initiated by strobing the control register, which is composed of five D flip-flops, FF<sub>1</sub> to FF<sub>5</sub>. To select celeration direction, set either the accelerate (FF<sub>1</sub>) or decelerate (FF<sub>2</sub>) flip-flop. Also program rate-of-change, using the three other flip-flops (FF<sub>3</sub> to FF<sub>5</sub>). With 250-kHz as the clock rate, the time allowed for full-scale celeration varies from 0.25 to 33 s. Celeration occurs until either a limit is reached or the control flip-flops are reset. This allows the celeration to be halted at any point within its range (at any clock rate between maximum and minimum). This feature can conceivably be used in a feedback control-loop application.

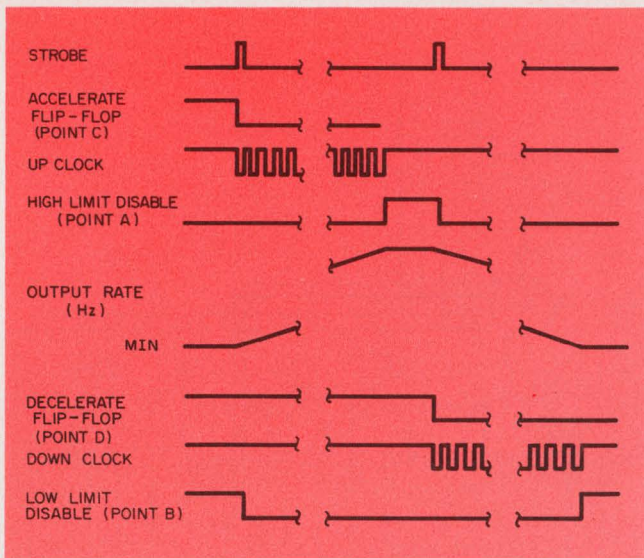

3. Waveforms show the timing sequence that produces the required trapezoidal characteristic for the output bit rate. Linear ramps are thus formed.

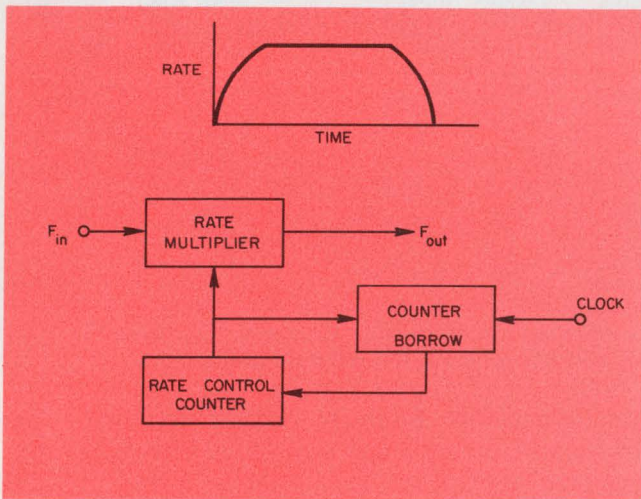

4. Logarithmic celerator is obtained by adding feedback from the rate control counter to the clock that drives it.

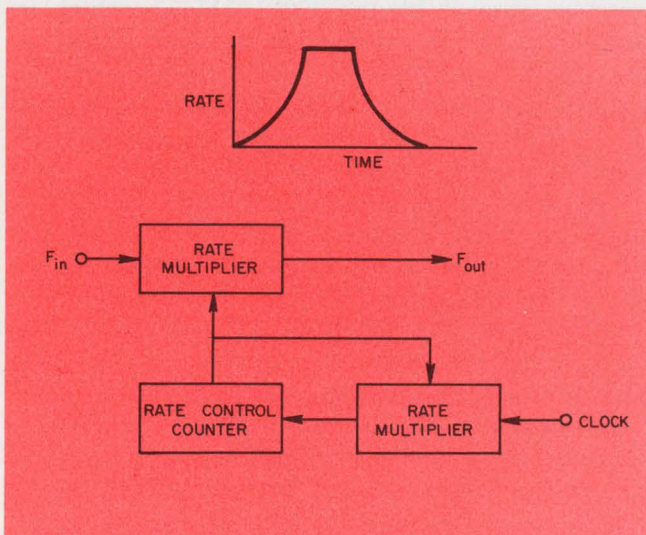

5. Exponential celerator uses feedback, as in the logarithmic case, but with the clock counter replaced by a rate multiplier.

The output of the up-down counters is the frequency of the output in binary code. If decade devices are used, the counter outputs will be BCD—ready for readouts and other uses.

### Logarithmic and exponential celerators

Optimal control of stepping motors usually requires that the rate-of-change of the drive-pulse frequency at high stepping rates be less than at low ones. This is because of the diminished torque at high slewing speeds.

Large inertial loads, on the other hand, should be brought to their final speed gradually to prevent ringing. Either requirement can be handled by a digital celerator.

A logarithmic celeration curve (Fig. 4) provides the optimal characteristic for all except the largest motors. The deceleration part of the curve should be a mirror image of the acceleration portion. The characteristic is thus similar to that achieved by analog circuits, which are usually designed around an RC rise-delay curve.

To make the celeration curve linear instead of nonlinear, use feedback from the rate-control counter to the clock that drives it. Figure 4 shows how this is accomplished. A logarithmic solution is found to the differential equation:

$$\frac{dR}{dt} = \frac{k}{R} \quad (3)$$

This means that the derivative of the count-rate function  $R$  is proportional to its inverse. So the clock rate applied to the counter must be multiplied by a factor inversely proportional to the counter's contents. This is easily handled by a presettable counter whose set inputs are the outputs of the rate-control counter.

A problem arises if you want the rate-control counter to go to zero where the logarithm is undefined. A simple solution is to add a small constant factor to the value of the rate-control counter, such as by connecting the least significant bit of the clock counter to a logic HIGH.

The same basic concept can be used for an exponential celerator with a characteristic (Fig. 5) suitable for driving large inertial loads without overshoot. For this circuit, we substitute a rate multiplier for the clock counter used in the logarithmic version. The mathematical relationship for this version of the circuit is the differential equation

$$\frac{dR}{dt} = kR \quad (4)$$

In this case, the derivative of the clock rate function is directly proportional to the function itself. The solution is an exponential function.

For applications requiring asymptotically converging rates, Fig. 6 shows how the output rate itself is used as feedback to the control counter.

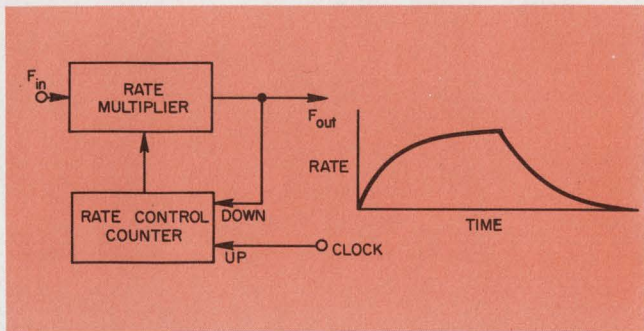

6. For an asymptotic celerator, the output rate itself is used as feedback to the rate-control counter.

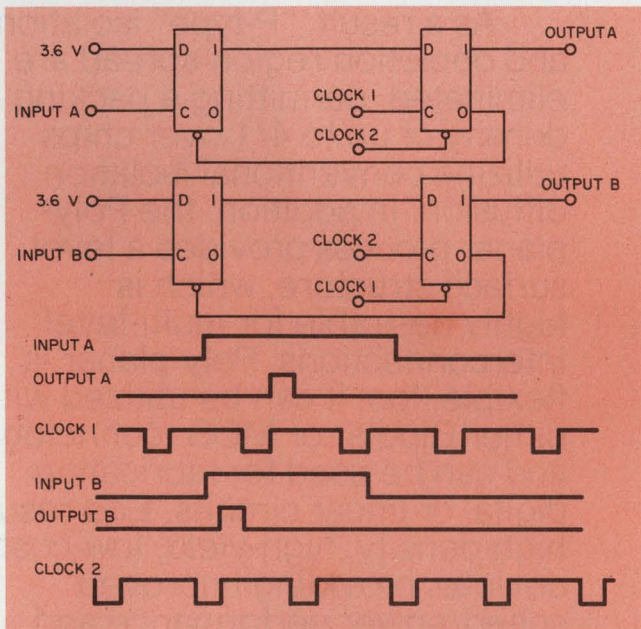

7. To insure anticoincident clocks, provided they are asynchronous, this flip-flop circuit works when the phases have noncoincident edges and a frequency at least twice that of the inputs.

The final stepping rate, including zero, is determined by the input clock. The input clock does not control the rate of change, as in the previous cases.

If the stepping rate of Fig. 6 is altered from a steady-state value, the higher rate predominates. This causes the counter to change the output rate so it converges on the control rate. But as the difference in rates becomes smaller, the net change of the counter slows.

The time constant of the asymptote depends on the maximum clock rates and the number of stages in the counter. The output rate can be converted to any constant multiple of the control rate by the insertion of rate multipliers in either or both feedback legs.

One constraint not obvious in the circuit of Fig. 6 is that the two clocks must be anticoincident—they cannot overlap. If the clocks are asynchronous, the circuit of Fig. 7 takes care of the problem. The only precautions are that the phases have noncoincident edges and be at least twice the frequency of the inputs. ■■

# OSCILLATORS

1 Hz to 250 MHz



**NEW**  
DUAL INLINE  
PACKAGE

RIGHT ON . . . . . Yes that's right . . . . . right on any frequency from 375 KHz to 30 MHz as specified with stability of  $\pm 0.002\%$  from  $0^{\circ}\text{C}$  to  $50^{\circ}\text{C}$ . DUAL-INLINE package gives standard logic outputs with a +5V DC input. Only DUAL-INLINE OSCILLATOR available with such a wide frequency range and tight stabilities in a package .495 x .800 x .590 high. Our Series 80 will offer you all these advantages.

INTERESTING? Call Dennis Griffin (312) 232-2600, and he will be glad to fill you in on all the details and send you our new catalog.

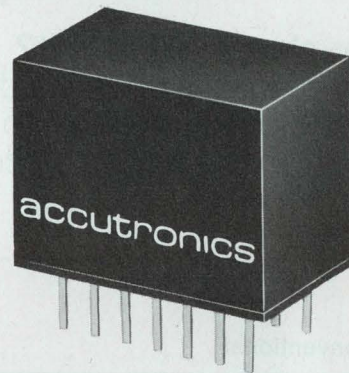

Series 80

FREQUENCY: 375 KHz to 30 MHz  
 FREQUENCY TOLERANCE:  $\pm 0.002\%$   
 TEMPERATURE RANGE:  $0^{\circ}\text{C}$  to  $50^{\circ}\text{C}$   
 SUPPLY VOLTAGE: +5V DC  $\pm 10\%$   
 OUTPUT VOLTAGE: Compatible with 10 TTL loads  
 RISE & FALL TIME: <50 ns  
 SIZE: 0.49W x 0.80L x 0.59H  
 SEE 1972-73 EEM Pg 1569

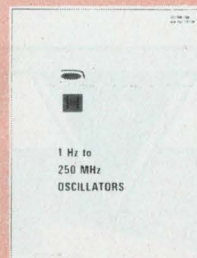

Please write or call for  
**NEW 1973 CATALOG**

Our new catalog covers various types of oscillators: VCXO, LCVCO, RCVCO, high stability, computer clocks, high output power, Navy standard hardware modules and low current drain oscillators from 1 Hz to 250 MHz. We'll even send you three neat conversion charts (3) to hang on your wall and impress your friends.

**accutronics**  
A HAMMOND CORPORATION COMPANY

628 NORTH STREET • GENEVA, ILLINOIS 60134

# Harris' New

**Our new Poly-planar™ technology did it. Produced the densest PROM on the market today, with twice the memory capacity of 1024's on the same size chip.**

## **Poly-planar. What is it?**

Poly-planar is a Harris developed technology designed to eliminate the area consumed by conventional isolation techniques by replacing

the P<sup>+</sup> diffusion with polycrystalline silicon.

As a result, "P-type" isolation and depletion region-spread are eliminated, permitting a packing density of up to 4/1 over chips utilizing conventional isolation diffusion. In addition, the Poly-planar process provides a level surface structure, which is highly desirable for multi-level interconnections. Poly-planar is flexible, too; it can be utilized with either Bipolar or MOS technology and can be used for fabricating digital or linear circuits. End result: high-density, high-yield, low-cost devices, providing improved speed/power performance and high reliability.

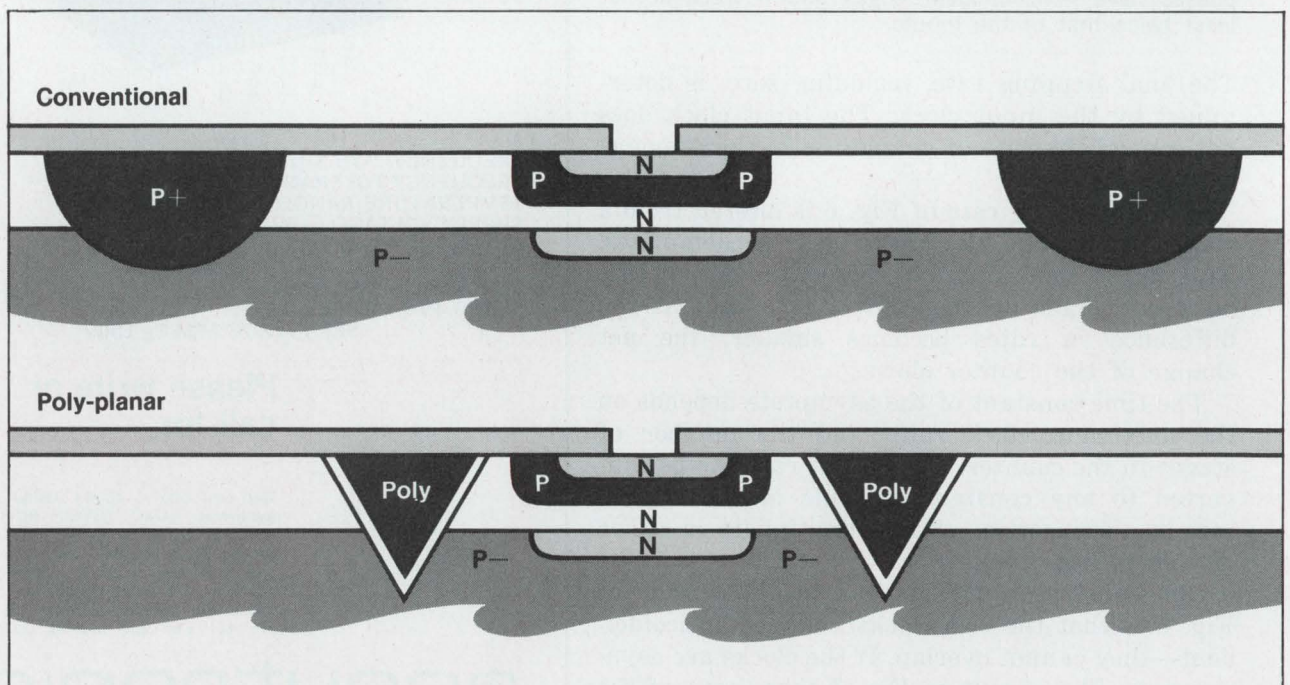

**Poly-planar makes it denser.** Compare the two diagrams shown here. The one at the top represents a cross-section of a chip fabricated through use of the conventional isolation diffusion process. The diagram above represents a chip manufactured with our Poly-planar process, demonstrating a packing density twice as great as in the conventional device.

# 2048 PROM:™

**HPROM-2048/2048A—512 words/ four bits per word. Easily interchangeable with all other 1024's.** We were first with the PROM concept, first to establish its reliability and first to deliver in volume. Now to all this experience, performance

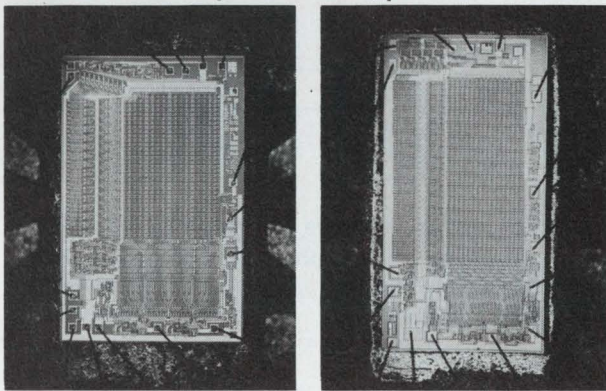

Twice the memory capacity at no increase in chip area. At left is a photo blow-up showing the circuit density of a typical Harris 1024 PROM. At right is our new HPR0M-2048, fabricated through use of our Poly-planar process, demonstrating isolation to isolation spacings half that of conventional devices and yielding a 4/1 improvement in density.

and dependability we've added the advantages of our new Poly-planar process to bring you this significant addition to the industry's most complete PROM line. PROM reliability has been documented by more than 232,000,000 fuseable link life test hours data. The HPR0M-2048 is available now for off-the-shelf delivery.

Because of its capacity (512 words/four bits per word) the HPR0M-2048 provided additional application possibilities for designing and producing economical

memories. By changing one address pin on any 1024 ROM socket, you can use the HPR0M-2048 to double your memory system capacity or reduce power dissipation by one half on your existing system. In addition the HPR0M-2048 is programmed in the same manner as the Harris 1024 PROM. Available with either 3-state (HPR0M-2048) or open collector (HPR0M-2048A) outputs. For details see your Harris representative or distributor.

## Features:

**512 words/4 bits per word**

**Fully decoded**

**DTL/TTL compatible**

**50ns typical access time**

**Power dissipation of 0.25 mW/bit**

**Expandable—"Wired-OR" outputs with chip select input**

**Available in military and commercial temperature ranges**

**HPROM-2048**

**HPROM-2048A**

**Bipolar**

**512 x 4**

100-999 units  
0°C to +75°C —55°C to +125°C  
**\$65.00 \$98.00**



**HARRIS**  
**SEMICONDUCTOR**  
A DIVISION OF HARRIS-INTERTYPE CORPORATION

P.O. Box 883, Melbourne, Florida 32901  
(305) 727-5430

**WHERE TO BUY THEM:** ARIZONA: Phoenix—Liberty, Weatherford; Scottsdale—HAR (602) 946-3556 CALIFORNIA: Anaheim—Weatherford; El Segundo—Liberty; Glendale—Weatherford; Long Beach—HAR (213) 426-7687; Mountain View—Elmar; Palo Alto—Weatherford, HAR (415) 321-2280; Pomona—Weatherford; San Diego—Weatherford, Western COLORADO: Denver—Elmar, Weatherford WASHINGTON, D.C.: HAR (202) 337-3170 FLORIDA: Hollywood—Schweber; Melbourne—HAR (305) 727-5430 GEORGIA: Atlanta—Schweber ILLINOIS: Chicago—Semi-Specs, Schweber; Palos Heights—HAR (312) 597-7510 INDIANA: Indianapolis—Semi-Specs MARYLAND: Rockville—Schweber MASSACHUSETTS: Lexington—R&D; Waltham—Schweber; Wellesley—HAR (617) 237-5430 MICHIGAN: Detroit—Semi-Specs MINNESOTA: Minneapolis—Semi-Specs MISSOURI: Kansas City—Semi-Specs; St. Louis—Semi-Specs NEW MEXICO: Albuquerque—Weatherford NEW YORK: Melville—HAR (516) 249-4500; Syracuse—HAR (315) 463-3373; Rochester—Schweber; Westbury—Schweber OHIO: Beachwood—Schweber; Dayton—Semi-Specs PENNSYLVANIA: Pittsburgh—Semi-Specs; Wayne—HAR (215) 687-6680 TEXAS: Dallas—Weatherford, Semi-Specs, HAR (214) 231-9031 WASHINGTON: Seattle—Liberty, Weatherford WISCONSIN: Wauwatosa—Semi-Specs.

**LEGEND FOR HARRIS SALES OFFICES & DISTRIBUTORS:** Harris Semiconductor (HAR); Elmar Electronics (Elmar); Harvey/R&D Electronics (R&D); Liberty Electronics (Liberty); Schweber Electronics (Schweber); Semiconductor Specialists, Inc. (Semi-Specs); R. V. Weatherford Co. (Weatherford); Western Radio (Western).

INFORMATION RETRIEVAL NUMBER 143

# Check before you freeze that design!

Here's a master checklist that just might ward off disaster some day. Use it while you work.

Critical examination of each design before release can minimize design and schedule slips.

Here is a master checklist that can save you time and money. Check your designs against it. Better yet, refer to the list during each phase of your design. One corrected item—an item that might have gone unnoticed without the checklist—can sometimes save a project from disaster.

No list like this can be all-inclusive. But it does present often-overlooked points of broad interest. You may wish to add your own entries based on your specialty.

---

James C. Breese, 1405 Amherst St., W. Los Angeles, Calif. 90025.

## Amplifiers

1. Are inputs and outputs physically and electrically separated as much as possible?

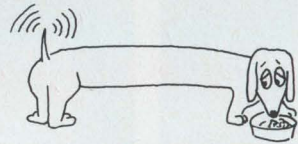

2. Are power sources decoupled close to high-gain, wide-bandwidth devices? Does each device have its own decoupling circuit?

## General

1. Have U.L. requirements been considered, and do the designs conform?
2. Have all of these factors been considered in the design:
  - Power consumption?
  - Weight?
  - Size?
  - Cost?
  - MTBF, MTTR?
3. Are there anticipated requirements or options that may be satisfied by minor changes easily incorporated now? For instance, components that might be needed later can be put on the PC art work now. The parts can be left out and mounted when needed.
4. Is the module easily tested? Has test equipment been designed? Have test personnel examined the design?
5. Are parts selected from the company's standard parts list where possible? Are parts available from second sources? Are the parts in this design in common use in other products of the company?
6. Has producibility been considered? Has production seen the design?
7. Has the module been "operator proofed" against the following:
  - Simultaneous and contradictory commands?
  - Damage from insertion or removal with power applied?
  - Backward power connections?Use your imagination here. The operator certainly will.
8. Are assemblies easily removed and replaced?
9. Does failure of a module cause "domino" failures elsewhere?
10. Can interlocks be defeated accidentally?

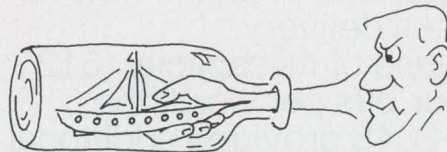



## Capacitors

1. Are surge currents within the rated limits of the capacitor? Can associated components safely handle the surge?
2. Are capacitors operated at less than half rated voltage for maximum MTBF?
3. Are electrolytics bypassed for high fre-

quencies with a small, solid-dielectric, noninductive capacitor?

4. Are large capacitors bypassed by bleed-resistors?
5. Are capacitors operated within their temperature limits?

3. Can linear amplifiers be driven into non-linear modes and do they automatically restore to linear operation?
4. Do nonlinearities generate sidebands that remain and appear as distorted data?
5. Have the effects of offset, bias voltages and currents to op amps been considered?
6. Is the slew rate adequate for high-frequency and fast-switching performance? Is the maximum output swing available at the highest signal frequency?

## Interfacing

1. Are standardized nomenclatures and pin assignments used?
2. Are decoupled power busses clearly identified and separated from the regulated but noisy power busses?
3. In the layout of the PC board have pins not assigned to standard and critical circuits been left unassigned to permit layout flexibility?
4. Can the interfacing cables be driven without degrading performance? Have sufficient steps been taken to protect against noise pickup on the cables?



## Cost

1. Is the circuit free of special parts (custom transformers, specially machined sinks, special specification op amps, selected resistors, etc.)?
2. Is the variety of parts at a minimum?
3. Is the module easy to assemble and test? Is it easy to repair?
4. Are low-cost parts used where possible?
5. Are ICs, LEDs, ROMs, and other parts with declining prices being used where possible?
6. Have expensive parts been submitted for competitive bidding?
7. Is hand-wiring eliminated where possible? Does the design use PC boards as male connectors, group I/O connections for flat cable wiring and wave soldering?

(Plastic power transistors can be mounted so that they overhang the PC card, thereby allowing transistors to be fastened to heat sinks with single screws.)

5. Are all loads compatible with their sources?
6. Will failure or the disconnecting of one or more power sources cause damage? If yes, what steps have been taken to prevent damage?
7. Is any special sequence required for removing or applying power?
8. Are interlocks provided to insure against improper power sequencing?
9. Can an open or shorted lead produce a harmful action? Is the circuit behavior fail-safe when an interface lead is opened or shorted?
10. Is circuit initialization—an automatic or manual reset or a warm-up time delay—required?
11. Have time race conditions been designed out of the circuits?

## Semiconductors

1. Have both voltage and current thyristor rate effects been considered in designing with thyristors?
2. Are transistors operated at less than 80%  $V_{ce}$  and  $V_{be}$ ? Are power limitations observed? Are capacitive and inductive loads properly treated?
3. Is the thermal impedance to the heat sink and to the ambient air low enough?
4. Are matched pairs used where needed? Are they adequately coupled thermally?
5. Are spare circuits identified on the schematic?
6. Have multitransistor arrays been considered to reduce cost or save PC space?
7. Are FET leads properly connected? (The gate is often not in the middle.)

## Inductors and transformers

1. Can the unit support the highest possible input voltage at the lowest possible frequency without saturation?
2. Is dc current carried by the unit? If yes, is the core large enough to withstand saturation and consequent reduction in inductance?
3. Is protection provided against voltage spikes from sudden field collapse? Does this protection prevent proper high-speed operation?
4. Have the effects of magnetic and thermal orientation of the unit within the assembly and in the next higher assemblies been considered?
5. Can worst-case core and copper losses be dissipated?
6. Are taps provided for required impedances or drive voltages?

## Resistors

1. For reliability, are all resistors operated at less than 75% of their rated power? Are they operated within their voltage rating?
2. Are noninductive resistors used in high-frequency and high-speed circuits?
3. Have the needs for precision, stability, linearity and noise-free performance of resistors been evaluated?

## Noise

1. Are critical component positions and sensitive cable routings securely fixed in place?
2. Is rf decoupling used in each module?
3. For low-level critical signals, are power driver and receiver circuits used with twisted, shielded-pair lines?
4. Are high-current, noise producing leads, such as those to motors and solenoids, isolated and shielded from signal circuitry?



5. Are the signals used for edge-triggering "clean" and free of multiple transitions?
6. Are filters used for both reducing line noise pickup and preventing noise broadcasting?
7. Are all wires large enough to carry worst-case loads?
8. For critical signals, has the common-mode-rejection method of reducing response to noise been considered and properly implemented? Are low-level leads as short as possible?
9. Are grounds returned to a single point? Are separate ground leads provided for low-level signals and kept separate from high-current and high-frequency ground leads?

## Testing

1. Are tests points provided so they are still accessible in the final assembly?
2. Can test points be shorted to ground without circuit damage?
3. Are test points labeled and conveniently placed for any corresponding adjustments?
4. Has a test specification and procedure been prepared?

## Adjustable components

1. Is the adjustment really necessary?
2. Are adjustments adequately labeled? Do clockwise adjustments produce an increase in the controlled quantity or move the operating point to the right in visual displays?
3. Is each adjustment independent of other adjustments? Are adjustments independent of power supply levels?
4. Is there sufficient range and resolution in the adjustment? Are the adjustment end stops strong enough to protect against overzealous turning?
5. Are adjustments still accessible when the module is mounted in the full assembly? Can the adjusted parameter be monitored from the module's final position?
6. Are factory-adjusted components sealed? Are they mounted so that tampering is discouraged?
7. Are variable resistors wired with the wiper connected to one end, thus preventing a completely open circuit should the wiper contact fail?

## PC cards and packaging

1. Are PC cards keyed and does the keying prevent reversed insertion?
2. Are power and ground busses labeled on the art work? Are diode directions shown? Are capacitor polarities marked?
3. Are pin-number labels provided for connectors, ICs and transistor sockets?
4. Are standardized pins used for power and ground? Are alternate pins left blank where possible to minimize accidental shorts while troubleshooting?
5. Are the adjustable components labeled?
6. Are sockets used for fuses and lamps?
7. Are low-level signal runs as short as possible? Are high-current conductor widths on PC boards wide enough?
8. Are hot components raised above the card, for cooling and card protection?
9. In difficult or dangerous environments, has hermetic sealing been considered for the package design?
10. Are metal-cased parts protected so they don't cause accidental shorts?
11. Is some room allowed for future growth?
12. Does the module carry its part number and name in a visible area?

## Relays

1. Has the relay driver been protected against voltage spikes? Does the protection increase dropout time too much?
2. Have operate, release and bounce times been considered?
3. Is arc suppression necessary. If yes, has it been tested for effectiveness?
4. Are contacts designed for the nominal load only? In "dry" circuits, are the proper contacts used? Have solid-state relays been considered?
5. Has circuit and contact timing been studied to eliminate sneak paths and momentary bridging of contacts?
6. Has the duty-cycle of the relay coil been considered?

## Temperature

1. Is sufficient cooling airflow provided? Is cooling still present with the drawers pulled out? Can airflow be impeded by operator negligence, such as stowing manuals on the cabinet top? (A good rule of thumb is:  $\text{Temperature Rise } (^{\circ}\text{C}) = \frac{1.7 \times \text{Power Dissipated (Watts)}}{\text{Airflow Rate (CFM)}}$ )
2. Has the performance of the cooling system been checked?



3. Are personnel protected from contact with hot parts?
4. Are heat-sensitive parts (transistors, capacitors) protected and kept away from heat sources?
5. Are PC cards and other materials that easily discolor protected from contact with hot parts?
6. Are components still properly cooled when installed in the final assembly?
7. Has power dissipation been checked under worst-case conditions? (For instance, check zener regulator circuits with the load removed.)

# Schmitt, the name that made the trigger famous, now makes HiNIL universal.

Schmitt is Teledyne's new HiNIL 367, noise-proof line receiver. It's the new way to go for a universal input-port to logic blocks. In industrial applications, for example, most inputs are either a switch or a relay closure. They usually cause contact bounce. But the most amazing thing about the 367 is that it has a truth table that simply eliminates contact bounce by definition.

And by the way, the noise immunity of the 367 is more than enough to handle any long lines between the logic and input. It has a 5.0 volt worst-case noise immunity and an additional 2.5 volt dead-zone Schmitt Trigger margin.

Because the 367 is a Schmitt Trigger, it holds that 2.5 volt noise immunity *even* during logic transition. Slow-down

capacitors, as you all know, do not provide true noise immunity during switching. But, with the 367 in there, you can use those slow-down capacitors at the rate of 4msec/uFd *and* achieve a high guaranteed noise immunity too.

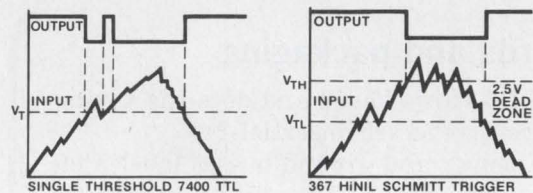

For fussy people, we put an inhibit pin on the 367 that allows information to be accepted only at times of low noise.

The new Quad Schmitt 367 is available now at \$2.98 in 100 up quantities. Order now or get in line.

## the challenger

# TELEDYNE SEMICONDUCTOR

1300 Terra Bella Avenue Mountain View, California 94040 (415) 968-9241 TWX: 910-379-6494 Telex: 34-8416

INFORMATION RETRIEVAL NUMBER 42

# The Sperry eye test for display equipment buyers

# ESP



The above is a printed interpretation of the appearance of the more popular displays. You are encouraged to make the same comparison with actual devices.

The old saying "what you see is what you get" certainly applies to the purchase of equipment incorporating displays — panel meters, DVM's, multimeters, counters, instruments, calculators and other equipment. If you can't clearly and easily read the information being displayed then you're not getting full product value. And, you're obviously not getting equipment supplied with advanced Sperry planar displays†.

How do you tell if they're Sperry displays? Simply take the Sperry eye test.

1. Do the displays appear as uniformly bright, continuous characters with no irritating gaps or filaments and screens to reduce readability?  
 YES  NO
2. Do the displays remain bright and clearly legible with no glare or appreciable fading even under direct sunlight conditions?  
 YES  NO
3. Can you quickly, easily and accurately read the displays from 20 to 40 feet away?  
 YES  NO
4. When the unit is positioned within a 130° viewing angle, can you still clearly read the displayed characters?  
 YES  NO

If you answered YES to all four questions, you already have your eyes on equipment featuring preferred Sperry displays.

If you answered NO to any of the questions, you owe it to yourself to take a comparison look at products equipped with superior Sperry displays.

#### FREE BUYER'S GUIDE —

To help you make the right equipment selection, Sperry offers the handy "Buyer's Guide for Equipment featuring Electronic Displays". It's yours for the asking. Order your copy today by checking the reader service card or phone or write: Sperry Information Displays Division, P.O. Box 3579, Scottsdale, Arizona 85257, telephone (602) 947-8371.

## SPERRY

### INFORMATION DISPLAYS

For the name of your nearest Sperry Representative or Distributor  
D.I.A.L. EEM  
(800) 645-9200 toll free



Sperry 1/3"



Sperry 1/2"

units are available for use with red filters

## It's a whole new ball game in displays!

SPERRY RAND

†Patents Pending  
\*NIXIE is the registered trademark of The Burroughs Corporation.

INFORMATION RETRIEVAL NUMBER 236

## Integrate-and-hold circuit gives electrochemical measurements

Operational-amplifier integration techniques can provide input-signal and time ranges comparable with those obtained from electrochemical cells. A FET peak-holding circuit holds the largest voltage reached by the integrator's output. More important, the value is held for a period up to three times longer than could be expected for the integrator capacitor alone.

With switch  $S_1$  in the Integrate position (Fig. 1), the integrated signal from  $A_1$  is fed to the peak-holding circuit comprised of amplifier  $A_2$ , low-leakage capacitor  $C_2$ , diode  $CR_1$  and FET  $Q_1$ .

The high input impedance of FET  $Q_1$  and the use of a voltage-follower circuit provide isolation between the integrator and output meter, thus minimizing leakage from the integrating capacitor,  $C_1$ .

The meter reads directly in coulombs when  $S_2$

is set in the X1 position and when the input scale factor is 1 V/A. Switch  $S_2$  should be set to the X3 position to avoid off-scale meter readings, if the unit is to be unattended during an integration cycle.

The Reset position of  $S_1$  clears  $C_1$  and  $C_2$ . When the measurement is completed,  $S_1$  is switched to the Hold position. This disconnects the input signal from the integrator and prevents a loss of charge from capacitor  $C_1$ .

The coulombmeter shown has a range of 0 to 128 coulombs, with the upper limit resulting when one or more internal amplifiers reach saturation. The peak-holding circuit will limit the output droop to about 0.7 coulomb/min., for an indication of 120 coulombs on the meter.

Robert G. Warsinski, Ford Motor Co., 24500 Glendale, Detroit, Mich. 48239. CIRCLE NO. 311

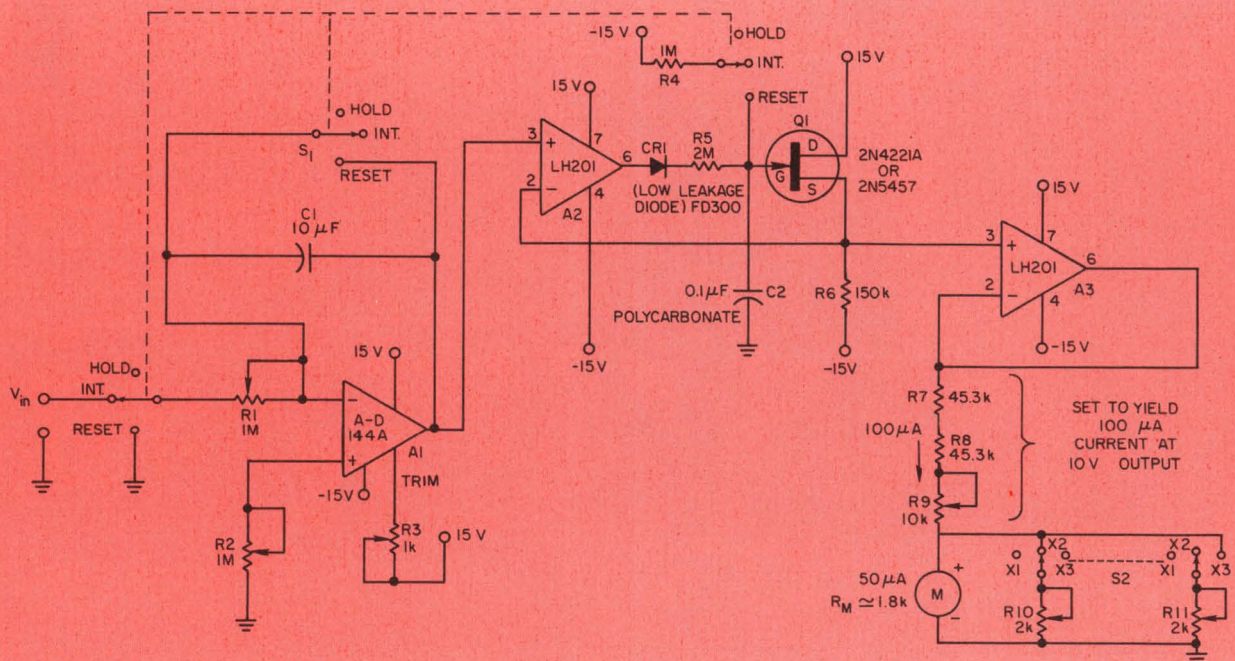

The peak value of the integral of the input voltage is read out directly on the microammeter, M,

which is calibrated to read in coulombs for an input scale factor of 1 V/A.

# THE BEST WAY TO SWITCH HIGH POWER LOADS FOR PRECISELY TIMED INTERVALS.

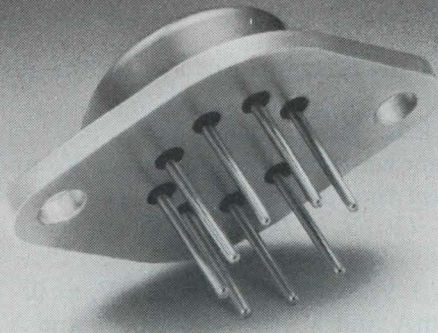

## □-LINE ONESHOT POWER PULSERS

The Unitorde Power Pulsers is a hybrid circuit available in two series optimized for switching loads up to 500 watts (60V) for 0.5 to 50ms. Output pulse width tolerance is within 1% of the internally preset time with a temperature coefficient of  $-0.04\%/^{\circ}\text{C}$  from  $0^{\circ}\text{C}$  to  $125^{\circ}\text{C}$ . It is a complete, ready-to-use thick film circuit in a compact TO-3 package.

### VOLTAGE SWITCH—PIC400

Upon actuation by an input pulse from an IC logic gate, the output of the PIC400 will switch the supply voltage across the load independent of the shape or duration of the input. No external components are necessary. The load may be placed in either the collector or emitter of the darlington output and may be driven from either a positive or negative supply. A wide variety of options are available, including 1800W switching capability (15A, 120V), extended pulse width range (from a fraction of a millisecond to several seconds), and controlled rise and fall rates. The two applications listed below illustrate the versatility of the PIC400.

### TYPICAL PIC400 SERIES APPLICATIONS

1. Driving electro-mechanical counter from 24V AC.

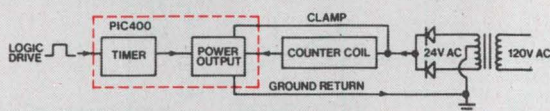

2. Solenoid actuation from negative power supply.

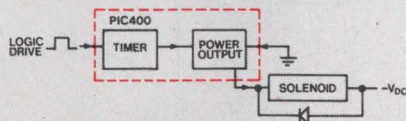

### REGULATED CURRENT SWITCH—PIC410

The PIC410 is a more sophisticated version of the PIC400. The output pulse is current regulated to within 1% of an externally preset value by means of a switching regulator in the output circuitry. This insures substantially lower internal power losses and higher efficiency than could be obtained with a series

regulator. A rapid turn-off circuit insures the fastest possible current decay upon termination of the output pulse. The range of options available for the PIC410 are the same as for the PIC400. Two typical applications follow.

### TYPICAL PIC410 SERIES APPLICATIONS

1. Constant current switching of high speed print-hammer from unregulated supply.

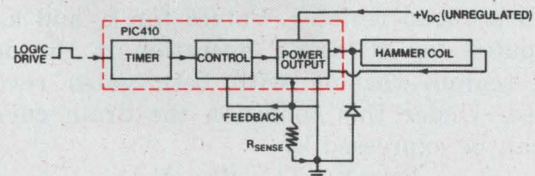

2. Driving high-speed stepper motor (with 5A constant current pulse) from 48V AC.

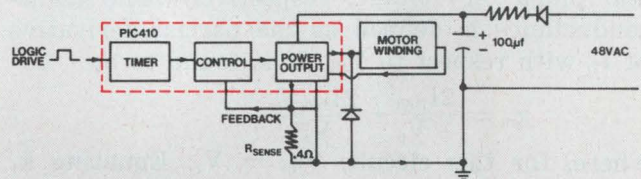

For more specific information call Vinnie Savoie—collect—at (617) 926-0404, or return the coupon to Unitorde Corporation, 580 Pleasant St., Watertown, Mass. 02172.

### Unitorde Corporation

Dept. 1 X, 580 Pleasant St., Watertown, Mass. 02172

PLEASE SEND INFORMATION ON:

- PIC400    PIC410  
 Application Note    Power Darlington

My application is: \_\_\_\_\_

Name: \_\_\_\_\_

Title: \_\_\_\_\_

Address: \_\_\_\_\_

City: \_\_\_\_\_ State: \_\_\_\_\_ Zip: \_\_\_\_\_

Telephone: \_\_\_\_\_

See EEM Section 4800 And EBG Semiconductors Section for more complete product listing.



**UNITRODE** quality takes the worry out of paying less.

# Analog multiplication or amplitude modulation are provided by a single MOSFET

A single n-channel, dual-gate MOSFET can be made to perform analog multiplication if one of the gates is used to vary the device's transconductance and the other is used for signal input. The resulting drain-current variation can be expressed as the sum of two terms—one proportional to the signal and control voltage. Removal of the signal term by subtraction of a portion of the input signal leaves just the product term.

As shown in Fig. 1, the input signal,  $V_s$ , is fed to gate  $G_1$ , while the control signal,  $V_c$ , goes to gate  $G_2$ . If  $V_c \gg V_s$ , then the drain voltage can be expressed by

$$V_o = -(k_1 + k_2 V_c) R_1 V_s.$$

The expression in the parenthesis is the small-signal MOSFET transconductance,  $g_m$ , and  $R_1$  is the drain-load resistor. Values for  $k_1$  and  $k_2$  are computed for MOSFET operation in the depletion region—that is with both gates reverse-biased. Under this condition the drain current,  $I_D$ , can be expressed by

$$I_D = I_{DSS} (1 - V_{GS}/V_p)^2.$$

$I_{DSS}$  and  $V_p$  are the short-circuit drain current and pinch off voltage, respectively. The transconductance is defined as the partial derivative of  $I_D$  with respect to  $V_{GS}$ . It is found to be

$$g_m = \frac{2I_{DSS}}{-V_p} + \frac{2I_{DSS}V_c}{V_p^2}$$

where, for this circuit,  $V_{GS} = V_c$ . Equating  $k_1$  and  $k_2$  with the previous equation, we find that

$$k_1 = \frac{2I_{DSS}}{-V_p}$$

$$k_2 = \frac{2I_{DSS}}{V_p^2}$$

Multiplication of the terms in Eq. 1 gives the output voltages as

$$V_o = -(k_1 R_1) V_s - (k_2 R_1) V_c V_s.$$

In the circuit shown, amplifier  $A_1$  sums  $V_o$  and  $V_s$  so as to cancel the first term and leave

$$V_{out} = -(R_f/R_{s1}) (k_2 R_1) V_c V_s,$$

provided that

$$-(R_f/R_{s2}) V_s + (R_f/R_{s1}) (k_1 R_1) V_s = 0.$$

With  $I_{DSS} = 4$  mA and  $V_p = -1.5$  V,  $V_s$  and  $V_c$  are restricted to voltage swings of 0.3 V and 1 V, respectively, to avoid saturation or pinch-off. For these operating conditions,  $k_1 = 5.32$  mA/V and  $k_2 = 3.56$  mA/V<sup>2</sup>. Since  $R_f = R_{s1}$ , and  $R_{s2}$  is adjusted to cancel the  $V_s$  term,  $V_{out} = 8.9 V_c V_s$ .

In practice, the highest operating frequency is restricted to 100 kHz by the low-frequency response of the op amp. If required, amplitude modulation can be obtained by omitting  $R_{s2}$ . However, without filtering, the modulation depth is limited to 60%. Above this  $V_c$  and  $V_s$  are of the same order of magnitude, causing the transconductance to be a function of both signals with consequent generation of spurious harmonics.

*Dr. W. V. Subbaro, Assistant Professor, North Dakota State University, College of Engineering and Architecture, Fargo, N.D. 58102.*

CIRCLE NO. 312

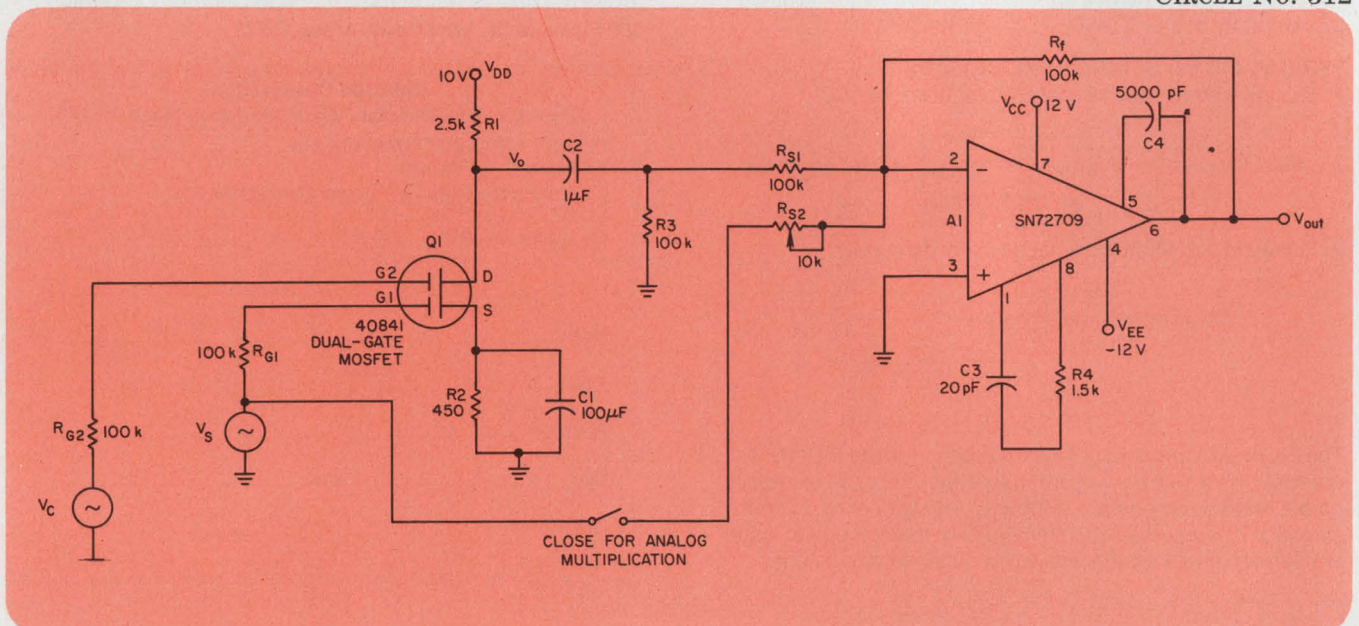

The drain circuit of MOSFET  $Q_1$  contains the product of signal voltage  $V_s$  and control voltage  $V_c$ .

The first-order term in  $V_s$  is nulled by  $R_{s2}$ , leaving only the product term at the output.



# GI is capacitors

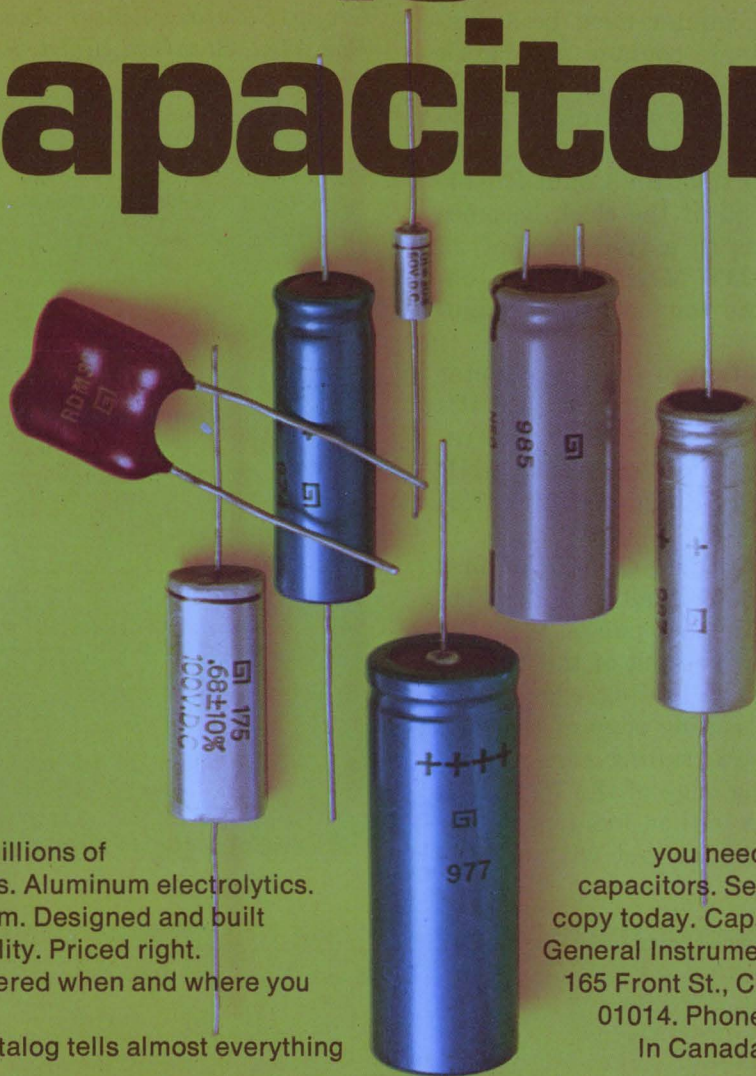

Literally billions of capacitors. Aluminum electrolytics. Micas. Film. Designed and built for reliability. Priced right. And delivered when and where you want 'em. The GI catalog tells almost everything

you need to know about capacitors. Send for your free copy today. Capacitor Division/General Instrument Corporation, 165 Front St., Chicopee, Mass., 01014. Phone 413/592-7795. In Canada 416/763-4133.



**General  
Instrument**  
the capacitor company

"Off the shelf" delivery from your **GI/M** distributor.

INFORMATION RETRIEVAL NUMBER 45

# Increase bandwidth of cascaded synchronous counters to 35 MHz

With the addition of a Schottky TTL flip-flop and a three-input AND gate to a Signetics 8284 synchronous counter, it's possible to cascade up to 12 such counters and achieve frequencies of up to 35 MHz. The technique (Fig. 1) overcomes the usual delay that occurs with two or more cascaded 8284s. The delay occurs primarily at the Carry-Out output of the first stage in the conventional synchronous configuration.

To increase the bandwidth, the Carry-Out (CO) output of the first counter must be anticipated. Even though a single counter may work at over 40 MHz, its CO output—used to enable the following stages—has a typical delay of 30 ns from the clock pulse. After this delay is added to the typical 15-ns setup time for Count-Enable (CE), the minimum period of the clock becomes 45 ns—which corresponds to a frequency of 22 MHz. (A frequency of 23.6 MHz has been obtained in practice with the conventional configuration.)

To anticipate the CO output of the first counter stage, the circuit uses two Schottky clamped ICs having a typical total propagation delay of 5 ns. The first Schottky circuit is a three-input AND gate,  $G_1$ , and the second a JK flip-flop,  $FF_1$ . The typical setup time is 3 ns.

When outputs  $Q_2$ ,  $Q_3$  and  $Q_4$  of the first counter stage coincide, the J input of  $FF_1$  is enabled for the 15th and 16th clock pulses. With the K input of  $FF_1$  at  $V_{cc}$ , the Q output of the flip-flop will be a positive pulse. The leading edge of the pulse coincides with the trailing edge of the 15th clock pulse, and the pulse's trailing edge is synchronized with the trailing edge of the 16th clock pulse. The flip-flop output is then identical to the CO output of the first counter, but with a delay

relative to the clock pulse of 5 ns instead of 30 ns.

The timing diagram of Fig. 2 is for a 25-MHz clock. During the 30-ns delay of CO from the 15th clock pulse, the Q output of  $FF_1$  provides a setup time of 35 ns. This is considerably longer than the typical setup time of 15 ns that is typically required. The setup time allows the circuit of Fig. 1, with the Q output of  $FF_1$  as the CO, to achieve frequencies of up to 35.3 MHz.

*Boris Bertolucci, Electronics Instrumentation Group, Stanford Linear Accelerator Center, P.O. Box 4349, Stanford, Calif. 94305.*

CIRCLE NO. 313

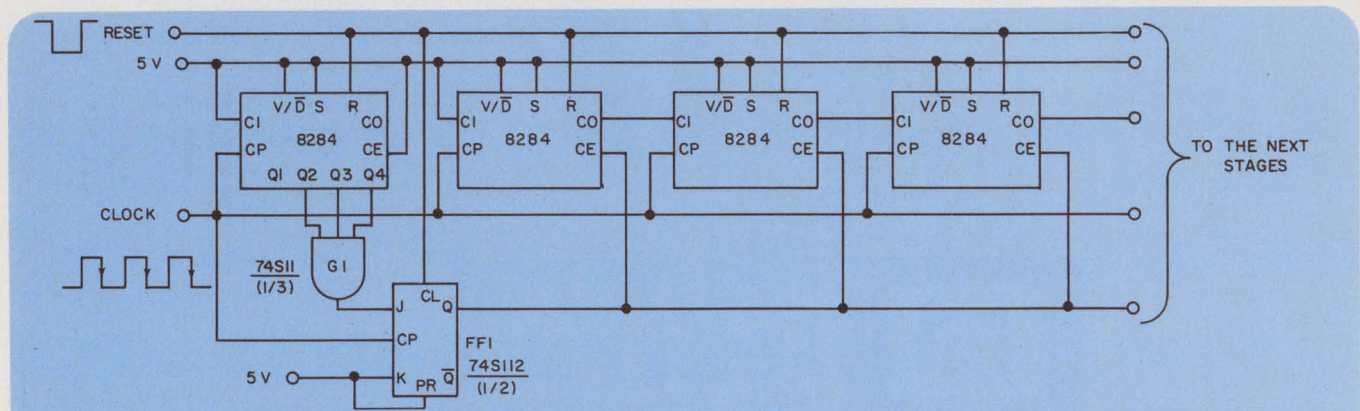
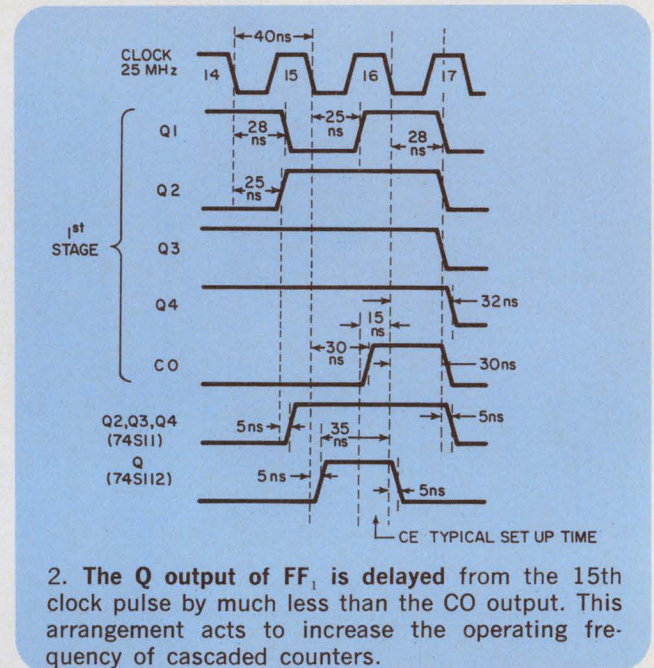

1. Schottky flip-flop  $FF_1$  and AND gate  $G_1$  increase the maximum frequency of cascaded 8284 count-

ers by lowering the delay of the Carry-Out output of the first stage from the clock.

# VACTEC PHOTOCELLS

## boiled to perfection

Heat, water, steam, or a combination of all three, can't penetrate Vactec's positive hermetic seals. Even the passivated plastic types are exceptionally stable. Vactec Photocells not only endure boiling water temperatures (100° C), but also other environmental extremes down to liquid nitrogen cold (-196° C).

Long term moisture like 500 to 5000 hours in a humidity chamber can be even more destructive than boiling. If you put Vactec to this test, be sure to include some competitive cells for comparison.

You simply can't buy a better photocell *anywhere*, and Vactec is competitive with import prices because of automated processing, assembling, and testing. Take advantage of Vactec engineering, research, and manufacturing in the heart of America. Because Vactec has 249 different types of cells in stock, we can ship before your order reaches an overseas supplier. Included is a complete line of visible detectors; photoconductors (CdS and CdSe); photovoltaic cells (Se and Si); couplers of LED's or lamps and photoconductors called Vactrols. Vactec also has a photometer which measures from .0002 to 10,000 fc, for as little as \$300.00.



### VACTEC, INC.

2423 Northline Industrial Blvd.  
Maryland Heights, Mo. 63043  
Phone (314) 872-8300

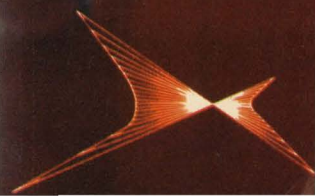

# Retriggerable one-shot prevents false triggering of PLL tone detector

By adding a retriggerable one-shot multivibrator and a transistor to a phase-locked-loop tone detector, you can prevent false triggering by radio noise.

The circuit of Fig. 1 discriminates between noise and the input tone by measuring the interval of time that the tone is present at the input of the detector. Since in-band frequency components of radio noise are shorter than the duration of a tone command signal, the circuit can be made insensitive to triggering by radio noise.

The 5-V logic level at the tone-detector output, point A, keeps transistor  $Q_1$  in saturation. But when a tone is detected, point A switches to ground potential, thereby triggering one-shot  $MM_1$ . The triggering of  $MM_1$  raises the one-shot output, point B, from ground to 5 V. The 5-V level at point B keeps transistor  $Q_1$  saturated until the one-shot times out. Point B then returns

to ground potential.

If the tone is still present after point B returns to ground—as occurs for a valid signal—both points A and B will be at ground potential. Transistor  $Q_1$  is thus cut off, providing a logic ONE at the output.

If the tone is no longer present—as when the detector is triggered by noise—point A will be at 5 V and point B at ground. Transistor  $Q_1$  stays saturated, and the output remains at ZERO.

Resistor  $R_1$  and capacitor  $C_1$  control the timing (Fig. 2) of  $MM_1$ . The  $R_1C_1$  time constant should be chosen to be about five times longer than the longest noise component expected on the particular transmission channel. About 100 ms is adequate in the hf spectrum.

*Edward I. Levy, Dade Div., American Hospital Supply, P.O. Box 672, Miami, Fla. 33152.*

CIRCLE NO. 314

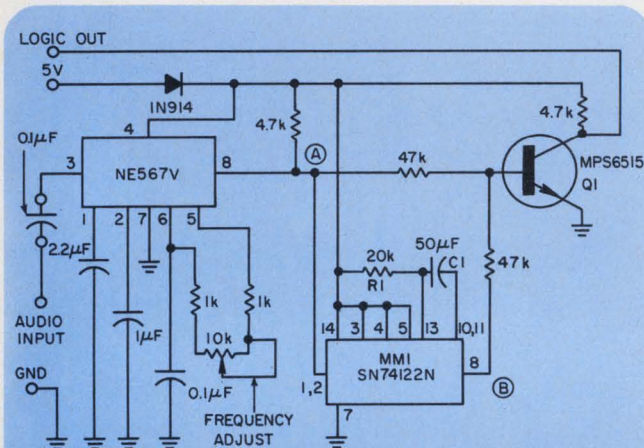

1. One-shot  $MM_1$  and transistor  $Q_1$  prevent radio noise from falsely triggering the NE 657V tone detector.

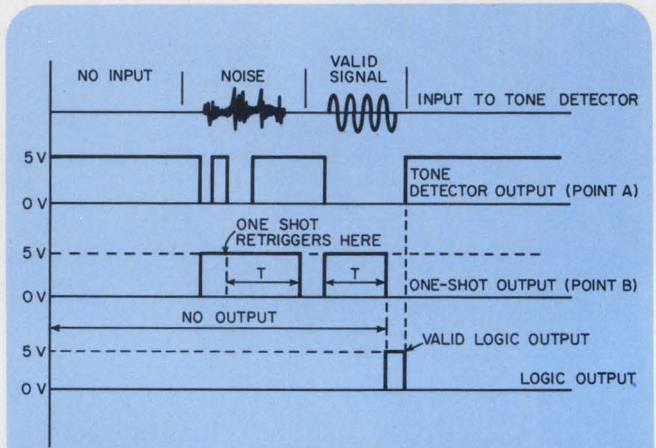

2. False triggering of the tone detector or one-shot does not produce a logic output, as indicated by the three output waveforms.

## IFD Winner of September 2, 1972

**Peter Himmelheber**, Senior Project Engineer and **Stanley Thomas**, Project Engineer, Naval Electronic Systems Test and Evaluation Facility, St. Inigoes, Md. 20684. Their idea, "Digital sweep generator maintains constant output voltage at specified time" has been voted the Most Valuable of Issue Award.

Vote for the Best Idea in this issue by circling the number for your selection on the Information Retrieval Card at the back of this issue.

**SEND US YOUR IDEAS FOR DESIGN.** You may win a grand total of \$1050 (cash)! Here's how. Submit your IFD describing a new or important circuit or design technique, the clever use of new component or test equipment, packaging tips, cost-saving ideas to our Ideas for Design editor. Ideas can only be considered for publication if they are submitted exclusively to ELECTRONIC DESIGN. You will receive \$20 for each published idea, \$30 more if it is voted best of issue by our readers. The best-of-issue winners become eligible for the Idea of the Year award of \$1000.

ELECTRONIC DESIGN cannot assume responsibility for circuits shown nor represent freedom from patent infringement.

To celebrate our 50th Anniversary—1923-1973



See this beauty at the Struthers-Dunn exhibit during the 1973 Design Engineering Show, Philadelphia, Pa. April 9, 10, 11, 12.

## This 1923 Model T FORD as GRAND PRIZE for your most unusual relay application!

**Second 50th Anniversary prize: TEN \$50.00 U.S. Savings Bonds.**  
**Third Prize: FIVE \$50.00 U.S. Savings Bonds.**

ALL entrants will receive a 9" x 12" four-color print of this photograph by contest end. Perfect for framing.

Yes! A beautifully restored Model T Ford Station Wagon from the same year the first Struthers-Dunn relays came out! It could be yours for telling us about your most unusual or interesting relay application, as detailed in the rules below. You and the car will be the talk of your town from the day it is delivered. Start writing or thinking about your application today! Note those second and third prizes, too! *Be sure to follow the rules below.*

### CONTEST RULES

- (1) Entrants must give a clear and complete description of an unusual, but practical and operating, relay application or solution of a relay problem, using electromechanical or reed relays of any make or price. *Entries must contain nonconfidential matter only.* No purchase necessary.
- (2) Winning entries will be judged on basis of the most unusual applications and/or imaginative thinking of widest interest to relay specifiers.
- (3) The three judges, familiar with design and use of relays, will be from the editorial departments of technical trade publications, and their decision will be final.
- (4) Brevity, clarity and completeness will count. Be formal or informal. Schematics welcome.
- (5) No limit on entries, but keep each entry to one application.
- (6) Entries must be postmarked no later than midnight May 15, 1973. Address: 50th Anniversary Contest, Suite 1500, 1201

Chestnut Street, Philadelphia, Pa. 19107. Do not send entries to Struthers-Dunn or its distributors.

- (7) For anonymity in judging, entries will be coded and identification removed insofar as possible.
- (8) Winning entrants will be notified by July 1, 1973 and publicly announced and identified shortly thereafter.
- (9) Grand prize will be delivered to winner's home.
- (10) All entries become property of Struthers-Dunn, Inc. and none will be returned. Struthers-Dunn reserves the right to use all entries in its advertising and promotion on an anonymous basis, but entrants will be paid \$50.00 for each entry used.
- (11) Contest void where prohibited, regulated or limited by law. Winners will be responsible for taxes, if any, on prizes.
- (12) Employees of Struthers-Dunn, Inc., its sales affiliates, distributors, advertising agencies, contest judges and members of their families are not eligible.



## STRUTHERS-DUNN, INC.

PITMAN, NEW JERSEY 08071

Canada: Struthers-Dunn Relay Div., Renfrew Electric Co., Ltd.

INFORMATION RETRIEVAL NUMBER 47

# “Scotchflex” Flat Cable Connector System makes 50 connections at a time.



“SCOTCHFLEX” IS A REGISTERED TRADEMARK OF 3M CO.

Build assembly cost savings into your electronics package with “Scotchflex” flat cable and connectors. These fast, simple systems make simultaneous multiple connections in seconds without stripping or soldering. Equipment investment is minimal; there’s no need for special training. The inexpensive assembly press, shown above, crimps connections tightly, operates easily and assures error free wiring.

Reliability is built in, too, with “Scotchflex” interconnects. Inside of connector bodies, unique U-contacts strip through flat cable insulation, grip each conductor for dependable gas-tight connections.

“Scotchflex” offers you design freedom, with a wide choice of cable and connectors. From off-the-shelf stock you can choose: 14 to 50-conductor cables. Connectors to interface with standard DIP sockets, wrap posts on standard grid patterns, printed circuit boards. Headers for de-pluggable connection between cable jumpers and PCB. Custom assemblies are also available on request.

For more information, write Dept. EAH-1, 3M Center, St. Paul, Minn. 55101.



**“Scotchflex”.**  
**Your systems approach  
to circuitry.**

# new products

## Flexible power switch/amp IC delivers 10 W of peak power

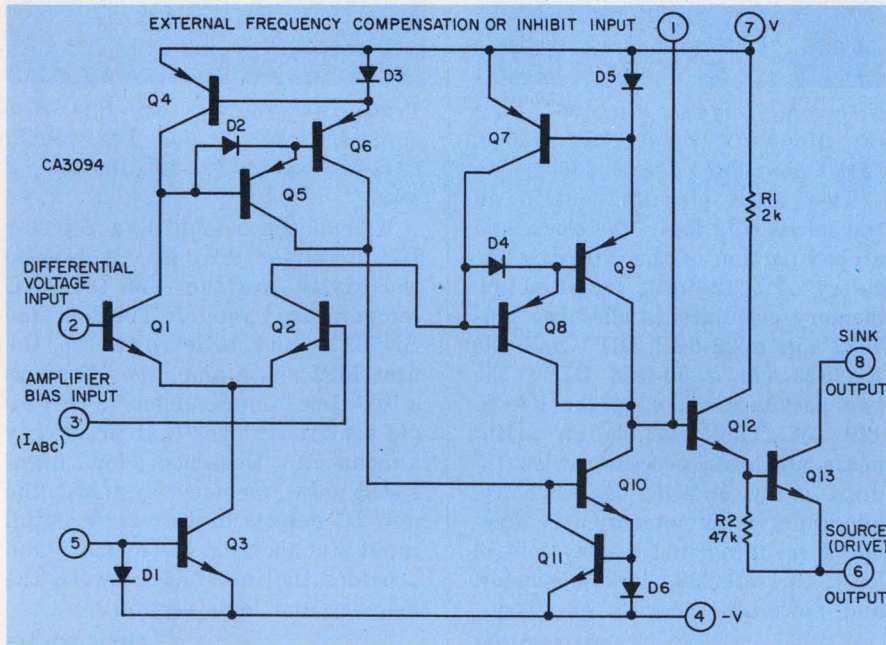

RCA Solid State Div., Route 202, Somerville, N.J. 08876. (201) 722-3200. P&A: See below.

Consisting of a high-gain differential-input preamplifier driving an output power amplifier, RCA's monolithic CA3094 offers design flexibility for control and general-purpose applications. It can be used as an op amp or a power switch, delivering up to 3 W of average power or 10 W of peak power to an external load. And the device may be operated from either a single or dual power supply. Strobing, gating and squelching, as well as agc, are all programmable.

In single-ended class-A amplifier applications, the CA3094 can deliver 0.6-W output, with 1.6 W dissipation in the device. Total harmonic distortion at 0.6 W in class-A operation is typically 1.4%.

The new IC has the generic characteristics of RCA's popular CA3080 op amp directly coupled to an integral Darlington power transistor that is capable of sinking or driving currents of 100 mA average or 300 mA peak. This sig-

nal level is said to be sufficient to drive directly high-current thyristors, relays, dc loads or power transistors.

The gain of the differential input stage is proportional to the amplifier bias current,  $I_{ABC}$ , permitting programmable variation of the IC sensitivity with either digital or analog signals. With an  $I_{ABC}$  of 100  $\mu A$ , for example, a 1-mV change at the input changes the output from 0 to 100 mA (typical).

Despite its high power ratings, the CA3094 can be programmed to idle at microwatt power levels. And because input impedance can also be programmed, the IC can be used in timers to give delays in excess of four hours.

Versions of the CA3094 come in the eight-lead TO-5 package and differ only in supply-voltage ratings. The models available are rated at 24 V (suffix T), 36 V (suffix AT) and 44 V (suffix BT).

A major use of the CA3094T is expected in automotive equipment and other applications where operation up to 24 V is a primary de-

sign requirement.

The CA3094 may also be obtained with formed leads corresponding to the eight-lead DIP or Mini-Dip. These models are designated with suffixes S, AS and BS, corresponding to the CA3094T, CA3094AT and CA3094BT, respectively.

Pricing for 100 to 999 quantities is 75¢ (suffixes T and S), \$1.19 (suffix AT and AS) and \$1.67 (suffixes BT and BS).

For more information

CIRCLE NO. 251

## Driver-receiver good for twisted pair line

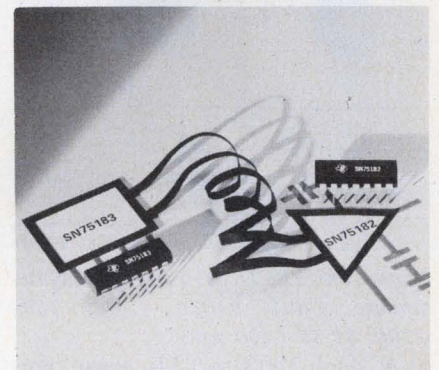

Texas Instruments Inc., P.O. Box 5012, M/S 308, Dallas, Tex. 75222. (214) 238-3741. SN75182N: \$3.14; SN75183N: \$3.48 (100 up); stock.

A line driver and receiver combination can be used in digital systems connected by twisted pair lines. The dual differential line receiver—the SN55/75182—replaces the DM7820A/DM8820A while the dual differential line-driver—the SN55/75183—replaces the DM7830/DM8830. The 182 receiver has two independent units. The input stage rejects large common mode signals while responding to small differential signals.

CIRCLE NO. 252

## 4k RAM emerges from Coplomar process

Standard Microsystems Corp., 35 Marcus Blvd., Hauppauge, N.Y. 11787. (516) 231-5151.

A 4096-bit electrically alterable RAM with decoding and sensing contained on a single monolithic silicon structure offers twice the speed of standard RAMs, according to the manufacturer. Called the SMC N-4412, the memory uses the company's Coplamos process. With a silicon die that's comparable in size to current 1024-bit configurations, the new memory has an access time of less than 180 ns. Production pricing is expected to eventually reach 0.25¢/bit.

CIRCLE NO. 253

## Dual amp senses low-level MOS signals

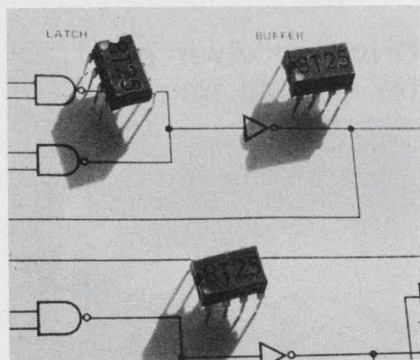

Signetics, 811 E. Arques Ave., Sunnyvale, Calif. 94086. (408) 739-7700. \$2.85 (100 up).

A dual MOS-to-TTL sense amplifier, for MOS RAMs—the 8T25—performs the same functions as two 75107 line receivers and either one-half of an 8275 quad bi-stable latch or a third of an Intel 3403 hex latch, according to Signetics. Thus one tiny eight-pin IC replaces two 16-pin packages and more. Another feature of the device is that it's bus-ORable—the tri-state outputs permit interface from the MOS memory directly onto a bus. Data inputs are current-sensitive, with a threshold of 300 mA. In the HIGH level, the voltage of the driving source must be greater than 1.6 V.

INQUIRE DIRECT

## Calculator system on two ICs

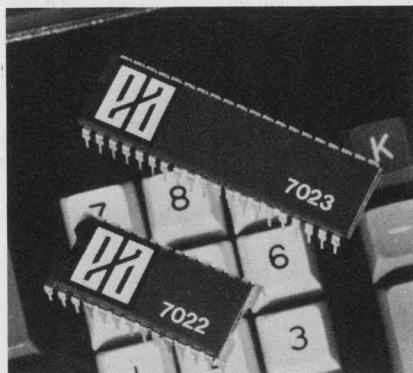

Electronic Arrays, Inc., 501 Ellis St., Mountain View, Calif. 94040. (415) 964-4321. \$32.50 (100).

Two MOS circuits contain all the calculating logic, the clock, and a good portion of the interface circuitry of a 12-digit, four-function memory calculator. Called the EA-7022 (in a 28-lead DIP) and the EA-7023 (in a 40-lead DIP), the two packages make up the EA S-129 set. They include an arithmetic/algebraic processor with 12-digit entry and display capacity, an accumulator memory, the keyboard scanning and display control logic, an internal clock generator, and power-on clearing circuitry.

CIRCLE NO. 254

## M119 dual comparator series offered

National Semiconductor Corp., 2900 Semiconductor Dr., Santa Clara, Calif. 95051. (408) 732-5000. LM-119: \$13.95; LM219: \$8.50; LM-319: \$3.95 (100 up); stock.

The LM119 series precision dual comparator is designed for operation with a single 5-V power supply to  $\pm 15$ -V supplies. It has improved specs over older comparators, according to the manufacturer. Special features include bias current of 500 nA, response time of less than 100 ns and gain of 40,000. Both the inputs and outputs of the LM119 can be isolated from system ground and as much as 25 mA output current is available from each comparator. With large overdrive, the response time of the LM119 is substantially less than 100 ns.

INQUIRE DIRECT

## Sense amp/data register has $\pm 2$ -mV sensitivity

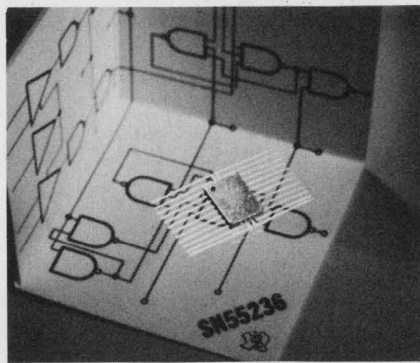

Texas Instruments Inc., P.O. Box 5012, M/S 308, Dallas, Tex. 75222. (214) 238-3741. \$23.17 (100 up); 8 wks.

A dual sense amp/data register IC features  $\pm 2$  mV threshold sensitivity over the  $-55$  to  $125$  C temperature range. Termed the SN55236 and believed to be the first MSI sense amp, the IC offers a two-times improvement in threshold sensitivity over that previously announced. Designed for high-speed core memory systems, the new IC detects bipolar differential input signals from the memory and provides the interface between the memory and logic section.

CIRCLE NO. 255

## Fast rectifiers go to 20 A, 600 V

RCA Solid State Div., Route 202, Somerville, N.J. 08876. (201) 722-3200. TA8411, TA8411R: \$1.49; TA8415; TA8415R: \$2.00; TA-8419, TA8419R, \$2.80 (1000 up); stock.

Twelve 100 to 600-V fast-recovery silicon rectifiers, available in forward and reverse-polarity versions, have current ratings of 6, 12 and 20 A. Series TA8411 through TA8414 are 6-A, forward-polarity types (cathode connected to stud), while Series TA8415 through TA-8418 are rated at 12 A. The Series TA8419 through TA8422 covers 20-A applications. Repetitive peak reverse voltage ratings are 100 V for TA8411, 15 and 19; 200 V for TA-8412, 16 and 20; 300 V for TA-8413, 17 and 21; and 600 V for TA8414, 18 and 22. All twelve devices have reverse-polarity versions (like numbered with suffix R) that are anode connected to stud.

CIRCLE NO. 256



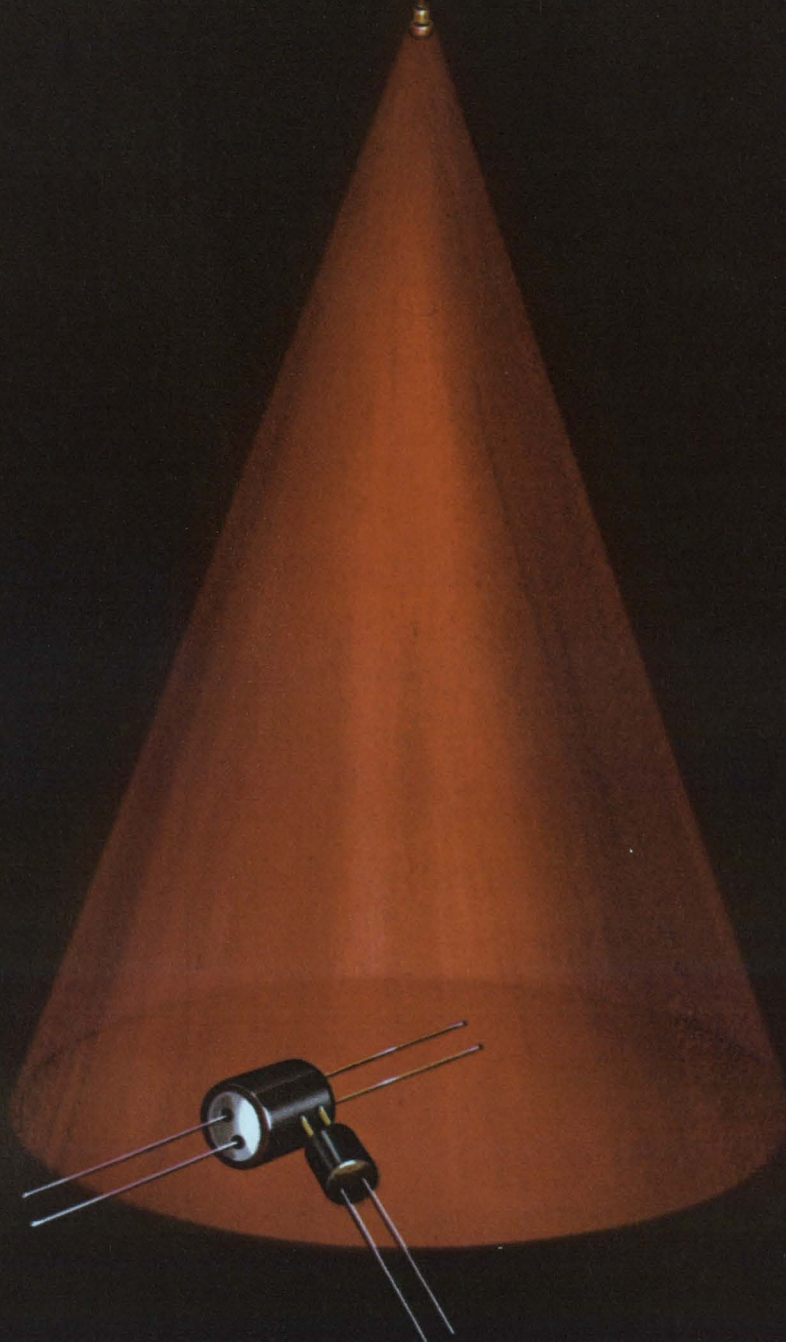

## Two New Opto-Isolators Featuring LEDs with CdS Cells...

Offering high reliability at low cost, PHOTO-MOD<sup>®</sup> opto-isolators, series CLM-6000 and CLM-8000, are now available for immediate delivery from Clairex. Using solid-state lamps and Clairex photoconductive cells, reliability and ruggedness are inherent in the design.

CLM-6000 is a miniature, low power, low resistance, isolator offering noiseless switching and

complete isolation for TTL to TTL interfaces.

CLM-8000 provides a hermetically sealed CdS cell and an LED. Operates on line voltage to drive SCRs and Triacs from TTL outputs.

For complete data or special assistance with your isolation problems, call (914) 664-6602 or write Clairex<sup>®</sup>, 560 South Third Avenue, Mount Vernon, New York 10550.

**CLAIREX ELECTRONICS**  
A DIVISION OF CLAIREX CORPORATION

Reliability. Our patented Grand Prix sleeve bearing design is rated at 12 years operating life (at 54°C). It's cool running and quiet. A unique capillary seal eliminates lubricant seepage. Rugged all-metal construction won't warp, resists breakage and acts as an effective heatsink.

Cooling power. PeWee delivers more air at higher back pressures — 22 cfm at .10 inches of water, 30.5 at .06 inches, 36 cfm in free air.

Whatever the equipment — rack panel, tape deck, power supply, counter, or memory stack, where space is at a premium and cooling critical, PeWee Boxer performs.

Other airmovers? Of course! Send for our full-line catalog No. ND4r. It's free, and contains performance data, electrical and mechanical specifications on more than 100 units. Valuable application information too.

For immediate service, contact us at **IMC Magnetics Corp., New Hampshire Division**, Route 16B, Rochester, N.H. 03867, tel. 603-332-5300. Or the IMC stocking distributor in your area. There are more than 50 nationwide and overseas. **IMC. We're reliable.**

**The Tiny Giant. It's 3 1/8 inches square by 1.655 inches slim. The only fan its size delivering 36 cfm. IMC's PeWee Boxer.**



INFORMATION RETRIEVAL NUMBER 50

## ICs & SEMICONDUCTORS

### 4-quadrant multipliers boast 0.5% accuracies

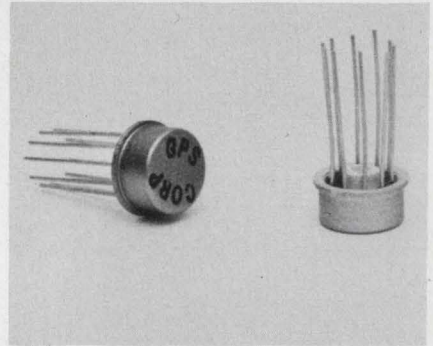

GPS Corp., 14 Burr St., Framingham, Mass. 01701. (617) 875-0607. Stock.

The 4100 Series four-quadrant multipliers are tiny hybrids that have accuracies of up to 0.5%. Other features of the line include a full power response of 800 kHz, bandwidth of 1 MHz and slew rate of 45 V/μs. Wide bandwidth operation, wide temperature range and the increased versatility of the 4100 Series make it ideal for all multiplier applications in control and instrumentation systems, according to GPS Corp.

CIRCLE NO. 257

### 'Calculator-on-a-chip' line expands to 9 ICs

Texas Instruments Inc., P.O. Box 5012, M/S 308, Dallas, Tex. 75222. (214) 238-3741. 8-digit chips: \$38.15; 10-digit chips: \$41.97 (100 up); stock.

The TMS0100 family of "calculator-on-a-chip" MOS/LSI ICs has been expanded to nine standard off-the-shelf circuits. The TMS0101 and TMS0103 are preferred eight-digit circuits, while the TMS0106 and TMS0118 are preferred ten-digit versions. The TMS0101 has floating or fixed-point result, chain operation, constant operation and protection of result in overflow; it uses algebraic keyboard entry. The TMS0103 provides four operations, floating or fixed decimal point and constant or chain operation; it's ideal for desk-top machines. The TMS0106 and TMS0118 feature a three-position selectable round-off.

CIRCLE NO. 258

INFORMATION RETRIEVAL NUMBER 51 ►

# Bright Tape Decks

...for those who expect to get more when they pay more.



**B**right tape decks cost more than other tape decks. They cost more because more goes into them—more quality in the materials, more care in design and manufacturing.

But this quality and care wouldn't be worth the extra you pay for it unless it meant greater reliability and freedom from the problems you accept as routine with other tape decks.

Bright quality pays for itself.

Bright tape decks have a rigid cast front panel. A front panel that can't come out of alignment so the tape always runs true, and tedious adjustments are unnecessary. Also, by conservative design, all electronic adjustments have been eliminated. The only maintenance is a simple bit of clean-up; there's virtually no downtime.

Even a seemingly insignificant part like a constant tension spring on the buffer arm received our attention. Because of this spring, you

can be sure that your tape will run at a constant speed and stack on the reel uniformly; when the tape is uniform on the reel, it won't stretch in storage.

And to insure uniform data density and perfect IBM compatibility, the timing, spacing, and tape speed are tied directly to the capstan encoder.

Available in either 8½ inch or 10½ inch models, you can buy Bright tape decks configured to suit your needs. Construction is completely modular with small, functionally organized circuit boards. You can order anything from the bare necessities to fully buffered electronics and interfaces for your application.

It's true that Bright tape decks cost more (about 10%), but you get what you pay for—a tape deck that is truly impressive in your system.

For more information write to Bright Industries, Inc. 686 West Maude Avenue, Sunnyvale, California 94086, (408) 735-9868.

**Bright**

INDUSTRIES INC.

A Subsidiary of Data Disc, Inc.

# When you've got a load to move,

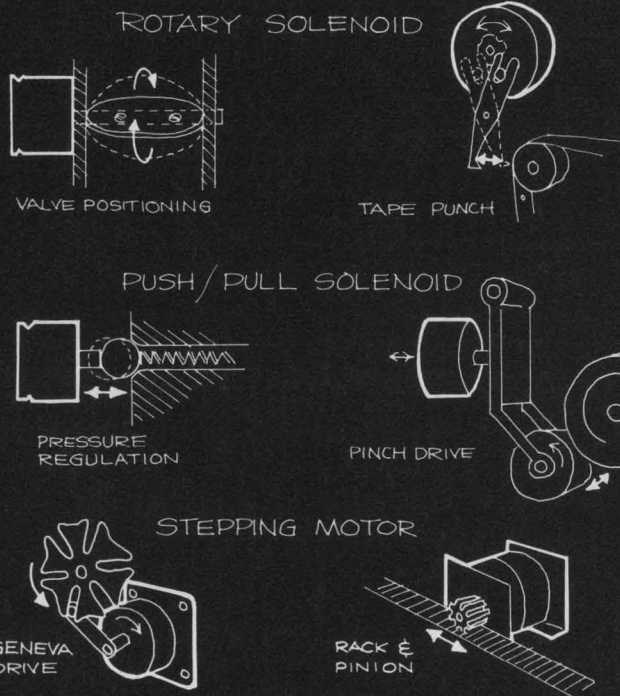

## or circuits to switch . . .

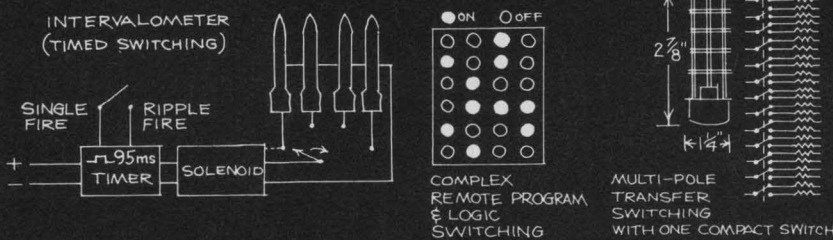

**Ledex Rotary Solenoids** give you fast, direct rotary motion. There's a family of eight sizes with torque all the way up to 117 pound inches. For linear loads, our **Push/Pull Solenoids** respond in less than 10 ms. Both have a compact form factor and there are over 350 stock models to get your prototype off the board and into the shop fast.

**Ledex Stepping Motors** position loads remotely in predetermined increments over 360°, cw, ccw, or both. You can add a knob for manual positioning. Attach a load on either or both ends. And our newest 12-position model has built-in pulsing circuitry, so it self-steps; needs no logic circuitry.

You'll find versatile **Ledex Switches** everywhere . . . in aircraft controls, laboratory instruments, business machines,

even amusement games. They take up very little space to control, transfer, program and check out complex circuits.

For a neat **Packaged Control Solution** to your most complex switch problems, we'll deliver the answer in a small black box, ready to plug in. Chances are, the Ledex combination of people and products have solved an actuating or switching problem much like yours already. Just send us an outline of your problem. Or ask for:

**Catalog A-9500**  
Over 400 ways to turn . . . push . . . pull . . . step . . . and switch plus new micro-electronic interface circuits.

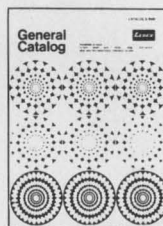

**LEDEX** the total technology people

**LEDEX INC.**  
123 Webster Street  
Dayton, Ohio 45401  
(513) 224-9891

POSITIONING · SWITCHING · MICROELECTRONICS  
INFORMATION RETRIEVAL NUMBER 52

## ICs & SEMICONDUCTORS

### Line receiver IC meets standard specs

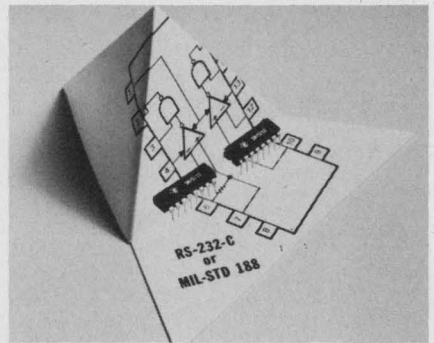

Texas Instruments Inc., P.O. Box 5012, M/S 308, Dallas, Tex. 75222. (214) 238-3741. \$5.40 in plastic; stock.

A dual line receiver IC meets RS-232-C or MIL-STD-188C specs without requiring external components. Designated the SN75152, this interface IC features a  $\pm 25$  V input common-mode range, 25 V differential input capability and continuously adjustable hysteresis with external resistors. Input hysteresis for the SN75152 remains approximately fixed for power supply and/or temperature variation. This receiver operates on  $\pm 12$  V power supplies and over the 0 to 70°C industrial temperature range.

CIRCLE NO. 259

### 1024-bit static MOS RAM easy to use

Intel Corp., 3065 Bowers Ave., Santa Clara, Calif. 95051. (408) 246-7501. \$35 (100 up); stock.

A 1024-bit n-channel silicon-gate static MOS RAM connects to TTL logic without any interface circuits. Termed the 2102, it runs on a single 5-V supply, accepts standard TTL inputs and generates a standard TTL output. Because the RAM is fully decoded and static, it requires no external decoding circuits, no refreshing circuits and no clock. Other features include an access time of 1  $\mu$ s, power dissipation of 0.15 mW/bit and input capacitance of only 5 pF. It has a 3-state output for OR-tie capability and a chip-enable input to facilitate simple memory assembly and expansion.

CIRCLE NO. 260

# WINDJAMMER

# FREE *barefoot' adventure*

**SOMETHING TO  
STIMULATE YOUR  
EROTIC PREOCCUPATION**

We have a book with color pictures. It's nothing pornographic. But somehow it tends to stimulate erotic thoughts. Especially if you're a free thinking, uninhibited person who wants to be turned on to an unusual vacation experience.

We sail adventurous schooners to several slightly uncivilized islands in the Caribbean. Places like Grenada, Saba, Monserrat, St. Maarten and Antigua. Fortunately these are the few islands that haven't been overrun by jaded tourists.

So you can find a deserted beach and stretch without being seen. Or you can strip down and play under a waterfall. Or you can get into the local color on each island.

And we haven't let our Windjammer cruises become a luxury. We keep things basic. Nice, clean cabins. Good hearty food. And an uninhibited crew that will entertain you until dawn with wild native music. The rest is up to you. There are no formalities, no social pressures, no restrictions. Fish, skin dive soak up the sun and communicate with real people in an unhampered, natural setting.

A 10 day Windjammer cruise starts at \$245 per person. Write for our free book today. It will give you something good to think about.



**Windjammer Cruises.**  
P.O. Box 431, Main Office Department 550 Miami, Florida 33101  
Yes, send me the book.

Name \_\_\_\_\_  
Address \_\_\_\_\_  
City \_\_\_\_\_ State \_\_\_\_\_ Zip \_\_\_\_\_

few major  
companies  
can give you  
this type of  
recorder.



**Our Recorder  
is the one with  
greater accuracy  
and efficiency.**

- With a larger memory bank . . .  
41% larger . . . for more on-line processing  
before the memory has to be cleared again.
  - Greater accuracy in system stability and recording.
  - With these pluses and more,  
our Pulse and Transient Recorder costs less.
- Add to this an unheard of ease of operation,  
a compatibility with all types of recording devices  
and a flexibility that makes its applications seem endless,  
and you've got the one that fulfills your recording needs best.
- Ask for the whole story, ask for the literature  
on the \*ICE Pulse and Transient Recorder.  
The better one.



P.O. Box 507, Lansdale, Pa. 19446 • (215) 855-0922 • TWX: 510-661-4976 • Cable: AMERLAB

INFORMATION RETRIEVAL NUMBER 54

## ICs & SEMICONDUCTORS

### UV silicon photodiodes spec'd at 90 mA/W

EG&G, Inc., Electro-Optics Div., 35  
Congress St., Salem, Mass. 01970.  
(617) 745-3200.

A UV series of photovoltaic silicon photodiodes are optimized for analytical instrument applications. Special features include a spectral responsivity at 230  $\mu\text{m}$  of 90 mA/W; spectral stability at 230  $\mu\text{m}$  of 0.13%/°C; equivalent Johnson noise current in the range of  $2\text{-}5 \times 10^{-14}$  A per root hertz; and a linearity response within 1% over seven decades of irradiance. Available stock items are the UV-100 with an area of 0.051  $\text{cm}^2$ ; the UV-444A with active area of 1.0  $\text{cm}^2$ ; the UV-800A with active area of 3.14  $\text{cm}^2$ ; and the HUV-1000 op amp/photodiode, which combines the UV-100 and a low noise, FET input op amp in a TO-5 package.

CIRCLE NO. 261

### Driver ICs good for magnetic memories

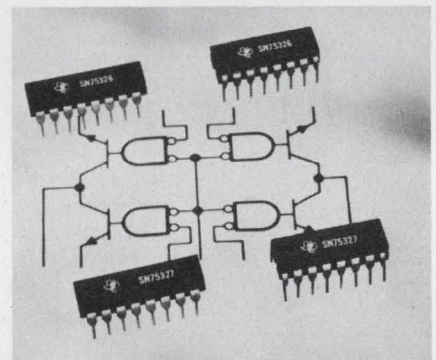

Texas Instruments Inc., P.O. Box  
5012, M/S 308, Dallas, Tex. 75222.  
(214) 238-3741. SN75326N and  
SN75327N: \$4.20 (100 up); stock.

Two versatile memory driver ICs, termed the SN55/75326 and the SN55/75327, are compatible with high speed magnetic memory systems. These quad bipolar memory drivers accept standard TTL/DTL decoder input signals and create high current, high-voltage output levels suitable for driving magnetic memory drive lines. Output transistor selection is determined by four separate address inputs and common timing strobe.

CIRCLE NO. 262

## CMOS rate multiplier does arith functions

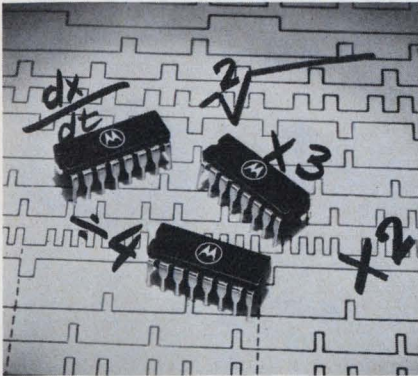

Motorola Semiconductor Products Inc., P.O. Box 20924, Phoenix, Ariz. 85036. (602) 273-3466. MC-14527CL: \$6.60; MC14527AL: \$11.85 (100-999).

The MC14527 BCD rate multiplier, a CMOS (CMOS) device, performs arithmetic, algebraic and differential-equation functions. The output of the multiplier has a pulse rate based on a BCD input number. This device is the first low power—0.25  $\mu$ W (quiescent)/package at 5 V dc—and high noise immunity (45% of  $V_{DD}$  typ) BCD rate multiplier. Previous digital rate multiplier functions have been available only in TTL devices.

CIRCLE NO. 263

## Programmable processor system

Fairchild Semiconductor, 464 Ellis St., Mountain View, Calif. 94040. (415) 962-3816

A family of microprogrammed MOS/LSI data processor circuits can be developed into a wide variety of small programmable digital processing systems. Called the PPS-25 (for Programmable Processor System), the system consists of a kit of six basic building blocks: the 3807/3803 keyboard circuits, 3805 arithmetic unit, 3806 function and timing unit, 3808/3809 serial memory registers, 3810 ROM and the 3811 output device. Although the kit comprises standard devices, it can be adapted to individual system requirements by microprogramming the 3810 ROM.

CIRCLE NO. 264

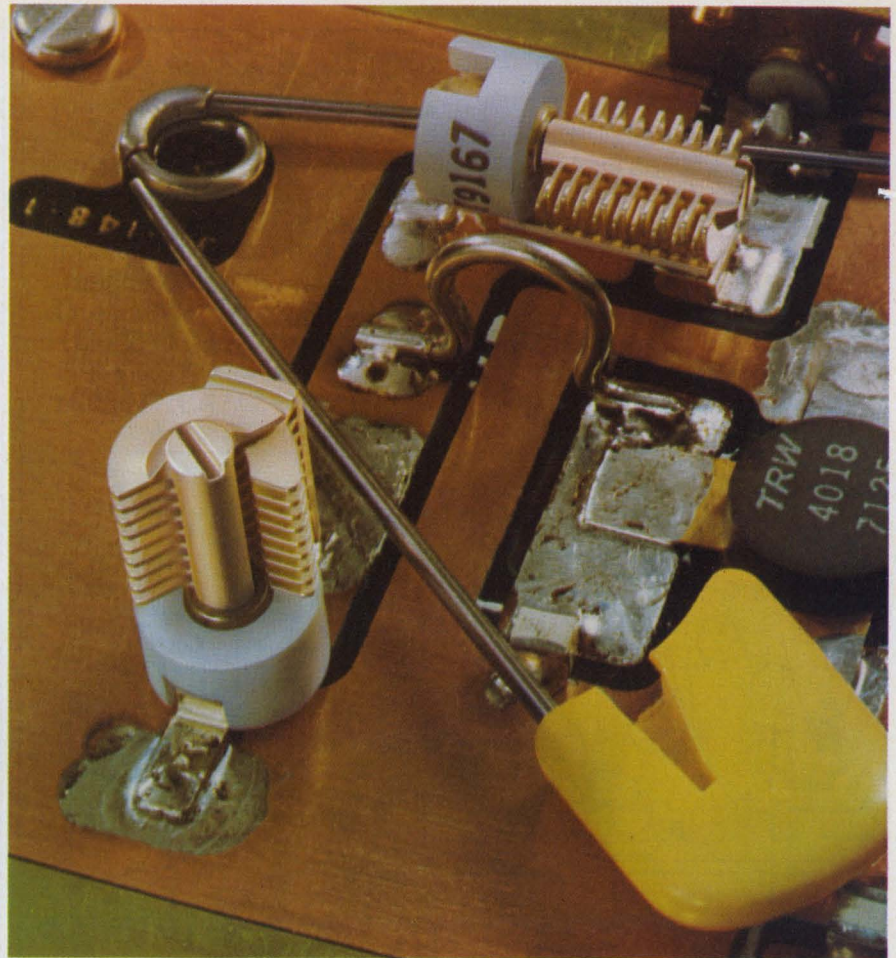

## The smallest 180° tuning air variable capacitors just had babies!

Right. Johnson's exclusive subminiature type "T" air variable capacitors (PC mounts) now come with stripline terminals for microwave applications, either vertical or horizontal tuning.

These space-savers are only about 1/3 the volume of a "U" capacitor, but they offer extraordinarily high mechanical and electrical performance for critical applications.

Rotors and stators are as stable and uniform as precision machining from solid brass extrusion can make them. A high 1 1/2 to 8 ounce-inches torque holds the rotor securely under vibration.

Temperature coefficient is very low plus 30 ± 15 ppm/° C. Q is high, typically 1800 at 200 MHz. Three capacitance ranges span from 1.3 pF to 15.7 pF.

Our 45 years of experience really shows up in these new capacitors. But why take our word for it when a stamp will get you a couple of freebies and you can check them out for yourself.

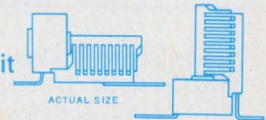

E. F. JOHNSON COMPANY / 3301 Tenth Ave., S.W. / Waseca, Minnesota 56093

Check type and range of sample(s) needed:	Capacitance range	1.3 to 5.4	1.7 to 11.0	1.9 to 15.7
	Horizontal tuning	<input type="checkbox"/>	<input type="checkbox"/>	<input type="checkbox"/>
	Vertical tuning	<input type="checkbox"/>	<input type="checkbox"/>	<input type="checkbox"/>

Name \_\_\_\_\_ Phone \_\_\_\_\_

Firm \_\_\_\_\_ Title \_\_\_\_\_

Address \_\_\_\_\_

City \_\_\_\_\_ State \_\_\_\_\_ Zip \_\_\_\_\_



**E. F. JOHNSON COMPANY**

INFORMATION RETRIEVAL NUMBER 55

WHILE SPENDING LONG SUNLESS DAYS IN ALASKA, PROFESSOR FLAKE CAME UP WITH THIS INGENUOUS INVENTION WHICH HE CALLS "THE COMBINATION CHICKEN-FOOLER AND THREE MINUTE EGG ALARM. CANDLE (A) BURNS DOWN TO THE POINT WHERE STRING BREAKS. THIS ALLOWS HAMMER (B) TO FALL KNOCKING SLEEPING BIRD (C) OFF SWING. REMOVAL OF BIRD'S WEIGHT ALLOWS PHONOGRAPH ARM TO FALL ON RECORD (D) AS RECORD PLAYER (E) BLASTS OUT "JADA," SQUIRREL THAT HAS BEEN TRAINED TO RESPOND, TURNS TREADMILL ATTACHED TO GENERATOR (F). GENERATOR LIGHTS BULB (G) AND CHICKEN, THINKING IT IS SUNRISE, LAYS EGG WHICH ROLLS INTO TEAKETTLE ON ELECTRIC HOT PLATE (H). STEAM FROM TEAKETTLE TRAVELS THROUGH HOSE ATTACHED TO BED (I) AS STEAM INFLATES RUBBER BALLOON, IT PASSES AGAINST POINT OF KNIFE (J) AND IS PUNCTURED. THE RESULTING NOISE AWAKENS SLEEPING MAN JUST IN TIME TO RETRIEVE THREE-MINUTE EGG FROM TEAKETTLE.

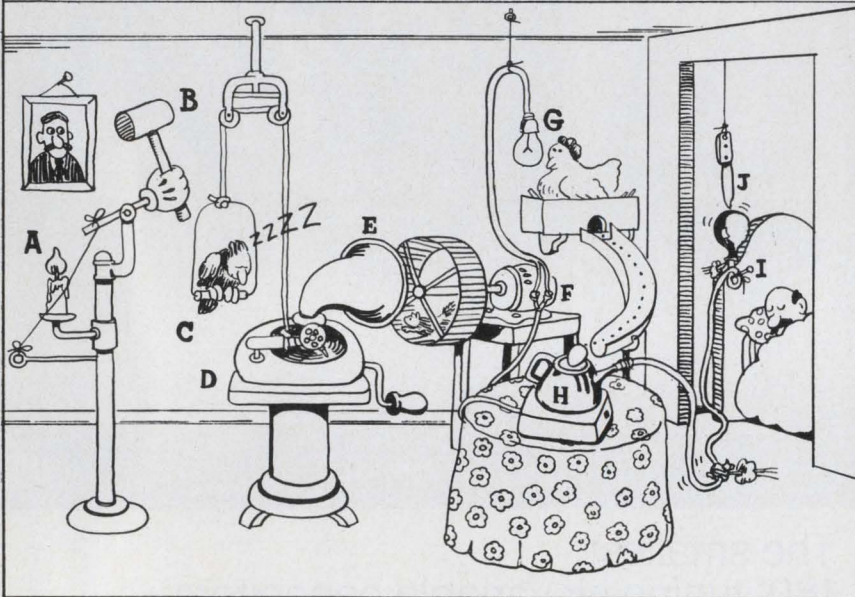

## There's a better way to time yourself. Send for our E-Cell™ Kit.

A \$30 value to introduce you to the wide range of timing, counting, integrating, delaying, monitoring, sequencing and measuring capabilities of this remarkably useful electronic device. Ten functioning E-Cell components, ready to use, with schematics for circuit assembly. Full specifications. Applications Notes and Plug-in sockets. The whole works for only \$9.95.



actual size

Plessey Electro-Products  
3860 Centinela Avenue, Los Angeles, California 90066

Enclosed is my check or money order for \$9.95.  
Please send my E-Cell Applications Kit to:

Name _____	
Title _____	Company _____
Street _____	City _____
State _____	Zip _____



**Plessey Electro-Products**

INFORMATION RETRIEVAL NUMBER 56

## Fast multipliers give 8 bits in 40 ns



Texas Instruments Inc., P.O. Box 5012, M/S 308, Dallas, Tex. 75222. (214) 238-3741. SN74284N and SN74285N: \$8.10 (100 up); stock.

Two TTL/LSI ICs can be used together to generate an eight-bit binary product in 40 ns. Designated the SN54/74284 and SN54/74285, these four-bit-by-four-bit parallel binary multipliers each contain the equivalent of over 200 gates on a monolithic chip. Used with the SN54H/74H183 carry-save adder, the SN54S/74S181 arithmetic logic unit, and the SN54S/74S182 look-ahead generator, expandable n-bit-by-n-bit applications are possible.

CIRCLE NO. 265

## Waveform gen/VCO has 50 ppm/°C stability

Intersil, 10900 N. Tantau Ave., Cupertino, Calif. 95014. (408) 257-5450 8038A: \$9; 8038B: \$4; 8038C: \$2.50 (100 up).

A monolithic IC waveform generator and voltage controlled oscillator, termed the 8038, produces simultaneous sine-wave, square-wave, and triangular-wave outputs with minimum amplitudes up to 6 V, 28 V and 10 V pk-pk, respectively. The 8038C has a typical temperature drift stability of 50 ppm/°C. Other versions have typical drift specs of 10 ppm/°C (8038A) and 20 ppm/°C (8038B). All outputs may be made TTL compatible and output frequency is tunable from 0.001 Hz to 1.0 MHz.

CIRCLE NO. 266



# SUPER BOWL



... and what a line-up—depth in every position! A rugged team of general purpose relays from 1 to 20 amps, AC and DC, 1 to 6PDT, with ratings to 110 VDC and 250 VAC. At the corners, dry reed and mercury-wetted DIP; on the line, open frame and covered units, plug-in and axial lead, Forms A, B and C, with ratings to 2 amps, 50 watts and 500 VDC. And in line backer slots, a new series of electromechanical and solid state industrial timers and sensors with delays of 0.01 to 360 seconds, voltages to 220 VDC and 400 VAC, and frequencies to 440 Hz.

Whatever signals you call, you're the coach with the Babcock team. Call your own "audibles" with our general purpose units; they're completely interchangeable with other models. They'll plug right into your PC board or socket with no time out. And there's never a fumble on delivery—the entire Babcock team is available "off the bench". If you have a design problem, huddle with us on it.

too; our applications engineering staff is ready to join your team.

Send for your FREE program today—our new short form lists all the players...with some very interesting numbers. Write or call Babcock Electronics Corp., Unit of Esterline Corp., 3501 No. Harbor Blvd., Costa Mesa, Calif. 92626; Tel: (714) 540-1234.



## BABCOCK

A UNIT OF ESTERLINE CORPORATION

INFORMATION RETRIEVAL NUMBER 57

# Hardware Fast Fourier Transform Processor

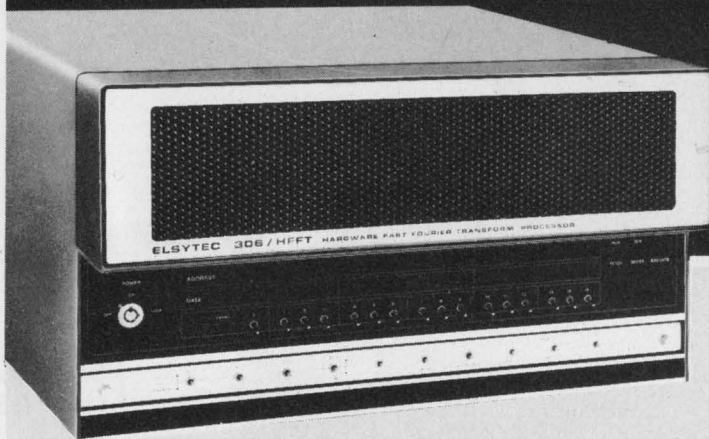

The 306/HFFT is a digital processor that performs forward or inverse Fourier Transforms of time or frequency domain data. It is contained within the mainframe of its host NOVA 800 computer for efficiency, smaller size and cost saving.

## FEATURES

- Basic Fast Fourier Transform time of 9.5 ms for 512 complex points (1024 real points).
- Real-Time to 25 KHz for 1024 real input points, 18 ms total processing time including all requisite procedures.
- Transform from 16 to 16384 real points.
- Full 16 bit accuracy.
- Polar coordinate output standard.

## APPLICATIONS

- |                         |                          |                   |
|-------------------------|--------------------------|-------------------|
| • Underwater acoustics  | • Speech recognition     | • Biomedicine     |
| • Mechanical vibrations | • Noise identification   | • Geophysics      |
| • Digital filtering     | • Doppler radar analysis | • Nuclear physics |

### EXPAND to a complete Fourier Spectrum Analyzer by field addition of:

- |                                    |                         |
|------------------------------------|-------------------------|
| • A single or dual Input Channel.  | • Anti-aliasing filters |
| • Operation oriented Control Panel | • Output displays       |

Delivery is 90 days ARO.

For further information, contact your local representative or the factory directly.

**elsytec**  
electronic systems technology

212 MICHAEL DRIVE, SYOSSET, N.Y. 11791  
(516) 364-0560

## High threshold logic line expands

Motorola Semiconductor Products, Inc., P.O. Box 20924, Phoenix, Ariz. 85036. (602) 273-3466. MC684P, MC685P and MC686P: \$4.05; MC688P: \$2.10.

The company's high threshold logic (HTL) line expands by four new devices: the MC686, a four-bit shift register (the first shift register offered in MHTL Series); the MC684, a decade counter, and the MC685 binary counter (first two counters in the series) and the MC688, a dual J-K flip-flop in a 16-pin package. All MHTL devices operate on a +15 V power supply. Switching threshold voltage is typically +7.5 V, while dc noise margin is typically 6 V.

CIRCLE NO. 267

## Dual line receiver features $\pm 100$ mV input

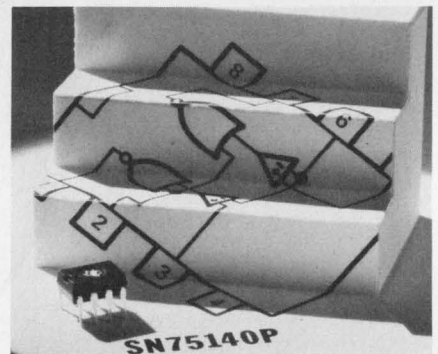

Texas Instruments Inc., P.O. Box 5012, M/S 308, Dallas, Tex. 75222. (214) 238-3741. P: See below.

A versatile and economical dual line receiver provides a low-input current of less than 100  $\mu$ A. This allows the receiver, designated the SN75140P and priced at \$2.52 (100 up), to be used in bus-organized systems. As many as 100 receivers may be used per line. The device comes in an 8-pin plastic DIP and features a guaranteed  $\pm 100$  mV input sensitivity for higher noise margins. Also, threshold voltage is externally adjustable from 1.5 to 3.5 V.

CIRCLE NO. 268

# WESTON presents a small achievement.

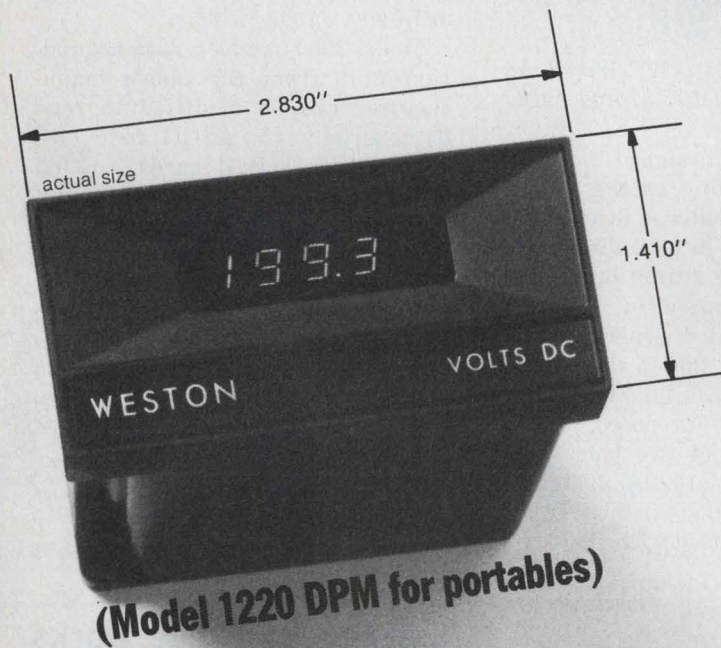

At last—a truly tiny DPM, with all the features you need for portable equipment.

A full 3½-digit meter. Weighs only 4 ounces. Takes up less than 4 square inches of panel space. Or, if that's too much, you can flush-mount it with only the readout showing.

But, power requirements are the big story of the 1220. 5.5V  $\pm$  10% is all the DC it needs. Use four Nicad C cells for up to 18 hours continuous operation—with all segments lit. Or, draw from equipment DC power supply. The 1220 uses less than .75 watt with all digits working. And, digits not in use are

automatically blanked out to conserve power.

And that's not all. The 1220 features a plug-in bi-polar LED display, reliable printed circuitry built around a plug-in LSI chip, and is designed to conform to vibration spec. MIL-M-10304. External display check feature lets you illuminate all segments of the display. And, of course, it needs no warmup. Accuracy is guaranteed from the moment you turn it on! Ten variations of the 1220 are available to give you a choice of full-scale ranges from 100MV to 1000V, 10 $\mu$ A to 100MA.

Sound like a lot? Here's the best part. The Model 1220 is less than \$100 each in OEM quantities. For line operation only, order Model 1221.

To see our new Model 1220 DPM, call your nearest Weston distributor. He'll be glad to go anywhere to show you the "go-anywhere" DPM. Or, call us direct at (201) 243-4700. Weston Instruments, Inc., 614 Freylinghuysen Ave., Newark, N.J. 07114.

**We're either first or best. Or both.**

**WESTON**<sup>®</sup>

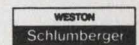

## Recorder provides copy from CRT terminals

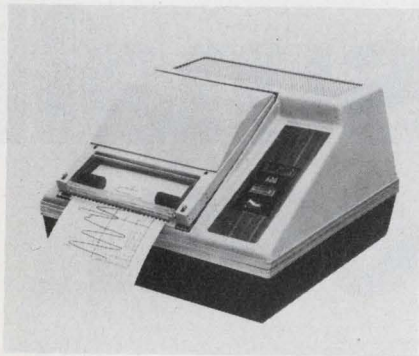

Alden Electronic & Impulse Recording Equipment Co., Inc., Alden Research Center, Westborough, Mass. 01581. (617) 366-8851. \$2400 (unit qty.); \$1830 (100 up).

The Alden 600 "Push to Print" OEM recorder provides paper records from graphic CRT display terminals. A flying-spot technique is used to write on electrosensitive paper at 30 lines/s—a 600-line frame takes 20 s. Recordings are visible immediately and require no further processing. No toners, developers and fixers are used, and the cost of supplies is less than one cent per frame. A sweep-trigger output pulse is supplied by the unit. The user supplies X-Y voltages and a CRT target "read" signal to the unit. Space and power are available for the addition of a customer's circuitry within the housing.

CIRCLE NO. 269

## CPU chip offers 12.5 $\mu$ s instruction cycle

Intel Corp., 3065 Bowers Ave., Santa Clara, Calif. 95051. (408) 246-7501. \$90 (100 up); stock.

Model 8008-1, a faster version of the Model 8008 CPU, is designed for direct addressing of up to 16 k, eight-bit words. Model 8008-1 contains an eight-bit parallel adder, six 8-bit data registers plus 11 additional registers. It operates with a set of 45 instructions, has interrupt capability, can perform as many as seven nested subroutines and operates synchronously or asynchronously. All inputs and outputs are TTL compatible.

CIRCLE NO. 270

## Cartridge recorder takes 1/4-in. tape



Kennedy Co., 540 W. Woodbury Rd., Altadena, Calif. 91001. (213) 798-0953. \$750.

Model 330 is designed for reliable data recording on the 1/4-in. 3M tape cartridge. Read/write speed is 25 in/s in both directions. Forward/reverse search or rewind is done at a speed of 90 in/s. Data are recorded separately on four tracks of a 300-ft tape using a density of 1600 bits/in. Model 330 meets the proposed ANSI standard. One and two track versions of the unit are also available. Cartridges recorded on these other versions can be used with the four-track unit.

CIRCLE NO. 271

## Versatile interface collects lab data

Bell Engineering, 1425 N. Ridgeway Dr., Tucson, Ariz. 85712. (602) 296-9005. \$2500.

This compact rack or bench-mount interface, for IBM-1800 series computers, transfers control signals and 16-bit data words from IC or relay data sources. Designated as Model 275, the unit features optical coupling for ground loop isolation, logic level conversion with adjustable noise immunity and adjustable time delays for generating process interrupts. Data transfer from a source device can be initiated via an interrupt generated from the source or under program control. Available options include: built-in status indicators, a diagnostic test panel and modified logic levels for interface with other computers.

CIRCLE NO. 272

## Interface controls data acquisition

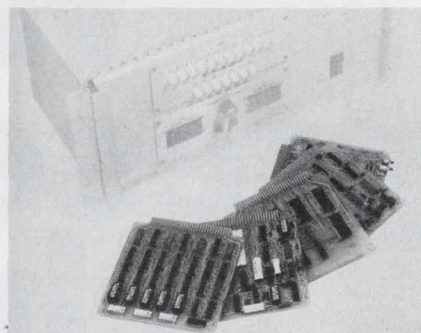

Moxon Inc., SRC Div., 2222 Michelson Dr., Irvine, Calif. 92664. (714) 833-2000. \$1095; 3 wks.

Model-3900 analog-data-acquisition unit from the above manufacturer can be modified to send data serially via ASCII code (RS 232). Three circuit cards, costing \$770, format the characters, insert stop bits, control the number of words per printed line, and provide other functions. Baud rates of 110, 115 or 300 can be selected. There are two additional cards with optional applications. The fourth card permits remote control converter operation and the fifth card inserts time codes using any external BCD source. These cost \$175 and \$150, respectively.

CIRCLE NO. 273

## Software package works with digitized data

Visicon Inc., Box 1008, State College, Pa. 16801. (814) 237-6521. See text.

Written in ASA Basic Fortran, this software package converts raster information from digitizing equipment such as flying-spot scanners to formats compatible with such devices as interactive drafting systems and digital incremental plotters. Requirements for use include a machine with Fortran capability and a memory of 16 to 20 k words depending on the I/O structures. An IBM 360/65, for example, can, per processing second, convert up to 16 inches of line information from the raster. The package is available on a leasing arrangement, with a cost of \$5000 for the first year and \$1000 per year thereafter. Maintenance and updating of the software is included in the lease.

CIRCLE NO. 274

# DIGITEC'S NEW DATA LOGGERS

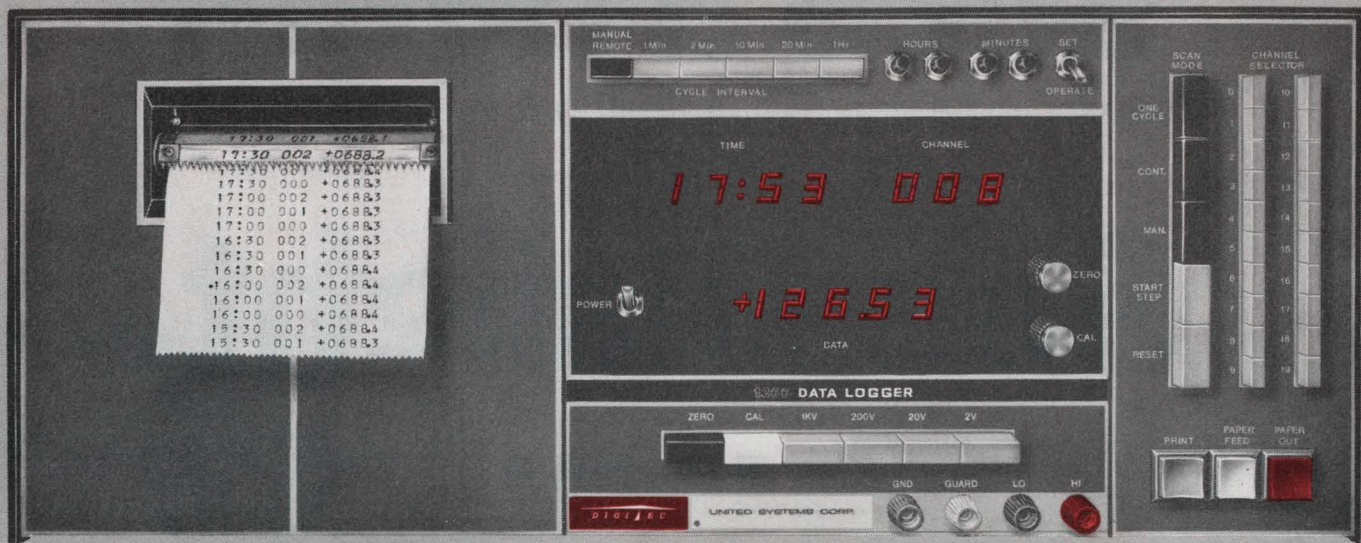

## HAVE ALL THIS VERSATILITY

- Models to measure Voltage, Current, Resistance, Temperature & other transduced parameters.
- 20 selectable scan points standard, expandable to 200.
- Real-time digital clock with program interval for unattended operation, standard.
- Digital printout arranged for quick, easy reading.
- BCD and system interlocks brought out to interface peripherals such as: comparators, tape punch, and mini-computer.
- Loss of power indication.
- All LED long-life displays.

## WITH PRICES UNDER \$1900

To see the DigiTec 1200 or 1500 series Data Loggers, simply contact your DigiTec representative. Or, you can call or write: **United Systems Corporation**, 918 Woodley Rd., Dayton, Ohio 45403 Phone (513) 254-6251.

All DigiTec instruments are available for rental or lease through Rental Electronics, Inc.

**DIGITEC**<sup>®</sup>  
UNITED SYSTEMS CORPORATION  
subsidiary of **Monsanto**

# Dialight sees a need:

(**Need:** Find a very small fault in a very large system.)

# See Dialight.

All printed-circuit boards need a fault indicator; that's why Dialight has developed such a broad family. These tiny LED devices signal where and when a fault occurs in a complex electronic circuit—and this can reduce downtime to a minimum. With some Dialight fault indicators, you can get as many as 10 units in just 1" of space. These devices, which come in a variety of sizes, are designed to operate from 1.6 to 14 volts and are available with both axial and right angle leads. They

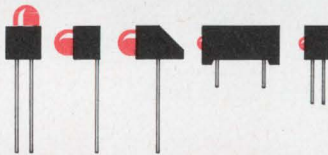

can be driven directly from DTL or TTL logic and can also serve as logic-state indicators, binary data displays, or just as indicators, as in this p-c board furnished by Struthers-Dunn, Inc.\* But Dialight's fault finders are only a small part of their fast growing family of light-emitting diodes. Additional opto-electronic devices are extensively used in cartridges, lighted push-button switches, opto-isolators, and readouts, all supplied by Dialight. A wide variety of discrete LEDs further adds to the broad family.

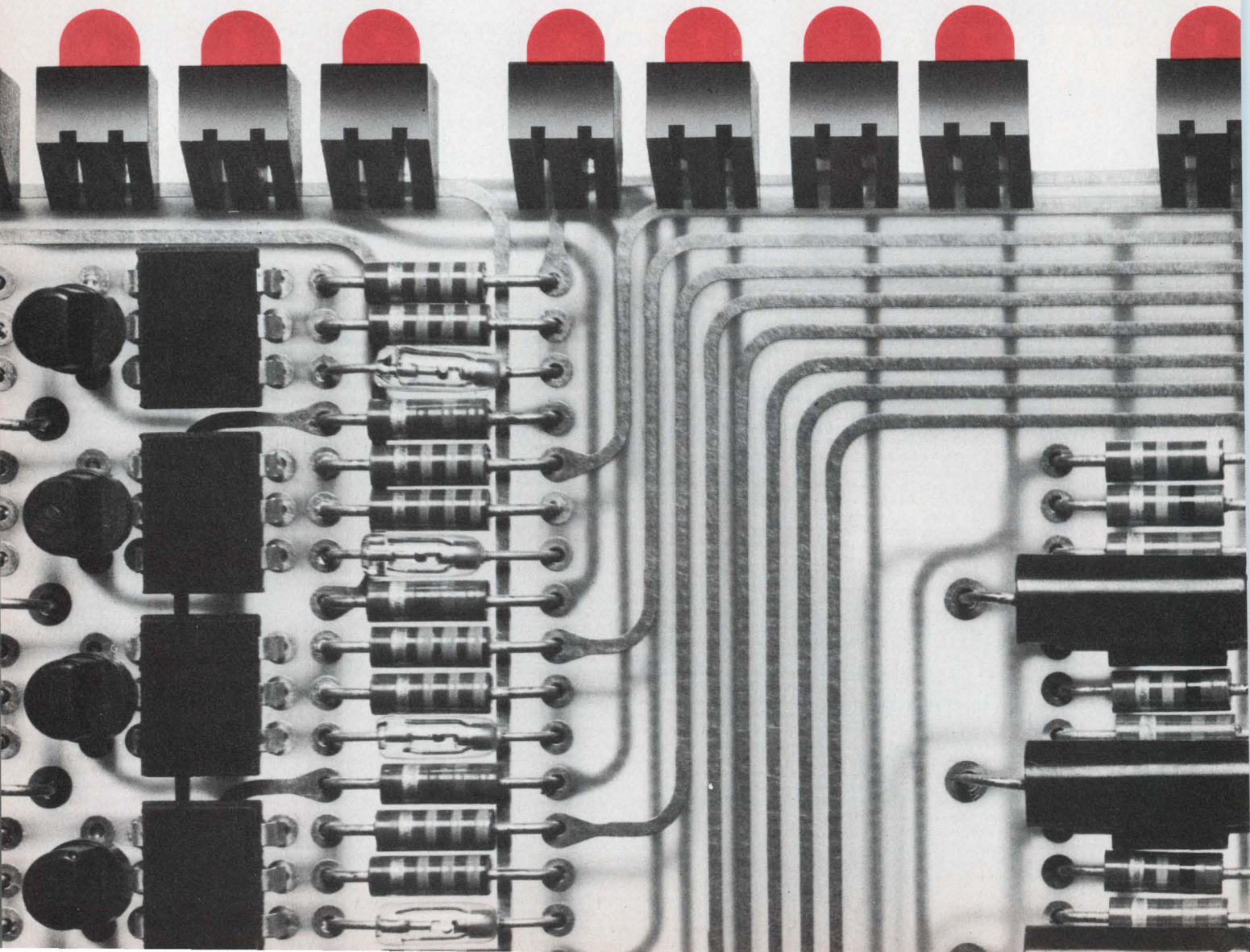

Dialight is a company that looks for needs . . . and develops solutions. That's why we developed the industry's broadest line of switches, indicator lights and readouts using LEDs. No other company offers you one-stop shopping in all these product areas. And no one has more experience in the visual display field. Dialight can help you do more with them. Talk to the specialists at Dialight first. You won't have to talk to anyone else. We can help you do more with LEDs than anyone else because we've done more with them.

Here are a few products in this family: **1.** Ultra-miniature indicator lights **2.** Datalamp cartridges **3.** Bi-pin LED lamp **4.** Opto-isolators **5.** LED solid state lamps **6.** Logic state fault indicators

\*Used in their VIP Programmable Controller

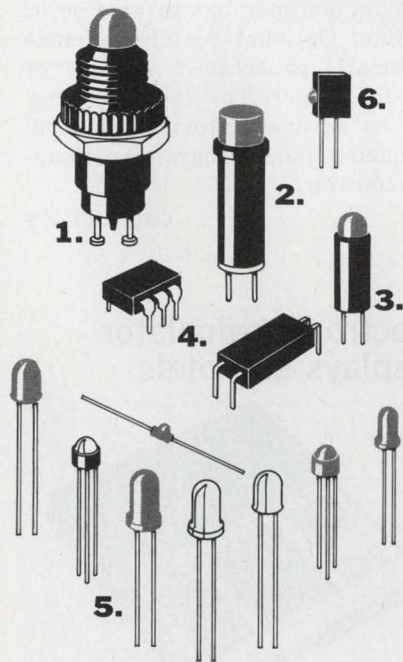

Please send data on your LED products.

NAME \_\_\_\_\_

TITLE \_\_\_\_\_

COMPANY \_\_\_\_\_

ADDRESS \_\_\_\_\_

CITY \_\_\_\_\_ STATE \_\_\_\_\_

**DIALIGHT**

Dialight Corporation, A North American Philips Company  
60 Stewart Avenue, Brooklyn, N.Y. 11237 (212) 497-7600

## DATA PROCESSING

### Disc drive uses head-per-track access



Dataflux, 1195 E. Arques Ave., Sunnyvale, Calif. 94086. (408) 732-7070. \$1200 to \$2500; 30 days.

Model 914 series disc-cartridge drives use a fixed head-per-track to access data. Storage capacities range from 0.5 to 8 Mbits using modules of 16 tracks. Rotation speeds of 1800, 2400 and 3600 rev/min result in average access times of 17, 12.5 and 8.5, ms, respectively. The number of sectors per track is variable from 0 to 2400. The data cartridges are removable. Prices range from \$1200 to \$2500 depending on storage requirements.

CIRCLE NO. 275

### Voice response system has proper enunciation



Instrument Systems, Inc., 540 Easy St., Garland, Tex. 75042. (214) 272-8556. \$1295; 90 days.

Devices having parallel BCD with positive true logic can have their readings announced by this digital-to-voice converter. Designated the DIGIVOX, this low-cost unit communicates in proper cadence with a voice drop at the end of each phrase. Applications for the unit include laboratory instrumentation, medical reporting, business information systems and transportation announcement systems.

CIRCLE NO. 276

### Plug-compatible line printer fits most minis



Digital Associates Corp., 1031 Post Rd., Darien, Conn. 06820. (203) 655-2222. Lease—\$279/mo.

Without hardware or software modification to the minicomputer, Model V-132-C can print at 600 lines/min with a width of 132 columns. It can be equipped for use with PDP-8, PDP-11, PDP-12, Data General Nova, Varian 620 and most other minicomputers. Installation and complete maintenance are available through Digital Associates nationwide and in Canada. The unit can also be purchased instead of leased.

CIRCLE NO. 277

### Improved performance disc drive announced

Ampex Corp., 13031 W. Jefferson Blvd., Marina del Rey, Calif. 90291. (213) 821-8933. \$25,000; 90 days.

Model DM-330 disc drive is said to decrease access time by an average of 2 ms over that of the IBM Model 3330 which it is designed to replace. Other claims for this model include 15% lower price and 1/3 less volume as compared with the Model 3330. Up to 16 Ampex drives, storing 100-million bytes of data each, can be linked with controllers on IBM-370 computers without hardware or software modifications. All units, including those packaged for OEMs, have regulated power supplies and TTL circuitry.

CIRCLE NO. 278

**Decision:** Assume you need an alterable, non-volatile memory in your system, what choices do you have *right now*? And at what *true* and *complete* cost-per-bit?

Cores and plated wire—patchboards—diode arrays? Fine. Providing you need lots of memory—and you're not concerned about size, bulk and speed. Or power consumption. Or compatibility with existing and future logic forms. Or the additional cost of power-fail detection circuitry, or retrieval software and reload hardware—and the like.

*Let's talk*

**Cost-per-Bit**

Semiconductor memories? If you go with RAMs your bit cost per se may be lower. But you'll have to consider the extra cost of providing an uninterruptible power source. Or power-fail detection circuitry and battery back-up. Or retrieval software and reload hardware. Just to compensate for their inherent volatility.

If you consider ROMs—either the fixed or one-shot programmable variety—your cost-per-bit for memory alone could be even lower. Until you start adding up all the extra peripheral costs involved in trying to overcome their inherent unalterability. Simulation systems. Special masks and programmers. Surplus capacity for unused future options. Not to mention multiple spare parts inventories, field retrofits, obsolete stock, and spoilage due to errors.

So where do you go from there? *Take a good look at RMMs!*

# AMORPHOUS RMM

## ALTERABLE / NON-VOLATILE SEMICONDUCTOR MEMORIES

They're the only *inherently* non-volatile, *fully* electrically alterable semiconductor memories in production—*now!* You can use them just like any other hard-wired memory elements—but without having to buy and build a bunch of superfluous circuitry into your system just to protect stored data or correct program errors.

In fact, you can take Ovonic RMMs completely out of your system—for days, weeks, years at a time—without loss of data. And you can also change, up-date and re-alter stored information at will. Quickly, selectively and *repeatedly*—by simple electrical means.

Easy to apply, too. Standard packages. TTL/DTL compatible. Compatible with each other. Which means you can mix or intermix them any way you like to create flexible, expandable memory systems to meet present and future needs—*exactly!*

Cost-per-bit? Still a bit more than RAMs or ROMs on a straight device comparison basis.

But considering the fact that bit cost is the *only* cost with RMMs, you'll find they're worth it! Important, too: RMM costs have dropped dramatically in the past 18 months and haven't reached bottom yet. So if you start using them now, your true bit costs will be a lot less by the time you hit volume production.

Call or write for complete information today!

**Energy Conversion Devices, Inc.**

1675 WEST MAPLE ROAD • TROY, MICHIGAN 48064  
TELEPHONE 313/549-7300



## DATA PROCESSING

### X-Y plotter operates without software

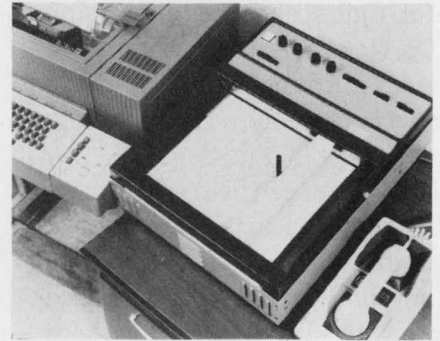

Valtec Corp., 17751 Sky Park Circle, Suite G, Irvine, Calif. 92707. (714) 540-9591. \$3600; stock.

The use of internal logic is said to eliminate the need for supporting software at the computer source. Operation is therefore independent of the service or language used. Model 2024/121 is plug compatible with all TTY/RS232 devices, operates at 10, 15 or 30 characters/s., can use ASCII or EBCDIC data and may be operated on or off-line. Optional features include automatic paper feed and use of fan-fold paper. The fan-fold paper can be advanced from an internal magazine under program or operator control.

CIRCLE NO. 279

### Electronic calculator displays subtotals

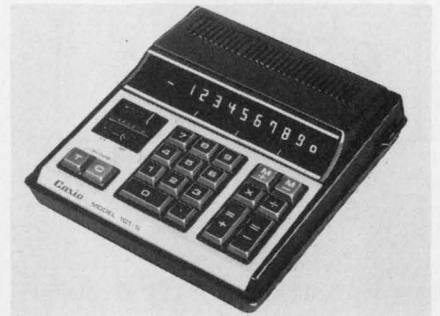

Casio, Inc., 1 World Trade Ctr., New York, N.Y. 10048. (212) 432-9230. See text.

Model 101-S is a 10-digit electronic calculator which can give accumulations at the same time as individual results of multiplication. This is done simply by pressing the appropriate memory key. The unit is intended to retail at a price of \$225.

CIRCLE NO. 280



# PUT THE BUGS BACK IN YOUR CIRCUITS...



## ...WITH A FREE LADY BUG FROM ADC!

If you've been thinking that most commercial transformers are pretty much alike, these new ADC Lady Bugs will change your mind.

We've engineered Lady Bugs to provide the kind of reliability you've come to associate only with transformers meeting military specifications. More than that, we've made sure these ADC Transformers offer something you haven't seen in a while: economy. So, beginning now, you can have the transformer performance you've always wanted, and still keep costs in line.

ADC Lady Bugs come in 46 different electrical configurations with power ratings from 50 mw to 2 watts. There are four different case sizes, with the smallest being approximately one-third cubic inch.

We don't want to bug you, but if you have a real need for miniature transformers, we will send you an evaluation sample free — no strings attached. Just tell us what your requirements are on the coupon and send it back to us. Or, if you just want more information, please circle the number on the Reader Service card.

### ADC PRODUCTS

4900 West 78th Street  
Minneapolis, Minnesota 55435

Yes, I would like an evaluation sample of the new Lady Bug transformer. Here's my application: \_\_\_\_\_  
\_\_\_\_\_

We anticipate using \_\_\_\_\_ units/year.  
My needs are for \_\_\_\_\_ 30 days  
\_\_\_\_\_ 60-120 days \_\_\_\_\_ Future

Division of Magnetic Controls Company  
4900 West 78th Street  
Minneapolis, Minnesota 55435  
TEL: (612) 835-6800 TWX: 910-576-2832 TELEX: 29-0321

NAME \_\_\_\_\_

COMPANY \_\_\_\_\_

ADDRESS \_\_\_\_\_

CITY \_\_\_\_\_ STATE \_\_\_\_\_ ZIP \_\_\_\_\_

TELEPHONE \_\_\_\_\_



DATA PROCESSING

**Simulator helps debug peripheral hardware**

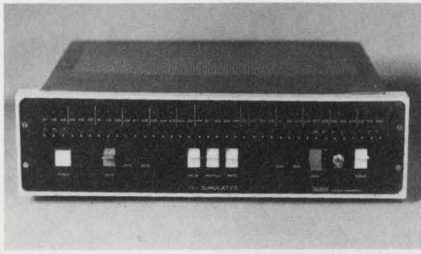

Teletron Co., 40 Elliott St., Melrose, Mass. 02176. (617) 665-5837.

The electrical and timing interface of the Model 11 simulator is identical to that of the PDP-11's Unibus. Any external device may be addressed, interrogated or written into under manual control thereby saving the time and labor of writing equivalent test programs. Proper operation of external interrupt and direct memory access (DMA) logic can be verified. The unit can apply stimuli to external devices along with suitable signals for synchronizing oscilloscope traces with the measured events.

CIRCLE NO. 281

**Floppy disc has rectangular shape**

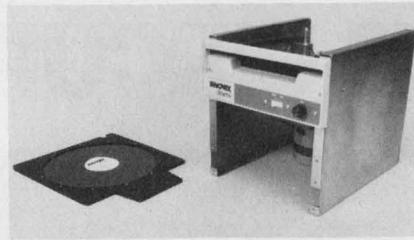

Innovex Corp., 4 Alfred Circle, Bedford, Mass. 01730. (617) 275-2110. \$990; mid-January.

Designated a "Diskette," this "floppy-disc" memory system boasts a 5- ms track-to-track access time and a bit transfer rate of 105 kbits/s.—all for the price of \$990. In operation, the disc remains stationary while the read/write head spins at 400 revs/min. The tape cartridge is a sheet of computer grade magnetic tape stretched on a 9 by 11 by 0.025 in. plastic frame. One-million bits of information are stored on 64 circular tracks. There is a 25 ms head settling time in addition to the 5 ms access time. The cartridges sell for \$7 each in large quantities.

CIRCLE NO. 300

**Disc-drive flying head allows 500 tracks/in.**

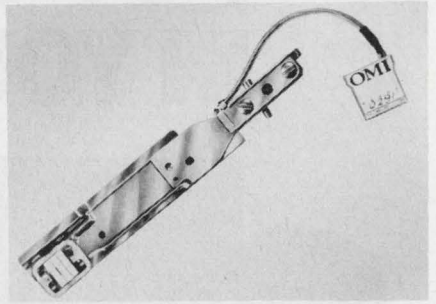

OMI Memories, Inc., 5621 W. Imperial Hwy., Los Angeles, Calif. 90045. (213) 641-7100. 2 weeks.

Over 500 tracks/in. with densities greater than 4000 bits/in. can be recorded by the model IX-150 flying head. The heads have track widths of  $0.0015 \pm 0.0001$  in., and are designed to operate at 3600 rev./min. Recording densities to  $2 \times 10^6$  bits/in. can be achieved. The heads are designed to fly approximately 45 microinches above the disc surface. Mounting configuration is compatible with standard 3330-type heads. Evaluation samples are available for delivery in two weeks.

CIRCLE NO. 301



Beautiful  
New Babies

**BOTH TRULY  
REMARKABLE**

CDI's New Baby: Series SL, Linear Slide Switch (Pat. Pending)

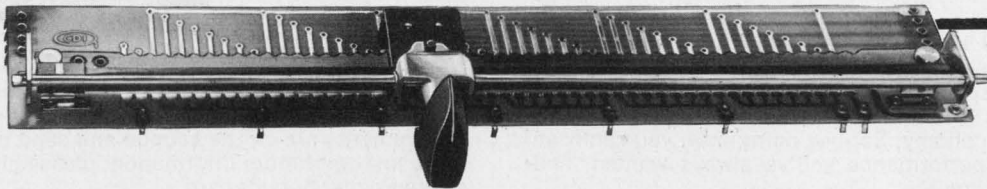

**REMARKABLE BECAUSE:**

- 1 Up to 100 or more positions (unique).
- 2 Available with solder lugs or dip solder termination for p.c. use.
- 3 Mounts EITHER left/right OR up/down (versatile).

- 4 Single or multiple position selectors.
- 5 Over 1,000,000 detents life.

**APPLICATIONS:**

- CATV channel selections.
- Column measuring.
- As an adjustable high & low limit switch, etc.

**ELECTRICAL CHARACTERISTICS:**

- 200 megohms min. insulation.
- 1000 volts min. dielectric strength.
- 2 amps @ 115 VAC current carrying capability.
- 125 ma @ 115 VAC current breaking capability.

CDI earns its reputation every day for Consistently High Quality, Consistently Good Delivery, Designing to Your Needs.



**CHICAGO DYNAMIC INDUSTRIES, INC.**

PRECISION PRODUCTS DIVISION

1725 Diversey Blvd., Chicago, Illinois 60614, Phone (312) 935-4600 TELEX 25-4689

# KEEP PACE

practical guides for designers, managers from  HAYDEN

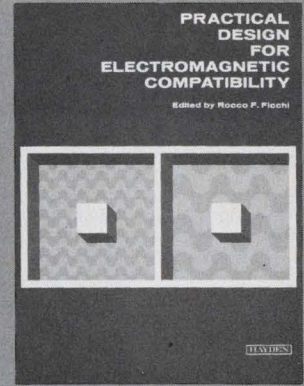
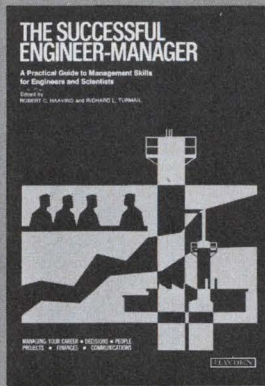

## Practical Design for Electromagnetic Compatibility

Edited By ROCCO F. FICCHI

In one convenient source, all the basic information you need to analyze, predict, control, and reduce unwanted signals. It details measurement techniques and equipment, recent advances in filtering and shielding, and fully covers the special problems encountered in computers, semi-conductors, and solid-state devices. 272 pp., 7 1/8 x 9 3/4, illus., #5685-0, cloth, \$13.95

## Durability and Reliability in Engineering Design

GILBERT KIVENSON

This thought-provoking work places at your disposal highly relevant findings from a variety of technical areas. It examines materials properties, breakdown mechanisms and phenomena, and failure modes along with steps to counter them; provides a capsule course in reliability theory; relates design considerations to the user's needs. 200 pp., 6 x 9, illus., #5851-9, cloth, \$9.95

## The Successful Engineer-Manager

A Practical Guide to Management Skills for Engineers and Scientists

Edited by ROBERT C. HAAVIND and RICHARD L. TURMAIL

A well-organized, realistic guide to the critical areas of technical management — career, decisions, people, projects, finances, and communications. Articles carefully chosen from *Electronic Design* offer you valuable pointers on financial analysis, person-to-person dealings, project scheduling, promoting new ideas, and much more. 176 pp., 7 1/8 x 9 3/4, illus., #5879-9, cloth, \$8.95

## Practical Instrumentation Transducers

FRANK J. OLIVER

You'll find virtually every known device for industrial or aerospace application covered in this complete, well-planned volume. Heavily illustrated, it reviews the state-of-the-art, clears up areas of confusion, presents pertinent data for specific applications. 352 pp., 7 1/8 x 9 3/4, illus., #5833-0, cloth, \$20.00

## 400 Ideas for Design, Volume Two

Edited by FRANK EGAN

Ranging from the ingenious to the amazingly simple, these top recent contributions to *Electronic Design's* "Ideas for Design" column are yours to use or adapt. They are gathered together by subject category for your convenience: amplifiers, design and laboratory aids, pulse, digital and control circuits, etc. 288 pp., 7 1/8 x 9 3/4, illus., #5067-4, cloth, \$11.95

## Practical Relay Circuits

also by FRANK J. OLIVER

Grouping relays by function, this time-saver will give you a rapid overview of the circuits that can solve the problem at hand. You can then check operating principles, standards, and other specifications in manufacturers' data or sources such as Hayden's *Engineers' Relay Handbook*. 384 pp., 6 x 9, illus., #5802-0, cloth, \$14.95

## Materials Science and Technology for Design Engineers

Edited by ALEX E. JAVITZ

The fundamentals of materials integrated with the hard facts of day-to-day engineering practice. The coverage offered you ranges from basic structure and behavior through new materials and applications, to environmental effects, reliability concepts, and cost effectiveness. 560 pp., 6 x 9, illus., #5640-0, cloth, \$23.95

## Advanced Electronic Instruments and Their Use

SOL D. PRENSKY

Here, fully described and illustrated, are the highly sophisticated new instruments used for sensing, measurement, and control monitoring. You'll find detailed coverage of femtometers, solid-state multimeters, digital display devices, and much more. 208 pp., 6 x 9, illus., #0796-5, paper, \$6.95; #0797-3, cloth, \$9.50

# 15-DAY FREE EXAMINATION

Please send the book(s) circled on 15-day free examination. At the end of that time, I will remit payment, plus postage, or return the book(s) with no further obligation.

5685-0    5851-9    5879-9    5833-0    5067-4  
5802-0    5640-0    0796-5    0797-3

### Save Money!

Payment Enclosed. Publisher will pay all shipping and handling charges — same 15-day guarantee.

Name \_\_\_\_\_

Firm \_\_\_\_\_

Address \_\_\_\_\_

City/State \_\_\_\_\_ Zip \_\_\_\_\_

**\$10.00 minimum for free exam orders.** Because of higher billing and collection costs, we must ask for payment in full with any order for less than \$10.00. Same 15-day guarantee.



**HAYDEN BOOK COMPANY, INC., 116 W. 14th Street. New York, N.Y. 10011**

ISBN Prefix 0-8104

72-58

# Optima Consoles: the beautiful difference.

Your product will be distinct from all others in one of these elegant enclosures. An adaptable system of instrument housings, counter and storage space. Available in many vibrant colors and finishes. Get information on the complete

line of Optima cases, consoles and racks. Write Optima Enclosures, Division of Scientific-Atlanta, Inc., 2166 Mountain Industrial Boulevard, Tucker, Georgia 30084. Or call (404) 939-6340. **OPTIMA**

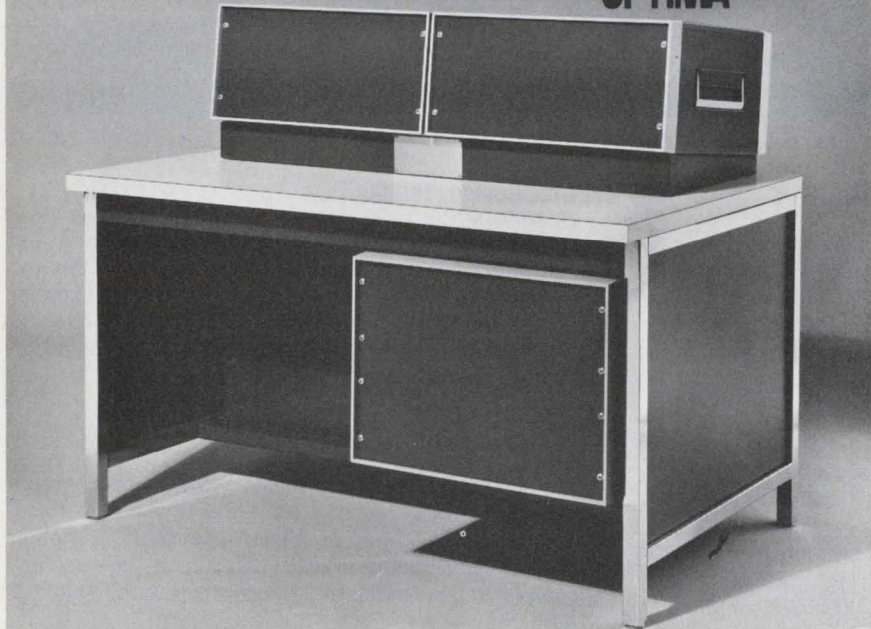

INFORMATION RETRIEVAL NUMBER 67

## MOTORS & SPEED CONTROLS



SEND FOR  
CATALOGS.

**BB**

Hundreds of different speed controls, thousands of different motors from the largest stocks in the country. From .02 to 10,000 RPM; Torques to 2000" lbs. Speed ranges to 1000:1. Immediate delivery. Low prices. Bodine, GE, Electrocraft and Superior motors. Also torque, synchronous, stepping and permanent magnet motors. A full line of power transmission components too; mechanical speed drives, clutches, brakes, couplings, indicators.  
**B&B Motor & Control Corp.**  
96 Spring Street, New York, N. Y.  
3259 Winton Road S., Rochester, N. Y.

INFORMATION RETRIEVAL NUMBER 68

## DATA PROCESSING

### Unit acts as watchdog for program errors

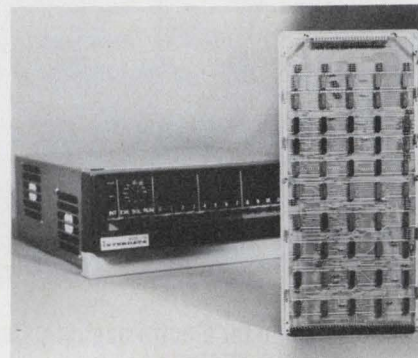

Interdata, 2 Crescent Pl., Oceanport, N.J. 07757. (201) 229-4040. \$600; April, 1973.

The entire unit consisting of controller, watchdog timer and from one to 16 nonvolatile 128-byte storage modules is contained on one 7 by 15 in. PC board. It is designed as an optional accessory for all of the company's "New Series" minicomputers. In operation the unit must be excited periodically by a software-generated output prior to a preset strappable timeout. If a program malfunction results in a failure to signal the unit before the set timeout (16 to 256 ms) then an automatic program reload will be performed from the 128-byte storage modules.

CIRCLE NO. 302

### Fault analysis added to CAD software

Softech, Inc., 391 Totten Pond Rd., Waltham, Mass. 02154. (617) 890-6900.

Performance degradation of electronic circuits in the presence of short circuits or open circuits can now be analyzed with Softech's propriety CAD program, AEDCAP. Users implement the fault analysis capability by incorporating test points in the circuit description. Such points will have two values; one representing a component failure and the other effectively removing the test point from the circuit. An arbitrary number of faults may be analyzed either one at a time or in any desired combination.

CIRCLE NO. 303

If you need  
 a high quality **3½-digit**  
 V-O-M at your price . . .  
 buy **Triplett's** new **8035**

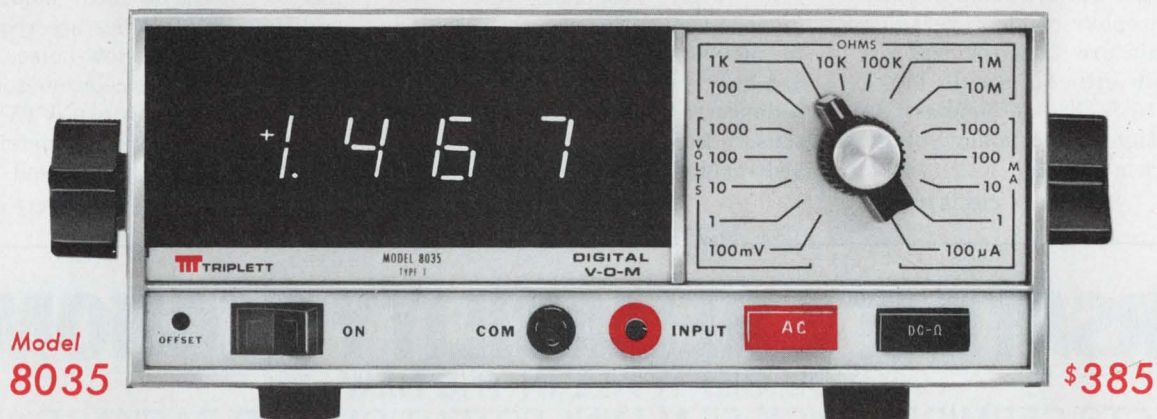

1. **EASY OPERATION** — Single polarized plug for test leads eliminates switching leads when changing functions.
2. **LOW POWER CONSUMPTION** — Less internal heating for greater stability and reliability.
3. **LOW CIRCUIT LOADING** — Greater measurement accuracy with 10 megohm input resistance for all AC and DC voltage ranges.

Designed for R&D, production, quality control, maintenance and classroom use, Triplett's new Model 8035 Digital V-O-M features an automatic polarity display, 100% overrange capability, out-of-range display blanking and high input resistance to make it nearly fool-proof.

With 26 ranges, the Model 8035 boasts accuracies from  $\pm 0.1\%$  to  $\pm 0.7\%$  of reading  $\pm 1$  digit . . . ranking it among the best on the market. Its green, polarized window and its single-plane, seven-bar, fluorescent display combine to insure bright, reflection-free readability from virtually any viewing angle.

Hardware for rack mounting is available.

See the **Model 8035**, priced at **\$385**, at your local distributor. For more information, or for a free demonstration of the convenience and accuracy of the 8035, call him or your Triplett representative. Triplett Corporation, Bluffton, Ohio 45817.

**TRIPLETT**

The World's most complete line of V-O-M's  
 choose the one that's just right for you

### Miniature power Xformer plugs into PC board

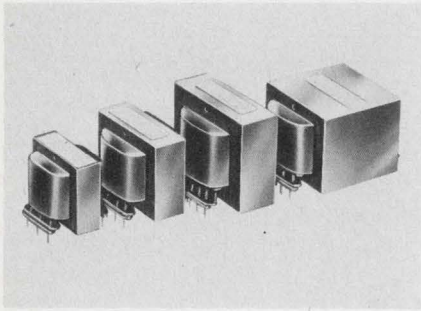

Signal Transformer Co., Inc., 1 Junius St., Brooklyn, N.Y. 11212. (212) 498-5111. Stock.

Signal's complete line of miniature plug-in power transformers run in sizes from 1 to 24 VA. They are made specifically for PC applications and are available in open-frame or epoxy-molded versions. These miniature transformers are offered with either a single 115 V or dual 115 V/230 V primary. A wide selection of secondary voltage ratings are available.

CIRCLE NO. 304

### Small torque sensor has no slip rings

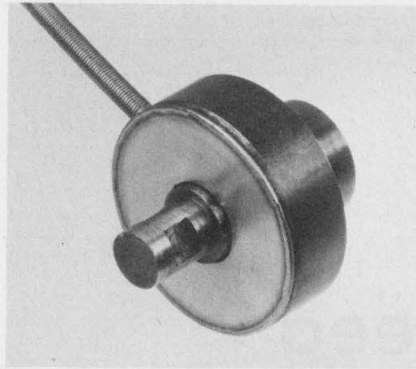

Sensotec Inc., 1400 Holly Ave., Columbus, Ohio 43212. (614) 294-5436.

The "Q" Series torque sensors do not have slip rings. They are connected directly in-line with the source of torque to be measured. And they are claimed to have a very high response rate (not given). Capacities range from 100 to 50,000 oz.-in. and sizes from 3/8 to 1-1/2 in. diameter. An impedance of 350  $\Omega$  makes these sensors compatible with all standard bridge type instrumentation.

CIRCLE NO. 305

### Piezo accelerometer is self-amplifying

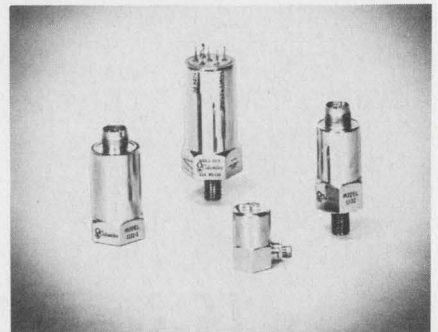

Columbia Research Laboratories, McDade Blvd. & Bullens La., Woodlyn, Pa. 19094. (215) 532-9464. \$300 to \$375; stock to 3 wks.

With over 40 different models, the 1100 Series of self-amplifying piezoelectric accelerometers offer sensitivities from 10 V/g to over 2 V/g. The frequency response is flat to 8 kHz on most models. No additional electronics are required; nor are special low-noise cables necessary. The accelerometers can operate directly into a VTVM, oscilloscope or recording instrument. Standard cable can be used.

CIRCLE NO. 306

# VERSATILITY RELIABILITY ECONOMY

## YOU GET IT ALL IN THE NEW CTS CERMIDE® THICK FILM MINI-POTENTIOMETER PACKAGE

(As low as 75¢ each in production quantities)

CTS Series 205 high power, mini pots offer immediate design versatility for instrumentation miniaturization (other applications too!) In any style you say . . . singles-duals-triples — straight or concentric tandems.

With proven CTS design features:

- 1 watt power rating • compact 5/8" diameter
- design versatility • TCR  $\pm 250$  PPM/ $^{\circ}$ C standard (lower on request)
- 50 ohms — 5 megohms • U/L approved SPST switch — 3 amp 125 vac • choice of mountings and terminals.



**CTS CORPORATION**  
Elkhart, Indiana



Write or phone  
CTS Keene, Inc., Paso Robles, Ca. 93446. Phone: (805) 238-0350.

# These digital panel meters are changing your thinking about digital panel meters.

They all operate on 5 volts DC. A new class of DPM's.

Most of your electronic systems have lots of digital logic all over the place along with 5 volts of DC to power it. We pioneered a way to use the same 5 volts to power the DPM as well.

The first thing this means is that you don't need a separate power supply just for the DPM. That saves money. It saves space. Less heat is generated. The design becomes simpler and the reliability is improved.

Then, because line-power voltage is kept away from the DPM and its inputs, internally generated noise is virtually eliminated. You get more reliable readings.

Now you can think of a DPM as a component just like any other logic component in your system.

We offer DPM's optimized for economy display applications. Like the AD2001, 3½ digits — \$89\*. The AD2002, a \$50\* 2½ digit replacement for analog meters.



Then, for system interfacing requiring exceptionally clean digital outputs, good isolation and high noise immunity, we offer the AD2003, a 3½ digit DPM with differential input CMR of 80dB and normal mode rejection of 40dB at 60Hz. All for \$93\*.

If you need 4½ digits, there's the AD2004 LED display DPM with an optically isolated analog section, and fully floating differential input providing CMR of 120dB at ±300 volts and normal mode rejection of 60dB at 60Hz or 50Hz. This one's \$189\*.

BCD outputs on all.

All small.

All given a seven-day burn-in for added reliability.

Our thinking hasn't stopped because yours hasn't either.

And our DPM's give you a lot more to think about.

Analog Devices, Inc., Norwood, Mass. 02062.

\*All prices are the 100-piece price.

 **ANALOG DEVICES**

## Call 617-329-4700

for everything you need to know about 5 volt DC powered DPM's.

INFORMATION RETRIEVAL NUMBER 71



# Select One...

One of these tachometer generators is suited to your application. We offer them in two-bearing and single-bearing versions, no-bearing overhung versions and in sealed housings for use in environments containing oil and hydraulic fluids. Outputs range from 2.6V/1000rpm to 45V/1000rpm; brush life up to 100,000 hours—that's over ten years!

FREE CATALOG of rotating components available.

Be Selective, Turn To...

**SERVO-TEK®**  
PRODUCTS COMPANY

1086 Goffle Road, Hawthorne, NJ 07506 · 201-427-3100

Servo-Tek of California, Inc.

8155 Van Nuys Blvd., Van Nuys, CA 91402 · 213-786-0690

INFORMATION RETRIEVAL NUMBER 72

## COMPONENTS

### Infrared sensor can respond to microwaves

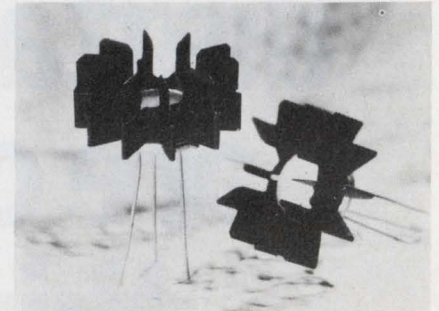

The Harshaw Chemical Co., Div. of Kewanee Oil Co., 1945 E. 97th St., Cleveland, Ohio 44106. (216) 721-8300. \$95.

Harshaw's PY5 and PY6 Pyroelectric SBN infrared sensors provide a flat response from 1 to 11  $\mu\text{m}$  for incident radiation intensities to 100 W/cm<sup>2</sup>. The sensors are protected by a T-12 infrared window to keep them clean and eliminate output fluctuations caused by air convection currents. For spectral responses into the far infrared, different window materials can be used. Without a window, the spectral response extends to the microwave region. Rise times of approximately 2 ns can be obtained.

CIRCLE NO. 307

### Slide switch provides 100 or more positions

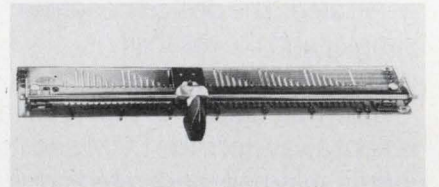

Chicago Dynamic Industries, Inc., 1725 Diversey Blvd., Chicago, Ill. 60614. (312) 943-4600. 4 wks.

Up to 100 or more positions can be incorporated into the new Series SL single or multiple-pole slide switch. It can be positioned vertically or horizontally. Electrical characteristics include 200 M $\Omega$  min. insulation resistance, 1000 V min. dielectric strength and 2 A at 115 V ac current carrying and 125 mA at 115 V ac current breaking capability. Switch life is over 1-million detents. The unit is constructed on a glass-laminate PC board and precious-metal plating and contacts are used.

CIRCLE NO. 308

NEW

## VECTOR-PAK SYSTEM SOLVES PACKAGING PROBLEMS

- CAGES NOW AVAILABLE FULLY OR PARTIALLY ASSEMBLED.
- NEW EASY-TO-ORDER NUMBERING SYSTEM.
- BUILT IN ADJUSTABILITY AND FLEXIBILITY TO SOLVE YOUR PACKAGING PROBLEMS.

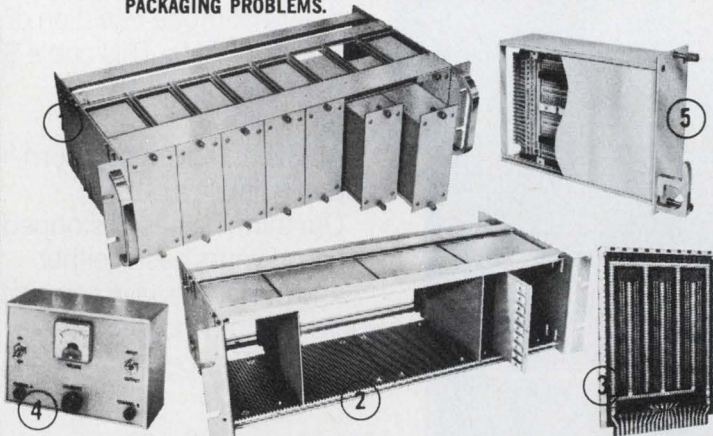

- ① Rack mountable cage and module systems available in 3½", 5¼", 8¾" heights and 9", 12", 15" depths. Immediate availability— assembled or multi purpose kit versions.
- ② Rugged Vector Pak Card Cages with extruded ABS or aluminum guides located on .15", .25", or .3" multiples.
- ③ Dozens of new Plugboards for building Plug-In Cards— IC and discrete types.
- ④ Multi-Mod Cases— sleek functional aluminum cases for instruments and other circuitry. 4 slotted interior surfaces for cards, mounting plates.
- ⑤ EFP modules in 1.6", 2", 3", or 4½" widths have slots for cards 4½" x 6½", 2.7" x 6.5", 8" x 9.6", slide off sides

Send for new specification sheets. NIMS bins and modules also available.

**VECTOR ELECTRONIC CO., INC.**  
12460 Gladstone Ave., Sylmar, California 91342  
Phone: (213) 365-9661 ■ TWX (910) 496-1539



72-2

INFORMATION RETRIEVAL NUMBER 73



# Simpson® has the world's largest selection of

## PANEL METERS and METER RELAYS

OVER 1500 RANGES, SIZES AND TYPES IN STOCK AT ELECTRONIC DISTRIBUTORS NATIONWIDE



**WIDE-VUE**  
1½", 2½", 3½", 4½", 8"

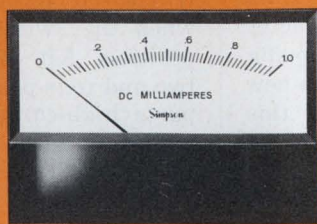

**DESIGNER SERIES**  
3½", 4½"



**NEW CENTURY SERIES**  
1½", 2½", 3½", 4½"



**BOLD-VUE**  
2½", 3½"



**RECTANGULAR**  
2½", 3½"  
round style available

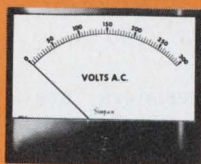

**RUGGED SEAL**  
3½", 4½", 4" x 6"

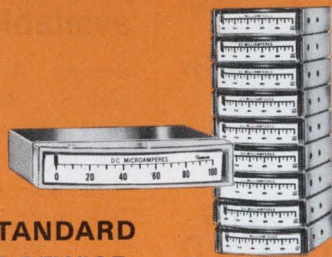

**STANDARD EDGEWISE**  
1½", 2½"

**STACKABLE EDGEWISE**  
1½", 2½"



**NEW 3½" STACKABLE EDGEWISE METER**

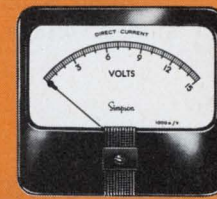

**RECTANGULAR**  
4½"



**DIGITAL**  
Model 2800



**PYROMETERS**  
4½"



**METER RELAYS**  
3½", 4½", 4" x 6"



**NEW 3½" EDGEWISE CONTROLLER**  
Many features.  
Request Bulletin C1206

- THE ABOVE PANEL METERS ARE AVAILABLE IN AC/DC VOLTMETERS, AMMETERS, MILLIAMMETERS, MICROAMMETERS . . . DC MILLIVOLTMETERS AND GALVANOMETERS . . . RF AMMETERS AND MILLIAMMETERS.

- METER RELAYS AVAILABLE IN DC MICROAMPERES, MILLIAMPERES AND MILLIVOLTS . . . AC AMPERES

- MATCHING WATTMETERS, RADIO FREQUENCY, SEGMENTAL, VU AND DB, RECTIFIER AND ELAPSED TIME METERS ALSO AVAILABLE.

- SIMPSON CAN MAKE CUSTOM PANEL METERS AND METER RELAYS TO YOUR SPECIFICATIONS. ANY PRACTICAL RANGE CAN BE SUPPLIED. SEND US YOUR REQUIREMENTS.

GET "OFF-THE-SHELF" DELIVERY FROM YOUR LOCAL ELECTRONIC DISTRIBUTOR. WRITE FOR NEW CATALOG 4100.

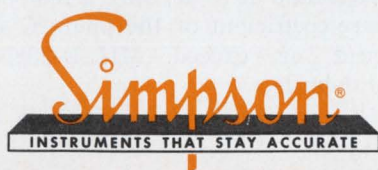

### SIMPSON ELECTRIC COMPANY

5200 W. Kinzie St., Chicago, Ill. 60644 • (312) 379-1121 • Cable: SIMELCO

IN CANADA: Bach-Simpson Ltd, London, Ontario

IN INDIA: Ruttonsha-Simpson Private Ltd, International House, Bombay-Agra Road, Vikhroli, Bombay

INFORMATION RETRIEVAL NUMBER 74



MANUFACTURERS OF THE WORLD FAMOUS SIMPSON 260®

## Fluid speed measured by counting vortices

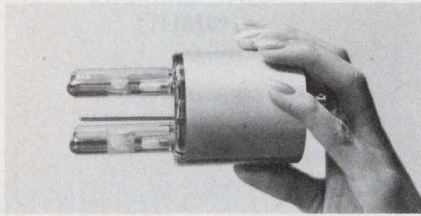

*J-Tec Associates, Inc., 317 7th Ave., S.E., Cedar Rapids, Iowa 52401. (319) 366-1843. \$990; stock.*

Using an ultrasonic technique, the Model CM 1106-B measures true fluid speed without moving parts. The sensor counts the frequency of the vortex stream formed behind a strut in the fluid flow, and is unaffected by changes in temperature, density, or depth. The frequency at which vortices are shed is directly proportional to the fluid speed. The user has a choice of either a pulse frequency or an analog voltage output.

CIRCLE NO. 309

## Coax switch handles 50 W of rf power

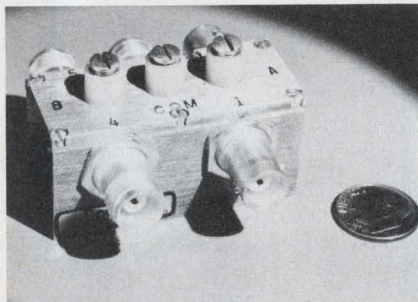

*Dow-Key Div., Kilovac Corp., P. O. Box 4422, Santa Barbara, Calif. 93103. (805) 684-4560.*

The multifunction coaxial switch, Part Number 209-101B, features two SPDT relays with a common connector in one small package with a basic size of  $2 \times 1 \times 7/8$  in. The switch is particularly designed for use in aircraft. It has a nominal characteristic impedance of  $50 \Omega$ , VSWR of 1.5:1 max at 400 MHz and an insertion loss of 0.5 dB max with 35 dB min isolation. The switch is actuated by a 26 V dc coil and the relay contacts will handle up to 50 W of rf power.

CIRCLE NO. 310

## Thermal protection unit uses solid-state sensor

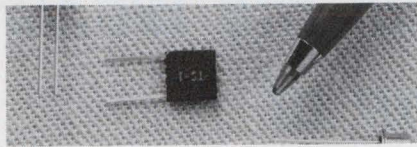

*Multi-State Devices, Ltd., 1330 Trans-Canada Hwy., Dorval 740, Quebec, Canada. (514) 683-6331. Under \$1 (OEM qty.).*

Multi-State's thermal switches for protecting circuits against overheating, cutoff at 85 C. These units use a solid-state polyconductor sensor and they have no moving contacts. They are said to be a new development for operation at this elevated temperature. Though designed primarily for electronic circuits, these switches can also be used in motor controls and automatically-controlled machines. Two styles are offered, the TS1-80 for surface mounting and the TS3-80 for feed-through mounting.

CIRCLE NO. 451

## Rotary encoder weighs only 2 oz. and is 1-3/8 D

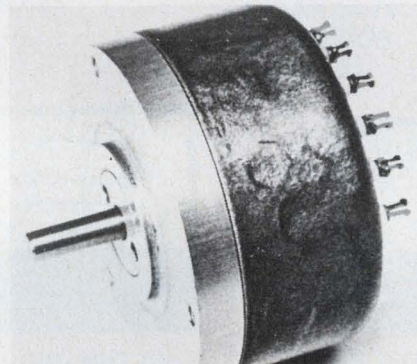

*Teledyne Gurley, 514 Fulton St., Troy, N. Y. 12181. (518) 272-6300.*

Designated the 8602-69, Teledyne's rotary encoder was designed for the electrical measurement of length, angle, speed, or position in radars, computers and measuring devices. The encoder has an accuracy of three minutes of arc. Its small weight—less than 2 oz.—and its small diameter—1.375 in.—make it suitable for any application where weight and space are critical. It is resistant to shock and vibration. Standard units provide pulse counts over a range from 1 to 1024 counts per revolution.

CIRCLE NO. 452

## Switch kit lets you try before you buy

*Switchcraft, Inc., 5555 N. Elston Ave., Chicago, Ill. 60630. (312) 792-2700. \$12.50.*

A designers' kit for designing dozens of pushbutton (Dual-Visual-Recognition) switches features continuous recognition of in and out switching positions without lamps or indicators. A black color band around the plunger indicates the out position; a brightly colored recognition cap shows when the switch is set to the in position. Kit No. K-133 includes two and four-pole DVR-2000 switch parts, high-current modules (11 A) and a selection of terminals.

CIRCLE NO. 453

## Wire-wound resistors available in DIP

*Arcidy Associates, 370 Commercial St., Manchester, N.H. 03101. (603) 668-2111. \$3-\$5 (100 up); 3-4 wks.*

Series DP-WW resistors are DIP units with up to eight precision wire-wound resistors. They are available with four to 16 pins in a variety of circuit configurations. Values range from  $0.1 \Omega$  to  $200 \text{ k} \Omega$  with tolerances to 0.02%, tolerance matching to 0.01%, temperature coefficients to 5 ppm/°C and temperature coefficients matching to within 2 ppm/°C. They are available in a variety of interconnection patterns or as independent resistors.

CIRCLE NO. 454

## Delay lines to 1000 ns packaged in 16-pin DIP

*Data Delay Devices, 253 Crooks Ave., Clifton, N. J. 07011. (201) 772-6820. \$3.50 (OEM qty.) 4 days.*

Series 1504, DIP delay lines provide a delay range from 10 to 1000 ns, impedances from 100 to  $500 \Omega$  with a  $T_d/T_r$  ratio of 5/1 in a standard 16-pin case. They can withstand 50 V dc, have a temperature coefficient of 100 ppm/°C and meet or exceed MIL-D-23859C standards.

CIRCLE NO. 455

LET ME MAKE  
ONE THING  
PERFECTLY CLEAR:

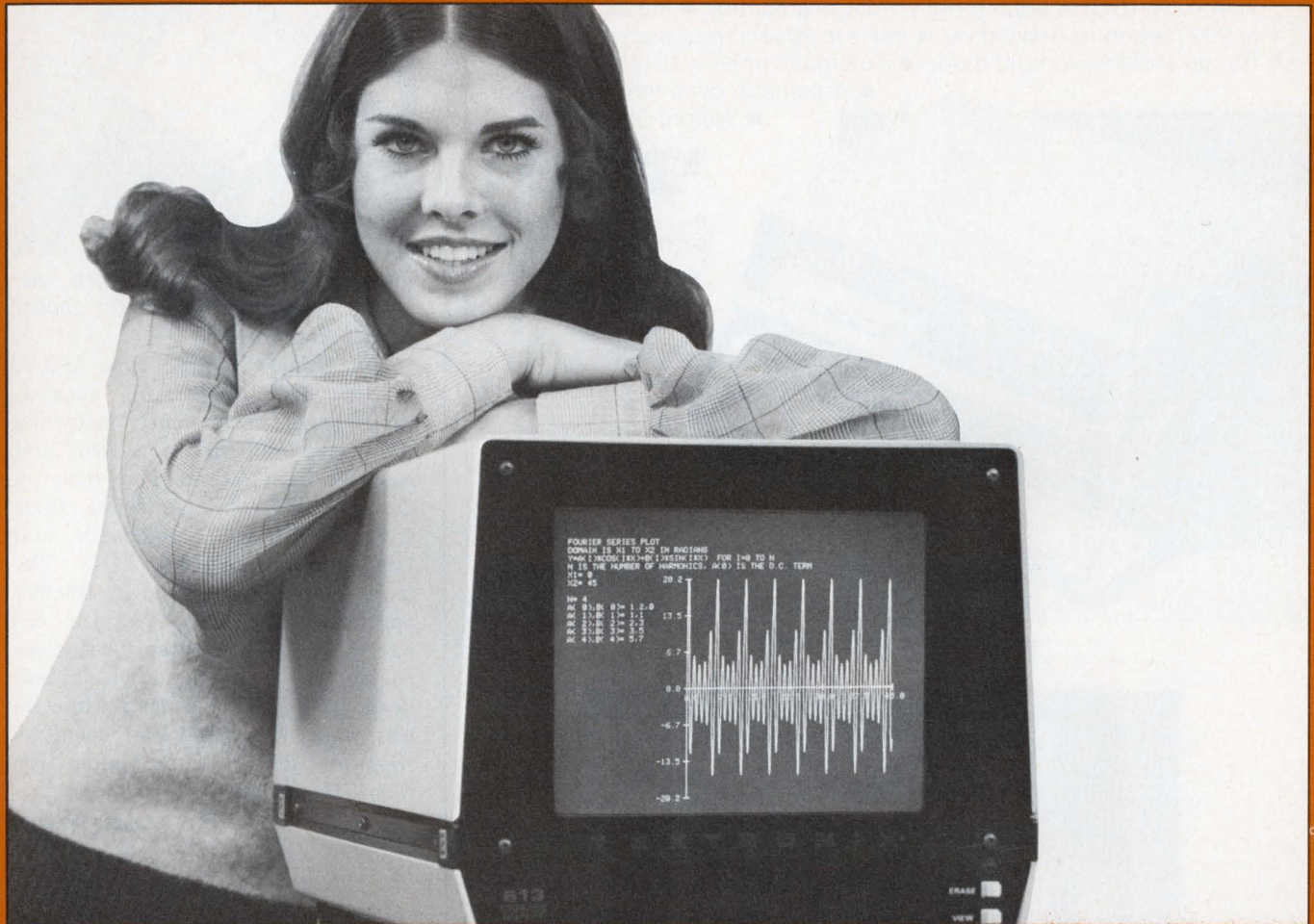

**YOU DON'T  
HAVE TO LOOK  
TWICE TO SEE  
DATA ON OUR  
NEW 613  
DISPLAY.**

On that big 11-inch screen you'll see a bright, high resolution trace. So how bright is bright? Well, it offers group viewing eight feet away with ambient lighting as high as 100 footcandles. And that's bright.

While our engineers have made a brighter display, they also found a way to help your pocketbook. The 613 doesn't use costly refresh memory devices. It uses a new Tektronix CRT which stores the image directly on the screen. That puts a 613 on your desk for only \$2,200 . . . one-third less than competitive large screen displays.

And, the new 613 is at home in a variety of applications. Use it as a computer display, medical monitor or laboratory display. It's equally at home serving as a process control monitor for engineers who need to see critical information. Or numerical control, production testing and experimental data. The 613 even shows up in management conference rooms, order processing and inventory control

locations. Name it. A highly versatile display that requires little maintenance.

Need hard copy? Just plug-in the TEKTRONIX 4610 Hard Copy Unit to the 613 and get an 8½ x 11 copy of data displayed on the screen.

There's one more thing we'd like to make perfectly clear, too: We service what we sell. And guarantee it.

Tektronix, Inc., Information Display Products Division, P.O. Box 500, Beaverton, Oregon 97005. Telephone (503) 292-2611. or Tektronix Datatek N.V. P.O. Box 7718 Schiphol Airport The Netherlands



# MIIDA MODEL 6354 3½ DMM with 0.1% DC ACCURACY.

- AUTOMATIC RANGING
- 0.1% (DC) and 0.5% (AC) voltage accuracy
- Measures to 200 megohms resistance
- 45Hz to 20 kHz frequency response
- Range and display hold mode
- Automatic polarity display
- Automatic over-range indicator
- Weight under 5 lbs.

**\$319.95**

Other Miida multimeters  
in full 4 and 4½ digits  
Distributorships available



Miida Electronics,  
a division of Marubeni America Corp.,  
2 Hammarckjold Plaza, N.Y., N.Y. 10017  
(212) 973-7152

INFORMATION RETRIEVAL NUMBER 76

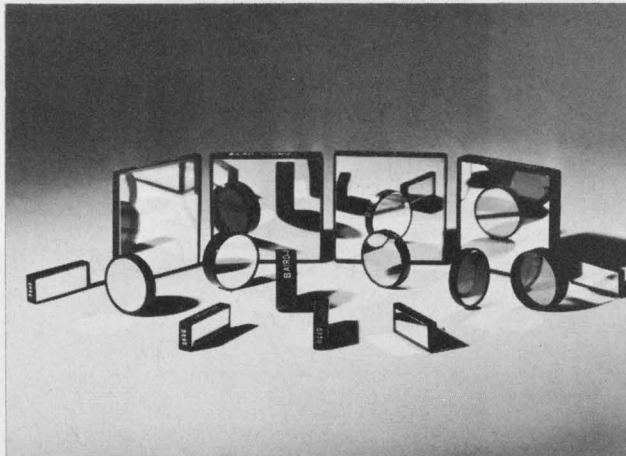

## Free Standard Optical Filters Catalog

Over 1,000 Standard Optical Filters listed with specifications and prices.

All Standard Filters are of highest quality. These filters have been carefully selected to satisfy 80% of the needs of customers who are building prototype instruments.

65% of all filters are in stock ready for immediate shipment.

Send for your copy of Catalog C-6.

**BAIRD-ATOMIC** System Components Division  
125 Middlesex Turnpike, Bedford, MA 01730  
(617) 276-6420 Telex: 92-3491

INFORMATION RETRIEVAL NUMBER 77

## COMPONENTS

### Rf relay comes with coax leads attached

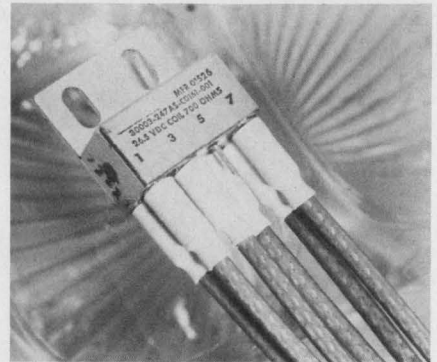

General Electric, 777 14th St.  
N.W., Washington, D. C. 20005.  
(202) 393-3600.

Half-size rf relays, Type 3SAV, feature 50-Ω, RG 316U coaxial-cable leads permanently attached for extra-low insertion loss and ease of installation. The relay is designed for transmission lines with 25 to 70-Ω impedance and frequencies under 500 MHz. The main contacts are rated at 100,000 operations to 75 W carrying capacity and 10 W interrupting capacity. Contact resistance is less than 0.050 Ω, operating time is less than 4 ms and coil sensitivities are 260 mW maximum for form D models.

CIRCLE NO. 456

### Small magnetic sensor provides high output

Electro Corp., 1845 57th St., Sarasota, Fla. 33580. (813) 355-8411.

Very compact, Electro's new magnetic sensor has a stainless-steel shell that measures just one inch in over-all length, and it mounts with a 1/4-40 thread. The unit, Model Number 3050, was developed expressly for computer peripheral use in timing and synchronization applications. It supplies a minimum of 12 V peak-to-peak at 1000 in./s with a 20-pitch, 30-tooth gear at 0.005-in. clearance and with a load of 100 kΩ. The sensor's output is stable over a temperature range from -100 to +225 F.

CIRCLE NO. 457

# Fill out this coupon:

Mail to: Hewlett-Packard,  
1501 Page Mill Road,  
Palo Alto, California 94304



Name \_\_\_\_\_

Company \_\_\_\_\_

Title \_\_\_\_\_

Address \_\_\_\_\_

City \_\_\_\_\_ State \_\_\_\_\_ Zip \_\_\_\_\_

## and we'll throw the book at you.

**We'd like to send you our new booklet on how HP's high-precision universal counters can help you make better time interval and frequency measurements.**

HP's 5326/5327 Series of counters offer you unmatched flexibility and versatility for a wide variety of applications. But best of all, you can get the exact counter you need without paying for a lot of extras.

For example, you can get frequency ranges to 50 MHz or to 550 MHz. You

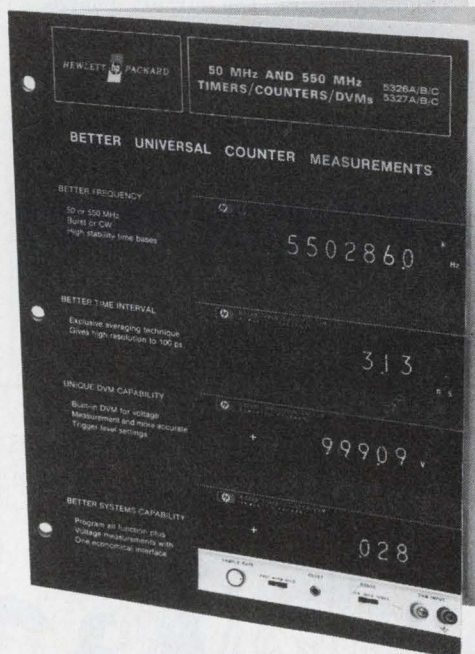

can get a counter with or without time interval averaging which can let you measure short time intervals faster and cheaper than ever before.

Or you can get a counter with or without a built-in DVM for more accurate and more convenient time interval measurements. And these counters feature a higher input sensitivity and high-accuracy time bases that have FCC-type approval.

And that's not all. HP gives you the most complete systems interface at the lowest cost. That means you can have the most ideal systems counter available anywhere. In fact, these counters are so versatile you can get almost any combination you need. Prices start as low as \$995.

Fill out the coupon and we'll rush you a copy of our new brochure which spells out the story in more detail. Or write: Hewlett-Packard, 1501 Page Mill Road, Palo Alto, California 94304; Europe: P.O. Box 85, CH-1217 Meyrin 2, Geneva, Switzerland; Japan: Yokogawa — Hewlett-Packard, 1-59 1, Yoyogi, Shibuya-ku, Tokyo, 151.

02209

HEWLETT  PACKARD

## LED drivers eliminate external resistors

*Precision Dynamics Corp. Electronics Div., 3031 Thornton Ave., Burbank, Calif. 91504. (213) 845-7606. \$2.75 to \$3.55 (100-999).*

The NOVA 5000 Series current-limiting LED drivers eliminate external resistors in driving seven-segment LED or filament displays. Constant current is delivered by the 20 mA devices as long as output voltage is maintained above 1.25-V dc. This allows single or double diode displays to be driven directly. A built-in quad latch allows displayed information to be held, while data input is either removed or changed. Ripple-blanking logic provides for suppressing of excess zeros. Six separate models come in standard 16-pin DIP.

CIRCLE NO. 458

## Compact keyboards offer current-sinking outputs

*Micro Switch Div. Honeywell, Inc., 11 W. Spring St., Freeport, Ill. 61032. (815) 232-1122. Stock.*

The solid-state 12-key (12SW) and 16-key (16SW) keyboards have current-sinking outputs for compatibility with TTL and DTL. The keyboards permit greater fan out, since each key switch offers two isolated outputs rated at 3.2 mA (outputs may be wired in parallel to sink 6.4 mA). Both keyboards are available with either level or pulsed outputs. The small Hall-effect keyboards have been designed for end-to-end mounting, and have standard 3/4-in. key spacing.

CIRCLE NO. 459

## Miniature amplifier inserts into microstrip



*Optimax, Inc., P.O. Box 105, Colmar, Pa. 18915. (215) 822-1311. \$75; stock.*

The AH-52 is a miniaturized modular amplifier designed for direct insertion into microstrip circuitry. The unit operates from 10 to 500 MHz and has a nominal gain of 14 dB at 16-V dc. A major feature is the high reliability—MTBF of  $1.44 \times 10^6$  hrs per MIL-HDBK-217A. Other specs include a noise figure of 5 dB and an output power, at 1-dB gain compression of +10 dBm.

CIRCLE NO. 460

## Power supplies slip into card cage

*Mohawk Industries, Inc., 73 N. Second St., Easton, Pa. 18042. (215) 252-0968. \$86; stock.*

Designated as Series 3127, these power supplies slip into a card cage alongside the circuit boards, thus eliminating all of the problems associated with cable routing, installation and noise. Eleven models are available from stock. Specs include: input voltage of 105 to 130 V ac, 50 to 60 Hz; output voltage adjustable and floating from 4.4 to 28.6 V dc; line and load regulation of 0.05%; ripple and noise less than 1.5 mV rms; and tc of 0.01%/°C.

CIRCLE NO. 461

## A/d converter features 300-ps aperture time

*Inter-Computer Electronics, Inc., Subsidiary of American Electronic Laboratories, Inc., P.O. Box 507, Lansdale, Pa. 19446. (215) 822-2929.*

The Model IAD-2208 a/d converter system is designed for wide bandwidth data processing and data acquisition systems. The unit features 300-ps aperture time, eight-bit resolution at conversion rates up to 5 MHz, and an accuracy of  $\pm 0.2\%$  of full scale  $\pm 1/2$  LSB. The Model IAD-2208 includes sample-and-hold, a/d encoder system timing and decoding, and power supplies. It operates either asynchronously from an internal clock, or synchronously from an external signal source.

CIRCLE NO. 462

## 4-digit decade counter costs just \$79

*Display Electronics, P.O. Box 1044, Littleton, Colo. 80120. (303) 781-7922. \$79; stock to 30 days.*

The CM Series modules include a decade counter, latch, decoder-driver, and readout for each digit. Standard modules are available with from two to six digits. All ICs are 7400 series TTL. Minimum counting rate is typically 18 MHz. The modules operate over a temperature range of 0 to 70 C. Lamp test and zero blanking functions are provided. A single 5 V dc power supply is required. The readout tube is a seven-segment, incandescent type with a character nearly 1/2-inch high. A polarizing filter is furnished with each module.

CIRCLE NO. 463

**ANA & LOG**

SPIKE PROMISES ME A REAL SWINGING TIME ON HIS CHOPPER, LOG.

BE SURE YOU WEAR YOUR HELMET.

WITH ALL THAT NOISE, RIDING ON THE SIDEWALK...AND HE'S GOT A CREW CUT!!

THAT'S THE OLD GENERATION ANA, NOW MY NEW 188 IS QUIET AND...

**ANALOGY:**  
INTECH HAS A GREAT SUBSTITUTE FOR THOSE OLDER, GENERATION CHOPPER AMPLIFIERS. IT'S THE A-188 WITH LESS THAN 0.5µV p-p NOISE, 0.5µV/°C DRIFT. IT OPERATES BOTH INVERTING OR NON-INVERTING. SMALL PACKAGE. LOW COST. WANNA SEE A GOOD CHOPPER SUBSTITUTE? WRITE ANA'S BOYS.

**intech** INCORPORATED  
(408) 244-0500  
1220 COLEMAN, SANTA CLARA CA 95050

We've something new  
lined up for you

# 4 to 8 GHz YIG-Tuned Transistor Oscillators

Now from Watkins-Johnson: YIG-tuned transistor oscillators with fundamental frequency coverage from 4 to 8 GHz.

These solid state oscillators, members of the WJ-5154 series, are already in use in MIL-qualified receiver systems. They provide the same low noise and linear tuning performance as the rest of the W-J YIG oscillator line, which spans 500 MHz to 20 GHz.

For more details on the WJ-5154 series of YIG-tuned oscillators, contact our Field Sales Office/Representative in your area or call Watkins-Johnson Applications Engineering at (415) 493-4141.

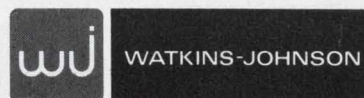

3333 HILLVIEW AVE., STANFORD INDUSTRIAL PARK, PALO ALTO, CALIF. 94304 • (415) 493-4141

United Kingdom: Shirley Ave., Windsor, Berkshire SL4 5JU, England • Tel: Windsor 69241 • Cable: WJUKW-WINDSOR • Telex: 847578  
West Germany: 8033 Planegg, Muenchenerstr. 17 • Tel: (0811) 71 36 57 • Cable: WJDBM-MUENCHEN • Telex: 528401  
Italy: Piazza G. Marconi, 25 00144 Rome-EUR • Tel: 59 45 54 • Cable: WJROM-ROMA • Telex: 60117



### Crystal oscillator is miniaturized



Scientific Research Corp., Sub. of Trak Microwave Corp., 4722 Eisenhower Blvd., Tampa, Fla. 33614. (813) 884-1411. \$350; 6-8 weeks.

The 5044-1006 is a complete crystal-controlled oscillator in a 1.33 × 1.33 × 0.35-inch package. It is said to be the smallest self-contained 920 to 1200-MHz crystal-controlled oscillator on the market today. The unit has a center frequency accuracy of ±0.0005%. Stability is ±0.002% from -40 to +70 C. Nonharmonically related spurs are 45-dB down, with harmonics 30-dB down. Power output is +7 dBm ±1.5 dB into a 50 Ω load. The 5044-1006 mounts on a PC board and requires +15 V at 60 mA.

CIRCLE NO. 464

### Counter displays are complete decades

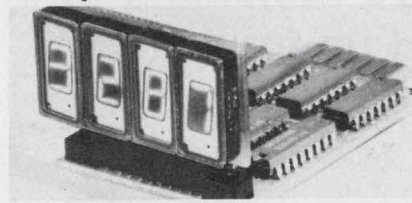

Instrument Displays, Inc., 225 Crescent St., Waltham, Mass. 02154. (617) 894-1577. \$80 ea. (25 four decade units); 2 wks. ARO.

Instrument Displays announces its new series of Counter Displays: a compact assembly of two to six decades in a single unit, with a readout character height of 3/8 inch. The readout uses 8 mA per segment, and has a brightness level of 700 FL at 5 V dc. The unit is available completely packaged, with bezel, filter and housing, or as a separate component. The readouts are mounted on a plug-in card and the entire package for a four-digit unit takes less than 2 in. of panel width, and is 1-3/8-in. high. Input is in TTL form at up to 10 MHz. Reset to 0, and 5 V dc inputs are on a single rear connector.

CIRCLE NO. 465

### 7-segment LED display offers cost savings



Fairchild Semiconductor Components Group, 464 Ellis St., Mountain View, Calif. 94040. (415) 962-3816. \$3.95 (100s).

The FND-70 1/4-inch-high digits are said to be approximately half the price of other quarter-inch LED displays. The unit uses only one LED per display segment. A molded plastic light pipe converts the spot of light into a uniform bar segment. A "fly's eye" lens (consisting of multiple convex lenses) on the display surface diffuses the light to provide bright displays over a viewing angle of 140°. The 10-lead DIP measures only 0.550 × 0.335-inch. Thus, four digits require no more panel space than three conventional 1/4-inch displays. The FND-70 uses a common cathode and operates at 10 to 25 mA per segment.

CIRCLE NO. 466

## Introducing the expensive dual-trace scope that doesn't cost a lot.

The B&K Precision Model 1470.

The compact 5-inch solid-state 1470 is specially designed to meet 80% of all your scope applications.

It has DC to 10 MHz bandwidth with 10 mV/cm sensitivity. Sixteen triggered-sweep speeds range from 1 μsec/cm to 0.2 sec/cm. Triggers on input signals as low as 5mV.

Sound good? Our prices become even more remarkable once you see our specs.

Call your B&K distributor. Or write Dynascan Corporation.

Very good equipment at a very good price.



Product of Dynascan Corporation  
1801 West Belle Plaine Avenue, Chicago, Illinois 60613

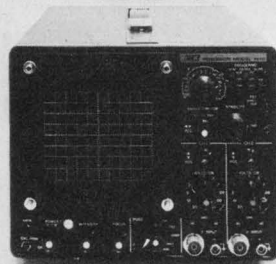

**\$499<sup>95</sup>**

## sapphire substrates

.000000" surface finish variation in Meller's high quality, in-stock substrates make them ideal for SOS, hybrid micro-circuitry, delay lines, etc.

The substrates feature high and uniform resistivity and have a scratch-free surface finished (up to 70X magnification), obtained using a special polishing method. Both x-ray and random orientation are available.

For more information, contact ADOLF MELLER CO., P.O. Box 6001, Providence, R.I. 02904. Tel: 401-331-3717.





# Are you one of the 326 that won't get the message?

You are if you received  
a copy of  
the Monsanto  
Silicon Evaluation  
Standards Manual  
and haven't sent us  
your registration card.

We are about to release the first major revision and addition to this highly informative "bible" covering materials handling and evaluation techniques. The problem is, we know we have distributed over 750 copies of the manual, but we have only 423 names on file to receive the revisions and additions.

So, if you have an original copy of the Monsanto Silicon Evaluation Standards Manual and it still has its registration card intact, please fill in the required information and mail it to us today. If the original registration card is missing, just send us your name and address on company letterhead. We'll see to it that you receive this valuable update.

**NOTICE!!** Additional copies of the Manual are still available from Monsanto at \$25.00 each. They will be mailed postpaid with the new material included.

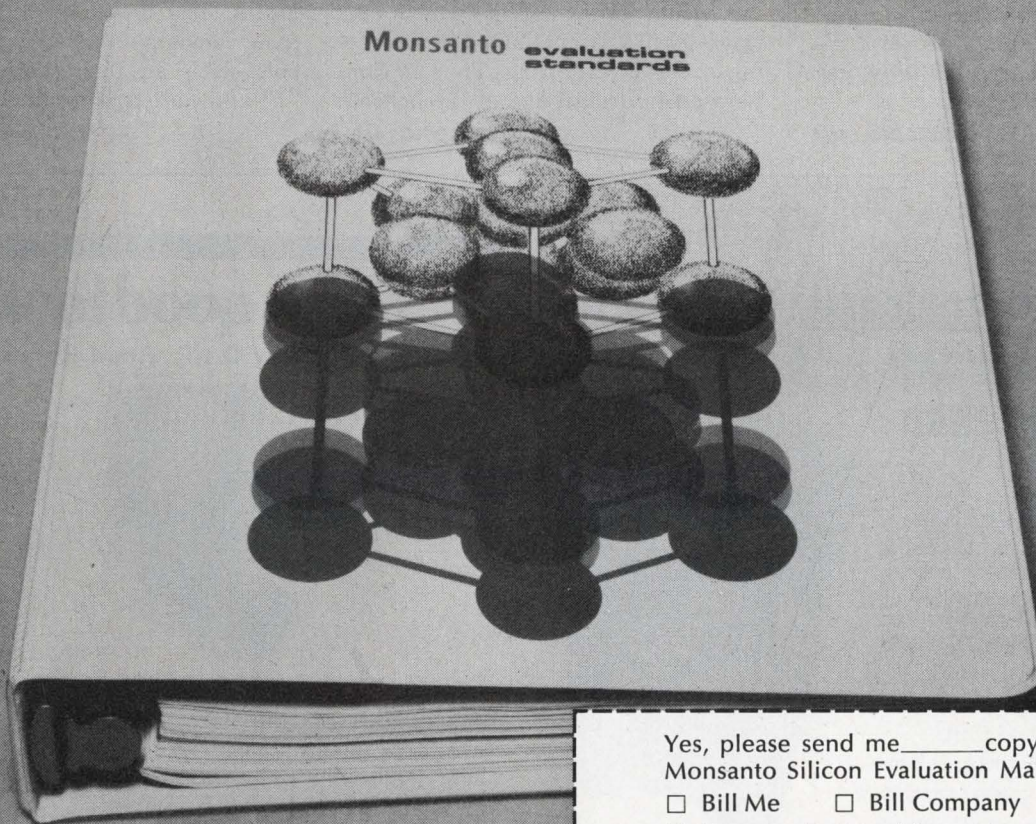

Order now. From the people  
who know more about  
silicon than anybody.

## Monsanto

Electronic Materials

P.O. BOX 8, ST. PETERS, MISSOURI 63376 (314) 272-7676

Yes, please send me \_\_\_\_\_ copy(ies) of the  
Monsanto Silicon Evaluation Manual

Bill Me     Bill Company  
 Payment Enclosed \$ \_\_\_\_\_

Name \_\_\_\_\_ Title \_\_\_\_\_

Company \_\_\_\_\_

Address \_\_\_\_\_

City \_\_\_\_\_ State \_\_\_\_\_ Zip \_\_\_\_\_

MAIL TO: **Monsanto Electronic Materials**  
P.O. Box 8, St. Peters, Mo. 63376  
Attn: Carl Moskowitz

## Module converts synchro to linear output

*Transmagnetics, Inc., 210 Adams Blvd., Farmingdale, N. Y. 11735. (516) 293-3100. \$595; stock to 5 wks.*

Transmagnetics, Inc., announces the availability of their Series B678 synchro to linear dc converters which are compact solid-state units that convert all standard synchro or resolver inputs to a linear dc voltage proportional to the input shaft angle. Accuracies to  $\pm 6$  minutes at 25 C and  $\pm 10$  minutes over  $-55$  to  $+85$  C are now available. This series offers infinite resolution, does not require adjustment of any kind, is short-circuit proof, is available either for PC-board mounting or connector termination, and all units are fully transformer isolated. All models are hermetically sealed and can be supplied to meet or exceed MIL-E-16400. The units are said to be low profile and lightweight.

CIRCLE NO. 467

## Small pulse generator tests CMOS circuits

*American Laser Systems, Inc., 3888 State St., Santa Barbara, Calif. 93105. (805) 687-1212. \$125.00; stock.*

The Model 727 CMOS-compatible pulse generator offers frequencies from 1 Hz to 1 MHz, and pulse-widths from 1  $\mu$ s to 100 ms. Additionally, a level detector, a noncapacitive differentiator, a NOR gate, a D flip-flop, and a pushbutton are provided. Q and  $\bar{Q}$  outputs and complementary inputs allow the synthesis of a wide range of digital functions. When powered by the circuit under test compatible test waveforms are assured, eliminating the possibility of damage to CMOS inputs. This makes it ideal for troubleshooting or for use in built-in test equipment. When powered from its own supply (3-15 V), up to 50 mA is available for powering external circuitry. Thus it can be used in design and at the bench.

CIRCLE NO. 468

## Seven-segment display interfaces with MOS

*Sperry Information Displays, P.O. Box 3579, Scottsdale, Ariz. 85257. (602) 947-8371.*

Eight new seven-segment planar gas discharge displays have been added to the company's line. The SP-330 Series (1/3-in.) and SP-350 (1/2-in.) units are for interfacing with MOS/LSI and for use in dc or multiplexed applications, with or without suppressed (blanked) zeros. The units offer improvements over previous displays. A keep-alive cathode provides an internal ion source that reduces reionization time to less than 30  $\mu$ s, allows zero suppression and improves operation in dark environments and at low temperatures. The units in both of the series come in 1-1/2, 2, 3, and 2-1/2 digits. The one-half digit in each case consists of plus/minus symbols with an over-range numeral "1" and an extra decimal point.

CIRCLE NO. 469

## Now, an enclosed rotary switch for less than \$2.50!\*

Step up to Grayhill quality. Specify an enclosed rotary switch at prices lower than those for many open wafer switches.

Look what's included in a one deck, enclosed Series 71 \$2.35 switch.\*

- Positive detent
- Molded in terminals
- 30° or 36° angles of throw
- Over 100 grams contact force

You can also specify switches in the same series with 1-12 decks, 1-6 poles per deck.

It all adds up to a longer life for Grayhill switches, which means lower operating costs for your customers.

For more details on this and all Grayhill products, write for our newest Engineering Catalog. Grayhill, Inc., 565 Hillgrove Avenue, La Grange, Illinois 60525. (312) 354-1040

\* In quantities as low as 100.

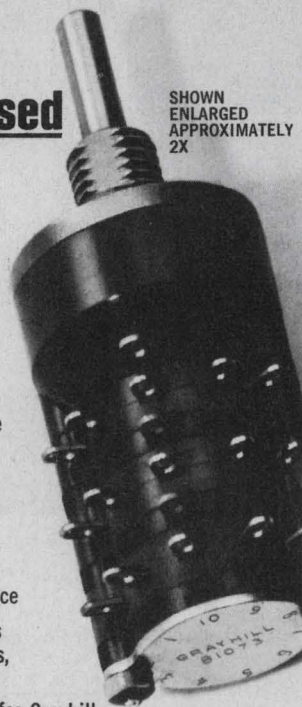

SHOWN ENLARGED APPROXIMATELY 2X

## Take a good look!

Hathaway D.I.P. Reed Relay



There's no reason why you can't have the dual advantages of Hathaway quality and prices on D.I.P., or mixed, reeds. Hathaway reeds are interchangeable with your present types and meet all of the quality industry standards. Next time your annual buy is up, take a good look at Hathaway.

Send for the Hathaway Drireed Switches catalog to get the specs, and ask for samples.



# HATHAWAY

c o m p o n e n t s

A HATHAWAY INSTRUMENTS INC. COMPANY

P. O. BOX 45381 • SOUTHEAST STATION • TULSA, OKLAHOMA 74145

PHONE: (918) 663-0110

TWX 910-845-2129

INFORMATION RETRIEVAL NUMBER 86

ELECTRONIC DESIGN 1, January 4, 1973

# Kick the habit with KEMET<sup>®</sup>

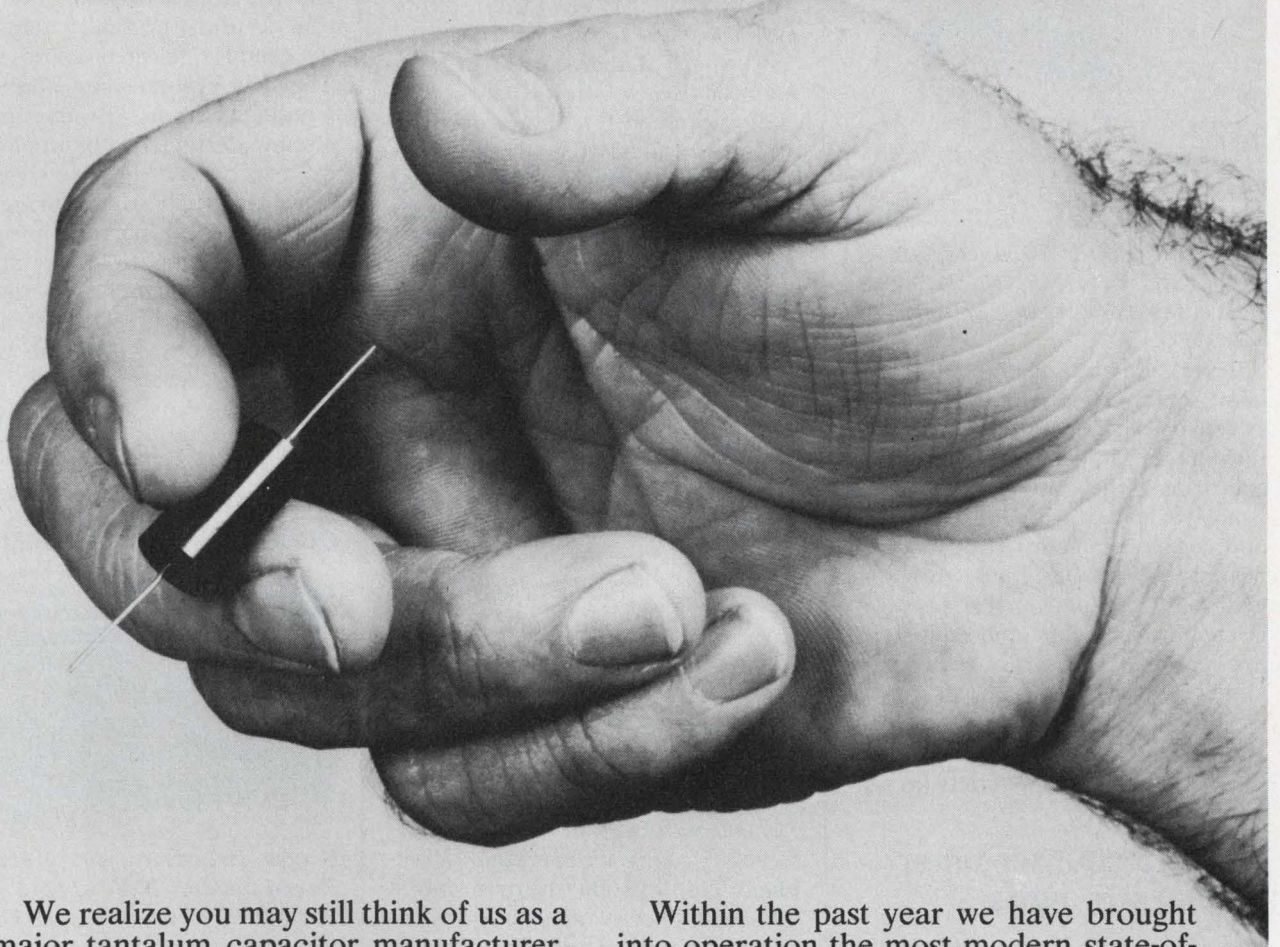

We realize you may still think of us as a major tantalum capacitor manufacturer. And that's fine. But it's time you also thought of us as a major supplier of ceramic capacitors.

For, in fact, that's what we are. From zero several years ago we have come on with a full product line of KEMET<sup>®</sup> stable K, NPO and MIL approved CK and CKR radial and axial-leaded ceramic capacitors. So much so, in fact, that KEMET Ceramics will be on the first Mars landing.

And we've created "Solder Guard", a new generation ceramic chip capacitor with a unique copper barrier layer in the end metallization that prevents silver leaching and scavenging problems during solder reflow operations.

Within the past year we have brought into operation the most modern state-of-the-art, automated ceramic capacitor production plant in the industry. A plant designed from concept to completion to build in product reliability through automation and precision process control.

With all that, KEMET ceramic capacitors are the best money can buy. And that's no bull!

So kick the habit. Think of KEMET for quality, price, and delivery when you specify or order ceramic capacitors.

Write us for complete information at P.O. Box 5928, Greenville, South Carolina 29606, Phone 803-963-7421.



COMPONENTS DEPARTMENT

## Scope gives triggered or recurrent sweep

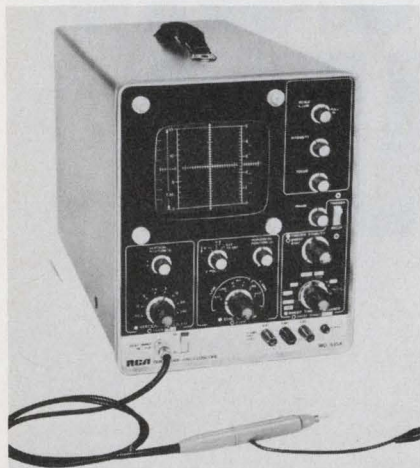

RCA Distributor Products, 415 S. Fifth St., Harrison, N. J. 07029. (201) 485-3900. \$329 (optional resale price).

This solid-state dual-mode scope offers both triggered or recurrent sweep operation at the touch of a button. In addition to dual-mode operation, the WO-535A has a usable bandwidth of dc to 10 MHz and comes complete with probes at no extra cost. Designed with special features for general purpose, electronic servicing and industrial applications, the scope requires a signal of only 5.9 mV pk-pk for 1-cm of deflection on the high-sensitivity range.

CIRCLE NO. 470

## 50-MHz counter-timer displays 6 digits

United Systems Corp., Subsidiary of Monsanto, 918 Woodley Rd., Dayton, Ohio 45403. (513) 254-6251. \$695.

A 50-MHz full-function counter-timer, Model 101C, has been released by Monsanto. This new counter features a standard six-digit display, time base stability to one part in  $10^8$  per day, BCD outputs for system compatibility and a sensitivity of 50 mV rms. Additional features include an adjustable display time with storage, two amplifiers with individual trigger controls and parallel inputs front and rear, and FCC type approval No. 3-174 for frequency monitoring.

CIRCLE NO. 471

## Digital panel clock is system oriented



Newport Laboratories, Inc., 630 E. Young St., Santa Ana, Calif. 92705. (714) 549-4914. \$275; 3 wks.

Newport Laboratories has announced a new digital clock especially designed for data acquisition systems. Called the Series 6700, these panel instruments display time-of-day in four models ranging in full scale from 12 hours to 99 days. System BCD outputs are gated and buffered. Time base is derived from 50 or 60-Hz power lines. Two crystal oscillator time base options permit operation in areas where the line frequency is not sufficiently accurate. In the event of power failure, an indicator lights when power returns while the clock display resets to all zeros.

CIRCLE NO. 472

## Backplane test system programs itself

Teradyne, Inc., 183 Essex St., Boston, Mass. 02111. (617) 482-2700. \$25,000 up; 12 wks. ARO.

This computer-operated Backplane Test System requires only a two-cable interconnection to the backplane under test. The N151 is self-programming and will record all shorts and opens, in the user's nomenclature, on either a CRT display or a printer. Magnetic-tape cartridges are used for program storage. Operation involves five keyboard commands—to analyze, test, print out a master connection list, store programs in memory, and edit programs. In normal use, a prototype or backplane known to be good is first connected to the system, which automatically "learns" the network. When production backplanes are tested, the system records all wiring errors instantly on the CRT display. Hard copy may also be obtained.

CIRCLE NO. 473

## Automatic test system isolates IC faults

Texas Instruments Inc., Digital Systems Div., P.O. Box 1444, Houston, Tex. 77001. (713) 494-5115. \$50,000 and up.

The ATS-960 is a computer-controlled system for testing of ICs and PC boards. The system is intended for those who test a diversity of production modules: It tests digital, analog and hybrid circuits, and provides automatic fault isolation to pinpoint faulty components in complex electronic assemblies. The new system uses English language programs. Production tests on new designs can be implemented by merely writing a new program. Operating in a timesharing mode, the system can perform production testing of up to four different kinds of assemblies at the same time. The test system instructs the operator each step of the way via its display screen.

CIRCLE NO. 474

## DPM features 0.05% accuracy, 3-1/2 digits



Gralex Industries, 155 Marine St., Farmingdale, N.Y. 11735. (516) 694-3607. From \$95; stock to 2 wks.

The Gralex Model 36 bipolar 3-1/2-digit DPM features 0.05% accuracy with negligible warmup time, 50 ppm/°C stability over a 0 to +50 C operating range, and a full one-year warranty. Offered in two autopolar ranges ( $\pm 1.999$  V or  $\pm 199.9$  mV, F.S.), the Model 36 has a floating differential input which provides  $> 1000\text{-M}\Omega$  input impedance and  $> 70\text{-dB}$  CMR. The Model 36 features a choice of seven-segment planar or Nixie display, with 1/2-in. numerals. Autopolarity, automatic blanking, and programmable decimal points are included at no extra cost. BCD outputs are standard.

CIRCLE NO. 475

# Complete RF Network Analysis for S-PARAMETERS

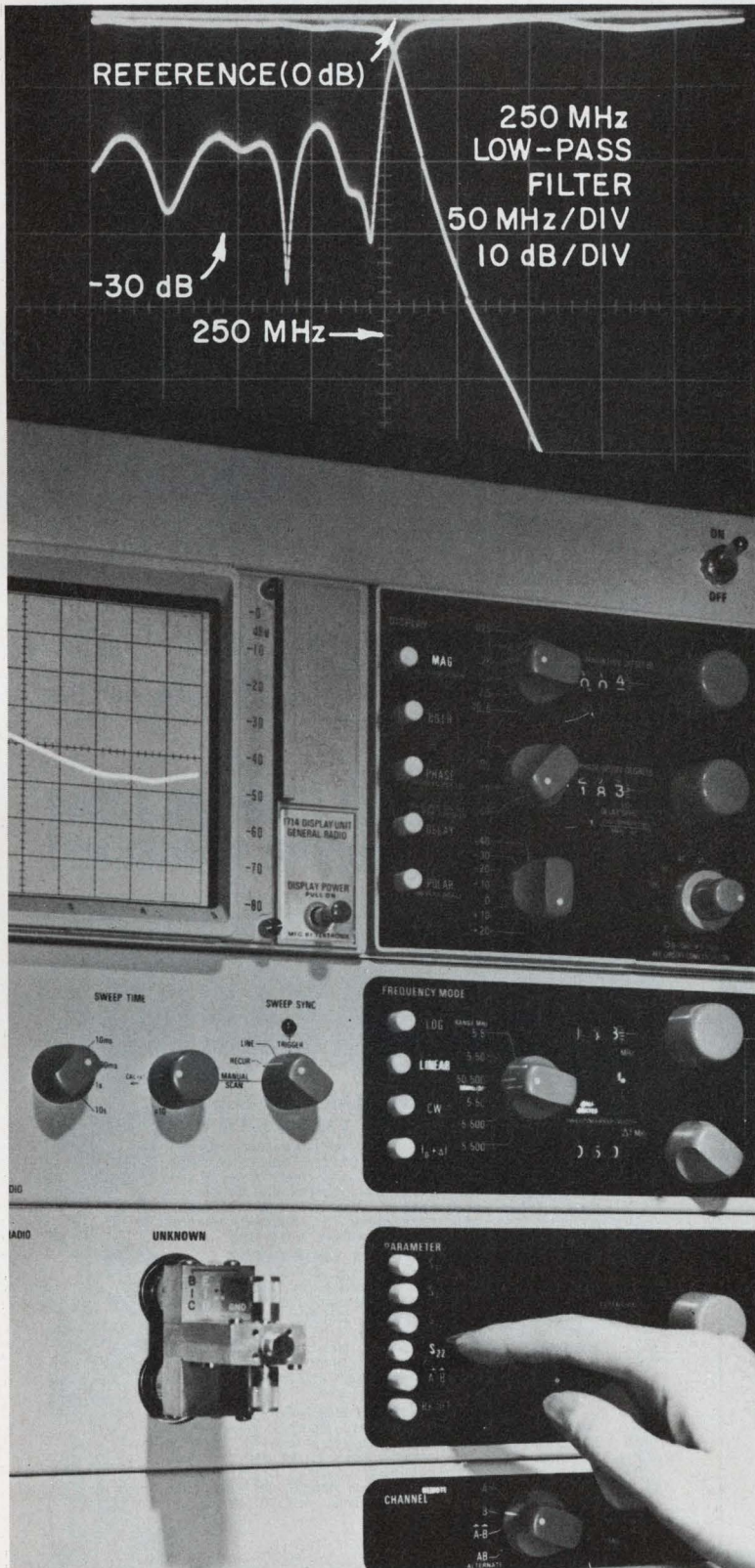

**YOUR** parameter — simply selected by pushbuttons for forward or reverse transmission characteristics ( $s_{21}$  or  $s_{12}$ ), input or output reflection characteristics ( $s_{11}$  or  $s_{22}$ ),  $s_{21}$  and  $s_{11}$  or  $s_{12}$  and  $s_{22}$  simultaneously, or the vector difference of any two transmission parameters or any two reflection parameters.

**YOUR** accuracy — carefully preserved by a built-in adjustable line stretcher to eliminate lead-length errors, by a well-designed means of inserting external bias with a minimum of measurement degradation, and by a totally integrated design to reduce system uncertainties.

**YOUR** device — easily interfaced by a variety of transistor mounts, a large selection of adaptors, and a broad line of accessories to suit nearly any requirement.

**YOUR** solution — the 1710 RF Network Analyzer fully equipped for s-parameter measurements from 400 kHz to 500 MHz with 115-dB dynamic range and 0.005-dB resolution, only \$9700 from General Radio.

**OUR** pleasure.

 **General Radio**

300 BAKER AVENUE, CONCORD, MASSACHUSETTS 01742  
• NEW YORK (N.Y.) 212 964-2722, (N.J.) 201 791-8990 • BOSTON 617 646-0550 • CHICAGO 312 992-0800 • WASHINGTON, D.C. 301 948-7071 • ATLANTA 404 457-2485 • DALLAS 214 234-3357  
• LOS ANGELES 714 540-9830 • SAN FRANCISCO 415 948-8233 • TORONTO 416 252-3395 • ZURICH (01) 55 24 20  
• GR COMPANIES • Grason-Stadler • Time Data • Techware Computing Corp. • GR ASSOCIATE • Micronic Systems Inc.

INFORMATION RETRIEVAL NUMBER 89

**Data generators zip along at 300 MB/s**

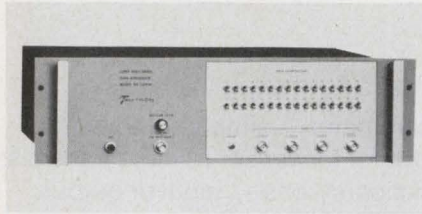

*Tau-Tron, Inc., 685 Lawrence St., Lowell, Mass. 01852. (617) 458-6871. From \$4365. 2-4 weeks.*

The two members of the DG-525 series are said to be the world's fastest programmable data generators: They operate from one bit/s to over 300 MB/s. They produce serial bit streams of 16 and 32 bits per word, and you can increase that word size to 64 bits with DG-525 options. Serial data stream is NRZ or RZ format. Output signals feature 1-V amplitude (or ECL), and up to  $\pm 1$ -V dc offset. Rise and fall times are 0.8 ns. The units are operated with an external clock signal, either sine wave or pulse.

CIRCLE NO. 476

**Spectrum analyzer spans vhf band, is portable**



*Systron Donner Microwave Div., 14844 Oxnard St., Van Nuys, Calif. 91409. (213) 786-1760. \$4250; 60 days ARO.*

The Model 750 is a portable spectrum analyzer specifically for vhf use. It covers the frequency range up to 480 MHz in a single band. The entire band can be scanned in one sweep for panoramic evaluation of all signals in the vhf range. Low frequency operation extends down to 1 MHz. A 500-MHz low-pass filter is included at the input. The Model 750 is fully portable, capable of operating up to eight hours from an optional internal rechargeable battery pack. Also available is an option to operate from an external 14 to 20 volt unregulated dc power source.

CIRCLE NO. 477

**4-1/2-digit DMM sells for \$495**



*Data Technology Corp., 2700 S. Fairview St., Santa Ana, Calif. 92704. (714) 546-7160. \$495.*

The Model 40 4-1/2-digit multi-meter provides fourteen ac, dc and ohms ranges with 0.02% and 0.03% accuracy. The instrument's dc measuring speed is 0.2 s and ac and ohm speed is 2 s and 500 ms, respectively. The fully-guarded DMM has 50 to 60-dB NMR and 90 to 100-dB CMR. Resolution is 10  $\mu$ V. A 1200-V overload, ac or dc, on any range prevents damage under all but the most severe conditions. Input impedance for ac is 1 M $\Omega$ , shunted by 50 pF. Dc input resistance is 10<sup>8</sup>  $\Omega$ .

CIRCLE NO. 478

**POWER SUPPLY HANDBOOK**  
YOUR'S **FREE**

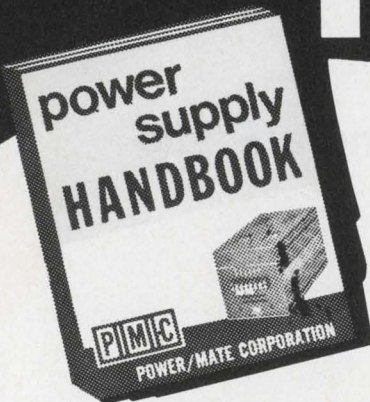

A complete reference of definitions, principles of operation, load connections and performance measurements. A working tool for the Engineer. Yours for the asking . . . and its FREE from Power/Mate.

SEND FOR YOUR FREE COPY



**POWER/MATE CORP.**

514 S. RIVER STREET HACKENSACK, N. J. 07601  
Phone (201) 343-6294 TWX (710) 990-5023



**CHOOSE FROM OVER 4,000 UNUSUAL BARGAINS!**

**OPTICS • SCIENCE ELECTRONICS**

**FREE CATALOG!**



**1,000's OF HARD-TO-FIND BUYS FOR INDUSTRY**

Brand new 164-page easy-to-read edition packed with new products, charts, diagrams, illustrations. On-the-job helps; quality control aids, unique, exclusive items to speed your work, improve quality, cut development and production costs! Loaded with optical, scientific and electronic equipment available from stock for industry, research labs, design engineers, experimenters, hobbyists.

**ONE SOURCE FOR ALL YOUR NEEDS**

Tremendous variety. Terrific savings. Countless hard-to-get surplus bargains. Many "one-of-a-kinds" nowhere else. Ingenious scientific tools. Thousands of components: lenses, prisms, wedges, mirrors, mounts, all types of accessories. Hundreds of instruments: pollution testing equipment, lasers, comparators, magnifiers, microscopes, projectors, telescopes, binoculars, photo attachments, ecological items, black light equipment and America's largest collection of unique lighting products.

**BUY DIRECT WITH MONEY-BACK GUARANTEE**

Edmund ships over 5,000 orders monthly to America's largest industrials — every item guaranteed! You must be satisfied, or return your purchase in 30 days for your money back. Shop the catalog of America's largest Science-Optics-Electronics Mart with confidence! Get your FREE copy without obligation. No salesman will call. Write now for free catalog "DA"



**EDMUND SCIENTIFIC CO.**  
300 EDSCORP BUILDING  
BARRINGTON, NEW JERSEY 08007  
TELEPHONE: 609-547-3488



# Mil spec synchro/digital converters:

## We've got 'em in cards. Or cased. For off-the-shelf delivery.

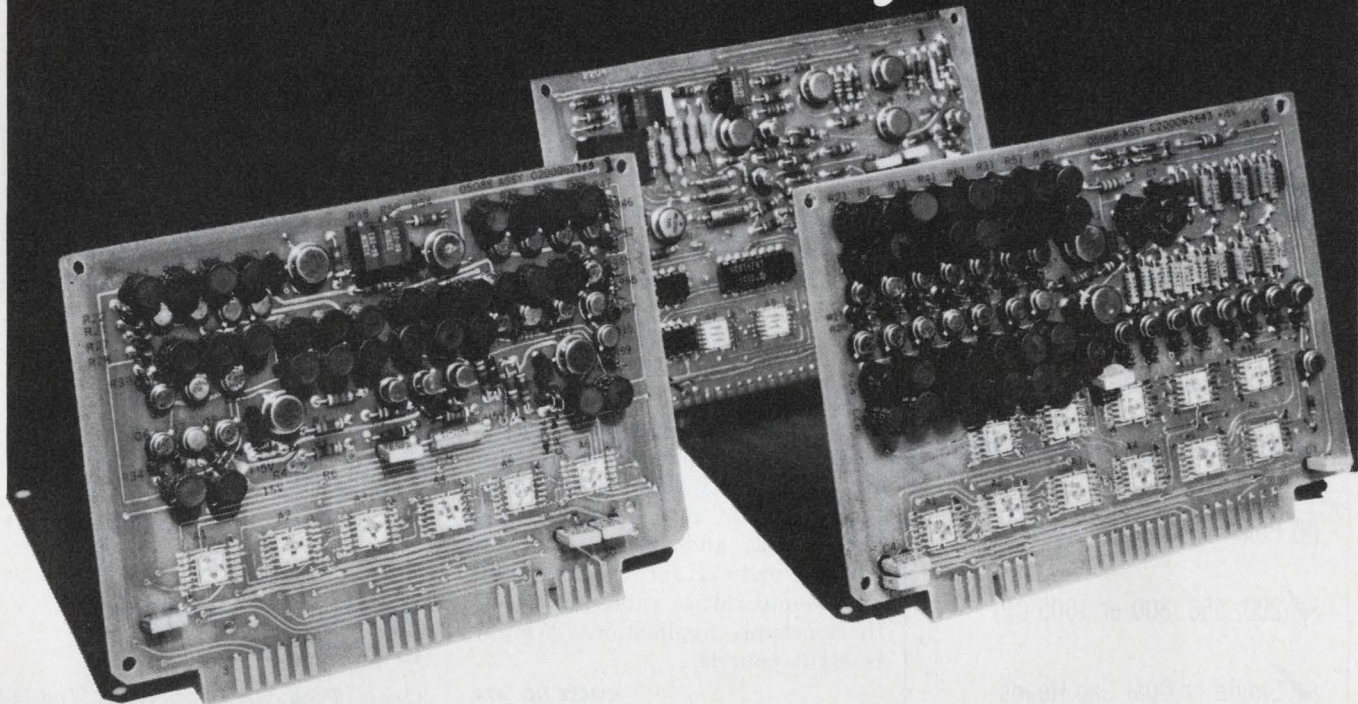

Kearfott can solve your synchro-to-digital and digital-to-synchro conversion problems with three production model solid state converters. All three meet MIL-E-5400.\*

TRIGAC I—A low cost synchro to digital converter, accurate to 12 minutes.

TRIGAC III—Synchro to digital tracking converter dynamically similar to an electro mechanical follow-up servo.

TRIGAC IV—Digital to synchro converter, accurate to four minutes.

### Typical Characteristics

	TRIGAC I		TRIGAC III	TRIGAC IV
Model Number	C70 4773 017	C70 4773 011	C70 4773 019	C70 4773 022
Package	2 P C cards	metal enclosure	2 P C cards	3 P C cards
Input Signal	4 wire resolver	3 wire synchro	4 wire resolver 4 channels	12 bit parallel
Output	13 bit BCD		14 bit natural parallel	3 wire 11.8V 400Hz
Resolution	6 minutes of arc			
Accuracy	12 minutes of arc		4 minutes of arc	
Logic Levels	Logic "1" = $\pm 5V \pm 10\%$ , Logic "0" = 0-0.5V			

\*Commercial version available

We can supply any of the cards shown in corrosion-resistant metal enclosures. Write today for new catalog. The Singer Company, Kearfott Division, 1150 McBride Avenue, Little Falls, New Jersey 07424.

**SINGER**  
AEROSPACE & MARINE SYSTEMS

# PSC Low Cost Tape Transports

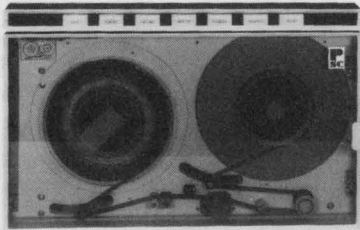

## User Engineered THROUGH OUT

- Interface Industry Standard
- 7", 8½" or 10½" Reel Size
- 6.25, 12.5, 25, 37.5 or 45 IPS
- Phase Encoding or NRZI
- 200, 556, 800 or 1600 CPI
- Single or Dual Gap Heads
- Write, Read, Read Write or Read after Write
- Power Fail Safe
- Solid State IC Logic

Give us your requirements we'll custom assemble to your specification with off the shelf components.

Call: Chuck Quillen, Director of Marketing for more information.

(213) 245-8424



**Producers Service Corp.**  
Computer Peripheral Div.  
1200 Grand Central Ave.  
Glendale, Calif. 91201

## INSTRUMENTATION

### Voltage calibrator is settable to 6 digits



*Electronic Development Corp., 11 Hamlin St., Boston, Mass. 02127. (617) 268-9696. \$820; stock.*

The Model MV115/B calibrator/transfer standard provides voltage ranges of 11.11111 V dc and 1.111110 V dc to accuracies of  $\pm 0.005\%$  ( $+40 \mu\text{V}$  and  $+10 \mu\text{V}$  respectively)—well within unsaturated standard cell error tolerances. Standard features include a "circuit condition indicator" to warn the operator of short circuit, overload, over voltage, low line voltage, or malfunction. A unique output polarity switch permits reversal of output polarity between floating terminals for zero voltage reference check, and provides a convenient method for checking ambient temperature references in dc thermocouple applications. Weight is eight pounds.

CIRCLE NO. 479

### 2-1/2-digit DMM kit costs just \$79.95

*Heath Company, Benton Harbor, Mich. 49022. (616) 983-3961. \$79.95 (mail order).*

The IM-1202 is a 2-1/2-digit Multimeter kit. A cold-cathode readout ends parallax and interpolation errors. Accuracy is within 1% on dc volts, 1-1/2% on ac volts and ac/dc current, 2% on ohms. The 29 selectable ranges measure voltages from 10 mV to 1000 V on dc, either polarity; 10 mV to 700 V rms on ac; 10  $\mu\text{A}$  to 2 A on ac or dc current, and 1  $\Omega$  to 2 M $\Omega$  on resistance. In addition, there are lighted indicators for overrange, positive and negative dc voltages and current, and a handy front-panel polarity switch.

CIRCLE NO. 480

### 2-channel recorder has plug-in-preamps



*Recorder Systems Div., Gulton Industries, Inc., Gulton Industrial Park, E. Greenwich, R. I. 02818. (401) 884-6800.*

The Techni-Rite TR-222 portable two-channel recorder accepts interchangeable plug-in preamps, weighs less than 30 lbs. and has electrically-selectable chart speeds of 0.5, 1, 2.5, 5, 10, 20, 50 and 100 mm/sec. Frequency response is dc to 30 Hz at 50 chart divisions and dc to 100 Hz ( $-3 \text{ dB}$ ) at eight divisions. Each channel is 50-mm wide. Preamps with gains of 10 mV/div. to 20  $\mu\text{V}/\text{div.}$  are offered as well as preamps that convert transducer signals. Time to change any preamp is approximately 10 seconds.

CIRCLE NO. 481

### Spectrum analyzer is portable

*Quan Tech, Div. of KMS Industries, Inc., 43 S. Jefferson Rd., Whippany, N.J. 07981. (201) 887-5508. \$3875.*

Model 306 TDL is a tracking wave and spectrum analyzer with a frequency range of 10 Hz to 50 kHz and bandwidths of 10, 30, 100, 300 and 1000 Hz. The instrument is equipped for instant conversion to a 12-V dc source. Automatic tracking enables the unit to lock onto and track a signal whose frequency varies over narrow or wide limits. No external pilot or reference frequency is required. A 5-digit readout enables the operator to determine the frequency of the tracked signal or, in manual operation, the frequency to which the analyzer is tuned. The instrument has a dynamic amplitude range of up to 90 dB in the logarithmic mode and  $> 70 \text{ dB}$  in linear operation.

CIRCLE NO. 482



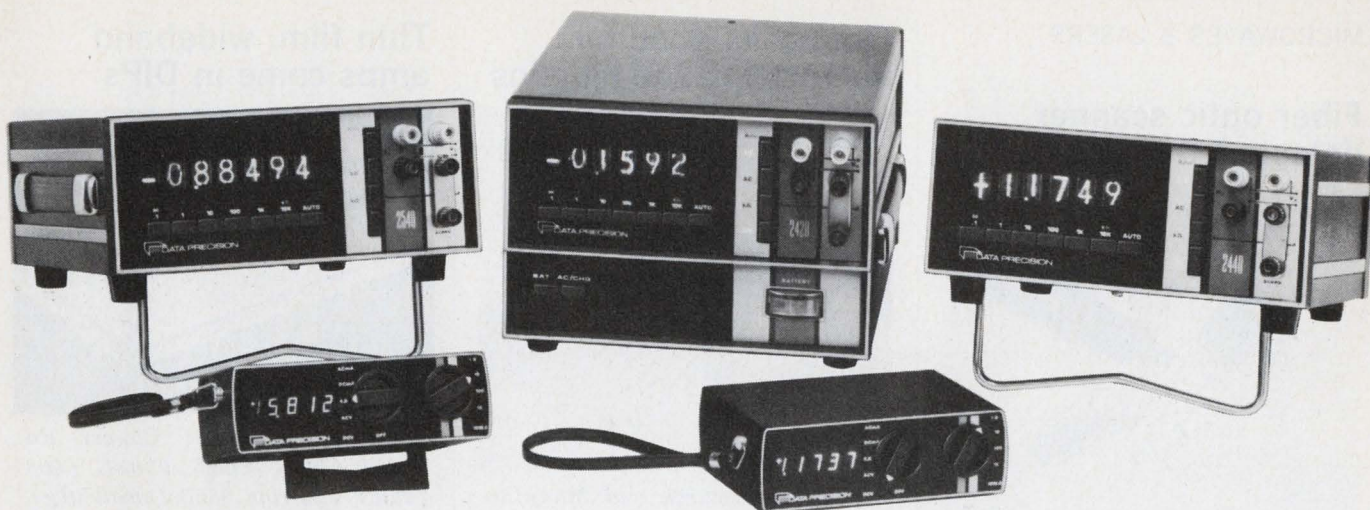

# Tri-Phasic<sup>TM</sup> multimeters

## The new standard for DMMs

In the early 70's Data Precision set new standards for digital multimeters by designing out needless high cost while utilizing innovative electronics. Our engineers created a family of multimeters that provides performance equal to or exceeding other laboratory-grade instruments at a fraction of the cost, size, weight and power.

Data Precision's advanced designs — Tri-Phasic<sup>TM</sup> conversion, Isopolar<sup>TM</sup> referencing and Ratiohm<sup>TM</sup> resistance measurement — have set new price/performance standards. Conventional DMMs just don't measure up!

Data Precision's new, laboratory-quality Model 245 4½-digit multimeter puts .005% resolution right in the palm of your hand. The one and a quarter pound, pocket-size Model 245 measures DC volts, AC volts, DC current, AC current and resistance with 100% overranging. It operates on its own rechargeable 6-hour NiCd battery pack and on AC line. Supplied with battery pack, carrying case, charger and probes, its complete price is \$295. An outstanding example of what Data Precision considers good engineering — years ahead.

The 2500 Series 5½-digit DMMs provide a basic accuracy for 6 months of  $\pm 0.001\%$  f.s.  $\pm 0.007\%$  reading  $\pm 1$  I.s.d. Priced from \$995. The 2400 Series 4½-digit DMMs have a basic accuracy, 6 months,  $\pm 0.007\%$  reading  $\pm 1$  I.s.d. Priced from \$580. Functions include DC volts, AC volts, resistance and DC ratio. Standard features include autoranging and 20% overrange; remote triggering and ranging; true differential floating circuit input; isolated BCD outputs and automatic zero stability.

All multimeters are documented by full test data and Certificate of Conformance. For complete information, specifications and copies of technical papers outlining the design features, write or call Data Precision Corporation, Audubon Road, Wakefield, Massachusetts 01880. Phone: (617) 246-1600.

 **DATA PRECISION**  
...years ahead

### Fiber optic scanner detects 1-mil targets

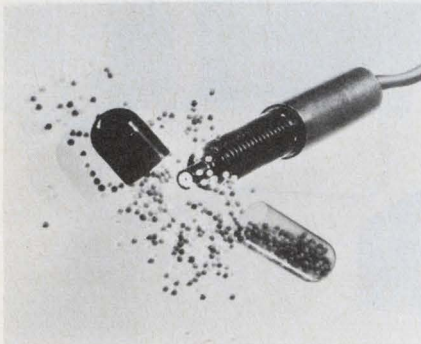

Skan-a-Matic Corp., P.O. Box S, Elbridge, N.Y. 13060. (315) 689-3986.

The S3010-3B Mini-Skanner, a fiber optic scanner, can detect a target as small as 1 mil in diameter. The tubular device has a minimum field of view of 10 mils in diameter, which enables it to differentiate between 10-mil wide lines spaced 10 mils apart. Repeatability of object positions of  $\pm 0.1$  mil is possible.

CIRCLE NO. 483

### Flat-packs good for microstrips and plug-ins

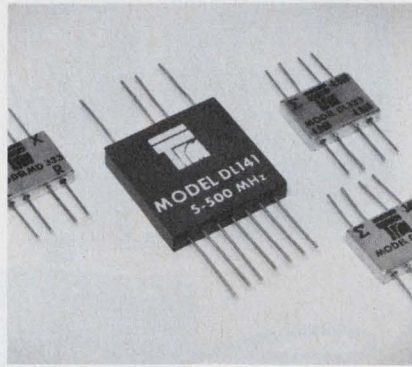

Technical Research and Manufacturing, Inc., Grenier Field, RFD #3, Manchester, N.H. 03103. (603) 668-0120, \$18 (1-4); stock to 4 wks.

Two-way, 3-way and 4-way power dividers and DBM mixers are available in miniature case sizes as small as  $1/2 \times 3/8 \times 1/8$  inches with frequency coverage from 0.2 to 500 MHz. Other features include characteristic impedance of 50  $\Omega$ , VSWR of 1.3:1, loss of 0.5 dB (max) and isolation of 30 dB (typ).

CIRCLE NO. 484

### Thin film, wideband amps come in DIPs

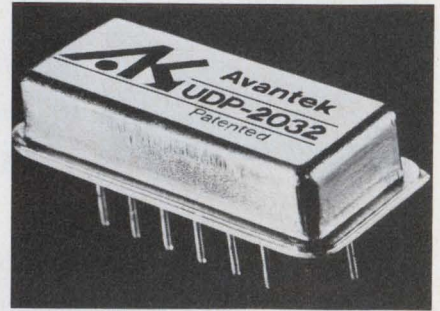

Avantek, Inc., 2981 Copper Rd., Santa Clara, Calif. 95051. (408) 739-6170. From \$550 (small qty).

Two series of thin film, wideband, low noise amplifiers, designated the UDP-2032 and UDP-4000 Series, feature dual-in-line packaging. The devices cover the frequency ranges of 1 to 2 GHz and 2 to 4 GHz, respectively. The devices provide a minimum of 24 dB gain at 1 to 2 GHz (UDP-2032) and over 10 mW (+11 dBm) linear output power from UDP-4003. Units within a series can be cascaded to boost gain without affecting bandpass characteristics.

CIRCLE NO. 485

from the proud inventors:



### A battery with a shelf life of a decade

Now available at a price you can afford for commercial applications. Solid electrolyte design makes this kind of performance possible:

- Shelf life projected to ten or fifteen years, retaining 90% of capacity.
- Very reliable. Withstands 20,000 G shock, 18,000 rpm spin and 2,000 Hz vibration. Operates from  $-65^\circ\text{F}$  up to  $160^\circ\text{F}$ .
- Operating voltage up to 3.6v, capacity up to 200 mAh.

For more information and sample prices, write Gould Inc., Dept. ES, P.O. Box 3140, St. Paul, Minnesota 55165. (612) 452-1500, Ext. 471.



INFORMATION RETRIEVAL NUMBER 95

## Honeywell makes cabinetry...all kinds

send for free brochure



200 Bond St.  
Wabash, Ind. 46992  
219/563-2161

**Honeywell**

INFORMATION RETRIEVAL NUMBER 96

ELECTRONIC DESIGN 1, January 4, 1973

# Here it is! Allochiral. The most rugged, reliable solderless interconnect system available. Lowest profile ever... .025" Low price, too!

You gain...

**Super-Low Profile** for greater packaging density!

**One-piece construction** for greater reliability, production savings on each contact, board and finished assembly!

**Short IC lead lengths** - as short as .035 below device for full contact - as much as 60% of lead perimeters!

**And, more.** A complete array of associated equipment. Boards. Connectors. IC carriers. Packaging Hardware. Insertion tools (manual, semi- and full automatic)!

It's new. From Robinson-Nugent, the socket people. Push an Allochiral contact/terminal through a pre-drilled board and it becomes a properly and permanently aligned, self-supporting connector socket for ICs. Or, with its available associated equipment and hardware, a complete back panel solderless interconnect system.

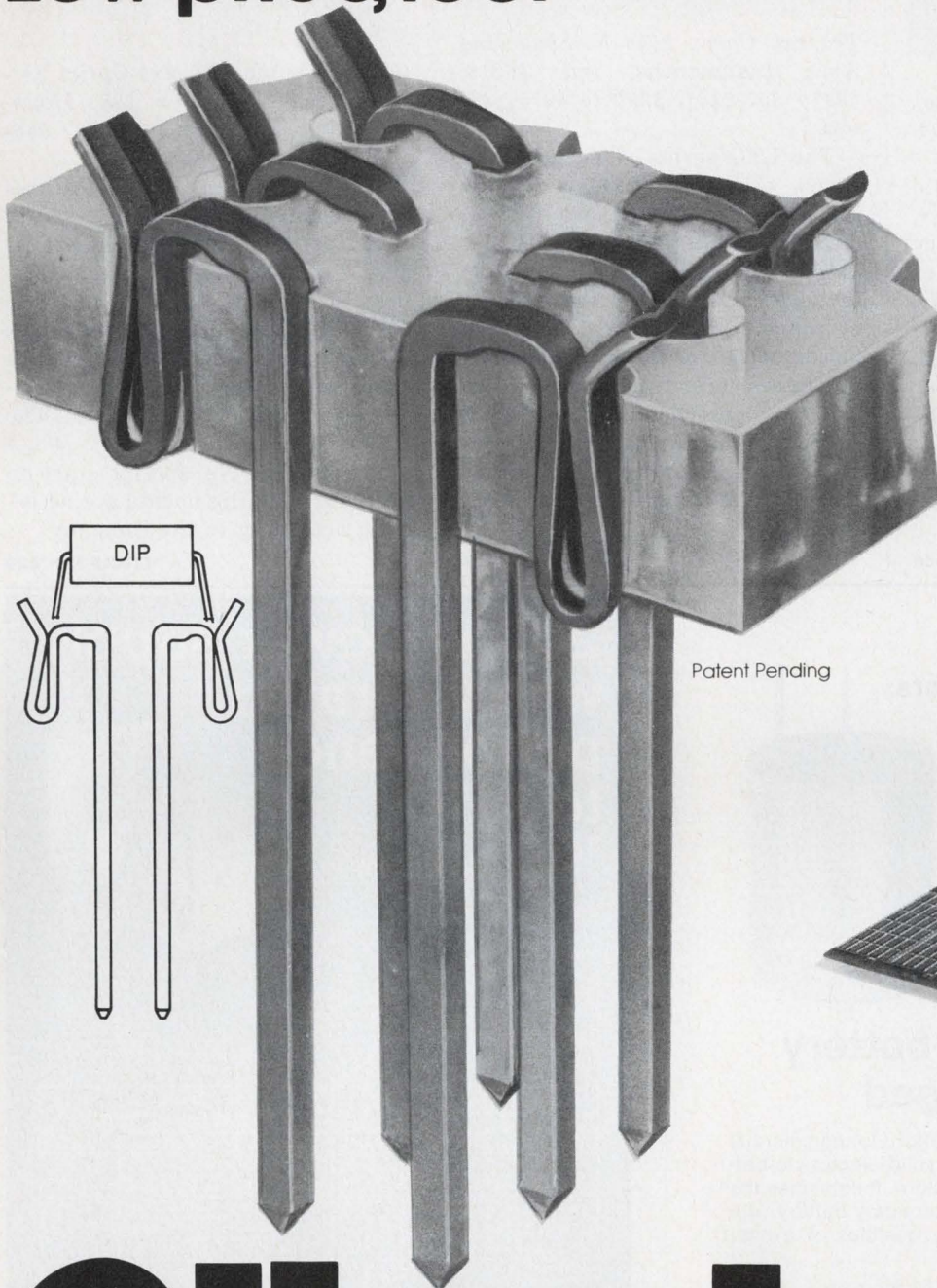

Patent Pending

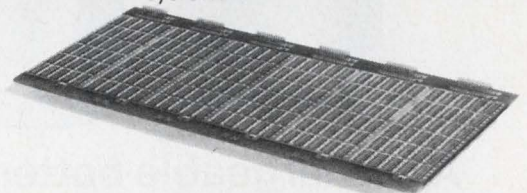

Try the new Allochiral system. From...

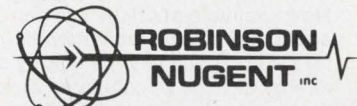

800 East Eighth Street  
New Albany, Indiana 47150  
(812) 945-0211  
TWX 810-540-4082

# Allochiral

(al-o-kir'-el)

INFORMATION RETRIEVAL NUMBER 97

### Linear Class A amp covers 1-2 GHz range

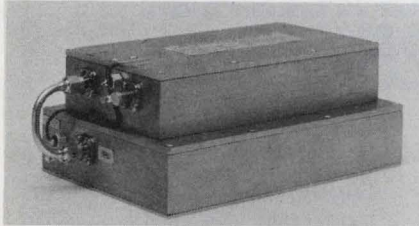

Microwave Power Devices, Inc., Adams Ct., Plainview, N.Y. 11803. (516) 433-1400. \$1950; 30 days.

The Model LWA1020, a solid state linear Class A amplifier, covers the complete frequency range of 1-2 GHz. The amplifier delivers 1 W at 1 dB compression, with a signal gain of 30 dB. The LWA1020 features complete field repairability due to the modular construction used throughout the amplifier. And 50 Ω spare modules that are factory prealigned can be replaced in the field by semi-skilled personnel.

CIRCLE NO. 486

### Octave-tuned oscillators offer 1% linearity

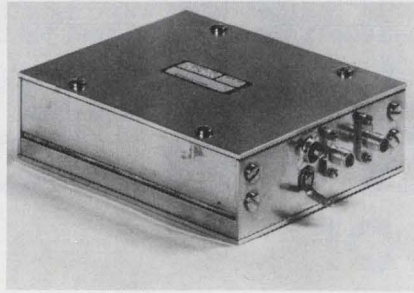

Texscan Corp., 2446 N. Shadeland Ave., Indianapolis, Ind. 46219. (317) 357-8781. \$390 to \$475; 4-6 wks.

The LTO series of electronically tuned oscillators exhibit tuning linearity of  $\pm 1\%$  without external circuitry. Tuning accuracy is also  $\pm 1\%$ . Five standard units in octave bandwidths cover the frequency range of 32 MHz to 1 GHz with power output of 20 mW. The LTO oscillators are fully isolated for stable operation into a 10.0:1 VSWR; tuning voltage is less than 12 V and the tuning input may be frequency modulated at a 1-MHz rate.

CIRCLE NO. 487

### Nd:YAG laser comes easy to use, compact

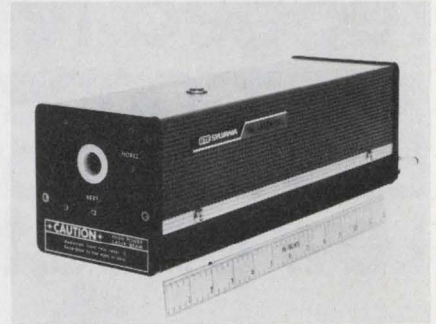

GTE Sylvania, Electro-Optics Organization, P.O. Box 188, Mountain View, Calif. 94040. (415) 966-9111. \$7000; 90 days.

A neodymium laser features quick-change pump lamps, safety interlock, and single-package design for ease of use and compactness. Designated Model 606, the Nd:YAG laser has a continuous output power of 3/4 W single transverse mode and 5 W multimode and operates at 1.06 μm. The 15-pound device is 4-1/4 × 4-1/4 × 15 inches. No special start-up procedures or alignments are necessary, according to the company.

CIRCLE NO. 488

from the proud inventors:

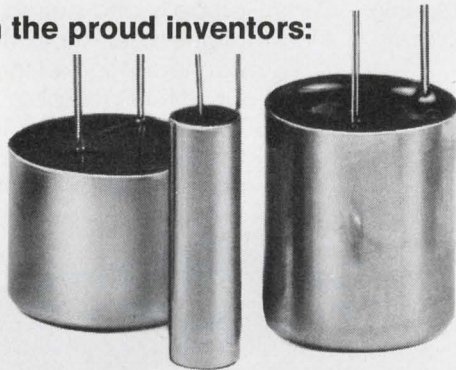

### A rechargeable battery that stays charged

Now available at prices you can afford for commercial applications. Our rechargeable, solid electrolyte battery is a capacitive type energy store. It combines the energy storage capability of a secondary battery with the environmental and shelf life qualities of a high quality capacitor.

- Many thousands of charge/discharge cycles.
- Can be integrated with electronic circuitry with no danger of leakage or contamination.

For more information and sample prices, write Gould Inc., Dept. ES, P.O. Box 3140, St. Paul, Minnesota 55165. (612) 452-1500, Ext. 471.



INFORMATION RETRIEVAL NUMBER 98

## 200 W power supply with full-rated performance to 71°C

\$99 (Dual \$119)



Stock Delivery

#### SPECIFICATIONS

Size: 5 x 5.5 x 10.75  
 Weight: 15 lbs  
 Input: 105-125V, 47-420Hz  
 Remote Sensing: Standard  
 Regulation: Line 0.01%  
 Load 0.10%  
 Ripple: Less than 250 Microvolts  
 Recovery: 25 Microseconds

Temperature:  
 Operating: -20° to +71°C  
 Storage: -65° to +81°C  
 Coefficient: -0.01%/°C Max  
 Current Limiting:  
 Fixed-foldback type  
 Overvoltage (OV): Optional  
 SCR Crowbar

SINGLE			DUAL (Two independent outputs)		
MODEL	VOLTS	AMPS	MODEL	VOLTS	AMPS
200-5	4.5 to 5.5	15.0	200-0505	4.5 to 5.5	7.0
200-12	11.5 to 12.5	10.0	200-1212	11.5 to 12.5	5.0
200-15	14.5 to 15.5	9.0	200-1515	14.5 to 15.5	4.5
200-24	23.5 to 24.5	7.5	200-2424	23.5 to 24.5	3.5
200-28	27.5 to 28.5	7.0	200-2828	27.5 to 28.5	3.5
200-48	47.5 to 48.5	4.0	(Any voltage 3 to 30 available)		
(Any voltage 3 to 50 available)			For OV models add -0 to model No.		

QUANTITY	SINGLE	WITH OV	DUAL	WITH OV
1-9	\$99	\$114	\$119	\$129
10-24	\$94	\$107	\$113	\$122

FREE POWER SUPPLY CATALOG

"Quality Power Supplies Since 1965"

**Electrostatics, Inc.**

7718 CLAIREMONT MESA BLVD. • SAN DIEGO, CA 92111 • (714) 279-1414

INFORMATION RETRIEVAL NUMBER 99

ELECTRONIC DESIGN 1, January 4, 1973

# Candidate for the PE license this year?

Use these up-to-date guides...  
specifically tailored for  
your study campaign

## HAYDEN PROFESSIONAL ENGINEERING EXAMINATION SERIES

LAWRENCE J. HOLLANDER, Editor-in-Chief,  
Professional Engineer, New York State

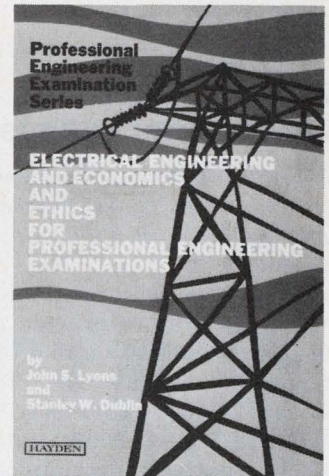
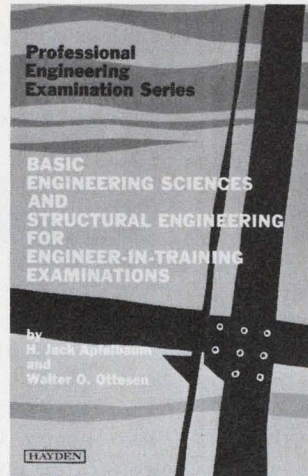

Written with your needs kept foremost,  
these study guides offer . . .

- a wide selection of actual, realistic problems from recent state examinations arranged by subject for convenient study
- detailed step-by-step solutions that bring out underlying principles to equip you to handle the unexpected
- concise background discussions precede the problems, presenting you with a mini-review of theory, principles, terminology
- separate tables of contents for subjects and problems quickly pinpoint the specifics for rapid review or "open book" examinations
- numerous schematic diagrams and detailed drawings to insure in-depth understanding

Review the books that concern you for  
15 full days—FREE!

### FOR 15-DAY FREE EXAMINATION

Please send the book(s) circled below on a 15-day examination basis. At the end of that time, I will remit payment, plus postage, or return the book(s) without further obligation.

5712-1      5715-6      5716-4

(For those ordering by ISBN, the Hayden Prefix is: 0-8104)

Save money! On all prepaid orders Hayden pays postage—  
same 15-day return guarantee! 72-29 ED

Name \_\_\_\_\_

Firm \_\_\_\_\_

Address \_\_\_\_\_

City/State \_\_\_\_\_ Zip \_\_\_\_\_



HAYDEN BOOK COMPANY, INC.  
116 West 14th St., New York, N.Y. 10011

### BASIC ENGINEERING SCIENCES AND STRUCTURAL ENGINEERING FOR ENGINEER-IN-TRAINING EXAMINATIONS

H. JACK APFELBAUM, P.E., Department of Mechanical Engineering, Lowell  
Technological Institute; and WALTER O. OTTESEN, P.E., Patent Counsel

Nearly 200 solved problems selected from a nationwide survey of recent E-I-T examinations offer you a complete, well organized review of the concepts and techniques that must be understood to successfully pass the preliminary exam. Unlike other study guides that stress one aspect of the field while shortchanging others, this volume provides balanced coverage of the three broad engineering areas: *the basic sciences*: mathematics, physics, and chemistry; *the engineering sciences*: statics, dynamics, fluid mechanics, thermodynamics, electricity, and engineering economy; and *structural engineering*. More than 300 detailed illustrations pinpoint key concepts and problem-solving techniques.

408 pp., 6 x 9, illus., cloth, #5712-1, \$13.95

### ELECTRICAL ENGINEERING AND ECONOMICS AND ETHICS FOR PROFESSIONAL ENGINEERING EXAMINATIONS

JOHN S. LYONS, P.E., and STANLEY W. DUBLIN, Institute of Environmental  
Medicine, New York University Medical Center

Concentrating on the subjects and topics that form the foundation of this rapidly changing technology, this book analyzes and solves for you almost 100 problems from a nationwide sampling of recent PE examinations. Its comprehensive, up-to-date coverage includes materials and problems not found in other guides of this type, such as electrical-magnetic-thermal analogs, semiconductors, and power system short circuits. More than 170 detailed illustrations are included. The separate section devoted to economics and ethics features an unusual approach to such topics as interest, costs, valuation, and others—the summarized use of formulas in solving nearly 50 typical problems.

302 pp., 6 x 9, illus., cloth, #5715-6, \$12.95

also available

### MECHANICAL ENGINEERING AND ECONOMICS AND ETHICS FOR PROFESSIONAL ENGINEERING EXAMINATIONS

EUGENE STAMPER, P.E., and STANLEY DUBLIN

Over 200 solved problems in mechanical engineering, along with the same thorough coverage of economics and ethics.

392 pp., 6 x 9, illus., cloth, #5716-4, \$14.95

### K-band generators boost power ratings

*Polarad Electronic Instruments, 5 Delaware Dr., Lake Success, N.Y. 11040. (516) 328-1100. Stock to 30 days.*

A series of calibrated microwave signal generators provide at least 0 dBm from 10.0 to 15.5 GHz and from 15.0 to 21.0 GHz. The new signal generators are Models 1709A, 1710A, 1809A and 1810A. Each reportedly provides a power output that's double that previously available. Other features include extended range FM, pulse and square wave modulation, (from 10 Hz to 10 kHz),  $\pm 0.5\%$  digital frequency readout, greater maintenance-free reliability (MTBF) and low cost (compared to the tube units). Prices are \$3760 for Models 1709A and 1710A, and \$4000 for Models 1809A and 1810A.

CIRCLE NO. 489

### Argon laser has 15 W cw output

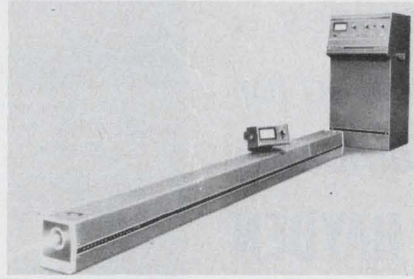

*Spectra Physics, 1250 W. Middlefield Rd., Mountain View, Calif. 94040. (415) 961-2550. 170-00: \$17,450; 170-03; \$22,750; 120 days.*

Two argon lasers with output powers of 10 and 15 W, designated the Model 170-00 and Model 170-03, respectively, feature beryllium oxide (BeO) plasma tubes and Staballite resonators. The standard lasers come complete with snap-in mirror and prism mounts. With the broadband mirror, the 170-03 operates on all lines. With the prism, single wavelengths can be selected; over 6 W are available at 514.5 nm and over 700 mW in the UV range.

CIRCLE NO. 490

### Scribing system claims chip-yield doubled



*Electro Scientific Industries, 13900 N.W. Science Park Dr., Portland, Ore. 97229. (503) 646-4141.*

The company's new scribing laser system boasts a throughput, or chip yield, that's more than twice that of previously achieved production levels, according to the company. Termed the SP3672, the system allows continuous scribing for a given substrate scribing pattern. Scribing speeds reach 6 ips.

CIRCLE NO. 491

from the proud inventors:

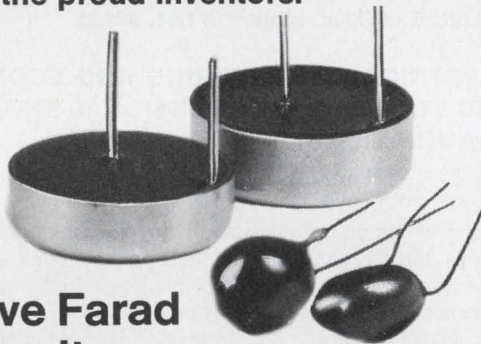

### A five Farad capacitor

Now available at a price you can afford for commercial applications. Solid electrolyte design makes this kind of performance possible:

- Up to five Farads capacitance (DC operation).
- High energy storage and low operating voltage (0.5v max.) allows cost economies in other circuit components.
- Excellent charge retention (measured in years).
- Operates over extreme temperature range: -65°F to 160°F.

For more information and sample prices, write Gould Inc., Dept. ES, P.O. Box 3140, St. Paul, Minnesota 55165. (612) 452-1500, Ext. 471.



INFORMATION RETRIEVAL NUMBER 101

FREE

**The World's Largest Consumer Electronics Catalog**

- Stereo/Hi-Fi Components • Musical Instruments and Amplifiers • CB & Ham Equipment • Tools and Test Equipment • Police and Fire Monitor Receivers • Public Address Systems • Photography Equipment • Semiconductors, Books, Parts • Plus Much More!

Send me the **FREE** LAFAYETTE Catalog  
**Lafayette Radio Electronics Dept. 45013**  
**P.O. Box 10, Syosset, L.I., N.Y. 11791**

Send Me the Free Lafayette Catalog 45013

NAME \_\_\_\_\_

ADDRESS \_\_\_\_\_

CITY \_\_\_\_\_

STATE \_\_\_\_\_ ZIP \_\_\_\_\_

(Please include your zip code)

INFORMATION RETRIEVAL NUMBER 102

# **STOP!**

# **GO...**

**to the inside front cover  
of this issue of  
Electronic Design . . .**

## **RENEW YOUR FREE SUBSCRIPTION TODAY**

**THIS IS A ONE-TIME RENEWAL OPPORTUNITY**

*To insure uninterrupted service, your free subscription to Electronic Design must be renewed now! Please turn to the special renewal card inside the front cover. Fill out and return the card promptly. To avoid delay, use the peel-off label from the front cover of this issue.*

**-- Do it now -- You'll be happier you did --**

High resolution,  
low cost

# SCAN CONVERTERS display any electronic information

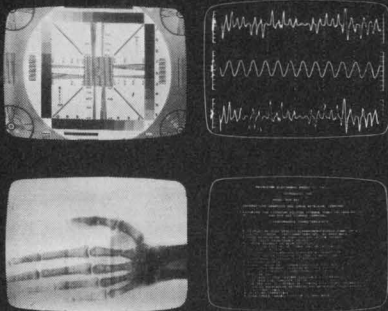

Any electronic information—from computers, lasers, TV cameras, scanners, X-ray, electron microscopes or whatever—can be displayed sharper, brighter, faster and at lower cost with PEP scan converters. Regardless of its format or speed. Even if it's only transient information. The reason: **only** PEP scan converters offer this combination of advantages:

- RESOLUTION to 3000 lines
- GRAY SCALE: 10 Logarithmic levels
- NON-DESTRUCTIVE readout
- WIDE RANGE of reading and writing speeds: video to DC
- WIDE system bandwidth: 30 MHz
- READ, write, selective erase, zoom, other functions
- LONG, trouble-free life

We're the people who developed high resolution, low cost scan conversion and image storage technology. Our Lithocon® silicon storage tube is the heart of all PEP scan converters, and makes them feasible for a whole new world of applications. Like microfilm/microfiche. Industrial process control. Facsimile. CATV systems. And X-ray, ECG and low light level detection systems. And hundreds more. We'll be happy to tell you about them. Write or call today for details. Princeton Electronic Products, Inc., P.O. Box 101, North Brunswick, New Jersey 08902; (201) 297-4448.



**PRINCETON  
ELECTRONIC  
PRODUCTS, INC.**

INFORMATION RETRIEVAL NUMBER 104

## PACKAGING & MATERIALS

### Modular heat sink dissipates 720 W

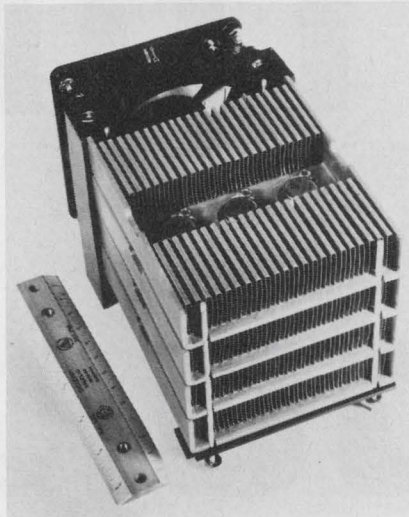

W. F. Chew Enterprises, 441 E. 4th St., Long Beach, Calif. 90812. (213) 432-2704. \$49; stock.

Coldpak IV, a modular forced-convection heat sink dissipates 720 W (12 TO-3 transistors) with less than 35 C plate temperature rise above ambient. The heat sink is sized in an envelope of 5.25-in. H × 5-in. W × 6.5-in. L. Coldpak IV with two-lead egress holes of 203-mils diameter and mounting holes of 156-mils spaced for TO-3 cases. The unit accepts any standard 4 11/16-in. square fan providing a minimum air flow of 60 cfm.

CIRCLE NO. 492

### Neutral flux for silver soldering boasts safety

Superior Flux & Mfg. Co., 1536 St. Clair Ave., Cleveland, Ohio 44114. (216) 781-9373.

Safety for users is a feature of silver solder flux No. 6 since it is neutral—not acid—and will not burn the operator's hands or skin. Flux fumes are claimed not to be harmful to eyes, lungs or nasal passages since they contain no free fluorides and cannot generate hydrofluoric acid or dangerous acid fumes. Superior No. 6 flux is used for brazing, hard soldering and silver soldering both ferrous and nonferrous metals and alloys such as mild steel, high carbon steel, stainless, monel, nickel, inconel, copper, brass, bronze and precious metals.

CIRCLE NO. 493

### Beryllium oxide raises substrate conductivity

Ceradyne, Inc., 8948 Fullbright Ave., Chatsworth, Calif. 91311. (213) 882-8777.

Polished hot-pressed beryllium oxide (CERALLOY 418) substrates have a thermal conductivity seven times greater than sapphire. The substrates are diamond sliced, ground, and lapped from large, uniform billets. Surface finishes can be finer than three micro-inches, in sizes up to 5 × 5 inches. The fine surface finish is obtainable because the hot pressed ceramics are theoretically dense (zero porosity), free from glassy binders (no unequal lapping), and fine grained (no pull-outs). All properties are isotropic in contrast to the anisotropic properties of sapphire. This isotropy is achieved due to the randomly oriented, polycrystalline nature of the hot pressed ceramics.

CIRCLE NO. 494

### Nylon relay socket handles 120 V, 5 A

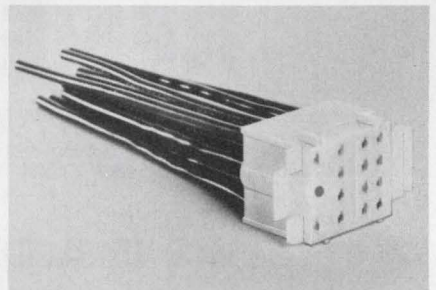

Waldom Electronics, Inc., 4625 W. 53rd St., Chicago, Ill. 60632. (312) 585-1212. \$19.20/100 (1000 up); stock.

The Series 1852-R nylon relay socket works for up to 14-contact, 4PDT relays, with a rating of 120 V, 5 A per circuit. The socket houses Waldom/Molex miniature, tin-plated brass terminals, which accept 18 to 24 gauge wire. The new socket snaps into standard chassis holes quickly and easily, without clips or screws. One side of the socket has a slide-in slot, while the opposite side has a mounting ear. The new socket is recommended for use with relays made by Comar, C.P. Clare, Guardian, P&B, Parelco, Sigma, etc.

CIRCLE NO. 495



# Tips on cooling off hot semiconductors

As power levels go up and up and package size shrinks, circuit designers are keeping semiconductors cool with IERC Heat Sinks/Dissipators. Reducing junction temperature gives many benefits: faster rise and fall times, faster switching speed and beta, fewer circuit loading effects and longer transistor life and circuit reliability.

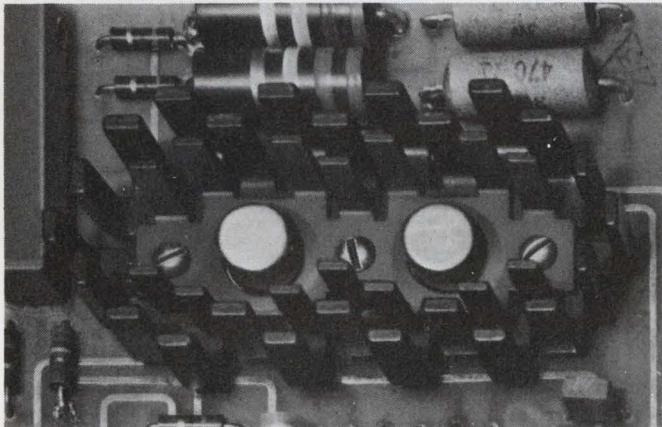

**Thermal mating of matched transistors**, such as these TO5's shown on a dual LP, maintains matched operating characteristics. The LP's unique multiple staggered-finger design (both single and dual models) maximizes radiation and convection cooling, results in a high efficiency-to-weight and -volume ratio.

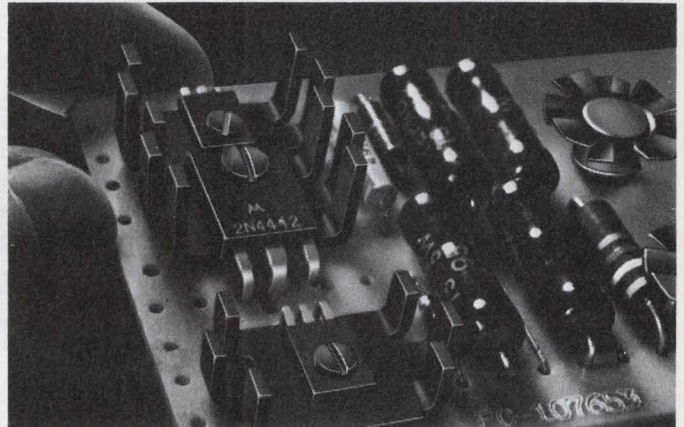

**Power levels of plastic power devices** such as X58's, MS9's, and M386's can be increased up to 80% in natural convection and 500% in forced air when used with PA and PB Dissipators. PA's need only .65 sq. in. to mount; PB's 1.17 sq. in. Staggered finger design gives these light-weight dissipators their high efficiency.

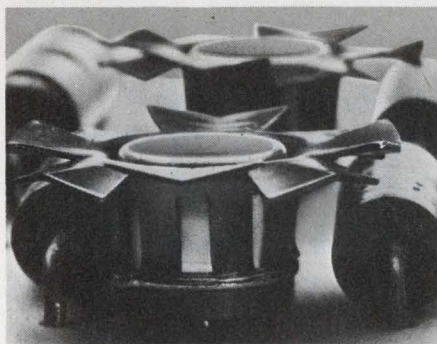

**TO5's and TO18's in high density packages** can be cooled off with efficient push-on Fan Tops that cost only pennies. T-shaped, need no board room, let other components snuggle close. Spring fingers accommodate wide case diameter variations. Models for RO97's, RO97A and D-style plastic devices also.

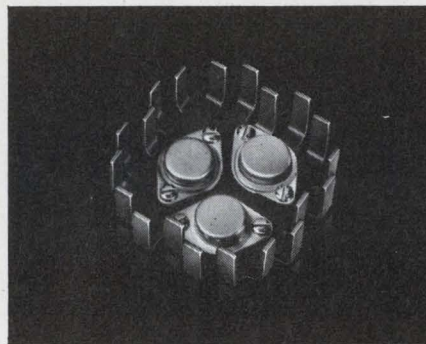

**High power TO3's, TO66's, TO6's, TO15's, etc.** can be operated with much more power when used with HP's. These compact, light-weight staggered finger devices accommodate from one to four TO3's. Provide the same heat dissipation as an extrusion that's three times heavier and one-third larger.

**Heat problems?** IERC engineers welcome the opportunity to help solve your heat dissipation problems. As the world's largest manufacturer of heat sinks/dissipators for lead and case mounted semiconductors, they can come up with a practical, low cost solution.

**Free four-page Short Form Catalog.** Send for your copy today.

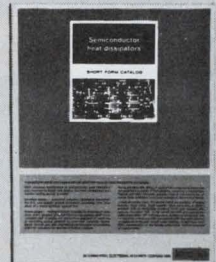

**Heat Sinks/Dissipators**

**IERC**





**our products  
are more fully  
developed...**

Standard Condenser capacitors are indeed fully developed to produce the optimum in performance and durability. Standard is in one business only, the design and manufacture of the world's finest capacitors. We have designed and delivered thousands of specialized capacitors for industry. In fact, what you think of as "special" may be among the many designs already available from stock at Standard. However, if you require capacitors of unusual shape, size, value and material, our engineering department will help you design and produce them to your exact specifications at stock prices. For immediate action, send us a sketch and complete details.

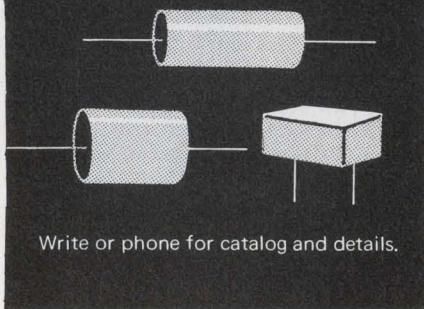

Write or phone for catalog and details.

**Standard**  
**CONDENSER CORPORATION**

Dept. ED-1 1065 West Addison Street  
Chicago, Illinois 60613 • (312) 327-5440

INFORMATION RETRIEVAL NUMBER 106

**PACKAGING & MATERIALS**

**Copper-clad epoxy glass laminate boasts low cost**

*Cincinnati Milacron, 4701 Marburg Ave., Cincinnati, Ohio 45209. (513) 841-8444.*

A PC board material for computer, communications and hostile-environment applications combines many of the best features of polyester-based laminates with those of general purpose and flame retardant glass-cloth reinforced epoxy laminates. The CIMCLAD EG material is a copper-clad laminate based on an epoxy-resin reinforced by a fiberglass mat. Its properties include lower dielectric constant (affects resistivity), lower dissipation factor (affects ability to hold charge), and greater arc resistance (reduces damage to circuit by shorting). The laminate is reported to be more economical than conventional epoxy, yet has better properties. CIMCLAD EG laminate is available in thicknesses of 47 mils to 125 mils and in four subtypes: EGA—one-ounce copper, one side; EGB—one-ounce copper, two sides; EGC—two-ounce copper, one side; and EGD—two-ounce copper, two sides.

**CIRCLE NO. 496**

**Terminal blocks feature tubular clamp contacts**

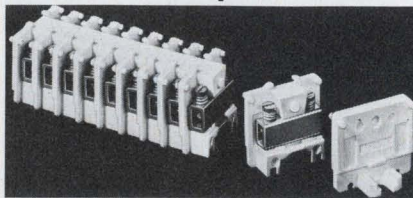

*Buchanan Electrical Products Corp., 1065 Floral Ave., Union, N.J. 07083. (201) 289-8200.*

Miniature 300-V sectional terminal blocks come with tubular screw and tubular clamp contacts for easy wire insertion and the elimination of lugging. The miniature blocks, handling a wire range through No. 12 AWG, are rated at 300 V NEMA general industrial control devices and 600 V NEMA limited power circuits. They are available in nylon or polypropylene, and other thermoplastic compounds.

**CIRCLE NO. 497**

**DIP insertion tool aligns lead pitch**

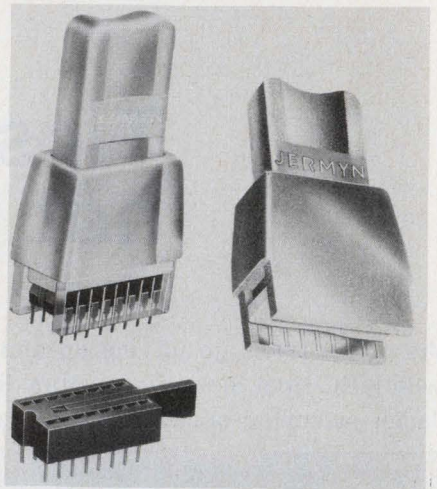

*Jermyn, 712 Montgomery St., San Francisco, Calif. 94111. (415) 362-7431. \$2.50; stock.*

A DIP insertion tool provides a safe means of inserting 14 and 16-pin DIPs into sockets and PC boards. The A23-2050 tool closes the IC leads to the correct 300-mil pitch before locating over the socket or PC board. The tool has a transparent base, facilitating visual alignment of the IC leads with the socket or PC board. Since no metal parts are incorporated into the tool, ICs can be inserted into live sockets without danger of short circuits.

**CIRCLE NO. 498**

**Zip-on insulation features high flexibility**

*The Zippertubing Co., 13000 S. Broadway, Los Angeles, Calif. 90061. (213) 321-3901.*

A zip-on protective material, Type ZVF, features flexibility for applications such as bundling and covering welding lines and others where flexibility is a must. The zip-on ZVF insulation is a fiberglass material which has a lamination of vinyl on both sides. It features the Z-trac which zips on or off easily and which holds strongly during its lifetime of application. If required, the trac may be permanently sealed. A special inside overlap of fiberglass is part of the ZVF construction and gives added protection at the zipper trac location.

**CIRCLE NO. 499**

space is  
on our side.

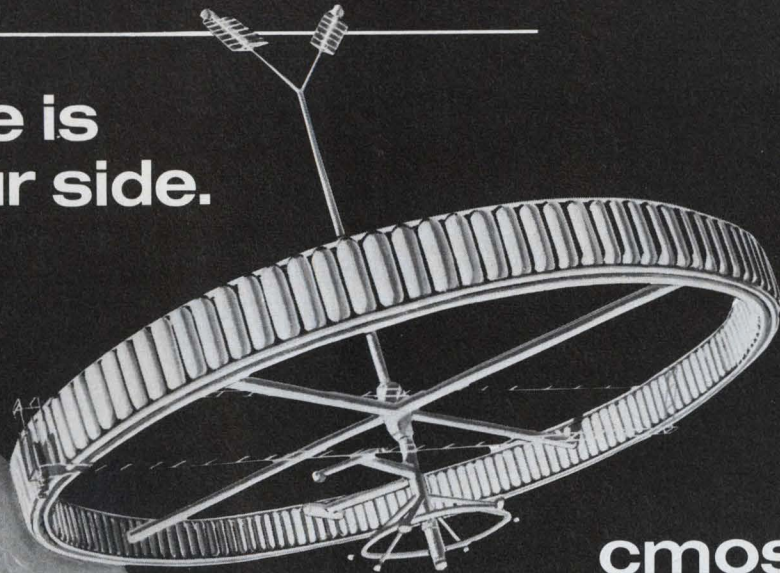

**cmos...**

**FROM SOLID STATE SCIENTIFIC**  
Leading the way into space now. Moving into new CMOS worlds every day. In the multiple mission, multi-year HEAO program, over 25 different devices from Solid State's standard SCL 4000 A series have been chosen by NASA for use in the High Energy Astronomical Observatory.

Hi-rel capability, nanowatt power dissipation, improved metallization that results in higher interconnect reliability — these are what make Solid State a leader in CMOS technology.

Exploring. Innovating. Expanding. Today, our side's made space — for you.

**SOLID STATE SCIENTIFIC, INC.**

Mon. gomeryville, Pa. 18936 • (215) 855-8400 • TWX-510-661-7269



INFORMATION RETRIEVAL NUMBER 107

who cares  
what a  
control knob  
looks like?

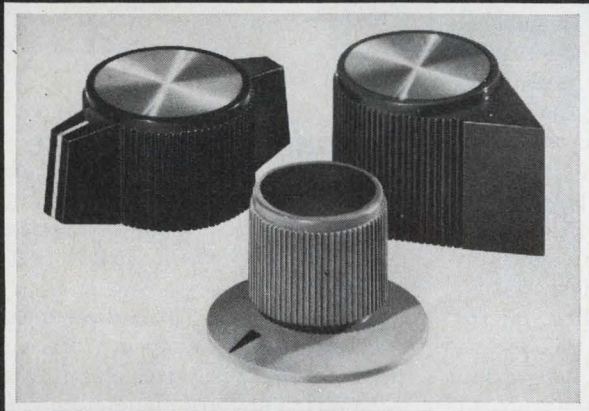

**we do.**

**ROGAN**

Outline your requirements for quotation and free knob sample. Also write for free, full-color catalog.

3455 WOODHEAD DR., NORTHBROOK, ILL. 60062, (312) 498-2300

INFORMATION RETRIEVAL NUMBER 108

ELECTRONIC DESIGN 1, January 4, 1973

## NOTHING ISOLATES LIKE OUR ISOLITES

Replace those old relays, reed relays and pulse transformers with up-to-date opto-isolators.

Litronix IsoLites give you faster switching speeds, no contact bounce, better reliability and 2500 volts electrical isolation. IsoLites can transmit from low frequency ac down to dc and eliminate ground loop problems. In long lines where common mode noise can build up, they may protect your equipment against a thousand volt jolt. Write for **free** application note and data sheets.

The   
bright guys  
**litronix**

19000 Homestead Road, Cupertino, California 95014  
(408) 257-7910 TWX: 910-338-0022

INFORMATION RETRIEVAL NUMBER 109

# Subminiature PANEL LIGHTS THAT LAST (up to 50 years)

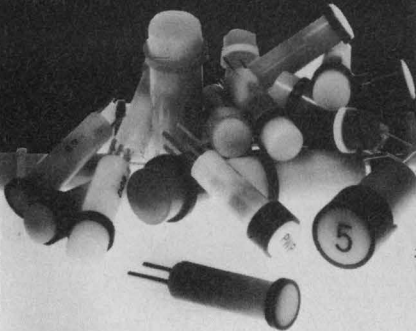

**low cost  
IMMEDIATE  
AVAILABILITY**

- LED's** (3/16" & 1/4" mtg. dia.)
- Self-Driven Incandescents**  
(built-in drivers & keep alive bias)
- Standard Neons & Incandescents**
- Customs too!**

Ruggedly built with shock proof and fully insulated bodies. ■ Attractively designed and available in several lens and collar colors. ■ Low profile and standard mounting models.

Call or write for more information today!

*the little light people*

## DATA DISPLAY PRODUCTS

8036 Westlawn Ave. Los Angeles, Ca. 90045  
(213) 641-1232

INFORMATION RETRIEVAL NUMBER 110

### PACKAGING & MATERIALS

#### Relay socket accepts proximity switches

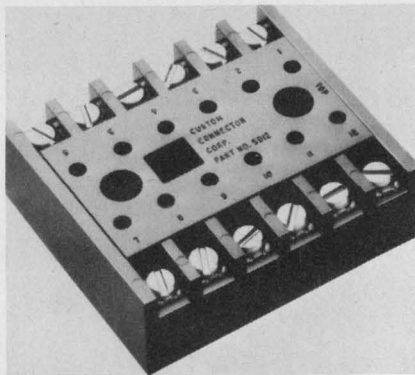

Custom Connector Corp., 1738 E. 30th St., Cleveland, Ohio 44114. (216) 241-1679.

Relay socket for 12 and 14-pin, 219 frame, plug-in relays can also be used with most 12-pin, plug-in, proximity switches. The relay socket is molded of rugged Noryl Thermo plastic resin. It has closed back construction eliminating the need for insulation.

CIRCLE NO. 500

#### Casting resins feature low dielectric constants

Emerson & Cuming, Inc., 59 Walpole St., Canton, Mass. 02021. (617) 828-3300. \$3 to \$10/lb; stock.

A line of casting resins, Stycast 35, for the microwave and electronic industries features low loss tangents below 0.001 from 60 Hz to 10 GHz and low dielectric constants. The Stycast 35 series presently contains six members: Stycast 35: a clear low-viscosity liquid which becomes pure polystyrene upon cure; Stycast 35D: upon cure it becomes cross-linked polystyrene; Stycast 35PE: a mixture of cross-linked polystyrene and polyethylene, resulting in a somewhat lower dielectric constant than Stycast 35; Stycast 35DS: filled with low-loss silica microballoons resulting in the lowest dielectric constant in the series, 1.9; Stycast 35DT: a mixture of polystyrene and polutetrafluoroethylene, it has the highest temperature capability of the series: 350 F; Stycast 35DA: mineral filled, raising the dielectric constant to 5.0 without raising the loss tangent.

CIRCLE NO. 501

#### Thick-film resistor offers high stability

E. I. Du Pont de Nemours & Co., 1007 Market St., Wilmington, Del. 19898. (302) 774-2358.

The Birox 1400 series of thick-film resistor compositions offers excellent stability after abrasive or laser trimming, with trimmed resistors drifting 0.5% or less over the entire 10 to 100-k ohms-per-square range of sheet resistivities. Trimmed resistors withstand power loadings as high as 200 W per square inch and voltage stresses as high as 3000 V per inch. The temperature coefficient of resistance for the new series is less than  $\pm 100$  ppm/ $^{\circ}$ C over the range of  $-55$  to  $125$  C.

CIRCLE NO. 502

#### Wiring duct prevents cutting wires to length

Marathon Special Products, P.O. Box 258, Bowling Green, Ohio 43402. (419) 352-1781.

A line of extruded PVC panel wiring duct and cover can be used to channel large or small amounts of wire within control panels and other places where multiple conductors are required, without the time consuming process of tying, wrapping or cutting to exact length. Duct-Dowel is used to hold up wires (by draping them over) at the time of panel assembly, and can be left in the wiring duct for later use on maintenance and changes.

CIRCLE NO. 503

#### Disconnects span wire sizes 10 to 22 AWG

Panduit Corp., 17301 Ridgeland Ave., Tinley Park, Ill. 60477. (312) 532-1800.

A line of Pan-Term disconnects provides quick, snap-in interconnections for wire sizes from 10 to 22 AWG. They are made from electro-tin plated brass to provide long, corrosion-resistant operating life. Serrated barrels are used on both male and female disconnects to assure high tensile strength and maximum wire contact after crimping.

CIRCLE NO. 504

# Now-Gordos switches in Gordos relays.

Now we don't stop with making the heart of a relay; we make the relay, too. So you can buy Gordos quality inside and out . . . and automatically get the same switches used in high-quality relays for years.

Right from the start, we're ahead with the industry's broadest line of reed switches. From there on out, the entire package is precision-engineered, produced and assembled to the same stringent standards that keep Gordos switches first.



Order off-the-shelf from our first five families of Microminiature DIP,

Miniature Molded, Miniature Open, Compact and Large reed relays. Or, throw us your special problems and see how our design and production savvy can help you meet out-of-the-ordinary needs for speed and relay performance.

Write or phone today.

Gordos Corporation, 250 Glenwood Avenue, Bloomfield, N. J. 07003; (201) 743-6800.

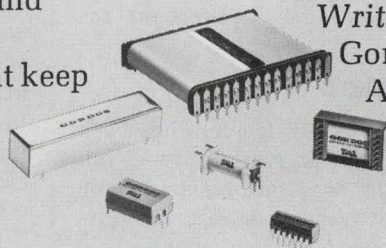

**GORDOS**  
CORPORATION

INFORMATION RETRIEVAL NUMBER 111

For wow-flutter measurements (JIS, NAB, CCIR),  
tape speed measurements,  
frequency measurements  
**A single MK-668A is the only requirement!**

Use it for wow-flutter measurements  
... tape recorders and record players.

#### SPECIFICATIONS:

##### • WOW FLUTTER MEASUREMENTS

###### Range:

0.01% to 3% in four ranges: 0.1%, 0.3%, 1%, 3% full scale.

###### Accuracy:

Within  $\pm 10\%$  full scale.

###### Meter Calibration:

Average, for NAB. Effective, for JIS. Peak, for CCIR (DIN).

##### • TAPE SPEED MEASUREMENT

###### Speed Range:

3kHz  $\pm 1$ kHz.

###### Readout Display:

4-digit counter type; unit, Hz; gate time, one second.

##### • FREQUENCY MEASUREMENT

###### Frequency Range:

10-9,999Hz.

###### Input Level:

100mV-30V.

###### Gate Time:

one second.

In addition, we product 4 kinds of wow-flutter meters, wow-flutter wave analyzers and related equipment.

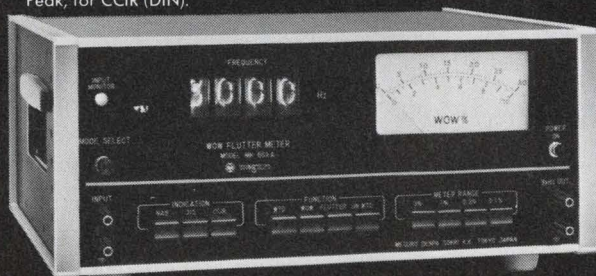

• Please see our catalog for details.



**MEGURO DENPA SOKKI K.K.**

No. 5, 1-2-chome, Chuo-cho, Meguro-ku, Tokyo, Japan  
TEL: 715-1211 Cables: MEGURODENPA TOKYO

INFORMATION RETRIEVAL NUMBER 112

ELECTRONIC DESIGN 1, January 4, 1973

## NEW Heathkit 2½ Digit DMM only 79<sup>95</sup>\*



A compact, solid-state multimeter with digital readout — at a fantastic kit-form price. The new Heathkit IM-1202 has four overlapping ranges to measure voltages from 10 mV to 1000 V on DC (either polarity), 10 mV to 700 V rms on AC, 10 uA to 2.5A on AC or DC current. Five resistance ranges measure from 1 ohm to 2.5 megohms. Front panel polarity switch reverses inputs without changing leads. 6 lbs.

## NEW Heathkit 30 MHz Counter only 169<sup>95</sup>\*



The Heathkit IB-1100 gives 1 Hz to over 30 MHz counting on a full 5-digit readout with 8-digit capability. The lighted overrange indicator makes misreading virtually impossible. Stable time-base circuitry assures accuracy better than  $\pm 3$  ppm from 22° to 37° C. Diode protected J-FET gives improved triggering over 100 mV to 150 V input range. Solid-state circuitry mounts on one large board for easy assembly. 6 lbs.

## Send for FREE '73 Catalog

HEATH COMPANY, Dept. 60-1  
Benton Harbor, Michigan 49022

- Please send FREE Heathkit Catalog.  
 Enclosed is \$ \_\_\_\_\_, plus shipping.  
Please send model(s).

Name \_\_\_\_\_  
Address \_\_\_\_\_  
City \_\_\_\_\_ State \_\_\_\_\_ Zip \_\_\_\_\_

Prices & specifications subject to change without notice.  
\*Mail order prices; F.O.B. factory.

TE-275

INFORMATION RETRIEVAL NUMBER 113



## specialist or general practitioner?

Specialist, of course... in the art of reducing or eliminating unwanted, troublesome signals from electronic circuits. Rtron specializes in the design and manufacture of RFI/EMI filters to cure virtually every electronic interference problem. UL Recognized data processing filters, MIL-F-15733 types and filters for every industrial application are readily available... from stock to custom designed, tubular, rectangular or bathtub types, in single or multi-circuit units.

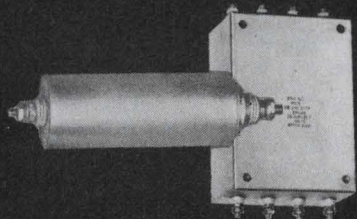

If you like our specialist, you'll like our treatment... phone or write...

# Rtron

Dept. ED-1

P.O. Box 743 Skokie, Illinois 60076  
Phone 312 • 327-4020

INFORMATION RETRIEVAL NUMBER 114

## evaluation samples

### Reed relays

A commercial reed relay (manufactured in accordance with MIL-Q-9858A) features 1 A or 20 W switching up to 250 V. Coil voltages are available for 1, 3, 5, 6, 10, 12, 15 and 24 V. The relay measures 0.275-in. diameter by 0.950-in. long and can be PC board mounted on 1-in. centers with 0.100 or 0.150-in. spacing. The relay features magnetic shielding and hermetic sealed coil for all environmental conditions. Electronic Applications Co.

CIRCLE NO. 505

### Pin headers

A range of pin headers has been extended by the availability of tall covers. The snap-on precision-made covers completely enclose the circuitry except for a small hole through which potting compound can be ejected. The 14 and 16-pin versions will house components up to 0.3 in. high; the 24-pin type will accommodate components up to 0.5 in. high. The contacts are gold plated phosphor bronze, and the body glass filled nylon Type A190. Jermyn.

CIRCLE NO. 506

### Terminals

A quick-connect wire terminal, which requires no insulation, has its point of contact covered with protective nylon. The terminal comes in two sizes. One fits 0.250 male tabs; the other 0.187 male tabs. Both can be used with Nos. 14, 16 or 18 gauge wire. Great Valley Industries.

CIRCLE NO. 507

### Antistatic cleaner

GTC-59 is a mildly alkaline preparation that cleans, degreases and imparts a hard, lustrous, water-repellent, antistatic finish to all nonporous surfaces, including glass, plastics and metals. Beaver Laboratories.

CIRCLE NO. 508

### Temperature recorders

Model 442A, a four-position temperature recorder reported to be the world's smallest, features an accuracy of  $\pm 1\%$ . It indicates temperature in ranges from 110 F to 450 F (or 43 C to 232 C). When exposed to the rated critical temperature, the indicator window turns from pastel to black for a direct readout which is permanent and irreversible. The recorder is self-adhesive. William Wahl Corp., Temp-Plate Div.

CIRCLE NO. 509

### Epoxy casting system

TRA-CAST 3109 is a two-part, solvent-free formulation designed for production potting, casting and coating applications. Color coded for easy mixing, this epoxy system cures in just a few hours at room temperature, with very low shrinkage and exotherm, making it suitable for larger mass castings (up to one gallon) and other large pour applications. Tra-Con, Inc.

CIRCLE NO. 510

### Bridging clip

A bridging clip electrically interconnects adjacent terminals in the same row of 66 Type connecting blocks. The clip, stamped of stainless steel, slips over the terminals with just finger pressure, eliminating laborious interconnecting by wire. Removal is just as quick and easy. Fastex, Div. Illinois Tool Works Inc.

CIRCLE NO. 511

### Slotted fastener

SwissLok is a fastener for joining sheet metal plates at right angles. Looking like the cross-section of a split rivet, the split has the configuration of a keyslot. The fastener is inserted through the opening of one sheet metal plate and the split portion straddles the edge of a second plate which is perpendicular to the first plate. A single blow with a hammer or air tool on the head of the fastener locks the two plates together. Waldman Corp.

CIRCLE NO. 512

## design aids

### Power transistors

A wall chart describes a complete range of high-current, high-voltage silicon power transistors. Major specifications of each type are included for device selection. Each chart includes a postage-paid reply card enabling you to receive a complete catalog with detailed specifications and price lists. Powertech, Inc.

CIRCLE NO. 513

### Tantalum capacitor chart

A 16-page Established Reliability Tantalum Capacitor Conversion Chart compares the electrical, acceptance inspection test and marking requirements between MIL-C-39003C and MIL-C-39003A. The chart cross-references military part number designations and dash numbers for CSR13 capacitors from the original MIL-C-39003 specification through to the present C revision. Also included are capacitor outline drawings and dash number listings for CSR09, CSR13, CSR23 and CSR91 capacitors with a cross-reference to equivalent KEMET capacitor part numbers. Union Carbide Corp.

CIRCLE NO. 514

### Multilayer board guides

A wall-chart provides design information on multilayer boards. Graphs and tables describe various conductors, conductor plating, layout tolerances and dimensions, laminates, voltage between conductors and general specifications. A table outlines required specifications. Lockheed Electronics, Data Products Div.

CIRCLE NO. 515

### Data conversion chart

All you want to know about data conversion is on a handy wall chart. The design reference guide includes calculations, terminology, theory, tables, codes and other reference information. Analogic.

CIRCLE NO. 516

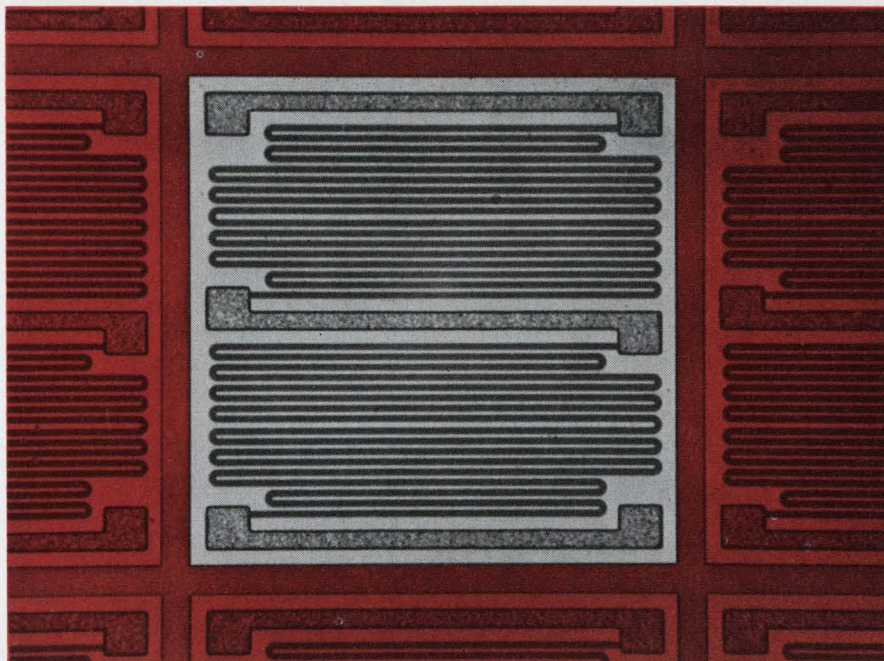

## New passivated thin-film resistor chips and wafers

from HYBEX a new division of Burr-Brown

Here's a new series of glass passivated thin-film resistors from a new, dependable source — Hybex. The unique "S" configuration, originated by Hybex personnel, greatly simplifies hybrid assembly.

Since these center-tap resistors contain three pairs of large surface aluminum bond pads, the operator can accomplish straight line wire bonding without reorientation of the 30 mil chip. Gold silicon backing also allows the use of all conventional die bonding techniques including eutectic and epoxy.

#### HYBEX "S" SERIES RESISTORS

- Temperature Coefficients: ● Standard Resistance Value Range:
  - Standard  $\pm 50\text{ppm}/^\circ\text{C}$  1% tolerance, 10 ohms to 510 kohms
  - Custom  $\pm 10\text{ppm}/^\circ\text{C}$  5% tolerance, 10 ohms to 510 kohms
  - tracking to  $\pm 5\text{ppm}/^\circ\text{C}$  10% tolerance, 10 ohms to 470 kohms
- Available as wafers or chips.
- Power Dissipation: 250 mw.
- All units 100% probe tested and visually inspected.

#### FOR COMPLETE TECHNICAL INFORMATION

use this publication's reader service card or contact Hybex.

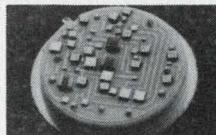

#### HYBEX CUSTOM CIRCUITS, TOO!

Let Hybex assist you with your unique thin and thick film hybrid and monolithic circuit requirements. For details on our custom circuit capability, contact Mr. Dennis Haynes, your Hybex man in Tucson.

# HYBEX

INTERNATIONAL AIRPORT INDUSTRIAL PARK  
Tucson, Arizona 85796  
TEL.: 602-294-1431 • TWX: 910-952-1111

A division of Burr-Brown

# application notes

## CMOS expandable gates

A technical bulletin outlines functions and circuitry of CMOS expandable gates. The bulletin describes the company's method of employing added buffer stages and is complete with diagrams on the configurations possible. Tables on dynamic and output-drive characteristics as well as circuit capabilities and over-all performance characteristics are included. Solid State Scientific, Inc., Montgomeryville, Pa.

CIRCLE NO. 517

## Microprogrammed control

"Economic Advantages of Microprogramming" contains a descriptive breakdown of the costs incurred in putting an integrated circuit into a system. These expenses are then compared with the cost of microprogrammed control, which is presented as an alternative to random logic. The brochure reviews the types of control memory elements currently being used, such as read-only memories, random-access memories and fusible read-only memories which are programmed by the user. Signetics Memory Systems, Sunnyvale, Calif.

CIRCLE NO. 518

## Dielectric products

"Dielectric Products and Their Applications" provides useful technical descriptions and applications of many resin and dielectric products. In some cases chemical formulations are given. The lines which are discussed include casting resins, adhesive systems, impregnating resins, molding compounds, ceramic encapsulants, glass, ceramic and plastic microballoons, silicone resins, plastic and ceramic foams, dielectric sheet and rod stock and syntactic foams for underwater buoyancy. Emerson & Cuming, Inc., Dielectric Materials Div., Canton, Mass.

CIRCLE NO. 519

## Broadband receiver design

"Design of a Communications Security Test Receiver for Maximum Broadband Dynamic Range" describes the problems associated with detection of broadband signals, offers insight into the solution of those problems and presents the required receiver design techniques to maximize broadband sensitivity and linear, instantaneous dynamic range. Points stressed are 1) application of successive filtering of the receiver channel and 2) maximizing signal handling capability. The related considerations concerning local oscillator rejection for maximization of tuning range and equipment shielding are also presented. American Electronic Laboratories, Inc., Lansdale, Pa.

CIRCLE NO. 520

## SCR protection

A bulletin on a high-power semiconductor series explains and illustrates the major causes of voltage transients in typical thyristor converter circuits and the basic approaches to transient protection to prevent malfunction or device failure. Nine fundamental suppression schemes are explained and compared for relative size, cost and complexity. A reference listing directs the designer to information for specific applications. Most of the seven-page publication is devoted to circuit illustrations. Westinghouse Electric Corp., Youngwood, Pa.

CIRCLE NO. 521

## Capacitor diodes

More than 300 JEDEC registered types of voltage-variable capacitors are described in a four-page catalog. Specifications presented are nominal capacitance and tolerances, tuning ratio, voltage ranges over which tuning ratio is valid, temperature coefficient of capacitance, Q, leakage, etc. Also included is design information such as Q as a function of voltage and frequency and capacitance vs temperature. Codi Semiconductor, div. of Computer Diode Corp., Fair Lawn, N.J.

CIRCLE NO. 522

## Consumer ICs

"New Developments In Consumer Integrated Circuits" reviews present state-of-the-art technology, including the continuing development of ion implementation. Technology improvements are illustrated by means of available products in TV-FM and automotive fields which utilize ion implementation. Sprague Electric Co., N. Adams, Mass.

CIRCLE NO. 523

## Neon lamps

"Miniature Neon Lamps: Elements of Electronic Versatility," a 127-page book, gives detailed information on aspects of construction and application as indicators, in voltage regulation and reference and as electronic circuitry components. A handy reference to the characteristics of most available neon lamps is included. Glowlite Corp., a subsidiary of El-Tronics, Inc., Pauls Valley, Okla.

CIRCLE NO. 524

## Troubleshooting motors

Common fractional horsepower motor troubles and their causes are examined in the company's Motorgram (Vol. 52, No. 5). Bodine Electric Co., Chicago, Ill.

CIRCLE NO. 525

## Optimizing microstrip lines

Two papers discuss the construction and performance of microcircuit components built on a substrate of pure fused silica. "Hybrid Microwave Integrated Circuits for Millimeter Wavelengths," by members of The General Electric Co., Wembley, England, describes microstrip transmission lines 500  $\mu\text{m}$  wide on 250  $\mu\text{m}$  thick fused silica with 50- $\Omega$  characteristic impedance. "Low-Loss Microstrip Filters Developed by Frequency Scaling" published in the Bell System Technical Journal, reports building of low-pass and bandpass microstrip filters up to 30 GHz on fused silica substrates by photolithic reduction of optimized low-frequency models. Dynasil Corp. of America, Berlin, N.J.

CIRCLE NO. 526



Do you face a make or buy decision on power supplies?

# BUY THE NEW LAMBDA LY SERIES

**>50% efficient, 20 KHz switching,  
50mV P-P ripple, 0.1% line or load regulation**

**SINGLE OUTPUT**

**\$300**

**5 VOLTS 30 AMPS  
WITH OVERVOLTAGE  
PROTECTION BUILT-IN**

**DUAL OUTPUT**

**\$380**

**±15 TO ±12 VOLTS  
8.5 AMPS EACH OUTPUT**

**TRIPLE OUTPUT**

**\$395**

**5 VOLTS 18 AMPS  
DUAL ±15 TO ±12 VOLTS  
2 AMPS EACH OUTPUT**

**QUADRUPLE OUTPUT**

**\$450**

**5 VOLTS 16 AMPS  
DUAL ±15 TO ±12 VOLTS  
1.5 AMPS EACH OUTPUT  
24 TO 28 VOLTS 1.0 AMPS**

AC input: 105-132 VAC, 47-440 Hz  
DC input: 145 VDC ±10%

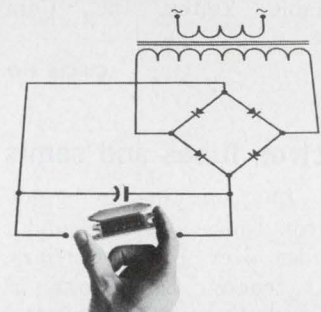
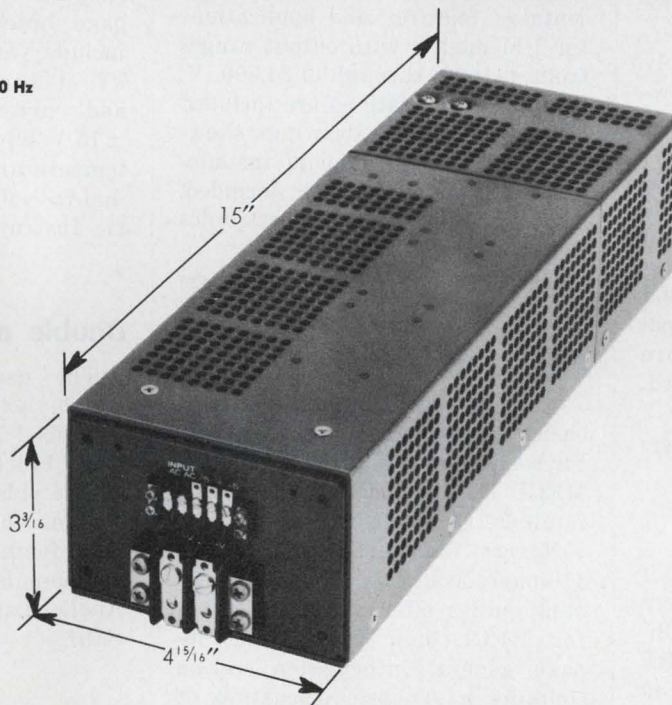

11 standard models in single, dual, triple or quadruple outputs in new "5" package. Triple and quadruple output models incorporate Lambda Power Hybrid Voltage Regulator.

**ALL CARRY LAMBDA'S 5-YEAR GUARANTEE.  
ALL IN STOCK FOR 1-DAY DELIVERY.**

**WHETHER  
YOU MAKE  
OR BUY...  
LAMBDA  
ELECTRONICS CORP.**  
A Veeco Company

MELVILLE, NEW YORK 11746 515 Broad Hollow Road Tel. 516-694-4200 ARLINGTON HEIGHTS, (CHICAGO) ILL. 60005 2420 East Oakton St., Unit Q Tel. 312-593-2550  
NORTH HOLLYWOOD, CALIF. 91605 7316 Varna Ave. Tel. 213-875-2744 MONTREAL, QUEBEC 100C Hymus Blvd., Pointe-Claire, Quebec-730 Tel. 514-697-6520

INFORMATION RETRIEVAL NUMBER 116

# new literature



## Linear & data conversion

A 16-page guide describes a line of linear products, data conversion modules, multichannel a/d conversion systems and power supply modules. Forty-eight modular power supplies are listed, including miniature DIP compatible supplies offering ac to dc and dc to dc conversion, and single, dual and triple outputs. Electrical and mechanical specifications as well as photos, general descriptions, graphs and circuit diagrams are included. Price and ordering information are available. Zeltex, Inc., Concord, Calif.

CIRCLE NO. 527

## Electron tubes and semis

A 100-page buyers guide of electron tubes and semiconductors includes over 1400 rectifiers, diodes, zeners, transistors, SCRs, FETs and unijunctions. A complete listing of foreign tube types is included. Prices are given. United-Page, Inc., Paterson, N.J.

CIRCLE NO. 528

## Disc storage

A two-color, single-sheet Data Bulletin describes Fastrack 010 Series Disc Storage Systems. Pacific Micronetics, Inc., San Diego, Calif.

CIRCLE NO. 529

## Dc-dc power converters

A two-page data sheet describes a line of ultraminiature dc-dc converters designed specifically to power linear ICs and a/d-d/a converters. It gives both electrical and mechanical specifications plus performance features. Included is a selection guide which categorizes dc-dc converters according to input/output (volts and current), line/load regulation data, price information plus complete operating specifications. Datel Systems, Inc., Canton, Mass.

CIRCLE NO. 530

## Dc power supplies

The UM Series of miniature, solid-state, high-voltage dc power supplies are described in Bulletin UM792. The two-page data sheet contains features and applications for UM models with output ranges from 0-1000 through 0-24,000 V. Detailed specifications are included along with outline drawings showing case sizes. Complete installation instructions are included. Spellman High Voltage Electronics Corp., Bronx, N.Y.

CIRCLE NO. 531

## MECL book

"MECL Data Book" contains basic performance specifications for each IC device in the MECL II, MECL III and MECL 10,000 logic families. Complete dc, ac and performance data are given in the 410-page book. Convenient abbreviated guides offer a quick selector for MECL logic blocks. The 36-page general information section contains a synoptic discussion of topics of value to the designer planning a MECL system. In addition, dimensioned drawings of MECL packages are shown. References to the MECL software support available are included by way of application note abstracts, as well as references to a sampling of MECL articles in the trade press. The book is available at \$2 per copy. Motorola, Inc., P.O. Box 20924, Phoenix, Ariz. 85036.

## Technical services

A booklet describes the company's analysis and characterization services for the electronics industry. Typical of the services available is trace analysis or solid or liquid raw materials such as graphite, silicon, germanium, III-V and II-VI compounds and alloys, ferrous, nonferrous oxides, garnet and ceramics and other related materials such as glass and plastics. Techniques employed include emission spectroscopy, spark source mass spectroscopy, infrared absorption spectroscopy and electronic microprobe analysis. The company also is offering structure characterization through X-ray diffraction, electron scanning microscopy and electron microprobe analysis. Monsanto Commercial Products Co., St. Louis, Mo.

CIRCLE NO. 532

## Negative hv power supplies

Negative high-voltage power supplies are described in a two-page brochure. Features detailed include variable high voltage to 2 kV at 10 mA, low ripple, voltage and current monitoring, separate  $\pm 15$  V supply for op-amp drive, low temperature coefficient and easy dial-in voltage. Pacific Photometric Instruments, Emeryville, Calif.

CIRCLE NO. 533

## Double exposure holography

The uses and applications of double exposure holography are described in a four-page brochure. The brochure discusses how a double-pulse hologram is made as well as the specifications and design features of the Model 22HD double-pulse holographic laser. Apollo Lasers, Inc., Los Angeles, Calif.

CIRCLE NO. 534

## One-chip calculator-memory

The CT5005, claimed to be the industry's first MOS four-function 12-digit chip with a register for memory or constant operation, is described in an eight-page brochure. The k feature is operated by recalling the k number from memory. Cal-Tex Semiconductor, Inc., Santa Clara, Calif.

CIRCLE NO. 535

# 350 MHz

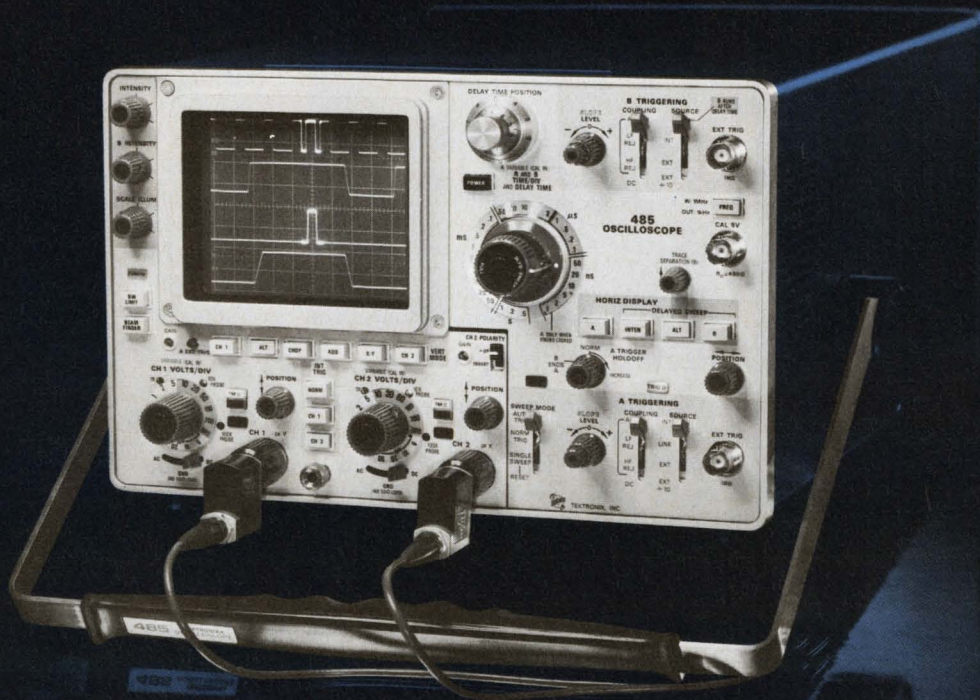

## in a portable laboratory oscilloscope that weighs only 23 pounds.

The dual-trace, 350-MHz TEKTRONIX 485 Oscilloscope is the newest addition to the world's most widely used portable family. Many features of earlier TEKTRONIX portables are retained, many others are expanded and a lot of new ones are added. The result is a new product which significantly expands the performance spectrum of portable scopes. Following are some of the features of the 485, an oscilloscope which measures with laboratory precision and carries with small-package ease.

**350-MHz Bandwidth at 5 mV/Div**—More dual-trace high frequency measurement capability at 5 mV/Div than any other laboratory-quality scope—portable or cabinet.

**1-M $\Omega$  and 50- $\Omega$  Selectable Inputs**—Scope circuitry automatically disconnects the 50- $\Omega$  inputs when signals exceed 5 V RMS or 0.5 watts to protect your equipment.

**Time Resolution to 1 ns/Div**—More time resolution than any other portable. And it's direct reading.

**A-External Trigger**—Just press this button to display the external trigger signal and quickly verify your trigger source or check timing reference.

**Alternate Sweep Switching**—View intensified waveforms and delayed waveforms at the same time. When you move the intensified zone you always know precisely where you are, and still see the delayed waveform. It saves time and adds operation convenience.

Weight without accessories, just 20½ lb (23 lb with accessories). As much as 30% lighter than other portables which have only 150-MHz bandwidth.

For complete information or to arrange a demonstration, contact any TEKTRONIX Field Office. Our offices are located in or near major cities and industrial centers—worldwide. If you prefer, write Tektronix, Inc., P.O. Box 500, Beaverton, Oregon 97005. In Europe, write Tektronix Ltd., P.O. Box 36, St. Peter Port, Guernsey, C.I., U.K.

485 Oscilloscope ..... \$4200  
U.S. Sales Price FOB Beaverton, Oregon



**TEKTRONIX®**

committed to  
technical excellence

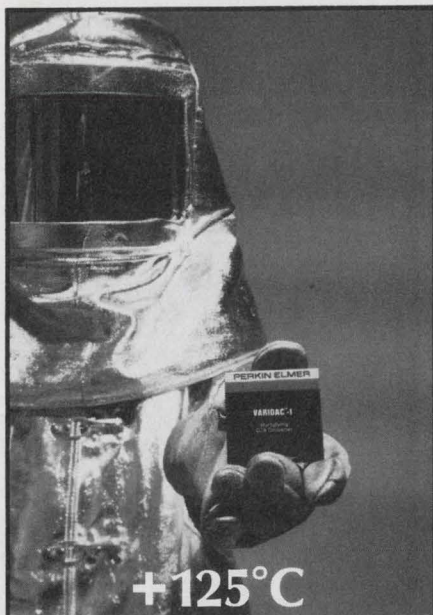

## doesn't bother our Multiplying D/A Converters a bit. (not even half a bit)

Over the range of  $-55^{\circ}\text{C}$  to  $+125^{\circ}\text{C}$  you maintain half bit accuracy, as well as 11 or 12 bit resolution — a stability which spans a full  $180^{\circ}\text{C}$ . This high performance level of Perkin-Elmer multiplying digital to analog converters is based on the utilization of our patented principal of vernier transformer windings. There is no drift or degradation over the life of the unit.

Each MD/A unit is encapsulated in a rugged package containing a series of windings switched by MOSFET IC's. The digital logic inputs are directly compatible with TTL and DTL devices without level shifting or pull up resistors.

These precision converters have wide applications in synchro and servo controls, interfacing digital and analog systems, for shipborne or air data computers, fire control systems and in drivers for analog display.

Numerous applications in the machine tool and process control industries are also possible since the frequency range is not limited to 400 Hz. For information on either standard Series 2000 models, or custom units for a specific application, just write or call: Electronic Products Department, Industrial Products Division, The Perkin-Elmer Corporation, Main Avenue, Norwalk, Connecticut 06856. (203) 762-4786. Vernistat® AC pots, Scott T's and other toroidal transformers are specialties of ours too.

**PERKIN-ELMER**

INFORMATION RETRIEVAL NUMBER 118

## NEW LITERATURE



### Heathkit catalog

Included in the Heathkit Catalog are color TVs, audio equipment, marine gear, amateur radio equipment, an electronic calculator, security systems and intercoms. More than a dozen pages are devoted to test and service instruments, plus educational kits. Heath Co., Benton Harbor, Mich.

CIRCLE NO. 574

### Transistor test system

A 28-page brochure describes both the hardware and the software of the company's T347 computer-operated transistor test system. Sections are included on test techniques, end-of-life programs, automatic distribution analysis, as well as a basic system description and a section on applications. Tera-dyne, Inc., Boston, Mass.

CIRCLE NO. 537

### COS/MOS IC products

"COS/MOS ICs," an eight-page catalog, contains logic diagrams with terminal designations and quick selection data charts for 52 ICs including gates, flip-flops, latches, multivibrators, shift registers, counters, display/counter/decoders/drivers, multiplexers, arithmetic circuits, memories and phase-locked loop. Information on COS/MOS high-reliability types conforming to MIL-STD-883 and MIL-M-38510, COS/MOS chips and COS/MOS technical publications are given. RCA Solid State Div., Somerville, N.J.

CIRCLE NO. 538

## Designing computer logic

Techniques and procedures used in designing, building and assembling computer logic systems and interfaces for PDP-series computers are described in the 225-page Logic System Design Handbook. The illustrated handbook is designed as a complement to the annual Logic Handbook and is keyed principally to the utilization of the company's logic modules and supporting hardware and accessories. It can also be used as a reference work in designing other types of logic circuits. Step-by-step procedures for assembling and wiring are included. Digital Equipment Corp., Maynard, Mass.

CIRCLE NO. 539

## Green glow lamps

Catalog GG-72 illustrates and describes green glow lamps and indicators. The catalog provides specification data on lamps, cartridge lamps, indicator lights and holders. Inter-Market, Inc., Glenview, Ill.

CIRCLE NO. 540

## Active filter nomograms

A brochure on active filters compares the performance of Butterworth, Chebyshev, Causer, and other standard filter types and provides easy-to-use nomographs for estimating filter complexity. A data sheet is included which lists various parameters which should be part of most active filter specifications. A standard product selection matrix enables active filter designers and users to select the Universal Active Filter most suited to their needs. Kinetic Technology, Inc., Santa Clara, Calif.

CIRCLE NO. 541

## EDP directory

The 1972 EDP Industry Directory covers computers, peripherals, terminals, special-purpose systems, communications equipment, auxiliary equipment, supplies and accessories, software and services. Single copy price is \$25. Order direct from Technical Publishing Co., EDP Industry Directory, 1301 S. Grove Ave., Barrington, Ill. 60016.

## Miniature lamps

A 40-page catalog covers descriptions and specifications for over 470 different miniature and sub-miniature incandescent and solid-state lamps. Complete operating parameters on each lamp are provided plus outline drawings with all necessary dimensions shown. An index is also included to show equivalent LAMPS model numbers and American National Standards Institute numbers to simplify selection. LAMPS, Inc., Torrance, Calif.

CIRCLE NO. 542

## Cermet trimmer

A low-profile, cermet trimming potentiometer, measuring only 0.15-in. high, is the subject of a catalog sheet. Beckman Instruments, Inc., Fullerton, Calif.

CIRCLE NO. 543

## Time sharing recorder

A thermistor probe and strip chart, which extends the range of the Model LT8200 recorder making it suitable for monitoring air conditioning and heating equipment, is described in a catalog sheet. Two other recorders described are a current recorder and a recording volt/ammeter. Amprobe Instrument, Div. of SOS Consolidated, Inc., Lynbrook, N.Y.

CIRCLE NO. 544

## ROMs

High-speed read-only-memories are described in data sheets. Aztec Data Systems, Irvine, Calif.

CIRCLE NO. 545

## Printer/plotter

A six-page illustrated brochure describes the CPE-57 Complot printer/plotter. The brochure outlines the functions of the printer/plotter in producing charts, graphs, alphanumerics, maps, drawings and other graphics using the electrostatic principle of operation. Applications ranging from weather maps to phototype setting are listed. Also included is a description of computer graphics plotting, non-impact line printing and software, as well as pricing and ordering information. Houston Instrument, Bellaire, Tex.

CIRCLE NO. 546

# OUR CODES ARE NO SECRET



We discovered recently that we have more standard output codes available for our Thumbwheel switches than anyone else in the business. Actually, it has become difficult to catalog all the choices we offer.



So, we printed a wall chart that shows the standard switches we make and 68 off-the-shelf truth tables. You can select the switch that best suits your needs. And cross check it for availability with the code you want.

Send for a wall chart now. Our codes are no secret.

See us in EEM 72-73  
Vol. 2 Pages 2116-2117

THE **DIGITRAN**<sup>®</sup> COMPANY  
A Division of Becton, Dickinson and Company **B-D**

855 So. Arroyo Parkway / Pasadena, Ca. 91105 / Tel. (213) 449-3110 / TWX 910-588-3794

INFORMATION RETRIEVAL NUMBER 119

# NEW SHORTER CASE! SCHAUER 1-WATT ZENERS

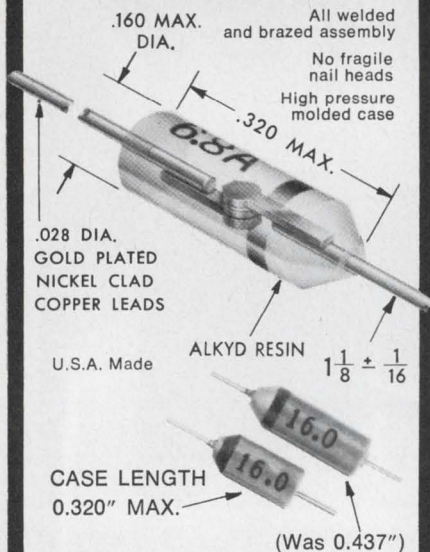

**SAME LOW PRICES FOR  
1% TOLERANCE ZENERS  
ANY VOLTAGE  
FROM 2.0 TO 18.0**

Quantity	Price Each
1-99	\$1.07
100-499	.97
500-999	.91
1000-4999	.86
5000 up	.82

**IMMEDIATE SHIPMENT**  
Send for rating data and  
20%, 10%, 5% and 2%  
tolerance prices.

Semiconductor Division

## SCHAUER

MANUFACTURING CORP.

4511 Alpine Ave., Cincinnati, Ohio 45242  
Telephone 513/791-3030

## NEW LITERATURE

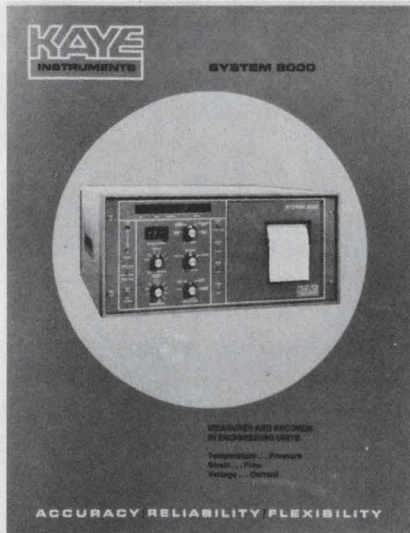

### Data system

An automatic data system for measuring and recording in engineering units temperature, pressure, strain, flow, voltage and current is described in a 12-page catalog. Kaye Instruments, Inc., Cambridge, Mass.

CIRCLE NO. 547

### Analog multipliers

The GPS MU4100 series multipliers are described in a four-page bulletin. The miniature components need no external operational amplifiers. GPS Corp., Framingham, Mass.

CIRCLE NO. 548

### Stepping switches

Catalog No. 601 provides detailed information on open or enclosed, spring-driven or direct drive, bracket-mounted or quick-mount stepping switches. The 56-page publication includes a thorough introduction to the design and construction of stepping switches, its uses, its physical and electrical characteristics, its circuitry, optional features and when to specify the switches, switch accessories and maintenance tools, plus a guide to selecting the proper switch. For each individual switch, the catalog offers complete physical and electrical specification data plus dimensional illustrations, mounting detail and full performance information. C.P. Clare & Co., Chicago, Ill.

CIRCLE NO. 549

### Rectilinear potentiometers

The Model 910 series of plastic rectilinear potentiometers are specified in a bulletin. Available in a variety of sizes and in linear and nonlinear functions with center taps, the high resolution pots operate efficiently when exposed to hostile environments, such as, jet fuel or hydraulic fluid. Outlined in the bulletin are the electrical characteristics of the rectilinear potentiometers. Amphenol Connector Div., Controls Operations, Broadview, Ill.

CIRCLE NO. 550

### Neon-tube applications

A convenient index of over 400 articles and letters which have appeared in the company's Application News lists each item by title, volume and number of the issue in which it appeared, as well as by the consecutive page number. Topics covered are neon glow lamps that are used as active components in electronics and as indicators in electrical equipment and high-energy devices which include spark gaps, transient surge protectors, noise sources and high-energy switches. Signalite, Neptune, N.J.

CIRCLE NO. 551

### Capacitor matrices

Fourteen-pin DIP multi-layer ceramic capacitor matrices are described in two bulletins. The NPO Series 6900 accommodates up to 12 capacitors in a single unit and range from 50 to 500 pF at 50 V dc. The BX Series 6910C provide for installation of up to seven capacitors and range from 500 pF to 0.1  $\mu$ F at 50 and 100 V dc. Both units are manufactured in accordance with MIL-C-39014. The Potter Co., a div. of Pemcor, Inc., San Diego, Calif.

CIRCLE NO. 552

### Flat-cable edge connectors

Data Sheet 208 describes flex-strip flat-cable edge-connector assemblies. The assemblies combine Series 608 connectors (which use the flat-cable conductors as contacts) and standard 0.100-pitch flat cable. Complete data and specifications are included. Ansley Electronics Corp., Doylestown, Pa.

CIRCLE NO. 553

## Data conversion

A short form catalog describes data conversion and display products. The 12-page brochure offers specifications, applications and pricing. Analogic, Wakefield, Mass.

CIRCLE NO. 554

## Connectors

Leaflets cover screwed GP connectors, BNC high-voltage connectors, connector-to-cable assemblies and a 70-MHz passive probe kit. Greenpar Engineering Ltd., Essex, England.

CIRCLE NO. 555

## Motor information kit

An information kit contains eight separate catalogs containing full information on transistorized, SCR, ac, and autotransformer motor speed controls; and synchronous, instrument and torque motors. B & B Motors and Control, New York, N.Y.

CIRCLE NO. 556

## Microwave tunnel diodes

Major electrical specifications of the company's diodes are detailed in a four-page brochure. Devices listed are microwave tunnel diodes, microwave oscillator diodes, germanium video detector and back diodes, gallium arsenide varactor and avalanche diodes and picosecond switching tunnel diodes. Micro State Products, Raytheon Co., Waltham, Mass.

CIRCLE NO. 557

## EMR 6140 manual

The 6140 Mission-Matched computer system is described in a 20-page manual. The manual details ways in which the system performs concurrent real-time and background batch processing. It also describes the unit's unique architecture and flexible software usually found only on larger, more costly machines. The manual details hardware and software features, real-time applications, systems capabilities, a full range of available peripherals, and the systems instruction set. It is illustrated with photographs and diagrams. EMR Computer, Minneapolis, Minn.

CIRCLE NO. 558

# What's your magnetic field?



## RFL covers them all...

- Magnetization
- Stabilization
- Measurement

When it comes to magnetic instrumentation, come to RFL. You'll profit from our more than three decades of experience . . . and the most complete line of quality engineered equipment available anywhere.

RFL magnetic measuring instruments provide precise determination of flux densities from as low as a few gamma to as high as 50,000 gauss. Our magnet chargers provide energy capacities ranging from 18 to 10,000 joules . . . enough for almost any permanent magnet including the rare earths. And the RFL Magnetreater® provides precision adjustment and stabilization of magnets and magnetic assemblies.

Equipment is just a part of our service. We also provide application engineering assistance . . . free fixture design for processing magnets and magnetic assemblies . . . and, where needed, complete systems for semi-automatic or automatic processing of permanent magnets or assemblies.



Call or write today for full information.

**RFL Industries, Inc.**

Instrumentation Division • Boonton, N. J. 07005

Tel: 201 • 334-3100/TWX: 710-987-8352/CABLE: RADAIRCO, N. J.

**BOEING**

# Engineers. Experienced or Beginning

Opportunity is knocking in the Pacific Northwest Aerospace industry.

The Seattle area, a great place to live and work, has challenging aerospace opportunities in varied commercial and military programs. Especially...

- Analysis of EMP effects. RF communications, including antennas, link analysis, and equipment design. RF and microwave circuit design.

- Design and implementation of subsystems level status monitoring, fault detection and fault isolation.

- Design of subsystems impedance matching circuitry, amplifiers and monitoring circuitry.

- RF equipment specification preparation, proposal evaluation, performance determination and monitoring of subcontracts for HF and VHF equipment.

Please send your resume to the Employment Office, The Boeing Company, P.O. Box 3707-EAD, Seattle, Washington 98124.

**BOEING**  
An Equal Opportunity Employer

## NEW LITERATURE

### Power supplies

A 16-page, four-color catalog describes electronic instruments, power supplies and industrial controls. Products featured are laboratory bench power supplies, sub-unit power supplies, signal sources, telecommunications test equipment, digital and analog measuring instruments plus a digital logic instructional kit. Farnell Instruments Ltd., Yorkshire, U.K.

CIRCLE NO. 559

### Microwave instruments

A microwave instrument catalog summarizes specifications for modular signal generators and signal sources, receivers, field intensity meters, antennas and spectrum analyzers. Polarad Electronic Instruments, Lake Success, N.Y.

CIRCLE NO. 560

### Thermal cutoffs

The Microtemp thermal cutoffs are outlined in the six-page brochure MD-149. Micro Devices Corp., Dayton, Ohio.

CIRCLE NO. 561

### General-purpose computer

The Model DC 6024/5, a 24-bit general-purpose computer, is featured in a two-color, 12-page brochure. Specifications, configurations and software are covered. Datacraft, Fort Lauderdale, Fla.

CIRCLE NO. 562

### Control devices

All-solid-state control devices—timers, photoelectrics, resistance sensing relays and multiple relays—are described in a condensed catalog sheet. Regent Controls, Inc., Stamford, Conn.

CIRCLE NO. 563

### Bisync analyzer

A specification sheet describes the Model 810 bisync line control analyzer. Paradyne Corp., Clearwater, Fla.

CIRCLE NO. 564

## vendors report

Annual and interim reports can provide much more than financial-position information. They often include the first public disclosure of new products, new techniques and new directions of our vendors and customers. Further, they often contain superb analyses of segments of industry that a company serves.

Selected companies with recent reports are listed here with their main electronic products or services. For a copy, circle the indicated number.

**Mohawk Data Sciences Corp.** Data processing systems and peripherals, source data collection systems, keyboard switch assemblies and tape drives.

CIRCLE NO. 565

**Tandy Corp.** Consumer electronics, components, TV antennas, magnetic tapes and hobby kits.

CIRCLE NO. 566

**Parker-Hannifin Corp.** Aerospace and components.

CIRCLE NO. 567

**General Automation, Inc.** Mini-computers.

CIRCLE NO. 568

**Avnet, Inc.** Electronic components, entertainment and high-fidelity products and computers.

CIRCLE NO. 569

**Western Digital Corp.** MOS/LSI.

CIRCLE NO. 570

**Systems Engineering Laboratories.** Computers.

CIRCLE NO. 571

**Beckman Instruments, Inc.** Medical electronics, analytical and pollution control instruments, industrial instrumentation and components.

CIRCLE NO. 572

**Lundy Electronics & Systems, Inc.** Computers, military electronics and environmental systems.

CIRCLE NO. 573



## EXPORT SALES

Experienced Tokyo, Japan, team of graduate-engineer (EE) representatives wishes to contact USA manufacturers of

Semiconductor-Test Equipment  
Production Equipment-Production Materials

**American Commercial Inc.**

2266 Stockbridge Avenue  
Woodside, California 94062

(415) 366-0353

INFORMATION RETRIEVAL NUMBER 901

**Get a jump on tomorrow,  
save today.**



**Take stock in America.**

With higher paying U.S. Savings Bonds.

## MICROWAVE ENGINEERS

**Design-Project**

Our O.E.M. sales programs offer attractive assignments with lots of future. Degree, with up to 1-3 years of microwave experience preferred.

OTHER OPENINGS INCLUDE:

### Technicians Jr.&Sr.

Microwave experience preferred. Will work with test procedures and microwave passive devices.

### Technical Writer

Technical writing experience required. Microwave experience preferred. Must be capable of writing test plans.

You'll join a thriving division for a strong, diversified company, attuned to today's opportunities. New England location offers advantageous living year round. Salaries open, based on qualifications; plus outstanding company paid benefits.

Please send confidential resume including salary history and requirements to Personnel Dept.

### TIMES WIRE & CABLE COMPANY

*A Subsidiary of Insilco Corporation*

358 Hall Avenue  
Wallingford, Conn. 06492

*An Equal Opportunity Employer M/F*

INFORMATION RETRIEVAL NUMBER 902

**PERSONNEL  
RECRUITMENT  
ADVERTISING**

**IN**

**Electronic Design**

**REACHES THE**

**RIGHT PEOPLE**

**AT A LOWER COST**

**PER THOUSAND**

*Call the  
HOTLINE*

*today*

*for complete*

*information:*

*(201) 843-0550*

*extension 209*



**New Low Cost Time Code Translator.**

Advances technology of Astrodata product line acquisition. Translates all serial time code inputs into parallel BCD or binary outputs. Plug-in TTL logic modules offer compatible interface to any related equipment. Most readable 7-segment displays of days/hrs/min/sec are gas discharge type. MOXON, SRC DIV. CIRCLE 122

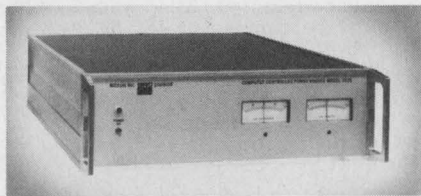

**New Computer Compatible, Programmable DC Power Source.**

Automatic systems use. Output 100V @ 0.5A or 50V @ 1A. 16-bit binary or 8-4-2-1 BCD. Hi speed — over 10 kHz. Noise and ripple 800 uv p-p max. Load transient recovery 30 μsec. Data circuit interface selection, programmable current limiting. Hi AC/DC isolation w/guard shield. Data line isolation. MOXON, SRC DIV. CIRCLE 123

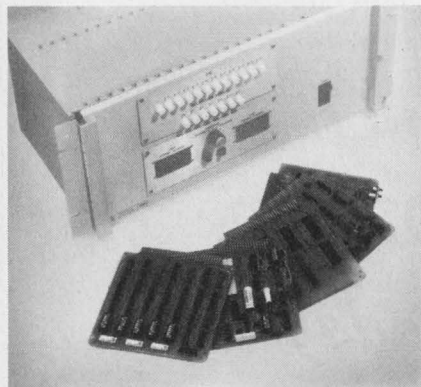

**Data Acquisition System with ASCII (RS232) Output.**

Permits direct connection to Mag. Tape Recorders, TTY/Telephone line modems, CRT displays, etc. Multiplexes and converts up to 128 channels of analog data inputs into single channel digital data. Complete module plug-in system available — multiplexer, ADC, DAC, Sample and Hold, Amplifiers, Power Supplies and Chassis. MOXON, SRC DIV. CIRCLE 124



**Moxon Inc/SRC Division**  
2222 Michelson Drive  
Irvine, California 92664  
Phone: (714) 833-2000

# Electronic Design

ELECTRONIC DESIGN's function is:

- To aid progress in the electronics manufacturing industry by promoting good design.
- To give the electronic design engineer concepts and ideas that make his job easier and more productive.
- To provide a central source of timely electronics information.
- To promote communication among members of the electronics engineering community.

**Want a subscription?** ELECTRONIC DESIGN is sent free to qualified engineers and engineering managers doing design work, supervising design or setting standards in the United States and Western Europe. For a free subscription, use the application form bound in the magazine. If none is included, write to us direct for an application form.

If you do not qualify, you may take out a paid subscription for \$30 a year in the U.S.A., \$40 a year elsewhere. Single copies are \$1.50 each.

**If you change your address,** send us an old mailing label and your new address; there is generally a postcard for this bound in the magazine. You will have to requalify to continue receiving ELECTRONIC DESIGN free.

**The accuracy policy of ELECTRONIC DESIGN is:**

- To make diligent efforts to ensure the accuracy of editorial matter.
- To publish prompt corrections whenever inaccuracies are brought to our attention. Corrections appear in "Across the Desk."
- To encourage our readers as responsible members of our business community to report to us misleading or fraudulent advertising.
- To refuse any advertisement deemed to be misleading or fraudulent.

Microfilm copies are available of complete volumes of ELECTRONIC DESIGN at \$19.00 per volume, beginning with Volume 9, 1961. Work is now in process to complete the microfilm edition of Volumes 1-8. Reprints of individual articles may be obtained for \$2.00 each, prepaid (\$.50 for each additional copy of the same article) no matter how long the article. For further details and to place orders, contact the Customer Services Department, University Microfilms, 300 North Zeeb Road, Ann Arbor, Michigan 48106 telephone (313) 761-4700.

**Want to contact us?** If you have any comments or wish to submit a manuscript or article outline, address your correspondence to:

Editor  
ELECTRONIC DESIGN  
50 Essex Street  
Rochelle Park, N.J. 07662

# Newtron 7 SEGMENT INCANDESCENT DIGITAL READOUT TUBES

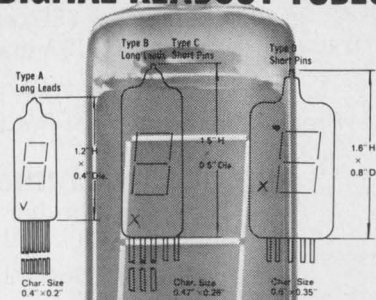

SERIES	TYPE	VOLTS	mA/SEG	FT-LAMB. BRIGHTNESS	PIN CIRCLE
DA-1000	A	5	10	1,500	0.197"
DA-1200*	B	5	10	1,500	0.280"
DA-1300*	B	5	20	6,000	0.280"
DA-1600	B	12	30	85,000	0.280"
DA-2200*	C	5	10	1,500	0.230"
DA-2300	C	5	20	6,000	0.230"
DA-2600*	C	12	30	85,000	0.230"
DA-2900	D	5	20	5,000	0.468"

• SPECIAL ORDER ONLY  
LIFE: 5V SERIES—100,000 Hours; 12V SERIES—10,000 Hours  
WITH DECIMAL POINT: DA-xx10 FOR +, -, 1 UNIT:  
DA-xx20

**Apollo**

5-1, Togoshi 6-chome, Shinagawa-ku,  
Tokyo 142, Japan  
Phone: (03) 786-2005

CORPORATION Cables: "APOLLOHAGITA" TOKYO

• U.S. Agent: **DAIMETRICS CORPORATION**  
1311 Post Ave., Torrance, Calif. 90501 Phone: (213) 328-2080

INFORMATION RETRIEVAL NUMBER 125

## Plagued by Thyristor Noise?

### Tokin SN Coils solve it.

And with enough reason. Take insertion loss: they outperform ordinary noise-absorbing cores and coils by

# 20dB

(300 kHz—5MHz)

A unique advantage from Tokin design originality. And talking about design, size has been reduced—installation simplified. Is it any wonder, then, that Tokin SN Coils captured

# 95%

(20,000,000 units)

of the Japanese market in only two years?  
Want to know more of Tokin SN Coils?  
Write to:

**Tokin**  
Tohoku Metal Industries, Ltd.  
Los Angeles Representative Office  
1277 W. Redondo Beach Blvd.,  
Gardena, Calif. 90247, U.S.A.  
☎ 213-329-4137, 4138  
Telex: 69-8147 TOKINSAN GDNA  
Cable address: "TOKINSAN GDNA"

## PICTURE, PATTERN, OR PLOT

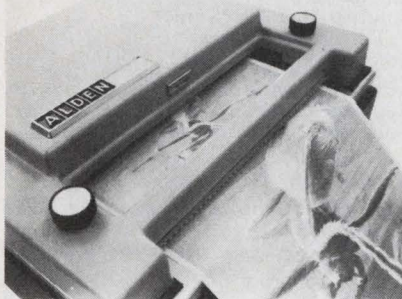

Now you can afford to add instant graphic hard copy output to your data terminals, storage tubes, computer outputs, SSTV, scanning sensors.

- Get low cost hard copy by instant graphic recording on ALFAX Type A electrosensitive paper where electricity is the ink.
- Interface ALDEN "Flying Spot" Component Recorders by simple synchronizing with your sweep circuit or scanning sensors and record directly from your target or cathode signal current.

Send for free brochure:  
"ALDEN Components to Picture,  
Pattern or Plot"

**ALDEN**  
ELECTRONIC & IMPULSE RECORDING EQUIPMENT CO., INC.

Westboro, Mass. 01581 Tel: (617) 366-8851 TELEX: 94-8404

INFORMATION RETRIEVAL NUMBER 127

## Revolutionary New!!



### TOYO HCM FILTER T-1 SERIES

#### ● FEATURES:

- These filters provide guaranteed rejection of 90dB. Their volume is 46.3% that of widely used 8-element conventional filters. Their height is only 12mm.
- Terminating conditions are uniform, allowing these filters to be used in a wide range of applications. These filters are fully compatible with other filters in terms of electrical characteristics. Ample consideration has been given to mechanical compatibility.
- Stringent environmental tests (shock and vibration tests) assure adequate quality control levels.

**TOYO COMMUNICATION**  
EQUIPMENT CO., LTD.

EXPORT DEPARTMENT  
TOYO BUILDING, NO.6-12, JINGUU-MAE,  
SHIBUYA-KU, TOKYO, JAPAN  
CABLE: EXPORTOYCOM-TOKYO  
TEL: (03) 406-3355  
TELEX: 02423001

INFORMATION RETRIEVAL NUMBER 128

ELECTRONIC DESIGN 1, January 4, 1973

## Electronic Design

### Advertising Sales Staff

Bryce Gray  
Sales Manager

### Rochelle Park, N.J. 07662

Robert W. Gascoigne  
Daniel J. Rowland  
50 Essex Street  
(201) 843-0550  
TWX: 710-990-5071

### Philadelphia

Thomas P. Barth  
50 Essex Street  
Rochelle Park, N. J. 07662  
(201) 843-0550

### Boston 02116

Richard L. Green  
20 Columbus Avenue  
Boston, Mass.  
(617) 482-7989

### Chicago 60611

Thomas P. Kavooras  
Berry Conner, Jr.  
200 East Ontario  
(312) 337-0588

### Cleveland

Thomas P. Kavooras  
(Chicago)  
(312) 337-0588  
(call collect)

### Los Angeles 90303

Stanley I. Ehrenclou  
Burt Underwood  
2930 Imperial Highway  
Inglewood, Calif  
(213) 757-0183

### San Francisco 94022

Jerry D. Latta  
P.O. Box 1248  
Los Altos, Calif.  
(415) 965-2636

### London W. 1

For United Kingdom and Holland  
Brayton C. Nichols

For Eastern Europe

Peter Kehr

The American Magazine Group

9 Warwick Street  
London, W. 1, England  
Phone: 437 5462

Cable: Ammagnic, London

### 4800 Verviers, Belgium

For Continental Europe

Andre Jamar

Rue Mallar, 1

(087) 253.85 Telex 41563

### Tokyo

Haruki Hirayama  
Electronic Media Service  
5th Floor, Lila Bldg.,  
4-9-8 Roppongi  
Minato-ku

Phone: 402-4556

Cable: Electronicmedia, Tokyo



## Good News For OSCILLATORS, TONE GENERATORS, TIMERS...

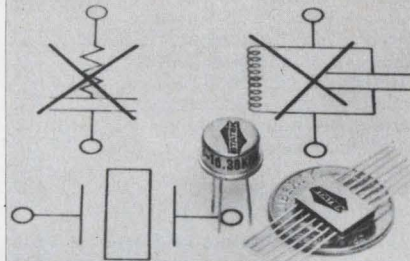

## Statek Quartz Crystals...

## Smaller, Less Expensive, Rugged, Accurate.

Here's why.

First, Statek developed a design to reduce the size of 10 kHz to 600 kHz crystals. Then, they applied IC type manufacturing techniques. The result... crystals that come in hermetically sealed TO-5 cans or IC flat packs.

Next, they're inexpensive. In production quantities, the cost may be lower than the less accurate, conventional LC/RC circuits you've been using. And high volume delivery is fast.

Their inherent design and rigid mounting make them rugged too. Even the lowest cost standard versions survive over 1,000 G shock.

Send for detailed data. Or for recommended circuits, simply write or call Statek detailing your design requirements.

#### Specifications

Frequency ..... 10 kHz to 600 kHz  
Accuracy:

0 to 70°C ..... 0.06%

-40 to +85°C ..... 0.08%

-55 to +125°C ..... 0.15%

Better specifications available on request.

In addition, Statek offers low frequency standard or custom hybrid oscillators and filters.

**STATEK CORPORATION,**

1233 Alvarez Avenue  
Orange, California 92668  
Phone: (714) 639-7810

INFORMATION RETRIEVAL NUMBER 129

# advertiser's index

Advertiser	Page
ADC Products, A Division of Magnetic Controls Company	123
AMP, Incorporated	35
Abbott Transistor Laboratories Incorporated	6
Accutronics, Inc.	87
Ailtech, a division of Cutler Hammer	16L
Alden Electronic & Impulse Recording Equipment Co., Inc.	173
American Commercial, Inc.	171
American Laser Systems	175
Amicon Corp.	175
Amphenol Industrial Division, Bunker Ramo Corp.	14, 15
Analog Devices, Inc.	129
Apollo Corporation	172
Arnold Magnetics Corp.	175
B & B Motor & Control Corp.	126
Babcock Electronics Corporation	115
Baird-Atomic, Inc.	134
Beckman Instruments, Inc., Helipot Division	50A
Belden Corporation	8, 9
Bendix Corporation, The Electrical Components Division	39
Boeing Company, The	170
Bourns, Inc., Trimpot Products Division	12, 13
Bright Industries, Inc.	109
Burdud Corporation	41
Burr-Brown Research Corporation, Hybex Division	161
Burroughs Corporation	Cover IV
Business Publications Audit of Circulation	50-H, 153
CTS Corporation	128
Centralab, the Electronics Division of Globe-Union, Inc.	16F, 16G
Cherry Electrical Products Corp.	42, 43

Advertiser	Page
Chicago Dynamics Industries, Inc.	124
Clairex Electronics, A Division of Clairex Corporation	107
Computer Automation, Inc.	16K
Cutler-Hammer	46
Dale Electronics, Inc.	Cover II
Data Display Products	158
Data Disc	82
Data Precision Corporation	147
Dialight Corporation	120, 121
Digitran Company, The	167
Dow Corning Corporation	16B, 16C, 16E
Dynascan Corporation	138
ECC Corporation	44
Edmund Scientific Company	144
Elco Corporation	11
Electronic Design	73, 74, 75, 153, 178
Electrostatics, Inc.	150
Energy Conversion Devices, Inc.	122
Exact Electronics, Inc.	51
Federal Scientific Corporation	174
Fluke Mfg. Co., Inc., John	17, 18
GTE Automatic Electric	50D, 50E
General Electric Company, Semi- conductor Products Department	29
General Instrument Corporation	10
General Instrument Corporation, Capacitor Division	99
General Radio Company	143
Gordos Corporation	159
Gould, Inc.	148, 150, 152
Grayhill, Inc.	140
Guardian Electric Manufacturing Company	50B, 50C
Harris Semiconductor, A Division of Harris Intertype Corporation	88, 89
Hathaway Instruments, Inc.	140
Hayden Book Company, Inc.	51-F, 51-G, 151, 175
Heath Company	159
Heinemann Electric Company	37
Hewlett-Packard	1, 4, 5, 54, 55, 135
Honeywell, Inc.	148
ILC Data Devices Inc.	16
IMC Magnetics Corporation	108

Advertiser	Page
Intech, Incorporated	136
Inter-Computer Electronics, Inc.	112
Interdata Corp.	20
International Electronic Research Corporation	155
International Rectifier	24
JFD Electronics Corporation	16A
Johnson Company, E. F.	113
Johanson Manufacturing Company	7, 175
Kurz-Kasch, Inc.	25
Lafayette Radio Electronics	152
Lambda Electronics Corp.	163, Cover III
Ledex, Inc.	110
Litronix	157
3M Company	104
Magnecraft Electric Company	26
Magneto, Inc.	175
Meguro Denpa Sokki K.K.	159
Meller Co., Adolf	138
MicroSwitch, A Division of Honeywell	177
Miida Electronics, a division of Marubeni America Corp.	134
Monolithic Systems	175
Monsanto Company	139
Monsanto Electronic Materials	33
Motorola Semiconductor Products, Inc.	16H, 16I
Optima, A Division of Scientific Atlanta, Inc.	126
Perkin Elmer Corporation	166
Plessey Electro-Products	114
Plessey Semiconductors	50
Power/Mate Corp.	144
Producers Service Corp.	146
Princeton Electronic Products, Inc.	154
QuantaLog, Inc.	81
RCA Solid State Division	16L
RFL Industries, Inc.	169
Rtron Corporation	160
Robinson-Nugent	149
Robison Electronics, Inc.	72
Rogan	157
SRC Division, Moxon, Inc.	172
Schauer Manufacturing Corp.	168
Semi-Film Technology	175
Servo-Tek Products Company	130
Signetics Corporation	22, 23
Siliconix Incorporated	52
Simpson Electric Company	131
Singer Company, The, Kearfott Division	145
Solid State Scientific, Inc.	157
Sprague Electric Company	19, 21
Sperry Information Displays	95
Standard Condenser Corporation	156
Stake Corp.	173
Stevens Tubing Corp.	175
Struthers-Dunn, Inc.	103
Tektronix, Inc.	45, 49, 133, 165
Teledyne Crystalonics	83
Teledyne Relays, A Teledyne Company	2
Teledyne Semiconductors	94
Texas Instruments Incorporated, Components Group	66, 67
Times Wire and Cable Company	171
Tohoku Metal Industries, Ltd.	172
Toyo Communication Equipment Co., Ltd.	173
Triplett Corporation	127
Union Carbide, Components Dept.	141
United Systems Corporation	119
Unitrode Corporation	97
Unimax Switch Corp.	16-J
Vactec Inc.	101
Vector Electronic Company Inc.	130
Watkins-Johnson	137
Weston Instruments, Inc.	117
Windjammer	111

## Design Data from Manufacturers

Advertisements of booklets, brochures, catalogs and data sheets. To order use Reader-Service Card.  
(Advertisement)

### 500-line Real-Time Spectrum Analyzer Acts Like 650-Lines

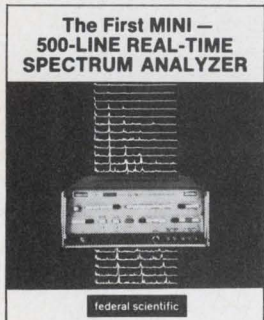

Second generation Mini-Ubiq™ Model UA-15A low frequency real-time spectrum analyzer — smaller, lighter, easier to use and less expensive than Federal's famous Ubiquitous® 500-line analyzer — is better for on-the-spot frequency analysis, machine noise diagnosis, computer automatic systems. Incorporates a sharper, computer-designed filter for increased selectivity — can separate closely spaced components as if it had 650 frequency lines. Widest choice of range — 12 ranges from 10Hz to 50kHz; highest frequency and amplitude accuracy; computer control of input amplitude range, analysis range, and presampling filter; operation with weighting function on or off; sweep termination adjustable for high sweep rates; earphone monitor of filtered input.

#### Federal Scientific Corp.

615 West 131st Street, New York, N.Y. 10027  
(212) 286-4400

CIRCLE NO. 171

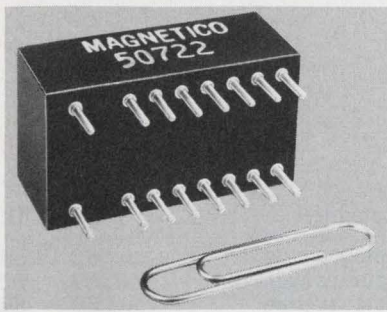

**Scott-T-Transformers** — Miniature size 13/16 x 1-1/2 x 5/8, input 90 or 11.8 volts, line to line, 400 Hz, output sine and cosine, 60 secs. accuracy, cost \$19. in quantity. Write for standard literature. Synchro to resolver & resolver to synchro. Magnetico, Inc., East Northport, N.Y. 11731. (516)-261-4502.

INFORMATION RETRIEVAL NUMBER 181

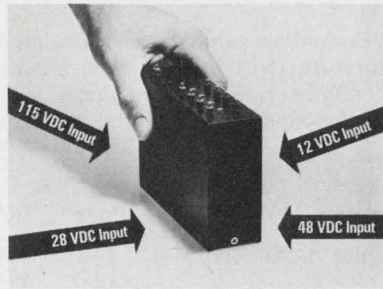

**DC-DC Regulated Power Converters** — loaded with power (6 watts/in<sup>3</sup>) and packed into pretested, encapsulated miniature packages. Modular design allows you to specify your own custom system without engineering charges. Inputs of 12, 28, 48, & 115 VDC with up to 6 outputs. Arnold Magnetics, Culver City, Ca. 90230. (213) 870-7014.

INFORMATION RETRIEVAL NUMBER 182

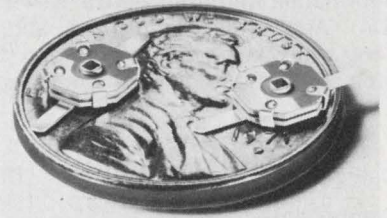

**Thin-Trim® variable capacitors** are designed to replace fixed tuning techniques. Applications include crystal oscillators, CATV amplifiers, communication and test equipment. Series 9410 has high Q's with five capacitance ranges from 1.0 - 4.5 pf to 10.0 - 50.0 pf. Johanson Manufacturing Corporation, Boonton, N. J. (201) 334-2676

INFORMATION RETRIEVAL NUMBER 183

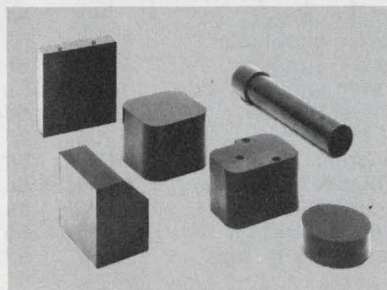

**Glass laminated epoxy 155°C cases** for component and circuit packaging are available in thousands of sizes. Thin wall tubes and headers offer optimum protection in all applications. Literature and samples available. Stevens Tubing Corp., 128 North Park Street, East Orange, New Jersey 07019. Telephone 201-672-2140.

INFORMATION RETRIEVAL NUMBER 184

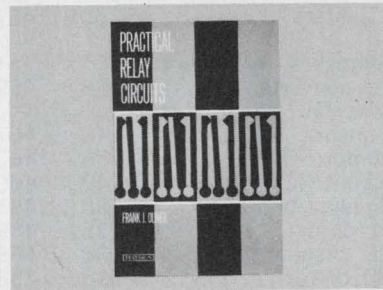

**Practical Relay Circuits**, by Frank J. Oliver. Time-saving guide classifies relays by function, presenting a rapid overview of the circuits that can solve the problem at hand. 384 pp., illus., cloth, \$14.95. Circle below for 15-day examination copies. Hayden Book Co., New York, N.Y. 10011.

INFORMATION RETRIEVAL NUMBER 185

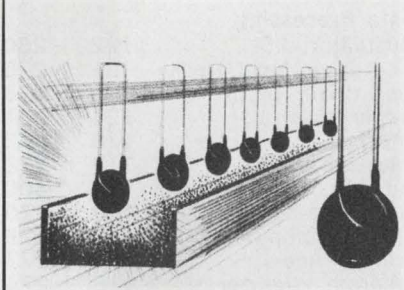

**New Amicon Epoxy Powder.** 30 second gel . . . 1 minute cure. Novaloy® Powders are outstanding for packaging delicate heat sensitive parts. Cures as low as 120°C. Fast cures with controlled flow, high gloss finish. Avail. in dip and electrostatic spray grades. Lit avail. from Amicon Corp., Polymer Prod. Div., Lexington, Ma. 02173. (617) 861-9600.

INFORMATION RETRIEVAL NUMBER 186

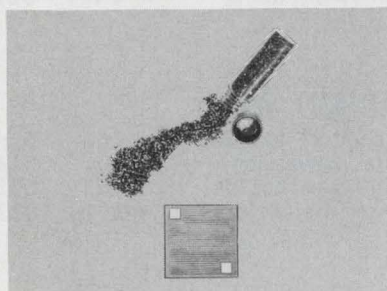

**30 Mil Thin Film Chip Resistors up to 10 megohms** are now available from Semi-Films Technology. Resistive material is improved tantalum nitride with greatly increased sheet resistivity. This new technology retains the stable properties inherent in the tantalum nitride process. Semi-Films Tech. Corp., Box 188, West Hurley, N.Y. 12491. 914-338-7714.

INFORMATION RETRIEVAL NUMBER 187

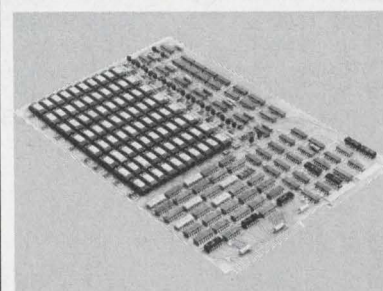

**Low cost semiconductor memory system monostore IV/Planar 4K x 20** on a single card 9-3/4" x 14". Cycle 650 ns. Includes timing control, refresh, address register, decoding, sense and memory array. TTL compatible. 0.5" card spacing. 4Kx16 \$900 from stock. Monolithic Systems Corp., Englewood, Co. 80110 (303) 761-2275.

INFORMATION RETRIEVAL NUMBER 188

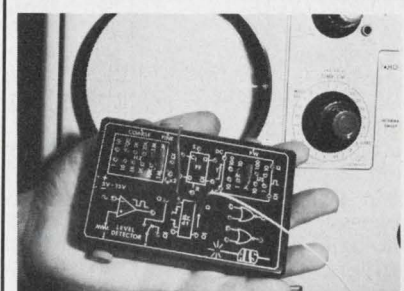

**COS/MOS Pulse Generator**—Features Squarewaves 1Hz-1MHz/Pulse-widths 1μs - 1 sec./"D" FF with S & R/Non-Capacitive Differentiator/Level Detector/"De-bounced" Push button. Q & Q outputs and complementary inputs available all functions. 3 - 15V circuit supply. Ideal as bench and built-in test equip. \$125. American Laser Systems. (805) 687-1212

INFORMATION RETRIEVAL NUMBER 189

# product index

**Information Retrieval Service.** New Products, Evaluation Samples (ES), Design Aids (DA), Application Notes (AN), and New Literature (NL) in this issue are listed here with page and Information Retrieval numbers. Reader requests will be promptly processed by computer and mailed to the manufacturer within three days.

Category	Page	IRN	Category	Page	IRN	Category	Page	IRN
<b>Components</b>			digital multimeter	146	<b>480</b>	data conversion	166	<b>536</b>
accelerometer, piezo	128	<b>306</b>	IC tester	142	<b>474</b>	data conversion	169	<b>554</b>
delay line, DIP	132	<b>455</b>	oscilloscope	142	<b>470</b>	data system	168	<b>547</b>
encoder, incremental	132	<b>452</b>	spectrum analyzer	144	<b>477</b>	disc storage	164	<b>529</b>
power transformer, PC	128	<b>304</b>	spectrum analyzer	146	<b>482</b>	EMR manual	169	<b>558</b>
relay, rf	134	<b>456</b>	tester, backplane	142	<b>473</b>	electron tubes	164	<b>528</b>
resistors, DIP	132	<b>454</b>	<b>Microwaves &amp; Lasers</b>			filters, active	166	<b>541</b>
sensor, fluid speed	132	<b>309</b>	amp, linear	150	<b>486</b>	holography	164	<b>534</b>
sensor, infrared	130	<b>307</b>	amp, wideband	148	<b>485</b>	ICs, COS/MOS	166	<b>538</b>
sensor, magnetic	134	<b>457</b>	fiber-optic scanner	148	<b>483</b>	lamps, green glow	166	<b>540</b>
sensor, torque	128	<b>305</b>	flat packs	148	<b>484</b>	lamps, miniature	167	<b>542</b>
switch, coax	132	<b>310</b>	generators, K-band	152	<b>489</b>	microwave diodes	169	<b>557</b>
switch kit	132	<b>453</b>	laser, argon	152	<b>490</b>	microwave instruments	170	<b>560</b>
switch, slide	130	<b>308</b>	laser, Nd:YAG	150	<b>488</b>	motors, autotransformer	169	<b>556</b>
switch, thermal	132	<b>451</b>	laser, scribing	152	<b>491</b>	multipliers, analog	168	<b>548</b>
<b>Data Processing</b>			oscillators	150	<b>487</b>	neon tube applications	168	<b>551</b>
calculator, LSI	122	<b>280</b>	<b>Modules &amp; Subassemblies</b>			potentiometers	168	<b>550</b>
disc drive, head/track	121	<b>275</b>	a/d converter	136	<b>462</b>	power supplies	164	<b>533</b>
disc drive, OEM	121	<b>278</b>	converter, synchro/			power supplies	170	<b>559</b>
heads, disc	124	<b>301</b>	linear	140	<b>467</b>	power supplies, dc	164	<b>531</b>
interface, computer	118	<b>272</b>	counter, digital	136	<b>463</b>	printer/plotter	167	<b>546</b>
interface, data	118	<b>273</b>	display, numerical	140	<b>469</b>	ROMs	166	<b>545</b>
memory, random-access	124	<b>300</b>	displays, digital	138	<b>465</b>	recorder	167	<b>544</b>
microprocessor, 8-bit	118	<b>270</b>	keyboards	136	<b>459</b>	switches, stepping	168	<b>549</b>
plotter, computer	122	<b>279</b>	LED display	138	<b>466</b>	technical services	164	<b>532</b>
printer, line	121	<b>277</b>	LED driver	136	<b>458</b>	thermal cutoffs	170	<b>561</b>
program, digitizer	118	<b>274</b>	oscillator	138	<b>464</b>	transistor testing	166	<b>537</b>
recorder, cartridge	118	<b>271</b>	power supplies	136	<b>461</b>	<b>application notes</b>		
recorder, hard-copy	118	<b>269</b>	pulse generator	140	<b>468</b>	capacitor diodes	162	<b>522</b>
simulator, I/O	124	<b>281</b>	rf amplifier	136	<b>460</b>	dielectric products	162	<b>519</b>
software, CAD	126	<b>303</b>	<b>Packaging &amp; Materials</b>			gates, CMOS	162	<b>517</b>
timeout, computer	126	<b>302</b>	DIP insertion tool	156	<b>498</b>	ICs, consumer	162	<b>523</b>
voice response system	121	<b>276</b>	disconnects	158	<b>504</b>	lamps, neon	162	<b>524</b>
<b>ICs &amp; Semiconductors</b>			flux, silver solder	154	<b>493</b>	microcircuits	162	<b>526</b>
CMOS rate multiplier	113	<b>263</b>	heat sink	154	<b>492</b>	microprogramming	162	<b>518</b>
calculator-on-a-chip	108	<b>258</b>	insulation	156	<b>499</b>	motors	162	<b>525</b>
calculator system	106	<b>254</b>	laminate	156	<b>496</b>	receiver, broadband	162	<b>520</b>
driver ICs	112	<b>262</b>	resins, casting	158	<b>501</b>	SCR protection	162	<b>521</b>
driver-receiver	105	<b>252</b>	resistor, thick film	158	<b>502</b>	<b>design aids</b>		
generator/VCO	114	<b>266</b>	socket, relay	154	<b>495</b>	capacitor, tantalum	161	<b>514</b>
line receiver	116	<b>268</b>	socket, relay	158	<b>500</b>	data conversion	161	<b>516</b>
line receiver IC	110	<b>259</b>	substrates	154	<b>494</b>	multilayer boards	161	<b>515</b>
logic line	116	<b>267</b>	terminal blocks	156	<b>497</b>	power transistors	161	<b>513</b>
MOS RAM	110	<b>260</b>	wiring duct	158	<b>503</b>	<b>evaluation samples</b>		
multipliers	108	<b>257</b>	<b>new literature</b>			bridging clip	160	<b>511</b>
multipliers	114	<b>265</b>	analyzer, bisync	170	<b>564</b>	cleaner	160	<b>508</b>
photodiodes, silicon	112	<b>261</b>	calculator-memory	164	<b>535</b>	epoxy	160	<b>510</b>
power switch/amp	105	<b>251</b>	capacitor matrices	168	<b>552</b>	fastener	160	<b>512</b>
processor system	113	<b>264</b>	cermet trimmer	166	<b>543</b>	pin headers	160	<b>506</b>
RAM chip	106	<b>253</b>	computer	170	<b>562</b>	reed relay	160	<b>505</b>
rectifiers	106	<b>256</b>	computer logic	166	<b>539</b>	temperature recorder	160	<b>509</b>
sense amp/data register	106	<b>255</b>	connectors	168	<b>553</b>	terminals	160	<b>507</b>
<b>Instrumentation</b>			connectors	169	<b>555</b>			
calibrator	146	<b>479</b>	control devices	170	<b>563</b>			
chart recorder	146	<b>481</b>	converters, dc-dc	164	<b>530</b>			
counter timer	142	<b>471</b>	data conversion	164	<b>527</b>			
DMM	144	<b>478</b>						
DPM	142	<b>475</b>						
data generators	144	<b>476</b>						
digital clock	142	<b>472</b>						

# There's plenty more where these

# came from.

Literally, thousands more.

Actually, the odds are in your favor that we have the unlighted pushbuttons you need, right-off-the-shelf.

Our secret is interchangeable parts. Pushbutton modules. Switch modules (including hermetically sealed units and high/low temperature versions). Facenuts.

Even a selection of colored buttons.

We also give you a choice of momentary or alternate action. Or a combination of both. And finally, a pick of one, two, three or four pole circuitry.

Which gives you the opportunity to customize your panel — front and back. To make it the way you want it. And to do it economically.

For more information, call your MICRO SWITCH Branch Office or Authorized Distributor (Yellow Pages under "Switches, Electric").

Or write for Catalog 51.



**MICRO SWITCH**

FREEPORT, ILLINOIS 61032

A DIVISION OF HONEYWELL

MICRO SWITCH products are available worldwide through Honeywell International.

INFORMATION RETRIEVAL NUMBER 131



# 1973 SUPER TOP TEN CONTEST RULES

## Reader Contest

**PICK THE TOP TEN ADVERTISEMENTS IN THIS ISSUE . . . WIN A WINDJAMMER CRUISE FOR TWO . . . \$1,000 CASH . . . FREE JET FLIGHT . . . FREE RERUNS OF YOUR COMPANY'S AD . . . 100 PRIZES IN ALL.**

Examine this issue of *Electronic Design* with extra care. Pick the ten advertisements that you think will be best remembered by your fellow engineer-subscribers. List these ten advertisements on the special entry form bound in at right. (Be sure to check the box marked "Reader Contest.")

Your selections will be measured against the ten ads ranking highest in the "Recall Seen" category of Reader Recall — *Electronic Design's* method of measuring readership. In making your choices do not include "house" advertisements placed by *Electronic Design* or Hayden Publishing Company, Inc. (such as this ad describing the contest). Don't miss your chance to be a Top Ten Winner! All entries must be postmarked no later than midnight, February 15, 1973. Winners will be notified in March 1973.

### READER CONTEST RULES

1. Enter your *Top Ten* selections on the entry blank provided, or on any reasonable facsimile. Be sure to indicate the name of the advertiser and *Information Retrieval Number* for each of your choices. Do not use page number. (Ads placed by Hayden Publishing Company in *Electronic Design* should not be considered in this contest.)

2. No more than one entry may be submitted by any one individual. Entry blank must be filled in completely, or it will not be considered. The box on the entry blank marked "Reader Contest" must be checked. *Electronic Design* will pay postage for official entry blanks only.

3. To enter, readers must be engaged in electronic design engineering work, either by carrying out or supervising design engineering or by setting standards for design components and materials.

4. No cash payments, or other substitutes, will be made in lieu of any prize, (except the \$1,000 prize).

5. Contest void where prohibited or taxed by law. Liability for any taxes on prizes is the sole responsibility of the winners.

6. Entries will be compared with the "Recall Seen" category of Reader Recall (*Electronic Design's* method of measuring readership). That entry which in the opinion of the judges most closely matches the "Recall Seen" rank, will be declared the winner.

7. In case of a tie, the earliest postmark will determine the winner. Decisions of *Top Ten* contest judges will be final.

8. Free reruns of any advertisement will be made only from existing plates or negatives. If the advertisement qualifying for a free rerun is an insert, the winner's company may run a two-page spread from existing plates or negatives in up to 4-colors.

9. Hayden Publishing Company, Inc. reserves the right to schedule reruns at its discretion.

**FOR A COMPLETE DESCRIPTION OF PRIZES  
FOR BOTH READER AND ADVERTISER CONTESTS  
SEE PAGES 74 AND 75**

## USE SPECIAL ENTRY BLANK BOUND IN AT RIGHT

(Additional entry blanks are bound inside the front cover)

## Advertiser Contest

**PICK THE TOP TEN ADVERTISEMENTS IN THIS ISSUE . . . WIN A WINDJAMMER CRUISE FOR TWO . . . \$1,000 CASH . . . FREE JET FLIGHT . . . COLOR TV . . . BULOVA TIMEPIECE.**

There's a separate contest open to all marketing and advertising personnel in companies, and to advertising agencies.

Examine this issue of *Electronic Design* with extra care. Pick the ten advertisements that you think will be best remembered by *Electronic Design's* readers. List these ten advertisements on the special entry blank bound in the front or back of this issue. (Be sure to check the box marked "Advertiser Contest".)

In addition to valuable prizes, all ads that place in the Top Ten will be given free reruns. If you are a winner in the advertiser contest, and if you ran an ad in the January 4 issue that did not place in the Top Ten, that advertisement, or a like ad of your choice, will be given a free rerun. See rules if the winning ad is an insert.

### ADVERTISER CONTEST RULES

1. All rules for the Reader Contest will similarly apply for this contest, with two exceptions: readers engaged in electronic design engineering work, as defined in the reader contest rules, are not eligible to participate in this special contest. The box on the entry blank marked "Advertiser Contest" must be checked.

2. Entrants in this contest may use the official reader contest entry blanks or any reasonable facsimile.

3. This special contest is open to marketing and advertising personnel only at all manufacturing companies and advertising agencies whether or not their companies or agencies have an advertisement in the January 4, 1973 issue. However, only those companies (or divisions thereof) advertising in the Jan. 4 issue, and the advertising agencies placing such advertisements are eligible for a free rerun of their advertisement should a member of their organization win.

4. Free reruns of any advertisement will be made only from existing plates or negatives. If the advertisement qualifying for a free rerun is an insert, the winner may run a two-page spread from existing plates or negatives in up to 4-colors.

5. Hayden Publishing Company, Inc., reserves the right to schedule reruns at its discretion.

**FOR A COMPLETE DESCRIPTION OF PRIZES  
FOR BOTH READER AND ADVERTISER CONTESTS  
SEE PAGES 74 AND 75**

## USE SPECIAL ENTRY BLANK BOUND IN AT RIGHT

(Additional entry blanks are bound inside the front cover)



Do you face a make or buy decision on power supplies?

# BUY LAMBDA LX SERIES

Choose from 7 packages, 39 models  
All 1-day delivery. All guaranteed 5 years

## "3" PACKAGE

DUAL OUTPUT ... \$85  
±15 TO ±12 VOLTS 0.4 AMPS

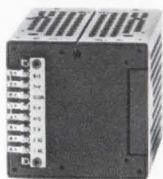

## "A" PACKAGE

SINGLE OUTPUT ... \$85  
5 VOLTS 4 AMPS (with O.V.)  
DUAL OUTPUT ... \$125  
±15 TO ±12 VOLTS 1 AMP



## "B" PACKAGE

SINGLE OUTPUT ... \$125  
5 VOLTS 5.8 AMPS (with O.V.)  
DUAL OUTPUT ... \$150  
±15 TO ±12 VOLTS 1.6 AMPS

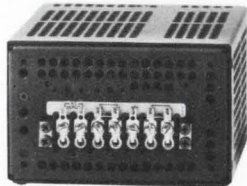

## "4" PACKAGE

SINGLE OUTPUT ... \$135  
5 VOLTS 7.4 AMPS (with O.V.)

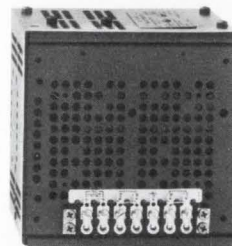

## "C" PACKAGE

SINGLE OUTPUT ... \$150  
5 VOLTS 9 AMPS (with O.V.)  
DUAL OUTPUT ... \$160  
±15 TO ±12 VOLTS 2.5 AMPS

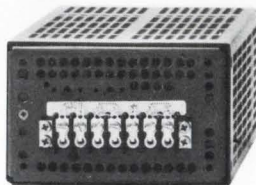

## "CC" PACKAGE

SINGLE OUTPUT ... \$200  
5 VOLTS 16 AMPS (with O.V.)  
DUAL OUTPUT ... \$235  
±15 TO ±12 VOLTS 4.0 AMPS



## "D" PACKAGE

SINGLE OUTPUT ... \$235  
5 VOLTS 27.5 AMPS (with O.V.)  
DUAL OUTPUT ... \$280  
±15 TO ±12 VOLTS 6.2 AMPS  
TRIPLE OUTPUT ... \$375  
±15 TO ±12 VOLTS 3.1 AMPS  
5 ± 5% VOLTS 12 AMPS  
(with O.V.)

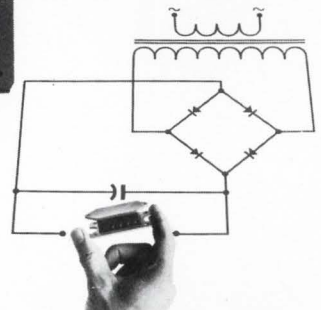
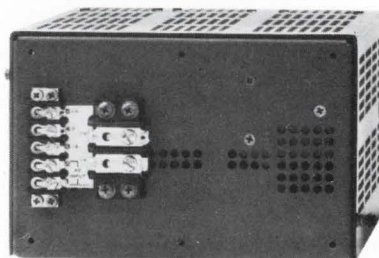

**WHETHER  
YOU MAKE  
OR BUY...**

**LAMBDA**  
ELECTRONICS CORP.

A Veeco Company

Line regulation 0.1% Load regulation 0.1%  
Ripple and noise 1.5 mV RMS, 5 mV P-P with either positive or negative terminal grounded  
AC input 105-132 VAC; 47-440 Hz  
All 5-volt models include built-in overvoltage protection.  
For information on other models up to 28 VDC, send for catalog.

MELVILLE, NEW YORK 11746 515 Broad Hollow Road Tel. 516-694-4200 ARLINGTON HEIGHTS, (CHICAGO) ILL. 60005 2420 East Oakton St., Unit Q Tel. 312-593-2550  
NORTH HOLLYWOOD, CALIF. 91605 7316 Varna Ave. Tel. 213-875-2744 MONTREAL, QUEBEC 100C Hymus Blvd., Pointe-Claire, Quebec-730 Tel. 514-697-6520

INFORMATION RETRIEVAL NUMBER 243

# SELLS ON SIGHT

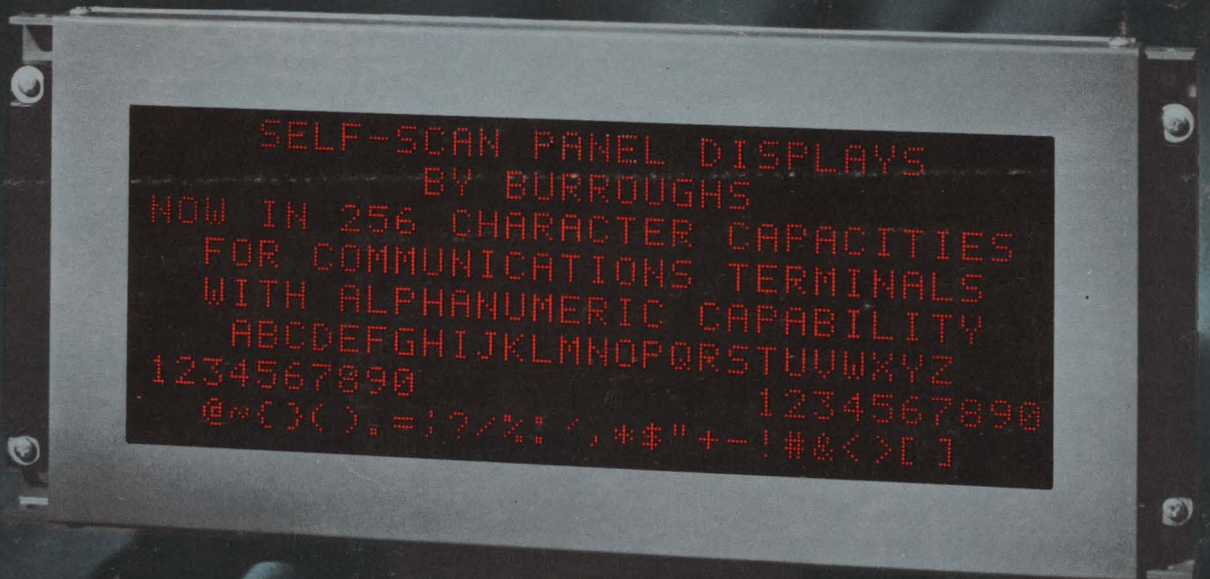

## superior readability that competitors can't match

One look at an operating SELF-SCAN<sup>®</sup> panel display and you will know why you should be featuring one in your system. SELF-SCAN displays are a new solution to the operator machine interface that provides advantages to the system builder, to the system user, and to the system operator.

You can offer your customer the advantage of a custom-stylized unit that his operators can use efficiently. SELF-SCAN panels are measurably superior to CRT for operator accuracy while significantly reducing fatigue level in day in-day out high volume production applications.

The 0.2" high characters are in the popular 5x7 dot matrix format and are made up of dots on .040" centers. The unit is ASCII compatible and displays a modified 64-character ASCII character set.

256-character display subsystems are available from stock for immediate delivery. Call or write Burroughs Corporation, Electronic Components Division, Box 1226, Plainfield, New Jersey 07061, Phone: (201) 757-3400. Ask to have a Burroughs sales engineer stop by your office and show you his 256-character SELF-SCAN panel, keyboard, and power supplies packaged in a standard Samsonite<sup>®</sup> briefcase.

Burroughs

