

# Electronic Design

FOR ENGINEERS AND ENGINEERING MANAGERS

VOL. 17 NO.

# 7

APRIL 1, 1969

Switching in four nanoseconds, a new family of logic ICs and medium-scale integrated chips offers individual gating speeds of less than two nanoseconds.

At least twice as fast as TTL, these complementary transistor logic chips include many popular circuit functions. For additional specifications, turn to page 112.

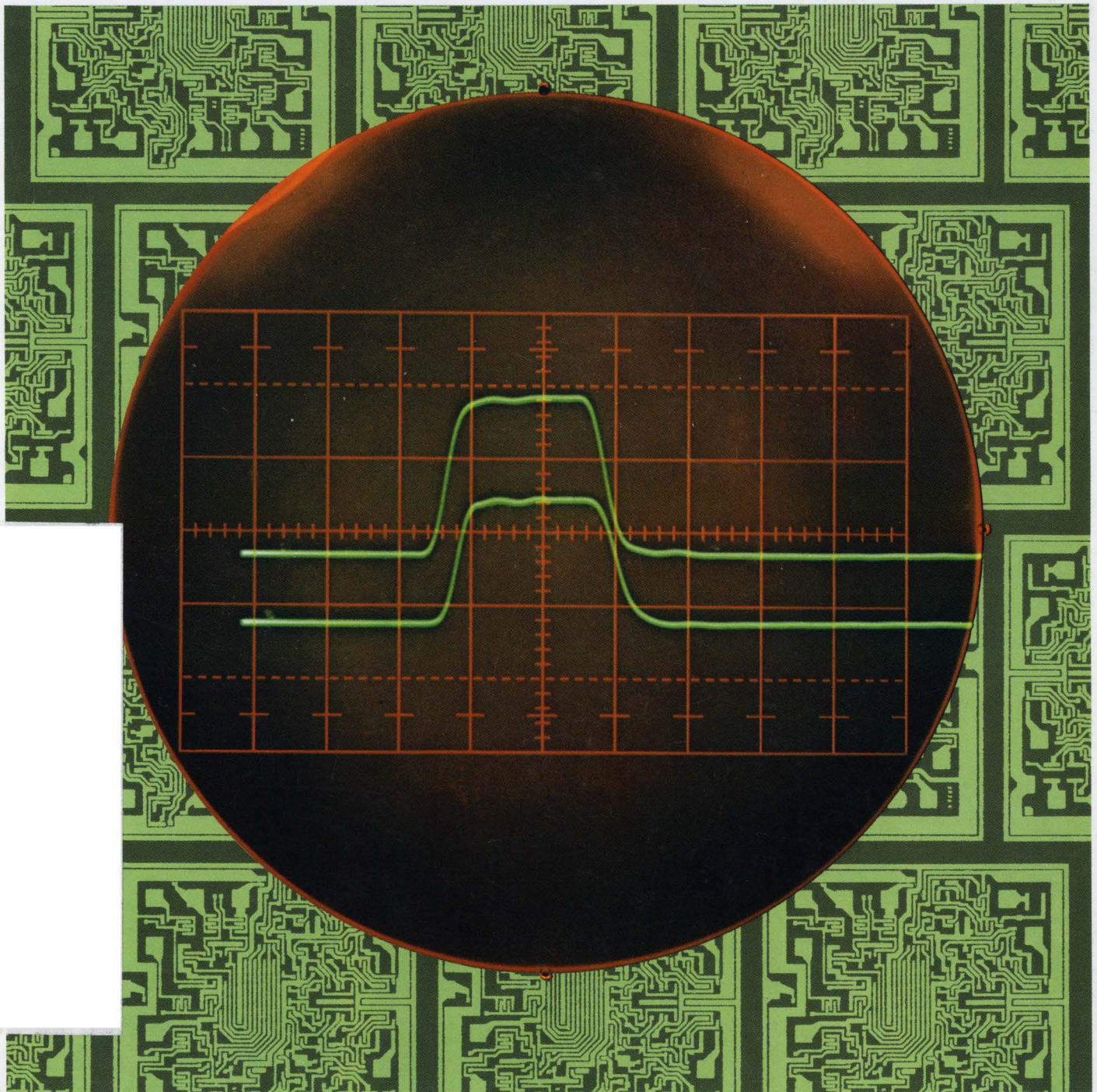

# TRW

## Microwave Transistors

### 10 Watt-1 GHz

### 20 Watt-1 GHz



### 6dB gain...50% efficiency...ultrac ceramic stripline

Two new microwave transistors have joined the TRW Gigahertz Family. Both the 10-watt 2N5595 and the 20-watt 2N5596 are in hermetically sealed ultrac ceramic stripline packages, offer excellent broadband capability, and operate from a 28 volt source. In class "C" common emitter operation, the 10

watt unit offers 6dB gain, and the 20 watt unit 5dB gain, with greater than 50% efficiency at 1 GHz.

Delivery is immediate...in production quantities. Order from the factory or any TRW distributor.

For complete information and applications assistance contact TRW Semiconductors, 14520 Aviation

Blvd., Lawndale, California 90260. Phone: (213) 679-4561. TWX: 910-325-6206. TRW Semiconductors Inc. is a subsidiary of TRW INC.

# TRW<sup>®</sup>

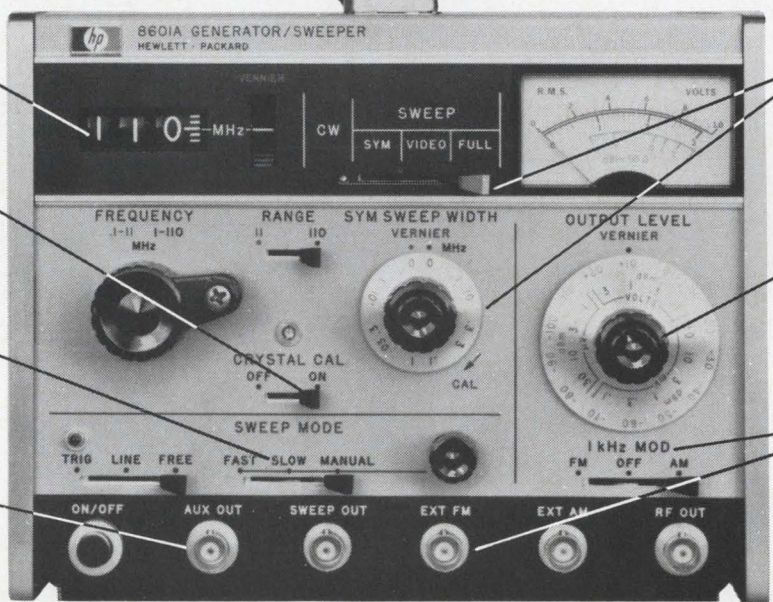

Digital frequency dialing accurate to 1% of frequency

0.01% calibration check at 5 MHz intervals.

Sweep speeds and triggering versatility for all applications.

Monitor frequency to 110 MHz with low-cost 10 MHz counter—HP 5321.

3 sweep functions, each with 0.5% linearity. Go from broad to narrow sweep with the flick of a switch.

$\pm 1$  dB output accuracy from 10 dBm to  $-110$  dBm; flatness is  $\pm 0.25$  dB from 0.1 to 110 MHz.

Modulation: AM or FM, internal or external. (Internal: 30% AM and 75 kHz deviation FM.)

# This 110 MHz sweeper is so accurate you can forget about markers

...and it doubles as a signal generator

Covering 100 kHz to 110 MHz, this all-solid-state 21 lb. instrument is a natural for both lab and production use. Price is \$1975. Call your HP field engineer for complete details on the 8601A Generator/Sweeper. Or write Hewlett-Packard, Palo Alto, California 94304; Europe: 1217 Meyrin-Geneva, Switzerland.



SWEEP SIGNAL GENERATORS

INFORMATION RETRIEVAL NUMBER 2

Systron-Donner's new portable counts every cycle at frequencies right up through 500 MHz. It's the sure, simple way to measure the higher frequencies because it's fully automatic — no more heterodyning, no more tuning, no more calculating.

Model 7015 costs only \$1975 — \$300 less than equipment using the older heterodyne techniques. So you get instant final-answer readings and save money too.

This new portable can be yours with a wide choice of oscillators, ranging in stability from the standard 3 parts in  $10^7$  per week to ultra-high stability of 5 parts in  $10^{10}$  per 24 hours.

For complete information contact Measurements Division, Systron-Donner Corporation, One Systron Drive, Concord, California 94520. Phone (415) 682-6161.

## First portable with top counting range: 500 MHz!



SYSTRON  DONNER

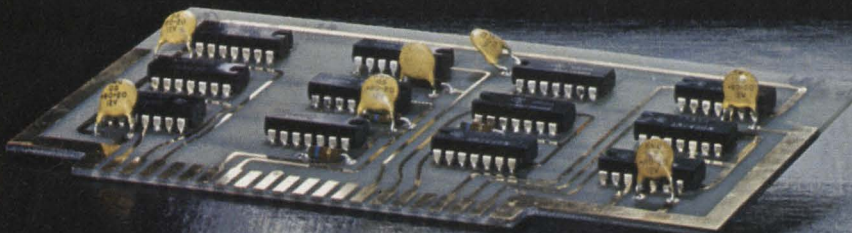

### Another first. One of 135 Systron-Donner instruments

Electronic counters	Analog computers
Pulse generators	Digital panel meters
Microwave frequency indicators	Microwave signal generators
Digital clocks	Laboratory magnets
Memory testers	Data acquisition systems
Digital voltmeters	Microwave test sets
Time code generators	
Data generators	

---

## NEWS

- 25 **Remote-sensing spacecraft to see all**  
Earth-resources satellites will help spot hidden mineral deposits, detect forest fires, agricultural blight and water pollution
- 34 **Just a step away from a landing on the moon**
- 42 Ten-trillion-watt laser is developed by Sandia Laboratories
- 47 Washington Report
- 50 Sidelights of the Issue
- 53 **Editorial:** End the conflict of purpose in technological education

---

## TECHNOLOGY

- 56 **Speed network analysis with topology** by using an improved method that provides solutions by inspection and handles active devices.
- 65 **Add graphic display to your computer** for faster design and reduced programing costs. Here are their advantages. Learn their characteristics.
- 70 **Tackle your switching circuit designs** with this easy-to-use technique. It offers optimum coupling between stages, takes drift and noise into account.
- 76 **Don't argue, discuss.** Nobody wins an argument. But you can win a discussion, if you learn to listen to the other guy first.
- 82 Ideas For Design
- 93 'Top Ten' prizewinning advertisements

---

## PRODUCTS

- 112 **Cover Feature:** Complementary-transistor logic circuits gate in 2 ns.
- 114 **Microwaves and Lasers:** Field replaceable laser tube boasts positive alignment.
- 120 **Data Processing:** Recording system simplifies keyboard-to-digital transitions.
- 124 **ICs and Semiconductors:** Radiation-resistant ICs are available from stock.
- 126 Components
- 128 Modules and Subassemblies
- 132 Production
- 134 Instrumentation
- 136 Packaging and Materials

---

## Departments

- 14 Designer's Datebook
  - 138 Evaluation Samples
  - 140 Design Aids
  - 142 Application Notes
  - 144 New Literature
  - 150 Advertisers' Index
  - 152 Information Retrieval Service
- Information Retrieval Service Card inside back cover  
COVER CREDIT: Fairchild Semiconductor, Mountain View, Calif.

# IBM Circuit Design and Packaging Topics

- Elevator control manufacturers reduce system size and cost with IBM relays
- IBM subjects reed switches to rigid tests before shipping

## Elevators: controller size and reliability critical

IBM wire contact relays help elevator control system manufacturers solve the major problem of reducing increasingly complex control systems without sacrificing reliability.

With many presently used large switching devices, for example, a typical controller unit for a 6-car installation fills a 10' x 10' room, floor to ceiling.

Larger and more complicated installations increase size even further, leading inevitably to controllers of unacceptable proportions. The answer is a smaller control system—which means smaller components. It is this trend that leads the elevator industry to growing recognition of the advantages offered by IBM relays.

## Elevators: relays allow dramatic reductions in size

One elevator manufacturer, Dover Corporation/Elevator Division, Memphis, Tennessee, chose IBM wire-contact relays after conducting extensive tests to determine which components offer the best combination of high reliability, small size, and low cost. Products were evaluated under worst-case conditions. Life tests showed that IBM wire-contact relays exceeded Dover's most stringent reliability requirements.

IBM wire-contact relays are smaller than most. The dense and compact packaging made possible by use of 4-, 6-, and 12-pole IBM relays slashes Dover's elevator controller size by over 75%. It also results in substantial manufacturing cost reductions plus savings in shipping and installation.

## Elevators: relays cut manufacturing costs

F. S. Payne Co., Cambridge, Massachusetts elevator manufacturer stresses that any new controller should use relay logic for serviceability and overall economy. IBM wire-contact relays were thoroughly tested in the lab, in Payne's

test tower, and in field installations. They proved 100% reliable.

IBM relays cost less per contact than presently-used relays and their multipole configuration reduces the number of relays needed. Because the entire control system is smaller, it can be made in less time, with fewer parts, by fewer people.

Elevator passenger safety is the overriding design consideration which depends, in large part, on controller reliability. IBM relays greatly surpass reliability criteria for elevators while offering dramatic space savings in control unit size.



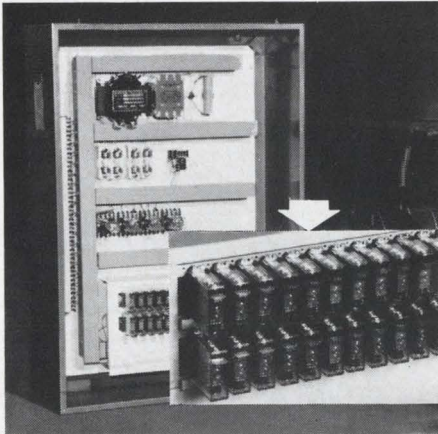

IBM relays can slash more than 75% off the size of elevator controller units without sacrificing reliability.

**□ Elevators: relays permit design flexibility**

Another elevator manufacturer, United States Elevator Corp., Spring Valley, California, finds IBM wire-contact relays important for design flexibility.

Their controller is programmed to sense changing needs for elevator cars as traffic patterns vary, as opposed to timing cars to arrive during pre-determined peak traffic hours. This requires simultaneous switching of many circuits. When U.S. Elevator investigated various switching components, they found the IBM 12-PDT relay to be ideal since it offered up to twelve separate switching circuits within one small component.

Additional design flexibility is provided by plug-in insertion and taper-pin wiring of relay receptacles which allows for future controller expansion.

Long life and ease of maintenance are two important design considerations for all elevator controllers. The IBM

relay, with mechanical life of 200 million-plus operations, and pluggable construction, fulfills both needs.

These are only three of many manufacturers benefiting from IBM wire-contact relays in their control systems. To find out how these relays can help you, contact IBM now.

**□ High-speed reed switches undergo rigid testing**

For applications requiring higher speed switching, IBM offers a line of reed relays built around the rhodium-over-gold IBM miniature dry reed switch.

These switches are designed for applications where fast, ultra-reliable operations are essential. They also serve ideally as an interface between solid state and relay logic.

To insure consistently superior performance with these switches, IBM uses advanced manufacturing equipment and rigid inspection techniques in every production phase.

For example, shipment populations of IBM reeds are sampled as a final process control measure to guarantee

product uniformity. Switches are tested under four operating conditions for life vs. resistive load and one condition for life vs. inductive load (100 mA inductive load with diode suppression).

Full documentation on quality assurance and failure parameters concerning these reeds are available on request.

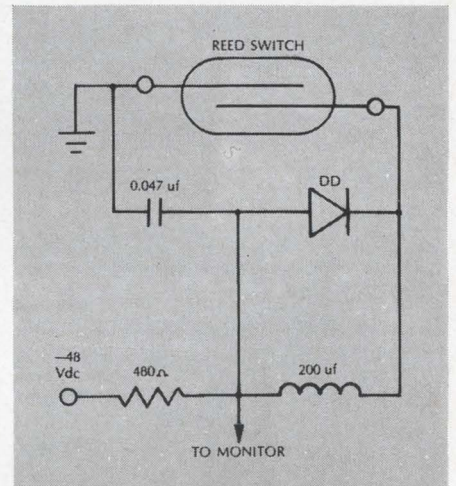

The diagram above shows just one of the circuits (48 VDC suppressed) used to test IBM miniature dry reed switches prior to shipment.

**IBM Industrial Products Marketing Dept. ED41  
1271 Avenue of the Americas  
New York, New York 10020**

**IBM®**  
INDUSTRIAL  
PRODUCTS

**Please send information on:**

- IBM wire contact relays
- IBM reed relays and switches

name \_\_\_\_\_

position \_\_\_\_\_

company \_\_\_\_\_

address \_\_\_\_\_

city \_\_\_\_\_ state \_\_\_\_\_ zip \_\_\_\_\_

# Where else can you get 100 MHz and sweep switching in one oscilloscope?

## Nowhere... but from DUMONT.

For example, the Dumont 767 H/F oscilloscope pictured below. It features:

- 79-02A and 74-17A plug-ins for 100 MHz dual trace and sweep switching to 5ns/cm.
- Bench or Rack Mounting. Only 7" high.
- Reliability of silicon solid state circuitry with no fan.
- Low power consumption, large display area, internal graticule.
- Interchangeable X and Y plug-in amplifiers.
- 13KV accelerating potential for high writing rate performance.

Send for our informative 1969 catalog of high and low frequency oscilloscopes and accessories, plug-in amplifiers, camera systems, and pulse generators.

**DUMONT OSCILLOSCOPE LABORATORIES, INC.**  
40 Fairfield Place, West Caldwell, N. J. 07006  
(201) 228-3665/TWX (710) 734-4308

**DUMONT**  
OSCILLOSCOPE LABORATORIES, INC.





# The Straight Line

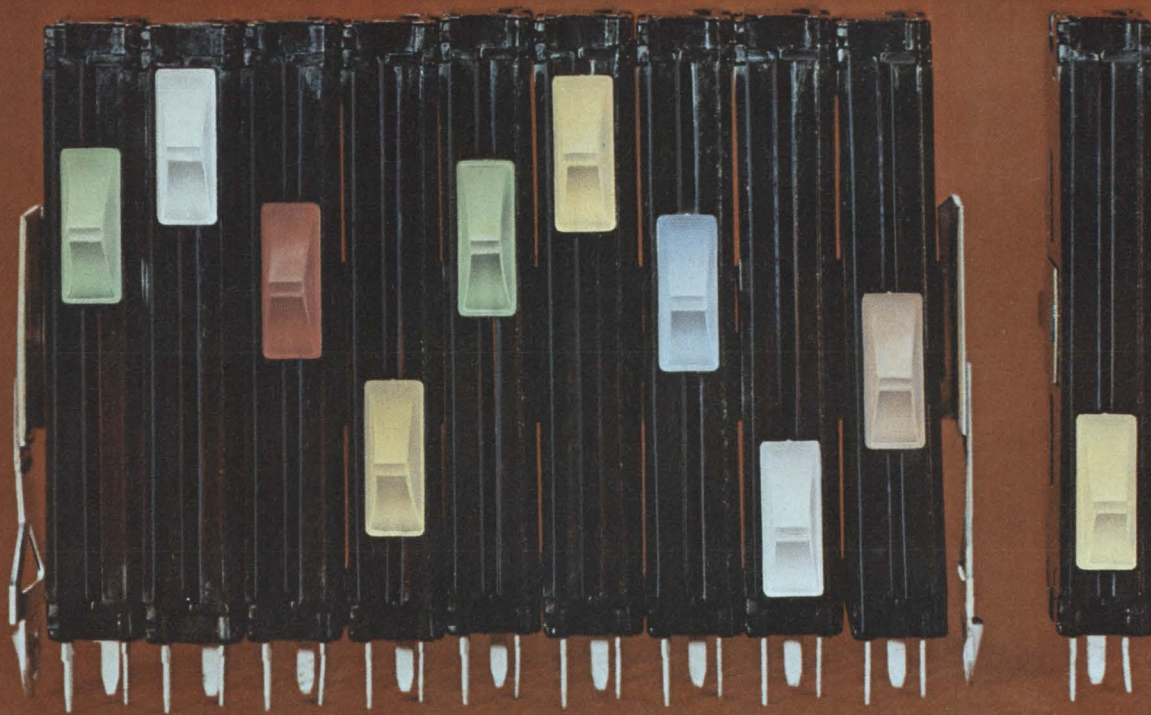

Covered under Patent No. 3,362,004 and others pending.

## Functional new concept in Potentiometer design



Horizontal, vertical or side mounting available.

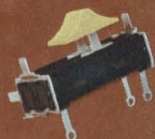

Multiple units lock and actuate with single knob.



Preliminary adjustment with template possible.



Needs only 1/3 mounting area of standard control.



Standard solder lug, wire-wrap or printed circuit terminals supplied.



Forward or rear facing twist-tab mountings. Snap-in mounts also available.

Variable resistors have been going in circles for years. Now Stackpole straightens them out. Using linear motion, Stackpole engineers created a potentiometer that conserves circuit board and panel space and offers a host of design advantages. Stackpole calls it SLIDE-TROL®. You'll call it ingenious! Utter simplicity, yet with all the quality and features of devices costing much more. SLIDE-TROL® is available in values of 40 ohms to 15 meg. ohms and since the element is rectangular and provides more area to dissipate heat, higher wattage ratings are possible. Phenolic housings eliminate shock hazards. Low noise and low contact resistance are assured by a patented 9-point movable spring contact. Only imagination limits the applications for SLIDE-TROL®. If you're looking for performance, economy and appeal in variable resistors, get the facts on SLIDE-TROL®. Write for samples and brochure: Stackpole Components Co., P.O. Box 14466 Raleigh, N. Carolina 27610. PH: 919-828-6201 TWX: 510-928-0520



**STACKPOLE**  
COMPONENTS COMPANY

Also a leading producer of quality slide, rocker and rotary switches.

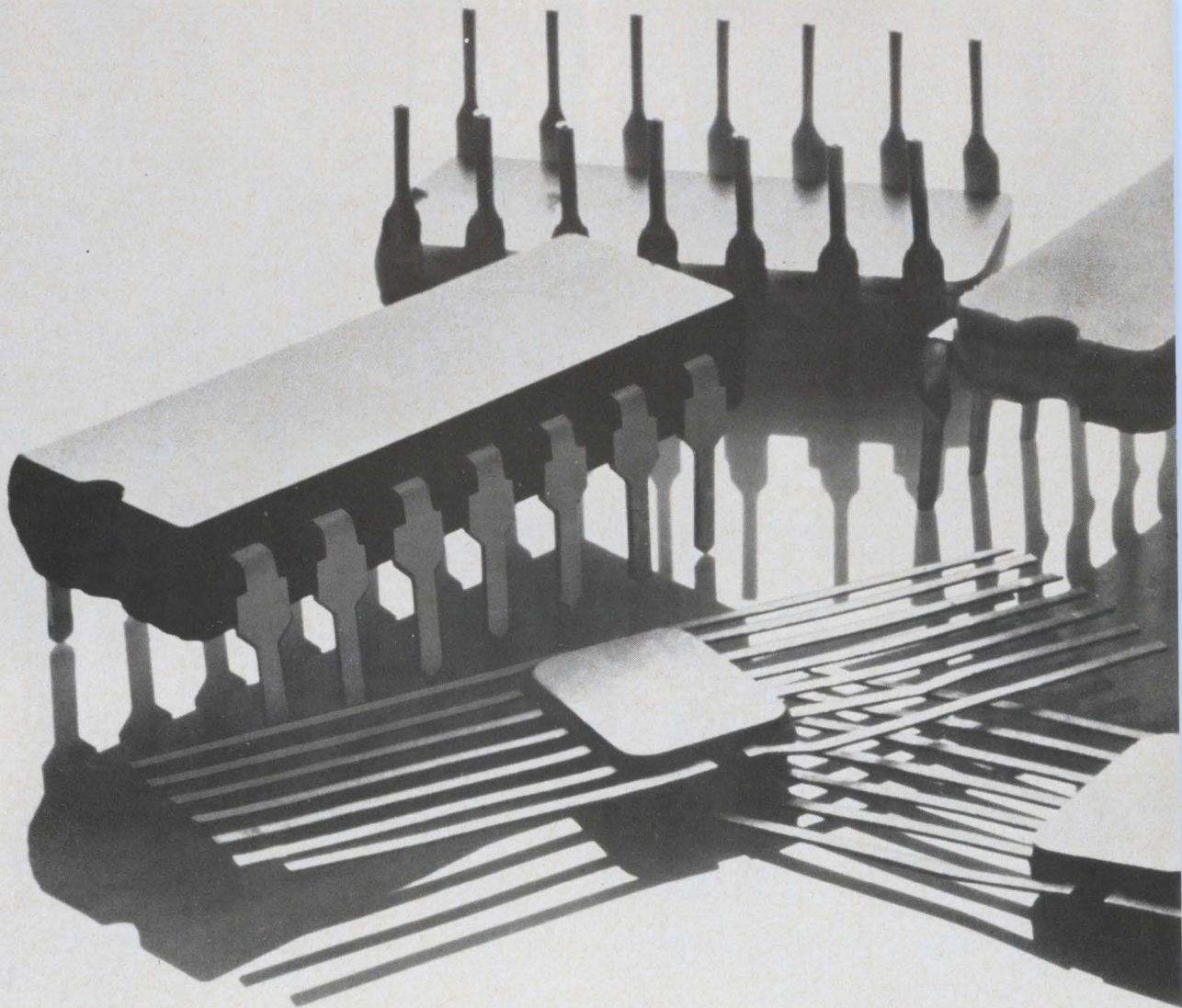

# Sylvania presents

The only way our competitors could match Sylvania SUHL integrated circuits was to copy them.

They're good imitations but we think our circuits are still better.

For instance, we use aluminum bonding wires where others use gold. This eliminates the chance of "purple plague" and gives better reliability, too.

The lower mass of aluminum wire also improves shock and vibration characteristics.

We are the only maker that performs 100% DC tests at temperature extremes. Of course, we make 100% AC tests, too.

We use a metal-to-metal seal for better hermeticity. We've been told that we have the best package on the market, based on tests by large-

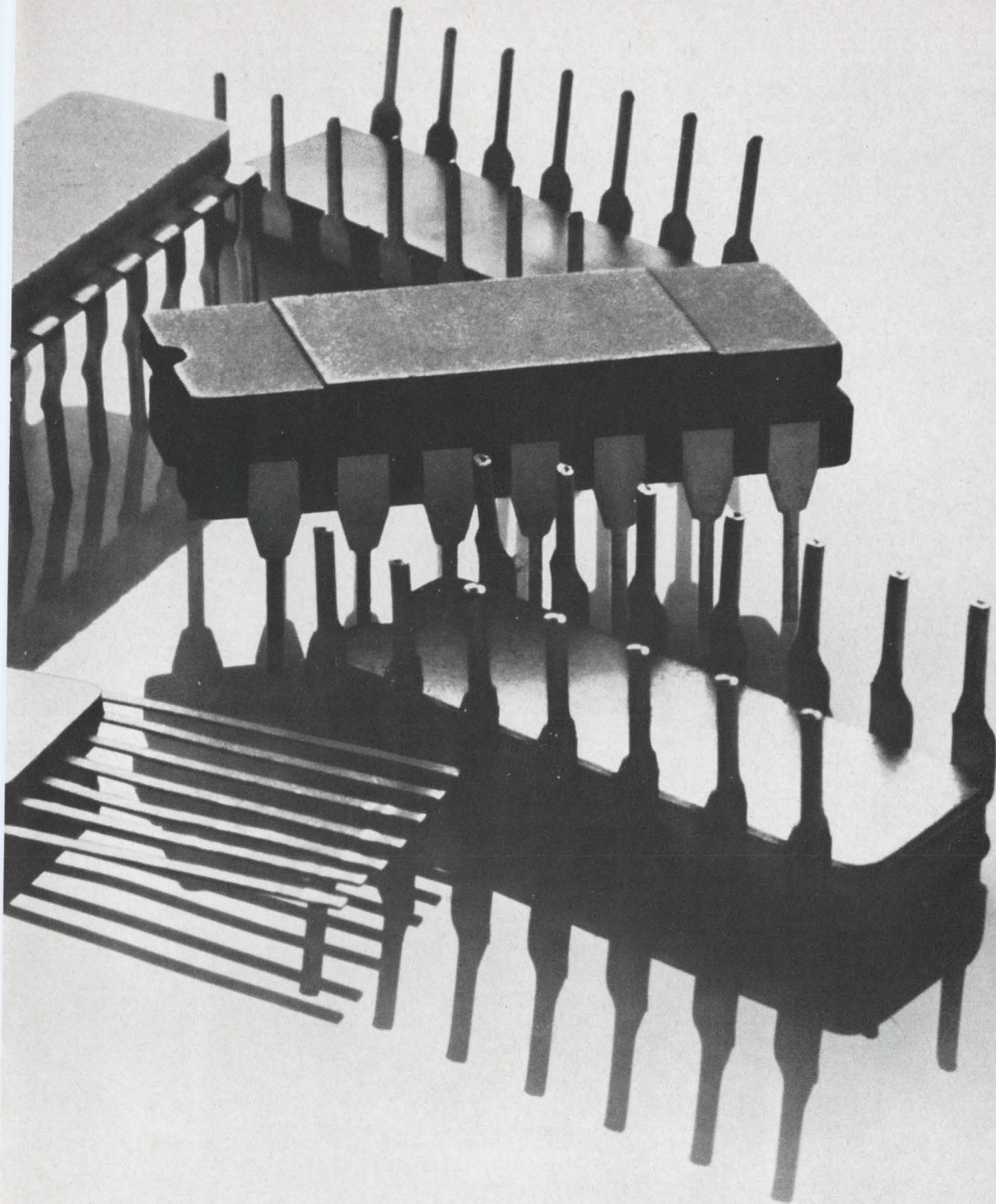

# eight good imitations.

scale users.

Our entire SUHL circuit line is available in both flat packs and dual-inline packages.

And we have the broadest SUHL circuit line in the marketplace. And that includes MSI.

All Sylvania MSI are completely compatible with SUHL circuits. Which means, if you are thinking of going the MSI route, Sylvania MSI is

the only way to go.

So why settle for good imitations when you can get the real thing?

Sylvania Electronic Components,  
Semiconductor Division, Woburn, Mass. 01801.

**SYLVANIA**  
GENERAL TELEPHONE & ELECTRONICS

# 2½D cycle time at 3D cost!

Data Products' new 3-wire, 3D memory

...the

## STORE/33™

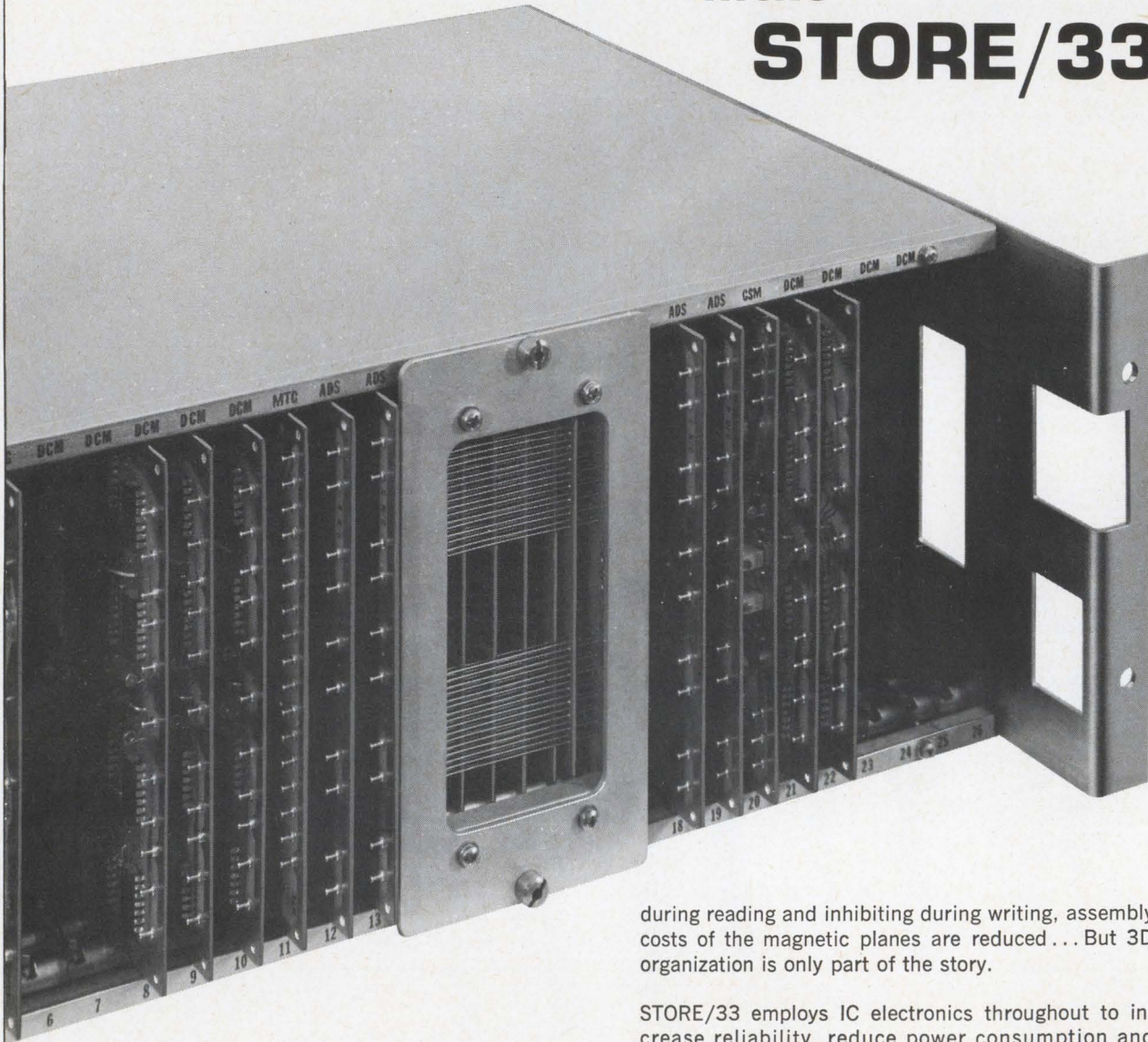

STORE/33 is in full production at Core Memories, Inc.\* . . . now you can have 2½D speed at coincident-current prices! For example, the 4K x 16 version of STORE/33 uses 18 mil cores to give a full-cycle time of 650 nsec. The price? Under \$4500\*\* in production quantities.

What makes this price breakthrough possible without a tradeoff in speed? The key, of course, is 3-wire 3D organization in which the fourth winding normally associated with coincident-current organization is eliminated. By utilizing the same winding for both sensing

during reading and inhibiting during writing, assembly costs of the magnetic planes are reduced . . . But 3D organization is only part of the story.

STORE/33 employs IC electronics throughout to increase reliability, reduce power consumption and achieve more compact packaging. The basic memory uses only four types of plug-in cards. The memory stack also plugs in. This standardization of circuit card types and modular construction reduces your inventory costs and simplifies maintenance. Word capacities to 16K, interface flexibility, plus a wide range of options . . . for the full story, write Data Products Corporation, 6219 De Soto Ave., Woodland Hills, Calif. 91364.

\*Core Memories, Inc. is a subsidiary of Data Products Corp.

\*\*Price does not include optional power supply.

Data Products manufactures LINE/PRINTERS™, DISCFILES®, Core Memories, Off-Line Printer Systems, Card Readers & Punches.

**P** data products

*"the peripheralists"*

# Our eyes do everything but blink.

**Newest camera tubes promise unprecedented performance in low light level TV, pattern recognition, tracking.**

Called a Cinticon™ camera tube our newest electro-optical device combines an orthicon-like storage/amplifying film with a Vidicon gun and intensifier. The result is a small super sensitive tube that will operate in near darkness.

Applications that immediately come to mind are surveillance cameras, cameras for on-spot news coverage, research into behavioral sciences, remote observation in light sensitive areas, as well as a host of military uses, both airborne and ground.

## **Vidisector®, Uvisector™ and Vidicon Tubes**

What makes advanced devices such as the Cinticon tube possible is our decades long experience over a wide range of tube design, production and application know-how.

Our very high resolution image dissectors, Vidisector and Uvisector tubes are cases in point. These magnetically focused and deflected camera tubes have a wide spectral response that ranges from near infrared to ultraviolet.

Add the advantages of reliability and simple operation and you can see why we've been the leading producer of these tubes for industrial process control, star trackers, scanning spectrometers and slow scan TV systems.

Example of our expertise at work: Vidicons which are the eyes for unerring guidance of Walleye and Maverick missiles.

Another: a unique Generation I image intensifier. Available as either a single or multiple stage device, it utilizes fiber optics coupled to a Vidicon for industrial security,

surveillance or low light level TV.

## **Correlation**

Not just content with seeing accurately, we also build a tube that remembers what it sees. Our work in correlation tubes has initiated entirely new methods of image processing. Among them: pattern recognition motion compensation, map and document reading, tracking, as well as electronic manipulation of images such as in area correlation, multiplication and division.

Naturally, we'd like to put this experience to work for you. Write for our brochure on electro-optical devices. If you have a blue-sky problem you want brought down to earth call us direct. ITT Electron Tube Division, International Telephone and Telegraph Corporation, P.O. Box 100, Easton, Pennsylvania. Phone: (215) 252-7331

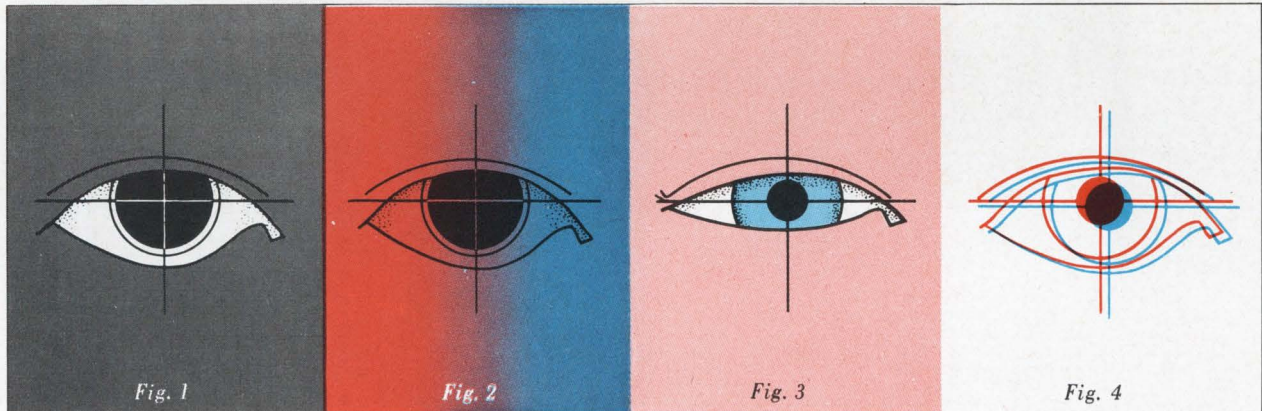

*Fig. 1* Cinticon camera tube combines orthicon-like storage with intensifier for super sensitivity under low light conditions. *Fig. 2* Vidisector and Uvisector tubes ranging from near infrared to ultraviolet are reliable, simple to operate.

*Fig. 3* Special design of Vidicons results in accurate guidance of Walleye and Maverick missiles. *Fig. 4* Correlation tubes make possible new methods of electronic manipulation of images.

**ELECTRON TUBE DIVISION** **ITT**

**For stronger, smaller, lighter  
PM motors, our alnicos  
pack quite a charge.**

# INDIANA GENERAL *We make it easy for the design engineer.*

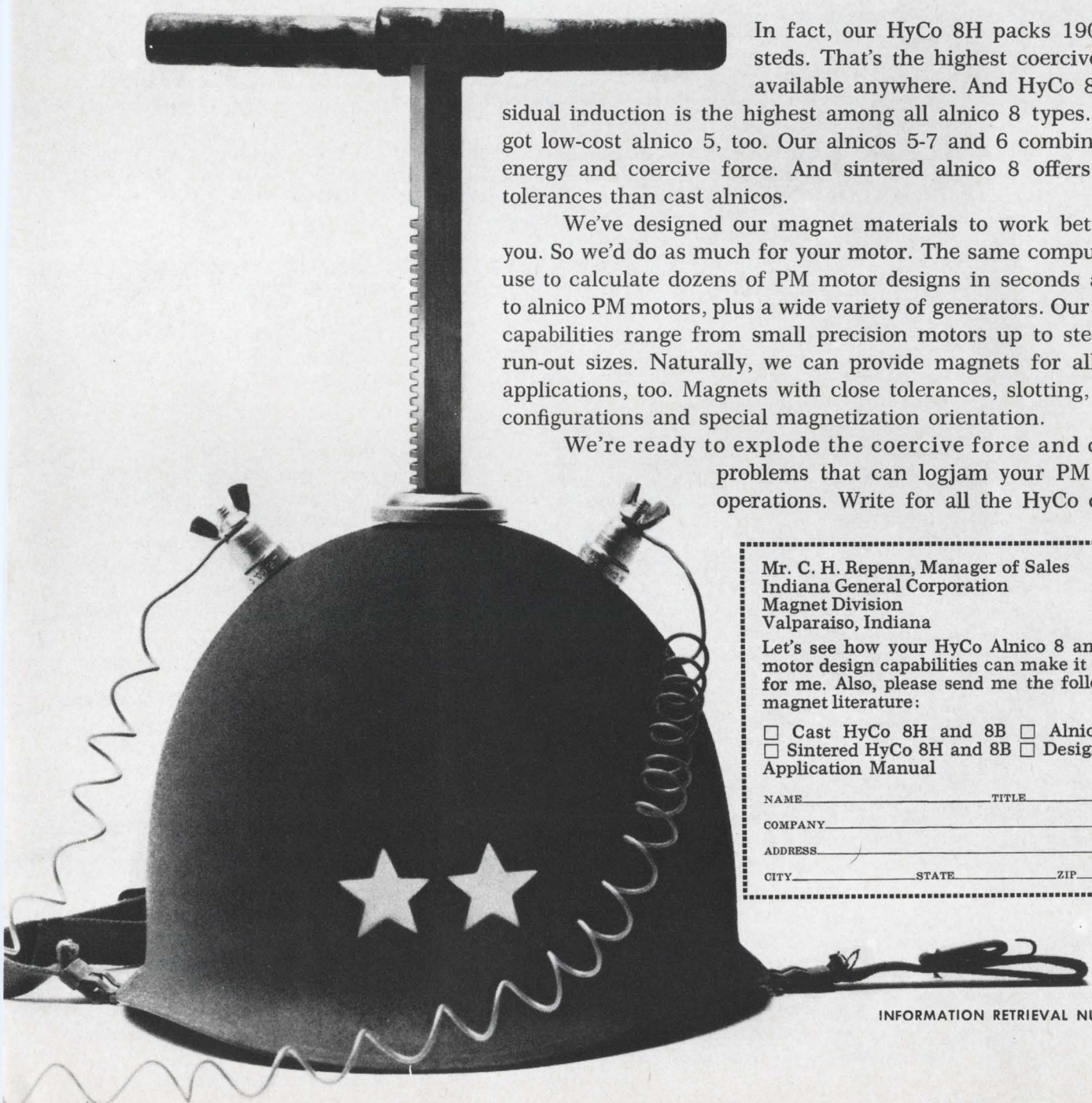

In fact, our HyCo 8H packs 1900 oersted. That's the highest coercive force available anywhere. And HyCo 8B's residual induction is the highest among all alnico 8 types. We've got low-cost alnico 5, too. Our alnicos 5-7 and 6 combine high energy and coercive force. And sintered alnico 8 offers closer tolerances than cast alnicos.

We've designed our magnet materials to work better for you. So we'd do as much for your motor. The same computer we use to calculate dozens of PM motor designs in seconds applies to alnico PM motors, plus a wide variety of generators. Our design capabilities range from small precision motors up to steel mill run-out sizes. Naturally, we can provide magnets for all these applications, too. Magnets with close tolerances, slotting, varied configurations and special magnetization orientation.

We're ready to explode the coercive force and design problems that can logjam your PM motor operations. Write for all the HyCo details.

Mr. C. H. Repenn, Manager of Sales  
Indiana General Corporation  
Magnet Division  
Valparaiso, Indiana

Let's see how your HyCo Alnico 8 and PM motor design capabilities can make it easier for me. Also, please send me the following magnet literature:

- Cast HyCo 8H and 8B     Alnico 5-7  
 Sintered HyCo 8H and 8B     Design and Application Manual

NAME \_\_\_\_\_ TITLE \_\_\_\_\_  
COMPANY \_\_\_\_\_  
ADDRESS \_\_\_\_\_  
CITY \_\_\_\_\_ STATE \_\_\_\_\_ ZIP \_\_\_\_\_

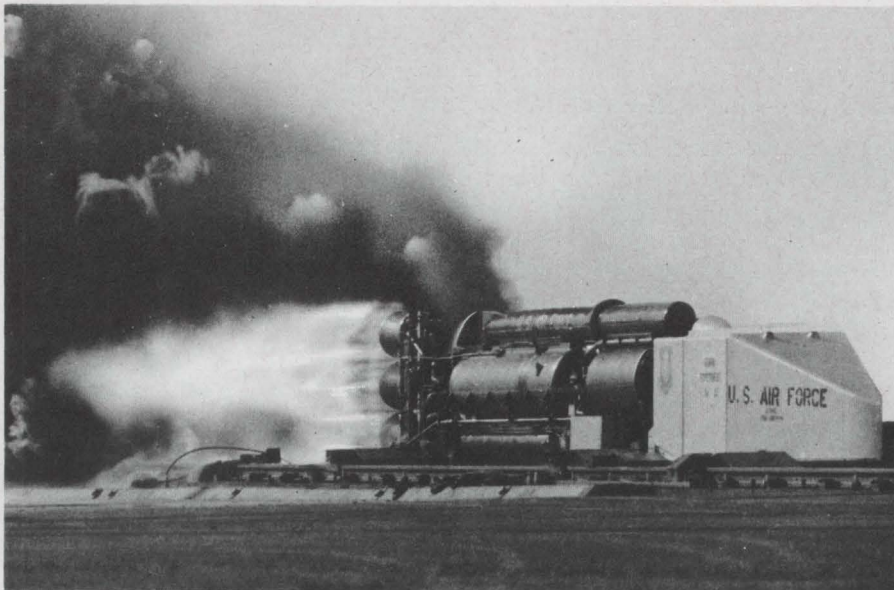

## Abbott Power Supplies on this Test Sled Have Been Subjected to 30 G's Vibration

Air Force personnel tested three Abbott model\* power supplies used to power electronic equipment on the Air Force Rocket Sled at Holloman Air Force Base. Test conditions consisted of 1½ minute sweeps of 30-G's peak sine vibration from 40 cps to 1500 cps, on each of three axis. Throughout these tests the Abbott power supplies operated within specifications.

All Abbott Power Supplies are hermetically sealed and encapsulated in heavy steel containers to meet the tough environments of the space age (MIL-E-5272C) with temperature extremes up to 100°C and conditions of altitude, vibration, shock, sand, dust, humidity, salt spray, fungus, sunshine, rain, and explosion. Under these conditions the power supply must operate normally. Abbott power modules use only the highest quality semiconductors and MIL-T-27B transformers in their construction to obtain the high degree of reliability under tough environments demanded by today's military requirements. To withstand heat sink temperatures of 100°C all silicon semiconductors are used exclusively.

The Abbott line of power modules includes output voltages from 5.0

volts DC to 10,000 volts DC with output currents from 2 milliamperes to 20 amperes. Over 3000 models are listed with prices in the new Abbott Catalog with various types of inputs:

- 60 $\phi$  to DC, Regulated
- 400 $\phi$  to DC, Regulated
- 28 VDC to DC, Regulated
- 28 VDC to 400 $\phi$ , 1 $\phi$  or 3 $\phi$
- 60 $\phi$  to 400 $\phi$ , 1 $\phi$  or 3 $\phi$

Included in the Abbott catalog is a listing of environmental parameters per MIL-E-5272C together with the cost and time required to qualify an Abbott Module. Many Abbott power supplies have already been completely tested and qualified to various environmental specifications. Copies of these test reports are available by phoning or writing to Abbott at the address below.

\*Model CL24D-55A, Ser. Nos. 4327, 4328 and Model A1D-70A, Ser. No. 5358, were tested.

TO: Abbott Transistor Labs., Inc., Dept. 97  
5200 West Jefferson Blvd.  
Los Angeles, California 90016

Sir:  
Please send me your latest catalog on power supply modules:

NAME \_\_\_\_\_ DEPT. \_\_\_\_\_  
COMPANY \_\_\_\_\_  
ADDRESS \_\_\_\_\_  
CITY & STATE \_\_\_\_\_

# Designer's Datebook

APRIL 1969						
Sun	Mon	Tue	Wed	Thu	Fri	Sat
6	7	1	2	3	4	5
13	14	15	16	17	18	19
20	21	22	23	24	25	26
27	28	29	30			

MAY 1969						
Sun	Mon	Tue	Wed	Thu	Fri	Sat
4	5	6	7	1	2	3
11	12	13	14	15	16	17
18	19	20	21	22	23	24
25	26	27	28	29	30	31

For further information on meetings, use Information Retrieval Card.

### Apr. 30-May 2

**Electronic Components Conference** (Washington, D. C.). Sponsor: G-PMP, EIA; James O'Connell, ITT Hdqs., 320 Park Ave., New York, N. Y. 10022

CIRCLE NO. 469

### May 5-7

**Electrical & Electronic Measurement & Test Inst. Conference** (Ontario, Canada). Sponsor: G-IM; G. E. Schafer, National Bureau of Standards, Boulder, Colo. 80302

CIRCLE NO. 470

### May 5-8

**International Microwave Symposium** (Dallas, Texas). Sponsor: G-MTT; J. B. Horton, POB 5012, Texas Instruments Inc., Dallas, Texas 75222

CIRCLE NO. 471

### May 6-8

**Frequency Control Symposium** (Fort Monmouth, N. J.). Sponsor: U. S. Army Electronics Command, Director, Electronic Components Laboratory, USAEC; Attention: AMSEL-KL-DT (Mr. M. F. Timm), Fort Monmouth, N. J. 07703

CIRCLE NO. 472

### May 14-16

**Spring Joint Computer Conference** (Boston, Mass.). Sponsor: G-C, AFIPS; T. D. Bonn, Honeywell EDP, 200 Smith St., Waltham, Mass. 02154

CIRCLE NO. 473

### May 19-21

**Aerospace Electronics Conference** (NAECON) (Dayton, Ohio). Sponsor: G-AES, Dayton Section; J. E. Singer, 5705 Coach & Four Drive East, Kettering, Ohio 45440

CIRCLE NO. 474

Please write for your FREE copy of this new catalog or see EEM (1968-69 ELECTRONIC ENGINEERS MASTER Directory), Pages 1727 to 1740.

**abbott transistor**

LABORATORIES, INCORPORATED

5200 W. Jefferson Blvd./ Los Angeles 90016  
(213) WEbster 6-8185 Cable ABTLABS

INFORMATION RETRIEVAL NUMBER 11



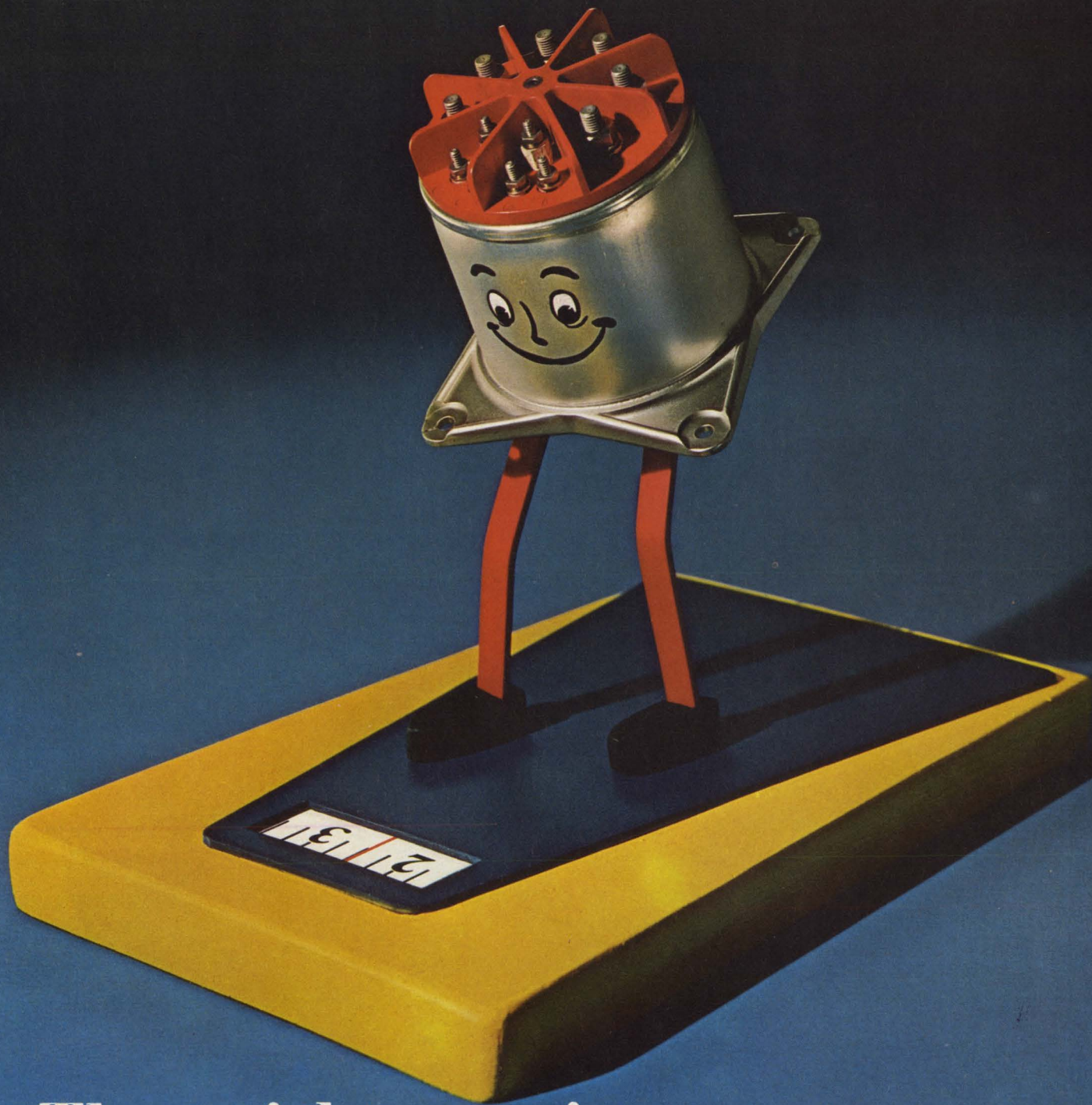

## The weight-conscious contactor...

### (for heavy-amp applications)

Twenty-two percent lighter for 150 amp applications than any existing 100 amp contactor: 3 lb. max. to be exact. That's right, the new Guardian 150 amp Series 4400 Contactor is 22% lighter and 16% smaller in volume than any existing 100 amp contactor.

Unique? You bet. And there's more. The 4400's design features internal as well as external phase isolation. It's unique—again—in offering a hermetically-sealed coil to prevent contact contamination, plus a hermetically-sealed unit outer cover.

Available 3 PSTNO normally open with 10 amp (*not* 5 amp) auxiliary contacts, the 4400 is designed for 240/416 VAC, 400 Hz systems of the future as well as 115/200 VAC, 400 Hz and 28/30 VDC systems of today.

A new 75 amp contactor, the Series 4500, offers the same basic design advances. For complete specifications and test reports on these two new weight-conscious contactors that let you do more with less, write for Bulletin D3.



**GUARDIAN<sup>®</sup>  
ELECTRIC**

MANUFACTURING COMPANY 1550 W. Carroll Ave., Chicago, Illinois 60607

# Electrical Engineers:

If you have a flair for semiconductor circuit or equipment design, try the circuit at IBM Burlington.

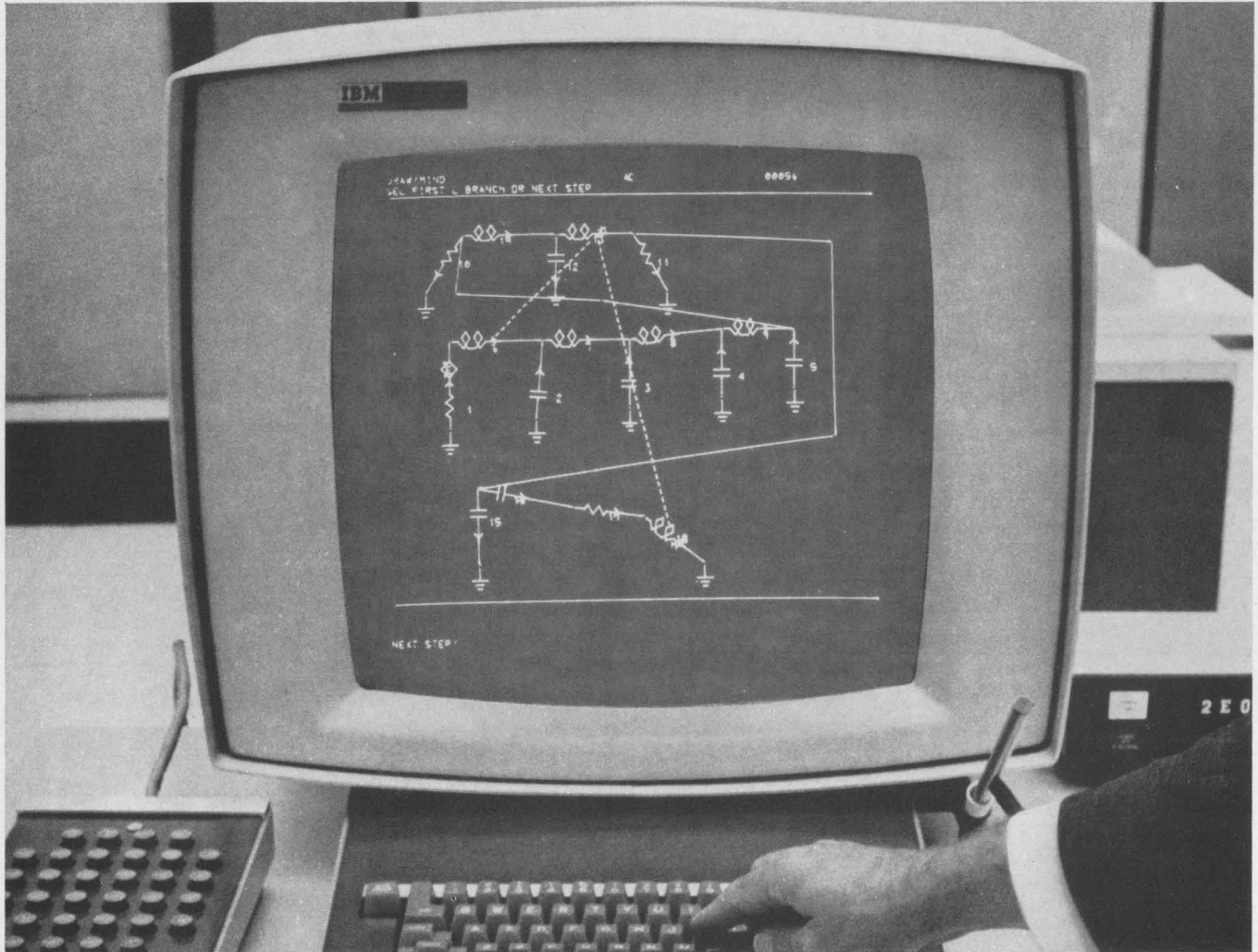

An Engineer at a computer terminal checks out a proposed electrical circuit design.

Because here is where significant work in monolithic circuits and magnetic film memories is going on for IBM. And we're continuing to develop new computer circuitry.

### Interdisciplinary environment

Here at Burlington you'd work with other top scientists and engineers in advancing the state of the semiconductor art. If you qualify, you'd have access to the latest equipment, including advanced computer systems as working tools.

Our need for EE's runs the gamut from circuit design and equipment development to on-line production. Depending on your engineering background and interests, you

could work in any one of the following areas: magnetic film memories, monolithic circuit design and characterization, processing equipment design, product engineering, and manufacturing engineering.

### Grow with IBM

Today's major growth industry is information handling and control. And IBM is a leader in that field. This growth environment can help bring out the best of your talents and abilities. Because in a growth company like IBM you must work constantly toward greater achievement. This means more opportunities to achieve distinction and personal recognition.

So, if you're a problem-solver who wants a personal sense of achievement and recognition for your hard work in an exciting growth company, consider IBM.

### Call or write

Get in touch with us. Call Bob Williams at (802) 769-2276 collect. Or send him your resume at IBM Corporation, Department CD1009, P.O. Box "A," Essex Junction, Vermont 05452.

An Equal Opportunity Employer

# IBM®

# HAPPENINGS IN ELECTRONICS

April, 1969

## Motorola accelerates pace in Optoelectronics

Unique low-cost phototransistors in molded plastic packages are the latest addition to Motorola's growing line of Optoelectronic devices. The MRD450 is in a 2-leaded Mini-TR package with an integral lens for highest sensitivity and definition. The MRD 100 and 150 are in subminiature Micro-TR packages for high density mounting. Compared to earlier devices which were prohibitively expensive, the new phototransistors are low cost by any scale. The 100-pc. quantity prices are: 80¢ for the MRD150; 1.00 for the MRD100; and 1.50 for the MRD450. They are the only available plastic phototransistors with homogeneous molded cases. The single-piece package eliminates the sealing problems of the older design. They are sensitive thruout the visible and near infrared spectral range. Circle #241 for data sheets and call Schweber for delivery.

## New family of MOSFETs from Union Carbide

Union Carbide Semiconductor, specialists in field effect transistors, announces a new family of MOSFET transistors. Some notable features of these devices raise the state-of-the-art in MOSFETS to a new high.  $I_{dss}$  (zero gate voltage drain current) is 20 pA., typical which is the lowest leakage on the market. The transient gate to source voltage is guaranteed at  $\pm 125$  volts which eliminates the need for gate protective diodes, resulting in ultra high input impedance. Immediate shipment from stock. Circle #242 for data sheets.

Single Units	Maximum	1-99	100-999	Dual Units	Matched	1-99	100-999
Type #	$I_{dss}$			Type #	Differential		
3N163	200 pA.	8.00	5.35	3N165	$\pm 100$ mV.	22.50	15.00
3N164	400 pA.	6.75	4.50	3N166	—	18.00	12.00

## A half million mikes in one can!

GE has come out with a new line of High Capacitance Computer Grade Electrolytic Capacitors. They were designed for your more exacting requirements and feature unusually high capacitance at low voltage ratings thru 100 volts. They will give excellent service in computer power supplies, industrial controls, high-gain amplifiers, and any application requiring the features listed. Dual voltage ratings for continuous operation at 65°C and 85°C; case sizes range from 1 $\frac{3}{8}$ " to 3" in diameter and up to 8 $\frac{5}{8}$ " in length. A 6-page product data bulletin is available listing individual electrical and physical characteristics. Circle #243.

### YOU GET THESE 12 DEVICES IN THE DICSK

TYPE #	DESCRIPTION	VALUE*
RD-86B	16-pin mating connector, polarized	7.00
MD-55	14-pin Flat-pack socket	8.00
029-090	14-pin Flat-pack contactor	6.25
029-003	Flat-pack carriers (2)	.30
029-385-01	14-lead DIP socket	6.20
029-554-01	14-lead contactor	7.05
029-240-01	14-lead DIP carriers (2)	.30
MF-11-8B	8-lead TO package	8.20
MF-11-10B	10-lead TO package	8.56
MF-11-12B	12-lead TO package	8.92
Total value .....		60.78
Kit price .....		39.88
You save .....		20.90

\*as of current published prices, 1-24 quantities.

## For designers:

### A kit of Barnes Integrated Circuit Sockets

If you're having trouble selecting IC sockets, we have just the thing to solve your problems — a Designers' IC Socket Kit! The kit contains DIP, flat-pak, and TO can type sockets as well as contactors and protective carriers, and finally a universal mating connector to the sockets. Twelve devices in all. Imagine the flexibility in developing breadboards with this kit sitting in front of you. The perplexing problem of choosing the right socket for your application is now child's play. Interconnection schematics are included in the kit. What's more, you save \$20.90! Remember this: with the universal mating connector you can interconnect the DIP, the Flat-Pak, and the TO-Can to each other. Call Schweber, ask for DICSK and get immediate shipment.

## Review of new catalogs: The New 1969 Motorola Condensed Catalog

Looking for a catalog that will give you a quick and efficient reference to the entire line of Motorola semiconductor devices? It's yours, and it's up-to-the-minute complete. As usual, an alpha-numerical index precedes more than fifty pages of components by categories. The major electrical characteristics are listed, permitting preselection of components for specific applications. Circle #244.

## How to get more value out of an Op Amp data sheet

The integrated Operational Amplifier is now being used almost universally as a circuit component. Because the miniature-packaged op amp has made available to designers an infinite variety of applications, it is being transformed into just another 'discrete' active element. This being the case, the same consideration should be given to op amp characteristics as is given to other discrete devices. With this end in mind, Motorola has published a 12-page application note to provide better understanding of the open loop characteristics of op amps and their significance to overall circuit operation. Related problems are discussed at length. Circle #245.



# ...looking for a specific interference filter?

Sprague makes many types to meet varied needs.

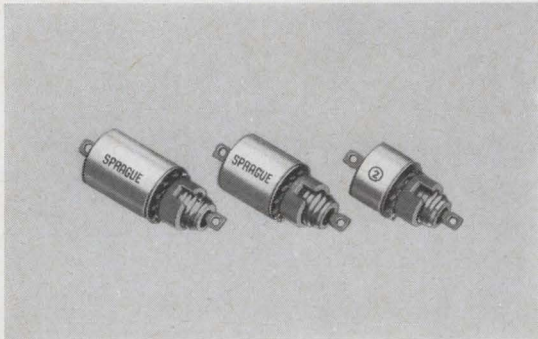

INFORMATION RETRIEVAL NUMBER 821

## SUBMINIATURE EMI FILTERS FOR D-C APPLICATIONS

50 or 100 VDC @ 125 C  
L and Pi circuits, 0.1 to 2.0 A  
Feed-thru capacitors, 7.0 A

ASK FOR ENGINEERING BULLETIN 8130A

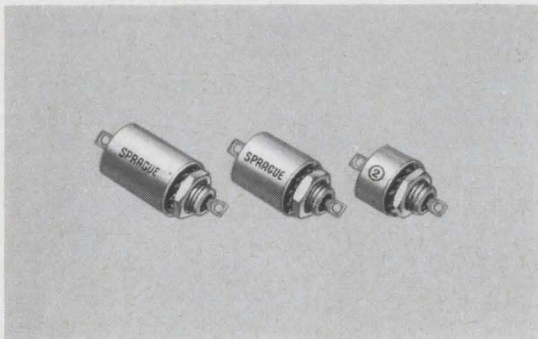

INFORMATION RETRIEVAL NUMBER 822

## SUBMINIATURE EMI FILTERS FOR A-C APPLICATIONS

125 VAC, 0-400 Hz, 125 C  
L and Pi circuits, 0.1 to 1.5 A  
Feed-thru capacitors, 5.0 A

ASK FOR ENGINEERING BULLETIN 8131

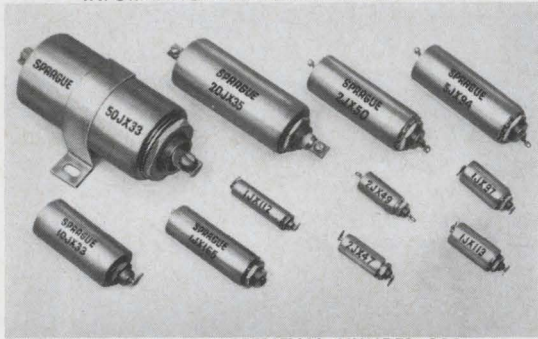

INFORMATION RETRIEVAL NUMBER 823

## GENERAL-PURPOSE EMI FILTERS

60 popular designs in various  
circuit configurations  
Current ratings, .005 to 50 A  
Voltage ratings, 50 VDC to 250 VAC

ASK FOR ENGINEERING BULLETIN 8100B

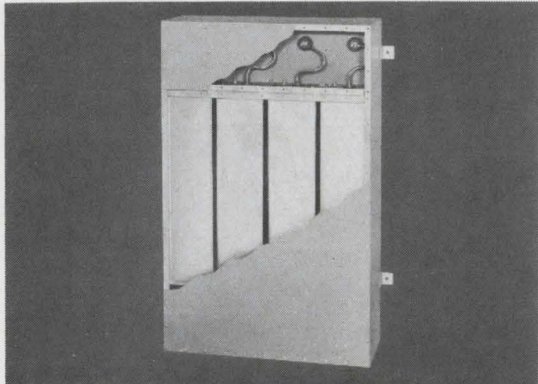

INFORMATION RETRIEVAL NUMBER 824

## HEAVY-DUTY POWER LINE FILTERS

250 VAC, 60 Hz  
30, 50, 100, and 200 A  
100 db from 14 KHz through  
10 GHz at full load

ASK FOR ENGINEERING BULLETIN 8410

For engineering bulletins as noted above, write: Filter Division,  
Sprague Electric Co., P.O. Box 39, Annapolis Junction, Md. 20701.



'Sprague' and '®' are registered trademarks of the Sprague Electric Co.

**THE BROAD-LINE PRODUCER OF ELECTRONIC PARTS**

# News

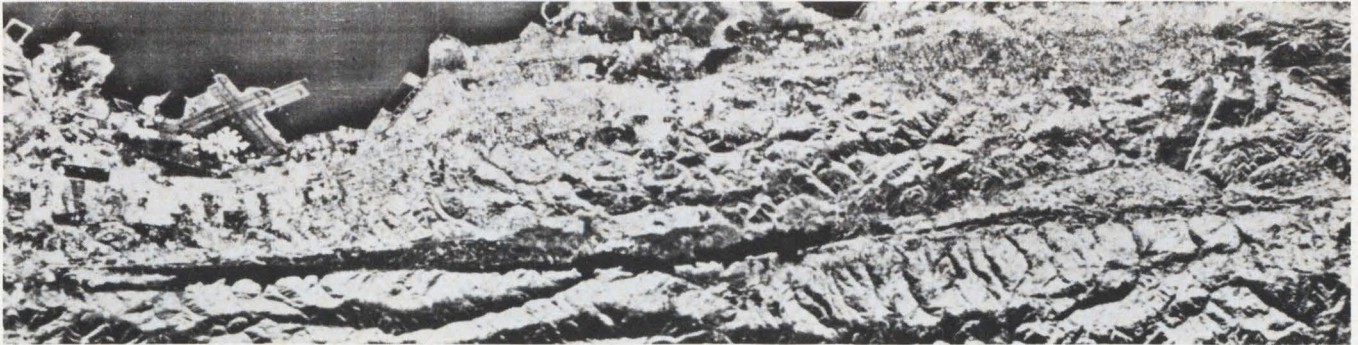

**Earth-fault systems** of San Francisco area show up like ravines in this radar-imaged

photo. Satellite imagery would provide uniform data on less-known faults, p. 25.

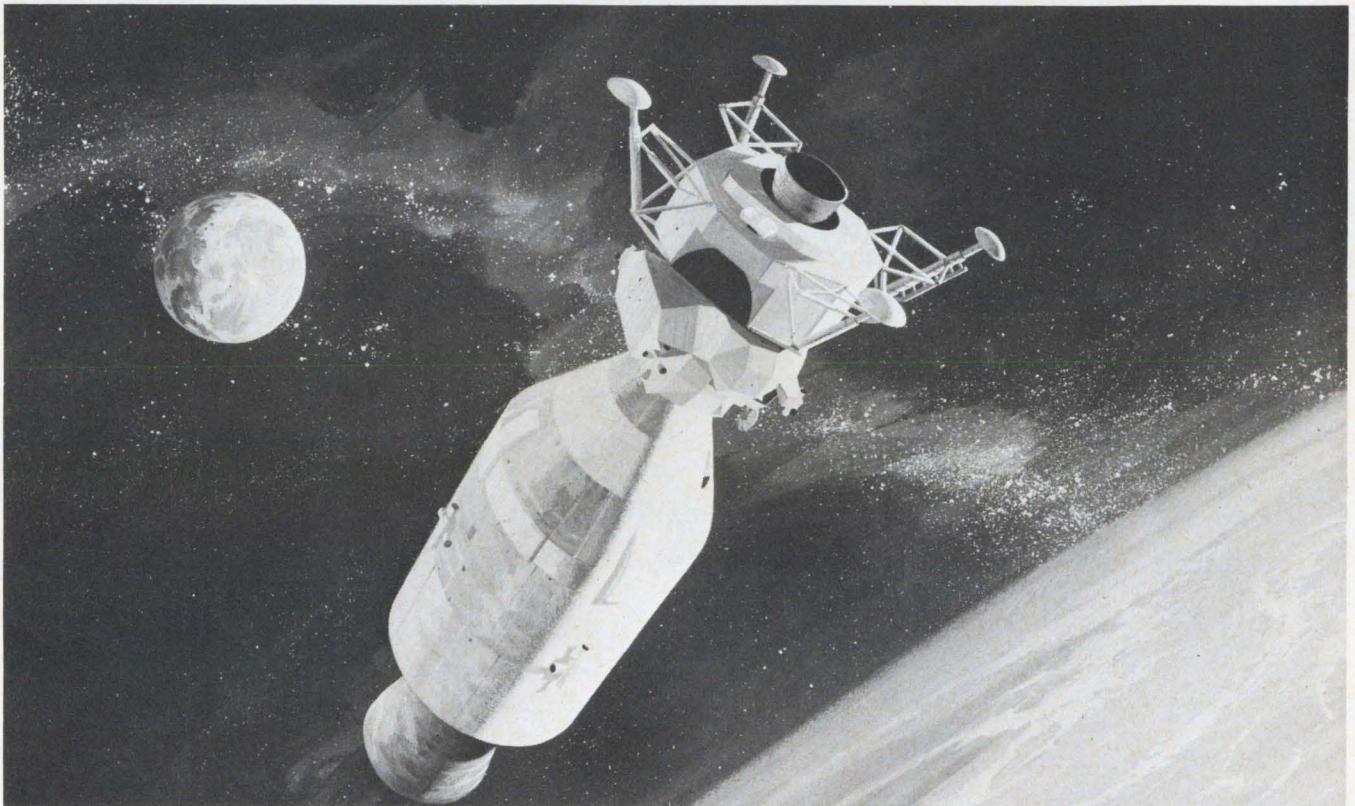

**Apollo 9 electronics** systems pass most severe test yet; earth-orbital rehearsal opens

the way for summer moon landing. "Mascons" still pose a problem, p. 34.

## Also in this section:

**Portable alarm system** to warn Army men against deadly nerve gas. Page 42

**Pulsed laser** puts out highest power yet: 10 trillion watts. Page 44

**News Scope**, Page 21 . . . **Washington Report**, Page 47 . . . **Editorial**, Page 53

# Something *New* Has Been Added!

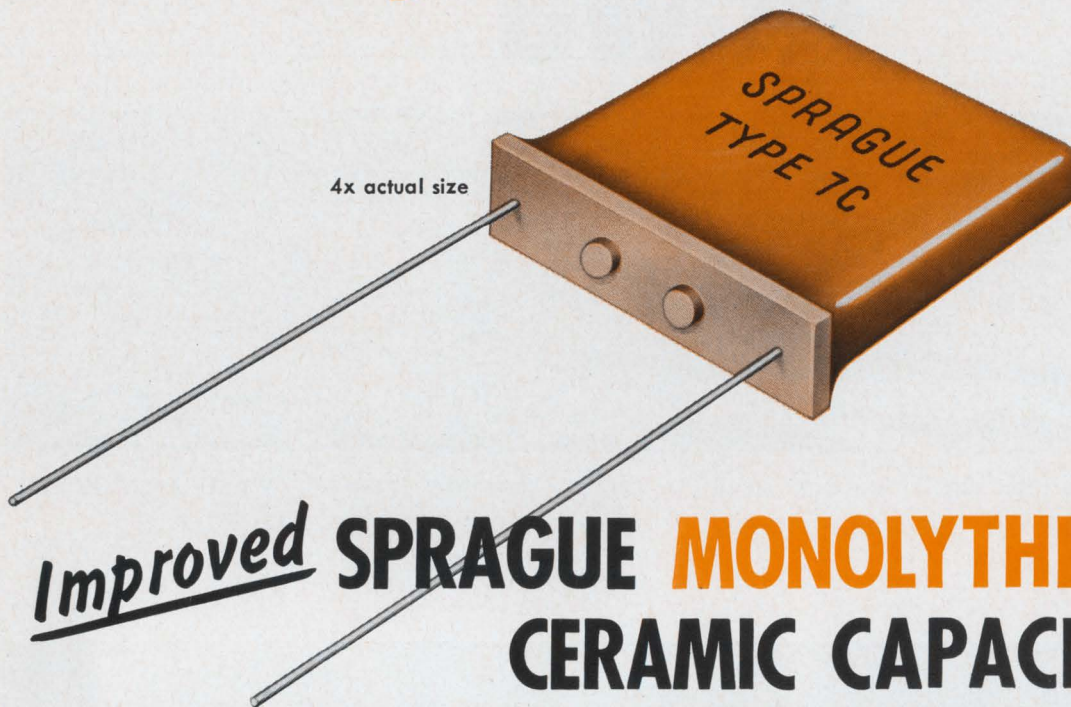

## *Improved* SPRAGUE MONOLYTHIC<sup>®</sup> CERAMIC CAPACITORS

now have a phenolic terminal base

Type 7C Radial-lead Capacitors are made with alternate layers of sprayed ceramic dielectric material and screened metallic electrodes, fired into a solid homogeneous block and coated with a tough phenolic resin. Their new bossed terminal base construction provides these advantages: (1) No resin run-down on leads. (2) Uniform lead spacing is automatically maintained. (3) No dirt and moisture entrapment; degreasing fluid flows freely between capacitor and board.

Body Code	EIA Characteristic	Operating Temperature Range	Maximum Cap. Change over Temp. Range	WVDC	Capacitance Range	Capacitance Tolerance
082	NPO	-55 C to +125 C	±60ppm/°C	50 100 200	51 pF to .024 μF	±20% ±10% ±5% ±2%
075	N750	+25 C to +85 C	-750 ± 120 ppm/°C	50 100 200	.001 μF to .082 μF	±20% ±10% ±5% ±2%
		-55 C to +125 C	Meets MIL-C-20 Char. UJ			
067	X7R	-55 C to +125 C	±15%	50 100	.0018 μF to 1.5 μF	±20% ±10%
023	Z5U	+10 C to +85 C	+22%, -56%	50	.01 μF to 3.3 μF	+80, -20% ±20%

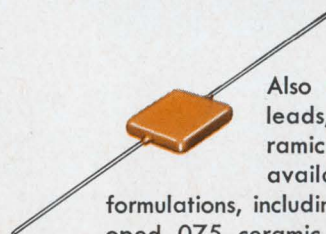

Also made with axial leads, Monolythic<sup>®</sup> Ceramic Capacitors are available in four body formulations, including a newly-developed 075 ceramic material, as described in the adjacent chart.



For complete technical data write for engineering bulletins on Monolythic Ceramic Capacitors to: Technical Literature Service, Sprague Electric Co., 347 Marshall St., North Adams, Mass. 01247.

### SPRAGUE COMPONENTS

CAPACITORS  
TRANSISTORS  
RESISTORS  
INTEGRATED CIRCUITS  
THIN-FILM MICROCIRCUITS

PULSE TRANSFORMERS  
INTERFERENCE FILTERS  
PULSE-FORMING NETWORKS  
TOROIDAL INDUCTORS  
ELECTRIC WAVE FILTERS

CERAMIC-BASE PRINTED NETWORKS  
PACKAGED COMPONENT ASSEMBLIES  
BOBBIN and TAPE WOUND MAGNETIC CORES  
SILICON RECTIFIER GATE CONTROLS  
FUNCTIONAL DIGITAL CIRCUITS

45C-8107R1

INFORMATION RETRIEVAL NUMBER 14



<sup>®</sup> 'Sprague' and '®' are registered trademarks of the Sprague Electric Co.

## Sentinel to 'Safeguard' Minuteman missile sites

In his first major defense decision, President Nixon appeared to change more than the Sentinel system's name. Referring to it as a "Safeguard" system the Chief Executive asked Congress to approve the installation of the ABMs on a modified timetable "clearly related to our periodic analysis of the threat" from both the Soviet Union and Communist China, rather than on any specific schedule.

While the system he recommended will use components already developed for Sentinel, deployment will be changed to reflect a new concept of "local defense for selected Minuteman sites and an area defense designed to protect our bomber bases and our command control authorities."

Deployment of sites around cities is being abandoned, the President indicated because "the heaviest defense system considered . . . still could not prevent a catastrophic level of U. S. fatalities from a deliberate all-out Soviet attack." Also, he said, "the Sentinel system could be misinterpreted as the first step toward the construction of a heavy system."

President Johnson's original \$1.7-billion system envisioned 15

to 20 antimissile sites stationed near the largest population centers in the country, whereas that requested by Mr. Nixon consists, initially, of two Minuteman missile sites—one at Malmstrom Air Force Base in Montana, the other at Grand Forks Air Force Base in North Dakota. Eventually the system, in toto, would encompass 12 sites designed to protect the country's retaliatory capability.

Long-range Spartan and short-range Sprint missiles plus radar would be located at the various sites, at a total cost of \$6 to \$7 billion, which is a minimum of \$500 million more than the Johnson system. But because of the deliberate stepped pace of the deployment asked by Nixon, budgetary requests for the coming year amount to \$900 million, one half of that asked by the previous Administration.

By concentrating on these two site installations, scheduled to be completed by 1973, Deputy Defense Secretary David M. Packard explained that as technical deficiencies arise, they could be solved before constructing any additional sites.

In addition to the first two sites in Montana and North Dakota the 10 additional sites will be located in southern New England; Washington, D. C.; Florida or Georgia; Michigan or Ohio; Texas; Warren Air Force Base, Wyoming; Whiteman Air Force Base, Missouri; upper northwest Oregon, and both central and southern California.

### Defense satellite communications pressed

The Dept. of Defense continues to press advances in both of its satellite communication systems, in its operational strategic system

and in its developmental tactical program. TRW, Inc., of Redondo Beach, Calif., has been picked by the Air Force to design new synchronous satellites for the high-capacity operational strategic system. Phase I satellites that presently make up the Defense Satellite Communications System (DSCS) are non-synchronous, provide low capacity, and continuously migrate in orbit. All were developed by Philco.

The Phase II satellite will be built under a nearly \$37.7-million contract. It will be designed to provide highly secure channels and will employ steerable, narrow-beam antennas that cover areas on the Earth's surface of up to 2000 miles in diameter. The directional narrow beams will permit use of relatively small, relatively simple, ground terminals. The satellites will carry sufficient propulsion to permit them to move to new locations above the Earth, in line with changing relay needs. First launch is scheduled for early 1971.

The Air Force also announced that RCA, under a \$1.3-million contract, is building airborne antenna subsystems for test use in the new Tactical Satellite Communications Program (TACSATCOM). The subsystem under development includes both the antenna and the associated electronics for automatic acquisition and tracking. The system will provide accurate directional transmission of frequency signals from an aircraft to an orbiting satellite, for relay to ground. (RCA is also developing for the Army, under a separate and earlier contract, experimental ground and airborne terminals for use with the TACSATCOM system.)

### Imports growing faster than exports, EIA finds

Imports of electronic products into the U. S. are increasing twice as fast as exports, according to a five-year study just released by the Electronic Industries Association.

But in dollar figures the trade balance still favors the U. S. In 1968, for example, total exports of electronic products totaled \$2.2 billion while imports totaled \$1.4 billion, the EIA reports.

The association study, outlined



Sentinel gets partial go-ahead

in the February issue of *Electronic Trends/International*, shows that for 1964-68, exports of selected electronic products increased 98.7 per cent, while the imports rose 214.5 per cent.

For 1968 alone, the EIA reports, exports in the military, industrial and commercial sector, reached \$1.4 billion, roughly two-thirds of all electronic exports. Computer apparatus continued to be the leading export item, totaling about \$486 million in 1967. Leading in export growth were radio-TV broadcast equipment—up 22 per cent—and detection equipment—up 20.6 per cent—over 1967.

In the consumer areas imports are growing at a much faster rate than exports. Despite a healthy 32.2 per cent gain in exports—with a big boost from tape recorders—to \$85.2 million in 1968, imports zoomed to nearly \$711 million—a 56.5 per cent increase over 1967.

Consumer-product imports in 1968 made up 52.2 per cent of total electronics brought into this country. The report notes that many of these imports came in under American manufacturers' brand names, with Japan, the dominant supplier, winning 77.2 per cent of the total U. S. 1968 consumer-product market.

## Computer 'reads' utility meters 100 miles away

The first working demonstration of remote, automatic utility-meter reading over 100 miles of telephone lines is now being conducted on some 60 meters in homes and businesses in Belvidere, Ill. The meters are "called," without ringing the customer's telephone, by the computer located in the South Milwaukee, Wis., plant of McGraw-Edison.

Billing information is prepared, without the aid of human meter readers, by the automatic remote-meter-reading system (Armeter)

developed by the R&D Dept. of the McGraw-Edison Power Systems Div. in South Milwaukee.

Located at the meter is a small, encoder-register that stores the meter reading, together with a transponder that interfaces with the telephone circuits. The encoder, utilizing IC circuitry, has two discs with coded apertures interposed between several light sources and their photocells. The encoder output is applied to the line through transponders, which, in turn, are connected through line couplers.

When the meter is to be "read," the transponders and couplers are energized by a 250-volt line pulse with a long risetime to avoid ringing the telephone. In response a tone generator in the transponder sends back tone frequencies that identify the customer's meter. The photocell light sources are then turned on in sequence, energizing the photoconductor cells and their associated tone oscillators. A combination of tones that represents the meter reading is sent out over the line through the coupler.

## Ultrasonics can detect heart-rejection signals

Ultrasonics can be used to spot changes that lead to early rejection of the transplanted heart by heart-transplant patients. This disclosure was made by researchers at the Stanford University Medical Center, Stanford, Calif., during the recent annual meeting of the American College of Cardiology.

Early rejection is the crisis that most often proves fatal for heart-transplant patients. The ultrasonic observation gives earlier indications of such changes than do other methods used until now.

Danger signals for early rejection are also obtained by watching for: (1) variations in the amplitudes of the voltages fed to the patient's electrocardiograph; (2) changes in the heart's waveform activity and its contraction rhythms; (3) by listening to the sounds of blood flowing from the veins into the heart.

The ultrasonic method bases itself on the fact that, during early rejection, the heart cells fill with fluid and the heart walls swell and

stiffen. These changes can be "seen" by observing ultrasonic pulse returns on a TV screen.

Adaption of ultrasonics as an adjunct to other diagnostic methods was made by Dr. Richard Popp, a Stanford postdoctoral fellow in cardiology. The equipment, which was a barium titanate transducer and operates at 2.25 MHz, had previously been used for detecting head tumors; the position of the fetus; and the location of foreign bodies in the human body.

Two types of TV displays are used. The first is a straight-forward distance-measuring trace, which first locates the exact position of the heart within the chest cavity. The second is a long-persistence display that "outlines" the heart itself. With the latter, the doctor can determine whether or not the heart is shrinking, expanding, or is staying constant in size.

## Nine-color laser built

A new tunable laser, also developed at Stanford Univ., may soon cut the high costs of chemical and medical spectroscopic research by providing a wide range of colored laser beams that are needed to analyze different materials.

The device consists of a 3-megawatt pulsed ruby laser, which shines on a small lithium niobate crystal held between two mirrors. The crystal generates nine discrete laser beams whose wavelengths depend on the angle at which the original beam strikes its asymmetric surface. Six of these beams can be tuned in wavelength, simply by rotating the crystal and mirrors. The other three are fixed.

## NASA seeks Viking bids

Design and cost proposals for a prime contractor on the planetary lander and project-integration portion of NASA's Viking project have been requested by April 2 by the Langley Research Center, Hampton, Va. Two Viking spacecraft, each consisting of a lander and an orbiter, are eventually to be procured for flights to Mars in 1973. The scientific fact-finding Missions will seek information about possible life on the planet.



# Is the 901 counter-timer just too good to be true?



Shown with optional 1.3-GHz plug-in.

# NO!

## But we can't blame you if you think so.

Picture a state-of-the-art, 200-MHz, universal counter-timer selling for \$250 to \$1000 below the competition. Having trouble? Picture won't focus? Of course not. Cheap price tags usually mean cheap products.

Focus in again. This time, picture technological breakthroughs—new circuitry and new components that the competition hasn't caught up with yet. Now, see how easy it is to make a better product and sell it for less, too?

How much better is the CMC 901? Take a look. Range: 200 MHz (instead of 125 or 135) without prescaling or plug-ins. Gate times:  $1\mu\text{sec}$  to 100 sec instead of to just 10 sec. TIM: built-in, with a resolution of 10 nsec instead of 100. Input sensitivity: 10 mV instead of the usual 50 or 100. Readout: 9 decades not just 8.

But specs aren't everything. How about the Model 901's "universality"? Besides counting to 200 MHz directly

(and 1.3 GHz or 3.3 GHz with optional plug-ins) the 901 also scales signals, measures time interval, period, and multiple-period average. It provides frequency and multiple-frequency ratios as well as total count; and, as an optional extra, it can be operated completely by remote control. The basic price tag? Just \$2475. So we can't blame you if you're skeptical, but would you be happy if you bought a lesser model and paid more?

*For the full facts, circle the reader service card.*

COMPUTER MEASUREMENTS COMPANY



A Division of Pacific Industries

12970 Bradley/San Fernando, Calif. 91342/(213) 367-2161/TWX 910-496-1487

INFORMATION RETRIEVAL NUMBER 15

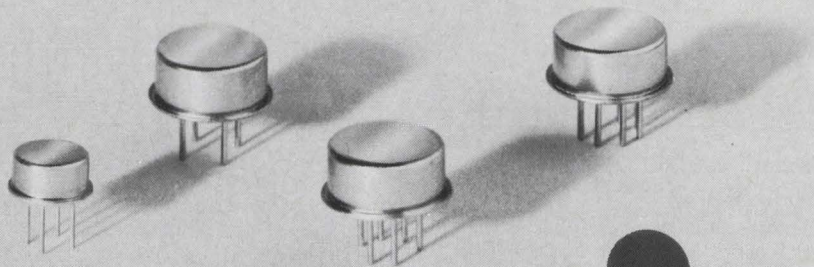

# Damon's got 'em!

## Monolithic Crystal Filters.

IMMEDIATE DELIVERY ON "STANDARDS"



Custom designs take a little longer.

If one of the 4 "standards" in the accompanying chart meets the requirements of your communications system, you can forget the delivery problem. Damon is making immediate off-the-shelf delivery of evaluation quantities. In addition, you get all these extra advantages over conventional, multi-component filters: much smaller size, significantly lower price and practically zero failure rate.

Damon also offers a wide variety of computer-assisted custom designs but these take a little longer — 3 weeks from date of order.

For detailed technical brochure on Damon Monolithic Crystal Filters, write Electronics Division, Damon Engineering, Inc., 115 Fourth Ave., Needham, Mass. 02194. Or call (617) 449-0800.

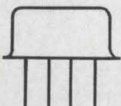
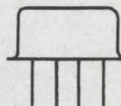
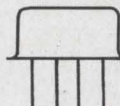
"STANDARD" 4 POLE MONOLITHIC CRYSTAL FILTERS

				
MODEL NO.	6347 MA	6347 MB	6348 MA	6348 MB
Center Frequency	10.7 MHz $\pm$ .5 KHz	10.7 MHz $\pm$ 1 KHz	21.4 MHz $\pm$ .5 KHz	21.4 MHz $\pm$ 1 KHz
Bandwidth, 3 dB	6 KHz min	15 KHz min	6 KHz min	15 KHz min
Bandwidth, 40 dB	24 KHz max	50 KHz max	24 KHz max	55 KHz max
Ripple, Max	1 dB	1 dB	1 dB	0.5 dB
Insertion Loss, Max	3 dB	2 dB	3 dB	2 dB
Spurious Returns	> 40 dB down	> 30 dB down	> 30 dB down	> 20 dB down
Terminations (Resistive)	1.5 kilohms	3.9 kilohms	0.38 kilohms	1.3 kilohms
Ultimate Atten.	55 dB	50 dB	50 dB	45 dB
Op. Temp Range	0°-60° C	0°-60° C	0°-60° C	0°-60° C
Case	TO-8	TO-8	TO-8	TO-5

**DAMON**

# 'Big eye' in the sky: Sensors to monitor earth

## Satellites to be launched in 1972 will detect crop blight, minerals, pollutants and other phenomena

**Elizabeth deAtley**  
West Coast Editor

With a map made from satellite photos, American forestry experts will spot telltale signs of blight in the great forests of the country and notify local authorities in time to check it . . . Geologists will see land structures that point to mineral deposits in hitherto unexplored regions of the world . . . Sanitary engineers will check the pattern of pollutants in the Great Lakes and other bodies of water and be guided in their designs of sewage-disposal systems.

In three years remote sensing equipment in satellites will make controls like these possible. The first earth-resources satellite in a continuing program, scheduled for launching by NASA in 1972, will contain electronic equipment that is sensitive to optical and solar infrared wavelengths. These will probably include:

- Three return-beam vidicon TV cameras—one sensitive to the blue-green band, another to the red and the third to the solar infrared.

- A multispectral scanner sensitive to four bands in the visible and solar infrared.

Electronic signals collected by this equipment will be relayed to ground stations, converted to images and finally into special photographic maps that reveal many things—the distribution of forests or crops, geologic features, water supplies, cities. The satellite will fly over every spot on earth about twice a month, relaying new pictures to ground stations so that maps can be constantly updated.

In addition to cameras and sensing equipment, the satellite may contain a data-collection system that will interrogate sensors on the ground—to determine the depth and temperature of a river at a certain point, say, or the number of seismic disturbances that have

occurred in the last five minutes. This information will also appear on the photos along with the image of the area under observation.

### Other sensors on the way

Optical and solar-infrared equipment like this is only the beginning. Already on the drawing boards are sensors that will detect many other parts of the electromagnetic spectrum (see Table, P. 28). Much of this equipment has already been tested in airplanes. It includes:

- Mid-range infrared scanners to detect forest fires, schools of fish, hot spots beneath the snow.

- Radar imagers to penetrate clouds and take pictures at night as well as by day.

- A radar scatterometer to measure the roughness of the sea.

- A passive microwave radiometer to measure and record the rate at which ice is melting.

The experts visualize a network of satellites that will provide daily coverage of the earth's surface.

How will data from all these different wavelengths be correlated? Can human interpreters hope to check out every spot on each of many different spectral images to determine which wavelengths best identify each feature of terrain?



Solar infrared color aerial photograph shows distribution of pollutants in Maumee Bay, Lake Erie. The sewage plant (1) discharges effluent (2) into Maumee Bay, which is trapped behind the recently built breakwater (3). (Photo courtesy of NASA).



## NEWS

### (Remote sensor, *continued*)

And what about the burden of counting every lake in the United States or every field of crops? Ultimately much of this will be done by computer. Already much research is being done to identify different features of the terrain by their spectral response patterns—their multiband tone “signatures”—so as to determine what response to expect from any one particular feature.

### Going west in great circles

NASA's first satellite is scheduled to circle the earth in a sun-synchronous polar orbit about 495 nautical miles high. Thus it will arrive at any given latitude at the same time of day, but at points about 1500 miles apart. Complete coverage of every point on the earth will be obtained about twice a month.

The return-beam vidicon cameras will televise areas of the earth about 100 miles on each side of the satellite's path. The data will be stored on tape for transmission to earth when the satellite is above a ground station. On earth, the conversion to images will probably be done by a laser recorder.

For reasons of economy, the first satellite will probably use two NASA STADAN stations—one at Fairbanks, Alas., the other at Rosman, N.C. But one day earth-resources satellites are expected to have their own dedicated receiving stations.

The three return-beam vidicon TV cameras aboard the first satellite were designed by RCA. They

---

**Solar high-altitude infrared color photograph** shows the urban expansion of the Los Angeles area. The direction and rate of urban sprawl and the effects on the countryside can be measured from aerial and space photographs. For example, a shift to lighter coloring in a populated area is an indication of urban decay, as this is reflected in declining attention to maintenance of lawns and plants in the area. Healthy vegetation shows up bright red in a solar infrared photo. (Photo courtesy of NASA).

What this country  
needs is a good  
nickel cigar...

and a  $\frac{3}{8}$ " square  
industrial  
cermet  
trimmer.

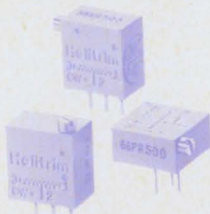

Helipot has the trimmer for \$3.50 list...  
now available in local stock.

*(But you'll have to find the cigar.)*

**Beckman®**

INSTRUMENTS, INC.  
HELIPOT DIVISION  
FULLERTON, CALIFORNIA • 92634

INTERNATIONAL SUBSIDIARIES: AMSTERDAM, CAPE TOWN, GENEVA, GLENROTHES,  
SCOTLAND, LONDON, MEXICO CITY, MUNICH, PARIS, STOCKHOLM, TOKYO, VIENNA

*(Remote sensor, continued)*

are sensitive, respectively, to blue-green in the 0.475-0.575 wavelength-micron region, to red at 0.580-0.680 wavelength-micron and to solar infrared at 0.690-0.830 wavelength-microns.

Why these bands? William A. Fischer, research coordinator for the Earth Resources Observation Satellite Program, U.S. Dept. of the Interior, Washington, D.C., says:

"We tried, by a reasoning process and by talking to the resources community, to isolate the parameters we most wanted to see. One of these is land form, including the form of the land beneath the water. To see through the water to the bottom, you must have one image in the blue or blue-green part of the spectrum because this is the region where solar energy is maximum and it is the only band that will penetrate the water.

"We also wanted to see the distribution of gross cultural features—cities—and this too can be done in the blue-green part of the spectrum.

"Then we decided that we not only want to see through the water; we also want to see the distribution of the water on the earth's surface. That requires another band—preferably in the near infrared part of the spectrum.

"Then we decided that, fourthly,

we wanted to see the distribution of vigorous vegetation. And you can do that, too, in the near infrared. Healthy vegetation looks bright red in an infrared photo.

"We proposed to NASA a two-camera system—blue-green and near infrared. Then we asked the Dept. of Agriculture what they would like to add. They have a computer program for determining the spectral signatures of crops, and they asked the computer: 'Given information in the blue-green and infrared, what third band would best help us to identify vegetation?' The computer searched its memory and came out with a wavelength in the red. So we selected three bands—blue-green, red and near infrared."

The three return-beam high-resolution vidicon cameras—4500 TV lines compared with 525 for the conventional vidicon—will be exposed simultaneously and then read out in sequence. The video pictures will be transmitted directly to the ground, or recorded in one of two magnetic tape recorders on the satellite for transmission later.

A laser beam image recorder designed by RCA will probably be used to produce images at the ground station. It uses a helium-neon, continuous-wave gas laser beam, which is intensity-modulated by the video signal to form a modulated, rapidly scanning spot of light. The light beam produces

**Table 1. Approximate range of spectral bands**

Visible	0.39 - 0.78 microns
Solar Infrared	0.78 - 3.5 microns
Mid-infrared	3.5 - 14 microns
Far Infrared	14 microns - 0.1 cm
Microwave	0.1 cm - 10 cm

an image of the video input on a conventional photographic film. The laser was chosen because it can supply high energy in a small beam and thus produce high resolution images.

### Eyes that see in the dark

The return-beam vidicon can detect only reflected sunlight in the visible and solar infrared spectral regions. But the sun is not the only emitter of radiation. All features of the terrain emit or reflect electromagnetic energy at distinctive and specific wavelengths, and the radiation they emit tells as much about them as the radiation they reflect. In general, "as you go to longer wavelengths, you sense cooler and cooler objects," says Charles J. Robinove of the U.S. Resources Div., Geological Survey.

"For example," he notes, "the sun is so hot you can sense its emissions in the visible spectrum. You can sense a volcano in the 3-to-5-micron infrared band. And for normal earth surfaces, you

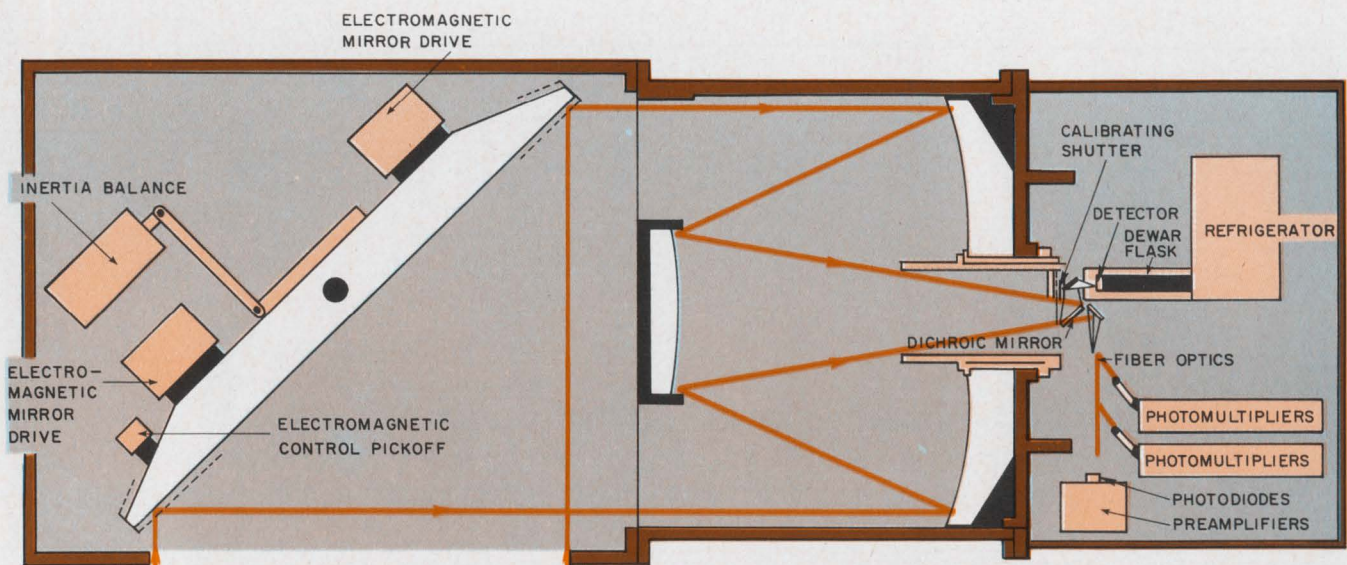

**Four-channel multispectral scanner**, designed by Hughes Aircraft Co., Los Angeles, and Santa Barbara Research

Center, Calif., makes images in the visible and infrared bands. Future models will be flown in a satellite.

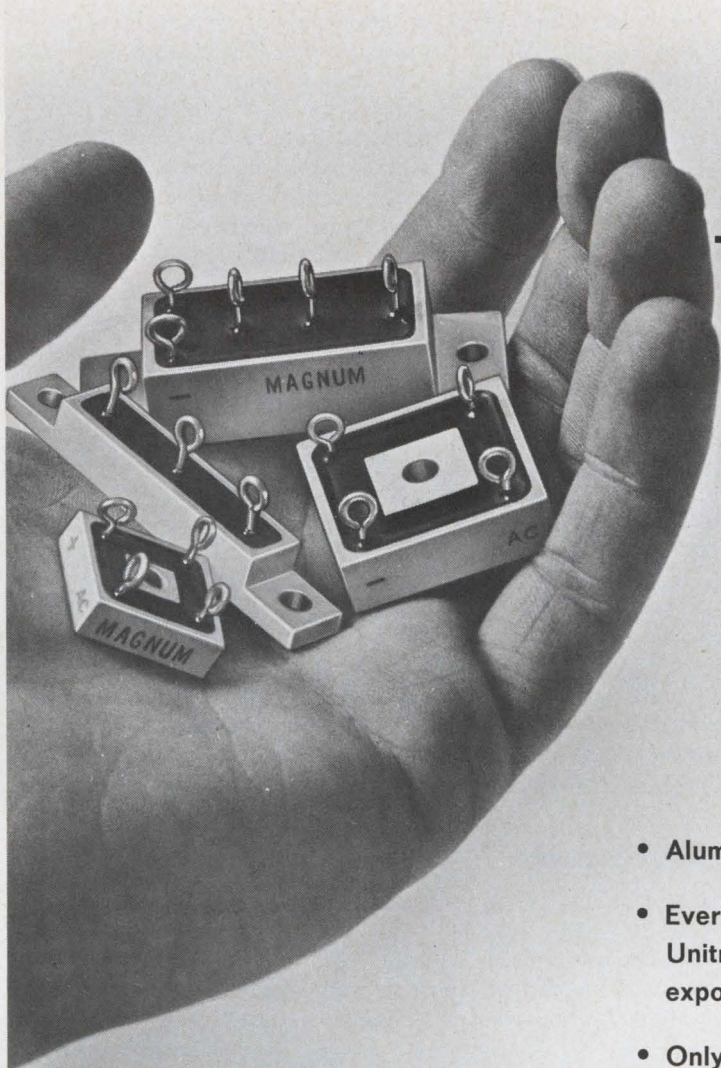

The "inside-out" bridge --  
the first 25 amp  
rectifier assemblies  
designed for reliability  
from the inside out...  
and priced competitively

- Aluminum package optimizes heat dissipation.
- Every chip individually fused in glass in a complete Unitrode monolithic package, so . . . silicon is not exposed to possible contamination by plastic filler.
- Only controlled avalanche rectifiers used.
- Terminal pins directly connected to silicon make direct thermal path — not only to case, but to lead wires — thus lower junction temperatures.

- #678 Series Three Phase 25 Amp Bridges
- #679 Series Single Phase 25 Amp Bridges
- #680 Series Single Phase 10 Amp Bridges
- #681 Series 15 Amp Doublers and Center Tap Rectifiers

PIV'S to 600V.  
4 different packages  
6 circuit configurations  
All available in regular,  
fast, or ultra-fast recovery

THE MAGNUM RECTIFIER ASSEMBLY by

**UNITRODE**

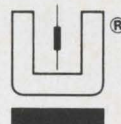

580 Pleasant Street, Watertown, Massachusetts 02172 • (617) 926-0404

IN ITS HEART, YOU KNOW IT'S RIGHT . . .

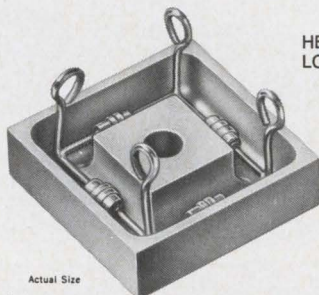

Actual Size

HERE'S WHAT IT  
LOOKS LIKE INSIDE

Even before it's potted, the Magnum has all the toughness, reliability, and electrical characteristics of the unique Unitrode fused-in-glass diode as the heart of its construction.

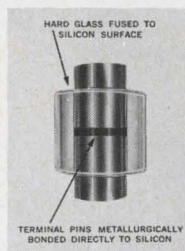

HERE'S WHAT IT  
LOOKS LIKE INSIDE  
THE INSIDE

With the silicon die metallurgically bonded between terminal pins of the same thermal coefficient, the hard glass sleeve is fused to the entire outer silicon surface. Result — a voidless, monolithic structure.

For fast action, call Dave Greene COLLECT at (617) 926-0404.

INFORMATION RETRIEVAL NUMBER 18

**(Remote sensor, continued)**

reach an energy peak in the 8-to-14-micron infrared."

But much of this emitted radiation cannot be detected from a satellite or aircraft because the atmosphere absorbs it. For example, our atmosphere absorbs most of the radiation in the 5.5-to-8-micron infrared region from about 14 microns out to 0.1 centimeter.

In the infrared region, the apparent emissivity does not vary greatly over the earth's surface. For land more than a few square feet in area, it averages about  $0.95 \pm 0.05$  in the 8-to-14-micron band. For water, the average is somewhat higher. Thus infrared radiation is primarily dependent on temperature. Because of this fact, it is useful for measuring temperature-dependent phenomena, such as:

- Incipient forest fires.
- Volcanoes.
- Upwellings of cool water from the ocean depths. These are important because they contain nutrients that attract fish. Thus it may be possible, using satellite infrared photos, to direct fishermen to bigger catches.

■ Certain water pollutants, particularly those from power plants—their effluents are warmer than the surrounding water.

Radiation in the microwave region of the spectrum is far less affected by the physical temperature of the emitting material. And emissivity at radio wavelengths varies greatly from one material to another. For example, for dry soil it is close to 1, whereas for water it is about 0.4. Therefore phenomena that affect emissivity can be detected by measuring microwave radiations (water content is one example).

Another interesting phenomenon is the fact that the wavelengths of energy emitted from an area of the earth also seems to depend on the depth as well as the nature of the emitting top covering layer. For example, infrared energy comes from close to the surface of a material, whereas microwave energy comes from deeper down.

**Picture-making point by point**

An infrared sensor measures the radiation or apparent temperature of the emitter. It must be calibrated to give a quantitative—immediately useful—reading. Otherwise

it measures only the differences in apparent temperature of differently emitting bodies.

A very high-resolution multispectral scanner instrument, which makes airborne pictures of the same scene in both infrared and visible wavelengths—in this case from an airplane—is shown on page 28. In this system, a mirror scans in one direction by rocking back and forth at right angles to the line of flight of the aircraft, while the motion of the aircraft provides scan along the line of flight. Light from the ground is reflected by the scanning mirror to a primary and a secondary mirror and finally to a dichroic, which reflects wavelengths longer than about 10 microns but passes those in the visible and solar infrared bands. The midrange-infrared detector measures the radiation emitted from the ground, while the visible and solar infrared detectors measure the intensity of the reflected sunlight. The mid-infrared detector must be cryogenically cooled, as shown in the figure. The instrument is calibrated during retrace time by first exposing the scan beam to space and then to two temperature-controlled hot plates. Comparing these with the appar-

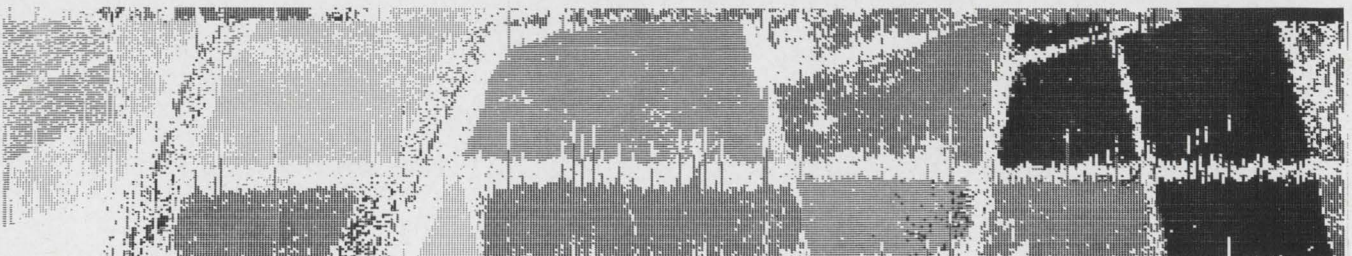
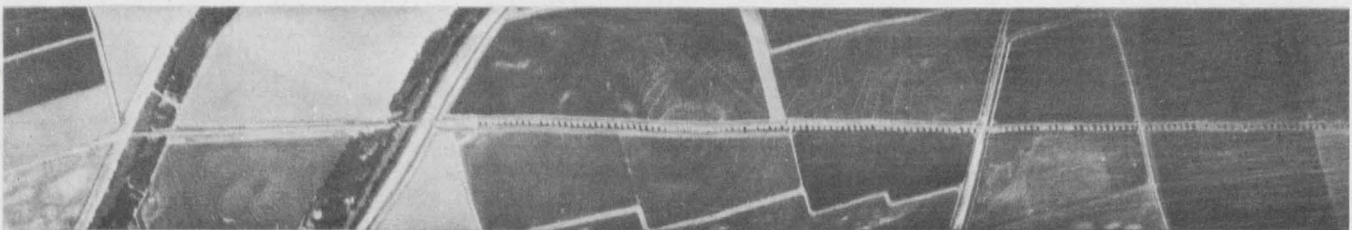

**Agricultural area in Davis, Calif.,** shown in two different spectral bands, was made with a multispectral scanner (top, 0.32 to 0.38  $\mu$ ; middle, 0.58 to 0.62  $\mu$ ). The lower strip shows a computer printout of the area which

distinguishes four different plantings by tonal differences. Fields of bare soil are lightest in tone; safflower fields are next; then, immature rice; and finally, mature rice which is darkest.



# Announcing the birth of Linear, our 3-year old baby.

**(and a free booklet on all the things he can do)**

In a way, linear has been the neglected child around our place for some time.

Of course, the line has been growing and getting healthier every day. We've just been a bit lax in getting it out into the world.

But now, Here It Is: mature, sophisticated and long-since out of diapers.

We have a wide line of linear devices ranging from core memory sense amplifiers to video amplifiers. They've been designed for both the circuit and the system designer.

Design flexibility is built into the line with operational amplifiers, differential amplifiers, high speed comparators, and RF/IF amplifiers, which can be used alone, or in conjunction to increase performance and design versatility.

Our new Linear booklet contains 49 linear circuit applications which illustrate some of the more subtle features that are built into the line.

The applications include: tuned circuit, AGC, sense, logarithmic, DC, summing and pulse amplifiers; local oscillators; modulators; hi-speed comparators; limiters; integrators; DC servos; Schmitt Triggers; line drivers; clock generators; voltage regulators; differentiators; line receivers; threshold and double-ended limit detectors. Buzz, buzz, buzz.

Signetics Linear Circuits are exhaustively tested to in-house and customer specs. In addition, all are subjected to the most stringent environmental testing through our "SURE" program.

All our linears are available through distributors in either 0°C to 70°C, or -55°C to +125°C operating temps.

And that's not the end. Like all precocious progeny, Linear is expected to produce some startling developments in the near future.

To keep up with this baby, you've got to have the book. Write to the proud parents: Signetics, 811 East Arques Ave., Sunnyvale, Calif. 94086.



SIGNETICS CORPORATION: A SUBSIDIARY OF CORNING GLASS WORKS

INFORMATION RETRIEVAL NUMBER 19

**(Remote sensor, continued)**

ent temperature of the emitting object gives a quantitative apparent-temperature measurement.

Unlike a frame-type camera, such as the return-beam vidicon, the multispectral scanner provides images that are in perfect registration because it scans every spot on the scene at the same time. Also, it provides simultaneous images not only in the visible and solar infrared but also in the mid-infrared, where energy is emitted rather than reflected.

For an example of multispectral imaging, see page 30. Such images can be processed in many ways. They can be studied separately. Or two or three of them can be combined into a black-and-white or color composite. Or then again, the signals from the various bands can be recorded on tape and analyzed by computer.

Probably the early earth-resources satellites will not include scanners that can sense in the mid-range infrared because they require cryogenic cooling. But NASA authorities indicate that a multispectral scanner that is sensitive to the visible and solar infrared regions will probably be included for study purposes.

**Radio 'pictures'**

Microwave sensors come in two forms—active (radar) and passive. Both techniques offer one great advantage over either optical or infrared instruments: They can penetrate clouds. On an average, any place on earth is cloud-covered 50 per cent of the time, and some places are cloud-covered almost all the time. Furthermore, some important phenomena are associated with clouds—floods, for example.

A radar imaging system that could make excellent pictures from satellite altitudes is very definitely within the state of the art. A synthetic-aperture radar with a very modest antenna could provide resolution comparable to that of the scheduled optical systems, says Mrs. Virginia Norwood, senior staff engineer in the Hughes Aircraft Space Systems Div., Los Angeles. But like any radar system it would be costly in power.

At satellite altitudes a conventional side-looking radar system would require too large an antenna to be practical, she says.

But in synthetic-aperture radar, the size of the individual resolution elements is reduced by effectively breaking the ground up into patches of the desired size and recording the phase history of each patch during the time the antenna beam is sweeping across it.

"By recording the phase history of a patch during several pulses," says Mrs. Norwood, "you make up for the fact that you aren't getting much energy from it during any one pulse."

**The look of a microwave**

Passive microwave imaging is still in its infancy. Much about these wavelengths still has to be learned—particularly on how to interpret such photos.

The airborne system measures apparent temperatures at microwave frequencies and translates them into colored images. It consists of a phased-array antenna, a radiometer, and a magnetic tape recorder plus a general-purpose computer and a three-gun color TV camera for imaging on the ground. The antenna electrically scans the earth at right angles to the plane's motion, like the scanning mirror in an optical system. It measures emitted earth energy at the tuned wavelength as a function of scan position, and records the output digitally on magnetic tape. This tape is then played through the computer to correct for the height and speed of the aircraft and for deviations in the antenna pattern. The corrected tape drives the TV camera, producing a color image in which each color represents a given band of apparent temperatures of the earth's surface scanned.

The resolution is coarse—1500 feet by 1500 feet from 30 to 40,000 feet. "However," says Alvin Edgerton, manager of the Geosciences Group, Space Div., Aerojet General, "this type of radiometer could be used in space for collecting regional information, such as broad-scale meteorological, glaciological and oceanographic data. For example, we could use it to get a quick inventory of all the snow-

covered areas in the word and to determine the rate of melting."

The time will come when thousands of sensed images will pour in every day—lakes and rivers, snow banks, forest lands and crops all over the entire world. Calculating the condition of each resource and keeping track of its seasonal changes will be a mighty task. To what extent can the computer help?

A computing machine can be trained to recognize the tonal signature of a particular material, and then to compare this signature with several sets of prerecorded signatures. The data may be in the form of spectrometer measurements or electronic signals from a multispectral scanner, previously recorded on magnetic tape.

Marvin Holter, of the Infrared and Optical Sensor Laboratories, Univ. of Michigan, Ann Arbor, and his associates, under contract to the U.S. Dept. of Agriculture, recently imaged an agricultural region in Davis, Calif., in 18 different bands, using a multispectral scanner. Two of the bands are shown on page 30. Also shown is a computer printout of the four different types of field, each represented by a different tonal density.

To identify the different crops, the computer first derived their tonal signatures by examining a small area of each crop type, point by point, in one image (or tape channel) after another. Once the computer had defined signatures for all the crops, it checked through the entire region—again, point by point, from one channel to the next—determined which signature matched each point, and printed out an image of the entire region. Thus the computer first derived signatures from a set of data and then used those signatures to analyze other data taken at the same time and under the same conditions. It was necessary to do this, Professor Holter points out, because the spectral signature of a crop may vary with the time of day, the season, and because of many other factors.

It is a simple step from printing out a map of the various crop types to summing the areas and presenting a count of the acreage. And this the computer does with ease. ■■

**If our 12MHz AM/FM/SSB  
IF strip with detection,  
limiting and AGC  
doesn't turn you on,  
maybe our 12MHz  
video amp will.**

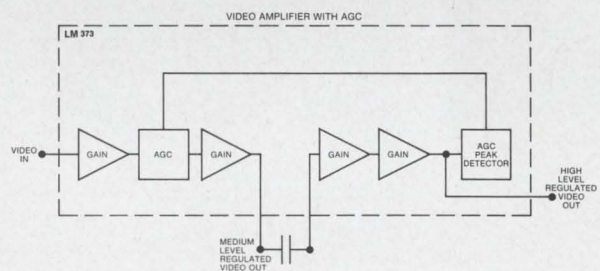
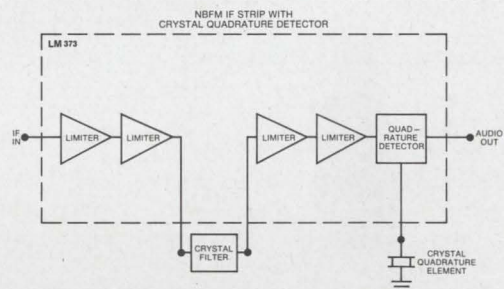
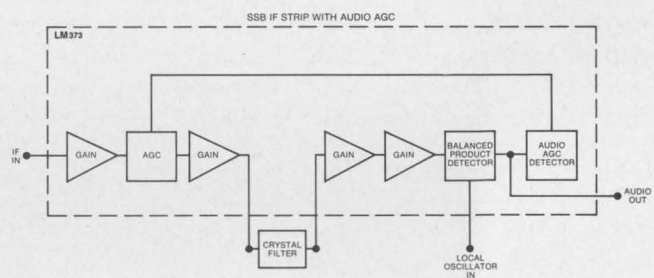
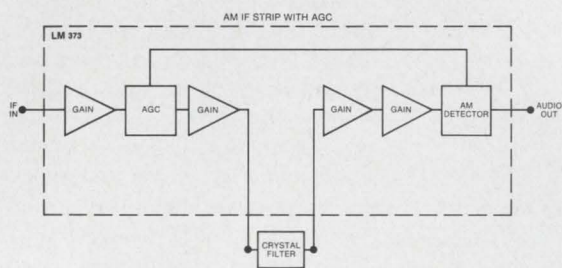

## It's all the same to us LM373

A fresh entry in a growing line of uncluttered monolithic communications subsystems. And still another you-can-get-it-here-only.

One device meets the diverse high performance requirements of mobile narrow-band FM, aircraft-band AM, and military SSB systems, with mode determined by connection of a few external components. Single conversion, using quartz crystal filters in the 9-12 MHz IF range, greatly simplifies conventional double-conversion VHF or UHF receivers.

The price is \$2.73 for the LM373, \$5.18 for the LM273 commercial/industrial types and \$13.12 for military additions. In hundred lots. Somewhat less for more.

For data sheet and application details, write or call National Semiconductor, 2975 San Ysidro Way, Santa Clara, California 95051. (408) 245-4320; TWX: 910-339-9240; Cables: NATSEMICON.

# National/Linear

# Just a step away from a landing on the moon

## LM vehicle, a success so far, to be tested above lunar surface prior to touchdown this summer

**Charles D. LaFond**, Chief  
Washington News Bureau

Man's weaknesses and his strengths once again were underscored when three astronauts who had been laid low by a cold went on to brilliantly carry out all of their team's mission goals.

In a little more than six hours, on their fifth day in orbit, two of the three separated the lunar module (LM) from the command and service module (CSM), flew it free into its own orbit, withdrew to a distance of 114 miles, then smoothly returned and gently re-docked. All major systems functioned perfectly.

The way is now clear for Apollo 10—a final test of the LM in lunar gravity.

Until the flight of Apollo 9, all of the complex systems required for landing men on the moon had been fully tested in space, but one—the lunar module's guidance

and navigation systems. On the previous flight—Apollo 8, which was its first time in space—the Grumman-built lunar lander was tested for structural integrity, for the efficiency of its propulsion systems and, to some extent, of its electronics systems—but, to now, the LM has never been flight-tested by man.

Although the Apollo 9 astronauts reported some problems with blinding sunlight, with the erratic quality of vhf communications and with interference from some form of "air-traffic-control" system (reported to be from a military air-operations network in Southeast Asia), McDivitt, Scott and Schweickart had only high praise for the LM's flight controls,

### Special test equipment required

For Apollo 9, the LM was provided with developmental, flight-test instrumentation that will not

be carried on future flights. This special equipment was installed to perform the following functions: detection, signal conditioning, and transmission of all major operational parameters.

In addition, the craft carried two extra C-band transponders to assist ground-radar tracking (receiving at 5765 MHz transmitting at 5690 MHz).

All data collected were telemetered to the Manned Spacecraft Center in Houston via five fm/vhf transmitters operating in the 228-to-260-MHz-range. All five channels were multiplexed to provide a single channel to ground-receiving stations. The multiplexer output was fed to a uhf/vhf diplexer that connected the signal with the digital command assembly, which operated at 450 MHz. Of the five transmitters only one was required for sending real-time data.

In future moon landings, four major systems must function to return the two astronauts to the mother ship. The environmental control system must provide atmospheric and temperature control for life-support. The basic electrical power system must function since it drives all systems. The propulsion system must work to lift the ascent vehicle from the lunar surface and carry it to the command module. And finally, the guidance and navigation system must function properly to assure successful rendezvous.

Although all of these systems had previously been checked out in space, except for the full test of the LM guidance and navigation system, Apollo 9 provided the first full-out test. The inertial measuring unit and guidance computer—sister equipment to that aboard the LM—is carried in the command module. Both are supplied by AC Electronics Div. of General Motors Corp. Supporting optical and radar systems are different and, until the flight, had been largely untried.

Three major guidance systems plus a backup were employed. The



Short "space walk" was taken by rookie astronaut Schweickart. The drawing is somewhat misleading as he did not stray from the LM platform during the walk.

# Three ways to improve on the performance, price and delivery of Op Amps like the 709C, 741C and MC 1439.

## LM301A/302/307

Our LM301A, 302 and 307 are more than interchangeable with the 709C, 741C and MC1439. They outperform them, are competitively priced and they are readily available. Ideal devices for long-interval integrators or timers, active filters, instrumentation amplifiers or in high impedance applications where noise is critical. All are completely specified for operation over 0° to 70°C temperature range.

LM301A—most versatile general purpose amplifier and comparator. Low input currents, low noise and guaranteed drift characteristics. 10V/ $\mu$ sec slew as a summing amplifier. (\$3.45 at 100 pieces)

LM302—fast voltage follower with super-low input currents. Fully compensated. (\$3.00 at 100 pieces)

LM307—internally compensated universal op amp. Same DC specs as LM301A. Direct plug-in replacement for 709-type op amps. (\$3.95 at 100 pieces)

Input for the asking. National Semiconductor Corporation/2975 San Ysidro Way, Santa Clara, California 95051/(408) 245-4320/TWX: 910-339-9240/Cables: NATSEMICON.

## National/Linear

(Apollo 9, continued)

first is carried in the instrument unit of the Saturn-V rocket, at the very top of the launch vehicle. Produced by IBM, the instrument unit includes a Bendix stable platform and a computer by Electronic Communications, Inc. From lift-

off onward, the system provides commands for steering; engine ignition, cutoff, and staging operations for the launch vehicle. It inserts the entire spacecraft, with the final S-IVB stage, into Earth orbit, opens the outer panels to permit the CSM to move forward, and exposes the lunar module for transposition.

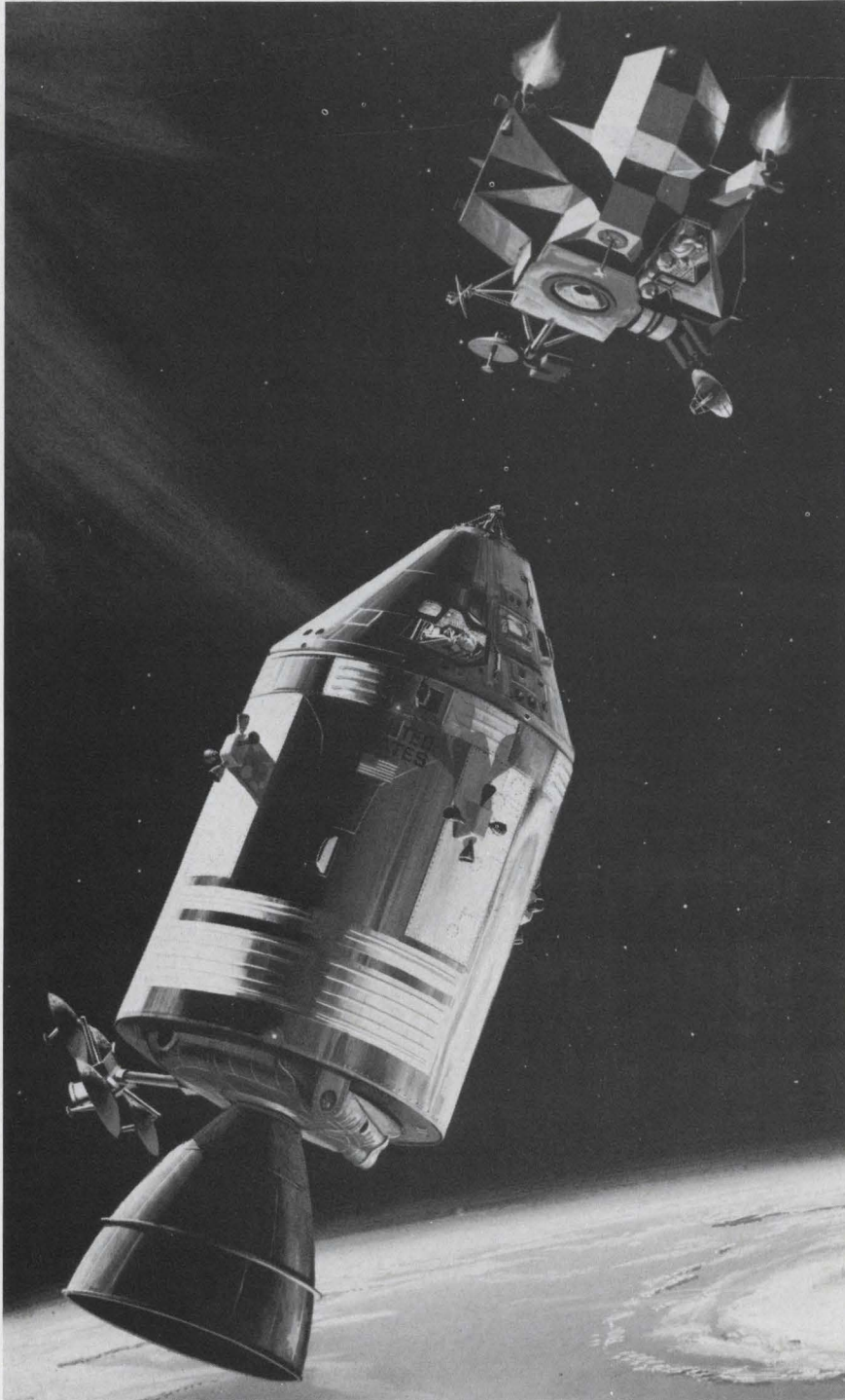

Astronauts Schweickart and McDivitt moved the lunar module over 100 miles away, dropped the descent stage, then rendezvoused with the command module using only the ascent stage. Artist's conception shows final docking approach.

The CSM moves forward, rotates 180°, then returns to dock with the lunar module. At this time, the now-mated moon craft, through a spring-loaded connection, is gently ejected outward from the third-stage assembly. The Saturn guidance system then commands a final firing of the S-IVB, which moves it safely away from the linked spacecraft and sends it on out into permanent solar orbit.

During transposition, the CSM's own guidance system provides stabilization but, because distance between the two craft is so short, most of the rendezvous and docking operations are manual. In the Apollo 9 flight, as will be required for the lunar-landing mission, one astronaut then cleared the passageway connecting the two craft, and two crewmen crawled into the cabin of the lunar module.

After occupying the cabin, all systems were energized, checked out, and the guidance and navigation systems aligned and updated, using inputs from the CSM and from the ground-command link.

The LM and CSM basic guidance systems are nearly identical. The inertial platforms and associated electronics are built by AC Electronics, and the computers are built by Raytheon. The optics in the CSM are more extensive, since they provide a principal method for updating the module's celestial position. The LM employs a very simple telescope for minimal backup.

Each guidance system has its own computer program. For the CSM it is called Colossus, for the LM, Sundance. Each is a basic program designed for the functions and operating characteristics of the two vehicles. Developed by the Instrumentation Laboratory of MIT, each program is modified and assigned a specific number to correspond to a particular mission need.

For most of the flight the CSM guidance is in control. The LM guidance comes into use when the two vehicles are separated. It controls the descent to the moon and the subsequent ascent and rendezvous.

The lunar module is provided with a backup system, called the abort-guidance system, to assure a safe return to the CSM should the

# Beneath this calm exterior lurks... Supertetrode!

Eimac's sensational new water cooled 50 and 100 kW tetrodes are the world's finest for high power applications. They're ideal for transmitters in HF, FM and broadcast bands, for over-the-horizon radar, distributed amplifiers, high energy physics and high power voltage regulation.

Both tetrodes feature transconductance double anything even we've been able to offer. They have greatly reduced cathode lead inductance and a unique re-entrant anode, permitting a shorter stem and lower input capacitance. Feedback capacitance also is much lower, simplifying tube neutralization and eliminating

any need for a neutralization circuit. In both tubes the screen base is designed to serve as an electrostatic shield.

These tubes have 4 to 5 dB higher gain than comparable tetrodes, yet are very compact. The 4CW50,000E (50 kW model) weighs only 35 pounds. It has 310 pF input capacitance, 52 pF  $C_{out}$  and 0.06 pF feedback capacitance. The 4CW100,000E weighs 50 pounds, has 349 pF  $C_{in}$ , 60 pF  $C_{out}$  and 0.8 pF  $C_f$ . For data and application assistance contact your nearest Varian/Eimac distributor or ask Information Operator for Varian Electron Tube and Device Group.



(Apollo 9, continued)

primary guidance system fail. Designed and built by TRW, Inc., it functions continuously on an open-loop basis in parallel with the primary guidance system, and was fully tested during the Apollo 9.

The abort-guidance system employs a simplified electronics and computer assembly, a strapped-down inertial guidance subsystem, and a data entry and display subsystem. The strapped-down inertial measuring unit, supplied under a subcontract by Hamilton Standard Div. of United Aircraft, is the heart of this programmed semiautomatic system. It gives the astronauts the information they need to manually guide the LM to rendezvous. Since so much depends on this backup system, its reliability was a major design constraint. In qualifications tests it demonstrated a meantime-between-failure rate of 4000 hours, Hamilton Standard says.

The sensor unit weighs just under 21 lb and consists of three gyroscopes and three accelerometers that are fixed to the LM structure. It employs no gimbals that are external to any of the inertial elements.

Apollo 9 permitted a comprehen-

sive test of all elements except the landing radar, although that was exercised, too. The rendezvous radar has an effective range of over 400 miles. The principal system is a continuous-wave tracking radar operating at X-band (transmitting at 9832.8 MHz, receiving at 9792.0 MHz). It is carried in the LM, and a cooperative transponder is installed in the CSM.

The radar permits continuous determination of slant range and range rate. From these data, angle and angle rate with respect to the CSM can be determined.

#### Radar used on Surveyor

The landing radar, built for RCA by Ryan Aeronautical Co., is a radar altimeter and Doppler velocity sensor. Its design is based on a similar system flown in the unmanned Surveyor series.

The transmitters are the same as that used in the rendezvous radar. A rectangular antenna array is employed, with the transmitter portion in the center and receiving arrays on either side. Four continuous-wave beams are produced: one for altitude determination and three for Doppler velocity measurements.

The primary communications in all Apollo flights is the Unified S-band link, tested so successfully in

Apollo 8. However, in Earth orbit—because of the relatively low altitude—the primary link to ground is through vhf. The prime link between spacecraft is also vhf, at either 259.7 or 296.8 MHz.

RCA produces the LM transceiver and Collins Radio produces the one aboard the CM. Both vhf systems are solid state and both vehicles carry redundant transceivers. All four systems operate at 30 watts and have a 550 mile range. Ten-watt cw transmitters are used.

For Apollo 10, now scheduled for May 18, a design modification in the vhf transceivers will be made, to permit backup range determination between the two vehicles.

In the Apollo 9 mission, Astronaut Schweickart, by stepping out of the spacecraft, also tested a portable, battery-powered life-support system. Developed by Hamilton Standard, the 60-lb backpack provides oxygen, temperature control and vhf communications.

In the recent test flight, the radio subsystem, which includes two-way voice (duplex) and seven telemetry channels, was built by Hamilton Standard. The radio subsystem, which will be used on the moon, is being built by RCA.

#### Lunar TV passes first test

The TV camera employed for the first time in Apollo 9 is the system specifically developed for use by astronauts on the lunar surface. Developed by Westinghouse Electric Corp., the camera is cable-connected to the spacecraft and required no controls. When the cable is connected the unit is energized continuously.

Stanley Lebar, lunar camera program manager at Westinghouse, says the camera will function properly in total vacuum over a temperature range of from +250° to -300° F. A key element of the 7.25-lb camera is a secondary electron conduction tube that permits transmission of relatively high-quality video, in light variations down to, and including, the light levels pertaining during lunar night. Primary scanning rate is 10 frames per second with 320 scan lines. A secondary mode produces 0.625 frames per second for detailed scientific observation ■■

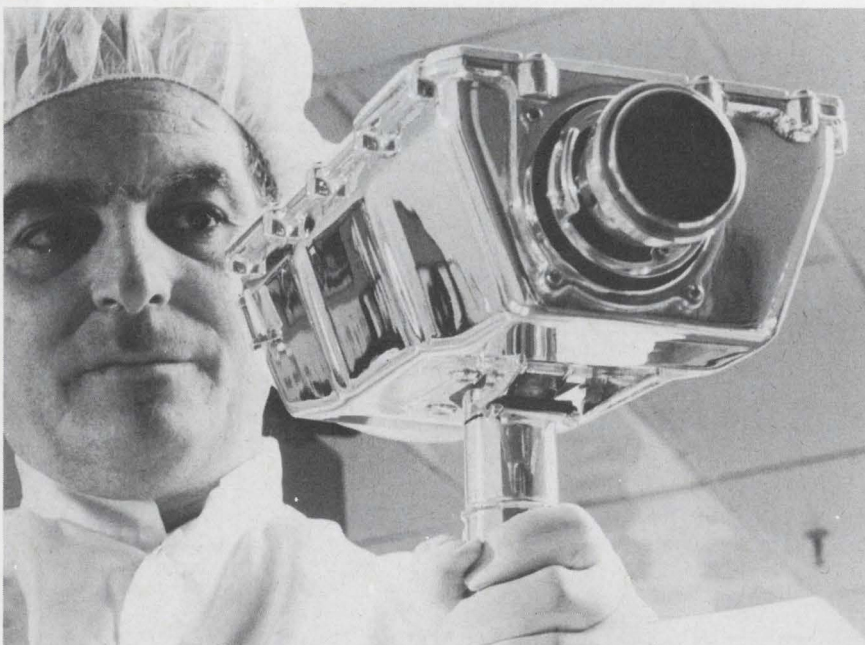

Westinghouse 7-1/4-pound moon camera passed its first flight test in Apollo 9. It uses a SEC tube for adaptability to changing light conditions.



# Hold off on that video amplifier you've been working on.

## FILM MEMORY SENSE AMPLIFIER

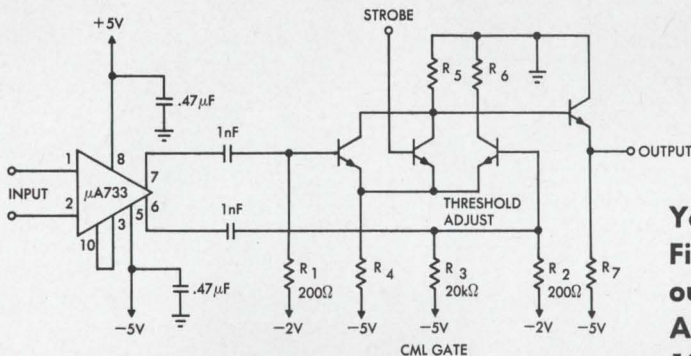

Delay Time: 12ns  
Overdrive  
Recovery Time: 45ns

is  $2^\circ$  at 5MHz and pulse response time is typically 5ns. And noise is a low  $25\mu\text{V rms}$  for a bandwidth of 50MHz because every transistor in the amplifier is made with our special low-noise processing and has an  $f_T$  of 1.2GHz.

The  $\mu\text{A733}$  is another of our Second Generation Linears, and the price/performance ratio shows it. Use the  $\mu\text{A733}$  in any application that calls for wide bandwidth,

You might not have to build it after all. First check out the Fairchild  $\mu\text{A733}$ , our latest wideband Differential Video Amplifier. The 3dB bandwidth is 120MHz at a closed-loop gain of 10 (90MHz at a gain of 100). Input impedance is  $25k\Omega$ , phase linearity

low phase shift and good gain stability at a low price. Here's how:

Write for more specs and detailed application notes. Or just pick up as many devices as you need from your stocking Fairchild distributor.

To order the  $\mu\text{A733}$ , ask for:

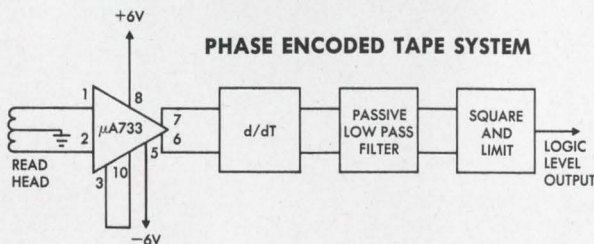

Phase Linearity:  $\pm 2^\circ$  from 2 to 5 MHz  
Input Resistance:  $25k\Omega$   
Input Capacity: 2pF  
Fixed Gain: 100

PART NUMBER	PACKAGE	TEMPERATURE RANGE	PRICES		
			1-24	25-99	100-999
U5F7733312	TO-5	$-55^\circ\text{C}$ to $+125^\circ\text{C}$	\$20.00	\$16.00	\$13.20
U5F7733393	TO-5	$0^\circ\text{C}$ to $+70^\circ\text{C}$	10.00	8.00	6.60

**FAIRCHILD**  
SEMICONDUCTOR



# We make components for guys who can't stand failures.

You can't court-martial a capacitor or a resistor for refusing to carry out orders. But at Corning we make our capacitors and resistors for guys who are demanding enough to wish that they could.

We make components that give you an extra measure of performance. Components that let you make sure your system will deliver all you designed into it. Because like you and the guys who use your equipment, we can't stand failures either.

Take our glass capacitors, for instance. There's only one reason why they've been designed into the Surveyor, Minuteman, Gemini, Apollo, Saturn, Titan, Syncom, Sparrow, Hawk and a number of other major aerospace and missile projects. With our glass capacitors, their circuit designers could get the proven stability and reliability that these important systems demanded.

U.S. Air Force tests have established that our glass capacitors deliver much better stability and much higher insulation resistance than ceramic and mica capacitors.

And take our precision tin

oxide resistors. They're the best of the metal film class. Because the resistive tin film is completely oxidized and molecularly bonded to the glass substrate, our tin oxide resistors are impervious to moisture and environmental degradation. No other resistor can deliver the same stability and reliability over load life. They offer guaranteed moisture resistance across all ohmic values to set a standard of reliability that can't be matched by metal film, wire wounds, carbon comps or metal glaze resistors. After a 56-day-long heat test in an environment of extremely high humidity, our tin oxide resistors showed a resistance change of just 0.2 per cent. And in an ambient temperature test—now in its ninth year—not one of the 600 tin oxide resistors being tested has exceeded a resistance change of 1.5 per cent.

But don't only think of Corning for military and other precision applications. We've got something to offer when economy and value are the prime considerations. At Corning we've been active in improving these important capacitor

and resistor characteristics, too.

We've developed the Glass-K™ capacitor to give you the volumetric efficiency and economy of monolithic ceramic capacitors, but with the much improved stability and reliability that a glass dielectric can add.

In resistors, our tin oxide resistors already offer long-term economy over metal film, metal glaze and precision wire wound resistors. And our new C3 resistors, in addition to giving you a small case size, compete costwise with carbon comps.

At Corning we make components for guys who can't stand failures. Guys like your most important customers. Guys like you. So, next time you're designing a system, reach for your CORNING® capacitor and resistor catalogs and call your local Corning authorized distributor for off-the-shelf delivery. They'll help you design-in that extra measure of performance.

If you don't have our catalogs, ask your Corning distributor for copies or drop us a line at: Corning Glass Works, Electronic Products Division, Corning, New York 14830.

**CORNING**  
ELECTRONICS

## Electronics helps monitor swimming pool

A new system that acts as a highly sensitive and selective electronic ear can recognize accidental falls of dogs or children into swimming pools, as well as underwater thrashing sounds, such as those made by a drowning swimmer. Larry Lohr, president of Sonar-Scope, Inc., of Los Angeles, believes it to be the first practical swimming-pool alarm system.

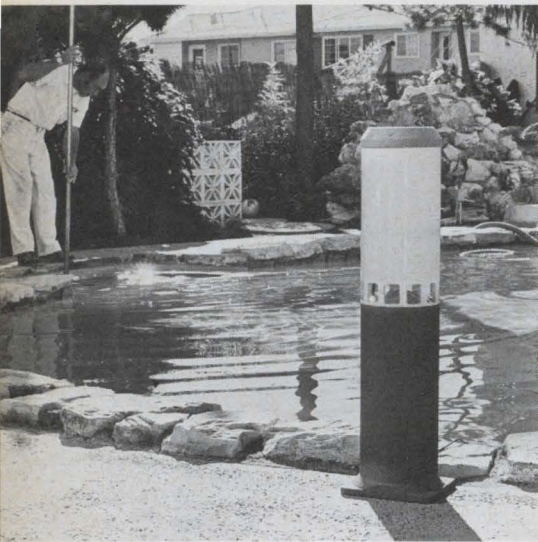

The system is comprised of an underwater microphone that was originally developed for the Yack-Yack scuba diver communication system developed by Y-Squared Associates of Santa Ana, Calif.; a pattern-recognition system, and electronics housed in an aluminum pool-side container. The key feature of the system is the pattern recognition unit.

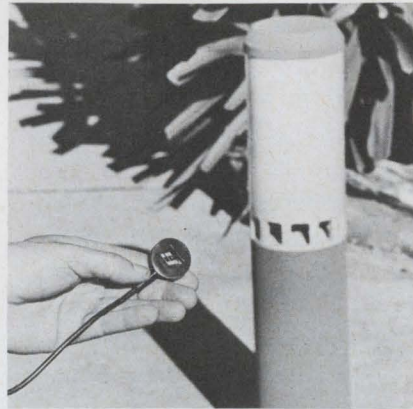

At left, PoolGuard alarm unit picks up sounds of drowning swimmers with underwater microphone; above, microphone was originally developed for diver communications.

Previous types of sonic swimming-pool alarms have been based on sensing frequencies present in the disturbances. They have not been too successful because of false alarms triggered by loud ambient noises, or even by heat changes in the structure of the pool.

According to Dr. Yujiro Yamamoto, president of Y-Squared Associates and designer of the new system, development of the pattern-recognition system was based on the fact that frequency content of typical signals of concern varies with object size. However, investigation showed that the rise- and fall-times of all of the wavetrains are substantially common.

As a result, recognition is obtained by sampling the rise-time and fall-time of incoming sounds and comparing them with reference waveforms triggered by the input signals. If the initial rise-time is not within compared limits, the sampling ceases and no alarm is given. However, should the rise-time agree with the standard, the sampling is continued and fall-times are compared. Agreement here produces an alarm. ■■

## Nerve gas alarm developed for Army

The Army's defense against lethal, invisible, odorless nerve gas is being strengthened significantly by development of a new, portable chemical-alarm system to be carried by soldiers in the field.

A sensitive, 14-pound backpack unit triggers an alarm on detection of nerve gas vapors in less than lethal concentrations.

The M8 alarm system is slated to become a standard field item for United States forces this year.

An electrochemical cell in the unit undergoes "spontaneous electrolysis" and energizes the alarm when gas is detected. The system is powered by 20 standard flashlight

cells and can be operated for 12 hours or more.

The complete system has six components: a detector unit, a remote alarm, a power source, detector-refill kit, field-test kit and vehicle-mounting kit.

The Army has had effective detection devices before but these lacked automatic alarm capabilities suitable for use by field troops.

The system was developed at the Warning and Detection Laboratory, Edgewood Arsenal, Md. The Bendix Corp., Towson, Md. and Southern Research Institute, Birmingham, Ala., are prime contractors. ■■



M8 chemical alarm system can detect minute amounts of nerve gas.

Hundreds of Different  
Advanced-Design Modules

# Power Supplies Now In Stock!

**Pre-Tested! Ready to ship!**



Jack Pumroy, Sales Manager  
Technipower, Inc.  
20 Benrus Center  
Ridgefield, Connecticut 06877

Telephone: 203-438-0333

Please send me your new list of the many hundreds of different power-supply modules now available, in depth from stock.



Also tell me about your exclusive Orange Seal dynamic thermal stress testing. I understand it significantly reduces "Infant Mortality."

NAME & TITLE \_\_\_\_\_

COMPANY \_\_\_\_\_

STREET & NUMBER \_\_\_\_\_

CITY, STATE, ZIP \_\_\_\_\_

PHONE \_\_\_\_\_

PRODUCT OR APPLICATION \_\_\_\_\_

I DO \_\_\_\_\_ DO NOT \_\_\_\_\_ HAVE TECHNIPOWER'S 64 PAGE CATALOG.

For fast action — clip coupon.  
For leisurely response — use bingo card.

**TECHNIPOWER**



**POWER SUPPLIES**

**"We Have Something Better Up Our Sleeve"**

A BENRUS SUBSIDIARY

# Ten-trillion-watt laser developed by Sandia

Sandia Laboratories scientists have developed a pulsed laser that at peak power generates up to 10 terawatts (trillion watts). Each burst lasts only 3 to 10 ps but is so intense that it reportedly has heated metal to 20 million degrees Fahrenheit.

The Sandia laser output, which will be used in materials research, surpasses that reported for a similar Soviet device—said to have discharged 20 joules of energy in 10 ps, the equivalent of two trillion watts.

"We have already surpassed this output," says Dr. Garth Gobell, manager of Sandia's Radiation Effects in Solids Dept., Albuquerque, N.M. "To my knowledge this represents the highest power yet generated by a pulsed laser."

The device is really a modified version of a two-billion-watt laser manufactured to Sandia specifications by the American Optical Co., Southbridge, Mass. It incorporates four neodymium-doped glass rods—a small oscillator rod and three amplifier rods, ranging from 21 to 42 inches in length and from one-half to one and one-half inches in diameter.

The laser reportedly can be operated as an optical amplifier in

three ranges:

- A long pulse mode of millisecond duration, with random spiking and total energy to 800 joules.

- A giant pulse mode of 35 nanoseconds duration, with energy up to 200 joules.

- A high-power mode of 3 to 10 picoseconds duration with energy of 50 joules.

Like the oscillator, the glass of the amplifier rods contain dispersed atoms of neodymium. Before they receive a pulse from the oscillator, these atoms are pumped up to a high-energy state by a xenon flash lamp. When struck by laser light, they release their extra energy in the form of photons.

The oscillator rod generates a train of ultrashort light pulses, one of which is selected and amplified by the three amplifier rods.

As the pulse travels the length of each amplifier, it gathers additional energy by picking up new photons from the lasing neodymium atoms. By the time the pulse exits from the final amplifier, its energy may be 2500 times greater than it was originally. At its exit from the oscillator, the pulse has energy of about 0.05 joule. This is increased to 0.25 joule by the first amplifier; to 10 joules by the sec-

ond amplifier, and to 50 joules by the third amplifier.

A lens ground from laser glass, is used to focus the beam to a point about 0.03 millimeter in diameter at the target surface.

Sandia researchers say they plan to use the laser for three basic types of experiments:

- To investigate ways of producing nuclear fusion by subjecting samples of deuterium (heavy hydrogen) to intense heat.

- To study the reaction of materials when exposed to heat energies that are capable of vaporizing the hardest metal.

- To produce a variable range of shock waves—and to study the effects of those waves on various materials.

The measurement of picosecond pulses—undetectable by oscilloscopes—was achieved by using a two-photon fluorescence system.

The laser pulse is split into two parts by a mirror system and re-joined in a container of dye. The region where the pulses overlap fluoresces as a bright line and is recorded on film. The pulse length is then calculated by measuring the width of the line and including a factor which corrects for the velocity of light in the dye. ■■

## Ion engines may keep satellites on station

To minimize power consumption during data transmission, a satellite in synchronous—or "fixed" orbit—must not be permitted to drift relative to a fixed point on earth. When the satellite "drifts" it loses alignment with pointed ground-receiving antennas and transmission-power requirements increase considerably.

To keep the satellite in position, tiny cold-gas jets aboard the spacecraft are fired to compensate for the drift.

Recently, two ten-pound cesium contact ion microthrusters on the

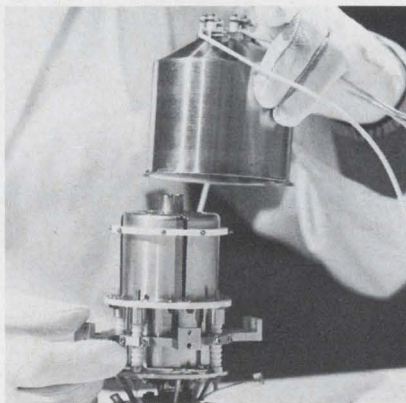

Thruster subsystem of electric ion engine is given final adjustment.

orbiting Applications Technology Satellite-D were tested in orbit for the first time.

Built by Electro-Optical Systems, Pasadena, Calif., the ion microthrusters are capable of zero-to-20-micropound thrust levels in four-micropound increments.

The ion engine requires only 30 watts of input and has a potential lifetime of more than a year under constant maximum thrust, according to the company. It is seen as an eventual replacement for the cold-gas jet systems now in use on synchronous satellites. ■■



Look to the future. Plug-In Oscillators for use above 1 GHz and with multi-octave coverage coming soon.

## From Alfred Electronics a new 10 MHz to 1 GHz Solid State Sweeper.

It's the nicest thing that ever happened to your swept and single frequency measurements.

**Front plug-in sweeper—maximum flexibility.** The new Model 6151 Sweep Oscillator with Oscillator Plug-In Units gives you swept and stable single frequency coverage from 10 MHz to 1 GHz. Here is a sweeper with two independent sweeps, three single frequency outputs which also include the Accentuated Comb Marker.

**Compare output power—100 mw or 2.24 volts.** The 100 mw (2.24 volt rms) into 50  $\Omega$  leveled output

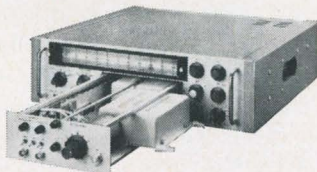

Model 6151 shown with plug-in drawer capable of holding all dc to 1 Gc oscillators.

allows this sweeper to be used in place of signal generator amplifier combinations.

**Sawtooth or triangular.** Sawtooth sweep with fast flyback. Triangular sweep provides forward and return sweeps of equal duration for hysteresis and memory measurements.

**Complete independence of controls.** The exclusive Alfred slide rule dial includes  $F_1$  start and  $F_2$  stop,  $F_0$  and  $\Delta F$  controls.  $F_1$  and  $F_2$  controls pass each other for up or down sweep.  $\Delta F$  sweeps around the  $F_0$  frequency and is accurately calibrated in frequency.

**Unique  $F_0$  control.** Serves as frequency marker, the center of the symmetrical sweep, and as a single frequency.

**Choice of three preset single frequencies.** A single frequency output may be set with the  $F_1$ ,  $F_2$  and  $F_0$  controls for precise component evaluation.

**Choice of leveling.** Internal or external leveling.

**Modulation for every application.** Internal 1 KHz squarewave for reflectometer and SWR measurements and 1 KHz sine wave for amplifier response testing. Model 6151 also may be externally amplitude and frequency modulated.

**Accentuated Comb Markers.** The optional Accentuated Comb Markers use crystals to generate precise and stable 1, 5 and 25

MHz signals for frequency identification during swept operation. Amplitude of the 1 MHz and 5 MHz is respectively 1/3 and 2/3 of the 25 MHz marker.

### Prices

1. Basic Oscillator	6151	\$1290
2. Plug-In Drawer		
10 MHz - 1000 MHz	6151-1	\$140
with Attenuators, DC - 1 GHz, 0-50 dB in 1 dB steps	Option A1	250
with Marker, Comb, 1, 5, 25 MHz	Option M1	375
3. Oscillator Modules		
10 to 20 MHz	Q01	\$200
20 to 50 MHz	Q02	200
50 to 125 MHz	Q03	200
125 to 250 MHz	Q21	250
250 to 500 MHz	Q22	250
500 to 1000 MHz	Q23	900

### For a Demonstration and Complete Information

Please call your local full service Alfred Sales Engineer (listed in EEM) or write Alfred Electronics, 3176 Porter Drive, Palo Alto, California 94304. Phone: 415-326-6496. TWX: 910-373-1765.

**ALFRED ELECTRONICS**

# TWO GREAT CONDUCTIVE PLASTIC PRECISION POTENTIOMETERS FROM BOURNS

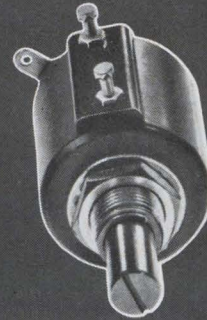
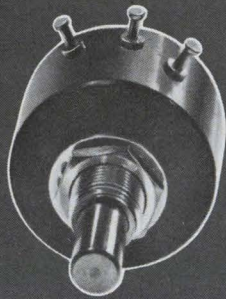

MODEL  
**3438**  
SINGLE TURN  
**\$800\***

MODEL  
**3501**  
TEN TURN  
**\$1375\***

Units Shown  
Actual Size

## BOTH AVAILABLE FROM DISTRIBUTORS FOR IMMEDIATE DELIVERY

These standard models offer outstanding specifications . . . lowest priced conductive plastic . . . immediate delivery.

The 3438 and 3501 Conductive Plastic potentiometers are another indication of the depth of the Bourns line. Other models, non-linear and linear and with or without load compensation, available to your specific requirements including Mil-R-39023. If your needs call for a single-turn or a ten-turn . . . Bourns has the solution! Before you specify or buy just any conductive plastic units, take a good look at the 3438 and 3501.

Get all the data you need for a sound decision. Write today for the latest catalog sheets or call your local Bourns office, representative, or stocking distributor.

SPECIFICATIONS	Model 3438	Model 3501
Resistance Range	100Ω to 1 Meg	1K to 1 Meg
Resistance Tolerance	±20%	±10%
Linearity (Independent)	±1.0%	±0.5%
Power	1 Watt at 40°C	2 watts at 70°C
Temperature Range	-15 to +105°C	-55 to +105°C
Rotational Life	20,000,000 shaft revolutions	50,000,000 shaft revolutions
Vibration	10G	20G
Shock	15G	100G



\*Price for 1-9 pcs.

BOURNS, INC., TRIMPOT DIVISION • 1200 COLUMBIA AVE., RIVERSIDE, CALIF.  
TELEPHONE (714) 684-1700 • TWX: 910 332-1252 • CABLE: BOURNSINC.

TRIMPOT® and Precision Potentiometers - Miniature Relays - Electronic Modules - Microcomponents.



Army seeks new "sniperscopes"



## Army's night-vision needs described

State-of-the-art advances are needed in tactical night-vision instrumentation, says a U. S. Army research specialist. He specifically called for such advances in the technologies of semiconductors and optically pumped lasers.

Speaking before a seminar on laser uses at the recent annual Spring Conference of the Electronic Industries Association here, Stanley M. Segal, of the Army Electronics Command, stressed the need for laser developments that will improve the performance of image-intensifier viewing devices.

A director in the Night Vision Laboratory at Fort Belvoir, Va., Segal noted that injection lasers, as presently used, employ light-emitting diodes, mostly gallium arsenides that are pulsed at repetition rates of from 5 to 5000 pulses per second. Pulse widths, he said, are of the order of 1 microsecond, with average power outputs from 0.3 milliwatt to 30 milliwatts. Operating frequencies, in the 1970-1980 period, will range from 8000 to 12,000 Angstroms.

But, Segal says, present efficiencies are very low—approximately one per cent. For low-power systems, improvements are needed to raise this to 10 per cent; for high-power systems to 15 per cent. Existing high-power systems must be reduced down from the currently typical size and weight (3 cubic feet and 150 lb), to units one fiftieth the size, at costs that are one twentieth of those now. Gains probably will be made, Segal suggests, by using new crystals of gallium aluminum arsenide that require less cooling and that offer

# Washington Report

CHARLES D. LAFOND  
WASHINGTON BUREAU

an opportunity for fabricating "multi-thousand diode arrays."

Systems using Q-switched, optically pumped lasers are even less efficient than semiconductor types but are required for different applications, Segal says. Those now in use operate with average 1 to 30 watts of output power and with pulse rates of from 10 to 100, but peak powers per pulse are in the order of megawatts. Operating range is from 9000 to 10,600 Angstroms. Efficiencies should be raised from the present 0.7 per cent to 5 per cent; weight should be cut by 85 per cent and cost should be reduced by 98 per cent. Principal gains, Segal predicts, probably will come through the replacement of solid laser rods by fluid materials.

## NASA asks relay-satellite study funds

Making his annual appearance before the House Committee on Science and Astronautics—during its budget hearings—Gerald M. Truszynski again asked that studies be continued on a Data Relay Satellite System. Truszynski, NASA's associate administrator for tracking and data acquisition, said that the reason the space agency's global communications and tracking network was able to perform its functions was because of the work done on early planning of future systems. His point: NASA sees an urgent need arising for data relay by satellite by the mid-to-late 1970s.

The system under study for more than a year would employ a series of special-purpose, active communications satellites that would be located in synchronous orbit to acquire and relay data—possibly even voice communications

# Washington Report

CONTINUED

—between low-altitude, Earth-orbiting spacecraft and ground-receiving stations.

“Our studies to date,” Truszynski declared, “have proven that such a system is technically feasible, and could significantly improve the present tracking and data acquisition support capability.” He claimed further that the system would improve existing network services and that it could serve to reduce annual operating cost of the network. These lower costs might be achieved, he said, by reducing the number of instrumented aircraft, range ships, and even of some ground stations that are employed on a special-purpose basis.

The studies contemplated for the system in fiscal 1970, the NASA official told the committee, would define the role of the system in all future NASA space programs and would develop plans for implementing the system. A tentative operational target date should be sometime in the mid-1970s, in time to support the manned space station that is planned to be aloft by then.

## Proposed Navy missile plans revealed

The first details of the Navy's new Advanced Surface Missile System (ASMS) have been revealed. A proposal by RCA, one of three teams now engaged in ASMS contract definition, reportedly calls for a single-stage, supersonic and radar-controlled anti-aircraft missile designed to replace Navy Terriers and Tartars. Other studies are being performed by teams led by Boeing and General Dynamics. The RCA team includes Bendix and Raytheon.

The RCA design is for a sleek-looking pointed weapon that employs fixed fins from the center portion rearward, and four small and movable fins near the warhead for aerodynamic purposes.

Control would be by semiactive radar—that is, the target would first be acquired by a shipboard radar, and the missile would then be guided home by its own directed-reflected radiation. Under the contractor-team arrangement, Raytheon would produce the microwave target illuminator and other flight electronics. RCA, as prime contractor, would build the shipboard phased-array radar used for target acquisition and for initial fire-control inputs to the missile.

All of the high-resolution guidance electronics would be carried in the missile nose cone. Each of the movable forward fins would have a leading-edge radar antenna. Bendix would design and produce the missile and its support equipment.

## Radar automation award to Univac

The Federal Aviation Administration has awarded Sperry Rand's Federal Systems Div. a \$35.4-million contract to produce and install all necessary equipment for automating airport radar-tracking systems at 64 facilities in the U. S. Called ARTS III, this system is a follow-on to an earlier, less automatic system in test use at the Atlanta airport since 1964, and at Jacksonville, Fla., and New York City.

Two of the alphanumeric systems will be used to train FAA controllers. The other 62 systems will be installed at the busiest airports in the country. ARTS-III is employed to display the following information automatically, on tracking radar screens: continuous information on the altitude, the heading and the identity of specific aircraft within a given air-traffic-control area. Such data now are introduced to displays manually. Univac, as prime contractor, will provide the necessary equipment, as well as all supportive operational and non-operational software programs.

The entire installation is expected to be completed by mid-1973. The system will work in conjunction with automatic digital-data transponders carried in commercial and military aircraft.

# These RCA Triacs will turn you on

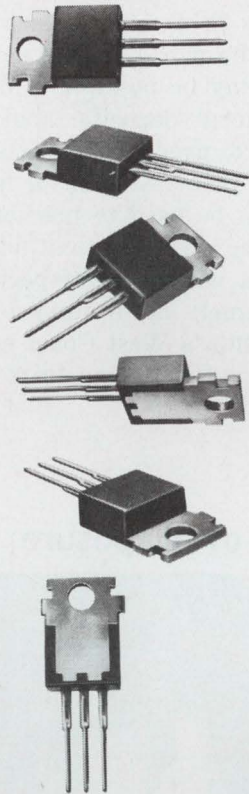

## Choose New RCA 8 Amp Triacs for On-Off or Variable Phase Control of Power Into Resistive or Inductive Loads

Now's the time to think in terms of more than electro-mechanical controls and turn on with Triacs! Not just any triac—but the new RCA-40668 and RCA-40669. Both feature the unique RCA hermetic chip in the popular, easy-to-mount RCA "plastic TO-66" package... and at prices that are just as popular.

Use the RCA-40668 for 120 V per 1-kW capability, the RCA-40669 for 240 V per 2 kW. With either, look what you get:

- Commutating  $dv/dt$  capability of 10 V per  $\mu s$  (typ.) permits operation into inductive loads.
- Critical rate of rise of off-state

voltage—300 V per  $\mu s$  (typ.) for 40668 and 250 V per  $\mu s$  (typ.) for 40669—minimizes false triggering caused by line transients.

- 100 A single-cycle in-rush current capability handles start-up surge loads readily.
- 8 A (RMS) capability at a case temperature of 80°C.
- 4 modes of gate control allow design flexibility and simplicity with either positive or negative DC logic.

For relay replacement, relay protection, motor speed controls and the like—in switching or phase control applications—for use in such devices as comfort control

systems, vending machines, appliances—turn to and turn on with RCA Triacs.

The RCA-40668 for 120 V per 1-kW operation is just 98¢ (1,000 units) and the RCA-40669 for 240 V per 2-kW capability is \$1.10 (1,000 units). See your local RCA Representative or your RCA Distributor for details. For technical data, write RCA Electronic Components, Commercial Engineering Section RG4-1, Harrison, N. J. 07029.

# RCA

# ENVELOPE DELAY AND LOSS MEASUREMENTS FROM 200 Hz TO 600 kHz

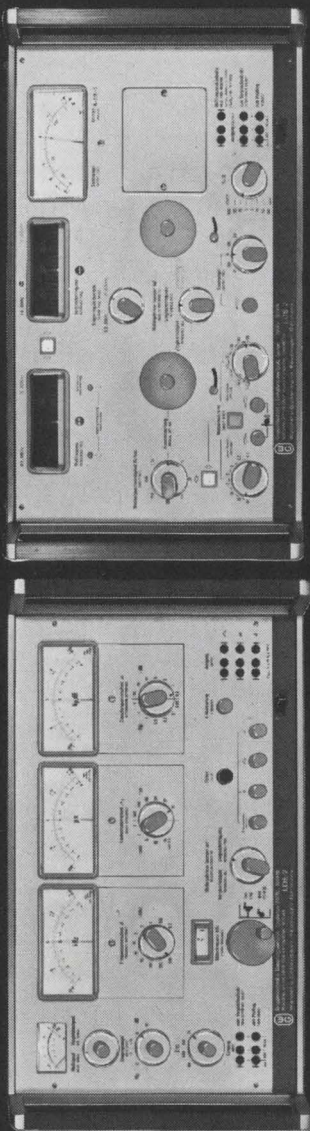

There are other less accurate, less versatile and less expensive design approaches than the one we chose for an instrument to measure envelope delay and attenuation distortion. Our philosophy is to produce only the finest measuring instruments current technology allows. Our objectives are precision measurements with confidence.

The principle we adopted for the LD-2 involves transmitting the reference frequency through the unknown, thereby providing an automatic and continuous phase control of the receiver. This eliminates a major source of potential error in systems that depend on the phase stability of an uncontrolled reference oscillator in the receiver for their accuracy. The approach is sophisticated and costly, but the result is versatility, accuracy, dependability and an instrument in which we take pride.

**Wandel & Goltermann**

West Germany / represented in U.S.A. by

**W&G INSTRUMENTS, INC.**

6 Great Meadow Lane, Hanover, N. J. 07936 • (201) 887-8700



10

## SIDELIGHTS OF THE ISSUE

### A new 'sense' of Home

Since the birth of the space age in 1958, hundreds of satellites have been launched. By far, the majority have been aimed at adding to man's store of pure scientific knowledge. Others have been launched for strictly military applications. Only a relatively few, such as the communications and weather satellites, have had any immediate effect on the average citizen. By 1972 this may all change. For at that time, NASA is expected to launch a remote-sensing, earth-resources satellite that may profoundly affect the future of every human being in the world. For example, by employing remote sensors it may be possible to detect huge stores of undiscovered mineral deposits, spot forest fires practically at their start, predict the pattern of water pollutants and even tell farmers when to harvest their crops. The data may even be used to predict earthquakes. The nature of this data, and the scientifically ingenious ways by which the data will be multispectrally sensed, make up the gist of a timely news story by Elizabeth deAtley, *ELECTRONIC DESIGN's* West Coast editor. For her complete review of the subject, turn to p. 25.

### A case of overexposure

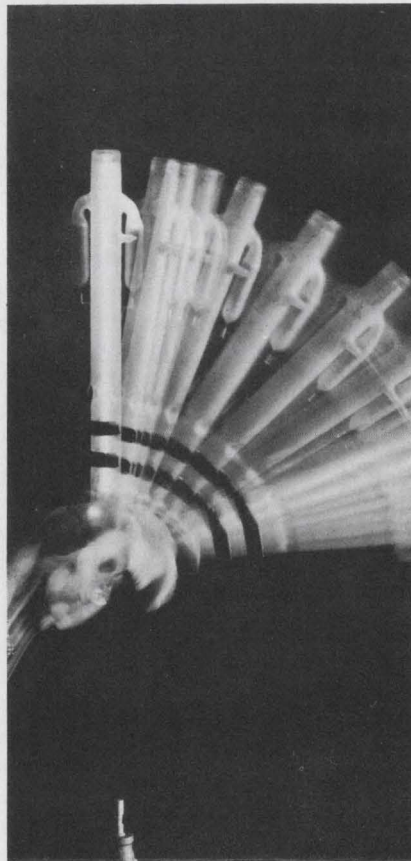

Helium-neon laser, caught by strobe light, was caught by protruding tip of vise, too (visible, bottom left).

An unfunny thing happened to (a) Hank Ries, one of our photographic consultants, and (b) the new-style helium-neon laser tube that Hank was instructed to photograph. While doing so, Hank accidentally closed a human circuit between the tube and his lighting unit. Up flew Hank's right hand, to hit the laser tube, while down went the rest of Hank. The laser tube swung down with him and hit the vise's base. Sorry about that, we had to tell University Laboratories, Inc.; it was a shock to Hank, too. But Hank's all right, and we think the picture he took of the Lasertron is great, too. See for yourself on p. 114.

# Voltage regulation is no longer a make-or-buy decision.

## POSITIVE VOLTAGE REGULATOR

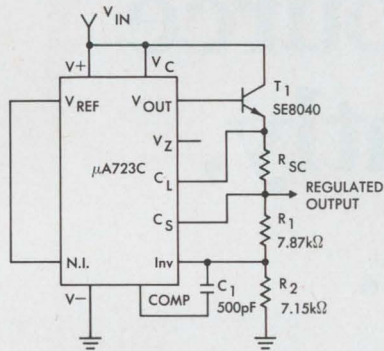

Regulated Output Voltage: +15V  
 Line Regulation ( $\Delta V_{IN} = 3V$ ): 1.5mV  
 Load Regulation ( $\Delta I_L = 1A$ ): 15mV

The Fairchild  $\mu A723$  Precision Voltage Regulator works better and costs less than any module you could make or buy to do the same jobs. Use it for series, shunt, switching or floating regulation — with positive or negative supplies — and get a regulated voltage anywhere in the range from 2V to 37V. Your design determines whether the output voltage is fixed or adjustable. The output current goes up to 150mA, but can be boosted by using an external pass transistor — PNP or NPN. And we've built-in provisions for adjustable current limiting, with or without

foldback, and remote shutdown.

The  $\mu A723$  is another product based on our Second Generation Linear technology. It uses FET's, MOS capacitors and exceptionally well-matched transistor pairs on the chip to give you a typical line and load regulation of 0.03% and a temperature coefficient of just 0.003% / °C. You get better system performance for every device dollar spent.

To show you how easy it is to use, here are two applications for the  $\mu A723$ .

Write for complete specifications and more applications information.

To order the  $\mu A723$ , ask your Fairchild distributor for:

## NEGATIVE VOLTAGE REGULATOR

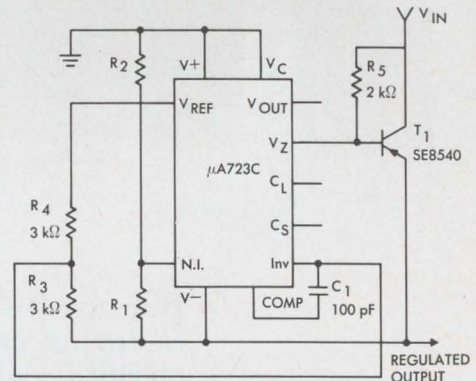

Regulated Output Voltage: -15V  
 Line Regulation ( $\Delta V_{IN} = 3V$ ): 1mV  
 Load Regulation ( $\Delta I_L = 100mA$ ): 2mV

PART NUMBER	PACKAGE	TEMPERATURE RANGE	PRICES		
			1-24	25-99	100-999
U5R7723312	TO-5	-55°C to +125°C	\$22.50	18.00	15.00
U5R7723393	TO-5	0°C to +70°C	6.50	5.20	4.25

**FAIRCHILD**  
SEMICONDUCTOR

# TTL

**If you haven't  
checked on deliveries  
from the first source  
for TTL recently,  
you should.**

Because we've dramatically increased manufacturing capacity on all Series 54/74 integrated circuits. Call TI for delivery information on our 17 Series 54L/74L low power circuits, 26 Series 54/74 standard gates and flip-flops, 13 Series 54H/74H high speed circuits, and 23 TTL/MSI types. All are available in TI's dual-in-line plastic package. Most are in our military-rated flat pack and ceramic d.i.p.



**TEXAS INSTRUMENTS**  
INCORPORATED

**Publisher**

Hugh R. Roome

**Editor**

Howard Bierman

**Managing Editor**

Robert C. Haavind

**Technical Editors**Frank Egan  
Michael J. Riezenman  
Raymond D. Speer**Management and Careers Editor**

Lawrence Locke

**Chief News Editor**

Ralph Dobriner

**Washington News Bureau**

Charles D. LaFond, Chief

**Military/Aerospace Editor**

John F. Mason

**East Coast Editor**

Jim McDermott

**West Coast Editor**

Elizabeth deAtley

**New Products Editors**Robert Patton  
Lucinda Mattera**Copy Editor**

Peter Irving

**Editorial Production**Dollie S. Viebig  
Phyllis Gura**Art Director**

Clifford M. Gardiner

**Art Assistant**

William Kelly

**Technical Illustrators**William Alvarez  
Rita Jendrzejewski  
Lynn E. Thompson**Production Manager**

Thomas V. Sedita

**Asst. Production Manager**

Helen De Polo

**Production Assistants**Bernard Wolinsky  
Carl A. Merkin**Circulation Manager**

Nancy L. Merritt

**Information Retrieval**

Genate Pazmino

## EDITORIAL



## End the conflict of purpose in technological education

The goal of education is to teach students. Yet the aim of too many educators in universities is to obtain more defense research contracts for their institutions. This is hardly surprising when university administrations reward the best contract-getters with promotions. Research work also spawns papers in technical journals, and the papers spell profits to educators.

Technological education has suffered as a result. Lecture sessions, the cookbook laboratory, separation of instructor and student, and an emphasis on gaussian test-score distributions have become widespread standards for technological education. The grind approach is rampant. There's little effort to make it an exciting experience. Innovation is limited, for the most part, to getting a computer for student use and switching to revised textbooks.

At the same time the Government needs the help of scholars to protect the nation and advance its welfare. Research in universities has had tremendously valuable benefits. Many defense projects have broad potential in industry and society. For example, a project aimed at developing educational techniques for servicemen might lead to general concepts for educational technology. The opportunity to do research is vital to a creative academician, and without it many professors might migrate to industry.

Moreover Government research funds provide substantial income to many leading schools. To withdraw this backing suddenly could be disastrous.

It's time to review the influence that defense research contracting is having on our universities. Should universities expend their energies developing concepts to bring in new Government research projects, or should they be working on imaginative laboratory series that will stimulate students rather than bog them down in reports? The answer is clear. The interests of the students must prevail—or it isn't education any longer.

Is there a way to retain the desirable features of Government support while promoting education? Perhaps. Universities might work out teaching co-op programs, where instructors could alternate between periods of teaching and research. The Government might pay institutions for supplying academicians for research. But the research itself might be done at separate institutions, along the lines of Lincoln Laboratory, Stanford Research Institute or Battelle.

A better way *can* be found if the Government and universities work together to find it.

We propose that a team made up of technically qualified defense officials and leading educators make a thorough review of the present situation and develop proposals for a new approach.

ROBERT HAAVIND

# predictable

# pulse performance

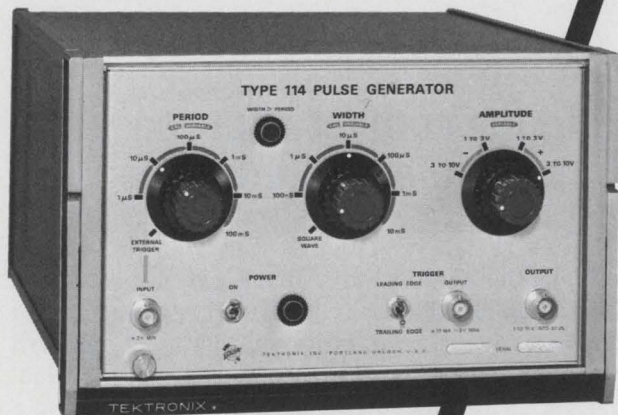

from  
**Tektronix®**

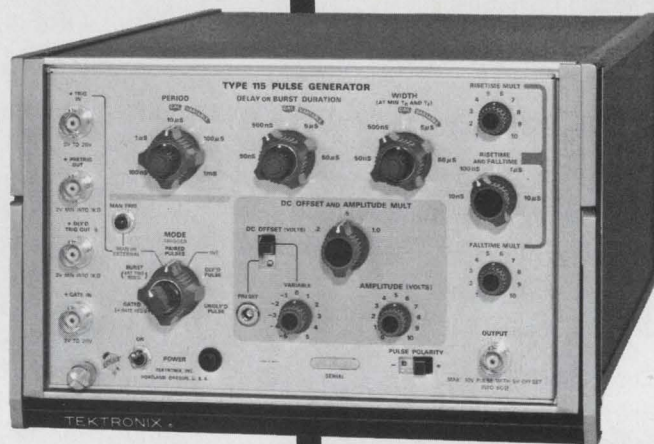

## TYPE 114 PULSE GENERATOR

- 10-Hz to 1-MHz Repetition Rate
- 10-ns Risetime and Falltime
- Pulses or Symmetrical Squarewaves
- $\pm 10$  V into 50  $\Omega$ , Short-Proof Output

Pulses or Squarewaves—You may have either using this solid-state generator! The compact Type 114 provides pulses with 10-ns risetimes and falltimes, periods variable from 1  $\mu$ s to 100 ms and widths variable from 100 ns to 10 ms. Pulse amplitudes are adjustable from  $\pm 1$  V to  $\pm 10$  V into 50  $\Omega$ . Aberrations are  $\leq 5\%$  at  $\pm 10$  V into 50  $\Omega$ . Symmetrical squarewaves are instantly available by setting the Width control to the squarewave position. Squarewave period and amplitude ranges are the same as for pulses. External trigger input permits synchronizing the Type 114 output with other events up to 2-MHz repetition rate. An optional rack adapter provides for mounting one or two Type 114 or Type 115 Pulse Generators in only 5 1/4 inches of panel height. Consult your Tektronix Catalog for detailed description of the Type 114 and the optional rack adapter.

Type 114 Pulse Generator ..... \$320

## NEW! TYPE 115 PULSE GENERATOR

- 100-Hz to 10-MHz Repetition Rate
- Variable Risetime and Falltime, 10 ns to 100  $\mu$ s
- Variable DC Offset,  $\pm 5$  V
- $\pm 10$  V into 50  $\Omega$ , Short-Proof Output

This multi-purpose, solid-state generator produces exceptionally clean pulses with aberrations less than 3% P-P at  $\pm 10$  V into 50  $\Omega$ . Pulse risetime, falltime, width, delay, period, amplitude and baseline offset are separately variable, permitting precise waveform simulation. Five operating modes offer a variety of outputs—undelayed pulses, delayed pulses, paired pulses, burst of pulses and gated pulses. Risetimes and falltimes are continuously variable from 10 ns to 100  $\mu$ s and periods are variable from 100 ns to 10 ms. Pulse widths are variable from 50 ns to 500  $\mu$ s with duty factors to 75% (50-ns minimum pulse separation). A continuously variable DC offset feature permits positioning pulse baseline through a range of +5 volts to -5 volts. Triggering is selectable, internally or externally. A detailed description of the Type 115 Pulse Generator is found in your Tektronix Catalog.

Type 115 Pulse Generator ..... \$825

U.S. Sales Prices FOB Beaverton, Oregon

To evaluate either of these pulse generators in your application, call your Tektronix Field Engineer, or write Tektronix, Inc., P.O. Box 500, Beaverton, Oregon 97005



**Tektronix, Inc.**  
committed to progress in waveform measurement



# Technology

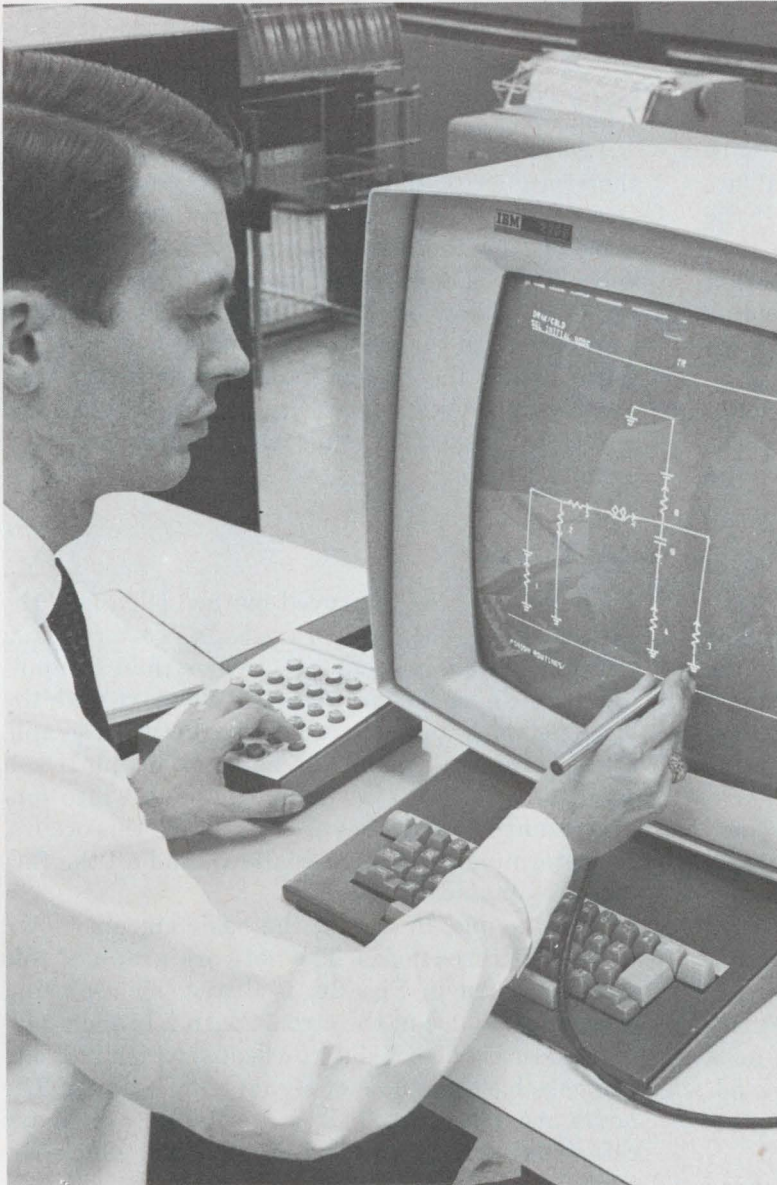

Graphic displays make your designs go quick, quick, quick, and cut your programming costs. On page 64.

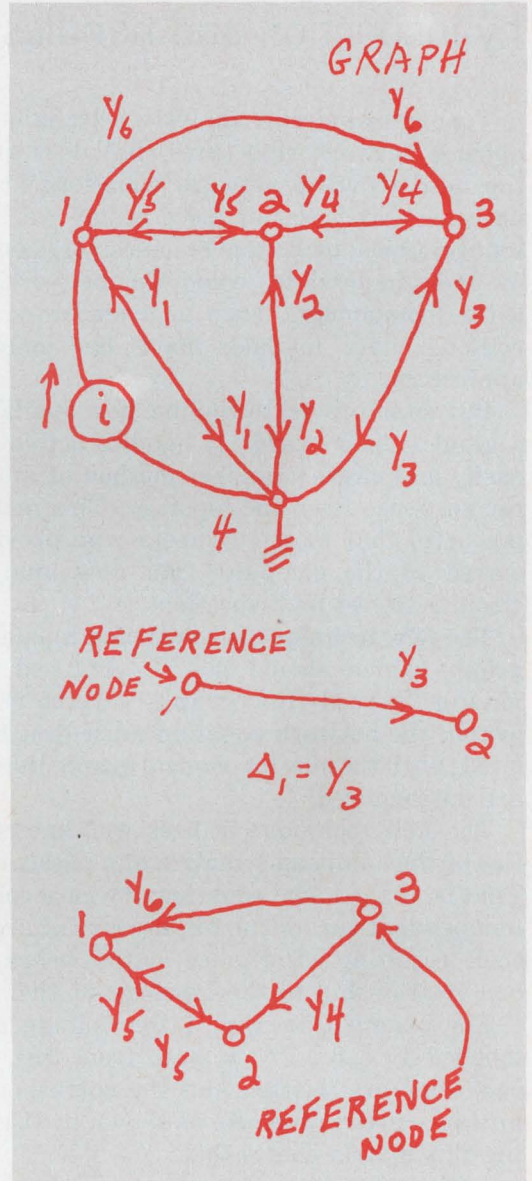

Improved topological method speeds network analysis. See page 56.

## Also in this section:

Simplify switching circuit design and get optimum coupling between stages. Page 70

Nobody wins an argument. But you can win a discussion. Page 76

Ideas For Design. Page 82

# Speed network analysis with topology

by using an improved method that provides solutions by inspection and handles active devices.

Topological circuit analysis, a technique for analyzing network structures that does away with the need to write network equations or evaluate network matrices, can speed design work. But the topographical technique becomes very complicated, or even impossible, when the networks contain active components, such as transistors. For this reason, these methods have had only limited application.

But an improved technique, now available, takes a giant step forward: It handles active networks easily and offers a quicker method of interpreting the response from the topology. This method is so powerful that most engineers who previously resorted to the computer can now analyze their circuits almost by inspection.

The new technique is based on a topological flow graph, which should not be confused with the Mason "signal-flow graph."<sup>1</sup> With the Mason graph, the network equation must first be formulated; with the new topological graph, the equations are not required.

The new technique utilizes well-known properties of the admittance matrix of a passive network. That is, if the nodal equations (where voltages are independent variables) for any circuit are written, their resulting admittance matrix bears a one-to-one relationship to the topology of that network.

For example, in Fig. 1 the voltage nodes are labelled 1, 2, 3 . . .  $n$ , and, from this, the node equations are written and the corresponding admittance matrix formed, as shown in (b). Inspecting this matrix shows that:

1. The sum of the admittances coming into node  $i$  is the same as the term appearing at the intersection of the  $i$ th row and  $i$ th column. Example: Admittances  $Y_6 + Y_5 + Y_3$  enter node 2 and appear at intersection of row 2 and column 2.

2. The admittances going from node  $i$  to node  $j$  appear in the matrix as the negative of the term at the intersection of the  $i$ th column and  $j$ th row. Example: Admittance  $Y_6$  going from node 1 to node 2 appears as  $-Y_6$  at intersection of column

1 and row 2.

From the topology of the network one can therefore write down the network determinant. Ordinarily, to evaluate the determinant,  $\Delta$ , it is expanded by the conventional method, which involves tedious multiplications and numerous cross-products, many of which drop out in the final answers. With the new method, however, the final quantities in the expanded determinant, for both passive and active networks, can be determined purely by inspection, thus eliminating time-consuming steps.

## How it's done

The basis of the improved method is called "the expansion of the network graph," which is a straightforward mechanical, rather than computing, process, as shown in Fig. 2. We start with the basic network and convert it to a network graph, then proceed to expand the network graph into a determinant graph; we again expand this into sub-graphs until no branches are left. When this occurs, the determinant is fully expanded, and all the factors are obtained.

For example, in Fig. 2, the basic circuit shown in (a) has three nodes. The network graph of this circuit, shown in Fig. 2b, is drawn by replacing every admittance in the circuit with a branch having oppositely directed arrowheads, which indicate two possible directions of signal transmission. The nodes are numbered, 1, 2, 3 . . .  $n$ , and a primary reference node is now selected, about which the expansion will take place.

Any node may be selected, but experience has shown that the node with the greatest number and complexity of incoming branches is best. For this particular case, it is node 3.

The network graph is then expanded by use of the determinant graph (c), which looks like a network graph, but which has the current or voltage sources removed. Current sources are open-circuited, as shown. Voltage sources are short-circuited.

To transform the network graph to the determinant graph, first choose the primary reference node. Having selected the reference node (3 in Fig.

---

John DeFalco, Senior Engineer, Honeywell Computer Control Div., Framingham, Mass.

**Table. Expanded Determinants**

No. of primary reference branches	Expansion of determinant to find value of $\Delta$
1	$\Delta = a_1\Delta_1; \Delta_1 = 1, \therefore \Delta = a_1$
2	$\Delta = a_1\Delta_1 + a_2\Delta_2 + a_1a_2\Delta_{1,2}$
3	$\Delta = a_1\Delta_1 + a_2\Delta_2 + a_3\Delta_3 + a_1a_2\Delta_{1,2} + a_2a_3\Delta_{2,3} + a_1a_3\Delta_{1,3} + a_1a_2a_3\Delta_{1,2,3}$
4	$\Delta = a_1\Delta_1 + a_2\Delta_2 + a_3\Delta_3 + a_4\Delta_4 + a_1a_2\Delta_{1,2} + a_1a_3\Delta_{1,3} + a_1a_4\Delta_{1,4} + a_2a_3\Delta_{2,3} + a_2a_4\Delta_{2,4} + a_3a_4\Delta_{3,4} + a_1a_2a_3\Delta_{1,2,3} + a_1a_2a_4\Delta_{1,2,4} + a_1a_3a_4\Delta_{1,3,4} + a_2a_3a_4\Delta_{2,3,4} + a_1a_2a_3a_4\Delta_{1,2,3,4}$

2c), all arrowheads pointing to the node are removed. The reference branches are now labelled  $a_1, a_2, a_3 \dots a_n$ , where branch  $a_1$  goes to node 1, and branch  $a_n$  to node  $n$ . In Fig. 2c the reference branches are  $a_1$  and  $a_2$ .

Now, the fully evaluated determinant is composed of products of the reference branches ( $a_1, a_2$ , etc.) of both the determinant graph and of subgraphs. The subgraphs are the branches and nodes remaining when the primary reference branches of the determinant graph are removed, together with all arrows directed towards nodes  $i, j, k \dots$  as indicated by the subgraph symbols  $i, j, k \dots$  etc. These subgraphs are designated by  $\Delta_1, \Delta_2, \Delta_3 \dots \Delta_n$ .

For each new subgraph, a new reference node is selected. This node is indicated by the number associated with the  $\Delta$  symbol, and, like the preceding reference branches, the arrows next to the new subgraph reference node are deleted.

As an example, see  $\Delta_1$  and  $\Delta_2$  in Fig. 2d. Just branch  $Y_3$  is left, and its value is  $Y_3$ . Although single branches are shown for the general case, they may be multi-branch networks; in this case subgraphs are made of other subgraphs, and the expansion is continued until single branches and, finally, no branches are left.

It must be emphasized that in the evolution described in Fig. 2, we are expanding the basic determinant  $\Delta$ . However, as described later, for network problems of transmission or gain, partial determinants (Eq. 4) are also used.

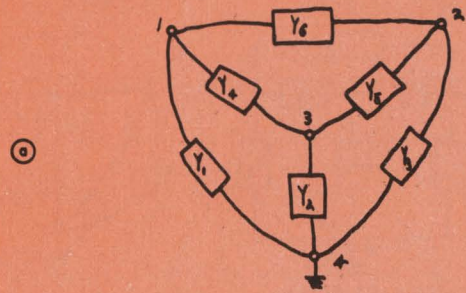

(b)

$$\Delta = \begin{vmatrix} 1 & 2 & 3 \\ Y_1 + Y_4 + Y_6 & -Y_6 & -Y_4 \\ -Y_6 & Y_6 + Y_5 + Y_3 & -Y_5 \\ -Y_4 & -Y_5 & Y_4 + Y_5 + Y_2 \end{vmatrix}$$

1. From the topology of the network in (a), the determinant of that network (b) can be written by inspection.

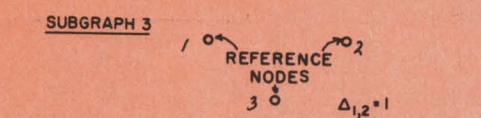
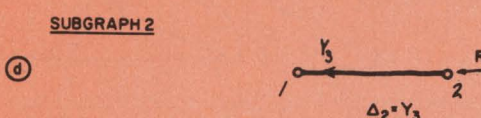
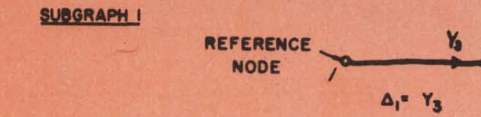
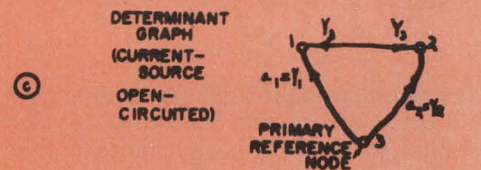
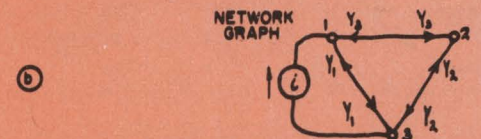
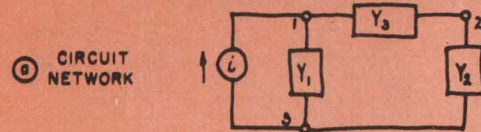

2. Expansion of the network graph starts with the circuit network (a), which is converted to a network graph (b), that is expanded to a determinant graph (c) and subgraphs (d), which provide all determinant factors.

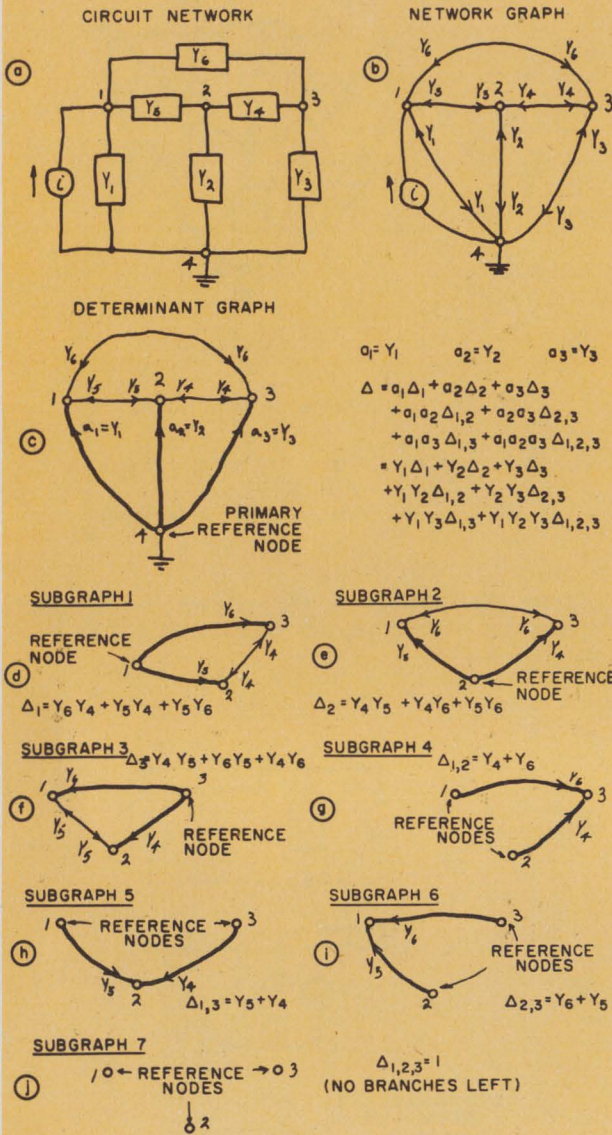

3. Complete development of a circuit network, from the network graph to the determinant graph, and continuing through the seven subgraphs ends when subgraph 7 has no branches, only nodes left: its value is then unity.

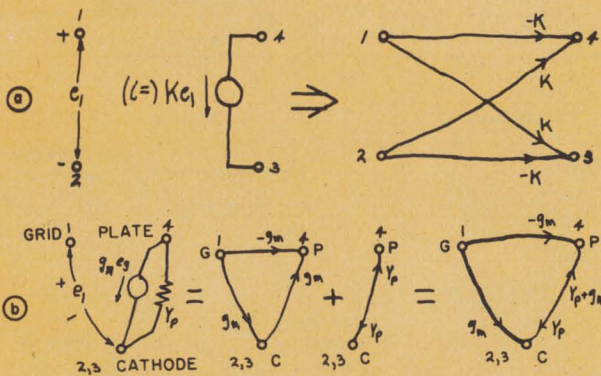

4. Incorporating a dependent current source in the network is accomplished by connecting the voltage nodes on which the current is dependent (a), to the nodes of the apparent current source (3,4), with branches having arrows of unilateral direction. Method is applied in (b) to the equivalent circuit of a vacuum tube.

### Expansion rules

A general rule exists for expanding the determinant. Its proof may be found in Ref. 2. The rule can be expressed as:

$$\Delta = a_1 \Delta_1 + a_2 \Delta_2 + \dots + a_n \Delta_n + a_1 a_2 \Delta_{1,2} + a_1 a_3 \Delta_{1,3} + a_2 a_3 \Delta_{2,3} + \dots + a_1 \dots a_n \Delta_{1,2,\dots,n} \quad (1)$$

The great majority of networks analyzed have a maximum of four reference branches, so the expanded determinants for one to four branches are given in the table. According to Eq. 1, the value of the network determinant  $\Delta$  is found by expanding the determinant graph. First, take the sums of all the reference branches, one at a time, and multiply the value of each reference branch by the value of its subgraph. Example:  $a_1 \Delta_1 + a_2 \Delta_2 + \dots$  etc.

Next, the values of all reference branches are taken two at a time, and multiplied by the value of the subgraph. Example:  $a_1 a_2 \Delta_{1,2} + a_1 a_3 \Delta_{1,3} + \dots$  etc. The process continues until all  $n$  branches are taken 1, 2, 3 ...  $n$  at a time. Example:  $a_1 a_2 a_3 \dots a_n \Delta_{1,2,3,\dots,n}$ .

It must be emphasized that in forming the subgraphs all reference branches are removed. Nodes on the remaining branches become the new reference nodes for the subgraphs. For example, in Fig. 2d, node 1 is the reference node for  $\Delta_1$  and node 2 is that for  $\Delta_2$ . When the subgraph has only nodes and no branches left, its value is unity.

Returning to the network of Fig. 2, the equation for the expansion of its determinant is, from the table:

$$\Delta = a_1 \Delta_1 + a_2 \Delta_2 + a_1 a_2 \Delta_{1,2} \quad (2)$$

From 2c and 2d, we can see that  $a_1 = Y_1$ ,  $a_2 = Y_2$ , and  $\Delta_1 = Y_3$ ,  $\Delta_2 = Y_3$ , and  $\Delta_{1,2} = 1$ . Consequently, the value of the determinant can be expressed as

$$\Delta = Y_1 Y_3 + Y_2 Y_3 + Y_1 Y_4 \cdot 1 \quad (3)$$

Complete development of a representative case is shown in Fig. 3. Inspection of the determinant graph shows the primary references. The expansion (from the table) is shown alongside the determinant graph, which is fully expanded into seven subgraphs. In the seventh subgraph no branches remain, indicating the expansion is completed. The determinant graph and the subgraphs are all evaluated in the same manner. At each step, the branches from the previous reference node are

eliminated. Although this technique looks complicated, it can be learned rapidly, and a circuit like that in Fig. 3 can, with a bit of practice, be evaluated in one minute.

### Incorporating dependent sources

Before the improved method is used to find voltages and currents in a network, one must learn how to incorporate dependent sources in a network graph. These sources are dependent on a voltage or current connected somewhere else in the network.

The general rule is illustrated in Fig. 4a. Here, it is assumed that a current source between nodes 4 and 3 depends on the voltage between nodes 1 and 2, which are at some remote point in the circuit. The value of current flow is related to the voltage by a  $K$  factor or,  $i = Ke_1$ . Consequently the current source is replaced by  $K$ -branches with arrows, as shown in Fig. 4a (at the right). If the current source were of opposite polarity, each branch would be the negative of the value indicated.

As an example, consider the equivalent circuit for the vacuum tube shown in Fig. 4b. Note that the current source dependency is a special case of Fig. 4a, with nodes 2 and 3 superimposed. The plate resistor is added in parallel with the transconductance ( $g_m$ ) branch between cathode and plate nodes. The  $K$  factor here is  $g_m$ .

Practical network problems are solved for the complex ratios of voltages, currents or impedances. This involves a fraction comprised of a denominator (which is the full network determinant  $\Delta$ ) and of a numerator, which is a partial determinant related to the flow of signals through the network. See Eq. 4.

For voltage gain and other problems, the relationship between the voltage at any particular node ( $e_n$ ) and the input or source voltage ( $e_i$ ) is defined

$$e_n = e_i \frac{(P_1 \Delta_{P_1} + P_2 \Delta_{P_2} + \dots + P_m \Delta_{P_m})}{\Delta} \quad (4)$$

where:

$e_i$  is the voltage at the input terminals of the circuit;

$e_n$  is the voltage at node  $n$  of the voltage graph;

$\Delta$  is the network determinant as shown in the table, or as evaluated by Eq. 1;

$P_i$  is the path gain, for any network element, of the  $i$ th path from  $e_i$  to  $e_n$ , not passing through the ground node; and

$\Delta_{P_i}$  is the determinant evaluated on a network subgraph formed by shorting to ground all nodes

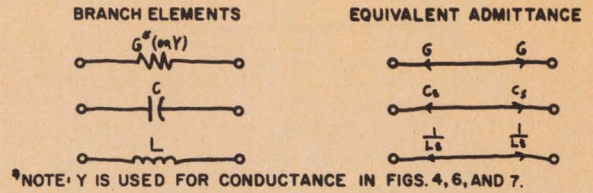

5. Branch elements and equivalent admittances for bilateral elements normally dealt with in network analysis. Although  $Y$  is used for conductance in some of the examples,  $G$  is the more proper symbol.

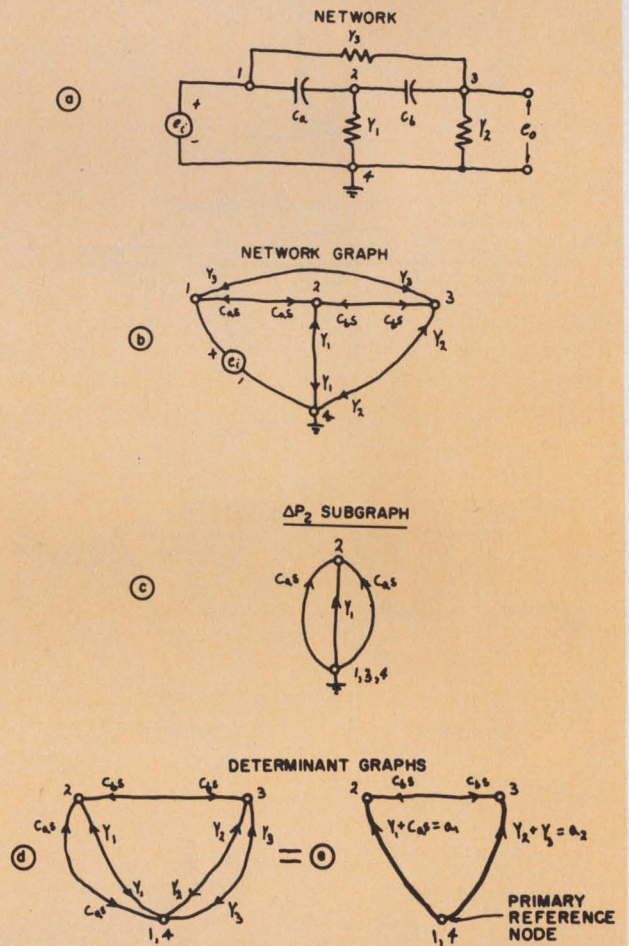

6. Network development for evaluating voltage gain of the RC network in (a). Network graph (b) is expanded into complete determinant graph (d) by shorting voltage source to ground. Parallel paths simply add together to give the simple, two-branch graph in (e), from which expansion is developed.

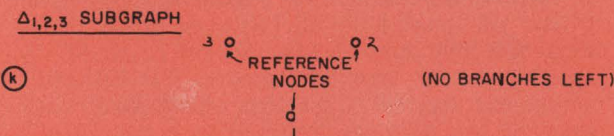
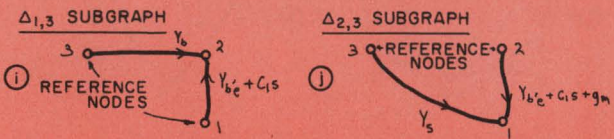
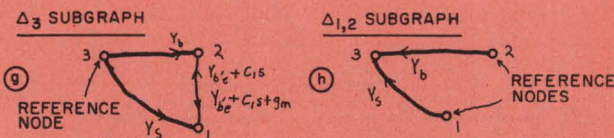
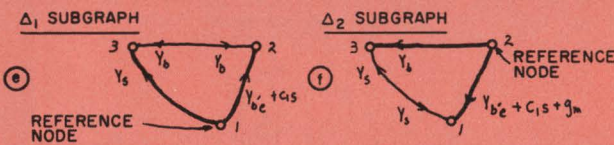
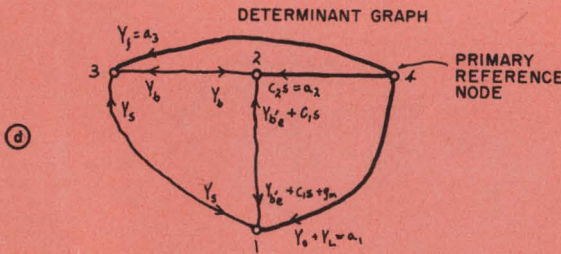
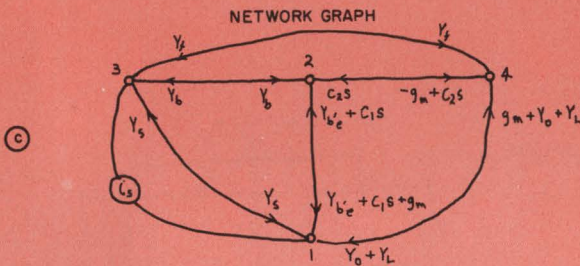
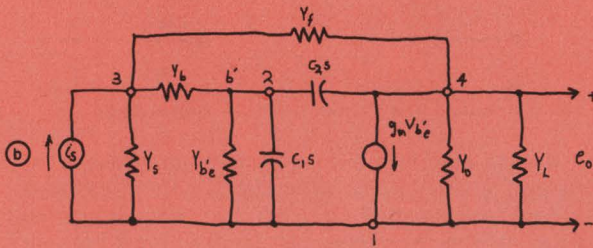
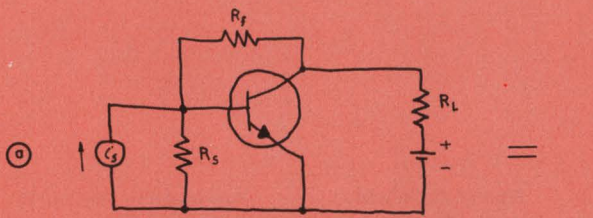

7. Transistor circuit high-frequency response is obtained by converting the transistor equivalent circuit in (a), and then expanding in accordance with Eq. 8 in text.

that the *i*th path passes through.

The factors which are multiplied in solving the determinant are the products of the branch gains in a path formed by following arrow directions between certain nodes. For example, in Fig. 1 there are two paths from node 1 to node 2. Note that the path through ground-node 4 is not considered a path. Path one goes from node 1 through branch  $Y_6$  to node 2, and has the path gain,  $Y_6$ . Path two goes from node 1 through branch  $Y_4$  to node 3, and thence through  $Y_5$  to node 2. This path gain is  $Y_4 Y_5$ .

With the improved method now established by Figs. 2, 3, and 4, we are now in a position to analyze practical circuits. Up to this point we have been using the  $Y$ s as a generalized admittance in the network. However, for the lumped, linear, finite, passive, bilateral elements normally dealt with, the nature of the branches is indicated in Fig. 5, and the value of the element admittance is the value of the branch.

### Determining voltage gain

For the first practical example, let's evaluate the voltage gain for the circuit in Fig. 6. We can use Eq. 4 directly, by substituting  $e_o$  for  $e_n$  and by rearranging:

$$\frac{e_o}{e_i} = \frac{P_1 \Delta_{P_1} + P_2 \Delta_{P_2} + \dots + P_m \Delta_{P_m}}{\Delta} \quad (5)$$

From inspection of the network, there are only two P-paths from  $e_i$  to  $e_o$  not passing through the ground node. Consequently, Eq. 5 now becomes

$$\frac{e_o}{e_i} = \frac{P_1 \Delta_{P_1} + P_2 \Delta_{P_2}}{\Delta} \quad (6)$$

In Fig. 6, the  $P_1$  path goes from node 1, along branch  $C_{2s}$  to node 2, and from node 2 to node 3 via branch  $C_{1s}$ . Therefore, the path gain of  $P_1 = C_{1s} C_{2s}$ .

Now, to evaluate  $\Delta_{P_1}$ , short to ground all nodes (1, 2, and 3) that the  $P_1$  path passes through. There now remains but one node with no branches, so it has a value of unity. Consequently  $\Delta_{P_1} = 1$ .

Path  $P_2$  is branch  $Y_3$ , therefore  $P_2 = Y_3$ . To evaluate  $\Delta_{P_2}$ , short nodes 1 and 3 to ground. The  $\Delta_{P_2}$  subgraph now looks like Fig. 6c, and  $\Delta_{P_2} = C_{2s} + Y_1 + C_{1s}$ . The numerator of the righthand side of Eq. 6 is now equal to:  $C_{1s} C_{2s} + Y_3 (C_{2s} + Y_1 + C_{1s})$ .

In Fig. 6b the voltage source ( $e_i$ ) is short-circuited, thus giving the determinant graph in Fig.

6d, which has nodes 1 and 4 superimposed. Arbitrarily choosing node 4 as the reference point, there are apparently four branches going away from the node. But because the branches are in parallel, their values add [in series, they multiply], and we obtain the simplified two-branch determinant graph in Fig. 6e. From the determinant expansion for two primary reference branches in the table, the denominator  $\Delta$  of Eq. 6 is then obtained. Applying this expansion to Fig. 6d, the network denominator is obtained and the expression for the voltage gain is, then:

$$\frac{e_o}{e_i} = \frac{C_a C_b s^2 + Y_3 (C_a s + Y_1 + C_b s)}{(Y_1 + C_a s)(Y_2 + Y_3) + (Y_1 + C_a s)C_b s + C_b s(Y_2 + Y_3)} \quad (7)$$

### Analyzing transistor circuit response

In this second practical example, the transistor circuit of Fig. 7 will be analyzed for its high-frequency response. The equivalent circuit and network graph appear in Figs. 7b and 7c. The equation for the high-frequency output voltage is:

$$e_o = \dot{i}_s \left( \frac{P_1 \Delta_{P_1} + P_2 \Delta_{P_2}}{\Delta} \right) \quad (8)$$

The network determinant is best evaluated at node 4 and, from the table, the expansion for three primary reference branches ( $a_1, a_2, a_3$ ) is:

$$\Delta = a_1 \Delta_1 + a_2 \Delta_2 + a_3 \Delta_3 + a_1 a_2 \Delta_{1,2} + a_1 a_3 \Delta_{1,3} + a_2 a_3 \Delta_{2,3} + a_1 a_2 a_3 \Delta_{1,2,3} \quad (9)$$

As in the previous example, locate the  $P$ -paths from  $i_s$  to  $e_o$  not passing through the ground node. In this example,  $e_i$  is developed across the transistor input load  $R_s$  (Fig. 7a), or across  $Y_s$  by the current source (Fig. 7b). Path  $P_1$  therefore goes from nodes 3 to 2 to 4, through  $(C_2 s - g_m)$  and  $Y_b$ . Path  $P_2$  goes between nodes 3 and 4 through  $Y_f$ . The gains of these paths are:  $P_1 = Y_b (C_2 s - g_m)$ ;  $P_2 = Y_f$ . Note that  $g_m$  is minus because it is a unilateral transmission path.

To evaluate  $\Delta_{P_1}$ , ground all nodes (4, 2, and 3) that the  $P_1$  path passes through, leaving only one node and no branches;  $\Delta_{P_1}$  is therefore equal to 1. Evaluate  $\Delta_{P_2}$  in the same fashion, shorting nodes 3 and 4 to ground, leaving a subgraph with three branches ( $Y_b' + C_1 s$ ),  $Y_b$ , and  $C_2 s$  terminating on node 2. From this  $\Delta_{P_2}$  is equal to  $Y_b + Y_b' + C_1 s + C_2 s$ .

The values obtained by evaluating the determinants and subgraphs in Fig. 7 are:

$$a_1 = Y_o + Y_L; \Delta_1 = Y_s (Y_b' + C_1 s) + Y_s Y_b$$

$$+ (Y_b' + C_1 s) Y_b$$

$$a_2 = C_2 s; \Delta_2 = (Y_b' + C_1 s + g_m) (Y_b + Y_s) + Y_b Y_s$$

$$a_3 = Y_f; \Delta_3 = Y_b Y_s + Y_s (Y_b' + C_1 s)$$

$$+ Y_b (Y_b' + g_m + C_1 s)$$

$$a_1 a_2 = (Y_o + Y_L) (C_2 s); \Delta_{1,2} = Y_s + Y_b$$

$$a_1 a_3 = (Y_o + Y_L) Y_f; \Delta_{1,3} = Y_b + Y_b' + C_1 s$$

$$a_2 a_3 = C_2 s Y_f; \Delta_{2,3} = Y_s + Y_b' + C_1 s + g_m$$

$$a_1 a_2 a_3 = (Y_o + Y_L) (C_2 s) Y_f; \Delta_{1,2,3} = 1$$

At this point, all the terms of Eq. 8 have been expanded and evaluated. To calculate the response, it is only necessary to substitute the values of  $P_1, \Delta_1, P_2, \Delta_2,$  and  $\Delta$  into Eq. 8, along with a value for input current  $i_s$ .

Despite the great number of terms, experience has shown that the calculation requires only a minute or so, against 15 minutes or more with other network methods.

In addition to the applications presented here, this improved method can be extended to solve for other parameters, such as input impedance, output impedance, and mesh currents. ■ ■

### References:

1. S. J. Mason, "Feedback Theory: Some Properties of Signal Flow Graphs," *Proc. Inst. Radio Engrs.*, 41, Sept. 1953, pp. 1149-1156.
2. L. P. A. Robichaud, *Signal Flow Graphs and Applications*, Englewood Cliffs, N.J. Prentice Hall, 1962.

### Test your retention

Here are questions based on the main points of this article. Their purpose is to make sure you have not overlooked any important ideas. You'll find the answers in the article.

1. On what properties of the admittance matrix of a passive network is the new topological method based?

2. What is the major advantage of the new method over conventional methods of determinant expansion?

3. What is the general rule for expanding the determinant?

4. What are the differences between the network graph, the determinant graph and the subgraphs? Which comes first?

5. How are current and voltage sources treated on determinant graphs?



# 29 FETS FOR SWITCHES OR CHOPPERS



## What's your most important switch or chopper requirement?

ON resistance . . . low as 5 ohms  
 Gate-to-drain capacitance . . . little as 0.25 pF  
 Price . . . some low as \$2.00 (100 up)  
 Somewhere in the 29 FETs listed here you'll find the right tradeoff for your switching or chopping application. Contact us for complete data on any or all of these devices!

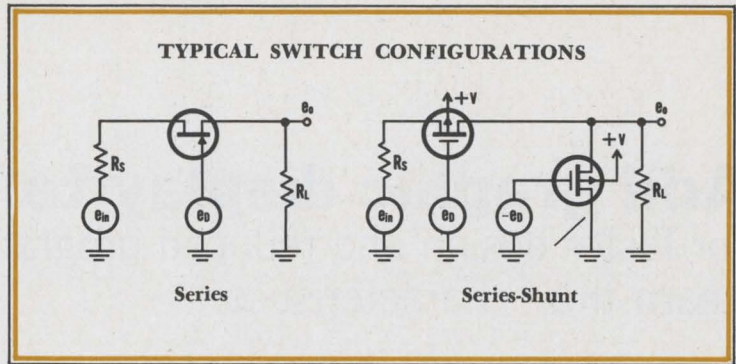

Type	$r_{DS(ON)}$ Max. (Ohms) <sup>(1)</sup>	$C_{gd(OFF)}$ (pF) <sup>(2)</sup>	$I_{D(OFF)}$ (pA) <sup>(3)</sup>	$V_P$ Max. (Volts) <sup>(4)</sup>	$BV_{GDS}$ Min. (Volts) <sup>(5)</sup>	Price <sup>(6)</sup>
MOS						
M105	20	9	10	—	30	\$23.50
M103	200	2.7	8	—	30	5.30
M104	1200	0.25	3	—	30	4.65
JUNCTION						
2N5432	5	9.5	40	10	25	40.00
2N5433	7	9.5	40	9	25	20.00
2N5434	10	9.5	40	4	25	33.50
U240 <sup>(7)</sup> (2N4445)	5	9.5	40	10	25	31.50
U241 <sup>(7)</sup> (2N4446)	10	9.5	40	10	25	14.25
U242 <sup>(7)</sup> (2N4447)	6	9.5	40	10	20	18.00
U243 <sup>(7)</sup> (2N4448)	12	9.5	40	10	20	11.70
2N4856	25	2.9	8	10	40	4.50
2N4857	40	2.9	8	6	40	3.80
2N4858	60	2.9	8	4	40	3.15
2N4859	25	2.9	8	10	30	4.35
2N4860	40	2.9	8	6	30	3.70
2N4861	60	2.9	8	4	30	3.00
2N4391	30	2.9	8	10	40	4.70
2N4392	60	2.9	8	5	40	3.70
2N4393	100	2.9	8	3	40	3.00
2N4091	30	2.9	8	10	40	4.35
2N4092	50	2.9	8	7	40	3.70
2N4093	80	2.9	8	5	40	3.00
2N3970	30	5.5	10	10	40	3.50
2N3971	60	5.5	10	5	40	2.60
2N3972	100	5.5	10	3	40	3.00
U200	150	5.5	20	3	30	2.35
U201	75	5.5	20	5	30	2.20
U202	50	5.5	20	10	30	2.00
2N3824	250	1.2	2.5	8	50	2.70

### NOTES:

- (1) Maximum ON Channel resistance measured at  $V_{GS} = 0$ ,  $V_{DS} = 0$ , for junction FETs, and  $V_{GS} = -20V$ ,  $V_{DS} = 0$  for MOS FETs.
- (2) Typical gate-to-drain OFF capacitance values measured at  $V_{GS} = -10V$ ,  $V_{DS} = 10V$  for junction FETs and  $V_{GS} = 0$ ,  $V_{DS} = -10V$  for MOS FETs.  $C_{gd(ON)}$  is approximately three times  $C_{gd(OFF)}$ .
- (3) Typical OFF drain current measured at  $V_{GS} = -10V$ ,  $V_{DS} = 10V$  for junction FETs and  $V_{GS} = 0$ ,  $V_{DS} = -10V$  for MOS FETs.
- (4)  $V_P$  max. to data sheet conditions.
- (5)  $BV_{DSS}$  for MOS FETs.
- (6) 100-999 Prices.
- (7) Identical to 2N4445 series, except for package.

**\* Applications Power: An ever-expanding catalog of quality devices, plus an in-depth applications team waiting to serve you!**



## Siliconix incorporated

1140 West Evelyn Ave. • Sunnyvale, Calif. 94086  
 Telephone (408) 245-1000 • TWX 910-339-9216

**ON CONDITION:** ON error voltage is a function of FET  $r_{DS(ON)}$  value relative to source and load resistance values of the circuit. Since, for different FET geometries, lower ON resistance means larger capacitance, a good figure of merit is the  $r_{DS(ON)} C_{gd}$  product for a given  $V_P$ . The 2N5432 series has the lowest  $r_{DS(ON)} C_{gd}$  product available!

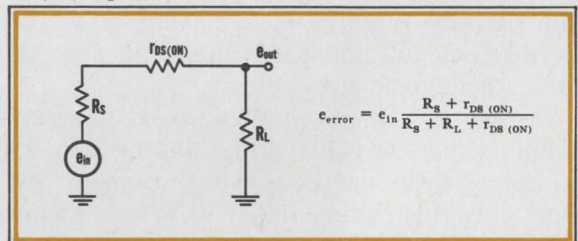

**OFF CONDITION:** Static OFF error voltage is extremely small due to low drain leakage current,  $I_{D(OFF)}$ . AC feedthrough is low since drain-to-source capacitance,  $C_{ds}$ , is always less than 0.4 pF.

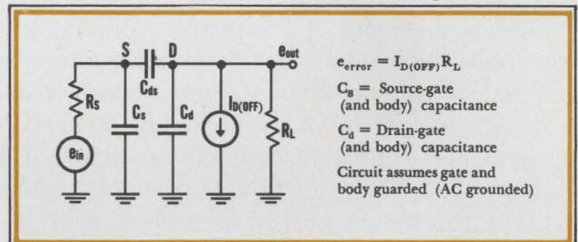

**SWITCHING:** Going from the ON condition to the OFF condition is generally the limiting case, and the important parameters are gate-to-drain capacitance,  $C_{gd}$ , and the output load impedance  $R_L$  and  $C_L$ . Silicon FETs offer lower  $C_{gd}$  for a given  $r_{DS(ON)}$  and  $V_P$ .

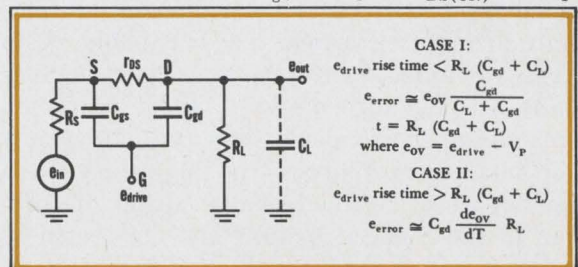

For further information and immediate applications assistance call the number below. Ask for Extension 19.

# Add graphic display to your computer

for faster design and reduced programming costs.  
Learn their characteristics.

Computer-aided design is still limited by the relatively slow operator-to-computer input-output communication link and the time and cost associated with teams of experienced programmers. Adding a graphic display system frees the designer from the need to set up equations or to transcribe data into punched cards. He works directly and alone, supplying graphical information directly into the system, and in seconds he has his calculations performed and sees the results displayed before him.

Instead of developing complex programs to handle every possible situation, he can specify design criteria at the graphic console. He can then provide immediate direction whenever errors or unusual conditions occur. Programming is thus simplified. And finally, the machine no longer dictates complete control over program flow; the creativity of the designer can thus be exercised.

The end-benefits of the graphic display system are: reduced product development time as a result of lowered turnaround time; faster response to design errors or oversights, and lowered programming costs. Present obstacles such as software support, hardware costs and the designer's resistance to change will be discussed shortly.

## Elements of a graphic system

Computer graphics involves the use of a graphic display device or cathode-ray tube (CRT) as an input-output device connected on-line to a digital computer system that is capable of storing large amounts of information, of retrieving specially selected information, and of performing a great number of calculations and data manipulation in seconds. Whereas, in their early use, CRT devices were confined to the output of information in the form of graphs and curves, in recent years input capabilities have been added that allow sketching and transmitting data to the computer in pictorial form. The benefits gained include more efficient utilization of computer re-

sources by non-programmers and marked improvement in speed over the comparatively slow, operator-to-computer communication link. These two features of graphic display devices are quite appealing, particularly with time-sharing systems.

A graphic data processing system (Fig. 1) basically consists of a display console attached to a digital computer through data communication channels. The display console provides the interface between the user and the computer and has, as its main characteristics, flexibility, speed and ease of operation. It contains an operator display unit, a light pen and, as optional manual input features, a set of function keys and an alphanumeric keyboard.

The operator display unit is a cathode-ray tube that has a display area on which information can be presented in graphical and alphanumeric form for visual communication between the operator and the computer. The image on the CRT is produced by an electron beam, which can be moved under program control over a grid of addressable points. While moving over the face of the CRT, the beam can be turned on and off by the program. The image is made up of points, straight lines of any desired length and orientation, and



1. The display console of a graphic data processing system includes an operator display unit, a light pen and a keyboard.

---

Juan Lafuente, Systems Development Div., International Business Machines Corp., Poughkeepsie, N.Y.

alphanumeric characters. To create an image on the CRT, the computer executes a graphic program—a series of orders or instructions. This program is continuously executed, causing the picture to be regenerated 30 to 40 times a second. The rapid execution of the graphic orders together with the brief persistence of the light on the screen gives the illusion of a fixed image. To regenerate the image, some display units are equipped with buffer storage or secondary storage, where the image is transferred from the central processing unit (CPU) after it is edited by the main program. The use of the buffer storage feature allows simultaneous operation of the display unit and the CPU, freeing the computer system for other purposes.

To display characters on the CRT, the system is usually provided with a character generator feature, which consists of a high-speed character yoke and analog circuitry which, in turn, translates strokes from a table in main storage into the electronic signals necessary to trace each character. The character generator feature significantly reduces the time required to display alphanumeric information, and relieves the CPU of the burden of character generation.

The light pen is used by the operator to identify a particular area of interest in the display to the computer. Light is emitted by the CRT phosphor as the image is traced. The user simply points the light pen to a line or character on the display screen. A photocell in the light pen senses the light of the electron beam and generates a signal. This signal is transmitted to the CPU, which relates the identified section of the image to the corresponding digital representation in the graphic program. Control may then be sent to a mainline program which performs some computations and alters the image on the CRT. At the same time, the computer may be programmed to create and maintain a data structure that contains all data pertinent to a design and the relationships between all elements of the design. Parameter values may be entered into this data structure by means of the alphanumeric keyboard, or they may be computed by subroutines activated by the light pen at the designer's request. In effect, the designer is constructing a complete digital description of a design in the computer's memory while he is simultaneously updating a pictorial representation of the design at the display console.

The alphanumeric keyboard can be used to enter information such as design parameter values into main storage. The function keys identify certain program-defined tasks. Each key has its own user-written interpretive subprogram stored in the computer's memory. When a key is pressed, a computer interrupt occurs, causing the key's assigned code to be transmitted to the computer.

Upon interpretation of this code, control is directed to the interpretive subprogram that performs the required task. For example, the function keys may be programmed to turn on and off, to enlarge or delete certain parts of the display, or to initiate input and output operations.

To illustrate how the operator at the graphic console interacts with the computer, consider the solution of a design problem. As the designer constructs an image on the CRT with the light pen, the computer simultaneously builds up a data structure—accepting data from the alphanumeric keyboard. Design data may be recalled at any time. By pressing a function key, a computational program may be invoked and the results displayed graphically for interpretation. If the design is unsatisfactory, the designer may recall the original display by means of the light pen or function keys and iterate through several cycles.

In programming a graphic unit, there are two basic modes: the vector mode which is used to display points and straight lines, and the character mode which is used to draw alphanumeric characters. Graphic orders used in coding the graphic program are of two kinds: data orders and control orders. Data orders specify absolute or relative vectors with the beam on or off. Control orders are used to control the sequence of execution of the orders in the graphic program; to load, store and test the contents of certain index registers, and to test the status of some hardware indicators.

Occasionally it is desirable to produce hard-copy output in graphical form. This is accomplished by equipping the system with one or all of the following: an x-y plotter, a digital drafting machine, or a recording unit. The recording unit may be used to trace the image on microfilm, in the same manner as the CRT display image is generated.

In computer-aided engineering design, it is often desirable to present information that already exists in pictorial form. This may be done by means of an optical scanner that reads graphical information and converts it into digital form for processing. During this scanning operation, the program controls the scanning pattern and the threshold level of light transmission.

### **Applying computer graphics to circuit analysis**

With a graphic data processing system it is no longer necessary for the circuit designer to set up equations or to transcribe the data into punched cards. The computer translates the graphical information into digital form, as required by the numerical procedures built into the program. The computer then performs the requested calculations and displays the results on the console CRT. Now a decision point is reached,

and the console operator intervenes. By the use of numerical analysis methods that are incorporated in the program, the computer "looks ahead," determines how changes in input parameters will affect the results, and suggests alternate approaches. The designer can easily make design changes, using a light pen and other manual input devices, and display the new results. The results may be obtained in the form of a graph, a table of values, or a drawing.

Graphic display devices are obviously most useful in engineering design applications that involve repetitive cycles of computation, analysis and parameter variation. For example, in designing an electronic circuit, the designer may draw the circuit schematics on the CRT and enter the value of each component via the alphanumeric keyboard. The voltage waveform produced by the circuit can be displayed beside the circuit diagram. Using the light pen and manual input features, the designer may then insert a new parameter value or delete a component. The new waveform resulting from the new circuit will be immediately displayed. Iterations can be continued through the program in this fashion—rapidly determining the variations in circuit response that correspond to variations in circuit parameters—until the designer arrives at his optimized design.

### Using graphic ECAP in circuit design

Consider the application of computer graphics to the design and analysis of electronic circuits. The Electronic Circuit Analysis Program<sup>1</sup> (ECAP) is an integrated system of programs developed to simulate an electronic circuit on the computer and to provide dc, ac, and transient analysis of electrical networks from a description of the network connections, from the position and

values of the electrical components, and from a description of the circuit excitation. Graphic ECAP<sup>2</sup> is a graphical extension to a 100-branch, 25-node, System/360 version of "1620 Electronic Circuit Analysis Program," using an IBM 2250 display unit for input and output. The program allows the designer to enter either a topological description of the circuit on punched cards or a circuit diagram on the graphic console CRT, and to display the desired result of the analysis in graphical form. The circuit diagram, input parameters, and desired results may be specified by using the light pen and alphanumeric keyboard. The main advantage of graphic ECAP is its ability to make circuit modifications rapidly and easily, and to obtain plotted results immediately.

Graphic ECAP thus enables the circuit designer to examine the performance of a circuit during the various stages of its design. Variations in circuit response caused by changes in circuit parameters can be rapidly determined. The effect of destructive excitation can be examined without destroying expensive circuit elements. And finally, measurements that are sometimes difficult to obtain with instruments can be made quite easily by computer.

The dc analysis program provides a steady-state solution of linear electrical networks. The designer can also obtain sensitivity coefficients, worst-case analysis, and standard deviation analysis of the network voltages. The ac analysis program provides a time-independent solution of linear electrical networks subject to sine-wave excitation. The transient analysis program offers the user a time response of an electrical network subject to user-specified driving functions. The program can handle nonlinear transient analysis problems by automatically switching branch parameter values, as a function of circuit currents and voltages.

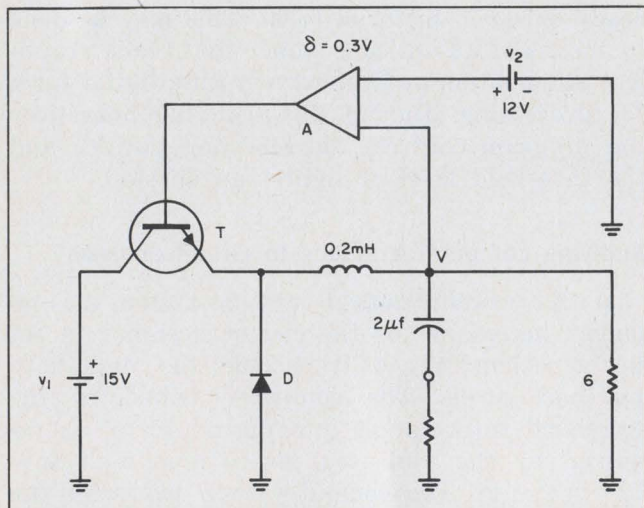

2. The voltage regulator circuit is analyzed to illustrate the use of graphic ECAP.

ELECTRONIC COMPONENT	STATE AND CONDITION	EQUIVALENT CIRCUIT
TRANSISTOR T	SATURATED $v \leq \delta$	
TRANSISTOR T	OFF $v > v_2 - \delta$	
DIODE D	NONCONDUCTING $v \leq \delta$	
DIODE D	CONDUCTING $v > v_2 - \delta$	
AMPLIFIER A	OFF $v \leq \delta$	
AMPLIFIER A	ON $v > v_2 - \delta$	

3. The equivalent circuit of the voltage regulator shown in Fig. 2 with trigger amplifier shown as S.

To illustrate the use of graphic ECAP, consider the voltage regulator circuit<sup>3</sup> of Fig. 2. The purpose of this circuit is to regulate a dc voltage  $V$  by alternately applying current from a power source  $v_1$  into a closed RLC circuit.

The circuit functions as follows: the power supply voltage  $v_1$  exceeds the voltage  $v_2$ ; the trigger amplifier  $A$  controls the state of the transistor  $T$ . When  $T$  is saturated, the trigger amplifier turns  $T$  off if  $V > v_2$ . When  $T$  is off, the trigger amplifier switches the transistor back to saturation if  $V > V_2 - \delta$ ,  $\delta$  being the hysteresis voltage of  $A$ . When  $T$  is turned off, the current through the inductor continues flowing. The return path is through the diode  $D$ , which goes from the blocked condition to saturation when  $T$  is turned off. When  $D$  changes state, the voltage across the inductor changes sign resulting in a reversal of the direction of the current. This allows the capacitor to charge and discharge alternately, and results in the oscillation of the voltage  $V$  about  $v_2$ .

In order to analyze the above circuit using graphic ECAP, it is necessary to supply the computer with an equivalent electrical circuit containing the standard electrical elements accepted by ECAP. Figure 3 shows the equivalent circuits for the transistor, diode and trigger amplifier. Note that the equivalent circuit for the trigger amplifier is simply the switch  $S$ . This illustrates how ECAP handles nonlinear transient analysis problems.

The manner in which the designer draws a circuit on the CRT is illustrated in Fig. 4. The component type is selected with the light pen from a list of options on the lower part of the screen. The component value is then entered via the alphanumeric keyboard. Figure 5 shows the complete equivalent circuit for the voltage regulator of Fig. 2. The dashed lines indicate the relationship between the switches. The computer automatically numbers the branches and nodes. Figure 6 illustrates the card-edit feature of graphic ECAP. The operator may request a card edit and cause the system to translate the circuit diagram into ECAP source statements. These are the same card statements that a designer using a nongraphic version of ECAP would have created as input.

To perform the analysis, the user may select a branch or node for current or voltage plot by pointing at the circuit diagram with the light pen. Figure 7 shows a plot of voltage for node 3. After viewing the results, the user may return to the panel displaying the circuit diagram or to the card-edit display, modify any portion of the input data, and observe the new results. The card-edit panel has facilities for altering a card, deleting a card, or inserting a new card. When the circuit designer is satisfied with a particular circuit,



4. Designer uses light pen to select components from a list of options shown at the lower area of the screen.

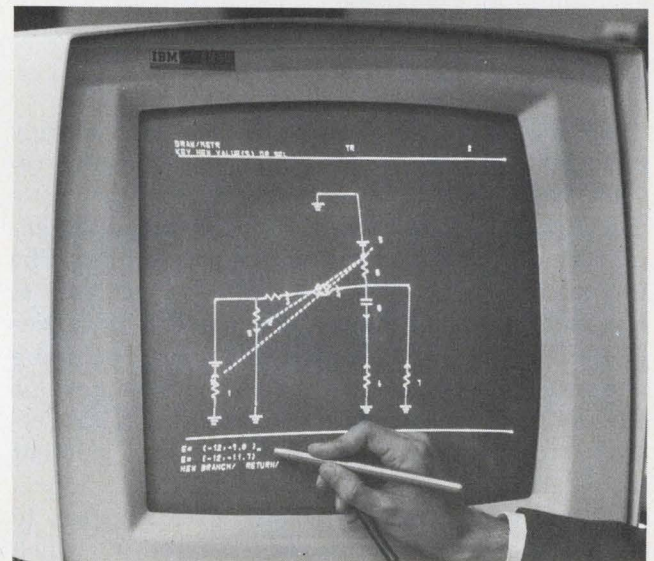

5. The graphic display of the equivalent circuit, with branches and nodes automatically numbered by the computer.

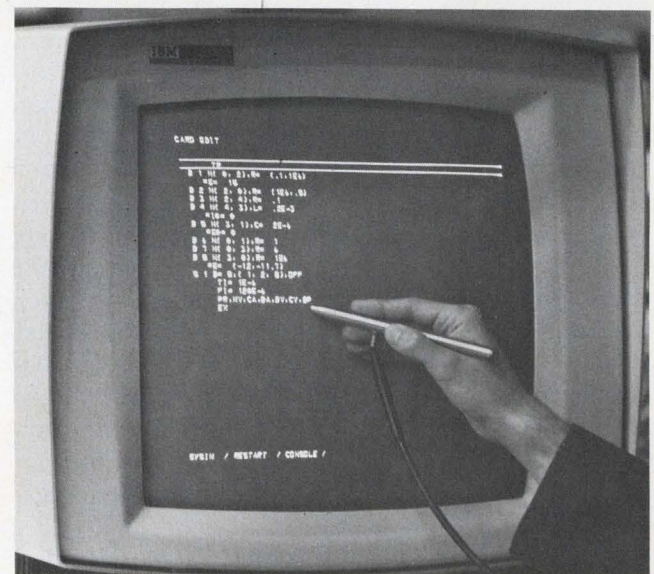

6. The operator may request a card edit to translate the circuit diagram into ECAP source statements.

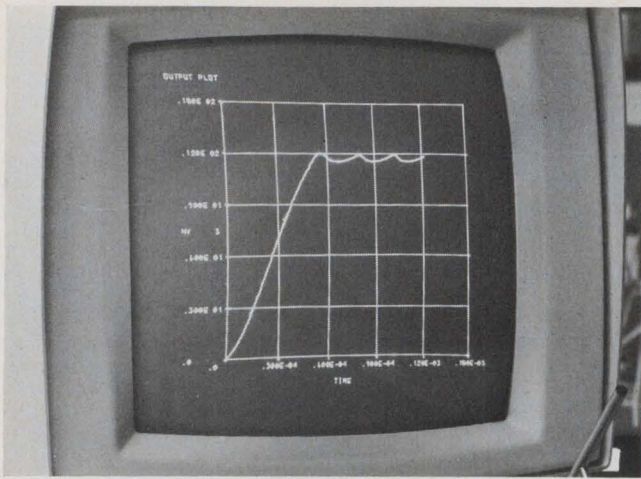

7. A plot of voltage for node 3 is displayed when the operator selects this node with his light pen.

he may request a complete printout of the analysis results on the system on-line printer.

### Let's discuss costs

The use of graphic display devices is relatively new, but application programs developed in recent years—mostly by research groups—have demonstrated the feasibility of accomplishing engineering design with computer graphics. The increasing demands on the design profession, coupled with continuous technological advances in the electronic data processing field, will more and more encourage use of interactive graphic devices. The most important advantages are reduced turn-around time; the ability to present pictorial input to the computer; graphical presentation of the results; faster user-response to errors, and increased program flexibility, which permits many iterations in a small amount of time.

Present drawbacks to wider use of graphic displays are the need for software support, the hardware cost and the designer's resistance to a change in methodology. The economics of employing a graphic console vary from application to application, and from place to place. Factors such as time savings, faster response to customer demands, and increased reliability of the design must also be considered in deciding whether or not a given application is practical. In recent years, the need to dedicate a powerful computer to control a display unit generally worked against justifying computer graphics applications on economic grounds. However, the increased availability of time-sharing systems and remote terminals are sure to have a benevolent effect on the acceptance of computer graphics for engineering design.

The monthly rental of a typical interactive display unit ranges from \$2000 to \$3000, depending on optional features. For a unit used for circuit

design and analysis, it is estimated that while a typical design session takes from one to one-and-a-half hours at the console, total design cycle time is reduced by several weeks—if the graphic approach replaces the conventional operation of a batch processing shop that has a one-day turn-around time. These are some of the factors to be considered in deciding whether or not purchase of the unit is justified.

Indications are that when applying the graphic tool to engineering design problems, the program requirements in terms of CPU time and core storage capacity are small during a design session, except for the occasional computational phase of the program. In a time-sharing environment, computer resources can be shared by many users; when one user is analyzing, the other is studying the latest results. Any period of zero demand may be used for processing the normal batched jobs. A second alternative is to attach a graphic display device to a small and inexpensive computer—one that nevertheless has the capacity and versatility to communicate rapidly and efficiently with the operator, and the capability to communicate with a large computer system, to satisfy the intermittent need for increased power and greater storage capacity required for the solution of complex design problems. ■■

### References:

1. 1620 Electronic Circuit Analysis Program (ECAP) *User's Manual*, Form No. H20-0170, International Business Machines Corporation.
2. C. W. Day Jr., G. R. Hogsett, D. A. Nisewanger and W. H. Malone, "2250 ECAP," *Program No. 360D-16.4.002*, April 1967.
3. C. T. Kleiner and E. D. Johnson, SPARC—System of Programs for Development and Analysis of Components and Subsystems by Recomp II, Autonetics Division, North American Aviation, Inc., Anaheim, California. *Report No. EM-3083*, Feb. 1962.
4. F. V. Windes, "Graphic Data Processing: A Description of IBM's System/360 Graphic Processing Components," *Graphic Science*, Dec. 1965, pp. 22-29.

### Test your retention

*Here are questions based on the main points of this article. Their purpose is to help you make sure you have not overlooked any important ideas. You'll find the answers in the article.*

1. Name three advantages of graphic displays for the design engineer.
2. How does the light pen perform its function in the graphic system?
3. How can hard-copy output be included in a graphic display system?
4. Name three present obstacles to wider applications of graphic displays.
5. At present, what are the monthly rental charges for a typical interactive display system?



GENERAL INSTRUMENT announces . . .

# CRYSTAL-CAP™

THE FIRST AND ONLY MYLAR\* CAPACITOR WITH "INTEGRAL-BODY-LEAD CONSTRUCTION" PROVIDES RELIABILITY AND PERFORMANCE STANDARDS UNMATCHED IN THE INDUSTRY.

To: General Instrument Corporation, Capacitor Group  
65 Gouverneur Street, Newark, N.J. 07104

I'll test it. Send me the free sample of a CRYSTAL-CAP Mylar capacitor and complete specifications.

Name \_\_\_\_\_

Title \_\_\_\_\_

Company \_\_\_\_\_

Address \_\_\_\_\_

City \_\_\_\_\_ State \_\_\_\_\_ Zip \_\_\_\_\_

## test it!

You really have to **see** the CRYSTAL-CAP capacitor to believe it. It's a pure capacitor! Nothing but Mylar and ultra-pure aluminum fused with the leads into a solid integrated unit.

But, wait until you **test** it! You'll think your instruments have gone sour. The insulation resistance will be much too high . . . The dissipation factor much too low . . . Stability far superior . . . And those terminals! No three pound weakling here. One million tests have proved it takes up to 15 pounds to break the bond.

The CRYSTAL-CAP is a **better** Mylar capacitor. The best you can buy . . . And only fractions of a cent more than conventional wrap-and-fill types.

Ratings from .001 to 1.0  $\mu$ F . . . 50 to 600 volts . . . Tolerances from  $\pm 20\%$  to  $\pm 1\%$  . . .  $-55^{\circ}\text{C}$  to  $+125^{\circ}\text{C}$ .

Prove it for yourself. Send the coupon to General Instrument Corporation, Capacitor Group, 65 Gouverneur St., Newark, N.J. 07104.

\*Mylar is a registered DuPont trademark

# capacitors



See us at Plaza Suite 537

# Tackle your switching circuit designs

with this easy-to-use technique. It provides optimum coupling between stages and takes noise and drift into account.

Transistor switching circuits are frequently designed using worst-case techniques, which take into account the effects of all parameter tolerances. Very often the use of such techniques is unjustified, because their advantages can be nullified by practical considerations, such as an imprecise load specification.

The following switching circuit design technique offers a useful alternative to conventional worst-case methods. Although relatively simple to employ, the method provides optimum coupling between stages and an optimum collector load for the driving stage. Furthermore, it allows an almost arbitrary selection to be made of the reverse-bias potential for the base of the transistor that is OFF. Rejection of noise and drift can therefore be included in the design. The method also includes the leakage current from the base of OFF transistors; it thus can be used for silicon or germanium devices at any power level.

## Various circuit configurations are covered

A variety of switching circuit types can be accommodated (Fig. 1). The most general case, where each base is driven from more than one collector, is shown in 1a. (A variation that allows driving more than one base from each collector will be considered later). The special case, where each collector drives only one base and where each base is driven from only one collector, is shown in 1b. The symbols used in Fig. 1 will retain their meanings throughout the discussion. That is,  $V_{CC}$  is the collector power supply;  $V_{BB}$  is the base-bias supply;  $R_L$  is the collector load resistor;  $R_B$  is the coupling resistor; and  $R_C$  is the base turn-off resistor.

In these diagrams, and in those that follow, no polarities are assigned to power supplies, and currents and voltages are polarized only by the diagram arrows. This allows voltages and currents to be handled as magnitudes, so that all results are equally applicable to npn or pnp tran-

sistors. It is necessary only to state that  $V_{CC}$  and  $V_{BB}$  have opposite polarities.

## Q1 either saturated or off

As shown in Fig. 1a, the driven transistor,  $Q1$ , will always be conducting at saturation if any one of the driving transistors is turned off. For example, base current is available for  $Q1$  through  $R_{L1}$  and  $R_{B1}$  if  $Q2$  is off. On the other hand,  $Q1$  will always be cut off, with its base-emitter junction reverse biased, if, and only if, each of the driving transistors is conducting and saturated.

The flow of current when  $Q1$  is off is shown in Fig. 2. Here,  $R_B/N$ , connected to one transistor collector, represents  $N$  resistors of magnitude  $R_B$  that are connected to  $N$  collectors of  $N$  conducting transistors. This representation assumes that the saturated collector-emitter voltage drop is identical for each of the  $N$  transistors, and that the worst-case value is used. This is a necessary assumption, if allowance is to be made for substitution of transistors during field maintenance.

As shown in Fig. 2, current flows through  $R_B/N$  in a direction that tends to turn  $Q1$  on, inasmuch as the potential of the driving collector is always higher than that of the back-biased base. Leakage current  $I_{CO}$  flows across the collector-base junction and would tend to turn on  $Q1$  if it crossed the base-emitter junction. Both of these spurious turn-on currents are drained off by  $R_C$  to the base bias supply  $V_{BB}$ .

When one driving transistor is off, so that its collector potential rises toward  $V_{CC}$ , currents flow as shown in Fig. 3. The base of  $Q1$  is usually at a higher potential than that of the conducting transistor collectors; thus, driving current is lost, as shown, through  $R_B/(N-1)$ .  $R_C$  has no useful function when  $Q1$  is on; in fact, driving current is lost through it to  $V_{BB}$ . The remainder of the current from  $V_{CC}$ , through  $(R_L + R_B)$ , is  $I_B$ , which is the base current useful for turning on  $Q1$ . Note that Fig. 3 assumes no current is lost as leakage at the collector junction of  $R_L$  and  $R_B$ . This is an approximation that is almost always valid, but which could require a special calculation for



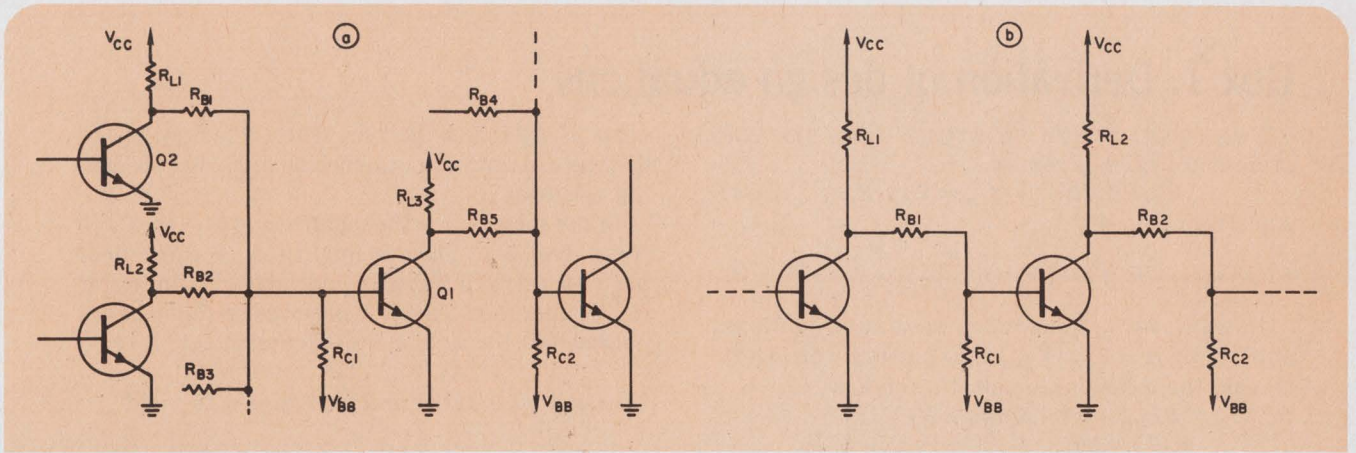

1. The most general switching-circuit configuration has one base driven by more than one collector (a). A special

case (b) has each collector driving only one base and each base driven from only one collector.

very low power applications.

The bias conditions on which the coupling network design parameters are based are shown in Fig. 4. In Fig. 4a,  $Q1$  is off, so its base-emitter junction is back-biased. In Fig. 4b,  $Q1$  is on, and  $I_B$  is supplied to its forward-biased base-emitter junction.  $R_B$ ,  $R_L$ , and  $R_C$  are, in general, not known. All the other parameters are known, or can be determined simply, as follows:

- $V_F$  is the magnitude of the difference between the manufacturer's maximum saturated collector-emitter voltage specification and the base potential of  $Q1$  when it is off. The base potential is chosen by the designer to achieve a desired noise margin and turn-off time. Its selection has little to do with the dc design of the coupling network. The dc design discussed here assures that the chosen base potential will be achieved for the maximum leakage condition.

- $I_{CO}$  is the manufacturer's specified collector-base leakage current at the highest operating temperature.

- $V_{BF}$  is the magnitude of the difference between  $V_{BB}$  and the OFF base-potential. Note that  $V_{BB} > V_{BF}$ . Although  $V_{BB}$  is often not under the circuit designer's control, it is roughly true that  $V_{BB}$  should be made as large as feasible.

- $V_N$  is the difference between  $V_{CC}$  and the manufacturer's specified maximum forward base-

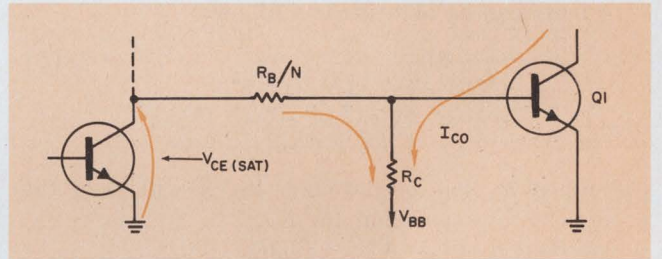

2. The OFF state of  $Q1$  occurs when all driving transistors are conducting into saturation.

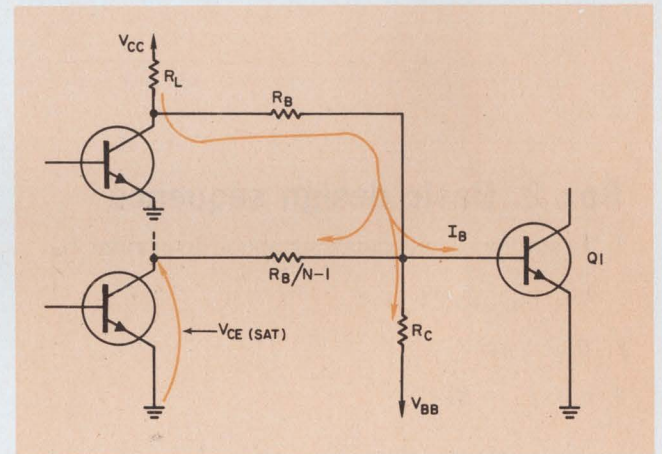

3. The ON state of  $Q1$  occurs when any one of the driving transistors is cut off.

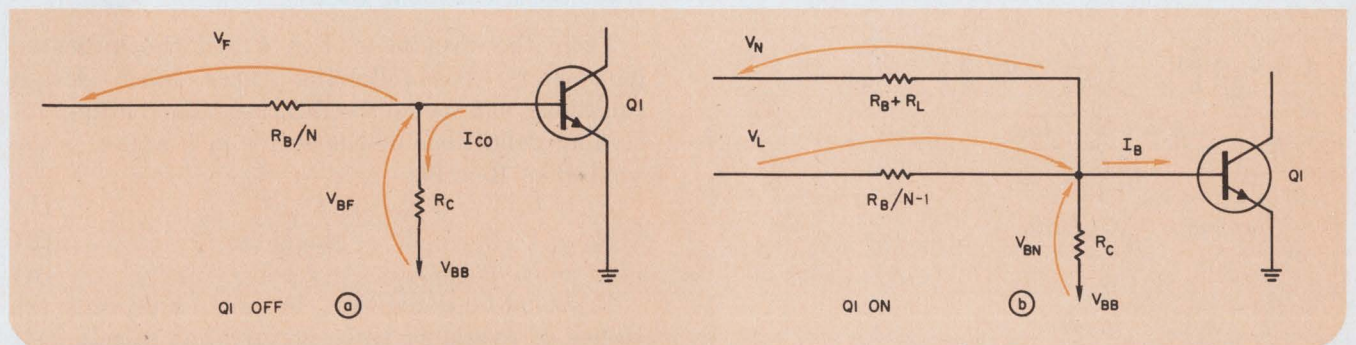

4. The design parameters are derived from these representations of  $Q1$  in the OFF state (a) and ON state (b).

## Box 1. Derivation of design equations

Two equations can be written from the diagrams of Fig. 4. From 4a,

$$[V_F/(R_B/N)] + I_{CO} = V_{BF}/R_C \quad (4)$$

And from Fig. 4b,

$$[V_N/(R_B + R_L)] - [V_L/(N-1)] - I_B = V_{BN}/R_C$$

By eliminating  $R_C$  between these two equations, and letting  $B = V_{BN}/V_{BF}$ , some algebraic drudgery reveals the following quadratic for  $R_B$ ;

$$R_B^2(I_B + BI_{CO}) + R_B[NBV_F + R_L \times (I_B + BI_{CO}) - V_N + V_L(N-1)] + R_L[NBV_F + V_L(N-1)] = 0$$

This is in the form of  $aR_B^2 + bR_B + c = 0$ , for which  $R_B = (-b \pm \sqrt{b^2 - 4ac})/2a$ , and the coefficients can be identified as follows:

$$\begin{aligned} a &= I_B + BI_{CO} \\ c &= [NBV_F + V_L(N-1)]R_L \\ b &= (c/R_L) + R_L(I_B + BI_{CO}) - V_N \\ \text{or, } b &= -[V_N - (c/R_L + aR_L)] \end{aligned} \quad (5)$$

When  $R_B$  has been found, Eq. 4 will yield the following expression for  $R_C$ ;

$$R_C = R_B V_{BF}/(NV_F + I_{CO}R_B)$$

However, a value for  $R_L$  must be found before  $R_B$  can be determined.  $R_L$  is sometimes fixed by the specification, or by other considerations generally unrelated to the coupling to  $Q1$ . The designer must be able to determine whether the specified

value of  $R_L$  is feasible; or, where it is not specified, he usually wants to maximize  $R_L$  for switching efficiency.

In the solution for the quadratic,  $(b^2 - 4ac) \geq 0$  for a real  $R_B$ . This inequality is a convenient means for determining an allowable maximum for  $R_L$ . Setting the inequality in terms of the network parameters for  $a$ ,  $b$ , and  $c$  results in

$$[V_N - (c/R_L + aR_L)]^2 \geq 4aR_L c/R_L$$

This can be squared and rearranged to yield

$$R_L \leq [V_N + (c/R_L) \pm 2\sqrt{V_N(c/R_L)}]/a$$

$$\text{or } R_L \leq [\sqrt{V_N} \pm \sqrt{(c/R_L)}]^2/a$$

Note here that  $c/R_L$  is independent of  $R_L$  (Eq. 5).

The equations for  $R_B$  and  $R_L$  involve an ambiguity; namely, that it is not obvious whether to take the positive or the negative square root. This has been resolved empirically to yield the three basic design equations:

$$R_L \leq (\sqrt{V_N} - \sqrt{c/R_L})^2/a$$

$$R_B = (-b + \sqrt{b^2 - 4ac})/2a$$

$$R_C = R_B V_{BF}/(NV_F + I_{CO}R_B)$$

Note that if  $R_L$  takes its maximum value, then  $(b^2 - 4ac) = 0$ , and  $R_B = -b/2a$ .

## Box 2. Basic design sequence

1. From load and transistor specs determine  $I_B$ ,

$$V_F, V_{BN}, \text{ and } V_{BF}$$

2.  $B = V_{BN}/V_{BF}$

3.  $a = I_B + BI_{CO}$

4.  $\frac{c}{R_L} = NBV_F + V_L(N-1)$

5.  $R_L \leq \frac{(\sqrt{V_N} - \sqrt{c/R_L})^2}{a}$

6.  $b = -[V_N - (c/R_L + aR_L)]$

7.  $R_B = \frac{-b + \sqrt{b^2 - 4ac}}{2a}$

$$\text{Note: } ac = \frac{c}{R_L} \times aR_L$$

8.  $R_C = \frac{V_{BF} R_B}{NV_F + I_{CO} R_B}$

emitter voltage. Note that  $V_{CC} > V_N$ .

- $V_L$  is the difference between the manufacturer's saturated collector-emitter voltage and the forward base-emitter voltage.

- $V_{BN}$  is the difference between  $V_{BB}$  and the forward base-emitter voltage. Note that  $V_{BB} < V_{BN}$ .

- $I_B$  is selected by the designer to allow for degradation of transistor dc beta with time or temperature, and to accommodate power supply variations that might reduce  $I_B$ .

- $V_{BB}$  and  $V_{CC}$  are nominal voltages.

### Three basic equations used

From the circuits of Fig. 4 and the indicated parameters, the following three basic design equations can be derived (their derivation, including definitions of the terms  $a$ ,  $b$  and  $c$ , is described in Box 1):

$$R_L \leq (\sqrt{V_N} - \sqrt{c/R_L})^2/a \quad (1)$$

$$R_B = (-b + \sqrt{b^2 - 4ac})/2a \quad (2)$$

$$R_C = R_B V_{BF}/(NV_F + I_{CO} R_B) \quad (3)$$

It should be noted that, in most cases, only the values of available resistors prevent selection of the maximum value of  $R_L$ .

To apply Eqs. 1 through 3 in a particular design, the designer begins by calculating the terms  $a$  and  $c/R_L$ , as follows:

$$a = I_B + BI_{CO}$$

$$c/R_L = NBV_F + V_L(N - 1)$$

$V_N$  can then be selected, if it has not been specified, so that  $V_N > c/R_L$ . Then,  $R_L$  can be calculated from Eq. 1. and  $R_B$  and  $R_C$  from Eqs. 2 and 3, respectively.

The complete sequence of design steps is summarized in Box 2. An actual design example using the technique is given in Box 3.

### Variations are sometimes required

For certain types of applications, variations in the basic design procedure are required. These variations are as follows:

■ If  $R_L = 0$ , as occurs when the driving source is an emitter follower or a contact closure,

$$R_B = [V_N - (c/R_L)]/a$$

In these cases,  $V_F$  will require a new calculation that will depend on the particular driving network.

■ Logic designs often require a cascade of identical stages, so that  $R_{L1} = R_{L2} = R_{Lu}$ . In these cases,

$R_{Lu} = [(\sqrt{V_N} - \sqrt{c/R_{Lu}})^2 - V_{CC}/H_{FE}]/BI_{CO}$   
 $H_{FE}$  in this equation is minimum dc current gain. Also,  $c/R_L = c/R_{Lu}$ . The other parameters are as previously defined.

■ When identical stages are cascaded so that all  $R_L$ s are equal, and it is further required that  $R_{B1} = R_{B2} \dots = R_{Bu} = R_{Lu}$ ,

$$R_{Bu} = \frac{V_N - 2[V_L(N - 1) + NBV_F + (V_{CC}/H_{FE})]}{2BI_{CO}}$$

Also, if  $R_B$  and  $R_L$  must be equal to each other, but not necessarily equal to their counterparts in adjacent stages,

$$R_B = [V_N - 2(c/R_L)]/2a$$

$R_L$ , here, is obtained from Eq. 1.

It is obvious that these two variations sacrifice all optimum coupling considerations for a particular uniform appearance. They are not, therefore, expected to be of great utility, except under special circumstances.

■ To fan out from one collector to  $M$  bases, each of which has  $N$  inputs, first determine  $D = R_L/R_B$  for each of the  $M$  outputs. Select the smallest  $D$  ratio, and adjust all the other  $D$ s to this value, keeping the sum  $R_L + R_B$  constant in each case. Then combine the resulting  $MR_L$ s into one load for the single driving collector. This adjustment has the effect of maintaining each  $I_B$  at its design value; but each base whose  $D$  ratio is changed is reverse-biased more than the design value when it is cut off. Each adjustment represents a loss in switching efficiency, because each of the adjusted stages is effectively driven by an  $R_L$  that is smaller than the optimum. ■■

### Box 3. Design example

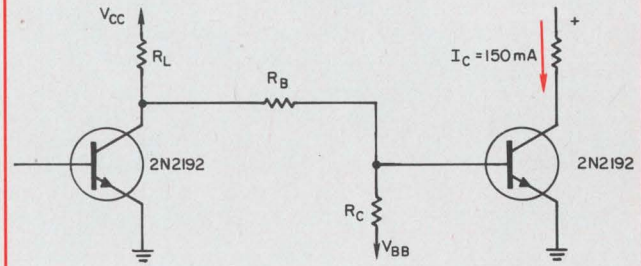

- (a)  $V_{CC} = +17$  V
- (b)  $V_{BB} = -15$  V
- (c) Back-bias the base by 0.5 V when OFF
- (d)  $V_F = 0.5 + V_{CE(SAT)}$   
 $= 0.5 + 0.35 = 0.85$

1.  $I_B = \frac{I_C}{H_{FE}} = \frac{150}{10} = 15$   
 $V_N = V_{CC} - V_{BE} = 17 - 1.3 = 15.7$
2.  $B = \frac{16.3}{14.5} = 1.12$
3.  $a = 15 + 1.12(0.015) = 15.02$
4.  $\frac{c}{R_L} = 1.12 \times 0.85 = 0.952$
5.  $R_L \leq \frac{(\sqrt{15.7} - \sqrt{0.952})^2}{15.02} = 0.593$ ; use 560  $\Omega$
6.  $b = -[15.7 - (0.952 + 15.02 \times 0.56)] = -6.35$
7.  $R_B = \frac{6.35 + \sqrt{(6.35)^2 - 4 \times 0.952 \times 15.02 \times 0.56}}{2 \times 15.02}$   
 $= 0.304$ ; use 300  $\Omega$
8.  $R_C = \frac{14.5 \times 0.3}{0.85 + 0.015 \times 0.3} = 5.12$ ; use 5.1 k $\Omega$

### Test your retention

Here are questions based on the main points of this article. Their purpose is to help you make sure you have not overlooked any important ideas. You'll find the answers in the article.

1. What adjustments must be made in this design technique to accommodate both npn and pnp transistors?
2. Is the design technique described suitable only for use with grounded-emitter driving stages?
3. How does the technique allow design latitude in rejection of noise and drift?



# When you come to power, you can count on our Joules.

DELCO SILICON TRANSISTOR TYPES	PEAK ENERGY RATING (Min.)	CONDITIONS	
		(Volts)	(Amperes)
DTS-103-107	1.6 Joules	40V	4 A
DTS-402	540 mJ	200V	9 A
DTS-423	105 mJ	300V	3.5A
DTS-424	228 mJ	325V	3.5A
DTS-425	131 mJ	375V	3.5A
DTS-431	300 mJ	200V	0.3A
2N3902	105 mJ	300V	3.5A
2N5241	300 mJ	200V	0.3A

Ratings derived from safe operating curves.

Joules of energy, that is. High energy reliability is an extra ingredient found in Delco silicon power transistors. It's because we design our transistors to have greater peak energy capability—to be able to withstand higher surges of voltage and current for a specified time. And we prove it. One hundred percent Pulse Energy Testing verifies all of our safe operating curves. That's why Delco triple diffused silicon power transistors have earned a reputation for survival in the toughest of switching jobs.

**SEMICONDUCTOR DISTRIBUTORS: EAST**—BALTIMORE, MD. 21201, Radio Electric Service Co., 5 North Howard St., (301)-539-3835 BINGHAMTON, N.Y. 13902, Federal Electronics, Inc., P. O. Box 1208, (607)-748-8211 CLIFTON, N.J. 07015, Eastern Radio Corporation, 312 Clifton Avenue, (201)-471-6600 NEWTON, MASS. 02195, The Greene Shaw Co., Inc., 341-347 Watertown St., (617)-969-8900 NEW YORK, NEW YORK 10036, Harvey Radio Co., Inc., 2 West 45th St., (212)-582-2590 PHILADELPHIA, PENN. 19114, Almo Electronics, Division of Sterling Electronics, Roosevelt Blvd. at Blue Grass Rd., Northeast Industrial Park, (215)-676-6000 PITTSBURGH, PENN. 15328, RPC Electronics, 620 Alpha Drive, RIDC Park, (412)-782-3770 WOODBURY, L.I., N.Y. 11797, Harvey Radio Company, Inc., 60 Crossways Park West, (516)-921-8700 **SOUTH**—BIRMINGHAM, ALA. 35233, Forbes Distributing Company, Inc., 1416 Fourth Ave., South, (205)-251-4104 MIAMI, FLORIDA 33142, Mountain Electronics, Division of Mountain National Co., 3730 Northwest 36th St., (305)-634-4556 RICHMOND, VA. 23220, Meridian Electronics, Inc., 1001 West Broad Street, (703)-353-6648 WEST PALM BEACH, FLA. 33402, Mountain Electronics, Division of Mountain National Co., 1000 N. Dixie Highway, (305)-833-5701 **MIDWEST**—CINCINNATI, OHIO 45237, United Radio, Inc., 7713 Reinhold Drive, (513)-761-4030 CLEVELAND, OHIO 44125, The W. M. Pattison Supply Co., Industrial Electronics Division, 4550 Willow Parkway, (216)-411-3000 INDIANAPOLIS, IND. 46225, Graham Electronics Supply, Inc., 122 South Senate Avenue, (317)-634-8486 KALAMAZOO, MICH. 49005, Electronic Supply Corp., P.O. Box 831, (616)-381-4626 KANSAS CITY, MO. 64111, Walters Radio Supply, Inc., 3635 Main Street, (816)-531-7015 MINNEAPOLIS, MINNESOTA 55401, Stark Electronics Supply Co., 112 3rd Ave., North, (612)-332-1325 SKOKIE, ILL. 60076, Merquip Electronics, Inc., 7701 N. Austin Ave., (312)-282-5400 ST. LOUIS, MO. 63144, Electronic Components for Industry Co., 2605 South

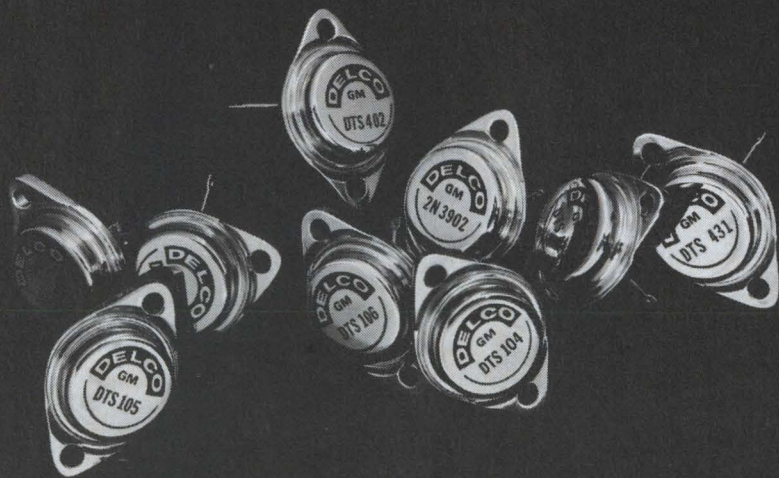

If your circuit involves inductive switching or is subject to transients, be sure to analyze the load line and specify your transistor energy requirements. Then, talk to the Kokomoans, the high energy people. They'll understand your need for Joules.

For information on power transistor load line analysis, ask for our Application Note No. 41.

For assured high energy capability in silicon power transistors, always specify Delco.

#### Kokomoan's Regional Headquarters

Union, New Jersey\* 07083  
Box 1018 Chestnut Station  
(201) 687-3770

Chicago, Illinois\* 60656  
5151 N. Harlem Avenue  
(312) 775-5411

Santa Monica, Calif.\* 90401  
726 Santa Monica Blvd.  
(213) 870-8807

Syracuse, New York 13203  
1054 James Street  
(315) 472-2668

Detroit, Michigan 48202  
57 Harper Avenue  
(313) 873-6560

Kokomo, Ind. 46901  
700 E. Firmin  
(317) 459-2175 Home Office

\*Office includes field lab and resident engineer for application assistance.



THE KOKOMOANS ARE IN POWER

# DELCO RADIO

DIVISION OF GENERAL MOTORS

KOKOMO, INDIANA

Hanley Road, (314)-647-5505 WEST—ALBUQUERQUE, N.M. 87108, Hyer Electronics Company, 130 Alvarado Drive, N.E., (505)-265-5767; 87106 Sterling Electronics Inc., 1712 Lomas Blvd., N.E., (505)-247-2486 COLORADO SPRINGS, COLO. 80902, L. B. Walker Radio Co., 9 E. Vermijo St., (303)-636-1661 DALLAS, TEXAS 75201, Adleta Electronics Company, 1907 McKinney Ave., (214)-742-8257 DENVER, COLO. 80219, L. B. Walker Radio Company, 300 Bryant Street, (303)-935-2406 ENGLEWOOD, COLORADO 80110, Hyer Electronics Company, 8101 E. Prentice Ave., (303)-771-5285 FORT WORTH, TEXAS 76102, Adleta Electronics Co., S. Expressway at E. Vickery, (817)-336-7446 HOUSTON, TEXAS 77001, Harrison Equipment Co., Inc., 1422 San Jacinto Street, (713)-224-9131 LOS ANGELES, CAL. 90015, Radio Products Sales, Inc., 1501 South Hill Street, (213)-748-1271 LOS ANGELES, CAL. 90022, Kierulff Electronics, Inc., 2585 Commerce Way, (213)-685-5511 OKLAHOMA CITY, OKLAHOMA 73102, Radio, Inc., 903 North Hudson, (405)-235-1551 PALO ALTO, CAL. 94303, Kierulff Electronics, Inc., 3969 East Bayshore Road, (415)-968-6292 PHOENIX, ARIZ. 85005, Sterling Electronics, Inc., 1930 North 22nd Ave., (602)-258-4531 SALT LAKE CITY, UTAH 84115, Hyer Electronics Company, 1425 South 2nd West, (801)-487-3681 SAN DIEGO, CAL. 92101, Milo of California, Inc., 2060 India Street, Box 2710, (714)-232-8951 SEATTLE, WASH. 98108, Kierulff Electronics, Inc., 5940 6th Ave., South, (206)-763-1550 TACOMA, WASH. 98402, C & G Electronics Company, 2502 Jefferson Ave., (206)-272-3181 TULSA, OKLAHOMA 74119, Radio, Inc., 1000 South Main Street, (918)-587-9124 CANADA—SCARBOROUGH, ONTARIO, Lake Engineering Co., Ltd., 123 Manville Rd., (416)-751-5980

## Don't argue, discuss. Nobody wins an argument. But you can win a discussion, if you learn to listen to the other person first.

Communicating is a snap for you. You have no problem presenting your ideas to indifferent, even hostile listeners. They always grasp your logic. They always agree with you. Right?

If so, skip this article. If not, let's take a close look at a most common form of communication—the conversation. In this example, you are trying to explain an idea of yours to Mr. Smart. He thinks his idea is better. That's where you start.

But it may not be where you finish. Without your even being aware of it, a misunderstanding or a disagreement can easily turn this exchange into an argument. And nobody wins an argument.

To illustrate how to use these steps, let's assume Mr. Smart does not accept your idea the first time you offer it.

### Start by listening

Here's the situation: You are telling a group how to follow a new policy. What you are telling them is not at issue now; *how* you do it is. For no matter how good your points are, they may well be rejected if you cannot present them effectively.

Okay, you're talking to the group when Mr. Smart suddenly speaks up. He doesn't agree.

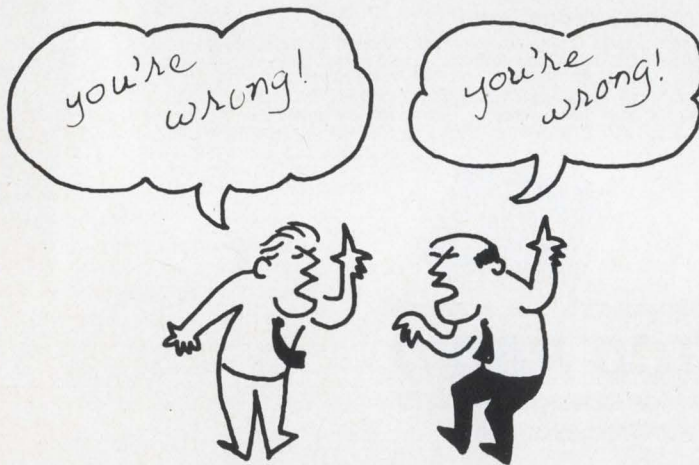

When you argue, nobody wins.



Listen closely to the other man's views.

To make sure that your conversation remains an intelligent exchange and to bring Mr. Smart around to your way of thinking, take these four steps when you respond to his objections:

1. Understand Mr. Smart's views.
2. Comment on his views.
3. Present your own ideas.
4. Control interruptions.

Here you take the first step. You listen to him. Don't interrupt.

Get a clear picture of Mr. Smart's thoughts. For unless you really know his views, you can't comment intelligently on them. Most likely, the stronger he disagrees with you, the more he'll talk about it.

So the first step is quite simple: just listen. Carefully and politely. Don't break in on him, except to agree with his thoughts. This will let him know you're paying attention.

Simple as it sounds, this first step serves a

---

Raymond E. Herzog, Electronics Engineer, Daytona Beach, Fla.

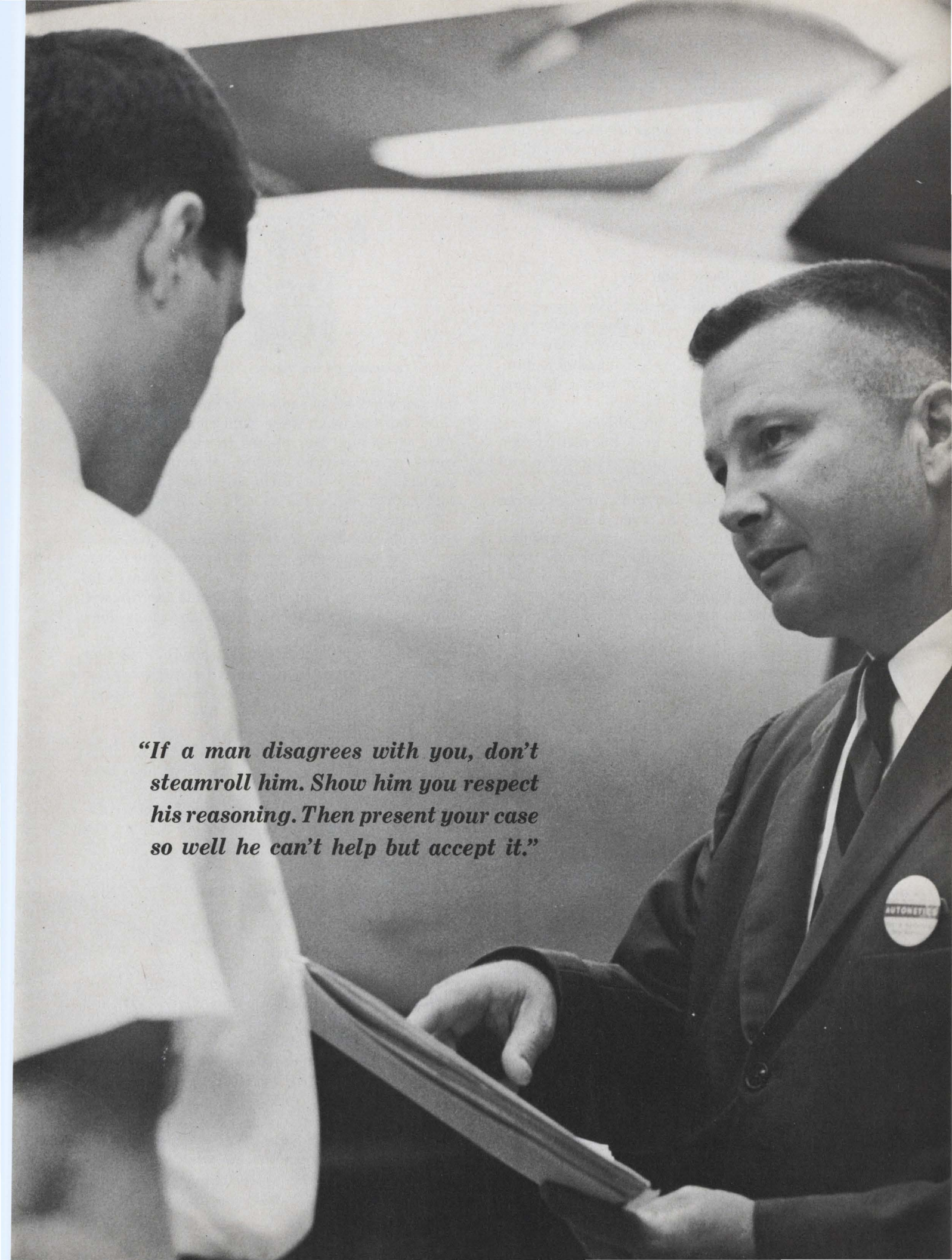

*“If a man disagrees with you, don’t steamroll him. Show him you respect his reasoning. Then present your case so well he can’t help but accept it.”*

dual purpose. First, you get to know Mr. Smart's ideas. Thus, when you get to Step 3 (which is where you will present your own thoughts again), you can focus on what *he* has just said, not on what you *expected* him to say. Second, by courteously listening, you show Mr. Smart you respect him and are not trying to steamroll him. You've also probably earned his respect—and his silence—when you are ready to speak.

### Tell him what you heard him say

After Mr. Smart has spoken his piece, you take the second step and say a few words yourself. What words? Well, surprisingly, your first remark should be a restatement of his objection. But you recount it in your own words. Repeat: his opinion, your words.

When Mr. Smart hears his objection coming from you in your words, he'll know that you understand him. This will allay his anxiety and he should be ready to listen to your side.

When you repeat his thoughts, try to agree with some point—any point, even a small one—that he made. Your agreement again shows him that you respect his reasoning. Also, by first agreeing on a point, you will soften the impact of your views, the third step. This creates a less argumentative atmosphere and induces far more cooperation.

Why pay so much attention to the atmosphere? Remember that your purpose is to compare Mr. Smart's thoughts with your own. The goal is mutual understanding. To achieve it, you can't merely present facts and force him to accept them. Instead, you build a series of agreements with him and let him come to his own decision.

### Now offer your views

Up to now you've held Mr. Smart's attentive ear while he listened to his thoughts as you restated them. Your next move is to keep his interest while you offer your views. Here is where you need to watch your words carefully.

First, show that there is more to the matter than just the views (his views) brought out so far. Now it's time to approach the points of disagreement. But present your comments and thoughts cautiously. A good way to lead into your views is:

"I see your viewpoint, but you also may want to consider these additional thoughts." And then you relate some ideas that will help him to see your attitude more clearly.

Other approaches you might use are:

"Perhaps if you thought about it this way . . ."

"Let's think this matter through together."

"John Doe once thought the same way. Let me

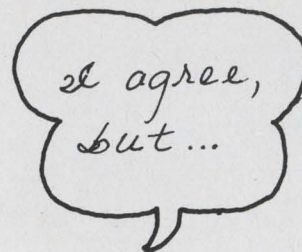

Comment on his views, present your own.

tell you what he learned that changed his mind."

Do you see what these approaches are doing? They're leading Mr. Smart to rethink his own views, or to consider additional points. They're suggesting that he form his own conclusion, rather than be forced to accept yours.

Conversely, the incorrect way to lead into your comments would be to tell Mr. Smart that he is wrong. Instead, suggest that there might be another way to look at the matter. Tell him *what* could be wrong. Then, he can decide for himself, and remember that his own decision means more to him than yours.

It's important that you take enough time over each point you make. Pause after each one, so that it will sink in. To check that Mr. Smart understands you, try questions like:

"Is that point clear?"

"You agree with that, don't you?"

These questions will move the discussion back and forth.

Another way to make a convincing presentation is to deliver it with plenty of action. For example, when you are giving facts or descriptions about something, make them *move*. Don't just show a chart or diagram—draw or sketch it as you talk.

### Handle the interruptions

So far, you've gained an understanding of Mr. Smart's differing opinion, commented on it, and then presented your own views. Most likely, Mr. Smart will be almost fully sold by this time. One possible problem yet remains. This is the matter of interruptions which he is quite apt to make. He may interrupt, unless he, too, is a good listener.

But if he isn't, he may pop questions, or he may throw out objections to what you say—sometimes before the words are out of your mouth. Whatever the interruptions, having to



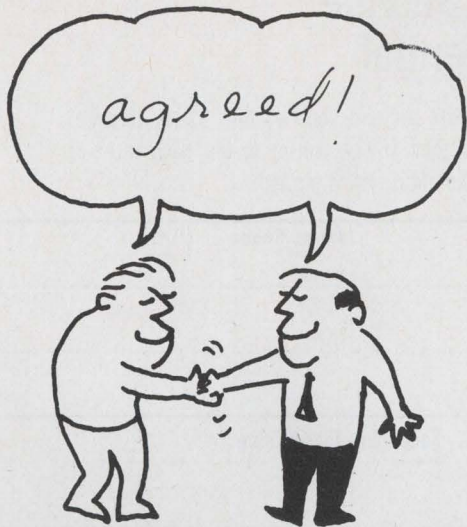

Logic plus psychology often spell agreement.

stop in the middle of your presentation can weaken your case.

How can you avoid interruptions that sidetrack the discussion? When Mr. Smart asks a question that you can answer later, tell him so. Let him know that you recognize his reasons for asking, and say that he will be able to better understand the matter after you've given him more information in the discussion.

On the other hand, if you feel that Mr. Smart is contradicting you just to be objectionable, try this. Pause briefly, and then quickly give your reply in less than half a minute. When you pause, don't seem to be in a hurry. Know what you're going to say and when you do speak, speak quickly. Then go right on from where you left off before the interruption. The brief silence may well disconcert Mr. Smart.

Still another cooling-off technique is to take a deep breath, fix your eyes directly on him and say: "Mr. Smart, I don't think I fully understand what you're saying." As he recollects his thoughts and tells you once more, his answer may come in a softer tone than it did before.

People who use this technique have found that sometimes the pause will unnerve an aggressive person. To break the silence, he will say something and, quite often, will thereby answer his own objection.

When it looks like interruptions are imminent and will require immediate answers, here is one more technique. Use the familiar "yes, but" and "yes, and" answers. In these replies, you compare what Mr. Smart has just said with one of the selling points of the idea you're trying to get across.

A sharp contrast can be made with a "yes, but" statement. In it, you turn his reason for not accepting your idea into a reason why he shouldn't be without it. To illustrate: When the objection is, "I don't have time to do this," you can suggest: "Yes, it's possible that you may

not have the time to do this, *but* do you have time to do. . . ." Here you mention time-consuming chores that he could avoid by doing what you suggest. This type of question prompts Mr. Smart to reconsider.

There may be times, however, when the "yes, but" reply is too strong, since the word "but" can be quite explosive. So, another, softer approach might be the "yes, and" answer. Let's say that Mr. Smart's objection is: "It's not the usual responsibility of my group to do this." Your reply would be: "Yes, you're right. It isn't your responsibility, *and* for that reason your group should receive unique recognition for having done it." Then go on to tell about the benefits of performing this unusual task; in other words, you justify the undertaking. The subject thus changes from an excuse for not doing something to the advantage derived from doing it.

Looking back to the paragraph where we discussed handling interruptions, you'll recall that we talked about a person being "almost fully sold" on something. Let's take a closer look at that word "sold". For when the purpose of a discussion is to get an idea across without an argument, "selling" Mr. Smart on the idea really isn't quite the right technique.

Rather, you should tell him things that start him thinking—thinking that there might be more to a matter than just what he sees at first. Then, when he considers, understands, and finally accepts your views, he has really *sold himself* on your idea.

The point was made long ago by the English poet Samuel Butler:

"He that complies against his will  
Is of the same opinion still." ■■

### Test your retention

Here are questions based on the main points of this article. Their purpose is to help you make sure you have not overlooked any important ideas. You'll find the answers in the article.

1. What are the four steps to take to persuade someone who disagrees with you?
2. Why shouldn't you interrupt while someone is explaining his viewpoint?
3. How should you handle interruptions while you are trying to get your points across?
4. Rather than bluntly telling someone he is completely wrong, what should you say?

# Free Career Inquiry Service

## Absolutely Confidential

Respond to the career opportunities advertised in this issue. Fill out and send us this handy resume. **Electronic Design** will do the rest – neatly typed copies of this form will be mailed to the companies of your choice, indicated by the circled Career Inquiry Numbers at the bottom of this page.

7

<b>Name</b>		<b>Home Phone</b>	
<b>Home Address (Street)</b>		<b>City</b>	<b>State</b> <b>ZIP Code</b>

<b>Age</b>	<b>U.S. Citizen</b> <input type="checkbox"/> Yes <input type="checkbox"/> No	<b>Security Clearance</b>
------------	---	---------------------------

Prime Experience	Secondary Experience

<b>Desired Salary</b>	<b>Availability Date</b>
-----------------------	--------------------------

**Employment History – present and previous employers**

Company	City, State	Dates	Title
		to	
		to	
		to	

**Education – indicate major if degree is not self-explanatory**

Degree	College	City, State	Dates
			to
			to
			to

**Additional Training – non-degree, industry, military, etc.**

---



---



---

**Professional Societies**

**Published Articles**

**Career Inquiry Numbers:**

900   901   902   903   904   905   906   907   908   909  
 910   911   912   913   914   915   916   917   918   919   925

**ELECTRONIC DESIGN**  
 850 Third Avenue  
 New York, New York 10022

# You can imitate a Digiswitch but you can't duplicate it.

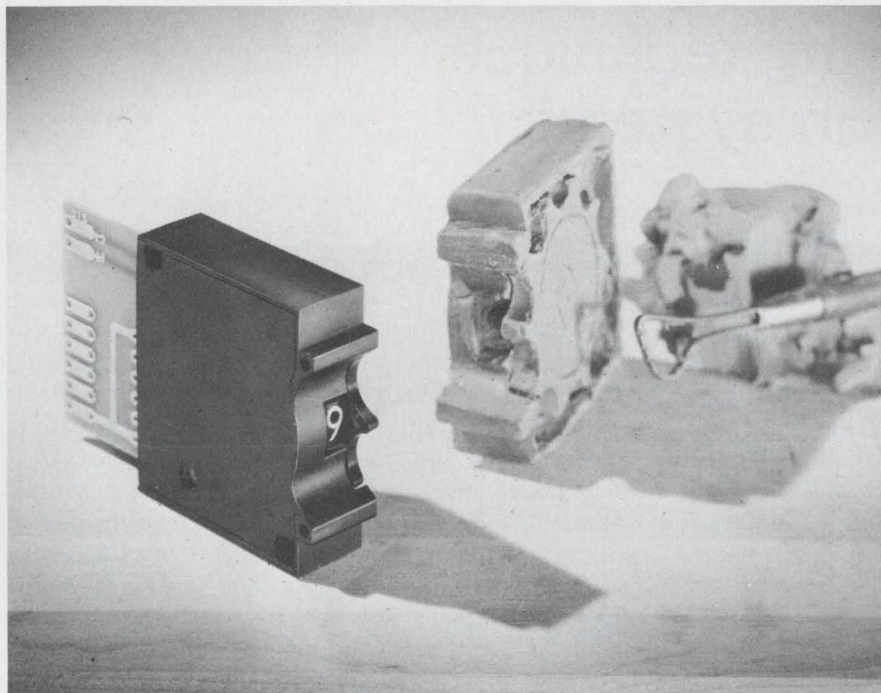

You can't duplicate a Digiswitch® any more than you could duplicate a sculpture by Rodin.

Make a fair copy? Sure, but the knowledge, experience and skill that went into the original would be missing.

Digitran pioneered thumbwheel switches, and years of experience and improvement have established Digiswitch as the industry standard. And, nobody comes close to duplicating our service organization, application library or scope of product.

Insist on an original. Digiswitch. The switch you can count on. More information about the original is yours for the asking.

**THE DIGITRAN COMPANY**  
 Subsidiary of Becton, Dickinson and Company   
 855 S. Arroyo Pkwy./Pasadena, Cal. 91105  
 Tel: (213) 449-3110/TWX 910-588-3794

INFORMATION RETRIEVAL NUMBER 48

SERIES P  
**THE**  
 MOST  
 COMPLETE  
 LINE OF  
**PANEL  
 MOUNTED  
 COUNTERS**



**Model P-4A**

Key resettable counter. U.L. listed. Lock on counter permits reset by key only for security measures. 115 V., 60 Hz. std.

ENM now offers the most complete line of panel mounted counters manufactured by a single source in the U.S.A.

Seven separate and distinct panel mounted models encompassing both resettable and non-resettable counters, key lock types and elapse time indicator with 9999.9 time scale.

All units feature six digits with a standard counting speed of 500 cpm. Higher speeds and various voltages available. Specials on request.

Write for 4-page full line panel mounted counter brochure. 



**ENM COMPANY**

5306 W. Lawrence Ave., Chicago, Ill. 60630  
 PHONE: (312) 282-8787  
 Representatives in principal cities

INFORMATION RETRIEVAL NUMBER 49

ELECTRONIC DESIGN 7, April 1, 1969

## POWER/MATE CORP. POWER TWIN-99 DUAL OP AMP SUPPLY

- ❖ Dual output 12.0 to 18.0 VDC at 400 ma.
- ❖  $\pm 0.05\%$  regulation
- ❖ 1.0 Mv rms ripple
- ❖ Overload and Short Circuit protected
- ❖ Meets MIL-E-5272 specs



Send for Literature describing thousands of Power Supplies to 400 Volts and to 50 Amps.

**\$99.00**



**POWER/MATE CORPORATION**

163 Clay St. ■ Hackensack, N. J. 07601  
 (201) 343-6294 ■ TWX (710) 990-5023

INFORMATION RETRIEVAL NUMBER 50

# Resonant charging technique simplifies ignition systems

Many capacitor-discharge ignition systems suffer from spikes on the high-voltage power supply. In units employing SCRs, these spikes can sometimes exceed the  $dv/dt$  rating of the SCR and breakdown occurs. A transistor circuit can be used to disconnect the SCR from the power supply when the SCR is OFF, but such circuits can be complex as well as expensive. This is so because, for a 30 or 40 kilovolt system, a 300 to 400 V transistor must be used. In addition, the charging current must be large enough to charge the capacitor up to full voltage before the next

pulse comes along. Conversely, the current must be small enough so that the disconnect transistor is kept within its safe operating limits.

A simpler solution is to use a resonant charging circuit, which provides high speed at low cost. The charger, as shown in Fig. 1a, is a modified series LC resonant circuit, which operates as follows: While the capacitor is discharging through the ignition, the series inductor,  $L$ , is being charged across the  $B+$  supply voltage. When the SCR turns off, the capacitor and inductor form a series LC circuit, with energy stored in the inductor but not in the capacitor. Resonant action now begins, and the capacitor charges to twice the supply voltage in a sinusoidal manner. As the voltage reaches the peak point, the current tries to reverse; but the diode cuts off, thus maintaining the voltage on the capacitor and isolating the power supply from the discharge circuitry.

The efficiency of the circuit of Fig. 1a can be improved by connecting a normally reverse-biased diode in parallel with the SCR, as shown in Fig. 1b. During discharge action, the coil and capacitor oscillate at their resonant fre-

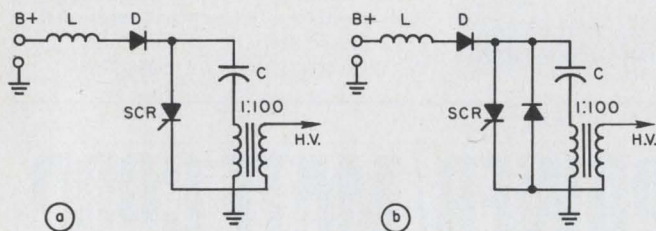

1. Resonant charging circuit is formed by inductor  $L$  and capacitor  $C$  when the SCR cuts off (a). The efficiency of the circuit is increased by the addition of a diode in parallel with the SCR (b).

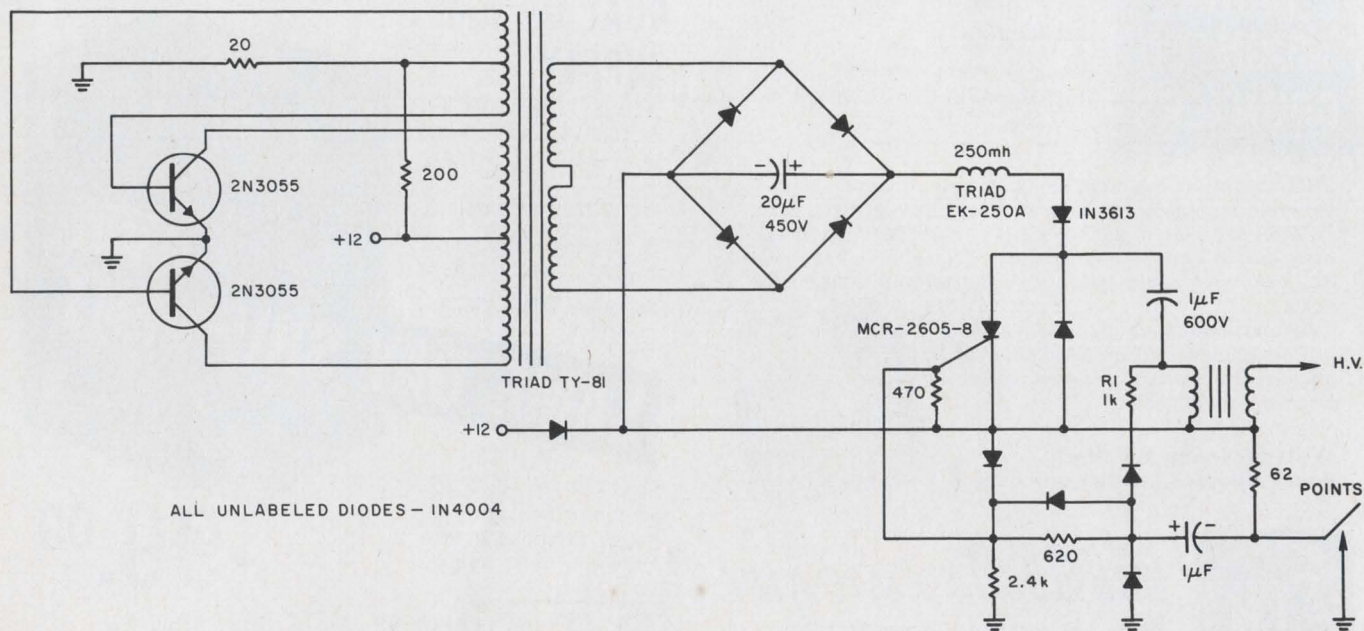

2. Complete ignition system using the resonant-charging technique provides an output voltage of 55,000 V.

There was a time when network analysis was a long, drawn-out process — consisting of *measuring* amplitude and *interpreting* phase response.

Now, with the HP 675A/676A network analysis system, you get a complete characterization of your network. You have **both** phase and amplitude information on a swept basis to 32 MHz—and you save hours of time because you can see changes in phase and amplitude responses as you make adjustments. Add the HP 11138A impedance measuring accessory for making complex driving point impedance measurements on a swept basis—and you have a complete network analysis system.

You can use this analysis system for your circuit design checking, operational amplifier characterization, crystal characterization, classroom demonstrations and many other applications. The system is completely programmable for automatic or computerized production and quality analysis testing.

The 675A Sweeping Signal Generator has a 10 kHz to 32 MHz range with settings anywhere in this range for single or continuous sweep. The 676A Phase/Amplitude Tracking Detector adds a full 360° phase measurement capability and an 80 dB dynamic amplitude range.

Channel A and B outputs on the 676A provides simultaneous amplitude measurements of two devices for comparison. Amplitude A-B and

PHASE A-B make difference measurements easy. Outputs can be easily calibrated in linear dB and linear phase on a low frequency oscilloscope or X-Y recorder.

Get complete characterization of your network with the HP 675A/676A network analysis system. Call your HP field engineer for complete specifications. Or, write to Hewlett-Packard, Palo Alto, California 94304. Europe: 1217 Meyrin-Geneva, Switzerland. Price: 675A, \$2250; 676A \$1275; 11138A, \$175.

**HEWLETT  PACKARD**  
SIGNAL ANALYZERS

099/14

# Now You Can Completely Characterize Your Networks to 32 MHz

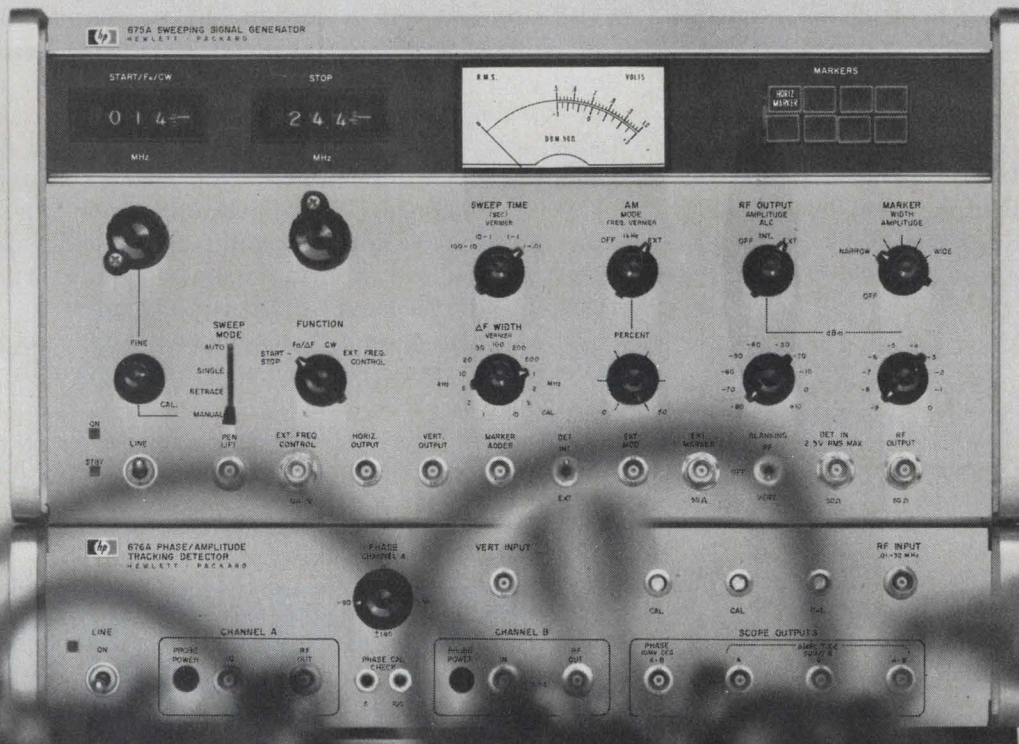

quency. After the first current reversal, the parallel diode becomes forward biased, and some of the energy still stored in the coil is transferred to the capacitor. If the capacitor charges up to a voltage,  $V$ , then the resonant charger will charge the capacitor to a voltage

$$(B+) + [(B+) - V], \text{ or } 2(B+) - V.$$

A complete capacitor-discharge ignition system based on this concept is shown in Fig. 2. The gate of the SCR in the circuit is reverse biased for faster switching speeds. Also, the two diodes in series with resistor  $R1$  insure negative gate bias

before the SCR is ready to turn off, giving extremely reliable operation.

With the inverter transformer shown (375 V), the discharge capacitor is charged up to 550 V with a 12-V input. Using a standard ignition coil having a 100:1 turns ratio, an output voltage of 55,000 V can be obtained. In laboratory tests the circuit was run at 24,000 rpm with full output still present.

*H. D. Carlstrom, Design Engineer, Sanders Associates, Inc., Nashua, N. H.*

VOTE FOR 311

## Transient generator speeds noise immunity measurements

Voltage transients on a power bus frequently can disrupt circuit operation by falsely triggering flip-flops, firing one-shots or appearing at amplifier outputs. Accurate and repeatable measurements of a circuit's immunity to such transients can be made with this transient generator (Fig. 1).

The generator, which draws its operating power from the circuit under test, produces positive or negative transients of variable amplitude at the push of a button. It can be used with any supply voltage up to the breakdown voltage of the capacitors.

Operation of the circuit is as follows: potentiometer  $R_4$  places a fraction,  $\alpha$ , of the  $V_{CC}$  voltage on the positive terminal of  $C_2$  and the negative terminal of  $C_1$ . Therefore, the voltage across  $C_2$ , namely  $V_{C2}$ , equals  $\alpha V_{CC}$ , and the voltage across

$C_1$ , namely  $V_{C1}$ , equals  $V_{CC} (1 - \alpha)$ .

Closing of switch  $S1$  then produces a negative transient of amplitude  $V_{CC} - \alpha V_{CC} = V_{CC} (1 - \alpha)$  and time constant  $\tau = R_1 C_2$ . Similarly, closing of switch  $S2$  produces a positive transient of amplitude  $V_{C1} = V_{CC} (1 - \alpha)$  and time constant  $\tau = R_1 C_1$ . Since  $0 < \alpha < 1$ , the amplitude of the transients can be continuously varied from 0 to 100% of  $V_{CC}$ .

Resistors  $R_2$  and  $R_3$  isolate the two capacitors during a switch closure. Resistor  $R_1$  is chosen small enough so that the voltage drop across it, due to the steady-state current of the circuit under test, can be ignored. Switches  $S1$  and  $S2$  should be of the "no-bounce" type, such as Victron VG-20 series. When packaging the generator, terminals  $a$  and  $b$  should be located close together to allow shunting  $R_1$  with an external resistance, if needed for high current circuits.

Three positive and three negative transients generated by the circuit on a +20 V power line are shown in Fig. 2.

*Eric J. Hoffman, Design Engineer, Johns Hopkins University, Baltimore, Md.*

VOTE FOR 312

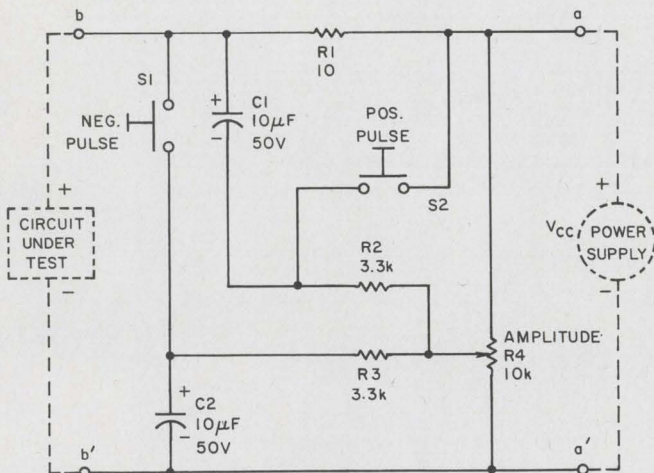

1. Positive transients are produced by switch  $S2$  and negative transients by  $S1$ . The amplitude of the transients is set by potentiometer  $R_4$ .

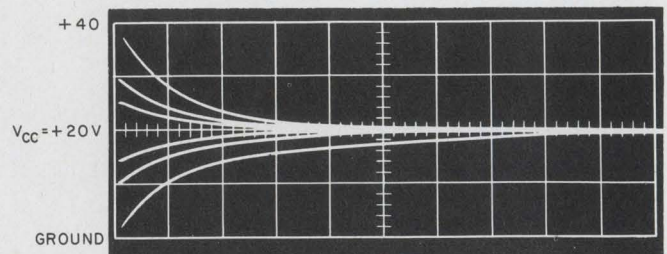

2. Positive and negative transients produced on a +20 V power line are shown by these scope traces. Horizontal sweep is 100  $\mu s/cm$ .



# Close your DVM credibility gap

...with the new 1822 Digital Voltmeter Calibrator

How well do you trust your DVM? Is its calibration still right? How about its linearity? Is the reading subject to hysteresis? Are you sure what effect input loading has on accuracy? How about the DVM's susceptibility to interfering voltages?

How do you find out? You could tear down your setup and drag your DVM to the standards lab for calibration. But wouldn't it be nice if the standards lab could come to you for a change?

We think we've worked out a way to bring the mountain to Mohammed and get those DVM calibration jobs done with the new GR 1822 Digital Voltmeter Calibrator. Here's an instrument that doesn't need the security blanket of standard lab conditions to do its job — it can come to you. And, conveniently too. All calibration functions are incorporated into one, small, easily transportable instrument.

All you have to do is bring the 1822 to your DVM, select a test voltage range, connect in your DVM, and push a button. Then, sit back and watch while an automatic test program takes your

DVM progressively through its decades. Select input loading or interfering voltages as desired. That's all there is to it. The testing method is in accordance with proposed USASI procedures for DVM's and Ratio Meters (USAS C39-6; soon to be released).

The 1822 is not limited to DVM testing. Anything that measures, transmits, or transduces analog voltages can be checked. And, the 1822 can be remote programmed for use as a systems calibration device.

The 1822 may create a credibility gap between you and your DVM's. But only for a little while. Then you'll swear by DVM's and not at them.

## SPECIFICATIONS

**DC Calibrating Voltages:** 100  $\mu$ V to 1111.1 V in 7 decade ranges.

**Voltages Available in Each Range:** 0.11111, 0.22222, 0.33333, etc., to 1.1111. Zeros can be substituted if desired in the last four, two, or one digits (i.e., 0.30000, 0.33300, or 0.33330). Standard cell output can also be selected (1.018700 to 1.019100 V, adjustable to match standard).

**Voltage Accuracy:** Six-month accuracy is  $\pm$ (30 ppm of voltage + 10 ppm of full range + 3  $\mu$ V), except on 1-kV range which is  $\pm$ (50 ppm of voltage + 10 mV).

**Warmup and Stability:** Output essentially within above accuracy after 15-minute warmup from cold start. Stability over a 24-hour period is within  $\pm$ (20 ppm of voltage + 2  $\mu$ V).

**Interference Voltages Available:** 1, 10, 100 V  $\pm$ 10%, dc or peak ac. Choice of common-mode ac and dc (low terminal to case) and normal-mode ac (algebraically added to output). AC voltage is from line or can be provided externally (5-V pk).

**Output Impedance:** Less than 0.2  $\Omega$  above 1 V and 200  $\Omega$  below 100-mV in "zero"-ohm position; 1-k $\Omega$ , 10-k $\Omega$ , or 100-k $\Omega$  outputs, switch selectable.

**Programmability:** Internal automatic program sequences voltages from 1/10 of full scale to full scale and back down again. Maximum voltage range is switch selected. Program begins at maximum range, then drops a range and repeats the program. Process continues until range reaches either a 1-V or 1-mV preselected minimum, or until told to stop. In addition, functions controlling output range, digits and zeros can be remote programmed by switch closure or by "on" signal.

**Price:** \$2800 in U.S.A.

For complete information, write General Radio Company, West Concord, Massachusetts 01781; telephone (617) 369-4400. In Europe: Postfach 124, CH 8034, Zurich 34, Switzerland.



**GENERAL RADIO**

## FET detector rectifies extremely small signals

A device was needed to rectify small signal levels in the millivolt (peak-to-peak) range. Various amplifier-rectifier configurations were found to be asymmetrical and to have unacceptable zero offset. The requirements, on the other hand, called for near-perfect symmetry, and for the rectified signal to be clamped to ground or zero volts dc.

These results were obtained with the simple and inexpensive FET arrangement shown. The FET is biased at pinch-off, where it passes very little current, allowing its source to drop to a near-zero level. The positive portion of the incoming signal (depending upon gate bias) pulls the device into conduction, and the rectifying effect is obtained.

With the values shown, offset due to leakage is only 2 mV, peak-to-peak between 20 mV and 1 mV (peak-to-peak) output. Symmetry of the

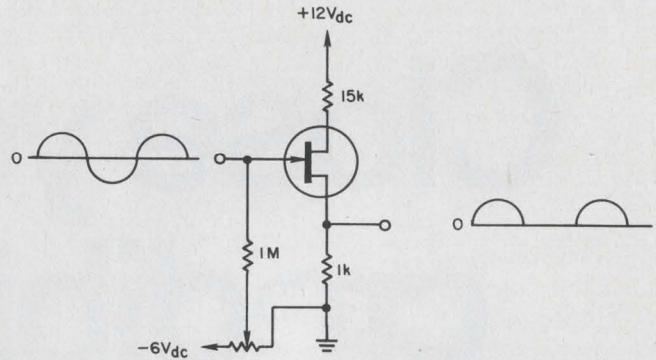

FET detector is biased at pinch-off to provide rectifying action.

resulting half wave is near perfect, and it is clamped to zero volts dc.

Neal H. Pyatt Jr., Project Engineer, Technoscan, Inc., Newport Beach, Calif.

VOTE FOR 313

## Measure resonator loaded Q with frequency measurements

Microwave band-reject filters are frequently constructed using several cavity resonators spaced along a main line by an odd number of quarter-wavelengths. To obtain desired filter performance, the loaded Qs of each cavity resonator must be measured accurately. The conventional measurement of loaded Q (using the half-power frequencies of the amplitude response) becomes quite difficult to implement when asymmetrical response shapes are encountered. An alternate method of measuring loaded Q entails only simple frequency measurements, and takes advantage of the response shape asymmetry.

A waveguide band-reject filter can be realized using top-wall coupled cavity resonators (see a) spaced along a main-line waveguide by 3/4 guide wavelength. Without compensation, the filter response shape is inherently asymmetrical.<sup>1</sup> This can be expected by examining the lumped-circuit equivalent (see b) of the loaded waveguide cavity resonator. The nominal half-guide wavelength cavity resonator acts as a series resonant circuit which is shunted by the inductance (L) of the coupling aperture. Peak rejection occurs at an anti-resonant frequency  $f_{\infty}$ , which is below the series resonant frequency,  $f_o$ , (see c).

For a nominal half-guide wavelength cavity resonator of the same cross section as the main

line rectangular waveguide, series resonance occurs when the effective length, L, is equal to  $\lambda_{go}/2$  where  $\lambda_{go}$  is the guide wavelength at series resonance. Anti-resonance occurs when

$$b = -\cot(2\pi L/\lambda_{g\infty}), \quad (1)$$

where b is equal to normalized susceptance of the inductive coupling aperture, and  $\lambda_{g\infty}$  is equal to

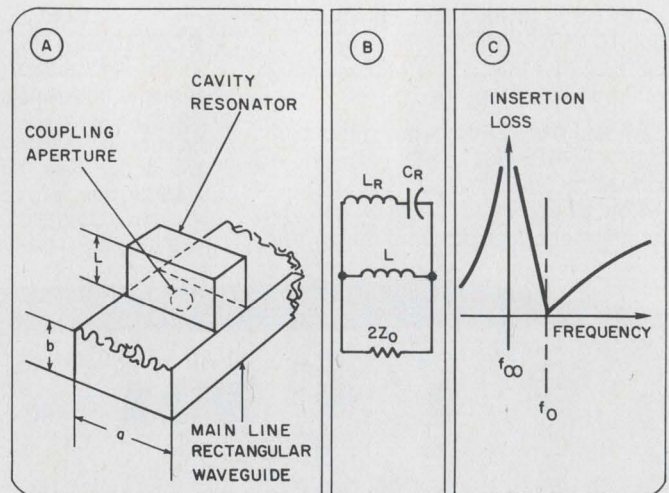

Top-wall coupled cavity resonator (a) can be used as a microwave band-reject filter. The low-frequency equivalent of such a filter is shown in b and its response curve in c.





## These specialists can't wait to get their hands on our new plastic transistors. How about you?

If you fit one of these descriptions, our new family of B-133000 plastic power transistors is for you:

You're a power-circuit designer. Interested in  $V_{CE0}$  up to 80 volts? Good gains up to 4 amps? And isolated collector? You know you are.

You're a manufacturing man. Get rid of those extra insulating washers and bushings. Our plastic transistors are electrically isolated. Mount them in a one-step operation with just a self-tapping screw.

You're a mechanical engineer. Here's a plastic package surrounded by a corrosion-resistant, protective metal form.

You're a components specialist. Now you can get interchangeability with other plastic configurations and TO-66 mounting arrangements.

You're a circuit reviewer. We're offering safe operating areas for all the 20-watt ( $T_C = 25^\circ\text{C}$ ) B-133000's. They're rugged, second-breakdown-resistant, silicon mesa NPN devices.

You're a purchasing man. You get low cost two ways—a low price tag and you don't need any expensive mounting kits. Delivery is fast—from distributor stock or directly from us.

No matter who you are, you've got a good reason for checking on our B-133000's. Write: The Bendix Corporation, Semiconductor Division, Holmdel, New Jersey 07733.

### B-133000-008 SERIES

Symbol	Characteristics
$I_C$ Max.	4.0A
$V_{(BR)CE0}$	40, 60 or 80V
$V_{CES}$	60, 80 or 100V
$P_T$	20W at Case Temp. $T_C=25^\circ\text{C}$
$P_T$	2.8W in free air at $T_A=25^\circ\text{C}$
$h_{FE}$	100-300 at $I_C=0.5A^*$
$h_{FE}$	12-48 at $I_C=4.0A^{**}$
$f_T$ Min.	1 MHz

\*B-133000,3,6

\*\*B-133000,2,5,8

**Bendix** **Electronics**

Chicago—(312) 637-6929; Detroit—(313) 548-2120; Great Neck, N.Y.—H. V. Sales Co. (516) HU 7-1142; Greenwich, Conn.—(203) 869-7797; Holmdel, N.J.—(201) 946-9400; Lexington, Mass.—(617) 861-8350; Los Angeles—(213) 776-4100; Minneapolis—(612) 926-4633; Orlando, Fla.—(304) 241-6559; Rochester, N.Y.—(716) 266-5550; Runnemede, N.J.—(609) 933-2550; Seattle—Ray Johnston Co., Inc. (206) LA 4-5170; Export—Cable: "Bendixint," 605 Third Avenue, New York, (212) 973-2121; Ottawa, Ont.—Computing Devices of Canada, P.O. Box 508 (613) 829-1800; San Juan, Puerto Rico—Southern International Sales Co. 723-3879.

the guide wavelength at the anti-resonant frequency. Letting  $L$  equal  $\lambda_{g0}/2$ ,

$$b = -\cot(\theta) = -\cot(\pi \lambda_{g0}/\lambda_{g\infty}), \quad (2)$$

where  $\theta$  is an angle in the second quadrant

If the frequencies of peak rejection ( $f_{\infty}$ ) and maximum transmission ( $f_0$ ) are measured, the corresponding guide wavelengths,  $\lambda_{g\infty}$  and  $\lambda_{g0}$ , can be calculated or obtained from existing tables. Then  $b$  can be calculated using Eq. 2. The loaded  $Q$  of the single cavity band-reject filter will be:

$$Q \cong \pi(\lambda_{g\infty}/\lambda_{\infty})^2(1/4 + b^2) \quad (3)$$

where  $\lambda_{\infty}$  is free-space wavelength at  $f_{\infty}$ . Using the values of  $b$  from Eq. 2,  $Q$  can be readily com-

puted from Eq. 3.

The technique of calculating loaded  $Q$ s from the resonant and anti-resonant frequencies can be applied to other transmission line band-reject cavity resonators, as well as to lumped-circuit resonators.

**Reference:**

1. R. M. Kurzrok, "Trimming Improves Response of Waveguide Band-reject Filter," *ELECTRONIC DESIGN*, Nov. 8, 1967, p. 116.

*Richard M. Kurzrok, Consulting Engineer, New York, N.Y.*

VOTE FOR 314

## Time division multiplex with standard TTL logic gates

Time division multiplexing has become a requirement in many digital processing systems to obtain minimum weight and cost. A multichannel digital system that incorporates time division multiplexing has a number of digital sources, all feeding information, upon command, onto a single line that connects to some digital processing equipment. It is reasonable to say that the output of each digital source must represent a very high impedance to the line when that source is not transmitting, so as not to load the source that is transmitting. Conversely, when a source is transmitting, it will exhibit normal logic levels.

As shown in Figs. 1 and 2, this can be accomplished easily by selecting as the output stage of each source a TTL integrated-circuit logic

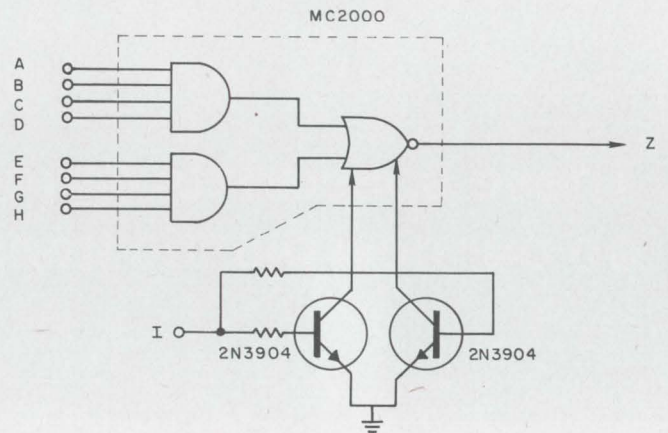

1. Standard TTL gate and two extra transistors provide multiplexing capability for a digital source.

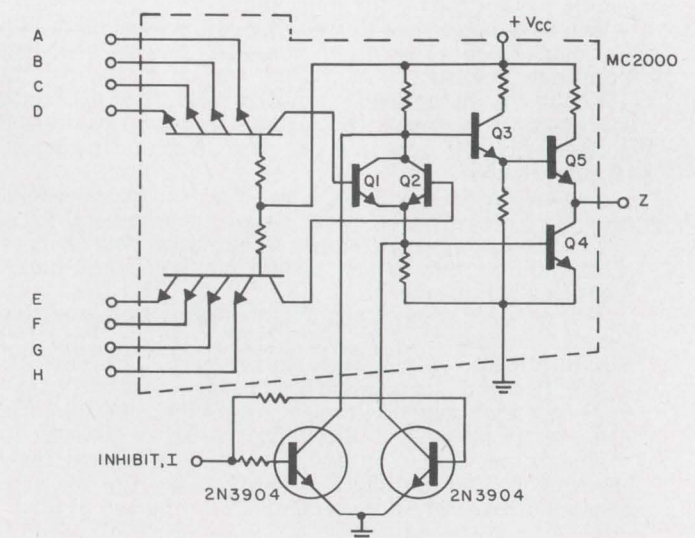

2. Output signal Z is either inhibited by input I or exhibits normal logic levels.

# VOTE

**VOTE!** Go through all Idea-for-Design entries, select the best, and circle the appropriate number on the Reader-Service-Card.

**SEND US YOUR IDEAS FOR DESIGN.** You may win a grand total of \$1050 (cash)! Here's how. Submit your IFD describing a new or important circuit or design technique, the clever use of a new component or test equipment, packaging tips, cost-saving ideas to our Ideas-for-Design editor. You will receive \$20 for each accepted idea, \$30 more if it is voted best-of-issue by our readers. The best-of-issue winners become eligible for the Idea Of the Year award of \$1000.

Beckman Instruments is  
one of the most demanding customers  
we've ever had.

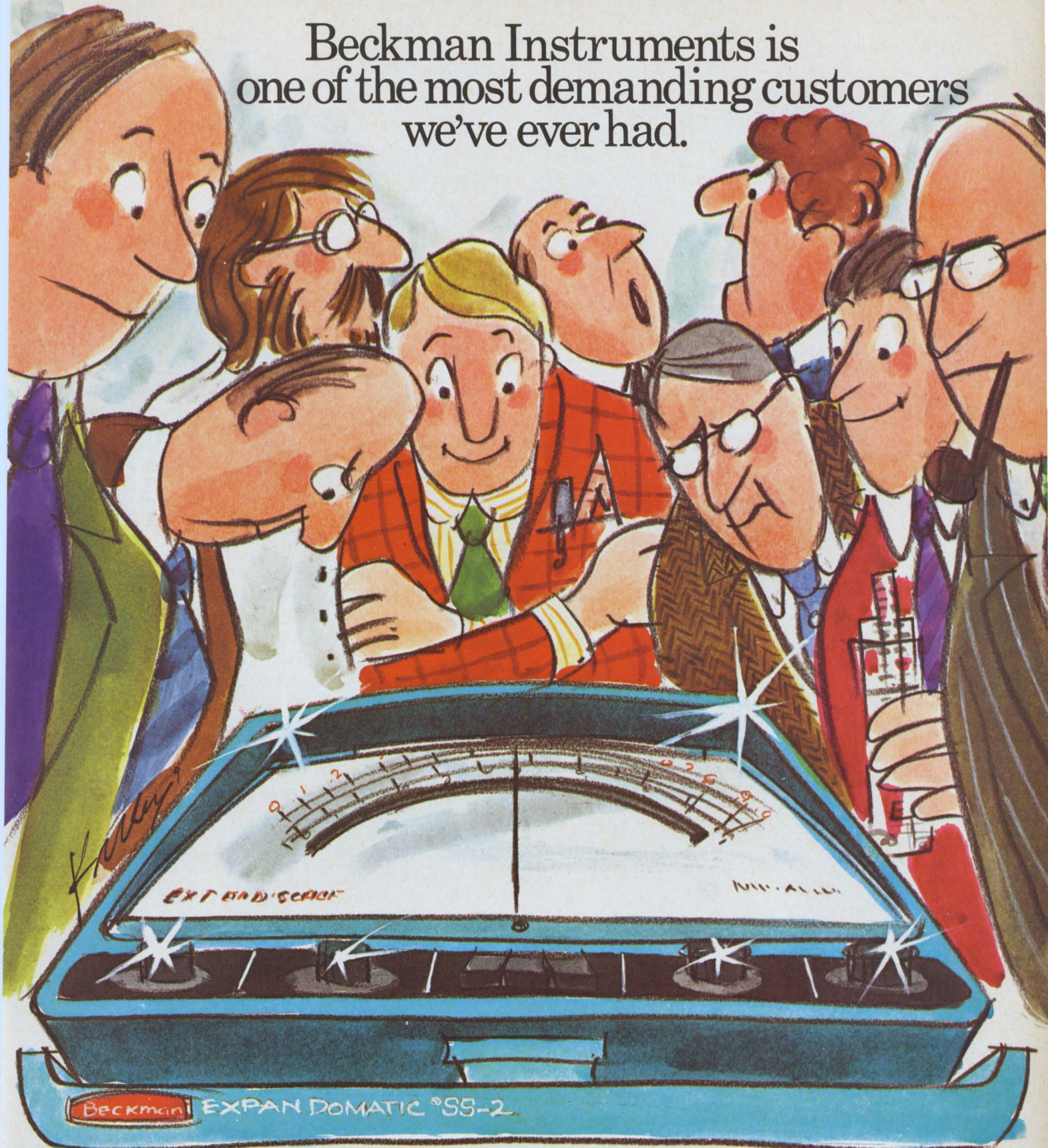

We make so many taut-band meters at Honeywell, that when Beckman Instruments came to us for a taut-band meter, we were pretty confident.

"Take a look through our catalog," we told them. "Just tell us which one you want."

"We've taken a look through your catalog," they told us, "and you don't have the one we want."

Then they told us what they wanted:

They wanted a very special meter to be used as the readout device in a new line of pH instruments that Beckman was designing.

The meter had to have incredible accuracy: To 0.05 pH (0.35% F.S.). A readability within 0.02 pH units. And an 8.1 inch scale. (They were asking us to make the largest meter we had ever made.)

Wow.

Well, Beckman got the meter they

wanted. Because they were demanding.

If you need a very special meter, we suggest you write Honeywell Precision Meter Division, Manchester, N.H. 03105.

Take a look through our catalog. Just tell us which one you want.

And if we don't have the one you want, be demanding.

**Honeywell**

block that has expandable capabilities. An expandable, dual 4-input AND-OR-INVERT gate connected to allow multiplexing is illustrated in Fig. 1, where input *I* is the channel inhibit signal. The only components required besides the IC gate are two resistors and two inexpensive transistors.

The multiplexing operation can be seen from Fig. 2, which shows the circuitry of the MC2000 gate. When the inhibit signal, *I*, is in the HIGH state, the bases of *Q3* and *Q4* are grounded, cutting off the output. In this inhibited state the output appears as a high impedance. When the inhibit signal is in the LOW state, the operation of the logic function is normal.

Many TTL devices offer this expandable capability and can be used to perform the multiplexing function.

*Ed Renschler, Senior Applications Engineer, Motorola Inc., Semiconductor Products Div., Phoenix, Ariz.*

VOTE FOR 315

## Positive-to-negative logic level converter uses simple IC

A level converter for converting positive logic levels to negative levels can be constructed with a standard integrated-circuit interface element, a zener diode, and 2 resistors. Although the integrated circuit used in this design is a DTL 930 Series 944 power gate, any gate or buffer element that has no internal pull-up resistor in its output stage is suitable.

As shown in the illustration, the  $-V_{cc}$  terminal is connected to  $-12\text{ V}$  and the  $+V_{cc}$  terminal to  $-6\text{ V}$ ; therefore, the  $+V_{cc}$  terminal is operated at  $+6\text{ V}$ , referred to the  $-V_{cc}$  terminal. An external pull-up resistor is connected from the output terminal to ground, and the gate's input terminal is returned through a resistor to  $-12\text{ V}$ . The input signal is applied through a 12-V zener diode to the input terminal of the gate.

The input signal characteristics are 0 V for a logical zero and  $+5\text{ V}$  for a logical ONE. When the input is at 0 V, the 12-V zener diode will cause the gate's input to be at  $-12\text{ V}$  (the same as the  $-V_{cc}$  terminal). For this condition, the output stage of the gate will be turned off, and no current will flow through the external pull-up resistor. The output signal will, therefore, be at 0 V potential.

When the input signal is at  $+5\text{ V}$ , the 12-volt drop across the zener will produce  $-7\text{ V}$  at the

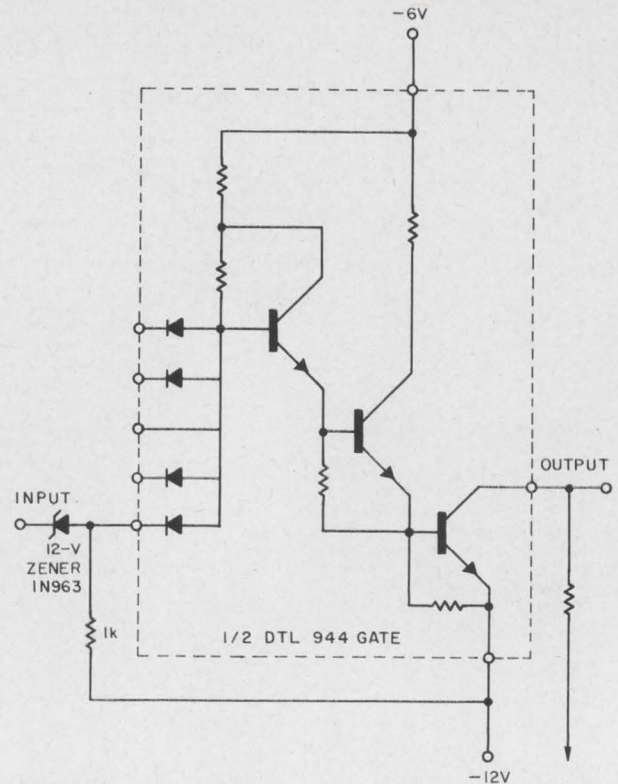

Output voltage swing of this logic level converter is determined by the zener diode and the supply voltages.

IC input; that is, the input will be  $-7 - (-12) = +5\text{ V}$  positive with respect to the  $-V_{cc}$  terminal. This condition will cause the output stage to conduct, thus producing a  $-12\text{-V}$  output.

Different supply voltages and zener diodes can be used to produce level converters having output voltage swings other than  $-12\text{ V}$ .

The 944 circuit actually has two gates within one package; therefore, two level converters can be constructed with it. Likewise, a hex-inverter without internal pull-up resistors could be used to make six converters.

Note from the following table that logical inversion is produced by this converter. Such inversion can be eliminated by preinverting the signal applied to the input zener diode.

Input	Output
0 V (ZERO)	0 V (ONE)
$+5\text{ V}$ (ONE)	$-12\text{ V}$ (ZERO)

*George S. Krause, Asst. Project Engineer, The Bendix Corp., Baltimore, Md.*

VOTE FOR 316

### IFD Winner for December 5, 1969

**D. C. Pidgeon**, Systems Service Engineer, RCA Service Co., Inc., Rosman, N.C. His Idea "IC ramp generator is simple and fast" has been voted the most Valuable of Issue Award.

**Vote for the Best Idea in this Issue.**

how to build cases, cabinets, consoles, boxes quickly and economically with the...

# imlok system

Built with Bud Imlok material is this attractive enclosure for a fuel cell system used for demonstration, experimentation and educational purposes.

Ask your Authorized Bud Distributor or Bud Representative to show you the advantages of the Bud Imlok System or, write us for this manual.

COMPLETE GUIDE TO

BUD IMLOK

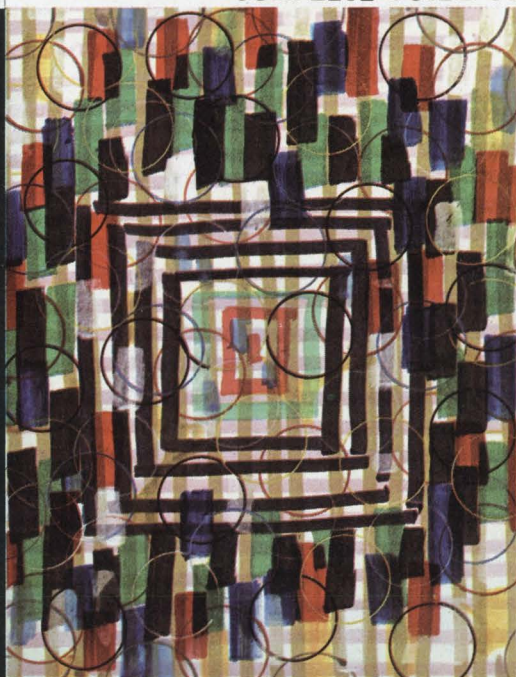

A new engineering manual shows and tells you about this remarkably simple system. It consists of assembling a variety of symmetrical aluminum extrusions and connectors to create exclusive enclosures. The size and configuration is limited only by your requirements. Imlok is ideal for prototype and short run work. The overall cost is low since no tooling costs and no skilled labor is involved.

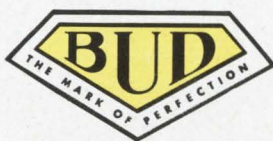
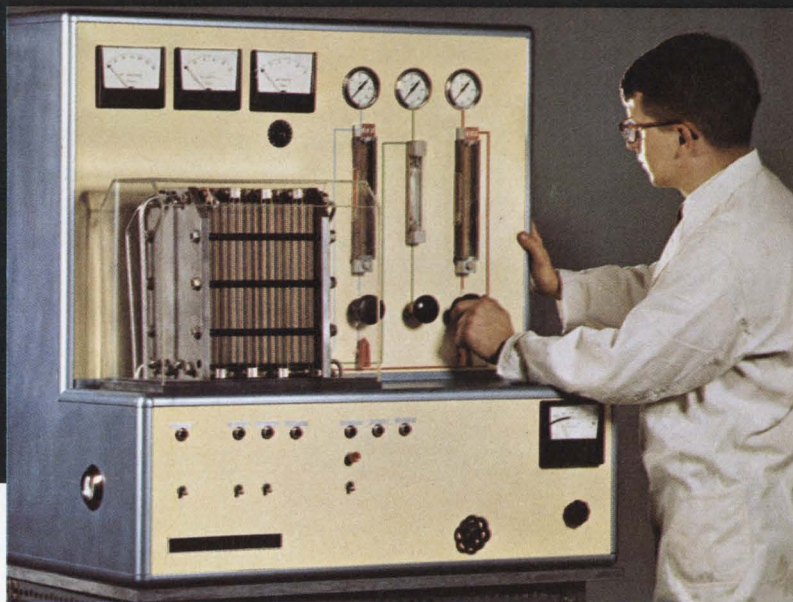

**BUD RADIO, INC.**

Willoughby, Ohio

\* Your product *Belongs* in a BUD cabinet

INFORMATION RETRIEVAL NUMBER 56

# CROWBAR...?



## The One Inside is FREE

Not so many years ago, the prudent transmitter engineer discharged a high voltage capacitor bank by dropping a shorting "crowbar" across its terminals. Today's "crowbar" is a protective overvoltage circuit found on DC power supplies — usually at extra cost. Now HP includes a crowbar as standard on its recently updated series of low-voltage rack supplies . . . at no change in price.

Long established as preferred system supplies for component aging, production testing, and special applications, these supplies have now been redesigned and expanded to meet the stringent demands of today's power supply user. Advantages include low ripple (peak-to-peak as well as rms), well-regulated constant voltage/constant current DC with outputs to 60 volts and 100 amps.

Where loads are critical and expensive, the extra pro-

tection — say, against inadvertent knob-twiddling — from a crowbar is invaluable. On all internal crowbars in this series, the trip voltage margin is set by screwdriver at the front-panel.

Pertinent specifications are: triggering margins are settable at 1V plus 7% of operating level; voltage ripple and noise is 200  $\mu$ V rms/10mV peak-to-peak (DC to 20 MHz); current ripple is 5 mA rms or less depending on output rating; voltage regulation is 0.01%; resolution, 0.25% or better; remote programming, RFI conformance to MIL-I-6181D.

Prices start from \$350. For complete specifications and prices, contact your local HP Sales Office or write: Hewlett-Packard, New Jersey Division, 100 Locust Avenue, Berkeley Heights, New Jersey 07922 or call (201) 464-1234 . . . In Europe, 1217 Meyrin, Geneva.

**HEWLETT**  **PACKARD**  
POWER SUPPLIES

Additional data sheets available upon request

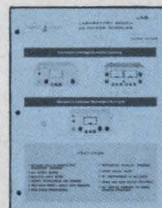

**LAB SERIES**  
smaller package,  
lower power,  
optional crowbar



**CROWBARS**  
A Technical  
Discussion



**1969 Power  
Supply Catalog**  
— includes total  
HP power supply line.

# Presenting the winning advertisements in 'Top Ten' contest

The following pages display the 10 outstanding advertisements that appeared in our Jan. 4 issue featuring the "Top Ten" contest. The contest attracted close to 5000 readers who attempted to match their ratings of the 10 most memorable advertisements with the "recall-seen" scores from ELECTRONIC DESIGN's regular Reader-Recall survey.

The winning advertisements combine attractive colors, tasteful design and well-written copy. The result: impact. The winners, in order of highest Reader-Recall score, are as follows:

1. Sylvania Electric Products, Inc.
2. Guardian Electric Manufacturing Company
3. Fairchild Semiconductor/A Division of Fairchild Camera and Instrument Corporation
4. Microswitch, A Division of Honeywell
5. Dale Electronics, Inc.
6. Astrodata, Inc.
7. Philbrick/Nexus Research, A Teledyne Company
8. Kurz-Kasch, Inc.
9. Amphenol, The Bunker-Ramo Corporation
10. Ingersoll Products, Division of Borg-Warner Corporation

# Fairchild can make more hybrids in

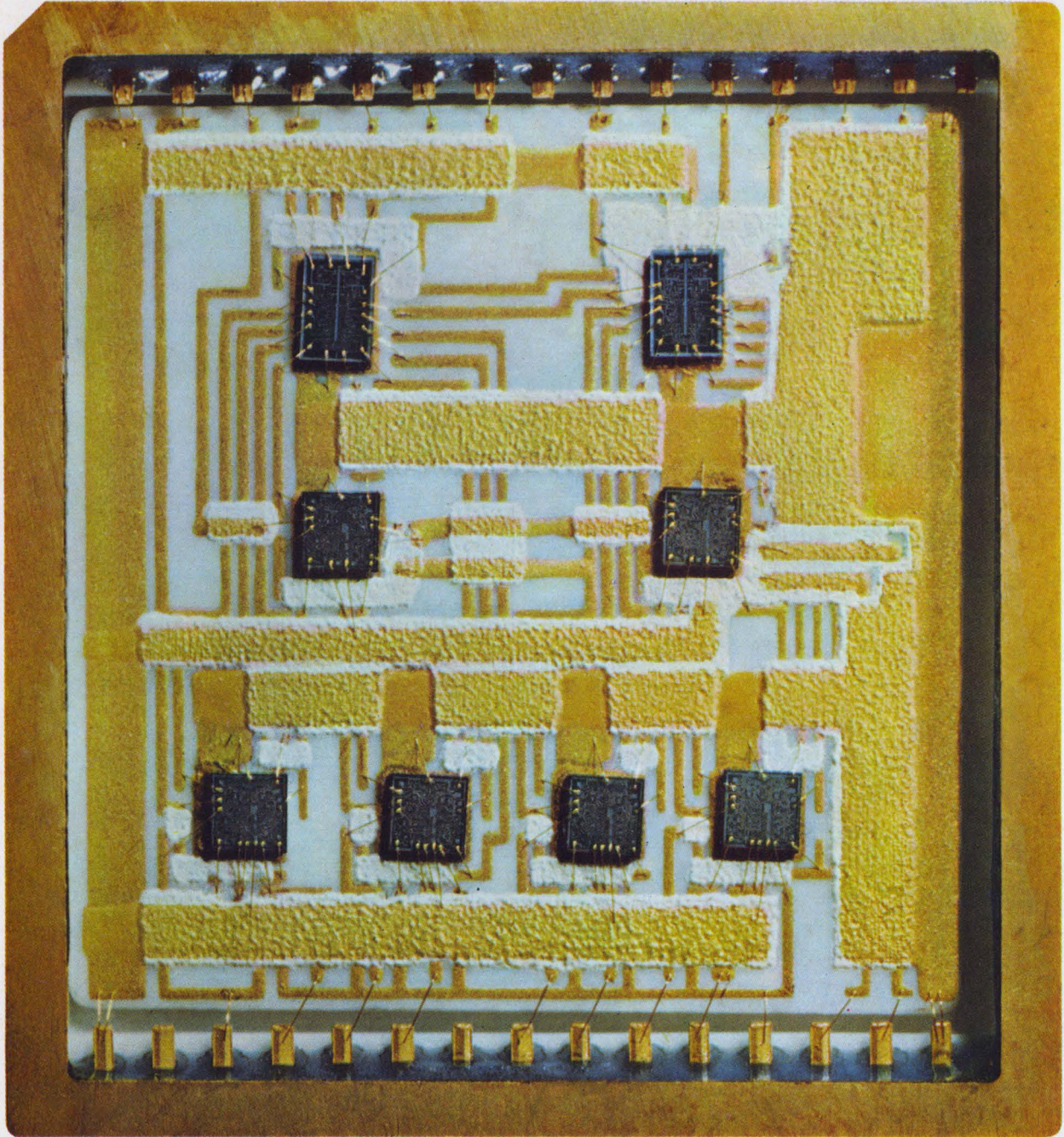



# an hour than you can use in a month.



*We can make any hybrid, in any quantity, using any method: Thick film. Thin film. Thin film on silicon. We can make them faster than anyone in the industry. And deliver them quicker to anyone in the world. We'll take any functions you need and package them any way you want. Our list of hybrid components has everything from a simple diode to a complex LSI array.*

*For your less complex applications, we have a line of off-the-shelf standard hybrids priced like discretes. If this commitment makes sense in general, we'd like to send you the whole story in detail. Our brochure is called Fairchild Hybrid Microcircuits. It can give you more ideas in an hour than you could use in a year. Write for it.*

Fairchild Semiconductor/A Division of Fairchild Camera and Instrument Corporation//313 Fairchild Drive, Mountain View, California 94040 (415) 962-5011 TWX: 910-379-6435

**FAIRCHILD**  
SEMICONDUCTOR

INFORMATION RETRIEVAL NUMBER 57

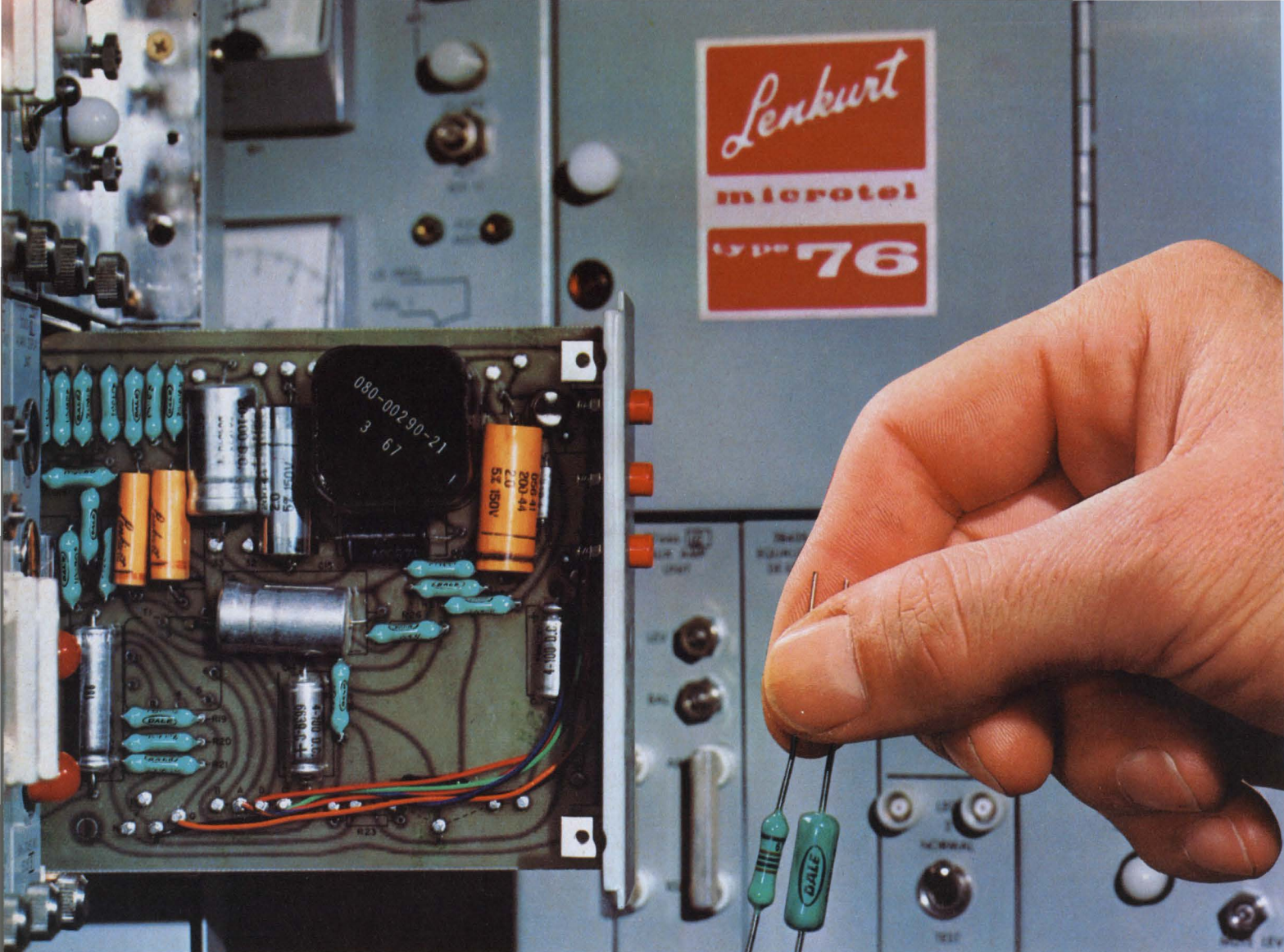

# 20 years of stability

# ...a job for DALE Metal Film Resistors

Twenty years – the design life of Lenkurt's versatile "76" Microwave Systems – puts stringent demands on a resistor. To meet them, Lenkurt uses Dale MFF Metal Film Resistors to maintain bias stability in critical amplification circuits. Their evaluation: "Good performance."

Here's how Dale multiplies the advantages of metal film for your application: **Broader design choice** – From subminiature 1/20 watt through 12 watts of housed power plus microresistive package and networks to your specification. **Proven failure rate** – See data at right. **Faster delivery** – Expanded production facilities let you call the shots on shipment of both MF and MFF types.

Call Dale today...402-564-3131 or circle 181 for complete Resistor Catalog A

GENERAL SPECIFICATIONS TYPE MF* MIL-R-10509F				
DALE TYPE	MIL. TYPE	125° C RATING (Char. C & E)	70° C RATING (Char D)	RESISTANCE RANGE (Ohms)
MF50	RN-50	1/20 w	1/10 w	30.1 to 80.6K
MF-1/10	RN-55	1/10 w	1/8 w	30.1 to 301K
MF-1/8	RN-60	1/8 w	1/4 w	10 to 1 MΩ
MF-1/4	RN-65	1/4 w	1/2 w	10 to 1 MΩ
MFS-1/2	RN-70	1/2 w	3/4 w	10 to 1.5 MΩ
MF-1	RN-75	1 w	–	25 to 2.6 MΩ
MF-2	RN-80	–	2 w†	100 to 10 MΩ

\*Also available in conformal coated (MFF) and housed chassis mount (D) styles with power to 12 watts. †Char. B.

**Tolerance:** ±1%, ±.5%, ±.25%, ±.10% standard. Characteristics D, C, or E apply depending on T.C. required.

**Proven Failure Rate:** .004% per 1,000 hrs. (60% confidence at 50% power, 70° C ambient). Based on 16,320,000 hrs. of load life testing without a failure (100% rated power, 70° C, failure defined as ΔR > 1%).

**Gard Testing** is available to meet Established Reliability requirements at significant time/cost savings over typical 100 hr. burn in. Write for Test Report #19590.



for optimum value in metal film resistors

DALE ELECTRONICS, INC., 1300 28th Ave. Columbus, Nebraska 68601  
In Canada: Dale Electronics, Canada, Ltd.



# Dale wirewounds can improve your memory.



**The computer:** General Electric's versatile GE/PAC<sup>®</sup> 4020 Process Control Computer... shown at left.

**Resistor assignment:** Establish line current values in the GE/PAC<sup>®</sup> 4020 core memory system.

**The part used:** Dale's Type NS...silicone coated, non-inductively wound.

**Reason:** Low inductance (less than 1  $\mu$ h) and unvarying stability (less than .5%/ 2000 hours).

Dale wirewounds give you unequalled design freedom in tailoring resistance, power, size and stability to your exact needs. Industrial.... precision.... established reliability.... standard or special....there's always a Dale resistor that can do the job better. Call 402-564-3131 for fast action, or circle 181 for Catalog A.



*for optimum value in wirewound resistors*

DALE ELECTRONICS, INC. 1300 28th Avenue, Columbus, Nebraska 68601

In Canada: Dale Electronics Canada, Ltd.  
Printed in U.S.A.

Gard Testing is available to meet Established Reliability requirements at significant time/cost savings over typical 100 hr. burn in. Write for Test Report #19590.

# He depends on choppers.



## Astrodata is...



**INSTRUMENTATION PRODUCTS**  
Tens of thousands of standard  
products doing very special jobs.

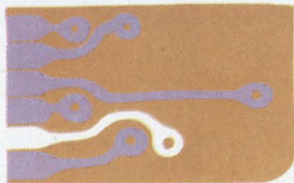

**PRINTED CIRCUIT BOARDS**  
A high quality-high production  
operation using advanced equipment.



**DIGITAL DATA DEVICES**  
The important peripherals for  
today's modern computers.



**INFORMATION SERVICES**  
An advanced software capability  
just leaving the launch pad.

# Astrodata's new amplifier doesn't.

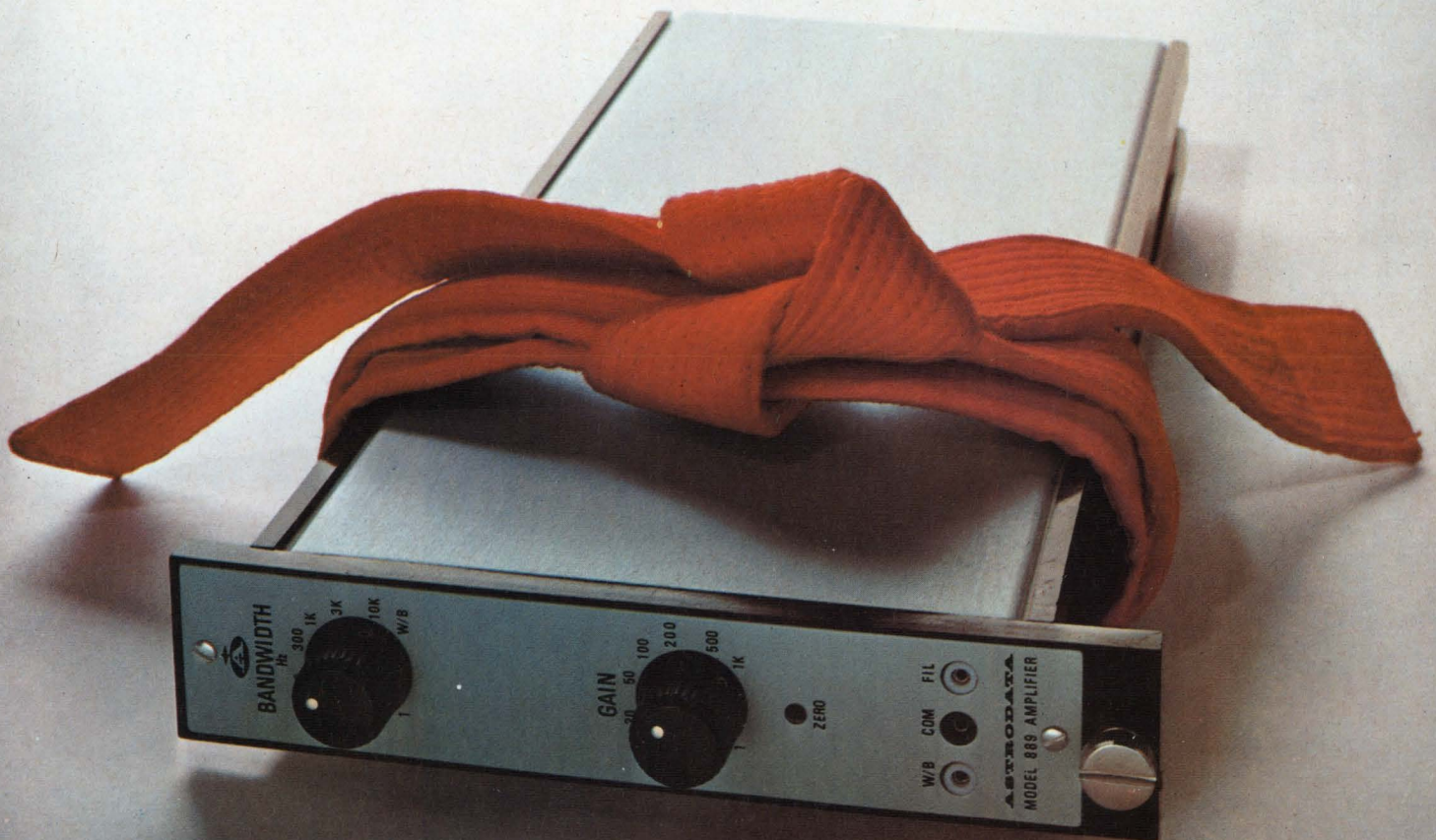

A Karate expert depends on choppers... his hard hands. High performance low level DC amplifiers used to depend on choppers too. But no longer.

Astrodata, by making use of the latest IC developments, has completely eliminated choppers in the new 889 amplifier with absolutely no reduction in accuracy or stability. No increase in drift.

The 889 is a real red belt champion. And you're the winner with lower initial and maintenance costs—smaller size—wider data bandwidth—lower noise—faster recovery and settling time.

Check these specs. No slew limiting to 40KHz. Settling time of less than 150 microseconds. Ideal for dynamic

applications. Gains to 2,500. Differential input current lower than a nano-amp. Perfect for use with low level transducers. Gain stability and linearity of 0.01%. Important in static tests.

Choppers chopped. Price and size chopped too. As low as \$330. And twelve 889 amplifiers fit snugly in just 7 inches of rack space. Even delivery is chop chop. Better than 30 days in quantity.

So chop an X on the reader card and get the full 889 story from Astrodata, who built industry's first all solid-state wideband DC amplifier 8 years ago and have delivered tens of thousands since then.

Astrodata—Space age technology on the industrial grow.



Astrodata, Inc. P.O. Box 3003 240 East Palais Road Anaheim, California 92803 Telephone (714) 772-1000



**DATA AND TELEMETRY SYSTEMS**  
Over 350 systems delivered—more than 100 using digital computers.



**ELECTRONIC SWITCHING SYSTEMS**  
To multiply the capability of the largest communication companies.



**ANALOG AND HYBRID COMPUTERS**  
The largest hybrid systems in the world have been delivered by Comcor.



**TIMING EQUIPMENT**  
Supplying the free world with more precision instrumentation than anyone.



# 25 winners in our collection of op art

nobody, but nobody makes more discrete op amps than Philbrick/Nexus

Philbrick/Nexus is avant-garde in operational amplifiers. Covers the spectrum of op amp capabilities — from mini-cost to maxi-performance. Standard products, as well as mixed products, match your needs economically. Use them. They'll color you bright. Op art masterpieces like these are but a few of the total Philbrick/Nexus exhibit:

## Economy Grade

SQ-10A — MINI-PRICED, but a top performer in general purpose applications. Only \$10.50 each in hundred quantities.

QFT-5 — LOWEST PRICED FET. General-purpose performance, low leakage. Only \$15 each by the hundred.

1009 — LOW COST, HIGH PERFORMANCE FET. Input impedance  $10^{12}$  ohms. Input bias current 5 pA. Priced at \$20.50 each in quantities of 100.

## General Purpose

CIA-2 — LOW PROFILE, HIGH PERFORMANCE. Thick-film hybrid, 80,000 gain,  $\pm 5\mu\text{V}/^\circ\text{C}$  input voltage offset.

SQ16 — HIGH PERFORMANCE. Gain 150,000,  $\pm 5\text{mA}$  guaranteed minimum output at  $\pm 11$  volts. Low noise,  $1\mu\text{V}$  rms broadband.

Q102A — ULTRA-HIGH PERFORMANCE. Gain 200,000,  $\pm 2\mu\text{V}/^\circ\text{C}$  input voltage offset typical at  $-25$  to  $+85^\circ\text{C}$ . Internally trimmed to 0.5mV max.

QFT-2 — TOP-GRADE PERFORMER. Gain 200,000, slew rate  $10\text{V}/\mu\text{sec}$ , 10 pA input bias current.

Q103A — HIGH INPUT IMPEDANCE, LOW BIAS CURRENT. Input voltage offset  $\pm 2\mu\text{V}/^\circ\text{C}$ . Only \$25.50 each by the hundred.

## High Reliability

Q10A — ALL-PURPOSE TOP-GRADE.  $-55^\circ\text{C}$  to  $100^\circ\text{C}$  operating temperature range.

P65A — PREMIUM GRADE. Wide application usage, proven performance, low broadband noise  $1\mu\text{V}$ .

CDA-3A — PROVEN PERFORMANCE. Input bias current 1nA, differential input resistance 2 megohms.

Q25AH — WIDEBAND FET HYBRID. 600,000 hours of operation with no failures. Small size TO-8 package, hermetically sealed.

## Wide Band

PP45U — 100 MHz BANDWIDTH. Slew rate  $200\text{V}/\mu\text{sec}$ . Excellent for broadband inverter applications.

1016 — FAST, HIGH POWER.  $f_p > 1$  MHz. Full output of  $\pm 10\text{V}$ ,  $\pm 100$  mA to 1 MHz. CMRR 100,000.  $E_{os}$  T.C. is  $10\mu\text{V}/^\circ\text{C}$ .  $A_{os}$  at 750,000.

1011 — LOW PROFILE, FAST SETTLING TIME FET. 15 MHz bandwidth, slew rate  $70\text{V}/\mu\text{sec}$ . Delivers  $\pm 11.5\text{V}$  output. Settles in 1.5  $\mu\text{sec}$  to .01%, 0.4 inches high max.

## Universal

ESL-1 — WIDE SUPPLY VOLTAGE RANGE,  $\pm 8$  to  $\pm 16\text{V}$ . CMRR 1,000,000:1, common mode input resistance 1.5 G ohms.

USL-1C — HIGH STABILITY. Wide range of supply voltages from  $\pm 8$  to  $\pm 26\text{V}$ . Input voltage offset  $\pm 1\mu\text{V}/^\circ\text{C}$ . Low drift.

## High Voltage

MLF-100 —  $\pm 100$  VOLT OUTPUT at 10mA. FET input amplifier. Short circuit protected.

## Micro-Power / Low Voltage

Q-200A — BATTERY OPERATED.  $\pm 50\mu\text{A}$  quiescent drain. Ideal for OEM battery operated and airborne instrumentation.

1402 — MICROCIRCUIT FET HYBRID. Bias current 5pA. Input impedance  $10^{12}$  ohms. Output  $\pm 14\text{V}$ ,  $\pm 5\text{mA}$ . Supply voltage from  $\pm 4$  to  $\pm 24\text{V}$ . Quiescent current  $\pm 0.5\text{mA}$ . In TO-8 case, hermetically sealed.

## High Performance

1003 — LOW-NOISE FET. 3,000,000:1 CMRR  $\pm 1\mu\text{V}/^\circ\text{C}$  input offset voltage  $+10^\circ\text{C}$  to  $+60^\circ\text{C}$ . Uses hermetically sealed active components.

1700 — LONG-TERM STABILITY. Input voltage offset  $\pm 0.15\mu\text{V}/^\circ\text{C}$ . Full output to 1.2 MHz. Gain  $10^9$ . Long-term stability .2 $\mu\text{V}$  per day.

1018 — ULTRA-LOW DRIFT. Gain 1.5 meg  $E_{os}$   $0.5\mu\text{V}/^\circ\text{C}$  and  $I_{bias}$  .02nA/ $^\circ\text{C}$ .

## Monolithic IC's

S-52 — LOW, LOW COST IC. Easy to stabilize. Dual in-line package. \$5 each in quantity.

T-52 — A REAL BUY. Same as S-52, but in TO-5 package. Same low price.

Your Best-Of-Show selection brings with it, at no extra cost and available nowhere else — unequalled integrity resulting from superb artistry in things analog. For other op amp prize winners, too numerous to mention, contact your Philbrick/Nexus sales representative for complete specifications, prices and applications assistance. Or write, Philbrick/Nexus Research, 46 Allied Drive at Route 128, Dedham, Massachusetts 02026.

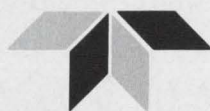

PHILBRICK/NEXUS RESEARCH

A TELEDYNE COMPANY

# What's inside this little black box?

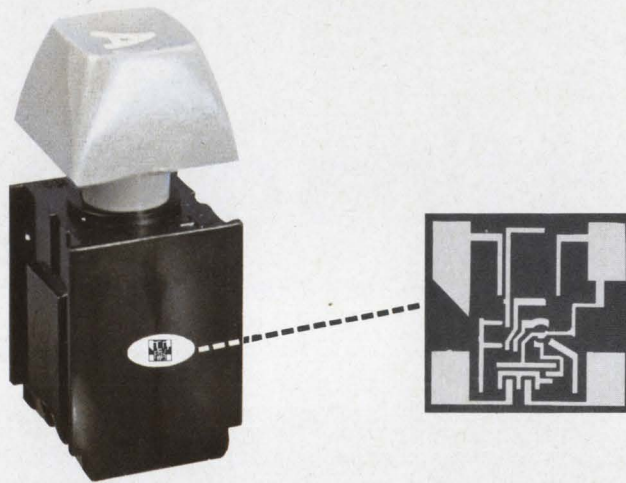

## A breakthrough in keyboard technology from MICRO SWITCH

Inside this key is a new discovery. Using the Hall effect, MICRO SWITCH has developed the world's first practical application of an integrated circuit as a keyboard switching element. An integrated-circuit chip (only .040" square) is actuated with a magnet mounted on a plunger. Thus, MICRO SWITCH has combined integrated circuitry with manual actuation to bring you an all solid state keyboard, unlike any other ever made.

It is called SSK. A keyboard unmatched in reliability, flexibility and low cost!

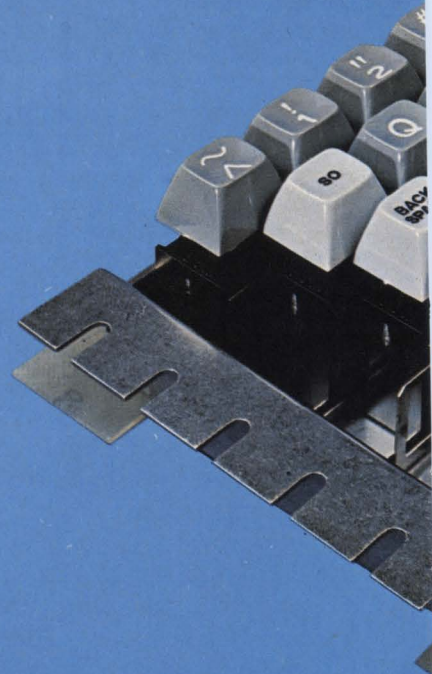





# It makes possible this all solid state keyboard... SSK... the first of its kind

SSK is a keyboard that is compatible with your present *and* next generation communications and data preparation equipment. Assembled, wired and encoded—ready to plug into your equipment.

#### **A breakthrough in keyboard reliability**

From key to connector, every unit of the new SSK keyboard is all solid state. The only moving mechanical part is the plunger. There are no mechanical linkages and no moving contacts to wear or fail. The result is unequalled reliability.

#### **A breakthrough in keyboard economy**

You get triple economy. First, the initial cost is less, tailored to your high production commitments. Second, the bounce-free output of SSK requires no special interface circuitry to adapt it to your equipment; just plug it in. Finally, being solid state, SSK is practically maintenance free; cuts your service costs to the bone.

**All in a completely flexible package!**

**For more facts on MICRO SWITCH SSK,  
turn the page.**

# SSK...a completely flexible package...

MICRO SWITCH solid state keyboard flexibility adapts to your format and encoding needs. All standard key arrays and custom arrays, block or offset. Encoding of any 8-bit code (or less); hexadecimal; Baudot; BCD; USASCII mono-mode, dual-mode and tri-function; plus EBCDIC and custom codes.

You may choose from a complete selection of customized legends and colors. Let us know the control functions you require—we'll match your needs to the letter. There's no reason anymore to compromise for any less—or pay for more—than what you want.

## Featuring the latest human factors considerations...

- A. Two-Key Rollover permits typing at burst speeds without causing a system error output.
- B. Universally accepted truncated keys combined with standard typewriter offset arrangements between rows, permits accurate high-speed typing without hindering the natural flow of operation.
- C. SSK offers sloped key or stepped key rows.
- D. Custom molded-in legends are integral part of button, cannot be obscured by wear.

## Backed by MICRO SWITCH Capabilities

Through advanced design concepts, complete engineering facilities, innovative assembly techniques, and unique quality assurance procedures, MICRO SWITCH is prepared to supply your every keyboard need. This means new reliability and flexibility in mass-production quantities with attractive customized appearance giving new sales appeal to your equipment.

**Make no decisions on keyboards until you see what's happening at MICRO SWITCH. Send the coupon today.**

### SSK MICRO SWITCH

Freeport, Illinois 61032

Dear Sir,

I would like further information about MICRO SWITCH SSK solid state keyboards.

Name & Title \_\_\_\_\_

Company \_\_\_\_\_

Address \_\_\_\_\_

City \_\_\_\_\_ State \_\_\_\_\_ Zip \_\_\_\_\_

Please have a field engineer call. Phone \_\_\_\_\_

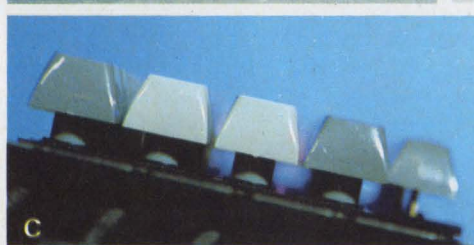
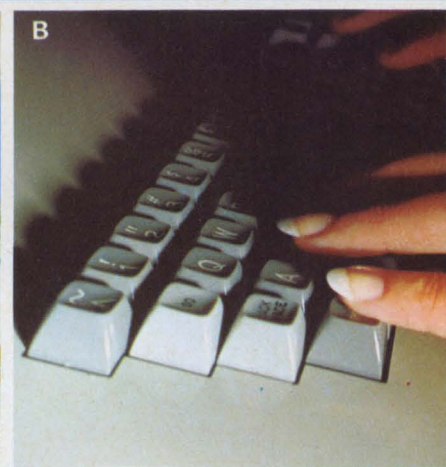
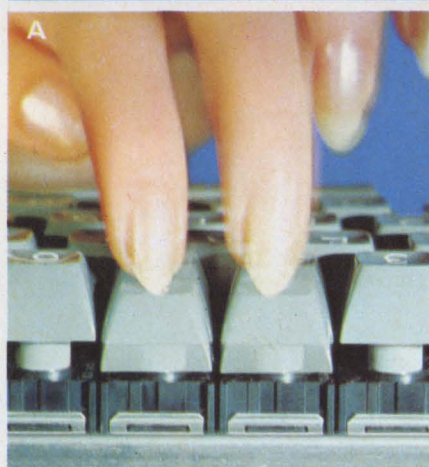

**MICRO SWITCH**  
 FREEPORT, ILLINOIS 61032  
 A DIVISION OF HONEYWELL  
 INFORMATION RETRIEVAL NUMBER 62

## DIODES

### Need Chip diodes? We'll slice them to your spec.

We'll design custom diodes for you, scribe and cut them to your needs and deliver them after a 100% DC test on each chip.

If you're working with hybrid circuits take a look at our capability to supply you with uncased diode chips. We can make them to order and test them to your electrical specs.

Right now, we are supplying chips similar to many popular finished diodes such as 1N3064, 1N3600, 1N4146, 1N4148 and 1N4448. All of these devices are 100% probe tested to DC specs and are checked for AC parameters on a sample

basis. After testing we'll scribe and cut them to your needs and we'll put a suitable backing material on the dice to be compatible with your method of welding or soldering the chips to your substrate.

Typical of the special treatment we can give is the quad N/P diode array we make for a large computer manufacturer. All four devices have a common anode with four separate cathode connections. We can also make quads in the P/N configuration if that's what you need.

Another way we can deliver diodes is as single or multiple chips in a channel pack. We'll give you common anode or common cathode configurations or even hook up some simple circuits such as bridges, ring modulators, etc. Again, all units are 100% tested to your specifications.

If you are looking at chip diodes as space savers in your circuit designs, talk to our sales engineers. You may be surprised at what they can offer you.

CIRCLE NUMBER 300

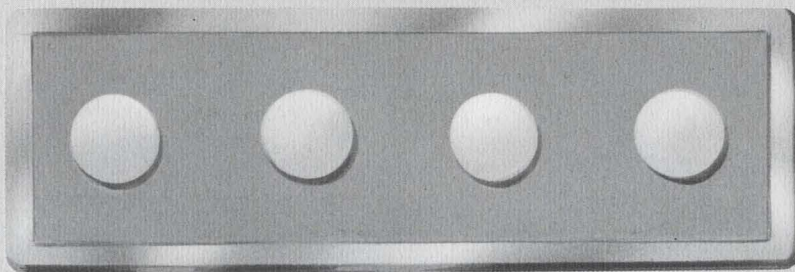

Quad diode array packs four diodes into a minimum of space.

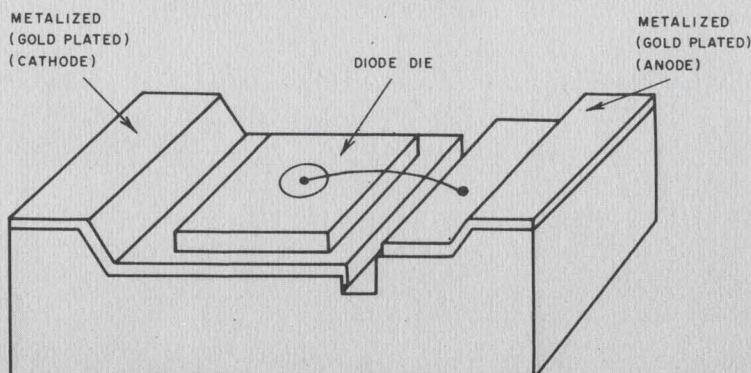

Diodes can be supplied in channel packs for ease of handling.

## This issue in capsule

### Integrated Circuits

Multiplexer/Demultiplexer arrays cut can count.

### Microwave Devices

Beamlead and chip capacitors simplify hybrid circuit design.

### Television

'Instant warm-up' heater speeds picture tube turn-on.

### Manager's Corner

The path to LSI: Who goes first?

### CRTs

Low drain heaters save portable power.

### EL Readouts

How etched leads boost EL bar-graph resolution.

## INTEGRATED CIRCUITS

### Multiplexer/Demultiplexer arrays cut can count.

Two new functional arrays reduce number of gate packages in typical multiplex system from ten to two.

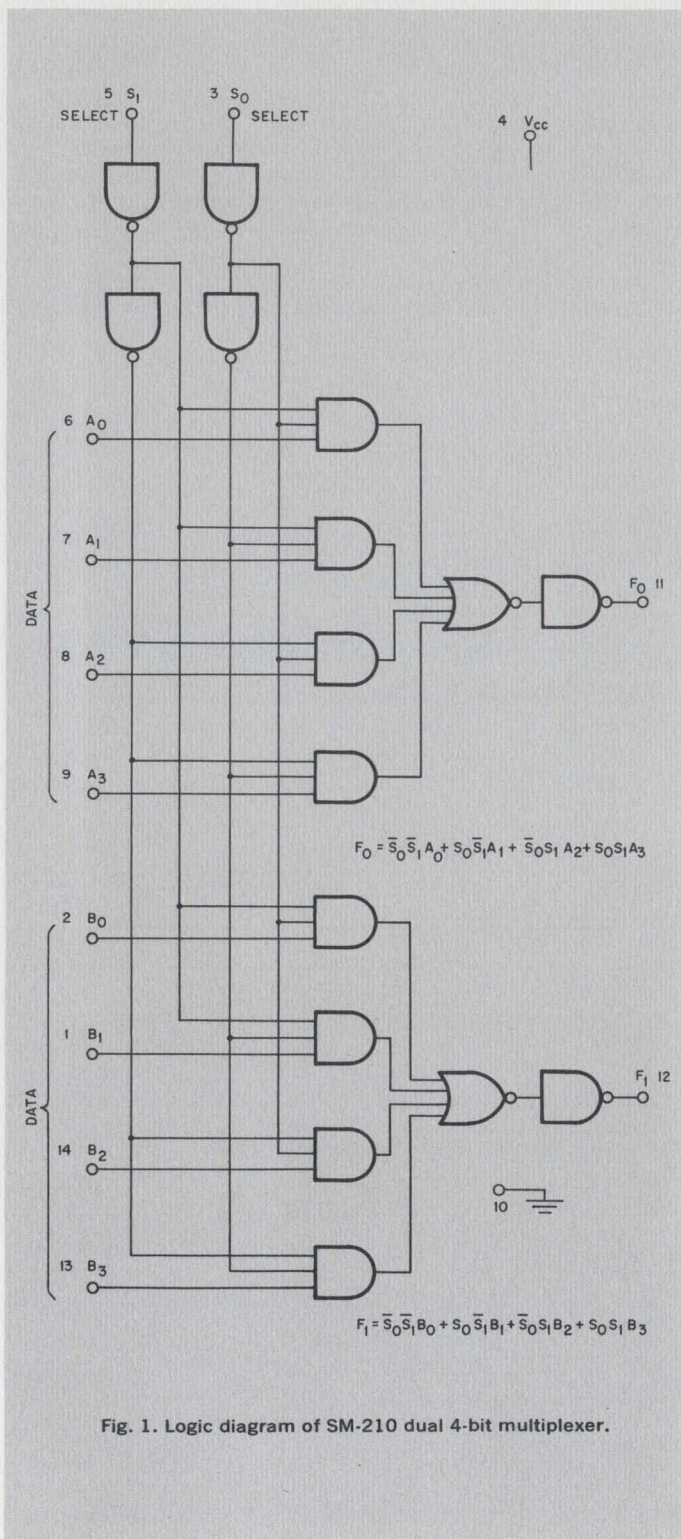

Fig. 1. Logic diagram of SM-210 dual 4-bit multiplexer.

Lower can count, higher speed and less power dissipation are some of the benefits you get from two new functional arrays we have just introduced. The SM-210 is a dual 4-bit multiplexer and the SM-220 is its demultiplexing counterpart. Each replaces up to five gates used in a typical multiplexing operation.

By designing the internal gate structures for speed rather than drive capability we've obtained a high on-chip speed. As a result, propagation delays through several internal gates are comparable to those usually accepted for a single gate. Typically, outputs are produced in less than 12 nanoseconds after the input pulse.

Both devices have the type of inputs and outputs characteristic of SUHL circuits to assure top performance in fan-out, logic swing, capacitance drive, and noise immunity.

Logically speaking, the SM-210 (Fig. 1) is a dual four-bit multiplexer. In each section, two control lines select one of four inputs for presentation at the output. The control lines are common for each section and are buffered from their external connections to prevent excessive loading of drive stages. Data and selection variables are directed to either of two identical quad 3-input AND gates. The results of the "AND"ing are "OR"ed together and double inverted in the output driver stage. The resulting output is the true AND-OR form of the input logic. This means you can drive flip-flops, shift registers, adders and other functions directly, without extra gate inversions.

A typical application of the SM-210 is shown in Fig. 2. This parallel-to-serial converter multiplexes two 16-bit words onto two bus lines. All "A" inputs are bussed into  $F_0$  and all "B" inputs are bussed into  $F_1$ . The selection variables are driven by a four-bit counter. The resultant outputs for each clock pulse are shown in the table. Propagation delay is about 24 nanoseconds from data input to data output and 29 nanoseconds from control input to final output.

This system could be expanded to multiplex two 32-bit words by constructing another identical system and directing its outputs along with  $F_0$  and  $F_1$  into another SM-210.

The SM-220 demultiplexer array performs the inverse operation of the SM-210. It consists of two separate decoding sections. In one section, incoming data may be steered to any one of four identical outputs under control of two selection variables. In the second section, another data input can be routed to either of two identical outputs determined by the state of the selection line.

The logic arrangement of the SM-220 is shown in Fig. 3. In the one-into-four section, four 3-input NAND gates are used, followed by output inverters. Each gate receives the data input along with one of the four possible combinations of the selection bits. The data can be steered to one output only for a particular selection input combination since the connections to each 3-input gate are unique. The output inverter/drivers provide the true states of the input data eliminating the need for extra gate inversions and allowing direct data entry into subsequent stages.

Used as a serial-to-parallel converter, as in Fig. 4, the SM-220 decodes 16 parallel bits onto two bus lines,  $F_0$  and  $F_1$ . The one-to-two section is used in six of the eight SM-220s and the one-to-four section is used in all. The output bits appear in the chronological order of their subscripts, shifting one to the right with each clock pulse. The SG-130 drivers are used to satisfy the input current requirements of the control lines. Propagation delay is about 33 nanoseconds from input to any output. Delay from control input to any output is about 40 nanoseconds.

As you can see, the SM-210 and SM-220 make an ideal pair for multiplexing systems where high speed, low power consumption and a low package count are desired. And where aren't these features important?

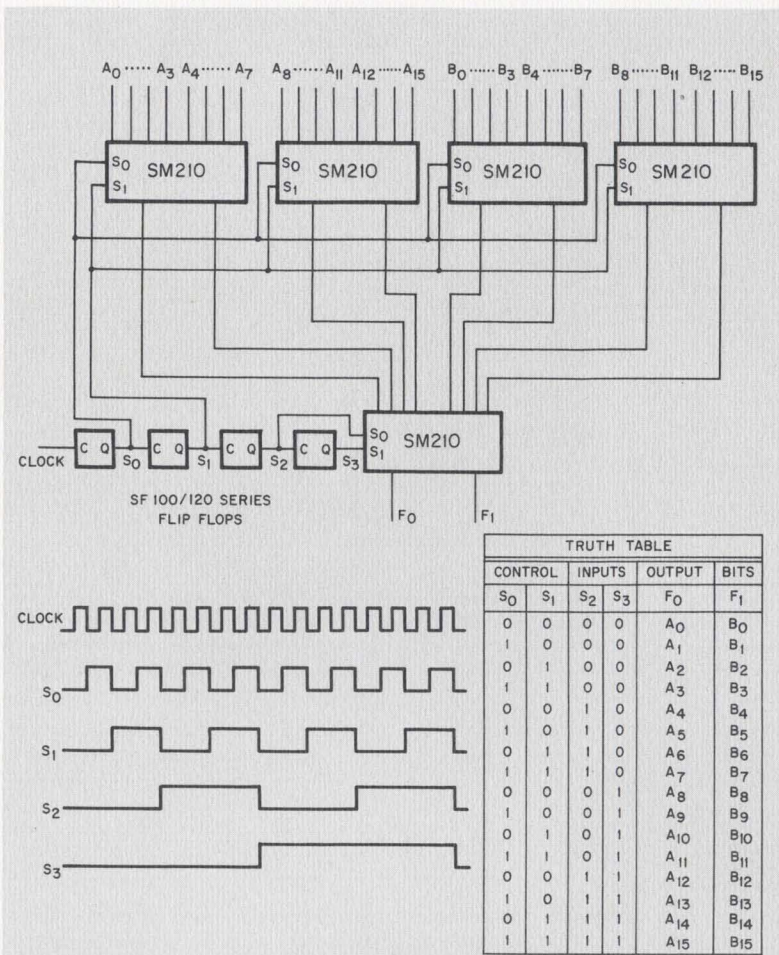

Fig. 2. Application of the SM-210 as a parallel-to-serial converter.

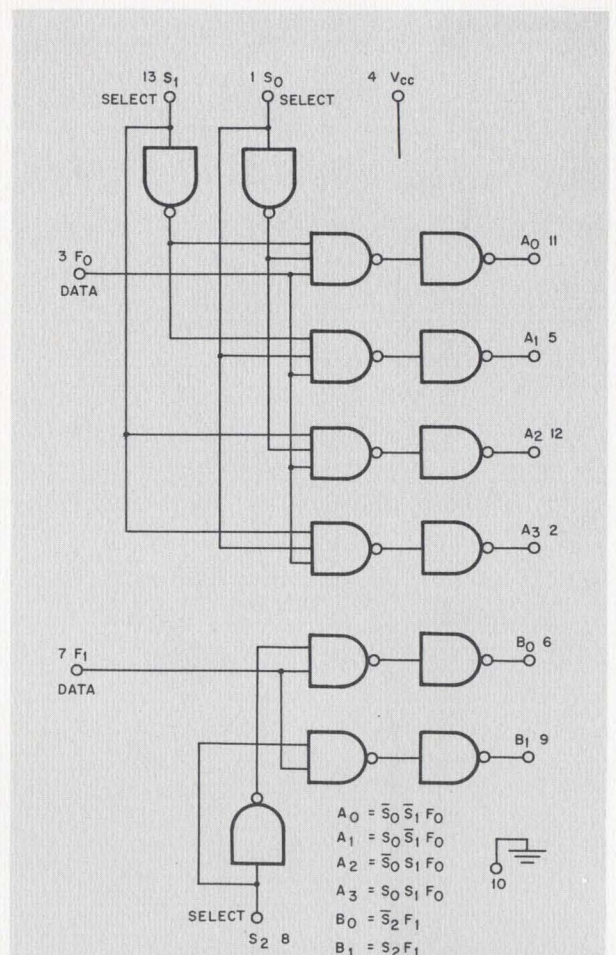

Fig. 3. Logic arrangement of SM-220 demultiplexer.

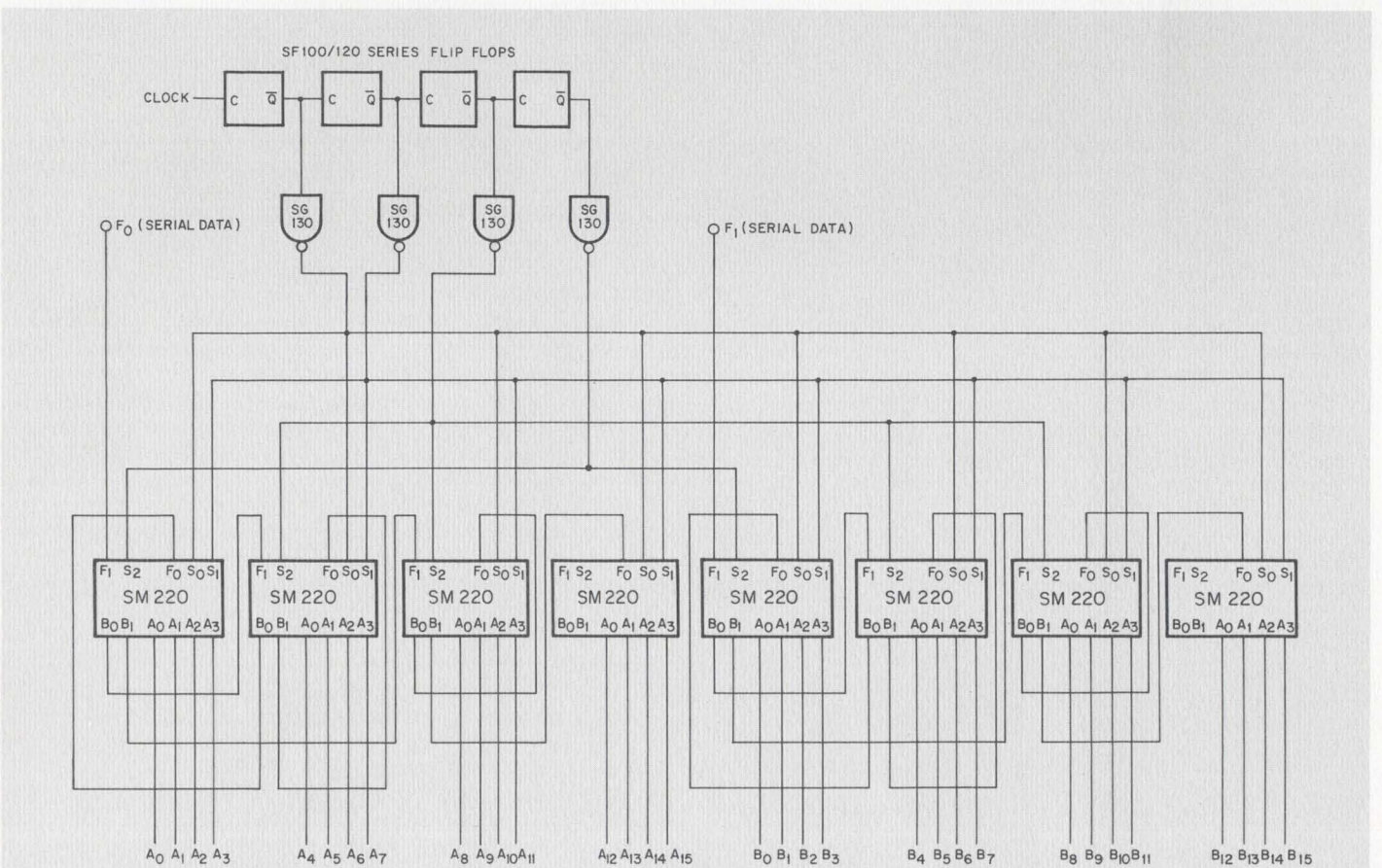

Fig. 4. SM-220 used as a serial-to-parallel converter.

## MICROWAVE DEVICES

### Beamlead and chip capacitors simplify hybrid circuit design.

New devices are ideally suited to use as series and bypass capacitors in microstrip applications.

Two new silicon-dioxide capacitor designs round out Sylvania's broad line of microwave components for microstrip systems.

The SC-9001 series are beamlead devices designed for series circuit applications such as coupling or blocking capacitors. Their mechanical design allows the gold beamleads to be spot-welded directly across a small gap in the microstrip line.

The SC-9002 series of chip capacitors is perfect for bypass applications. The base of the chip can be bonded directly to the ground plane and the other plate of the capacitor can be

connected to the microstrip line by a flying lead. These chip devices have gold metallization pads for ease of handling and bonding.

Both series of capacitors have an RF insertion loss equal to, or better than, microstrip line itself. Among the many applications for the two new capacitors are microwave switches, video detectors, RF and IF amplifiers and limiters.

Keep watching the pages of IDEAS for further developments in our microstrip components line. We expect to be telling you soon about a new resistor that will bring the benefits of beamlead devices to the microstrip world.

CIRCLE NUMBER 302

PACKAGE STYLE	CAPACITANCE RANGE
<b>BEAM LEAD</b>  PACKAGE 146	0.5 TO 2.2 pF
<b>BEAM LEAD</b>  PACKAGE 147	2.2 TO 4.7 pF
<b>BEAM LEAD</b>  PACKAGE 148	5.6 TO 47 pF
<b>CHIP</b>  PACKAGE 149 - 152	* PACKAGE 149 $0.020'' \times 0.020'' = 6.8 \text{ TO } 8.2 \text{ pF}$ * PACKAGE 150 $0.030'' \times 0.030'' = 10 \text{ TO } 22 \text{ pF}$ * PACKAGE 151 $0.040'' \times 0.040'' = 33 \text{ TO } 68 \text{ pF}$ * PACKAGE 152 $0.050'' \times 0.050'' = 100 \text{ pF}$

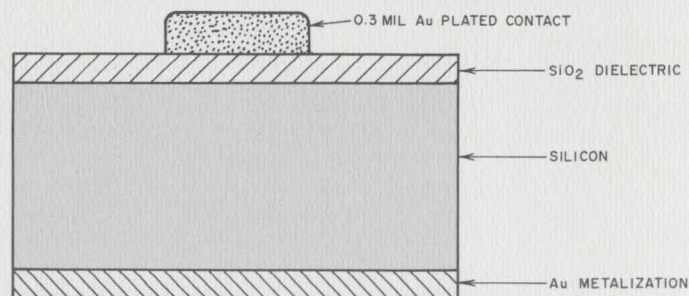

Electrical characteristics:	Beamlead	Chip
Capacitance Range @ 1 MHz	0.5 to 50 pf	6.8 to 100 pf
Temperature Coefficient	200 ppm/°C	200 ppm/°C
Capacitance Tolerance	± 20%	± 20%
Operating Temperature	-55°C to 150°C	-55°C to 150°C
Working Voltage	50 volts min	100 volts min

#### Characteristics of beamlead capacitors

Type number	Capacitance	Package number
SC-9001A	0.5 to 1.0	146
SC-9001B	1.0 to 2.2	146
SC-9001C	2.2 to 4.7	147
SC-9001DM	5.6 ± 20%	148
SC-9001EM	6.8 ± 20%	148
SC-9001FM	8.2 ± 20%	148
SC-9001GM	10.0 ± 20%	148
SC-9001HM	15.0 ± 20%	148
SC-9001JM	22.0 ± 20%	148
SC-9001KM	33.0 ± 20%	148
SC-9001LM	47.0 ± 20%	148

#### Characteristics of chip capacitors

Type number	Capacitance	Package number
SC-9002EM	6.8 ± 20%	149
SC-9002FM	8.2 ± 20%	149
SC-9002GM	10.0 ± 20%	150
SC-9002HM	15.0 ± 20%	150
SC-9002JM	22.0 ± 20%	150
SC-9002KM	33.0 ± 20%	151
SC-9002LM	47.0 ± 20%	151
SC-9002MM	68.0 ± 20%	151
SC-9002NM	100.0 ± 20%	152

## TELEVISION

### 'Instant warm-up' heater speeds picture tube turn-on.

Two-second warm-up time more nearly matches CRT to the turn-on characteristics of solid-state TV receivers.

We've come up with a new directly heated cathode design for television picture tubes that approaches the "instant warm-up" characteristics of modern solid-state receivers. And what's more, it requires so little power that it can be driven by a simple link to the horizontal yoke current.

The construction of the new heater-cathode is shown in Fig. 1. The mounting is designed to give maximum thermal isolation for the cathode. The ceramic support is also carefully designed to act as a thermal sink for the cathode support structure. This maintains a relatively uniform thermal gradient along the length of the cathode ribbon. This is very important for long mechanical life of the cathode.

The cathode itself is a ribbon with an oxide-coated button at its center. Since power input requirements are proportional to the mass of the button, the button area is kept to a minimum.

We evaluated the new instant warm-up cathode in a type 12CSP4 monochrome tube and have come up with some remarkable results. Warm-up time, measured in terms of a

visible raster, was as little as 1½ to 2 seconds. The test tubes do not show any microphonic properties, nor does severe shock appear to change electrical characteristics. Emission levels are satisfactory with maximum currents in the range of 1 mA.

The low power requirements, 0.5 V at 0.800 A, enabled us to experiment with unusual sources of power. In a conventional arrangement, a portion of the DC power supply load current could provide the necessary heater current. But this approach would rule out use of the heater as the element by which the video signals are applied to the picture tube. This important feature can be retained if the heater is driven by means of a transformer in the yoke circuit as shown in Fig. 2.

In this circuit, a half-inch diameter ferrite toroid is used as a one-turn transformer. The primary is the ground return lead. The secondary is formed by passing the heater lead from the picture-tube socket through the core and connecting it to the other heater contact.

The result is a very low impedance source for powering the heater.

The toroidal transformer adds a minimum of capacitance to the video circuit, thus requiring no modification of the output stage peaking components. The low-impedance source is capable of supplying the higher-than-rated current needed when the cathode is cold. Measured warm-up time of the picture tube using this circuit was less than two seconds.

Although it's not yet an off-the-shelf item, our new instant warm-up cathode is definitely out of the experimental stage. We're ready to talk about designing it into your tubes. It can give you the selling feature you need for next year's models.

CIRCLE NUMBER 303

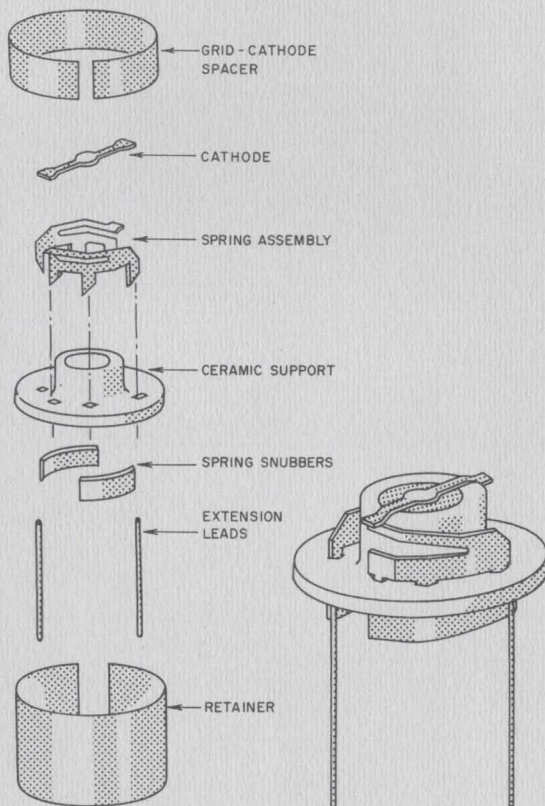

Fig. 1. Construction of the new instant warm-up picture tube cathode assembly.

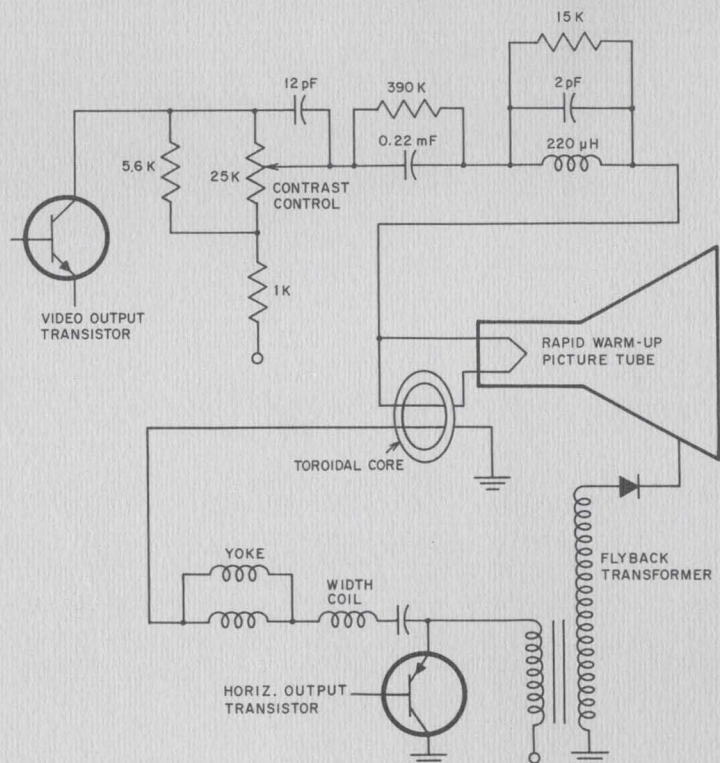

Fig. 2. New heater-cathode can be driven by single-turn transformer from yoke ground lead.

## MANAGER'S CORNER

### The path to LSI: Who goes first?

Perhaps the best analogy to illustrate the relationship between the design engineer and the integrated circuit manufacturer is that of two children daring each other to perform a certain adventurous act. Each one says "you go first."

As the semiconductor technology advances towards more highly complex circuits, the interface between the design engineer and the IC manufacturer becomes more critical. As the situation exists presently, the design engineer risks the design of a complex system based on the assumption that advanced circuit configurations can be fabricated by the integrated circuit manufacturer. The manufacturer, on the other hand, risks the production of a highly complex integrated circuit based on the assumption that the engineering community will use that package in their system design programs.

This could limit the advancement of LSI as a practical technology. The most apparent question is "who should take the first step." Should the design engineer be willing to take the gamble in hardening his design, hoping that the IC manufacturer can achieve the level of sophistication required to meet his IC specifications; or should the manufacturer go out on a limb and provide a more complex IC chip hoping that the engineering community can work with these more complex building blocks?

Actually, the relationship between the design engineer and the IC manufacturer is critical only if we are considering LSI as the immediate objective. If one looks back on the relationship as it has existed in the past, it is obvious that there is an evolutionary trend present. For example, in the past when an engineer intended to use a flip-flop in his system he merely designed the circuit using discrete components. With the introduction of the monolithic integrated circuit, the IC manufacturer decided to package the flip-flop configuration, thereby offering the design engineer a pre-tested building block.

In effect, the IC manufacturer made it possible for the engineering community to approach system designs on a higher level. They no longer were restricted to thinking in terms of discrete components since they now had available a wide assortment of functional blocks. The design engineer can now expand his thinking to a point where his general approach to system design assumes the use of these larger building blocks.

As the monolithic technology matured, the IC manufacturer, hoping to serve the engineering community, approached his packaging concept on a larger scale. If flip-flops could be packaged individually, why not complete shift registers and other similar complex circuit functions? Where once an engineer had to design a shift register by using individual IC flip-flops, he can now obtain this fundamental unit ready made.

Once again, the thinking of the design engineer was allowed to expand to a higher level. In approaching complex

system design, the engineer is now armed with larger and more sophisticated building blocks. This frees the engineer from the burden of having to design and test previously established circuit configurations. With larger, pretested building blocks available he can use his talent, experience and creative energies in the development of a more efficient and effective system.

It should be obvious at this point that the evolutionary trend has arrived, quite naturally, at the present state of semiconductor technology—namely, MSI (Medium Scale Integration). MSI is a natural extension of the monolithic technology, and is a stepping-stone on the path to LSI. It is this fact which lends so much importance to Sylvania's approach in satisfying the needs of the engineering community for more complex and sophisticated building blocks.

Rather than make an unrealistic leap into the production of extremely complex circuit configurations, which could possibly result in a retardation of semiconductor developments (i.e., trying to force the design engineer to work with building blocks far more advanced in sophistication than those which he is used to working with), Sylvania has followed the more natural line of evolution. We are providing the design engineer with integrated circuit configurations designed to allow him to expand his thinking at a more practical and realistic pace. In this way the same goals can be achieved. The level of LSI is approached for complex system design, while at the same time the design engineer can use practical building blocks to design and fabricate systems using present-day specifications.

What it all boils down to is the fact that the integrated circuit manufacturer serves as a high-level packager. He follows the activity of the system's design engineer, continuously observing system developments. The integrated circuit manufacturer then attempts to package larger portions of these systems, thereby freeing the design engineer to rise to higher levels of design approaches, and to think in bigger terms.

The relationship between the design engineering community and the integrated circuit manufacturer is, therefore, regenerative. As systems become more complex, the packaging of larger portions of these systems will follow. As these packages or building blocks are made more complex, the result will be the raising of the design engineer's level of thinking. This, of course, is a limitless process and will lead, in the future, to levels of design sophistication which today are unimaginable.

*Harry Luhrs*

H. M. Luhrs  
Product Marketing Manager  
Integrated Circuits





## EL READOUTS

### How etched leads boost EL bar graph resolution.

Chemical technique allows 50-line-per-inch spacing of bar graph segments, simplifies printed-circuit board connections.

Our recently developed chemical etch technique for making connections to electroluminescent (EL) devices improves the resulting device in two ways. By the use of this technique, we can now produce EL bar graphs with resolutions as high as 50 lines per inch. At the same time, the etched leads make an ideal way to connect the EL device directly to the necessary circuitry by soldering directly to a printed circuit board or to flex circuits.

The chemical etch method allows us to maintain tight control over lead spacing and lead dimensions. Because of this, we can vary the resolution along the length of a bar graph. This allows us to construct bar graphs having a logarithmic characteristic, or any other function desired. Elements of the bar graph can be as small as 0.050" in width.

Using this technique gives us better capability of stacking or making multiple bar graphs on a single substrate. Again, these can have the same or varying resolutions, widths, lengths, etc.

Chemical etch is just another flexibility added to the already high flexibility of EL display devices. In addition to bar graphs, EL devices are readily adaptable to the display of any type of information. For example letters, numbers,

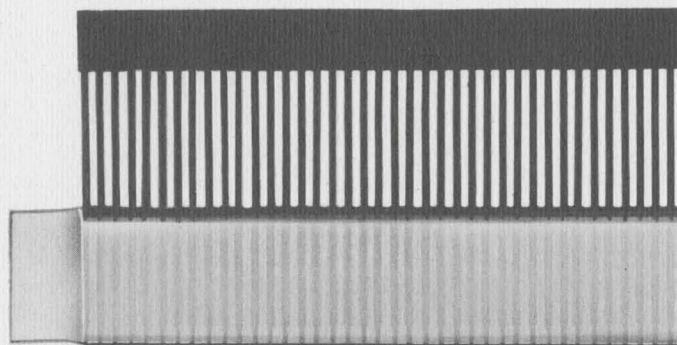

Chemical etch process allows accurate spacing of bar-graph divisions down to 50 lines per inch.

pictorial or analog data displays can be easily designed to meet your specific needs.

New developments in phosphors now enable us to offer EL devices with brightness levels up to 50 foot-lamberts at 250 V, 400 Hz and 25 foot-lamberts at 115 V, 400 Hz. Special glass faceplates allow contrast enhancement to permit viewing under the highest of ambient light conditions.

These features are in addition to the basic characteristics of EL that make it such an ideal display device. EL is a planar display; you don't have to look through a web of non-illuminated characters to see the one that's lit. It is practically immune to catastrophic failure and the spectral characteristic of EL devices closely matches the response of the human eye.

With all these features, isn't EL the best way to solve your display problems? Talk to Sylvania's applications engineers. They will be glad to show you how the flexibility of EL makes it practically certain that a display can be designed to match your exact requirements.

**CIRCLE NUMBER 305**

This information in Sylvania Ideas is furnished without assuming any obligations.

# SYLVANIA

A SUBSIDIARY OF  
GENERAL TELEPHONE & ELECTRONICS

NEW CAPABILITIES IN: ELECTRONIC TUBES • SEMICONDUCTORS • MICROWAVE DEVICES • SPECIAL COMPONENTS • DISPLAY DEVICES

D1

NAME \_\_\_\_\_

TITLE \_\_\_\_\_

COMPANY \_\_\_\_\_

ADDRESS \_\_\_\_\_

CITY \_\_\_\_\_ STATE \_\_\_\_\_ ZIP \_\_\_\_\_

**Circle Numbers Corresponding to Product Item**

300      301      302      303      304  
305

Please have a Sales Engineer call



### HOT LINE INQUIRY SERVICE

Need information in a hurry? Clip the card and mail it. Be sure to fill in all information requested. We'll rush you full particulars on any item indicated.

You can also get information using the publication's card elsewhere in this issue. Use of the card shown here will simplify handling and save time.

# We tossed out the space wasters.



Now you can reduce the size and weight  
of a connector without losing a circuit.



55 #20 contacts, #22 shell.  
Area—2.44 sq. in.  
Weight—1.3 oz.

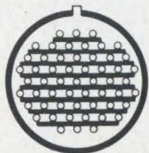

55 #23-22 contacts,  
#16 shell. Area—1.58 sq. in.  
Weight—.9 oz.

Metal clips stood in the way of better connectors. They limited the number of contacts, scratched plating and robbed essential dielectric wall thickness. So we tossed them out.

Our Astro/348<sup>®</sup>, MIL-C81511 connector design replaced them with a contact retention system integral to the dielectric. And an interesting thing happened. Originally developed as a high-density subminiature, Astro/348 turned out to be a better miniature and standard design, too. It packs more contacts into less space than retention devices with metal clips permit.

This simplification created other advantages, too. For example, Astro/348 connectors cost less per circuit than

other present-day connectors. We expect Astro/348 to become the standard connector family for the next decade.

We'd like to demonstrate how the Astro/348 is smaller in size, bigger in performance. Call or write Bob Meade for an appointment. Amphenol Connector Division, 2801 S. 25th Ave., Broadview, Ill. 60153. (312) 261-2000.



**AMPHENOL**  
THE BUNKER-RAMO CORPORATION

# Meet the standard connector family for the next decade

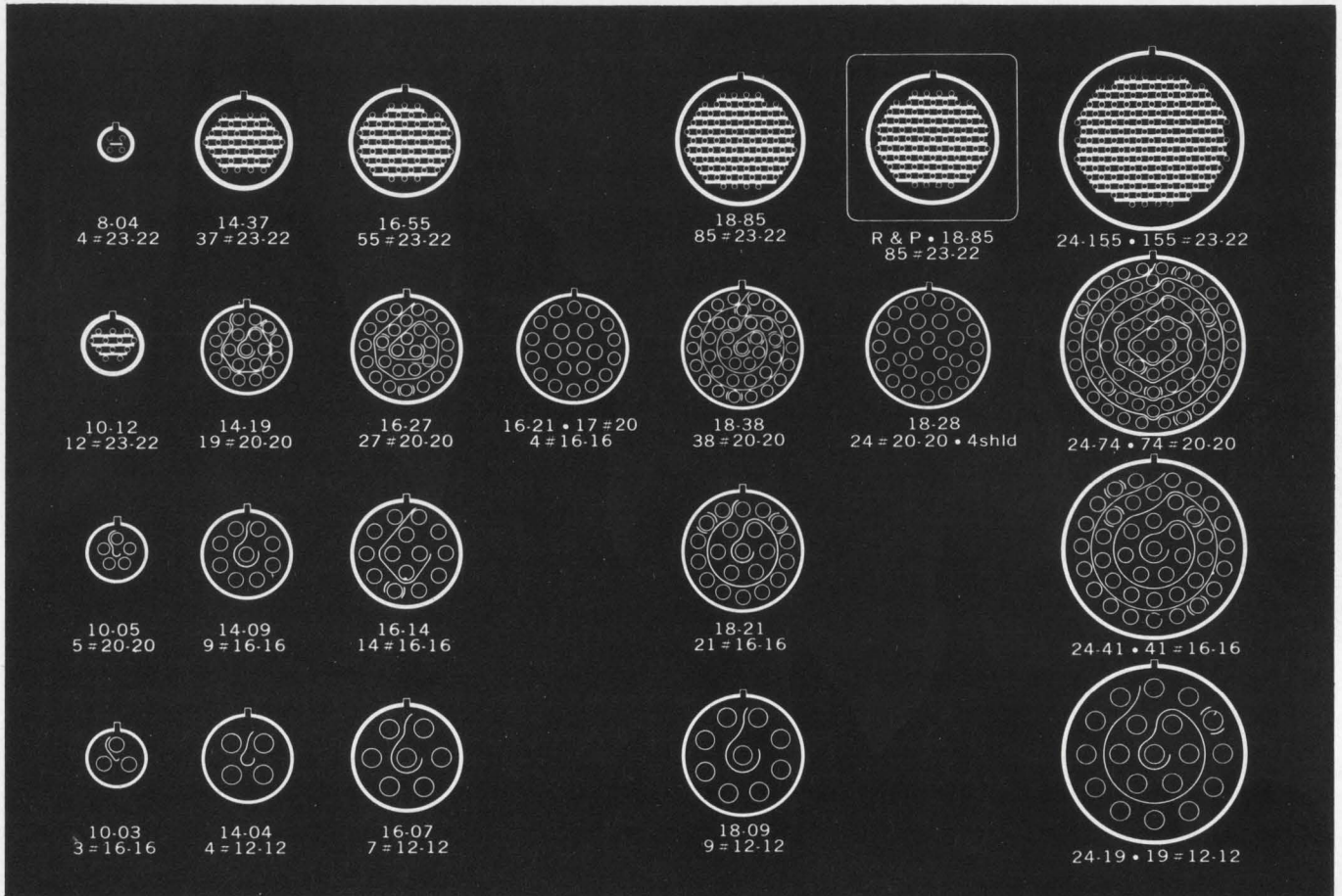

## Astro/348<sup>®</sup> high-density connectors to MIL-C-81511

20-page catalog tells the whole story—For complete details, circle the information retrieval number on this page or write Amphenol Connector Division, The Bunker-Ramo Corporation, 2801 S. 25th Ave., Broadview, Illinois 60153.



**AMPHENOL**

THE BUNKER-RAMO CORPORATION

INFORMATION RETRIEVAL NUMBER 60

# Who says relay specs are dull reading?

Not us. We're sure you'll find the specs of these two popular models positively fascinating. Want more info? Write: 1550 W. Carroll Ave., Chicago, Ill. 60607



**GUARDIAN**<sup>®</sup>

GUARDIAN ELECTRIC MANUFACTURING COMPANY

INFORMATION RETRIEVAL NUMBER 63

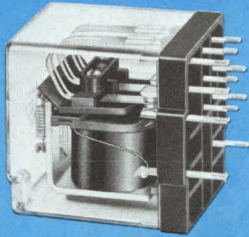

SERIES 1220



SERIES 1300



NO NEED FOR RADIO TYPE PINS

ONE PIECE SWITCH

A.C.

10 AMP

AVAILABLE with MANUAL RESET

available with electrical reset

AVAILABLE WITH TIME DELAY

DPDT OR 3PDT

UL RECOGNIZED

ONLY \$1.85 IN QUANTITIES

3 WAYS TO CONNECT

4PDT

ONE Cubic Inch

CONTACTS 3 AMPS. AT 120 VAC

1.5 OUNCES

TEMPERATURE RANGE -45° +70°C

500 MEGOHMS INSULATION RESISTANCE

AC or DC  
PLUG-IN OR PRINTED CIRCUIT TERMINALS

LEXAN DUST COVER

TESTED FOR OVER 100 MILLION OPERATIONS



## EMCOR has lots of pretty models

Three are from our standard line, the other three . . . well, after all, even EMCOR doesn't have these in its line. But, we can offer "color engineered" EMCOR® Modular Enclosure Systems. ■ Apply the psychology of our new colors singly or in combination to create the atmosphere you want in your installation. For instance, for a relaxing and thoughtful mood use Blue or Olive Green; for a soft, warm feeling use Tan; for elegance, try Gold. Black is dignified, White pure and clean. ■ Our new colors also can be used functionally to codify operations as to input or output information, or to identify operator responsibilities. ■ "Human engineering" is another EMCOR asset. Our "people-watching" engineers studied the human form and have designed cabinets that cut down on mental and physical fatigue for that extra measure of efficiency. ■ Write for more details on EMCOR colors and "human engineering."

EMCOR Reg. U.S. Pat. Off.

EMCOR/colorful cabinetry

**Ingersoll Products** 1221 W. 120th St., Chicago, Ill. 60643

DIVISION OF BORG-WARNER CORPORATION



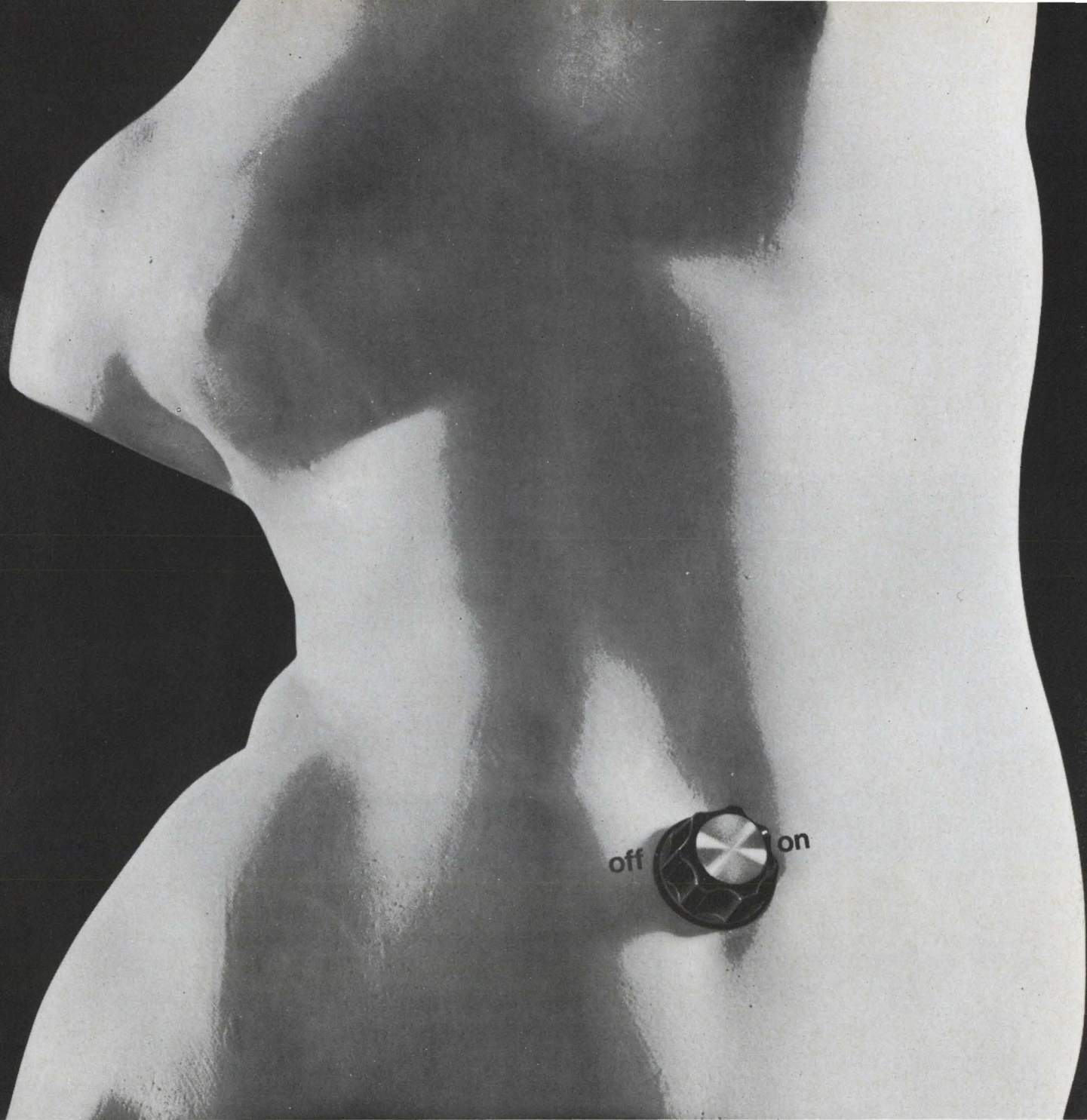

# Kurz-Kasch instrument knobs turn the action on!

A knob is to start something. Or stop it. Or make it faster or or slower. Or more or less.

But a well designed knob on a well designed piece of equipment (electronic or otherwise) does more than this. It not only turns the equipment on—it turns the user on!

After all, the knobs are what an equipment user (and buyer) sees first, last, and most often. If they don't do more for him than turn the equipment on, the whole design leaves him cold.

Kurz-Kasch knob designers know this. They've put together a line of 347 instrument knobs in a variety of sizes, colors and thermosetting plastic materials. Each one is calculated to turn the action on—with *your* equipment, *your* users, *your* buyers.

You can join 4,000 action oriented original equipment manufacturers who already turn on with KK Knobs. Write today for free Kurz-Kasch Designer Catalog.



Write for new catalog  
and free knob samples.



## Kurz-Kasch, Inc.

Standard Parts Division • Dayton, Ohio 45401  
INFORMATION RETRIEVAL NUMBER 66

# when size makes the difference



## Adlake makes the size



Adlake's new AWCM and AWDM Mercury Wetted Contact Relays — Sub-Miniature in size for printed circuit board use (see diagram) provides the answer to the high component density question. Small in size, yet made to Adlake's stringent quality requirements. Depend on Adlake's reliability and this new product to help solve your space problems. Available as contact Form C or contact Form D.

Write, please, for BULLETIN No. MW 5. See us at Booth No. 3342 Design Engineering Show, May 5th — 8th.

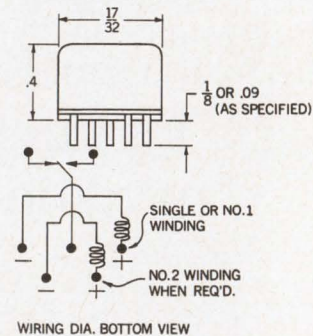
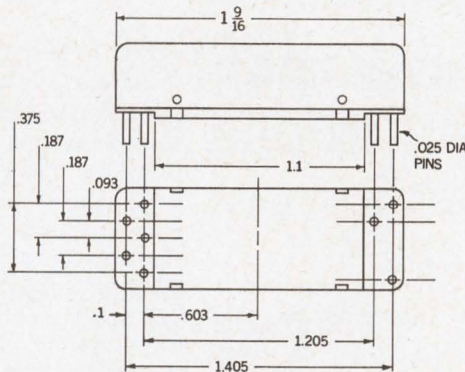

**THE ADAMS & WESTLAKE COMPANY**

A SUBSIDIARY OF **ALLIED PRODUCTS CORPORATION**

ELKHART, INDIANA 46514 • 219 • 264-1141 • TWX 219 • 522-3102 • TELEX 25-8458 • CABLE ADLAKE

Mercury Relays / Architectural Products / Transportation Equipment / Doors and Entrances / Contract Manufacturing



# Products

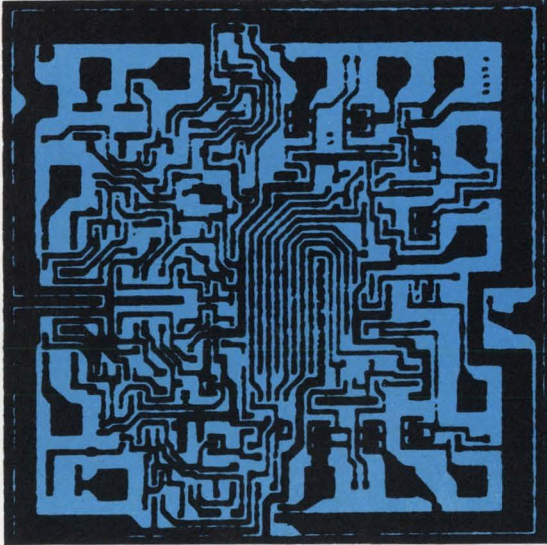

**Complementary-transistor** logic circuits switch with 2-ns gates. p. 112.



**Typewriter-to-magnetic-tape** recording system can be operated by non-EDP personnel, see p. 120.

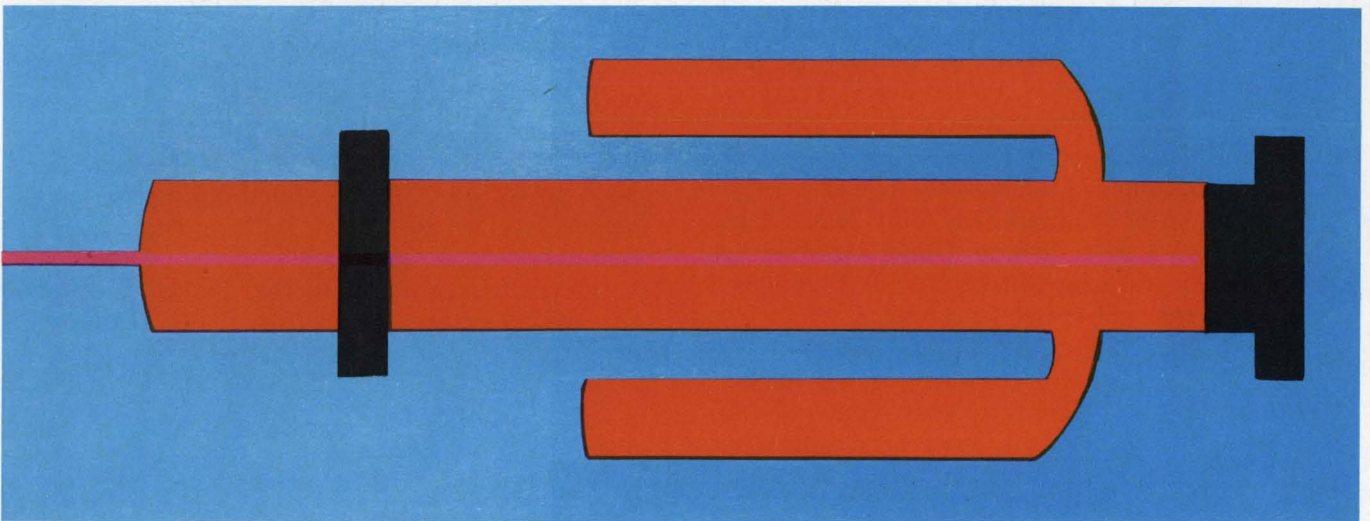

**Field-replaceable He-Ne laser** maintains its alignment within 0.001 in. from unit to unit.

Precision flanges mounted on the plasma tube guarantee precise positioning, p. 114.

## Also in this section:

**Radiation-resistant ICs** are now commercial off-the-shelf devices, p. 124.

**Cermet-element trimmer pot** comes in standard dual-in-line package, p. 126.

**FET-input operational amplifier** stabilizes voltage drift, p. 128.

**Design Aids**, p. 140 . . . **Application Notes**, p. 142 . . . **New Literature**, p. 144.

# Complementary-transistor logic circuits chip away speed ceilings, slash costs

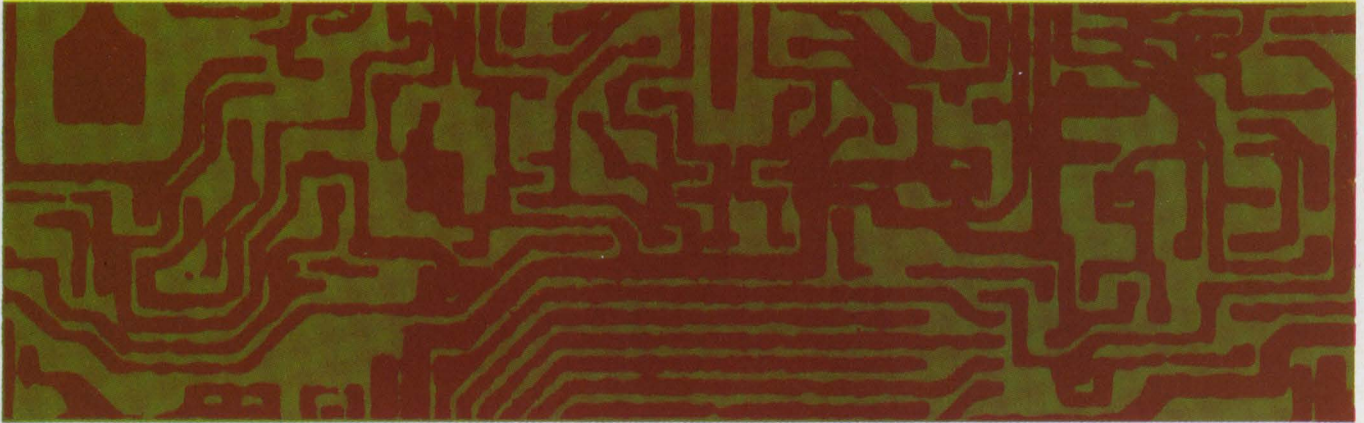

*Fairfield Semiconductor, 313 Fairchild Drive, Mountain View, Calif. P&A: \$1.55 to \$12.05 each for 100 to 999; April, 1969, evaluation quantities.*

Offering the fast performance of current-mode logic at the low prices of diode-transistor logic, a new family of complementary-transistor logic (CTL) integrated circuits operate with individual gate switching speeds of 1.5 to 2 ns. Gate times as fast as these mean over-all system operating speeds of about 4 ns.

Primarily aimed at the computer market, from small desktop units to large-scale systems, series CTL II circuits comprise not only basic logic chips but also MSI functions. Other expected applications for the new family include high-speed test equipment and control systems.

Twice as fast as its family predecessor, CTL I, the new line of ICs employs a processing innovation to yield very high frequency npn and pnp transistors. This results in increased operating speed without significant circuit changes or any power differences from CTL I.

Besides the initial savings realized from their low purchasing price, CTL II circuits reduce system costs by permitting the use of inexpensive packaging techniques with no sacrifice in operating speed. Requiring only two-layer circuit boards, complementary-transistor logic allows the relatively inexpensive method of wirewrapping to be used for connections to the back panel.

Seven basic logic AND gates have a maximum gate propagation delay time of 3 ns. These are the 9853, 9854, 9855, 9864, 9866, 9871 and 9872.

Designed for level restoring and logical inverting functions, two high-speed inverters insure a typical propagation delay of 5 ns at a fanout of

12. The 9852 is a dual two-input NOR gate, while the 9806 is a hex inverting element with a total fanout of 48.

The 9856 is a dual two-input AND buffer gate with typical propagation delays of 6 ns at full fanout of 25. The 9816 is a hex restoring element with typical propagation delays of 5 ns at a fanout of 12. Both circuits have a logic swing of 3 V and a minimum noise immunity of 1 V.

Designed for interfacing with 100- $\Omega$  interconnection lines, the 9819 and 9820 dual line receivers are compatible with the 9821 dual line driver. The 9819 offers a differential input, while the 9820 provides two single-ended inputs. Maximum driver/receiver pair delay is 12 ns and minimum line noise immunity is  $\pm 0.4$  V.

Offering response times that can be controlled through an external capacitor, the 9826 dual line driver and the 9827 dual line receiver meet the requirements of RS-232B and MIL-STD-188B interface specifications. With single-ended outputs, the 9826 driver has a typical propagation delay of 100 ns. The 9827 receiver, which operates with delays of only 120 ns typical, provides a differential-amplifier input with hysteresis to improve noise immunity and allow single-ended transmission reception.

Initiating the MSI half of the family are four circuits: the 9838 one-out-of-eight decoder with two enable lines, restored outputs and a 10-ns address-to-output time; the 9881 eight-input multiplexer with on-chip decoding, data input enable and 15-ns address-to-input time; the 9834 quad latch that writes in 12 ns, reads in 8 ns and has multi-function mode control; and the 9824 four-bit comparator with fully restored and clamped outputs to reduce ringing.

CIRCLE NO. 250

whatever direction  
your design takes...

# Allen-Bradley thick film networks will put you out front in...

**Packaging**—Advanced manufacturing capability covers virtually every type and every configuration of resistive and/or capacitive networks—single or dual in-line, as well as flat-packs, with or without hermetic sealing.

**Characteristics**—Exclusive and patented formulations enable A-B to provide resistance values from 1 ohm to 5.0 megohm. Ratings to 20 watts/in<sup>2</sup> at 85°C. Capacitance values from 10 pfd to 0.5 mfd with voltage ratings to 50 volts. Applications include precision tuned circuits.

**Performance**—Standard resistance tolerance  $\pm 10\%$ . For critical circuitry, tolerances to  $\pm 0.1\%$  can be furnished—with resistances and TC's matched. Temperature coefficient less than 250 ppm in all cases. Special units to 100 ppm or less. Load life stability of 1% in 10,000 hours can be achieved.

**Reliability**—Allen-Bradley has precise control over all raw materials and manufactures all basic components—glasses, organic materials, and substrates. Special machines—designed and built by A-B—assure uniform product quality—at a competitive price.

**Timing**—Allen-Bradley has unique in-plant ceramic facilities. Prototype networks—with or without holes—can be prepared to meet your specific needs. Quickly. Economically.

For more details, write Henry G. Rosenkranz, Allen-Bradley Co., 1201 S. Second St., Milwaukee, Wis. 53204. Export Office: 1293 Broad St., Bloomfield, N.J., U.S.A. 07003.  
In Canada: Allen-Bradley Canada Ltd.

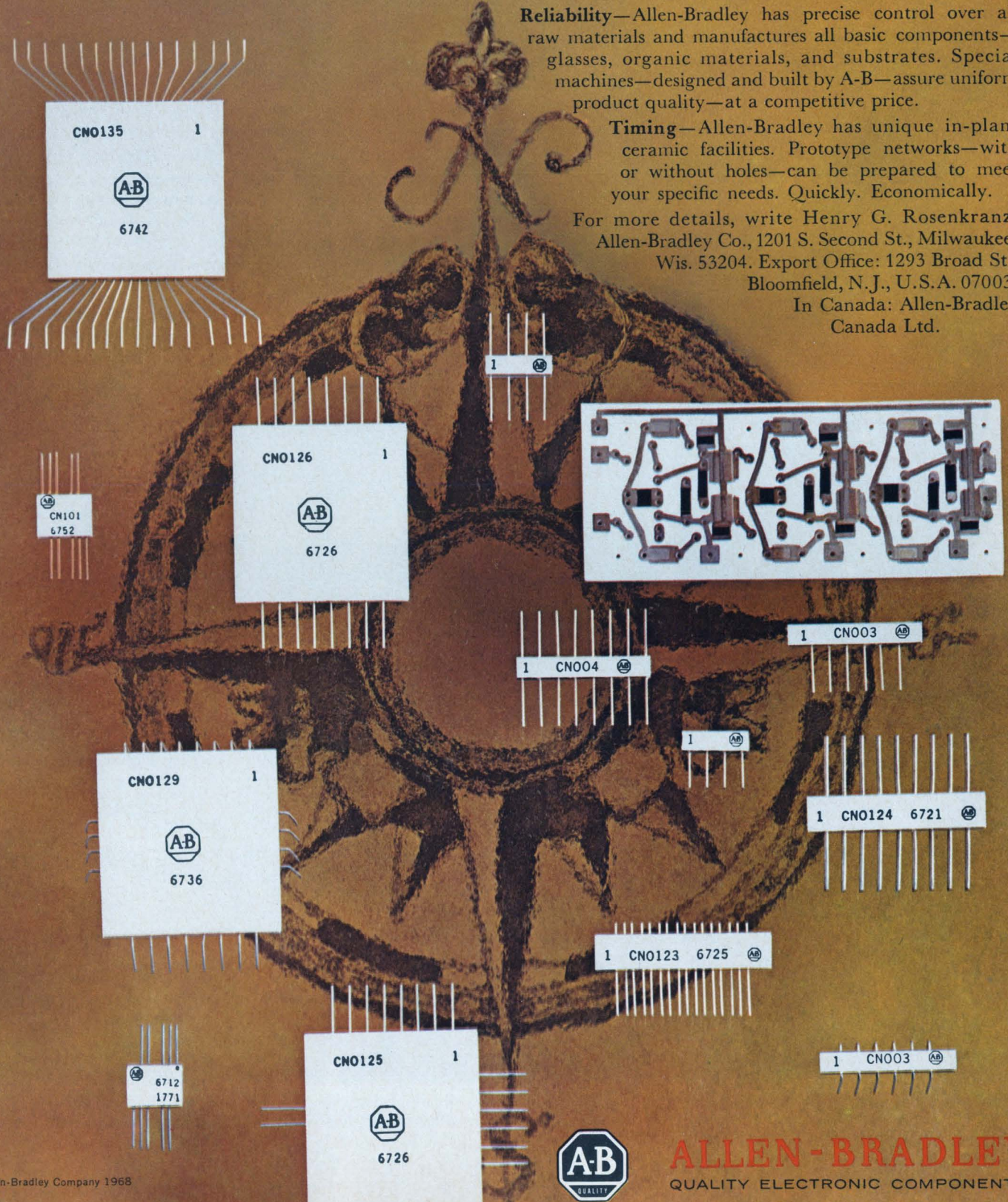

## Prealigned He-Ne laser tubes hold position when replaced

*Univesity Labs., Inc., 733 Allston Way, Berkeley, Calif. Phone: (415) 848-0491. P&A: from \$240; 30 days.*

When precise alignment of a laser tube is required in a systems application, failure of the tube can be costly in terms of downtime. When the tube is replaced it must be realigned by skilled personnel using precision equipment.

Permanently aligned internal-mirror laser tubes have been available for some time, but they could not be replaced without disturbing the orientation of the beam. As a practical matter, it just is not pos-

sible to hold the tolerances of the glass envelope close enough to ensure that the optical center of the laser beam will be coaxial with the glass structure.

Series-25 Lasertron tubes have now been designed to incorporate an end-mounting flange and a holding collar. By precisely locating mounting holes in the flange, it is possible to center the beam on the holes—even though the holes may not be centered on the annealed pyrex tube. With this system, a tube can be replaced while maintaining the output beam to 0.001 inch on center and 100  $\mu$ rad in

angle. Installation of these coherent light sources can be simply and quickly accomplished by any electronics technician.

The laser tube and hardware are supported with three screws on the front locating flange and two screws in the rear for mechanical support; the beam's position and direction is determined entirely by the front flange.

Output powers range from 1 to 5 mW, polarized or unpolarized. These tubes operate in the TEM<sub>00</sub> mode with a beam divergence of 0.8 milliradian full angle.

CIRCLE NO. 251

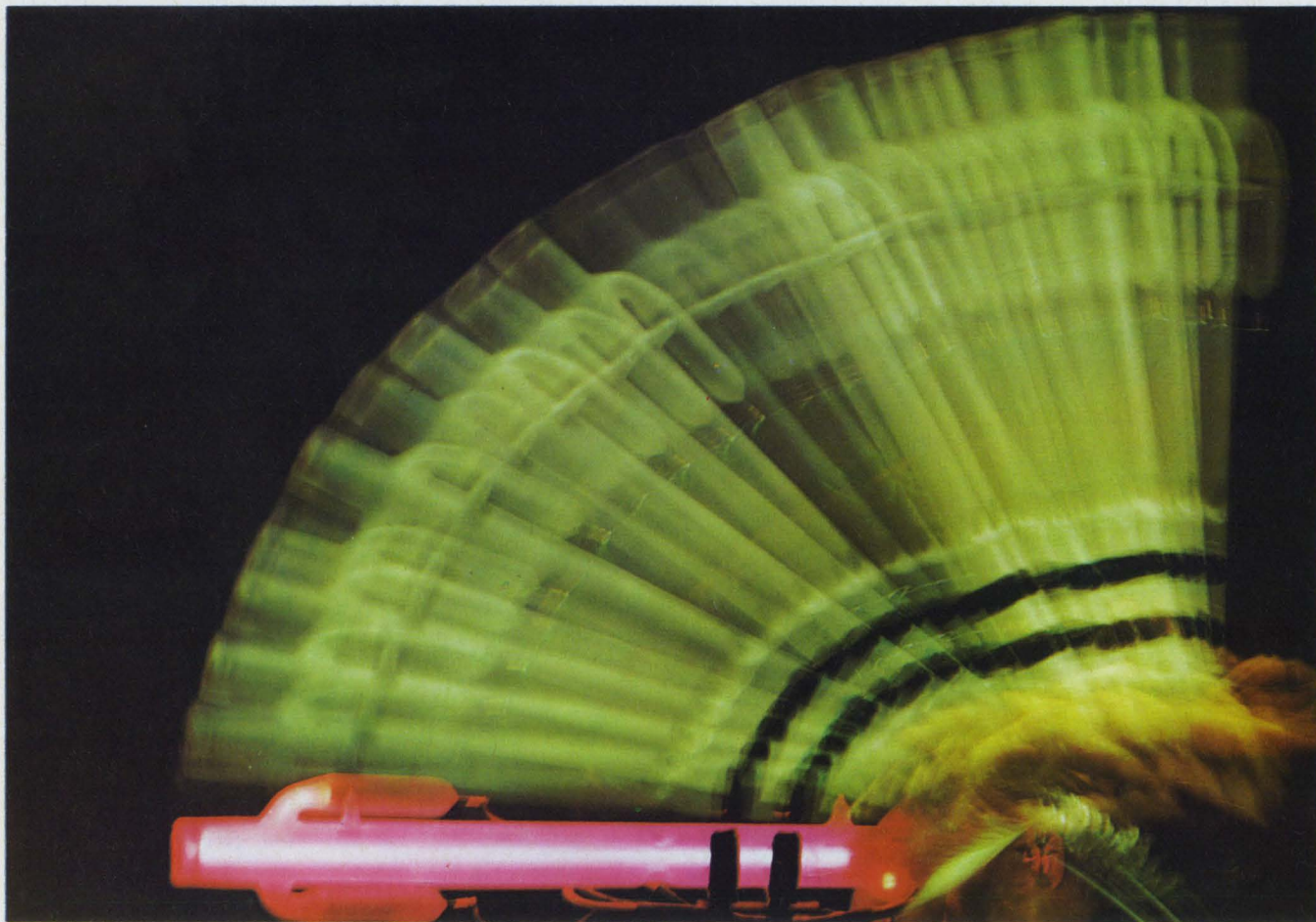

Helium-neon laser tubes can be replaced in as little time as it takes to replace five screws and two electrical connections. Precision flanges allow quick field changes

without disturbing beam-axis alignment. So when a blown tube puts your laser system down for the count, just have your technician slap in a new one.

ALLEN-BRADLEY

Metal-Grid resistor networks  
combine a new measure of

# precision, stability and performance in a sealed, compact package



Precision Metal-Grid resistor network shown  
approximately 1½ times actual size

The advanced capabilities—developed from years of manufacturing Allen-Bradley Metal-Grid resistors—are now applied to a new line of resistor networks. This technology enables the production of complex resistive networks on a single substrate.

Allen-Bradley's exclusive simultaneous deposition method is used to obtain the best resistance tolerance and temperature coefficient matching. The reliability of interconnections on the common resistance plane is incomparable. Uniformity and quality are inherent in A-B networks. To illustrate, 2 PPM temperature tracking is normal.

A-B Metal-Grid networks offer a wide range of values—with individual resistances as low as 25 ohms and as high as 2.0 megohms. Both the inductance and capacitance are low, permitting efficient operation at high frequencies.

A-B engineers will be pleased to cooperate in developing networks for your specific need. For additional details, please write to Henry G. Rosenkranz, Allen-Bradley Co., 1201 S. Second St., Milwaukee, Wis. 53204. Export Office: 1293 Broad St., Bloomfield, N.J., U.S.A. 07003. In Canada: Allen-Bradley Canada Ltd.

#### BRIEF SPECIFICATIONS

##### Resistor Networks

**Tolerances:**  $\pm 1.0\%$  to  $\pm 0.01\%$   
**Resistance Matching:** to 0.005%  
**Temperature Range:**  $-65^{\circ}\text{C}$  to  $+175^{\circ}\text{C}$   
**Temp. Coef.:** to  $\pm 5$  ppm/ $^{\circ}\text{C}$   
**Load Life** (Full load for 1000 hr @  $125^{\circ}\text{C}$ ): 0.2% maximum change

##### Ladder Networks

**Full Scale Accuracy:** 10 bits or less, better than  $\pm 1/4$  least significant bit. More than 10 bits, better than  $\pm 1/2$  least significant bit.  
**Frequency Response:** Less than 100 nanosecond rise time or settling time  
**Temp. Coef.:** Less than 10 ppm/ $^{\circ}\text{C}$   
**Temperature Range:**  $-65^{\circ}\text{C}$  to  $+175^{\circ}\text{C}$

**ALLEN-BRADLEY**  
QUALITY ELECTRONIC COMPONENTS

Now you can revise your thinking  
about the size of latching relays!

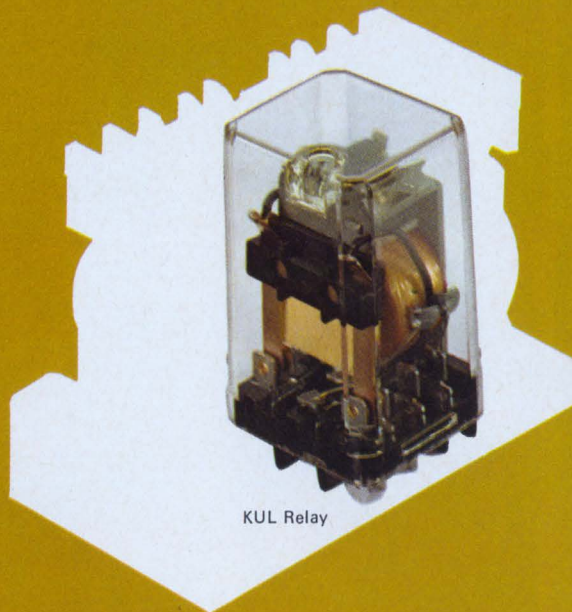

KUL Relay

## New P&B magnetic latching relay cuts mounting space in half

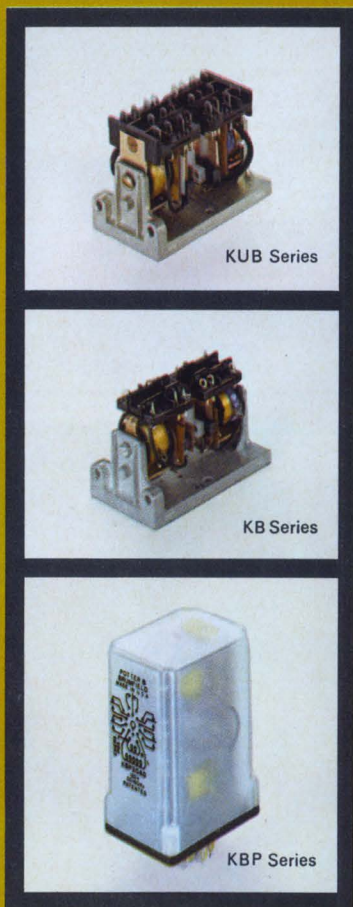

KUB Series

KB Series

KBP Series

Our new KUL takes up only about half the chassis area of mechanical interlocking latching relays. Only one relay is used, not two. The price (starting at \$6.05) is a lot less, too.

The secret? A unique magnetic circuit design. Voila! A small latching relay with excellent memory stability... one designed for continuous duty but which will stay latched without power on the coil. And remember, there are no mechanical interlocking members to wear out.

Single or dual-wound (polarized) coils are available for DC operation to 110 volts. Single coil, two-input, AC units (to 120 volts) employ diodes for pulse separation. Contact arrangements up to 3 Form C are available for switching 5 or 10 amperes. Quick-connect/solder terminals fit nylon socket rated for 10 amperes.

KUL relays are recommended for a host of commercial applications such as process controls, business machines, alarm systems, battery chargers and the like.

### Wide Choice of Other P&B Latching Relays

**KUB SERIES.** Latching relay employs two KU relays. Quick-connect/solder terminals. Coils operate on same or different voltages. Exceptionally rugged, die-cast zinc base.

**KB/KBP.** Two KA relays with mechanical interlocking feature. Solder terminals (KB) or octal-type plug and nylon case (KBP).

Need more information? Call your local P&B sales engineer or the factory direct. Potter & Brumfield Division American Machine & Foundry Company, Princeton, Indiana 47570. Telephone: (812) 385-5251.



POTTER & BRUMFIELD

### High-power switch handles 3.5 kW

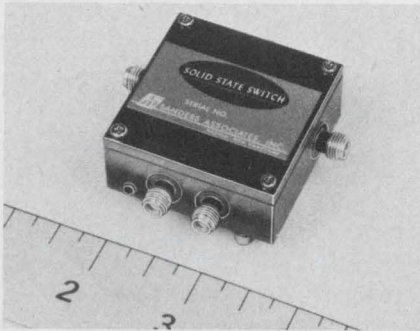

Sanders Associates, Inc., 95 Canal St., Nashua, N.H. Phone: (603) 885-2814.

A high-power switch, model DS-982 SP4T, is capable of switching 3.5 kW of peak power at speeds of 50 ns with less than 2-dB loss in the operating range of 1 to 6 GHz. This solid-state switch, which employs thin-film circuitry, weighs only 80 grams and measures 1-3/4 by 1-3/4 by 3/4 in. It features 25-dB minimum isolation, typical VSWR of 2.5, and operating range of -55 to +100°C.

CIRCLE NO. 252

### High-power rf transistor carries large currents

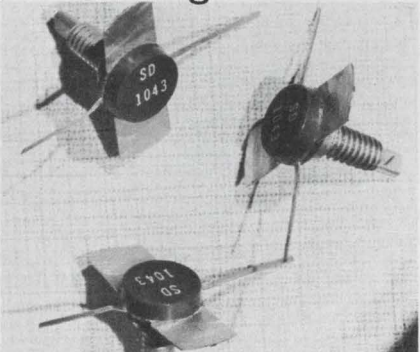

Solid State Scientific Corp., Montgomeryville Industrial Center, Montgomeryville, Pa. Phone: (215) 855-8400. P&A: \$4.85; stock.

A transistor with a multi-emitter electrode design also features a heavily diffused base matrix located between the individual emitters. The result is a high rf current handling capacity and high power gain. The SD1043 is intended for CATV output amplifier applications and has low cross-modulation capability.

CIRCLE NO. 253

### Planar back diodes have low i-f noise

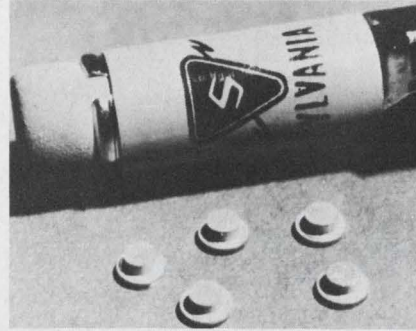

Sylvania Electric Products, Inc., Semiconductor Div., 100 Sylvan Rd., Woburn, Mass. (617) 933-3500. Price: \$25.

A new family of planar germanium back diodes with high sensitivity, low video impedance, and low i-f noise are designed for use as video or short pulse detectors. Offered in a Micro Pill package for stripline applications, the diodes are also available in other configurations or in chip form. The new family of back diodes comprises the D5610 (S-band), the D5611 (C-band), and the D5621 (X-band).

CIRCLE NO. 254

### Pulse-height detector measures spike leakage



Varian, Solid-State Microwave Operation, Salem Rd., Beverly, Mass. Phone: (617) 922-6000.

A microwave pulse-height detector has been developed to permit precise measurement of the spike leakage from TR tubes. Earlier methods of measurement erroneously assumed that the amplitude of the leakage spike is the same on a pulse-to-pulse basis. The new device permits counting of each pulse having an amplitude above a preset level.

CIRCLE NO. 255

**LOOKING BEYOND THE "SPECS" WITH P&B**

*This 4PDT Power Relay enables you to fit 4 poles where 2 fit before*

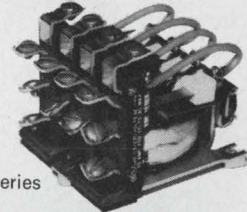

PM Series

This compact, heavy-duty 4PDT power relay is designed to occupy about the same space as a conventional 2-pole relay. It's available with a wide range of operating voltages for a host of single phase and polyphase heavy-duty switching applications. There are three versions: The PM standard series with screw type terminals, the PMT with quick-connect terminals, and the PMC with plastic dust cover.

Mechanical life is in excess of 10 million operations at a maximum of two cycles-per-second with 50% dwell time. Buzz-free operation throughout the life of the relay is assured by a unique armature design. Standard coil operating voltages range from 6 to 480 volts AC, 50/60 Hz or 6 to 110 volts DC. The standard PM series relays are listed by Underwriters' Laboratories and Canadian Standards Association.

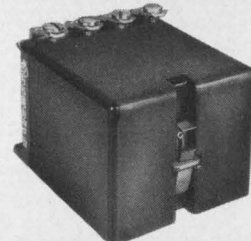

PMC, with plastic dust cover. Also available with metal cover.

**PLUS P&B Capabilities and Facilities that insure**  
 ■ Controlled Quality ■ Reliability  
 ■ Long Life ■ On Time Deliveries

**AMF**  
**POTTER & BRUMFIELD**  
 Division of American Machine & Foundry Co.  
 Princeton, Indiana 47570

INFORMATION RETRIEVAL NUMBER 71

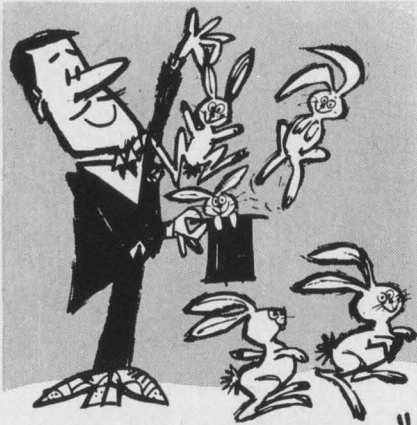

## "Black Magic" FROM Plastic Capacitors

### NEW "LQ" Series OIL-FILLED CAPACITORS FOR MEDIUM AND HIGH VOLTAGE APPLICATIONS



- Voltage range, 1000 to 10,000 volts DC
- Power Factor, 0.5% at 60 and 1000 Hz.
- Peak to Peak Ripple Voltage, 20% of DC Voltage Rating
- Designed for continuous operation of 10,000 hours at 65°C
- Black phenolic shell, epoxy end fill
- Axial wire lead terminations
- Excellent corona characteristics

Here's new "Black Magic" from PC, delivering more power and reliability at extremely low cost. Compact size and stability increase their versatility. Quality construction assures peak performance. Intensive testing to insure field performance applications unlimited.

Write for free samples and complete engineering data today!



**Plastic Capacitors**  
INC.  
2620 N. Clybourn • Chicago 14, Ill.  
DI 8-3735

## MICROWAVES & LASERS

### Rf power transistors work at 12.5 volts

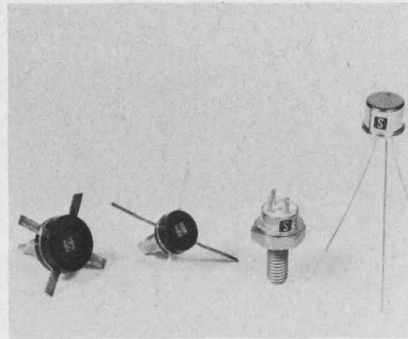

Soliton Devices, Inc., Transistor Division, Riviera Beach, Fla. Phone: (305) 848-4311.

Silicon rf power transistors and kits that operate at 12.5 V are now available. The transistors, which include types 2N5421, 2N5423 and 2N5424, are packaged in TO-5 and grounded-emitter TO-60 cases. The kits consist of three to five devices, and deliver up to 40 W from a parallel pair of outputs at a frequency of 175 MHz. They are packaged in plastic strip-line cases.

CIRCLE NO. 256

### Sweeper plug-ins put out 16 dBm



Wiltron Co., 930 East Meadow Dr., Palo Alto, Calif. Phone: (415) 321-7428. P&A: \$2950; 6 wks.

Developed for communications applications, two new sweeper plug-ins maintain a full 16 dBm of output power over their entire frequency bands. Model 6120 covers the range of 3.6 to 4.3 GHz, while model 6122 operates from 5.9 to 6.4 GHz. Each of these solid-state sources holds spurious signals down over 30 dB and harmonics over 40 dB. Level variation across the band is  $\pm 0.25$  dB.

CIRCLE NO. 257

### Microwave synthesizer covers 1.2 to 2.4 GHz

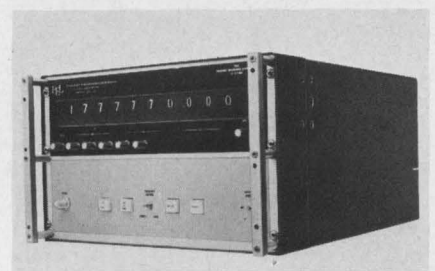

Frequency Engineering Labs., Farmingdale, N.J. Phone: (201) 938-9221. P&A: \$15,950; 16 wks.

Model 700B synthesizer operates over a frequency range of 1.2 to 2.4 GHz and is suited to unified S-band telemetry systems, remotely programmable test stations and frequency agile radar. The selection of remote or local operation can be made with a single front-panel toggle switch. Tuning increments to as fine as 1 Hz are optional. Frequency stability is two parts in  $10^9$  per day.

CIRCLE NO. 258

### Rotary attenuator holds VSWR to 1.2

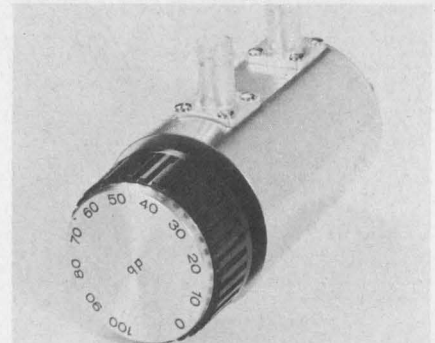

Texscan Corp., 2446 N. Shadeland Ave., Indianapolis, Ind. Phone: (317) 545-2101. P&A: \$140; 2 wks.

With attenuation levels ranging from 0 to 100 dB in 10-dB steps, the RA-100 rotary attenuator covers the frequency range of dc to 1200 MHz with a VSWR of 1.2 maximum at 1000 MHz. The unit has an impedance of 50  $\Omega$  and is available with BNC, TNC, type N and STM connectors. The RA-100 occupies a minimum of behind-the-panel space; it is 1-7/8 in. in diameter and 2-15/16-in. long.

CIRCLE NO. 259





**Here are four Acopian power supplies...  
two singles and one dual.**

Where your equipment or system requires more than one regulated DC output, you can save space, weight and cost by using Acopian duals. Acopian duals consist of two independent regulated power supplies housed in a single plug-in case. They occupy less space than two separate modules, require only one socket instead of two, and cost less, too. Whether you need two identical outputs, such as required for powering operational amplifiers, or two different voltages, Acopian offers you a choice of 80,000 combinations.

Acopian duals also save you time. Shipment is guaranteed within three days after receipt of order. For information on the complete line, ask for the brand new Acopian 1969 catalog. Write Acopian Corp., Easton, Pa. 18042 or call (215) 258-5441.



## COUNT- PRINTER

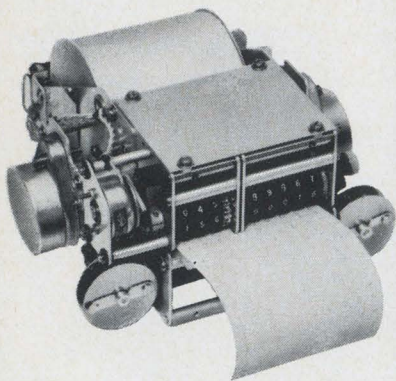

### FOR DIGITAL RECORDING OF COUNT TOTALS & TIME INTERVALS

Combining simplicity and economy, the MFE Count-Printer provides the ideal solution to your digital recording needs. Effective features include: immediately visible print-out, continuous count indication, one or two channels, plus optional internal rectifier and time counting.

This unit will soon be available as a **printing digital voltmeter**. In this configuration, it may readily be customized for your OEM applications.

### HIGHLIGHT SPECIFICATIONS

- Portable or Rack Mount
- One or Two Channels
- Three to Six Digits per Channel — Eight Maximum
- Actuation by External DC Voltages or by Contact Closure with Optional Internal Rectifier
- Max. count rate 600/min.
- Max. reset rate 12/min.
- Max. print rate 60/min.
- Visual Display of 1/8" high digits
- Optional Print & Reset Buttons
- Optional Time Solenoid

**For details on how you may use the MFE Count-Printer, contact us with your requirements now.**

# MFE

MECHANICS FOR ELECTRONICS, INC.

Telephone (617) 864-8130  
152 Sixth St., Cambridge, Mass. 02142

INFORMATION RETRIEVAL NUMBER 74

## Typewriter-to-tape system prepares computer data

*R J Communication Products, Inc., 9827 N. 32nd St., Phoenix, Ariz. Phone: (602) 948-6310. P&A: \$4600; 60 days.*

Using a conventional keyboard, the RJ DS-10 typewriter-to-incremental-magnetic-tape-recorder system makes it possible for non-EDP oriented personnel to prepare computer compatible data. A simultaneous hard copy is produced so that recorded data may be visually verified on the spot. Unlike punched-card or paper-tape equipment, the recorder is virtually silent and may be used in a regular office environment.

Either an IBM BCD heavy-duty Selectric or an IBM model B may be ordered as the typewriter element of the system. Either machine may be used for general office purposes.

Input circuits, specifically designed for each typewriter, per-

form the necessary code conversions to adapt the typewriter output to the standard magnetic tape, BCD code. This tape is directly usable on low and medium density, seven-track computer tape handlers with no intermediate conversion steps.

The recorder supplied with the system is a DELTA-CORDER IIA, six-inch reel, incremental magnetic recorder. Available as extra-cost options are units that accept 8-1/2- and 10-1/2-in. reels.

An on-off switch located on the typewriter permits the operator to make both data and non-data, hard-copy entries without disturbing the position of the tape with respect to the recording head. Single- or multiple-line record formats are available using precoded end-of-record characters on the keyboard.

CIRCLE NO. 260

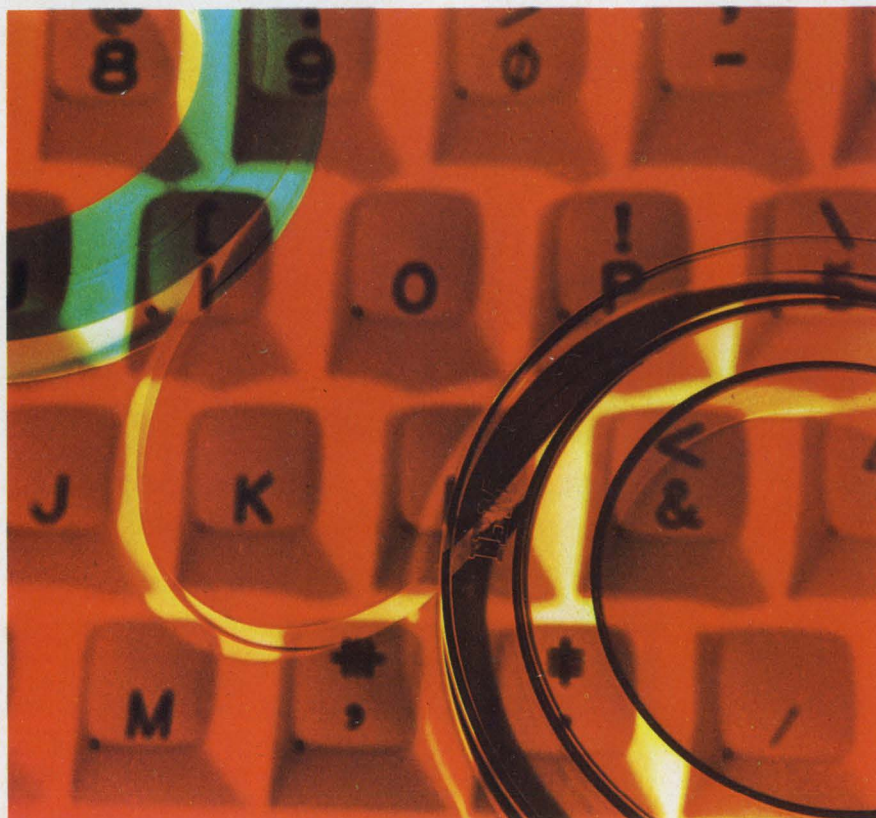

From keyboard-to-recorder is the concept embodied in a new system that allows office personnel to record computer compatible data on magnetic tape.



## Ever wonder how you keep a secure line from being bugged?

In a secret communications situation, the security of your teletype, telegraph, telephone and other signal lines is critical.

The solution is to guard security with Filtron Fil-Tel® filters, which are designed to meet the newest Military Communication Agency's Red/Black specifications. Used in conjunction with protected and shielded facilities, Filtron Fil-Tel filters for voice, digital, light, and controlled circuits provide the required intelligence security you need. They remove spurious energy, and provide a continuous RF-tight shield for every signal transmitted or received. As

with all Filtron shielding and filtering products, construction of the Fil-Tel line is of the highest quality. All units are hermetically sealed, and housed in hot-tinned steel cases ready for fast mounting. Assemblies of any combination of filters are available, completely pre-wired to standard terminal strips and enclosed in an RF-tight cabinet.

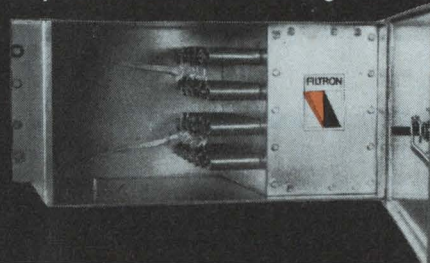

The Red/Black insignia on Filtron's "Fil-Tel" line is our guarantee of superior communications security performance. For a complete, informative listing of our Red/Black secure communications devices and shielded enclosures, write for our new 24-page catalog, No. P-68.

### FILTRON COMPANY, INC.

131-15 Fowler Avenue,  
Flushing, N.Y. 11355 (212) 445-7000

Subsidiary of  
Liquidonics Industries, Inc.

INFORMATION RETRIEVAL NUMBER 75



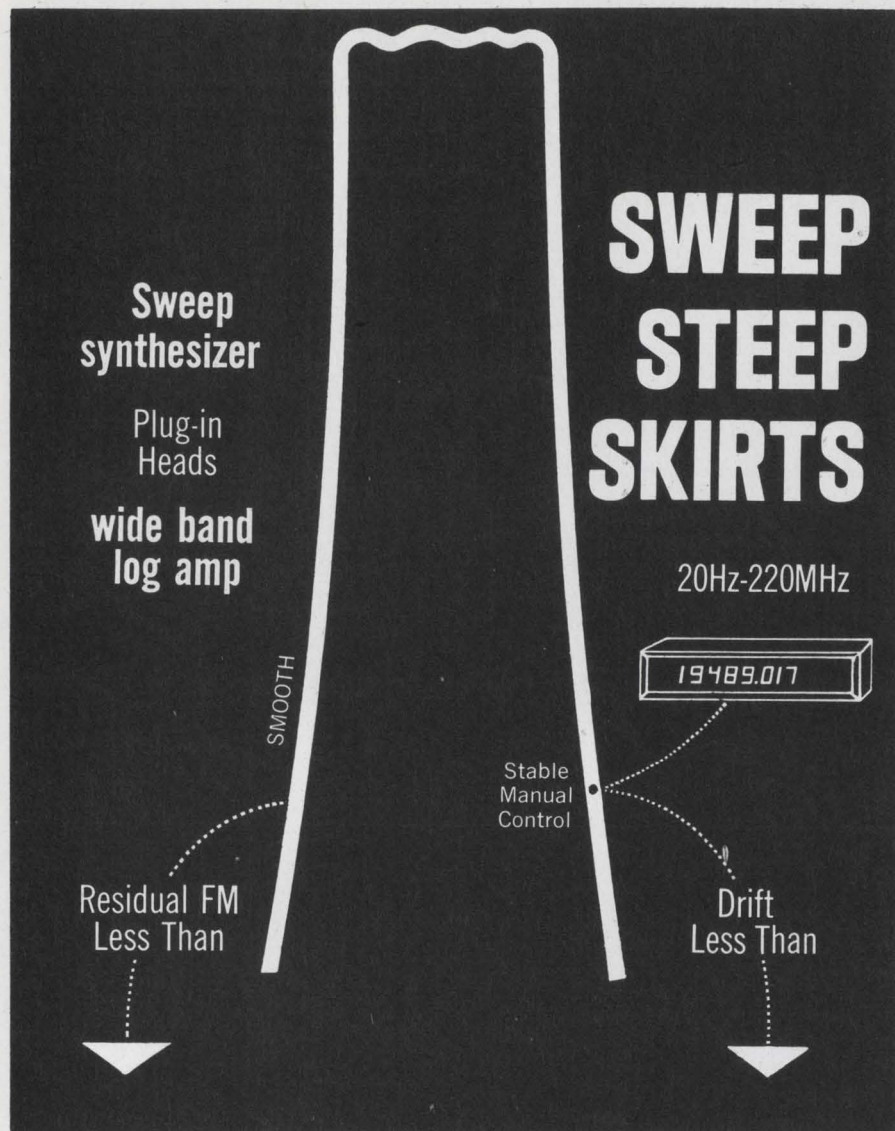

# SWEEP STEEP SKIRTS

Sweep synthesizer

Plug-in Heads

wide band log amp

20Hz-220MHz



Stable Manual Control

Residual FM  
Less Than

Drift  
Less Than

10Hz @ 10MHz  
40Hz @ 70MHz

**Sweep Synthesizer**  
100KHz-70MHz

5ppm/min,  
20ppm/hr.

**\$4065** includes 100MHz wide-sweep

0.5Hz,  
overall

**Sweep Plug-in**  
20Hz-200KHz

3Hz/min,  
15Hz/15 min.

**\$505** includes 20KHz wide-sweep\*

1.0Hz,  
overall

**Sweep Plug-in**  
100Hz-2.0MHz

30Hz/min,  
120Hz/15 min.

**\$400** includes 2.0MHz wide-sweep\*

100Hz,  
overall

**Sweep Plug-in**  
10KHz-115MHz

500Hz/min,  
3KHz/hr.

**\$630** includes 100MHz wide-sweep\*

10Hz @ 5MHz,  
75Hz @ 100MHz

**Sweep Plug-in**  
2MHz-220MHz

200Hz/min,  
@ 12MHz.

**\$475** (tentative specs)\*

**Log-Amp**

20KHz-220MHz, 80 db  
Hi-Z input, **\$845**

\*plug-in rack \$525, markers extra

## KAY ELECTRIC COMPANY

MAPLE AVENUE, PINE BROOK, N. J. PHONE (201) 227-2000

INFORMATION RETRIEVAL NUMBER 76

## DATA PROCESSING

### Fast equalized modem compensates lines

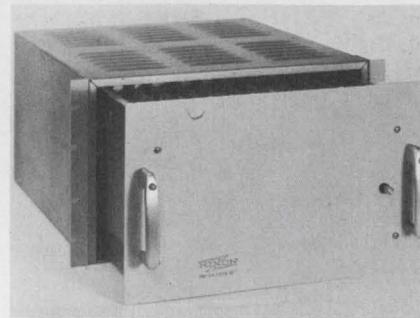

Rixon Electronics, Inc., 2120 Industrial Parkway, Silver Springs, Maryland. Phone: (301) 622-2121.

Designed for use in multi-point polled systems, a new data set operates reliably over completely unconditioned lines at rates as fast as 2400 bits per second. Model PM-24A contains a fixed equalizer that compensates for a full range of lines, thereby eliminating the need for manual equalization. It can also be used in straightforward point-to-point transmission systems.

CIRCLE NO. 261

### Rotating file stores paper tapes

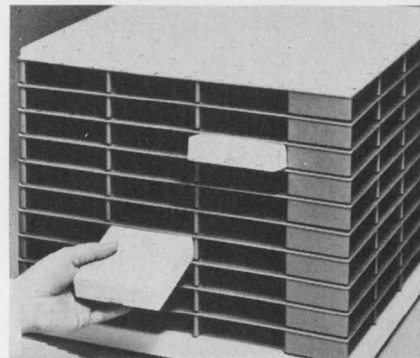

Information Design, Inc., 3247 Middlefield Road, Menlo Park, Calif. P&A: \$85, typical; stock.

Standard 5-, 7- or 8-track punched paper tapes may now be stored conveniently in boxes or reels in the rotating Carrousel File. Modular construction permits the user to expand his file capacity from 60 to as many as 576 units. The molded polystyrene file rotates smoothly on a ball bearing base and is available in grey, blue and beige, so that the file can be color coded.

CIRCLE NO. 262

## Keyboard data terminal has typewriter touch



DataNetics Corp., 2828 Spreckels Lane, Redondo Beach, Calif. Phone: (213) 542-4355.

Meeting the need for a low-cost remote data-entry station, for transmitting highly formatted information, a new keyboard terminal has the touch and reliability of an electric typewriter. Model 33 operates into a Bell System 402C data set, and transmits data at rates to 75 characters per second. The keyboard is fully buffered with an 8-bit ASCII code output.

CIRCLE NO. 263

## Digital intercoupler complements Teletype

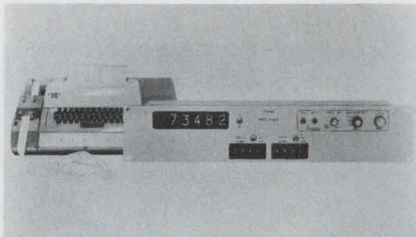

Anadex Instruments Inc., 7833 Haskell Ave., Van Nuys, Calif. Phone: (213) 873-6620. P&A: \$300; 8 wks.

Model G33 intercoupler option provides direct compatibility between any standard Anadex digital product and a Teletype ASR33 page printer and paper-tape perforator. The new intercoupler is integrally mounted within the enclosure of the digital product and permits the use of a standard teletypewriter without the Teletype multiple-wire distributor. This option is said to facilitate one of the least expensive methods of obtaining a printed record of measurements from a single data source.

CIRCLE NO. 264



# this is Simpson's 2700 digital system...

- 4½ digits
- 0.05% accuracy
- 5 plug-in function modules

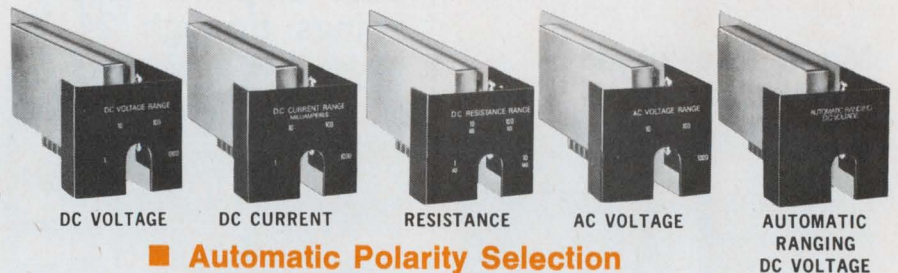

- Automatic Polarity Selection
- Built-in Self Calibration
- 100 Microvolt Resolution
- Optional BCD output
- IC Modular Design for reliability

Standard single and dual rack mount kits available.

**2700 DIGITAL SYSTEM \$615<sup>00</sup>**  
complete with DC voltage range module, test leads, and operator's manual

AVAILABLE "OFF-THE-SHELF" AT ELECTRONIC DISTRIBUTORS STOCKING SIMPSON INSTRUMENTATION PRODUCTS.

**Simpson** ELECTRIC COMPANY



5200 W. Kinzie Street, Chicago, Illinois 60644 • Phone (312) 379-1121  
Export Dept: 400 W. Madison Street, Chicago, Illinois 60606. Cable Simelco  
IN CANADA: Bach-Simpson Ltd., London, Ontario • IN INDIA: Ruttonsha-Simpson Private Ltd., International House, Bombay-Agra Road, Vikhroli, Bombay

INFORMATION RETRIEVAL NUMBER 77

## Hardened circuits bid for MIL market

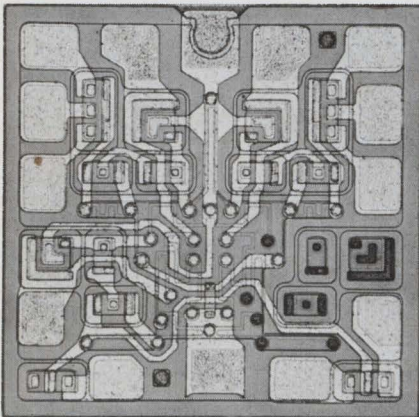

Philco-Ford Corp., Tioga and C Sts., Philadelphia, Pa. Phone: (215) 443-4325.

Five diode-transistor logic (DTL) circuits, a level shifter, and two 709 operational amplifiers comprise a new bid for the radiation-hardened IC market. The circuits are manufactured with a proprietary process that is suited to mass production of radiation-tolerant devices. These radiation-tolerant ICs feature dielectric (nonconductive) isolation of active elements.

CIRCLE NO. 265

## Monolithic diode suppresses arc

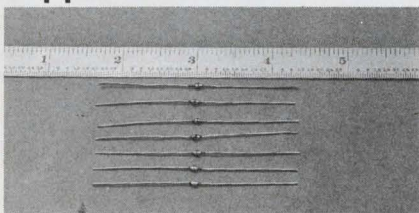

MicroSemiconductor Corp., 11250 Playa Court, Culver City, Calif. Phone: (213) 391-8271. P&A: from \$1.68, stock to 2 weeks.

Ideally suited for relay applications, a monolithic arc-suppressor diode is a non-polarized device that performs the function of two back-to-back zeners. Available for 28- and 110-volt relay suppression, the new double-sealed glass diode measures 0.065 by 0.10 in. with 0.02-in leads. Capable of internal use in the smallest relay cans, it operates over the  $-65^{\circ}$  to  $+175^{\circ}$ C temperature range and meets all applicable MIL-S-19500 reliability specifications.

CIRCLE NO. 266

## Low-cost plastic SCR handles 8 A at 400 V

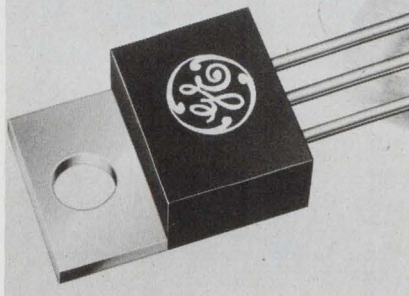

General Electric Semiconductor Products Dept., North Syracuse, N.Y. Phone: (315) 456-2396. P&A: 60¢ to \$1.04; 30 days.

Available with voltage ratings of 50, 200 or 400 V, the C122 plastic SCR offers an 8-A current capability. With a peak one-cycle surge rating of 80 A, the new unit has an expected critical rate of rise of off-state voltage of 40 V/ $\mu$ s at  $100^{\circ}$ C. Its gate triggering requirements at  $25^{\circ}$ C are 25 mA and 1.5 V respectively. The C122's package is compatible with the hermetic TO-66 case.

CIRCLE NO. 267

## Dual amplifier chip swings through 24 V

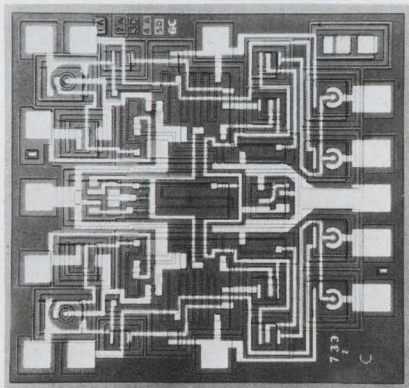

Fairchild Semiconductor, 313 Fairchild Dr., Mountain View, Calif. Phone: (415) 962-3563. P&A: \$4.85; stock.

A new dual operational amplifier achieves high packing density through the use of a 14-lead dual-in-line package, which contains two identical operational amplifiers on a single silicon chip. Each amplifier of the  $\mu$ A739 has a differential input and a single-ended output capable of large output swings (24 V pk-pk) without latch-up.

CIRCLE NO. 268

## Dynamic shift registers use complementary MOS

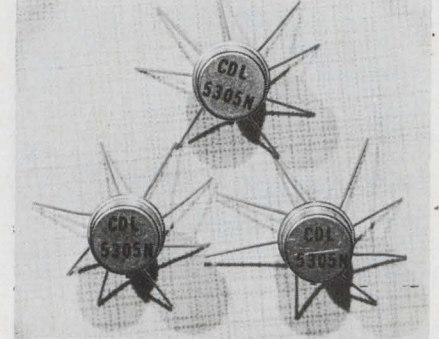

Solid State Scientific Corp., Montgomeryville Industrial Center, Montgomeryville, Pa. Phone: (215) 855-4400. Availability: 3 wks.

For high speed and low power requirements, series CDL 5300 dynamic shift registers combine complementary MOS transistors with two-phase dynamic logic into large-scale integrated MOS arrays. The new series features both single- and dual-bit availabilities with speeds up to 10 MHz in the 64-bit versions. Complementary static logic shift registers are also available.

CIRCLE NO. 269

## Low-cost thyristors go from $-55^{\circ}$ to $+125^{\circ}$ C

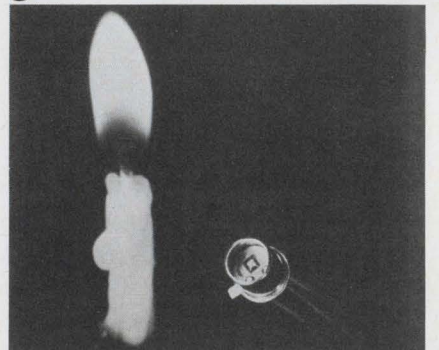

Transitron Electronic Corp., 168 Albion St., Wakefield, Mass. Phone: (617) 245-4500. P&A: \$1.90 to \$3.60; stock.

Representing an industry first, a new series of low-cost photo-SCRs (thyristors) operate over the full military temperature range of  $-55^{\circ}$ C to  $+125^{\circ}$ C. Series RTPC-0501 units feature a high light-sensitivity of 20 foot-candles, without the need for a focusing lens. Their flat lens permits wide angular response.

CIRCLE NO. 270

# STILL SEARCHING FOR THE RIGHT IC TESTER

## for the right job...at the right price?

End your search with Microdyne. We've been here all along. With the industry's most comprehensive line of IC testers . . . that meet any application you can dream of . . . at realistic prices within budget. See for yourself.

**Model 701** for incoming inspection by unskilled operators. Tests digital IC's up to 16 leads. Programmed with pre-wired patch plug.

**Price: \$675**

Circle RS#783

**Model 716** for incoming inspection and engineering evaluation of digital and linear IC's with up to 36 leads. Semi-automatic or manual programming. Pulse generator, 5 test power supplies, go/no-go comparators.

**Price: \$2790**

Model 715 with analog meter: \$2290.

Circle RS#784

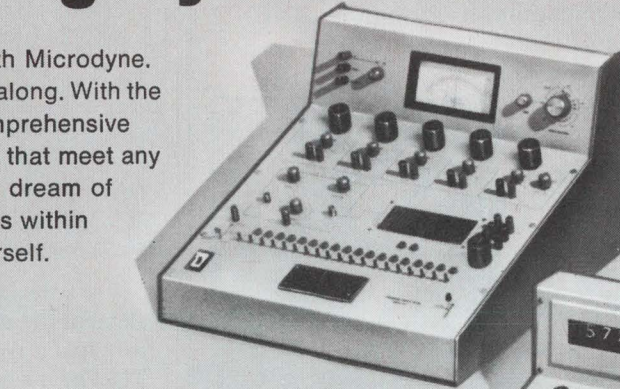

**Model 717** for engineering evaluation. Kelvin connections, 10MHz pulse generator, 5 test power supplies.

**Price: \$1790**

Model 718 with three digit volt/current readout: \$2290.

Circle RS#785

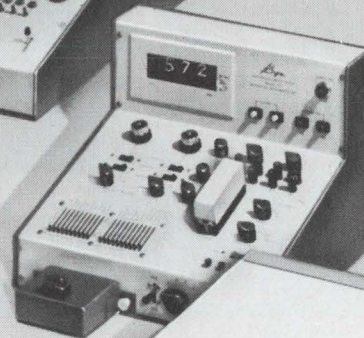
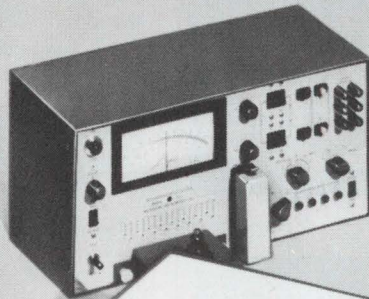

**Model 711** for incoming inspection of digital and linear IC's. Programmed manually or semi-automatically. Two test power supplies.

**Price: \$1495**

Model 710 with analog meter: \$995.

Circle RS#786

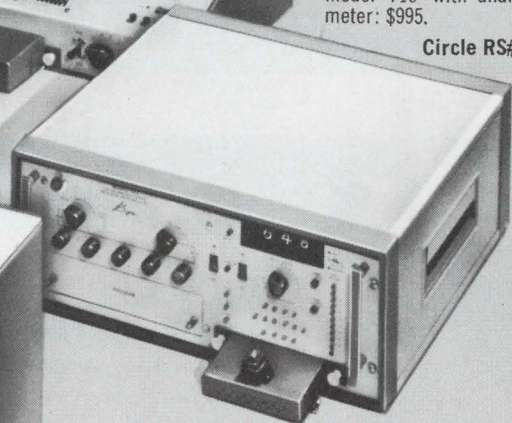
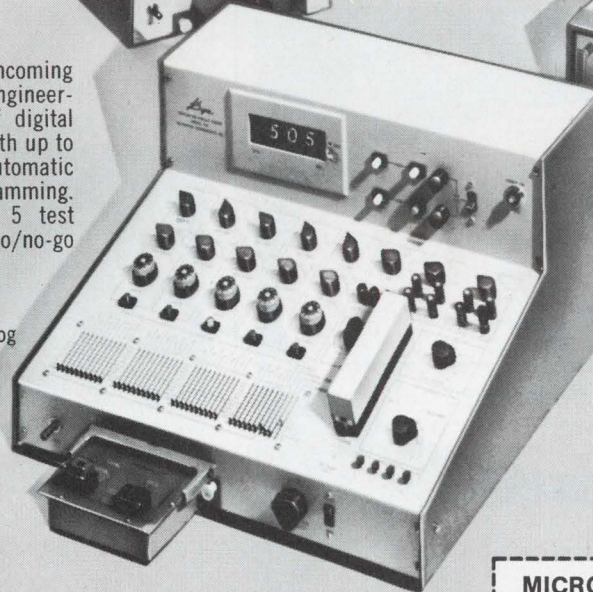

**Model 721** for high-speed production testing. Fully automatic, simultaneous D.C. and functional measurements of all digital IC's. Three digit volt/current readout for out of tolerance value. Program matrix card.

**Price: \$4650**

Model 720 without readout: \$3990.

Circle RS#787

See the complete Microdyne line of IC testers at Booth 2E45, IEEE Show, March 24-27, 1969, N. Y. Coliseum

**MICRODYNE** SUBSIDIARY OF COMPUTER TEST CORPORATION

# MICRODYNE

**MICRODYNE INSTRUMENTS, INC.**

203 Middlesex Turnpike • Burlington, Mass. 01803

Phone: 617/272-5691

### MICRODYNE INSTRUMENTS, INC.

Eureka! The *right* IC tester! Send me a bulletin.

- |                                    |                                    |                                    |
|------------------------------------|------------------------------------|------------------------------------|
| <input type="checkbox"/> Model 701 | <input type="checkbox"/> Model 717 | <input type="checkbox"/> Model 710 |
| <input type="checkbox"/> Model 716 | <input type="checkbox"/> Model 718 | <input type="checkbox"/> Model 721 |
| <input type="checkbox"/> Model 715 | <input type="checkbox"/> Model 711 | <input type="checkbox"/> Model 720 |

NAME \_\_\_\_\_ TITLE \_\_\_\_\_

COMPANY \_\_\_\_\_

ADDRESS \_\_\_\_\_

CITY \_\_\_\_\_ STATE/ZIP \_\_\_\_\_

Dept. ED-03



New and Better  
Communications with . . .

# TELEMATE 300

## ACOUSTICAL COUPLER

TELEMATE 300 was designed and developed to specifications of DACC, a time-sharing computer company that knows the needs of users.

That's why Telemate 300 is more compact, more reliable and elegantly styled.

### Top Quality • Competitively Priced

- Easily portable
- Data Rate: 300 Baud
- Carrier and on/off lights
- Highly selective tuned oscillator circuit
- Half/full Duplex
- Triple tuned circuitry
- AGC circuit
- Acoustic isolation min. 20 db
- Teletype or EIA Interface
- Optional: Carrying case, originate/answer, cable interface, loud speaker and RS 232B

FULL WARRANTY • WRITE FOR BROCHURE



Use TELEMATE 300 with your telephone and/or your teletype system. Comes in walnut and attractive office decorator colors.



**DACC**

DIRECT ACCESS COMPUTING CORP.

Communications Equipment Group

24175 Northwestern Highway  
Southfield, Michigan 48075

313/358-5000

INFORMATION RETRIEVAL NUMBER 78

## COMPONENTS

### Cermet trimmer is standard DIP

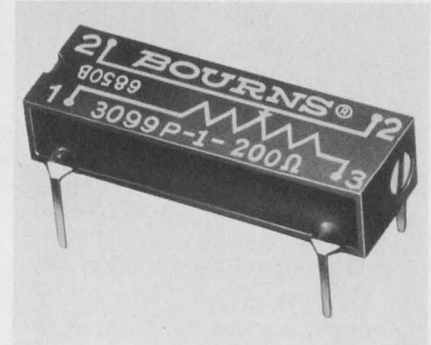

Bourns, Inc., Trimpot Products Div., 1200 Columbia Ave., Riverside, Calif. Phone: (714) 684-1700. Price: \$2.35.

For the first time, a cermet-element trimmer potentiometer is supplied in a standard dual-in-line TO-116 package. Compatible with standard DIP sockets and automatic insertion equipment, the 20-turn model 3099 measures 0.2 by 0.25 by 0.75 in. Standard resistance range is 10 Ω to 1 MΩ, operating temperature range is -55 to +125°C, and power rating is 0.75 W at 25°C.

CIRCLE NO. 271



## THICK FILM MATERIALS

### NEW Fine Line Gold

ESL #8831 CERAMIC GOLD CONDUCTIVE CERMET PASTE

- Fine Line Printing (.003" wide x .003" spacing)
- Smooth Glossy Surface
- High Density Film
- Low Resistivity (.002 to .004 ohms/square)
- Excellent Eutectic Bonding to Silicon Chips (no Au preforms, no special atmosphere, 390°C minimum temp.)
- Ultrasonic or Thermal Compression Bonding or Parallel Gap Welding of Fine Wire or Foil

- Conductive Pastes
  - Resistive Pastes
  - Dielectric Pastes
- Literature is available

ESL is a major producer of conductive, resistive and dielectric pastes for thick film and hybrid integrated circuit manufacturers throughout the world.

ESL pastes are formulated to both simplify and speed production with full assurance of the highest quality results. Try ESL products . . . you'll see the difference!

**ELECTRO-SCIENCE  
LABORATORIES, INC.**

1133 Arch Street, Philadelphia, Pa. 19107  
• Telephone 215/563-1360 215/563-2215



INFORMATION RETRIEVAL NUMBER 79

### Tiny indicator lamps block soldering heat

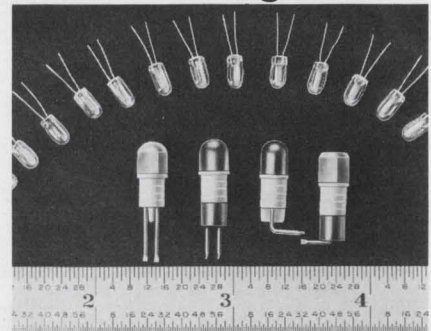

Shelly Associates, Inc., 111 Eucalyptus Dr., El Segundo, Calif. Phone: (213) 322-2374.

Miniature indicator lights are now available with epoxy heat barriers that prevent transmission of soldering iron heat into the body of the indicator housing. This high-intensity indicator light series includes lamps that increase average life expectancy from 60,000 to 100,000 hours. Lamp ratings range from 1.5 to 28 V with current ratings as low as 0.01 A.

CIRCLE NO. 272



## Seven-segment readout dissipates 0.5 watts

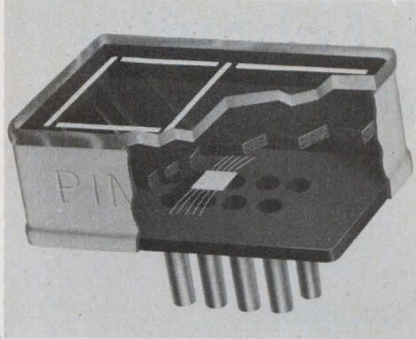

Pinlites, Inc., 1275 Bloomfield Ave., Fairfield, N.J. Phone: (201) 226-7724.

Said to be the world's smallest decoder/display system, a new readout package consumes a maximum power of only 0.5 W. Able to translate 8-4-2-1 BCD codes to seven-segment displays, model M6-IC features a package depth of 3/16 in. Segment brightness is 250 ft-L, and filament design life is 100,000 hours. The seven-segment characters are 5/16-in. high.

CIRCLE NO. 273

## DIP reed relay is IC compatible



Grigsby Barton, Inc., 107 N. Hickory, Arlington Heights, Ill. Phone: (312) 392-5900.

A compact 14-pin dual-in-line reed relay is completely compatible with IC logic components and PC-board pin spacing. The GB811 is designed for operation with integrated circuitry. Input is 5 V dc for direct transistor logic drive, with the package containing both a reed relay and a diode to suppress back emf. The relay has a contact rating of 3 W and a breakdown voltage of 200 V dc.

CIRCLE NO. 274

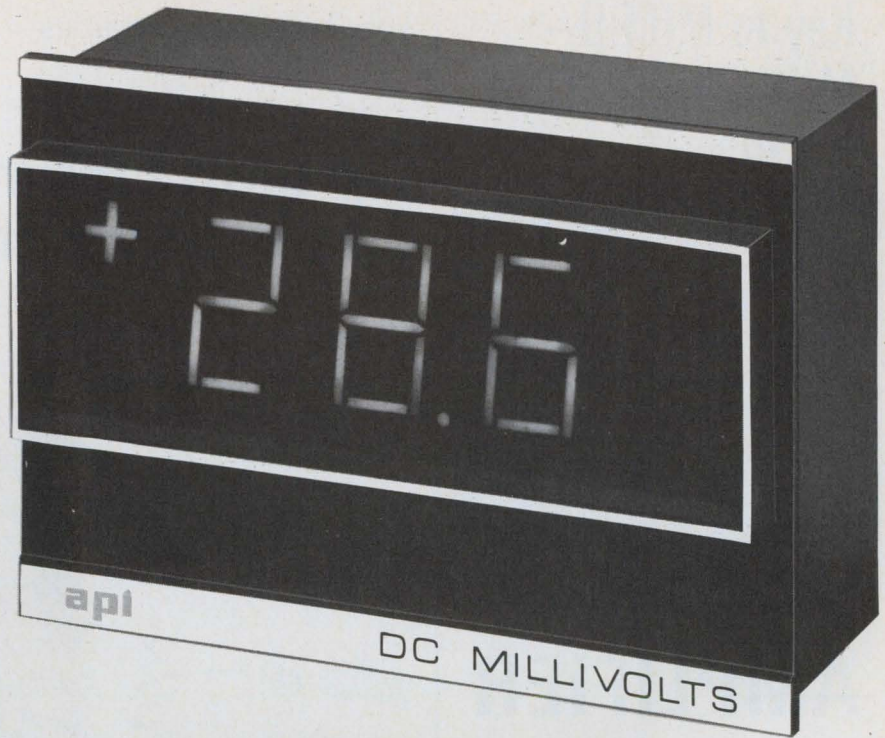

# Best readability among small DPM's

API's new digital panel meters are the only ones of their size with seven-bar segmented digits, 7/8" high, all on one plane, readable from 40 feet at angles of  $\pm 70$  degrees. They need only 1 1/2" behind the panel when the detachable power supply is mounted remotely.

- 3 and 3 1/2 digit models.
- Accuracy  $\pm .1\%$  of reading,  $\pm 1$  digit.
- BCD output.
- Auto-polarity.
- 1000 megohms input impedance.
- Front or rear panel mounting.

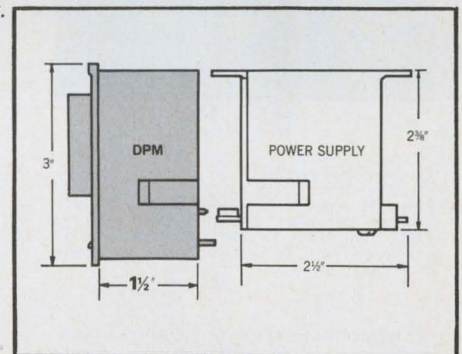

Priced to compete with high accuracy analog meters in OEM quantities.

Ask for Bulletin DP-1 ■ IEEE Booth No. 2G-34

## api INSTRUMENTS CO.

Chesterland, Ohio 44026 | (216) 729-1611

INFORMATION RETRIEVAL NUMBER 80

# Key to MICRO-MINIATURIZATION is SRC



## HI-GAIN IF AMPLIFIER

Used extensively in C and X Band transponders, SRC IF amplifiers have qualified to Mil-E-8189, Mil-I-25500, Mil-E-25144, Mil-E-5272 and Mil-Q-9858. Special packaging requirements involving the integrating of LO, mixer, IF and detector are routinely handled at SRC. Let our engineers solve your space problems.

### TYPICAL SPECIFICATIONS:

F<sub>0</sub>: 60 to 80 MHz  
 BW: 5 to 20 MHz at 3 db points.  
 Gain: 70 db.  
 Noise Figure: 4 to 6 db.  
 Impedance: 50 ohm input, 50 ohm output load or 1K ohm detected video output load.  
 Output: 0 dbm.  
 Power Requirements: 12 VDC @ 35 ma.  
 Temperature Range: -40°C to +85°C.  
 Size: 1 x 1/2 x 3/10 inches, plus base plate.  
 Weight: 15 grams.  
 \* Units can be supplied for extended operating temperature range.

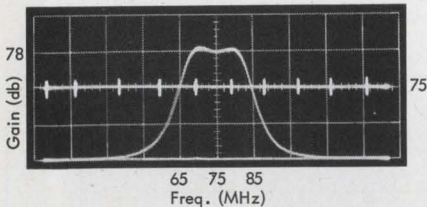

### MODIFICATIONS:

The SRC microminiature IF's can be modified to customer specifications, such as AGC, bandwidth, center frequency, or manufactured with or without video detectors incorporated.

**SCIENTIFIC RESEARCH CORPORATION**  
 4722 Kennedy Road, Tampa, Fla. 33614  
 Phone: 813/884-2989

(A Subsidiary of Trak Microwave Corp.)



INFORMATION RETRIEVAL NUMBER 81

## Op amp FET input circuitry ups bandwidth and speed

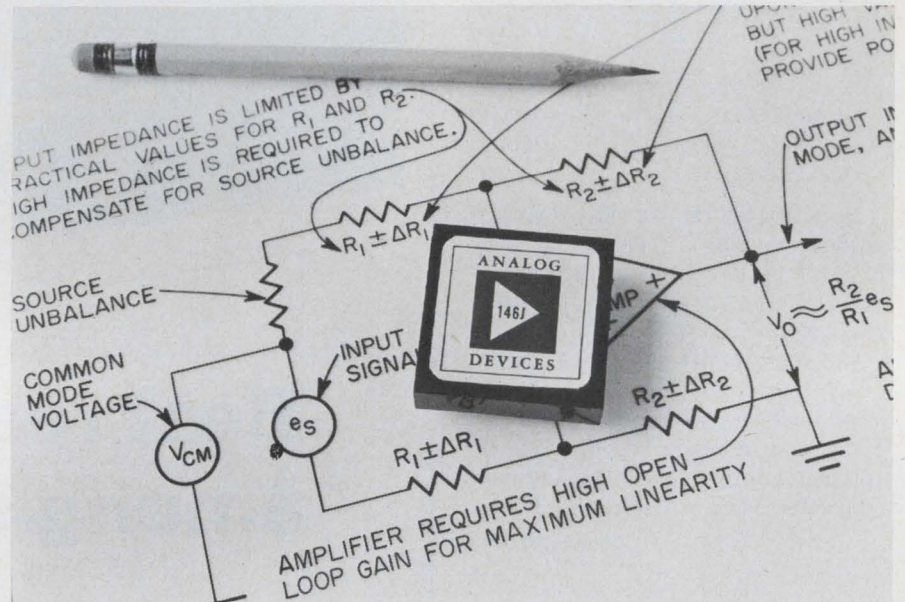

Analog Devices, Inc., 221 Fifth Ave., Cambridge, Mass. Phone: (617) 492-6000. P&A: \$57 to \$70; stock.

The use of FET input circuits in the model 146 operational amplifier is the key to wide bandwidth and faster response. Often the advantages of FET input circuitry tend to be counterbalanced by the FET's poor voltage stability and low common mode performance. But in this amplifier the disadvantages have been overcome.

New design concepts embodied in the model 146 provide superior specs at a price significantly lower than many competitive units. Two versions of this op amp are offered with different levels of voltage and current stability. Model 146K offers 2  $\mu\text{V}/^\circ\text{C}$  maximum voltage drift and 20 pA initial bias current. A lower priced version provides 7  $\mu\text{V}/^\circ\text{C}$  maximum voltage drift and 30 pA maximum initial bias current.

Output rating of both amplifiers is 10 V at 20 mA, open-loop gain is 100,000 and unity-gain bandwidth is 5 MHz. Other specifications include 150 kHz full-power

response ( $\pm 10$  V, 20 mA), and  $10^{11}$  ohms differential and common-mode impedance.

These FET op amps are particularly well suited for use in current-to-voltage converter circuits that measure fractional nanoamp currents developed by photomultiplier tubes, ion gauges, photocells, and other low-level transducers. Such signal sources invariably have high internal impedance and therefore require high impedance amplifier circuits.

Model 146 is an accurate buffer amplifier or voltage follower for extracting low level signals from high impedance sources. For example, the common mode error for a 1-V measurement is 1 V/10,000 or 100  $\mu\text{V}$ . Voltage drift error for a  $\pm 10^\circ\text{C}$  temperature change adds only a 20  $\mu\text{V}$  error (which is 20 ppm or 0.002%). Current drift error for the  $\pm 10^\circ\text{C}$  change would depend on the actual value of source resistance, but assuming a relatively high  $10^7$  ohm source, current drift error would amount to 20 pA  $\times 10^7 \Omega$ , or 200  $\mu\text{V}$ . This is an error of less than 0.02%.

CIRCLE NO. 275

# SNOB KNOB



Black

Decorative  
metallic  
ring

Spun  
aluminum  
cap

Spun  
aluminum  
inlay

The first new styling innovation in fifteen years! 900 Series Snob Knobs come in four bright, handsome models. Spun aluminum cap. Spun aluminum inlay. Decorative metallic ring. And Black. From 1/2" to 1 3/4" diameter. Kurz-Kasch is known as the quality knob source by electronics manufacturers the world over. If you're not familiar with the outstanding Kurz-Kasch line, we'll send you a complete catalog. And if you're just anxious to see the new Snob Knob, we'll send you a free sample.



**Kurz-Kasch, Inc.**

Standard Parts Division • 1415 S. Broadway  
Dayton, Ohio 45401 • Phone 223-8161

INFORMATION RETRIEVAL NUMBER 82

# BERYLLIUM COPPER COMPONENTS

**STAMPINGS & CHEM-BLANKS\***

**YOUR SINGLE SOURCE  
SUPPLIER FOR:**

**FINGER STOCK - CUSTOM DESIGNS**

- PROTOTYPES
- MULTI-SPRINGS
- BENDING
- HEAT TREATING
- PHOTO-ETCHING
- FORMING
- PLATING

**BTL BRAUN**  
**TOOL & INSTRUMENT CO., INC.**

140 Fifth Avenue, Hawthorne, New Jersey 07507  
Telephone: 201-427-1773 • TWX 710-988-4136

\*CHEM-BLANKS is a service mark of H. Braun Tool & Instrument Co., Inc.

INFORMATION RETRIEVAL NUMBER 83

ELECTRONIC DESIGN 7, April 1, 1969

# PULL PUSH

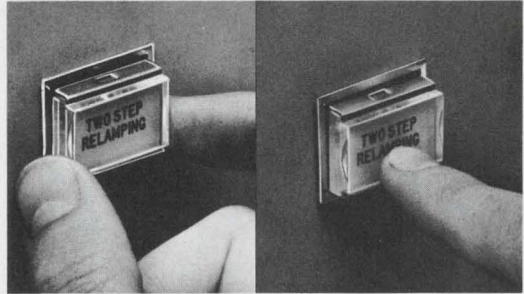

# REMOVE

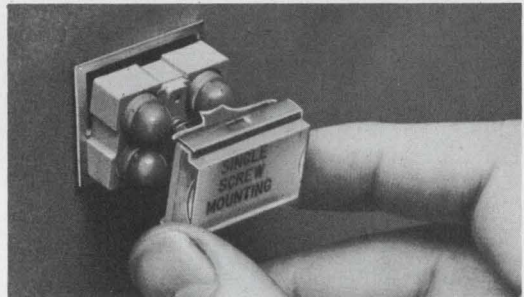

The easiest relamp since lighted push button controls were invented.

Easiest installation too—front mounting with a single captive screw, no costly wiring because we buss our lamps internally at the factory.

Unimax Series 9 LPB's are four-lamp pushbutton panel controls designed to meet the requirements of MIL-S-22885/9-12. You have a wide choice of display screen styles, color coding and customized messages which can be modified or replaced in the field. Features include multi-pole switching and holding coil capabilities, and each of the four lamps can be illuminated independently. Switch guards, spacer barriers, RF shielding and drip-proof seals are available.

Unimax LPB's have a lot going for you. Contact our representative or write for Catalog 50-2. See a lively demonstration of our LPB capabilities—ask our rep to bring his demonstrator.

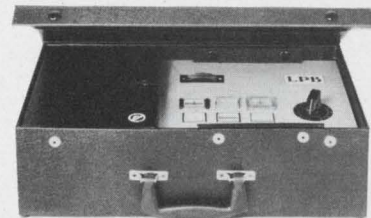

Illuminated Push-Button Controls by

**Unimax Switch** 

Division of Maxson Electronics Corp.  
IVES ROAD, WALLINGFORD, CONN. 06492

INFORMATION RETRIEVAL NUMBER 84

# Help stamp out right angle microwave connectors.

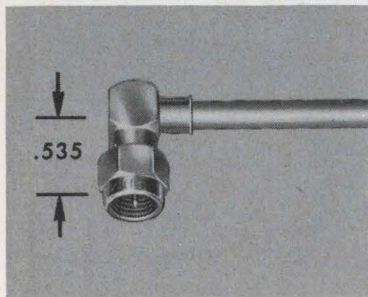

How you're probably doing it now.

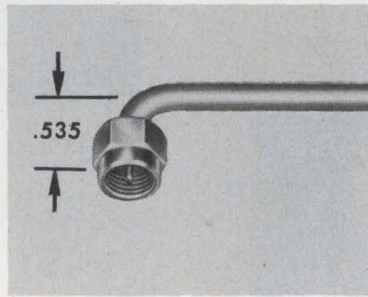

How you ought to be doing it.

You can, if you're using semi-rigid cable.

Right angle microwave connectors are used for no other reason than the minimization of the distance between the mating face of the connector and the center line of the cable and are always used for packaging purposes and never for performance. Here's how we achieve a new high in performance in this kind of situation and still meet your packaging needs:

We bend our semi-rigid miniature coaxial cable 90° immediately at the entrance of our new PDM straight plug (meets MIL C-39012 Type SMA) and ship these assem-

blies ready for immediate use. You can order, from stock, any length from 2 inches to 18 inches in 2 inch increments. Special lengths take three to four weeks.

The advantages are many and compelling. No interruption of cable geometry. No impedance discontinuities. Performance very close to straight plug. Cost about 60% less than right angles. No assembly time. Same center line to reference plane distance. No assembly failures.

For complete details, write for Technical Bulletin No. 13 to: *Phelps Dodge Electronic Products Corporation, 60 Dodge Avenue, North Haven, Connecticut 06473.*

**PHELPS DODGE** ELECTRONIC PRODUCTS CORPORATION 

INFORMATION RETRIEVAL NUMBER 85

## MODULES & SUBASSEMBLIES

### Balanced mixers cost only \$12

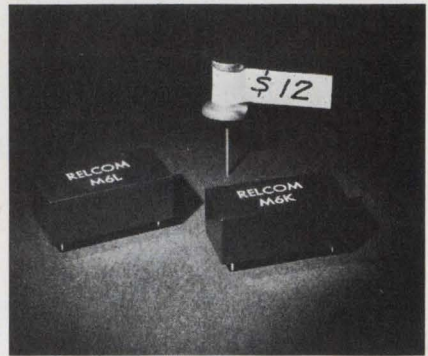

*Relcom, 2329 Charleston Rd., Mountain View, Calif. Phone: (415) 961-6265. P&A: \$12; stock.*

Designed for economy, model M6K and model M6L are low-cost double-balanced mixers selling for \$12 each. Model M6L covers the frequency range 0.2 to 30 MHz while model M6K covers 5 to 400 MHz. Isolation is 35 dB for model M6L and 25 dB for model M6K. Each is designed to operate over the temperature range of -54 to 100°C.

CIRCLE NO. 276

### Voltage transducers convert frequency

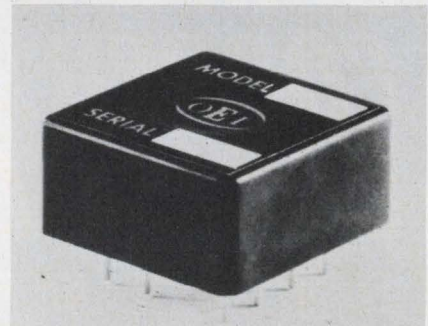

*Optical Electronics Inc., P.O. Box 11140, Tucson, Ariz. Phone: (602) 624-8358. P&A: \$45 to \$75; stock.*

Low-cost voltage-to-frequency and frequency-to-voltage transducers are available in two new modules. Model 5329 provides a universal approach to highly accurate voltage-controlled oscillator applications, and model 5337 provides the user with a versatile, highly linear frequency-to-voltage converter. Linearity is  $\pm 0.3$  to  $\pm 0.6\%$  and operating range is dc to 100 kHz.

CIRCLE NO. 277

## Decoder/drivers blank and dim

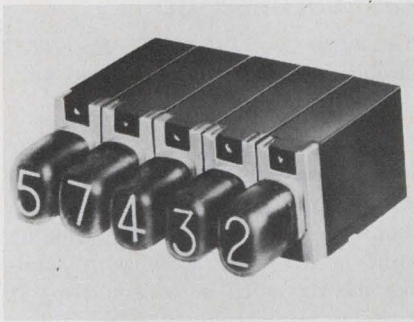

Burroughs Corp., P.O. Box 1226,  
Plainfield, N.J. Phone: (201) 757-  
5000.

Two new miniature IC decoder/  
drivers for wide-temperature opera-  
tions incorporate both blanking and  
dimming capabilities. Models BIP-9802  
and BIP-9806 are de-  
signed for use with Burroughs'  
type B-4998 miniature rectangular  
Nixie tube. Both operate from -55  
to +125°C while model BIP-9806  
also features memory capability.

CIRCLE NO. 278

## IC logic cards decouple dynamically

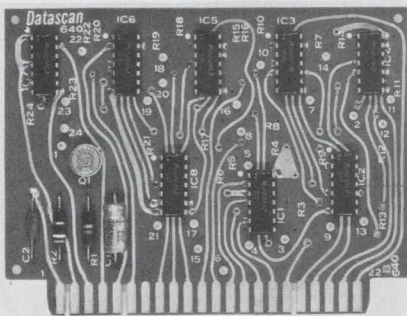

Datascan, Inc., 1111 Paulison Ave.,  
Clifton, N.J. Phone: (201) 478-  
2800.

Reducing costs of backplane  
wiring and testing time, series 600  
IC logic cards use dynamic de-  
coupling circuits to eliminate high-  
and low-frequency noise for ex-  
tremely reliable system operation.  
The new TTL series also provides  
for mounting pull-up resistors on  
the card, and features a maximum  
number of test points with no  
added capacitance, 44-pin edge  
connections, and unique three-slot  
interpin keying to prevent acci-  
dental interchanging or reversing  
of cards.

CIRCLE NO. 279

# a double gun 15 MHz Scope for \$774\*

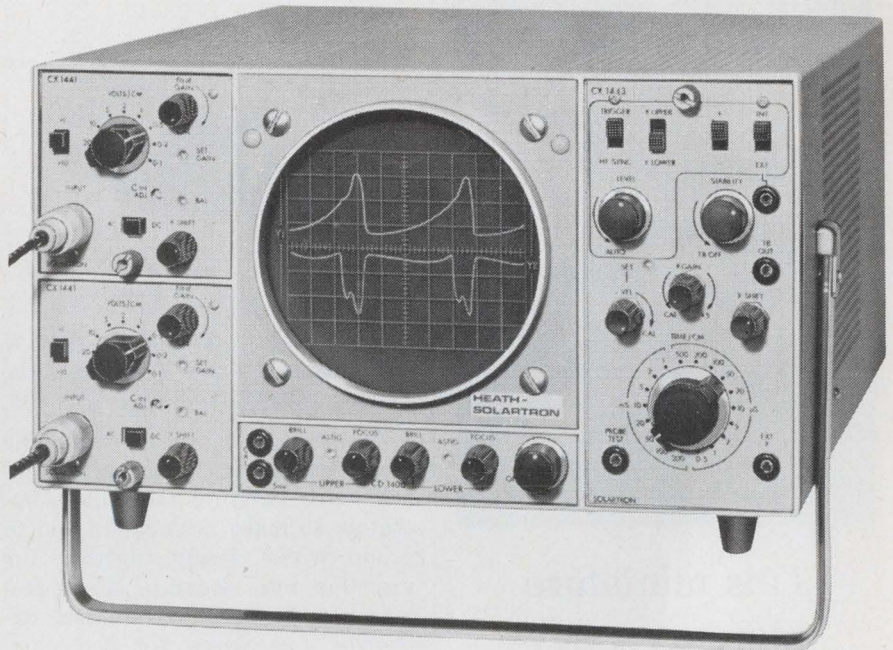

## Heath/Solartron CD-1400 Series

Main Frame \$450\*

Plug-Ins \$91\* up

The Heath/Solartron CD-1400 is more than  
a portable, general-purpose, true dual-beam  
oscilloscope: it is a fully modular system  
of vertical amplifiers and time bases to  
fill your measuring requirements with un-  
matched flexibility. The 5" CRT, coated  
with P31 phosphor, operates at 4 kV to  
give you high resolution and bright dis-  
plays. Viewing area of the graticule is 8 by  
10 cm. Separate gun assemblies, position-  
ed vertically to minimize geometric distortion,  
have separate focus and brilliance controls.  
Available in factory assembled and tested  
form only.

The CD-1400 shown above with two CX-  
1441 Wide-Band Amplifiers and a CX-1443  
General Time Base and X Amplifier fea-  
tures:

- DC to 15 MHz bandwidth
- 24 ns rise time
- 9 sensitivity ranges from 100 mV/cm to  
50 V/cm (10mV/cm, DC to 750 kHz  
with switched x10 gain)
- 18 calibrated sweep ranges from 0.5 us/  
cm to 200 ms/cm in a 5, 2, 1 sequence  
(a continuous uncalibrated coverage up  
to 500 ms/cm gives a 5 s sweep)

- ±5% accuracy
- x1 to x5 expansion
- Int, Ext, +, -, Normal, Auto, HF Sync  
Trigger Modes . . . all for just \$774

A sensitivity of 100 uV/cm is available up  
to 20 kHz, increasing to 1 mV/cm up to  
75 kHz by plugging in the CX-1442 High  
Gain Differential Amplifier.

High frequency low level signals in the  
presence of large in-phase signals can be  
displayed with the CX-1449 Wide Band  
Differential Amplifier featuring 10 mV/cm  
sensitivity on the DC-10 MHz bandwidth.

Variable sweep delay to 100 ms is provided  
on the CX-1444 Sweep Delay Time Base.

DC external trigger, DC coupled X input  
and Single Shot are available on the CX-  
1448 Wide Range Time Base which has 20  
ranges from 0.5 us/cm to 1 s/cm extendable  
to a 25 s sweep.

The modular design of the CD-1400 system  
protects it against obsolescence and gives  
greater measurement capability customized  
to your needs at an unassuming price: the  
main frame costs only \$450, plug-ins start  
at \$91.



HEATH COMPANY, Dept. 520-26  
Benton Harbor, Michigan 49022

For more infor-  
mation send for  
the NEW  
HEATH  
Scientific  
Instrumentation  
Catalog

Please Send Free New Scientific Instrumentation Catalog

Name \_\_\_\_\_

Company \_\_\_\_\_

City \_\_\_\_\_ State \_\_\_\_\_ Zip \_\_\_\_\_

Prices & specifications subject to change without notice.  
\*Mail order prices; F.O.B. factory.

TE-196

INFORMATION RETRIEVAL NUMBER 86

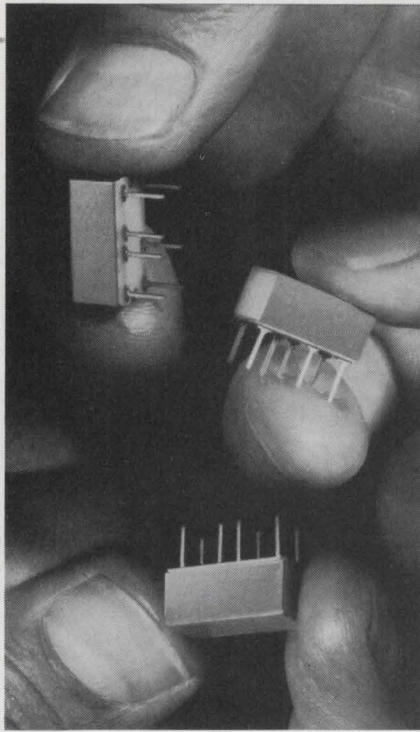

## This miniature mercury relay operates in ANY POSITION

It's the new Logcell® Mercury Film Relay and it combines all the advantages of conventional mercury wetted relays with miniature size (0.06 cu. in.), operation in *any* mounting position, and shock and vibration resistance. Use Logcell Relays in computer logic circuits, precision instrumentation, high speed control systems or wherever you need a relay that offers:

- Long life — tested to billions of cycles
- No contact bounce
- Form "C" SPDT contacts
- Operation in any mounting position
- Fast operating time — 2.5 ms
- No measurable AC contact noise
- Thermal noise less than 0.2 microvolt
- Switches dry circuits to 2 amps
- Inherent memory — requires no latching current (mono-stable models also available)

For complete information on Logcell Relays — and Switches — write Fifth Dimension Inc., Box 483, Princeton, N. J. 08540 or call (609) 924-5990.



**FIFTH DIMENSION INC.**

INFORMATION RETRIEVAL NUMBER 87

## PRODUCTION EQUIPMENT

### Handheld tool twists fine wire

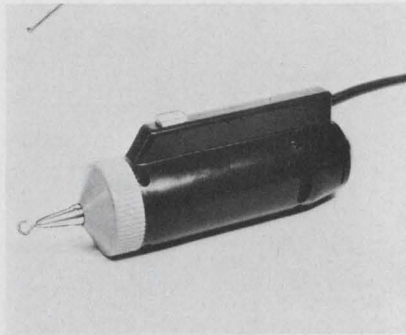

*Jensen Tools and Alloys, 3630 E Indian School Road, Phoenix, Ariz. Phone: (602) 955-0180. Price: \$25.*

Designed for use on electronic production lines, a compact handheld wire twisting tool allows operators to make neat cables and to group wires closely together for insertion into sleeving. Model D-0 may also be used to reinforce extremely fine wires for soldering. This is accomplished by looping the wire as many times as needed on the hook, and then spinning it into a heavier gauge.

CIRCLE NO. 280

### Automatic extractor removes DIP ICs

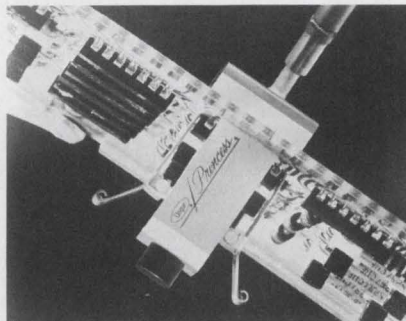

*Ungar, Div. of Eldon Industries, 223 East Manville St., Compton, Calif. Phone: (213) 385-4011.*

Designed to facilitate removal of dual-in-line integrated circuits, a new automatic extractor, model 6982, features a spring-loaded positive lock that frees and protects the operator's hands during desoldering. The extractor releases the package at the precise moment of solder melt to prevent heat damage to components, circuits and boards.

CIRCLE NO. 281

### Pocket scriber has carbide tip

*Marindus Co., Inc., P.O. Box 663, Englewood, N.J. Phone: (201) 567-8383.*

A new carbide-tip pocket scriber with an adjustable and retractable point is designed for use in close quarters. The hard-metal carbide point is fitted in a ballpoint pen-like casing with a pocket clip. It may be re-sharpened many times and can be adjusted to vary or maintain point projection. Refills are readily available and easily inserted.

CIRCLE NO. 282

### Soldering tool kit enables evaluation

*Weller Electric Corp., 100 Wellco Rd., Easton, Pa. Phone: (215) 258-5371.*

A 30-day, no cost, test and trial kit permits in-plant evaluation of model W-TCP low-voltage soldering station. Included in the EK-1 kit are six interchangeable tips of various sizes and temperature ranges, as well as a comprehensive guide to permit customizing the unit for various applications. The tool features automatically controlled output that matches the tool to the work.

CIRCLE NO. 283

### Portable desoldering kit uses compressed air

*Air-Vac Engineering Co., 100 Gulf St., Milford, Conn.*

A completely portable desoldering kit, type KSG-2-E60, features a soldering iron with an integral transducer that converts compressed air into a vacuum for removing molten solder. Also included in the new kit are air pressure controls, a compressed air cylinder, spare parts and a selection of replaceable tips. The cylinder contains 90 cubic inches of compressed air at 1800 psi for handling about 500 desoldering operations.

CIRCLE NO. 284

# Precisely aligned photo sensors on .050" centers are now possible

## with HYBRID THICK FILM PHOTO ARRAYS

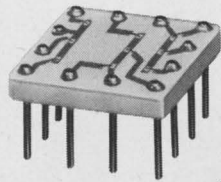

12 pin plug-in array

16 point photo array mounted to P.C. board

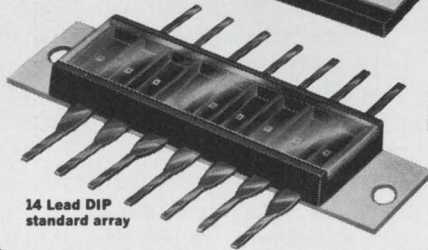
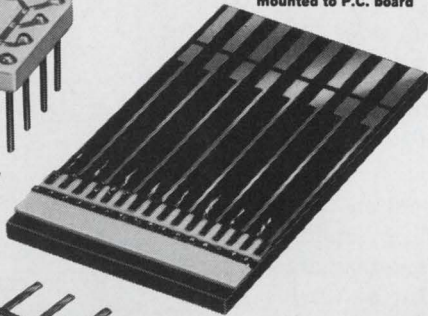

14 Lead DIP standard array

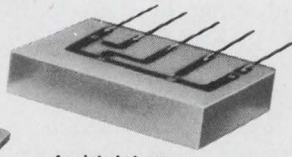

4 point photo array with wire leads

An entirely new concept now makes possible *precise* (within  $\pm .002''$  in both x and y axis) high density (as close as .050" on centers) mounting of photo sensors. HEI's advanced thick film technology opens up application areas which were not feasible with discrete sensors.

HEI thick film photo arrays eliminate the need for expensive, individually packaged, photo semi-conductors and avoid the problem of misaligned sensors. Many chips can be combined into an array that gives significant cost savings over discrete devices.

Interface circuitry can be made part of the thick film module to provide the entire light sensing function in one extremely small package.

HEI Photo Arrays can be used in computer card or tape readers, mark sensing equipment, character recognition sensors, level and positioning guides... almost any application where precision light sensing is required!

Write or call for complete details today!



Jonathan Industrial Center  
Chaska, Minnesota 55318 Phone: (612) 445-3510

INFORMATION RETRIEVAL NUMBER 88

## TRUE SOLID-STATE RELAY



Opening New Relay Applications in Multiplexing, Isolated Sensing, High Speed Isolated Control, etc. Offered in A - B - C Contact Configurations for Direct Replacement of Mechanical Types.

- Switching Time . . . . . less than  $65\mu$  sec
- Contact Open Resistance . . .  $10^9$  ohms
- Contacts Capable of switching DC to 4 M HZ
- Non-Polarized Effective Coil
- Effective Coil Accuate/Release Voltage Hysteresis . . . less than 10 mV . . .
- Non-Polarized Contacts
- No Reference Required Between Effective Coil and Effective Contacts
- Life Expectancy—tested to  $10^{10}$  operations with no failure.

### SHAFFSTALL-BALL CORPORATION

5149 E. 65th Street, Indianapolis, Indiana 46220  
Phone: 317-257-6296

INFORMATION RETRIEVAL NUMBER 89

ELECTRONIC DESIGN 7, April 1, 1969

# POWER/MATE CORP. UNI-88

## UNIVERSAL POWER SUPPLY

- 0 to 34 volts at 1.5 AMPS.
- .005% Regulation
- 250 Microvolts ripple
- Meets MIL-E-5272 specs
- 100,000 hours MTBF
- 5 year warranty

**\$99.00**

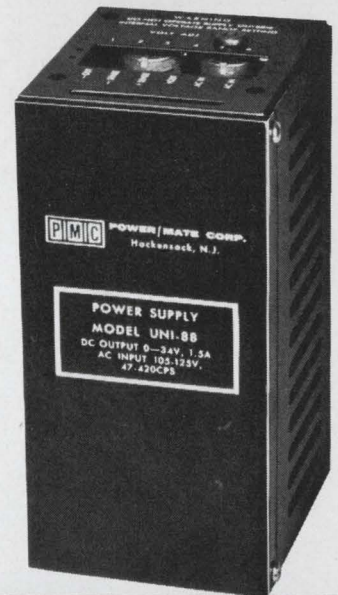

**SAME DAY SHIPMENT**



### POWER/MATE CORPORATION

163 Clay St. ■ Hackensack, N. J. 07601  
(201) 343-6294 ■ TWX (710) 990-5023

INFORMATION RETRIEVAL NUMBER 90

133

# NEW HIGHLY SELECTIVE CONSTANT DELAY FILTERS

CONSTANT DELAY OVER 100%  
of PASS BAND COUPLED with  
HIGH SELECTIVITY  
and LOW RIPPLE

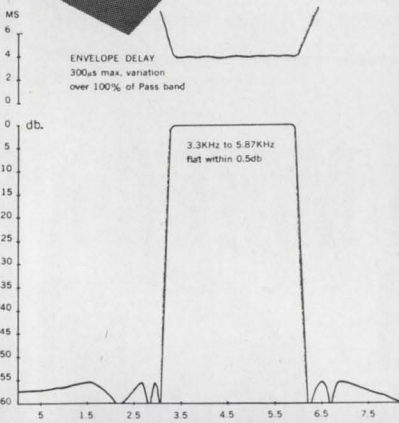
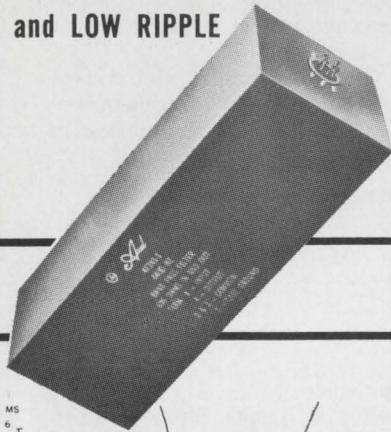

### Check These Specifications

- 300  $\mu$ sec max. delay distortion from 3300Hz to 5920Hz
- $\pm 0.25$ db max. amplitude variation from 3300Hz to 5870Hz
- 55db or greater below 3070Hz and above 6160Hz
- Size: 3x9x2 $\frac{3}{4}$  high
- Manufactured to meet Govt. Specifications: MIL-F-18327C

*Axel*

**AXEL ELECTRONICS, INC.**

A UNIT OF GENERAL SIGNAL CORPORATION

134-20 Jamaica Avenue

Jamaica, N.Y. 11418

Manufacturers of:

Capacitors • Precision Wave Filters • R.F.I. Filters • Pulse Networks • Pulse Transformers • Pulse Modulators.

## INSTRUMENTATION

### Digital picoammeter resolves down to 1 pA

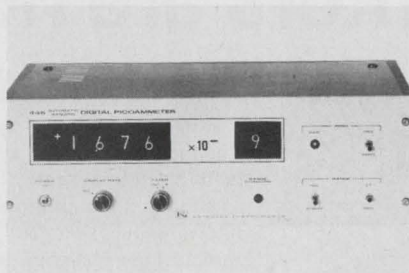

Keithley Instruments, Inc., 28775 Aurora Road, Cleveland, Ohio  
Phone: (216) 248-0400. Price: \$1495.

Able to measure automatically the leakage currents of semiconductors and capacitors, a new digital picoammeter features a full-scale current range of 1 nA to 10 mA with 1 pA resolution. Model 445 has a 3-digit display with 100% overranging, automatic polarity and overload indication, a variable display rate, fast and stable autoranging, and both analog and digital printer outputs.

CIRCLE NO. 285

### Memory voltmeter reads digitally



Micro Instrument Co., 12901 Crenshaw Blvd., Hawthorne, Calif.  
Phone: (213) 679-8237.

A 4-digit memory voltmeter features digital readout of pulses from dc to 50 ns and amplitudes to  $\pm 1000$  V in four ranges, providing 100% overrange and BCD output. Available in a half-rack dual shielded cabinet, model 5203 will measure and hold the peak amplitude of one-shot or transient pulses, as well as repetitive pulses. The instrument can measure any phenomenon that can be defined in terms of peak voltage.

CIRCLE NO. 286

### Modular system generates pulses

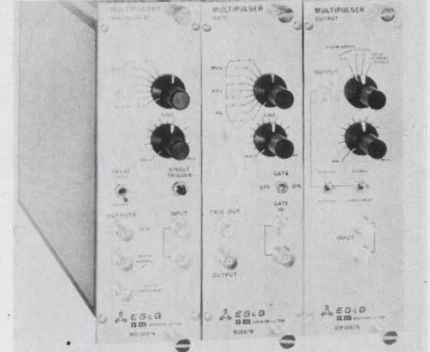

Nuclear Instrumentation Div., EG&G, 35 Congress St., Salem, Mass. Phone: (617) 745-3200.

A modular pulse generator is capable of generating bursts of pulses with each pulse having independent amplitude, width and spacing at repetition rates of 50 MHz down to 1 pulse every 10 seconds. The Multipulser is a directly coupled NIM-standard system employing true current-source outputs for module interconnections via 50- $\Omega$  cable. Signal levels are fast-logic NIM standards.

CIRCLE NO. 287

### Digital panel meters use IC techniques



Datascan, Inc., 1111 Paulison Ave., Clifton, N.J. Phone: (201) 478-2800. Price: \$175 (100 lots).

Ten versions of three-digit panel meters use integrated circuit techniques to improve performance and reliability while reducing costs. Some of the features include 100% overrange, non-blinking display, programmable decimal points, BCD outputs, 0.01/ $^{\circ}$ C stability, an accuracy of 0.1% reading  $\pm 1$  digit, and an operating temperature range of 0 to +60 $^{\circ}$ C. The range of these meters is 100 mV to 100 V and 1  $\mu$ A to 100 mA.

CIRCLE NO. 288



## Counter-timer uses plug-in ICs

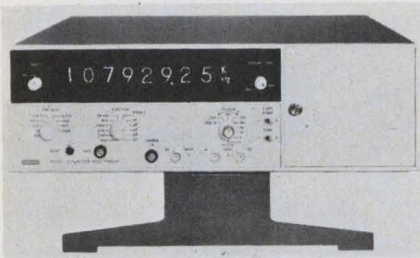

Beckman Instruments, Inc., 2200 Wright Ave., Richmond, Calif. Phone: (415) 526-7730.

A 100-MHz counter and timer, model 6155, features field-replaceable plug-in integrated circuits instead of standard printed circuit boards. The 6155 is the first counter/timer to be marketed using this principle. A complete set of functional spare parts can be purchased for less than \$50 per instrument, and simplified repair procedures result in lower labor costs.

CIRCLE NO. 289

## Computerized system processes video signals

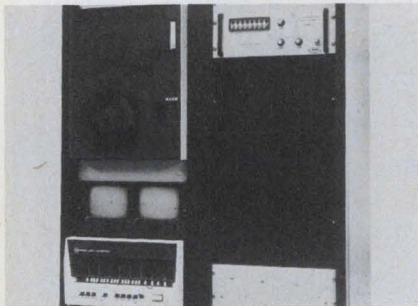

Spatial Data Systems, Inc., 108 Aero Camino, Goleta, Calif. Phone: (805) 968-3594. P&A: \$50,000 to \$150,000; 4 to 6 months.

Called a video processor, a new high-speed computerized system averages, compares and analyzes television pictures and wideband transients. Its advantages are said to be two-fold: enhancement of signals and semi-automatic sensing of small differences or changes in pictures or signals in real time. The system's key components include a magnetic tape recorder, a digital computer, digital to analog converter, high-speed arithmetic and control, dual video monitors, a magnetic disc and a power supply.

CIRCLE NO. 290

# Solve all Resistor problems fast...

## TALK TO THE SPECIALIST... LECTROHM

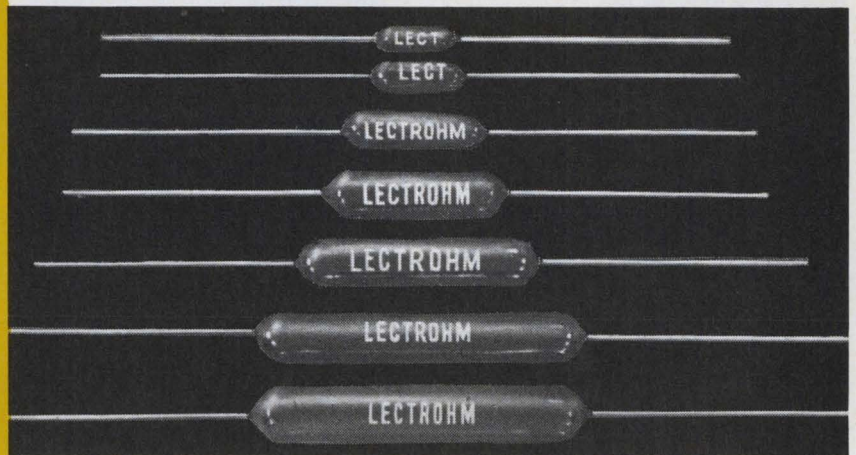

With LECTROHM's entire production facilities devoted to the manufacture of quality power, wire-wound resistors, we are in the unique position to provide quick, economical solutions to all resistor problems. As specialists in the field, LECTROHM knows resistors.

Whether your products require "standard" or "custom" styles — fixed or adjustable types, vitreous enamel or silicone coated — there is a LECTROHM resistor to match those needs precisely. To meet your production schedules, large stocks of standard styles in popular values are always available for immediate shipment, with special facilities geared to fast delivery on small orders of special values.

Whatever your resistor problems entail, you will do better talking to the specialist — talk to LECTROHM. You'll be time and money ahead, everytime.



Vitreous Enameled  
Fixed Resistors



Vitreous Enameled  
Adjustable Resistors



Type FP Resistors



**FREE!**

Full line  
LECTROHM  
catalog.

Send for your  
copy today!

## Lectrohm, Inc.

A subsidiary of



COOK ELECTRIC

5562 Northwest Highway, Chicago, Ill. 60630

# What's the top value in low cost matrix switching?

Try the Telefunken OHS individually selectable, 9 pole, 12 position ordinate holding switch. Distributed exclusively in the U. S. A. by Cunningham. Ideal for educational systems, intercom systems, many other audio and control applications. Brings you: **1. Compact size.** Only 3 1/2" x 2 1/2" x 3 1/2". **2. Magnetic latching.** Gives fail-safe protection against power failure. **3. Low cost.** Because of compact design and modern manufacturing methods. **4. Modular construction.** Plug-in units easily replaceable—simplifies maintenance, reduces downtime.



**OHS**  
(Telefunken)

## Ordinate Holding Switch

Switching systems problems? Let our know-how in systems engineering work for you with: **OHS (Ordinate holding) switches;** **crossbar switches** for general purpose/high-performance requirements; **McKee random access matrices** for high voltage and current; **reed matrix switches** for high frequencies.

Detailed specifications available in our new Data Sheet No. 604. Write or call Cunningham, Carriage St., Honeye Falls, N. Y. 14472. Phone: (716) 624-2000.

**Cunningham**  
Subsidiary of Gleason Works

Proven capability in engineered switch products and systems.

INFORMATION RETRIEVAL NUMBER 93

## PACKAGING & MATERIALS

### Dual-in-line packages null thermal expansion

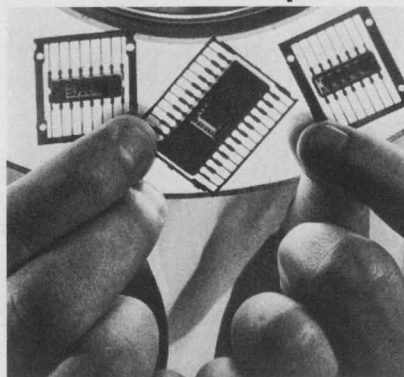

Sylvania Electric Products, Inc., Parts Div., 12 Second Ave., Warren, Pa. Phone: (814) 723-2000.

Three new dual-in-line integrated circuit packages for the semiconductor industry include a 14-lead multi-chip, a 16-lead dual-in-line, and a 24-lead dual-in-line unit. These IC packages use an iron-nickel-cobalt alloy which matches the thermal expansion of the glass-ceramic insulator. The insulator is a special blend of hard glass and alumina.

CIRCLE NO. 291

### Fiber-optic system transfers images

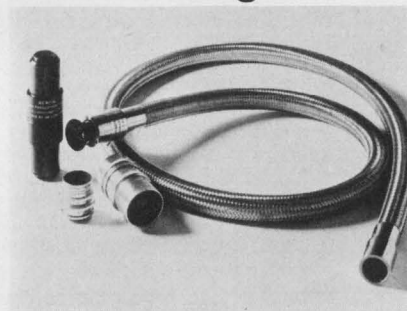

Mosaic Fabrications Div., The Bendix Corp., Galileo Park, Sturbridge, Mass. Phone: (617) 347-9191.

Model IS-810 Imagescope is a snake-like image transfer device that can monitor remote areas and inspect otherwise inaccessible or hazardous ones. Fitted with a suitable lens system at either end, the Imagescope utilizes thousands of small 10-micron clad optical-glass fibers, perfectly aligned to transmit a high-resolution image from the viewed area to the viewing station.

CIRCLE NO. 292

### Plastic extrusions are adhesive backed

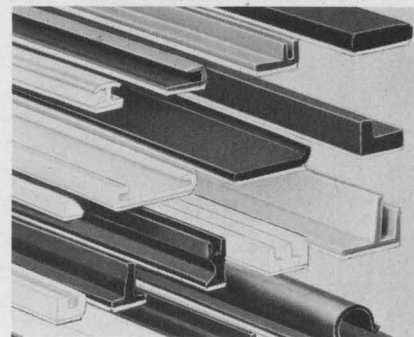

Richco Plastic Co., 5825 No. Tripp Ave., Chicago. Phone: (312) 231-0200.

To facilitate application, custom and standard plastic extrusions can be supplied with double-faced adhesive backing. This eliminates the need for fasteners and reduces installation time substantially. Typical applications would be tracks for permanent or sliding panels, retaining strips of various types, and trim strips for cabinets.

CIRCLE NO. 293

### Terminals and splices have two-stage crimp

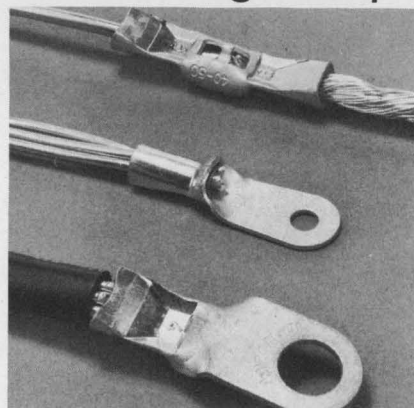

AMP Inc., Harrisburg, Pa. Phone: (717) 564-0101.

A new line of terminals and splices features a two-stage, contoured-crimp, designed specifically for use with stranded and solid aluminum wire. The one-piece terminal body houses a perforated sleeve of tin-plated brass. Crimping forces extrude the relatively soft aluminum wire into the sleeve perforations, scraping off oxides and exposing freshly bared metal to the inner surfaces of the perforations.

CIRCLE NO. 294

# THE SUN NEVER SETS

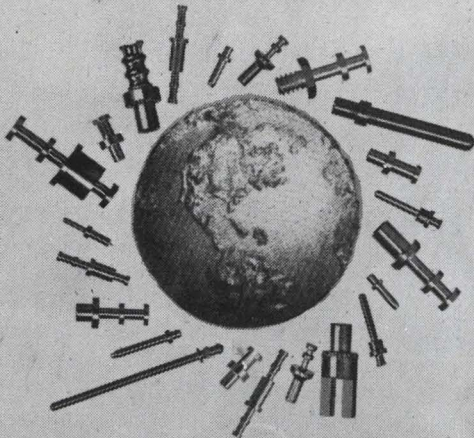

... On CONCORD'S Terminal and Pin customers. We MAKE and PLATE precision MICRO, MINI, STANDARD and CUSTOM parts. Same day shipments on standard parts.

- For printed circuits
- For modules
- For connectors

Send drawings for prompt quotation

## CONCORD ELECTRONICS CORPORATION

37 GREAT JONES ST. • NEW YORK, N.Y. 10012 • 212-777-6571

TWX 710-581-4930

INFORMATION RETRIEVAL NUMBER 94

*to buy smart...*  
**in WHITEPRINTERS**  
*buy only the speed you need!*



Economy Model 146. 47" throat.  
Speeds to 9 feet per minute.

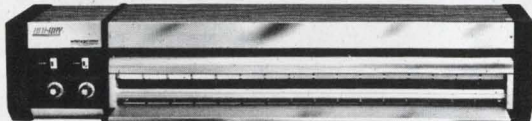

Workhorse Model 842. 42" throat.  
Speeds to 12 feet per minute.

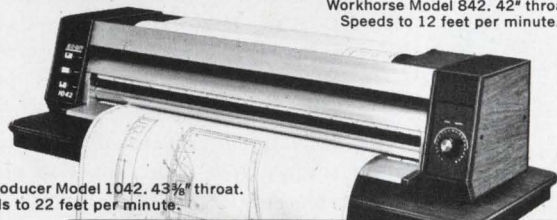

Big Producer Model 1042. 43 1/2" throat.  
Speeds to 22 feet per minute.

# BLU-RAY

*Only Blu-Ray gives you a choice, and full year warranty.*

INCORPORATED  
 TO BUY SMART, SEND FOR FREE LITERATURE TODAY.  
 4334 Westbrook Road, Essex, Conn. 06426 • (203) 767-0141

INFORMATION RETRIEVAL NUMBER 95

ELECTRONIC DESIGN 7, April 1, 1969

# Going to IC's? Or Higher IF's?

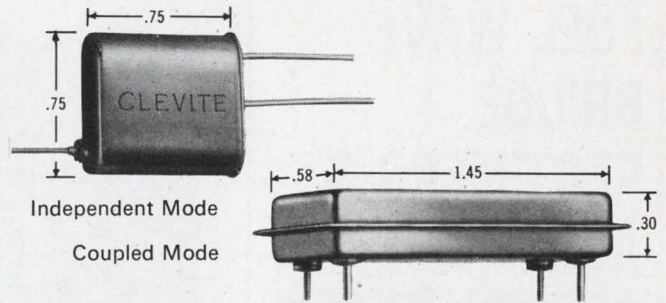

## Go two ways with Monolithic Quartz Uni-Wafer® Filters

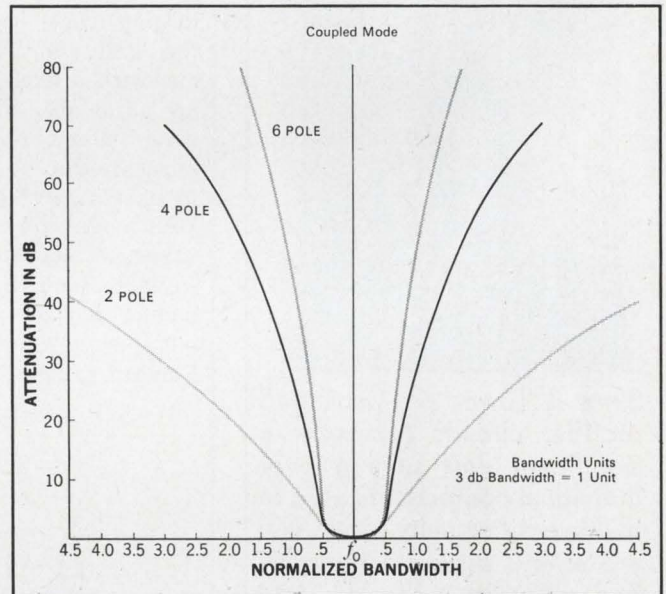

Go independent mode. Go coupled mode. You can go either mode with monolithic Clevite Uni-Wafer® filters. They're smaller and more reliable (fewer interconnections) than conventional filters.

Clevite Uni-Wafer filters are ideal for matching IC circuitry in communications receivers operating in the VHF and UHF frequency ranges as well as in telemetry, radar and aerospace systems.

They are 2, 4 and 6 pole crystal filters with a choice of center frequencies ranging from 8 MHz to 75 MHz. They've been developed using Clevite's advanced engineering techniques and Clevite's original thin film approach to quartz filters. In this concept, arrays of resonators are achieved on a single quartz wafer with resonator isolation and spurious suppression controlled by the trapped energy principle.

So if you're going to IC's or higher IF's, go Clevite Uni-Wafer filters. They're available in both independent and coupled mode.

For more information and complete specification data, write: Clevite Corporation, Piezoelectric Division, 232 Forbes Road, Bedford, Ohio 44146.

# CLEVITE

INFORMATION RETRIEVAL NUMBER 96

# LOWEST COST . . . FULL WAVE BRIDGE RECTIFIERS & ASSEMBLIES

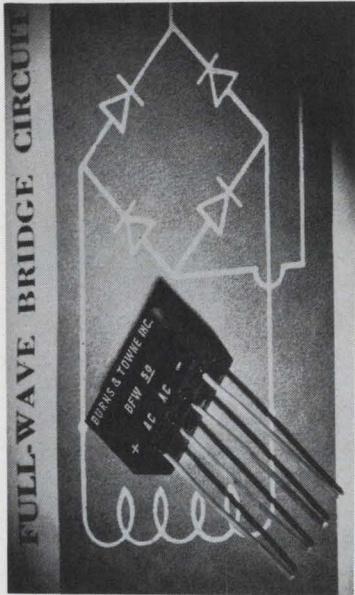

Burns & Towne pre-packaged rectifier circuits represent a significant cost savings over individual components used in multi-rectifier units. Yet, you are always assured of quality and reliability. The low cost BFW family of single phase full wave bridges . . . features high current capability of up to 2.0 amps.

Part No.	Max. PRV (volts)
BFW-50	50
BFW-100	100
BFW-200	200
BFW-300	300
BFW-400	400
BFW-500	500
BFW-600	600
BFW-800	800
BFW-1000	1000

Call or write for full specifications and price data.

**BURNS & TOWNE INC.**  
18-36 Granite St.  
Haverhill, Mass. 01830, Tel (617) 373-1333

INFORMATION RETRIEVAL NUMBER 101

# Evaluation Samples

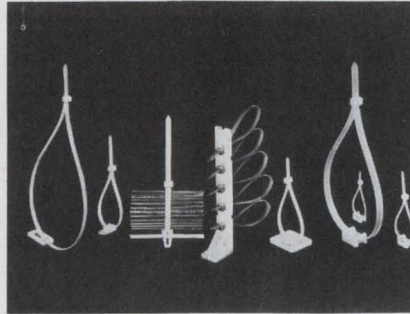

## Wiring mounts

Adding versatility to Panduit's Sta-Strap harness tying systems are several mounting devices that are designed for use with self-locking cable ties. Included are: the TA1 and TA2 offset mounts, one with a fixed slot and one with an adjustable slot; the PM2H25 push mount for securing wire harnesses up to 4-in. in diameter to panels as thick as 1/8 in.; the PP2 mount for supporting wiring harnesses above or away from any surface; and the AM2 adhesive mount for use on virtually any metallic or non-metallic surface. Panduit Corp.

CIRCLE NO. 345

NOW YOU CAN GET  
YOUR BEADS..  
MAN WITH LEADS!



## Ferrite beads

Ceramag ferrite beads can be installed in printed circuit boards with automatic insertion equipment. Complementary samples are offered attached to a humorous folder that is styled like a greeting card. Stackpole Components Div.

CIRCLE NO. 346

## Shrinkable tubing

Type TE-250 heat shrinkable tubing is extruded of modified polytetrafluoroethylene. It is supplied in expanded sizes that can easily be assembled over connectors, components, or other irregular shapes. When heated to 621°F (327°C), it will shrink to form a tight-fitting covering over the component, providing both mechanical and electrical protection. The exceptional electrical properties and chemical inertness of polytetrafluoroethylene make shrinkdown TE-250 tubing a reliable insulation choice in applications involving extreme electrical, thermal, and chemical environments. L. Frank Markel & Sons, Inc.

CIRCLE NO. 347

## Emi/rfi shielding kit

A sample kit of emi/rfi shielding material used on electronic enclosures is now offered free to assist qualified engineers in making the proper selection. Each reusable polyethylene bag contains a wide variety of knitted wire mesh gaskets, conductive silver/silicone, conductive tapes and see-through shielding glass. Technical Wire Products.

CIRCLE NO. 348

## Profile extrusions

A functional sample of a plastic profile extrusion consists of two different materials, rigid and flexible vinyl, combined into a single extrusion. Typical of a product line that includes extruded rigid and flexible vinyl polypropylene, the sample extrusion forms the backbone binding element of an eight-page brochure. The brochure describes recent advances in plastic profile extrusion technology that make possible the design and mass production of uniformly high-quality extrusions, ranging from tiniest spline to a broad 12-in.-diameter profile. Crane Plastics, Inc.

CIRCLE NO. 349

# Room for improvement

General Electric's TO-5<sup>2</sup> transistor-size sealed relays give you more room for increased power, improved performance

We didn't cut any corners on this high-reliability, transistor-size sealed relay. We left them on so there'd be more room for a more powerful magnet—2½ times more powerful.

This added power means this type 3SBS, 2PDT, 1 amp relay gives you higher contact forces, larger contact gaps, and greater overtravel to minimize mechanical shifts. Shifts which usually increase early-in-life failures.

Though there's more room inside to give you all these advantages, the outside dimensions—top-to-bottom (.275") and side-to-side (.370")—are the same as any transistor-size relay.

So don't cut corners on your next transistor-size relay application. Specify GE's square Type 3SBS. For full details, write General Electric, Section 792-45, Schenectady, New York 12305.



ACTUAL SIZE

**GENERAL**  **ELECTRIC**

INFORMATION RETRIEVAL NUMBER 102

# CREATE YOUR OWN MODEL NUMBER

... tailor an AMF Cybertran Video Pre-amplifier to fill your needs

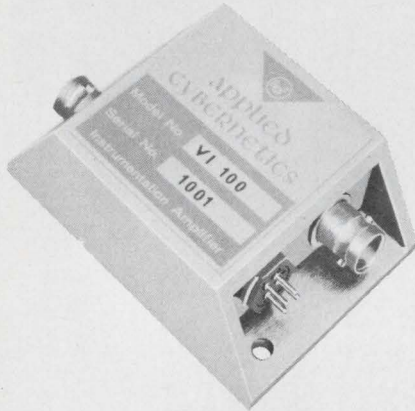

## Broad Frequency Response

- High Input Impedance
- Low Input Impedance
- $f_1$  .1 Hz/ $f_2$  25 MHz

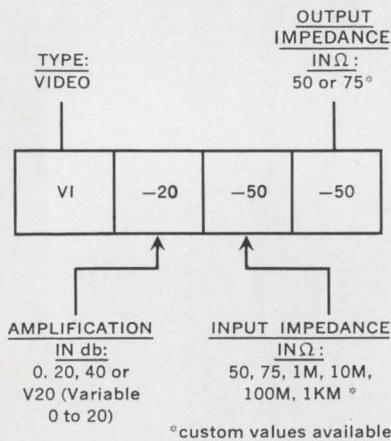

Never before has such flexibility been built into a line of video preamplifiers. AMF Alexandria's VI Series of Cybertrans makes it possible for you to specify your video preamplifier requirements and have AMF ship it to you. Write or call Bob Peterson, Applied Cybernetics Products, 1025 North Royal Street, Alexandria, Virginia, 22314 Phone (703) 548-7221. TWX 703-931-4209. Representatives in major cities of U.S.A.

**AMF**  
ALEXANDRIA

INFORMATION RETRIEVAL NUMBER 103

## Design Aids

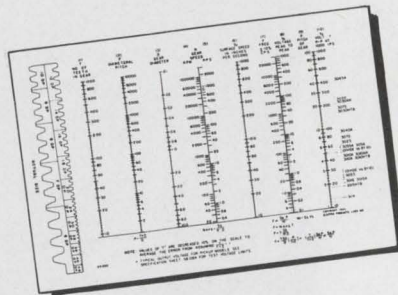

### Magnetic pickup data

A valuable addition to any engineer's reference file, a magnetic pickup nomogram provides a fast method of calculating the operating characteristics of various magnetic pickups when used with a wide range of gear sizes and speeds. A handbook included with the nomogram is an in-depth reference that contains charts, diagrams and a wealth of information on magnetic pickups. Electro Products Laboratories, Inc.

CIRCLE NO. 350



### Profit leak detector

A pocket-sized production cost computer will give instantaneously the annual cost of hand component insertion in any quantity from 100,000 inserted components to 100 million, and compare this with the cost of inserting the same number of components automatically. The cost comparison includes not only the total savings available but also the savings after machine pay-off. The calculator recommends a specific machine system to do the required work, as well as suggested alternative units which may be considered for variables due to production line requirements. USM Corp., Dyna/Pert Dept.

CIRCLE NO. 351

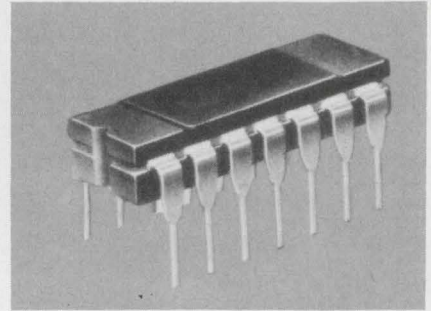

### DTL substitution guide

DTL interchangeability guide cross-references hermetically sealed DTL part numbers of six major manufacturers. The listings are divided into three main sections by package types: 14-lead ceramic dual in-line, low-profile TO-5 style, and 14-lead 1/4-by-1/4 ceramic flatpacks. ITT Semiconductors.

CIRCLE NO. 352

### PC comparison chart

The relative advantages of etched and die-stamped circuitry are compared on a specifications chart. It can help determine the best approach for any application. GTI Corp., Dytronics Div.

CIRCLE NO. 353

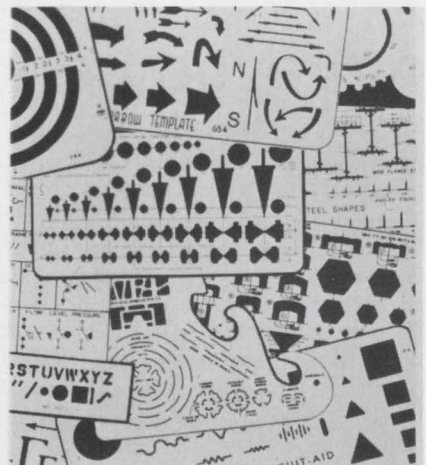

### Designer's templates

A wide variety of templates for engineers and draftsmen is illustrated in a comprehensive brochure. Every item is illustrated and prices and an order form are included. Plasticoid Products, Inc.

CIRCLE NO. 354

Use This Giant "Economy-Size" Coupon at Once.

# SAVE TIME and MONEY on WIRE WRAPPING

Connector Panels. Yours or Ours.

Please tell me how I can close the time-and-cost gap by letting you wire wrap our connector panels, or having you furnish your panels completely wrapped and ready for installation.

Name \_\_\_\_\_

Company \_\_\_\_\_

Address \_\_\_\_\_

\_\_\_\_\_

\_\_\_\_\_

Mail to Elco Corporation, Fort Washington, Pa. 19034

Now, under one roof, Elco wire wraps connector panels via fully-automatic, semi-automatic, or hand-wrapping methods. We will wrap your panels, or Elco metal plates—ready for installation. We can assure you of saving both time and money plus giving you the added benefit of greater reliability. So for your current or contemplated prototypes or production runs—contact your Elco Sales Office. Or call, wire, TWX or write ELCO Corporation, Fort Washington, Pa. 19034; 215-646-7420; TWX 510-661-0363.



GARDNER-DENVER FULLY-AUTOMATIC MACHINE WRAPPING.



SEMI-AUTOMATIC MACHINE WRAPPING.



PRECISION HAND WRAPPING.



INFORMATION RETRIEVAL NUMBER 104

# Application Notes

## Microwave components

Intended for electronic engineers and designers, a new 16-page brochure describes the performance and applications of microwave gridded vacuum tubes and microwave circuit modules. Applications discussed include phased-array radars, airborne communications equipment, airborne navigational aids, microwave communication links, radar beacons and fuses, microwave test equipment, and marine radars. The brochure also contains performance ratings, characteristics, and capabilities of these microwave products in easily understood graphs, charts and product drawings. General Electric Tube Dept.

CIRCLE NO. 295

## Die casting

Describing the die-casting process and related monitoring and measuring instrumentation, a 12-page booklet is entitled "Monitoring the Die Casting Process." It contains 10 sections covering such topics as instrumenting the processes, measured variables, devices and systems used, interpretation of records, economic advantages of instrumentation and future developments. Written for the nonspecialist, the booklet contains a glossary of terms to explain technical references. Honeywell Test Instruments.

CIRCLE NO. 296

## Trimmer capacitors

Information vital to users of air dielectric trimmer capacitors is printed in a guide for design engineers in the latest issue of *Trimmer Topics*, a two-page newsletter. The newsletter is available without charge to qualified engineers, scientists and technicians concerned with the application and specification of trimmer capacitors. Voltronics Corp.

CIRCLE NO. 297

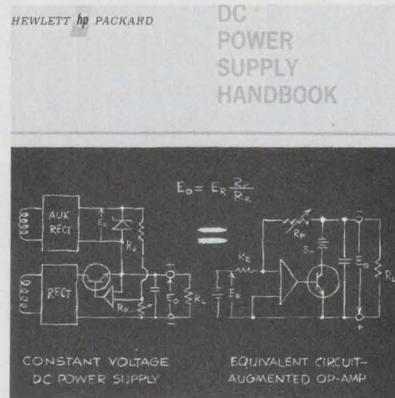

## Power supply handbook

An 82-page power supply handbook contains a listing of a complete line of supplies. Along with other helpful information, it has a selection guide and a condensed listing to help the prospective user find the supply that best meets his needs. Engineering inquiry forms are included for situations that require applications assistance. The handbook portion discusses power supply circuit principles, operating features, performance measurements, and special applications of regulated dc power supplies. Hewlett-Packard Co., Jersey Div.

CIRCLE NO. 298

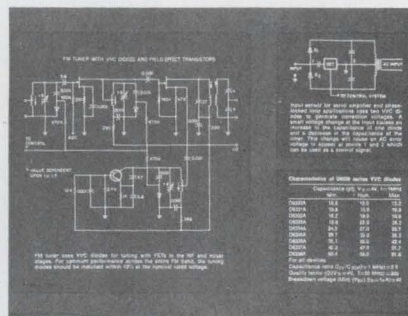

## VVC-diode applications

Useful application information on voltage-variable capacitance diodes is given in an 8-page booklet. Physical descriptions and electrical characteristics of a broad line of devices are included. Featured is an fm tuner design that uses VVC diodes and FETs for tuning its rf and mixer stages. Sylvania Electronic Components.

CIRCLE NO. 299

## Light measurement

An eight-page technical brochure on spectral energy measurements from 200 to 1200 nanometers, discusses measurement units, modes and applications. Measurement of spectral energy is approached from a standpoint of illuminance and irradiance. The text deals with visible light, integration of flashed energy, integration of light energy over long periods of time, and measurement of narrow bands of light energy. International Light Inc.

CIRCLE NO. 321

## Acoustic data

Varacoustics, a new sound-control process that assures high quality voice and music amplification in any room, regardless of size or acoustics, is explained in a new 4-page brochure. Illustrated with photographs and electroacoustical before-and-after charts, the copy details the steps taken to tailor a sound system to the geometry and surface properties of an architectural enclosure. The brochure describes acoustical handicaps and how they are overcome by installation of filter circuits in the communications control center. Communications Systems Div., DuKane Corp.

CIRCLE NO. 322

## Microwave vector detector

Containing both theoretical and practical information, a new 9-page application note talks about the microwave vector detector, a device that has two rf inputs and four dc or video outputs. The voltages at the video outputs carry amplitude and relative phase information of the two microwave input signals. Suggested applications include use with differential amplifiers and use as a frequency discriminator. Aertech Industries.

CIRCLE NO. 323



# measure

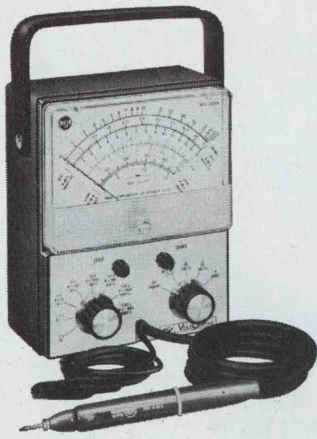

**NEW RCA WV-500B** all solid state, battery operated VoltOhmyst eliminates warm-up time, zero shift that can occur in tube voltmeters. Completely portable. Only \$79.00.\* Now has eight overlapping DC current ranges from  $2\mu\text{A}$  to 1.5A.

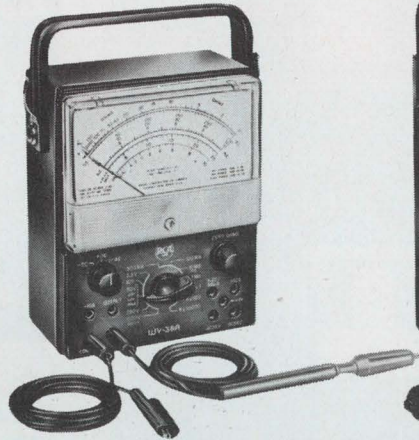

The **RCA WV-38A** Volt-Ohm Milliammeter is a rugged, accurate, and extremely versatile instrument. We think it's your best buy. Only \$52.00.\* Also available in easy to assemble kit, WV-38A (K).

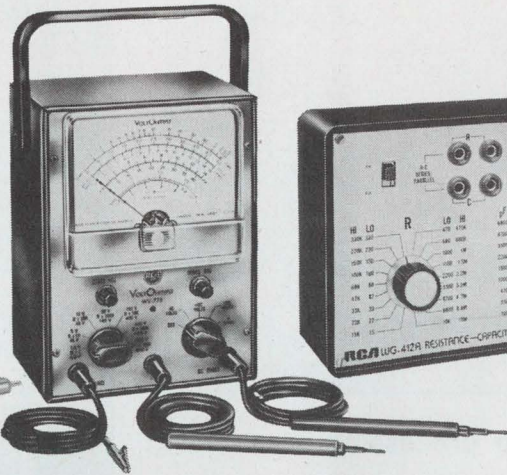

The **RCA WV-77E** Volt-Ohmyst® can be used for countless measurements in all types of electronic circuits. Reliability for budget price. Only \$52.00.\* Also available in an easy to assemble kit, WV-77E (K).

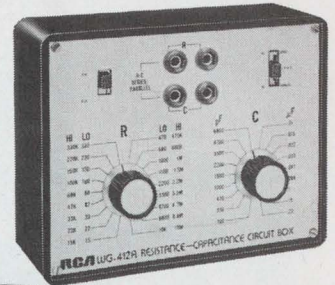

The **RCA WG-412A** R-C circuit box can help you speed the selection of standard values for resistors and capacitors, either separately or in series or parallel R C combinations. Only \$30.00.\* It's easy to use, rugged, and compact.

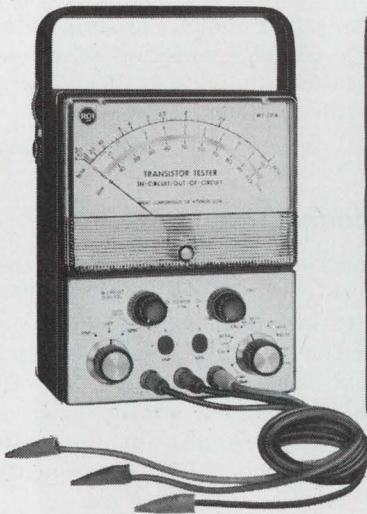

The **RCA WT-501A** in-circuit out-of-circuit transistor tester is battery operated, completely portable. It tests both low and high power transistors, has NPN and PNP sockets for convenient transistor matching for complementary symmetry applications. Only \$66.75.\*

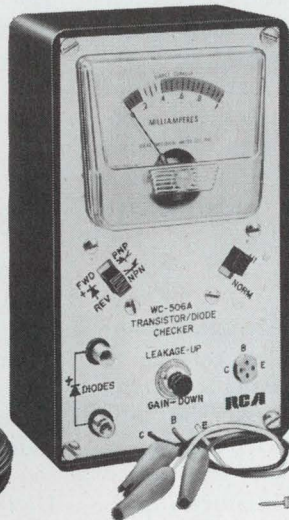

The **RCA WC-506A** transistor-diode checker offers a fast, easy means of checking relative gain and leakage levels of out-of-circuit transistors. Compact and portable, it weighs 14 ounces, measures  $3\frac{3}{4}$  by  $6\frac{1}{4}$  by 2 inches. Only \$18.00.\*



The **RCA WV-98C** Senior VoltOhmyst is the finest vacuum-tube voltmeter in the broad line of famous RCA VoltOhmysts. Accurate, dependable, extremely versatile, it is a deluxe precision instrument. Only \$88.50.\* Also available in an easy to assemble kit, WV-98C (K).

For a complete catalog with descriptions and specifications for all RCA test instruments, write RCA Electronic Components, Commercial Engineering, Dept. D-18W-1, Harrison, N.J. 07029.

\*Optional Distributor resale price. Prices may be slightly higher in Alaska, Hawaii, and the West.

LOOK TO RCA FOR INSTRUMENTS TO TEST/MEASURE/VIEW/MONITOR/GENERATE

# NEW LITERATURE



## Image processing

A 12-page color brochure describes and illustrates visual image processing through computer-based optical systems. The extraction, interpretation, modification and presentation of graphic material are discussed. Applications discussed include the tracking of human eye movements, interpreting seismograms and oscilloscope traces, processing hand-marked questionnaires, and analysis of topographical maps. Information International.

CIRCLE NO. 324

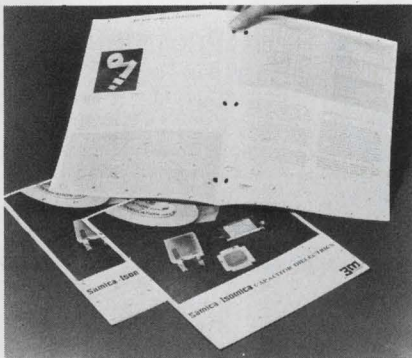

## Capacitor dielectrics

Information on capacitor dielectrics is contained in an eight-page brochure available on request. The brochure contains photographs of materials and applications, along with charts and property tables on an unimpregnated mica paper, and a silicone impregnated mica paper. Design data and processing suggestions are also included. 3M Company.

CIRCLE NO. 325

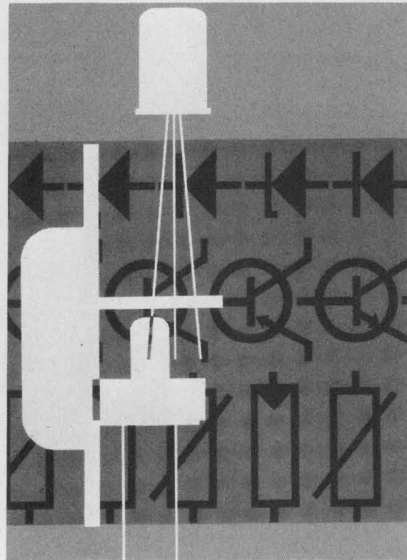

## Semiconductor catalog

A comprehensive, new buyer's guide to a line of semiconductors is now available. The 32-page catalog covers both standard and industrial semiconductors, and includes complete specifications on the latest types. The catalog covers a wide range of semiconductors, such as silicon and germanium devices, Hall-effect devices and digital integrated circuits. Siemens America Inc.

CIRCLE NO. 341

## Lamp brochures

Indexed brochures contain complete listings and illustrations of miniature and subminiature lamps and signaling devices. The brochures offer full specifications, application information and price listings. Sylvania Miniature Lighting Products.

CIRCLE NO. 342

## Instrument carts

Instrument and laboratory carts fabricated of stainless steel are described in a 16-page brochure. The line features all-welded construction, heavy duty five-inch swivel casters, and shelves molded of plywood-fiberglass laminates. Cambridge Electronics, Inc.

CIRCLE NO. 343

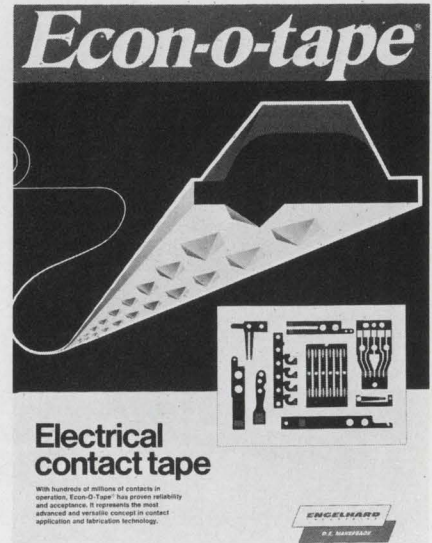

## Electrical contact tape

A 32-page brochure describes a weldable contact strip that represents an advanced and versatile concept in electrical contact application and fabrication technology. The brochure, complete with charts, tables and engineering data, covers contact material selection, application and design. Engelhard Minerals & Chemicals Corp.

CIRCLE NO. 344

## Rf connectors

Miniature rf connectors are the subject of a 4-page catalog. The publication includes technical information, outline drawings and coaxial cable information for 29 units. The catalog also describes a crimp tool designed for use with the connectors. RF Components Division of Sealectro Corp.

CIRCLE NO. 330

## Circuit protectors

A 16-page brochure contains detailed information on single and multipole electromagnetic panel-mount circuit protectors of the molded phenolic case type. Six pages of curves and charts illustrate delay characteristics, rupture capabilities and impedance values. Airpax Electronics, Cambridge Div.

CIRCLE NO. 331

Pick the  
**BEST IC**  
for the job

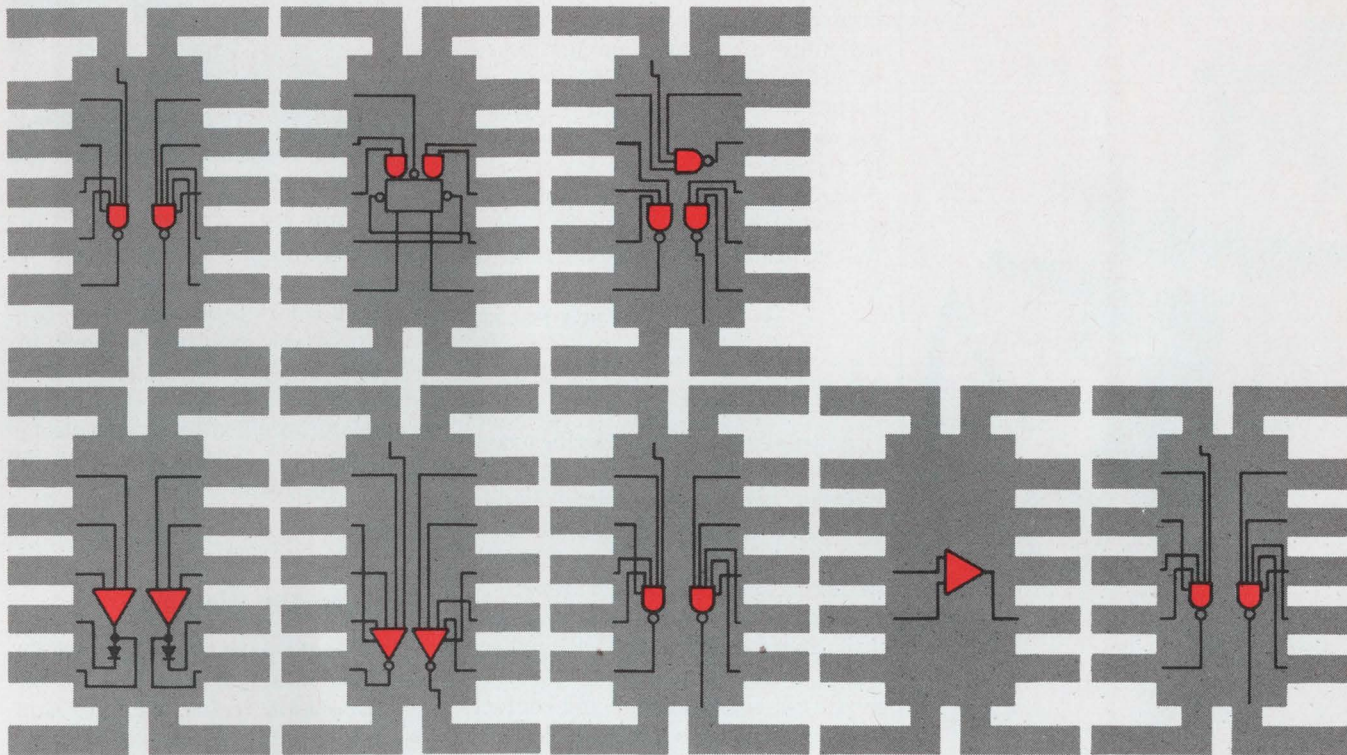

**Best line of defense against radiation environment**

Radiation offers the circuit designer two orders of magnitude improvement in hardening levels over conventional PN junction devices. This is accomplished by dielectric isolation, thin-film resistors over oxide, small-device geometries, shallow diffusions and other special design techniques. So when you pick the Best IC for a radiation environment application, doesn't it make sense to come to the leader in hardened circuit technology?

Our line of defense consists of 930 series DTL, a level shifter, a line driver and a linear 709. These are not prototype circuits. We can deliver Dual 4 Input; Dual 4 Input Power or Triple 3 Input Gates; Clocked Flip-Flop; Dual 4 Input Buffer; Dual Level Shifter; Dual Line Driver and 709 Operational Amplifiers. With the exception of the Dual Level Shifter and Dual Line Driver, all are plug-in replacements for their non-hardened 930 Series and 709 counterparts. The Hardened Dual Line Driver is a pin-for-pin replacement for Radiation's standard RD 209 Line Driver.

Want more information? Contact your nearest Radiation Sales Representative. He'll give you complete details and help you pick the Best IC for the Job.

WE MAKE THE **BEST IC** FOR THE JOB



**RADIATION**  
INCORPORATED  
SUBSIDIARY OF HARRIS-INTERTYPE CORPORATION  
MICROELECTRONICS DIVISION

RADIATION SALES OFFICES: P. O. Box 476, Lexington, Mass. 02173, (617) 862-1055 • 600 Old Country Road, Garden City, N.Y. 11530, (516) 747-3730 • 2600 Virginia Ave. N.W., Washington, D.C. 20037, (202) 337-4914 • 6151 W. Century Blvd. Los Angeles, Calif. 90045, (213) 670-5432 • Saratoga, Calif., (408) 253-5058 • P. O. Box 37, Melbourne, Fla. 32901, (305) 727-5430 • International Sales: Marketing Department, P. O. Box 37, Melbourne, Fla. 32901, (305) 727-5412

INFORMATION RETRIEVAL NUMBER 106

## VECO THERMISTORS FOR MIL. APPLICATIONS



### ...the strength and sensitivity of an ant

Ever see an ant move masses larger than itself? Or the speed it responds with at the slightest sound?

Strength and sensitivity exactly like our line of thermistor disks and rods for military or industrial use. Each is manufactured to meet, or even exceed, the requirements of MIL-T-23648.

Rugged insulated design...high reliability...and precise accuracy... makes them especially suitable

for applications of temperature measurement and control, such as transistor circuitry, within a range of  $-55^{\circ}\text{C}$  to  $+125^{\circ}\text{C}$ .

Whether your application is military or industrial, there is a VECO thermistor engineered for your requirements.

**VECO**  
**VICTORY  
ENGINEERING  
CORPORATION**  
VICTORY ROAD, SPRINGFIELD,  
NEW JERSEY 07081  
(201) 379-5900 • TWX 710-983-4430

INFORMATION RETRIEVAL NUMBER 107

## NEW LITERATURE

### PC connectors

Many solutions to PC connection problems are described in a new printed circuit/connection catalog. The book has numerous engineering diagrams that depict the typical assembly of printed circuit board to chassis or into a board assembly in parallel, perpendicular or edge-to-edge arrangement. The catalog is a valuable reference for simplifying printed-circuit assembly and achieving more economical and faster production. Molex Products Co.

CIRCLE NO. 332

### Slide switches

A 4-page bulletin describes new double-wipe slide switches. The bulletin contains complete details of the features built into the new switch. Among these are a newly designed slider for either 3- or 6-A ac ratings that improves operator feel and increases life. Engineering drawings thoroughly describe mounting configurations and contact arrangements. Switchcraft, Inc.

CIRCLE NO. 333

### Inert gas ovens

A two-page bulletin that describes inert gas ovens gives construction details and prices. Designed to speed up post-processing cool-down and to reduce gas consumption, the ovens offer a temperature range from  $+50$  to  $+538^{\circ}\text{C}$  ( $1000^{\circ}\text{F}$ ), and are available with programing or for manual steady-state operation. Blue M Engineering Co.

CIRCLE NO. 334

### Temperature control

A new booklet presents the fundamentals of proportional temperature controllers in a technically simplified manner, and shows how to apply these concepts to the reader's own applications. The booklet, illustrated by line drawings and schematics, explains proportional band, power controller input signal, rate action and reset action. Research, Inc.

CIRCLE NO. 335



### Wire stripping

A full line of hand-held and bench-mounted wire strippers is illustrated and described in an 8-page, 2-color brochure. The brochure offers helpful suggestions on how to select the correct wire stripper for a specific requirement. Complete specifications, operational drawings and ordering information are given. Ideal Industries, Inc.

CIRCLE NO. 336

### Engineering plastics

An eight-page, two-color bulletin describes polycarbonate resins, thermoplastic resins, molding compounds, and injection-moldable thermoset compounds. These materials cover the full range of performance, processing and cost requirements in plastics design, and have achieved acceptance and widespread use in business machines, appliances, electrical/electronic equipment, automotive and aircraft applications. General Electric Co., Plastics Dept.

CIRCLE NO. 337

### Aerospace motors

Compact aerospace induction motors for specialized military and industrial applications are fully described in a 3-color 10-page bulletin. Tables and drawings detail specifications and variations for 12 frame sizes, ranging from one to seven inches in diameter. Available are horsepower from 0.003 to 45, torques from 0.227 to 2000 in-oz, and speeds from 1500 to 22,500 rpm. Photos and notes illustrate a wide range of typical 60- and 400-Hz applications. Kearfott Products Div., Singer-General Precision, Inc.

CIRCLE NO. 338

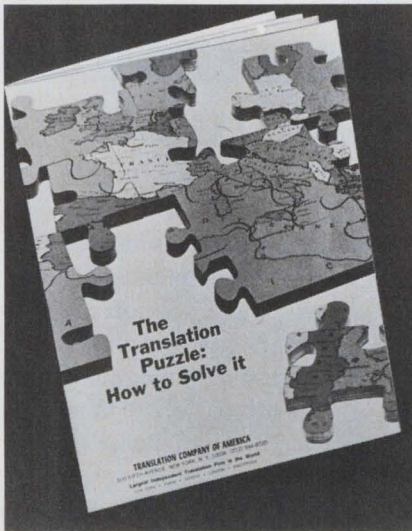

### Technical translations

*The Translation Puzzle: How To Solve It* is the title of a new 8-page brochure being offered to companies in the electrical and electronics fields. The free brochure contains information of interest to industry, government and other organizations involved in international relations, who need effective translations. It tells how an international translation organization works, and how to use translation services most effectively. Translation Co. of America.

CIRCLE NO. 339

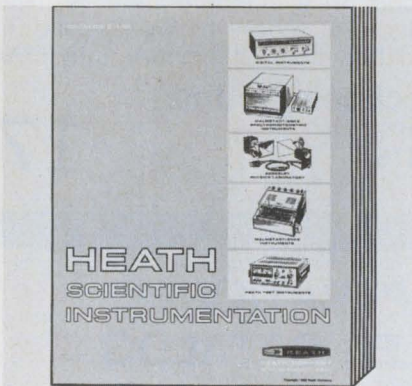

### Scientific instrumentation

The Heath scientific instrumentation catalog is now available. Featuring many new instruments for R&D or industry, this 68-page catalog includes full specifications, illustrations and many schematics. The Heath/Malmstadt-Enke Modular Digital System, a new approach to digital and analog instrumentation, is introduced. Heath Co.

CIRCLE NO. 340

# Some oscillographs have all the fun.



## This one does the work.

CEC's 5-124A probably has been the busiest oscillograph in "recorded" history. It has certainly been the most popular portable in the low-cost field.

The reasons are pretty obvious. The 5-124A weighs in at only 40 lbs., yet it can challenge the heavyweights in performance. Consequently, it has brought precise measurement to industry at a price virtually any business can afford.

Consider some of its capabilities. The direct print 5-124A loads in just 10 seconds. Records data from d-c to 13,000 Hz on 18 channels. Produces 7"-wide records at speeds up to 50,000 ips. Features 5 record speeds with instantly selectable pushbutton transmission. Seldom requires maintenance. And offers an unrivaled range of options and accessories.

For the full story of the 5-124A, call our nearest office or write Bell & Howell, Pasadena, Calif. 91109. Ask for Bulletin Kit 3310-X1.

CEC/DATA INSTRUMENTS DIVISION

 **BELL & HOWELL**

ELECTRONIC DESIGN's function is:

- To aid progress in the electronics manufacturing industry by promoting good design.
- To give the electronic design engineer concepts and ideas that make his job easier and more productive.
- To provide a central source of timely electronics information.
- To promote two-way communication between manufacturer and engineer.

**Want a subscription?** ELECTRONIC DESIGN is sent free to qualified engineers and engineering managers doing design work, supervising design or setting standards in the United States and Western Europe. For a free subscription, use the postfree application form inside the back cover. If none is included, write to us direct for an application form.

If you do not qualify, you may take out a paid subscription for \$25 a year in the U.S.A., \$35 a year elsewhere. Single copies are \$1.50 each.

**If you change your address,** send us an old mailing label and your new address; there is generally a prepaid postcard for this inside the back cover. You will have to requalify to continue receiving ELECTRONIC DESIGN free.

**The accuracy policy of ELECTRONIC DESIGN is:**

- To make reasonable efforts to ensure the accuracy of editorial matter.
- To publish prompt corrections whenever inaccuracies are brought to our attention. Corrections appear at the end of the Letters column.
- To refuse any advertisement deemed to be misleading or fraudulent.

Microfilm copies are available of complete volumes of ELECTRONIC DESIGN at \$19.00 per volume, beginning with Volume 9, 1961. Work is now in process to complete the microfilm edition of Volumes 1-8. Reprints of individual articles may be obtained for \$2.00 each, prepaid (\$.50 for each additional copy of the same article) no matter how long the article. For further details and to place orders, contact the Customer Services Department, University Microfilms, 300 North Zeeb Road, Ann Arbor, Michigan 48106; telephone (313) 761-4700.

**Want to contact us?** If you have any comments or wish to submit a manuscript or article outline, address your correspondence to:

Howard Bierman, Editor,  
ELECTRONIC DESIGN,  
850 Third Avenue,  
New York, N.Y. 10022.

# Design Data from

## Terminal Board Engineers' Guide



"Broadest Line of Terminal Boards in the Industry" —the new Kulka Catalog 17A is designed for the Specifying Engineer and Purchasing Agent. It contains 56 pages of exhaustive data on every type of terminal board in current use, including "Kliptite," High Heat, Closed Back, High Barrier, Stud and Turret, Pressure Contact, Wire-Wrap, Screw Clamp, and Military Terminal Boards. Free copy on request.

**Kulka Electric Corporation**  
520 South Fulton Ave.  
Mount Vernon, N. Y. 10551

174

## New Design Data & Specs on Displays/Readouts

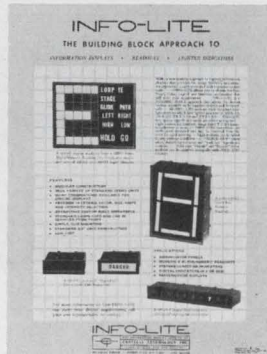

INFO-LITE is offering eight new pages of data and specifications on lighted readouts and displays. These sheets show the wide variety of display units that are available thru INFO-LITE's modular construction. Specifications and data on several standard series units are shown, including four series of 7-bar Numeric Readouts (.7", 1", 2", & 2.7" high), a series of Alpha/Numeric Readouts, four series of Panel Annunciators and a series of Digital Indicators. Information on how to specify and price standard units is included. Special units are shown pictorially and layout and specification instructions are fully covered.

**Info-Lite Div. of Cartelli Technology, Inc.**  
45-14 - 108th Street  
Corona, L.I., N.Y. 11375  
212 592-4700

175

## FREE - NEW OPERATIONAL MODULES CATALOG

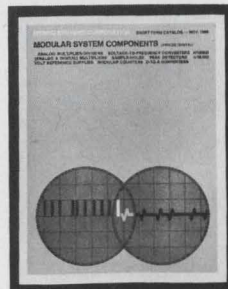

New Function Module Catalog describes solid-state IC modules:

- D/A Converters
- 10 Megahertz Analog Multiplier
- Voltage-To-Frequency Converters
- Peak Detectors
- Sample-Holds
- .1% Analog Multiplier

and other analog-digital operational modules. All units described are encapsulated plug-ins suitable for printed circuit mounting.

**HYBRID SYSTEMS CORP.**  
95 Terrace Hall Avenue  
Burlington, Massachusetts 01803

176

# Manufacturers

Advertisements of booklets, brochures, catalogs and data sheets. To order use Reader-ServiceCard.  
(Advertisement)

## FREE PUSH BUTTON SWITCH CATALOG L-209

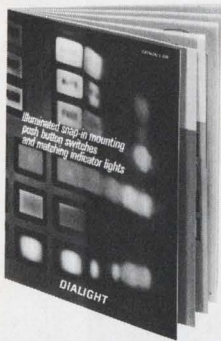

**New from Dialight Corporation!** Available is a full color catalog providing data, specifications and ordering information for newly introduced illuminated Snap-in Mounting Push Button Switches and Matching Indicator Lights. Switches are momentary or alternate action, with ratings 125V AC, up to 5 amps. Round, square and rectangular push button caps are illustrated in full color. A wide array of cap shapes, colors and bezel combinations may be had, making panel designing easier than ever. Send for FREE catalog today.

**Dialight Corporation**  
60 Stewart Avenue  
Brooklyn, N.Y. 11237  
Telephone: (212) 497-7600

177

## A FREE Cross Reference Guide



**to better Printed Circuit drafting**  
No engineer or draftsman should be without the NEW By-Buk Printed Circuit Drafting Aids P-45 Catalog with color-coded MIL-SPEC sizes. Also contains over 2000 pads, shapes, tapes, transistor tri-pads, spaced integrated circuit terminal pad sets and many other drafting aids for faster, more accurate, distortion-free printed circuit master drawings. Send for your FREE catalog.

**By-Buk Company**  
4326 West Pico Blvd., Los Angeles, Calif. 90019  
Telephone: (213) 937-3511

178

## Quality Fasteners For All Designs



This 8-page catalog provides design data on the complete group of DZUS 1/4-turn self-locking fasteners for standard, high speed and panel applications, as well as universal high strength multiple thread fasteners for high tensile and shear stresses. Dzus stud assemblies, wire forms and receptacles offer an exceptional, wide variety of combinations from stock to fit specific fastening requirements. Diagrams and tables give full details for rapid, unlimited design selection. Condensed or complete Catalog available on request.

**Dzus Fastener Co., Inc.**  
425 Union Boulevard  
West Islip, L. I., N. Y. 11795

179

## Advertising Sales Staff

### New York 10022

Robert G. Drake  
Sales Manager  
Edward F. Clancy  
Sales Service Manager  
Robert W. Gascoigne  
Thomas P. Barth  
Samuel M. Deitch  
Byron Adams  
850 Third Avenue  
(212) Plaza 1-5530  
TWX: 867-7866

### Philadelphia 19066

William C. Repetto  
P. O. Box 206  
Merion Station, Pa.  
(215) MA-3-5888

### Boston 01945

Richard Parker  
P.O. Box 645  
Clifton Station  
Marblehead, Mass.  
(617) 742-0252

### Chicago 60611

Thomas P. Kavooras  
Berry Conner, Jr.  
200 East Ontario  
(312) 337-0588

### Cleveland

Thomas P. Kavooras  
(Chicago)  
(312) 337-0588  
(call collect)

### Los Angeles 90303

Stanley I. Ehrenclou  
John V. Quillman  
W. James Bischof  
2930 Imperial Highway  
Inglewood, Calif.  
(213) 757-0183

### San Francisco 94022

Arthur R. Shields, Jr.  
175 San Antonio Rd., S 243  
Los Altos, Calif.  
(415) 941-3084

### London W. 1

For United Kingdom & Holland  
Brayton C. Nichols  
44 Conduit Street  
Tel: REGent 4714

### Verviers, Belgium

For Continental Europe  
Andre Jamar  
1, Rue Mallar, 1  
(087) 253.83 Telex 41563

### Tokyo

Yoshihiro Takemura  
IPS Group Ltd.  
Box 36, Ohsaki Post Office  
Phone (431) 5804



# A 2 KVA 400 CYCLE, SOLID STATE BIPPY?

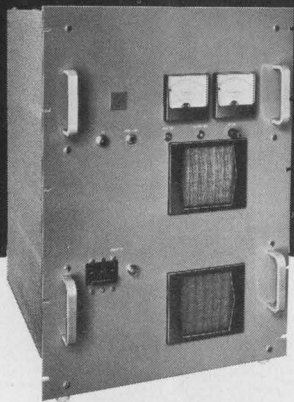

Around here, it's affectionately called just that. But you can simply refer to our newest creation as the CML Model CRS-2000A Frequency Converter until you get used to the idea of a Bippy hanging around. It features low distortion sine wave output and excellent regulation... less than 1% voltage regulation, less than 0.5% frequency regulation. Full power is available into leading and lagging power factor loads. The Bippy is solidly built (as all Bippys are), air cooled, and extremely quiet (as all Bippys are not)... measures 19" x 26 1/4" x 20". Ideal for marine and ground support installation, portable shelters, communications vans, radar systems, aircraft maintenance depots. This truly is the Bippy you can bet on. It socks the power to you!

**CML, Inc.**

a subsidiary of  
Tenney Engineering, Inc.

350 Leland Avenue  
Plainfield, N.J. 07062  
(201) 754-5502 • TWX 710-997-9529



## Advertisers' Index

Advertiser	Page
AMF, Alexandria	140
API Instruments Co.	127
Abbot Transistor Laboratories Incorporated	14
Acopian Corporation	119
Adams & Westlake Company, The	110
Alfred Electronics	45
Allen-Bradley Co.	113, 115
Amphenol, The Bunker-Ramo Corporation	105, 106
Astrodata, Inc.	98, 99
Axel Electronics, Inc.	134
Beckman Instruments, Inc., Helipot Division	27
Bell & Howell	147
Bendix Corporation, The Semiconductor Division	87
Blu-Ray Incorporated	137
Bourns, Inc.	46
Braun Tool & Instrument Co., Inc.	129
Bud Radio, Inc.	91
Burns & Towne, Inc.	138
By-Buk Company	149
CMC, A Division of Pacific Industries	23
CML, Inc.	150
Clevite Corporation, Piezoelectric Division	137
Concord Electronics Corporation	137
Corning Glass Works, Electronic Products Division	40, 41
Cunningham, Subsidiary of Gleason Works	136
Dale Electronics, Inc.	96, 97, 151
Damon Engineering, Inc.	24
Data Products Corporation	10
Delco Radio, Division of General Motors	74, 75
Dialight Corporation	149
Digitran Company, The	81
Direct Access Computing Corp.	126
Dumont Oscilloscope Laboratories, Inc.	6
Dzus Fastener Co., Inc.	149
EMN Company	81
Eimac, A Division of Varian	37
Elco Corporation	141
Electro Science Laboratories, Inc.	126
Fairchild Semiconductor, A Division Fairchild Camera and Instrument Corporation	39, 51, 95, 96
Fifth Dimension, Inc.	132
Filtran Company, Inc.	121
General Electric Company, Specialty Control Department	139
General Instrument Corporation	69
General Radio Company	85
Guardian Electric Manufacturing Company	15, 107
HEI, Inc.	133
Heath Company	131
Hewlett-Packard	1, 83, 92
Honeywell, Precision Meter Division	89
Hybrid Systems Corp.	148
IBM Industrial Products	4, 5

Advertiser	Page
ITT Electron Tube Division	11
Indiana General Corporation	12, 13
Info-Lite Div. of Cartelli Technology, Inc.	148
Ingersoll Products, Division of Borg Warner Corporation	108
Kay Electric Company	122
Kulka Electric Corp.	148
Kurz-Kasch, Inc.	109, 129
Lectrohm Inc., A Subsidiary of Cook Electric	135
Mechanics for Electronics, Inc.	118
Microdyne Instruments, Inc.	125
MicroSwitch, A Division of Honeywell	102, 103, 104
Monsanto Company	Cover III
National Semiconductor Corporation	33, 35
Phelps Dodge Copper Products Corporation	130
Philbrick/Nexus Research, A Teledyne Company	100, 101
Plastic Capacitors, Inc.	120
Potter & Brumfield Division of American Machine & Foundry Company	116, 117
Power/Mate Corp.	81, 133, 151
RCA Electronic Components and Devices	49, 143, Cover IV
Radiation, Incorporated	145
Schweber Electronics	17
Scientific Research Corporation	128
Shaffstall Ball Corporation	133
Signetics Corporation, A Subsidiary of Corning Glass Works	31
Siliconix Incorporated	62, 63
Simpson Electric Company	123
Sprague Electric Company	18, 20
Stackpole Components Company	7
Sylvania Electric Products, Inc.	8, 9, 104A-H
Syston-Donner Corporation	2
TRW Semiconductors, A Subsidiary of TRW, Inc.	Cover II
Technipower, Inc.	43
Tektronix, Inc., Oscilloscopes	54
Texas Instruments Incorporated	52
Transistor Electronics Corporation	151
Unimax Switch, Division Maxon Electronics Corporation	129
Unitrode Corporation	29
Victory Engineering Corporation	146
W & G Instruments, Inc.	50
Career Advertising:	
IBM Corporation	16



# POWER/MATE CORP. UNI-76

## UNIVERSAL POWER SUPPLY

- ❖ 0 to 34 volts at 0.5 AMPS.
- ❖ .005% regulation
- ❖ 250 Microvolts ripple
- ❖ Meets MIL-E-5272 specs
- ❖ 100,000 hours MTBF
- ❖ 5 year warranty

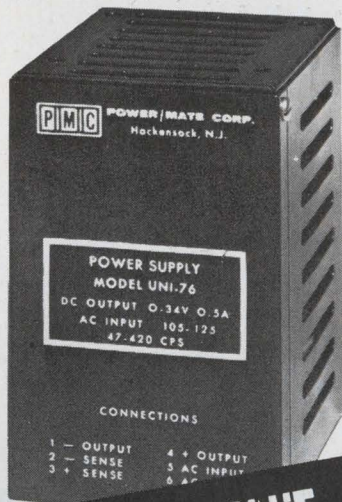

**SAME DAY SHIPMENT**

**\$76.00**



**POWER/MATE CORPORATION**  
163 Clay St. ■ Hackensack, N. J. 07601  
(201) 343-6294 ■ TWX (710) 990-5023

INFORMATION RETRIEVAL NUMBER 110

## SWITCH/INDICATORS

Unlimited Variety

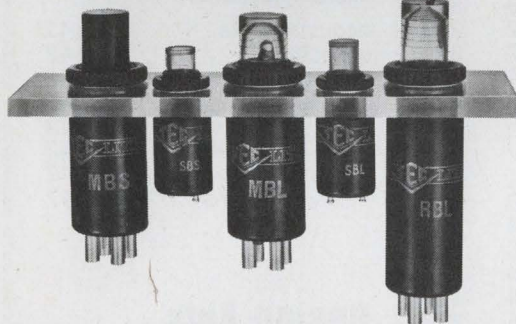

Aren't these what you're looking for? Endless variety and options. Million-cycle reliability! Low, off-the-shelf prices. Compact design. TEC's got 'em . . . in switches matchmated with TEC-LITE Indicators to give your panel a more handsome design. For information about TEC's complete line of switch/indicators • readouts • display panels • data entry keyboards • CRT display terminals, call (612) 941-1100 or write:



**Transistor  
Electronics  
Corporation**

Box 6191 • Minneapolis, Minnesota 55424

INFORMATION RETRIEVAL NUMBER 111

ELECTRONIC DESIGN 7, April 1, 1969

# Transients stop here!



## New Dale Arrester Provides Reliable, Low-Cost Surge Protection

Dangerous transient voltages get nowhere when you put Dale's new Surge Protector in their path. For a few dollars, this new design provides the best insurance you can buy against damage from direct lightning strikes, and from transients induced by lightning and switching. Here are just a few of its advantages over other low-cost protectors:

**SENSITIVITY** Typical breakdown voltage is 1500 volts when subjected to a voltage pulse rising at 10 kv/ $\mu$ sec. Power-follow current is extinguished within 1/2 cycle or less.

**REPEATABILITY** Will bypass repeated overvoltages without significant change in breakdown level.

It's weatherproof, mounts anywhere, meets all applicable NEMA, USAS and IEEE standards. For a few bucks, it can save you a bundle. Write for complete information.



**DALE ELECTRONICS, INC.**  
**SIOUX DIVISION** Dept. ED  
Yankton, South Dakota 57078

Producers of: Toroids, Series Resonant Traps, Variable Pitch Inductors, Miniature High Frequency Inductors, Degaussing Coils, Industrial and Military Coils, Subminiature Coils, Surge and Lightning Arresters, Custom Assemblies, Motor Driven Potentiometers.

INFORMATION RETRIEVAL NUMBER 112

# Information Retrieval Service

All products, design aids (DA), application notes (AN), new literature (NL), and reprints (R) in this issue are listed here with Page and Information Retrieval numbers. Reader requests will be promptly processed by computer and mailed to the manufacturer within three days.

Category	Page	IRN	Category	Page	IRN	Category	Page	IRN
<b>Components</b>			picoammeter, digital	134	<b>288</b>	scriber, carbide-tip	132	<b>282</b>
beads, ferrite (ES)	138	<b>346</b>	processor, video	135	<b>290</b>	soldering tool kit	132	<b>283</b>
capacitors (AN)	142	<b>297</b>	pulse generator	134	<b>287</b>	temperature control (NL)	146	<b>335</b>
circuit protectors (NL)	144	<b>331</b>	temperature control (NL)	146	<b>335</b>	templates (DA)	140	<b>333</b>
components (AN)	142	<b>295</b>	voltmeter, memory	134	<b>286</b>	twister, fine wire	132	<b>280</b>
connectors, PC (NL)	146	<b>332</b>	<b>Microwaves &amp; Lasers</b>			wire strippers (NL)	146	<b>336</b>
connectors, rf (NL)	144	<b>330</b>	acoustic data (AN)	142	<b>322</b>			
decoder/display	127	<b>273</b>	attenuator, rotary	118	<b>259</b>			
diode, suppressor	124	<b>266</b>	back diodes, planar	177	<b>254</b>			
diodes, VVC (AN)	142	<b>299</b>	beads, ferrite (ES)	138	<b>346</b>	<b>New Literature</b>		
DTL substitutes (DA)	140	<b>331</b>	components (AN)	142	<b>295</b>	carts, instrument	144	<b>343</b>
extrusions, plastic	136	<b>293</b>	connectors, rf (NL)	144	<b>330</b>	circuit protectors	144	<b>331</b>
extrusions, profile (ES)	138	<b>349</b>	detector, microwave	117	<b>255</b>	connectors, PC	146	<b>332</b>
ICs, hardened	124	<b>265</b>	detector, vector (AN)	142	<b>323</b>	connectors, rf	144	<b>330</b>
lamps (NL)	144	<b>342</b>	laser, He-Ne	114	<b>251</b>	dielectrics	144	<b>325</b>
lamps, indicator	126	<b>272</b>	light measurement (AN)	142	<b>321</b>	image processing	144	<b>324</b>
logic ICs, fast	112	<b>250</b>	shielding kit (ES)	138	<b>348</b>	instrumentation	147	<b>340</b>
magnetic pickups (DA)	140	<b>350</b>	sweeper plug-ins	118	<b>257</b>	lamps	144	<b>342</b>
motors (NL)	146	<b>338</b>	switch, microwave	177	<b>252</b>	motors	146	<b>338</b>
op amp, dual	124	<b>268</b>	synthesizer, S-band	118	<b>258</b>	ovens, inert gas	146	<b>334</b>
PC chart (DA)	140	<b>352</b>	transistor, vhf power	117	<b>253</b>	plastics	146	<b>337</b>
reed relay, DIP	127	<b>274</b>	transistors, rf power	118	<b>256</b>	semiconductors	144	<b>341</b>
SCR, plastic	124	<b>267</b>	<b>Modules &amp; Subassemblies</b>			switches, slide	146	<b>333</b>
semiconductors (NL)	144	<b>341</b>	circuit protectors (NL)	144	<b>331</b>	tape, contact	144	<b>344</b>
shielding kit (ES)	138	<b>348</b>	decoder/display	124	<b>273</b>	temperature control	146	<b>335</b>
shift registers	124	<b>269</b>	decoder/drivers, IC	131	<b>278</b>	translations, tech	147	<b>339</b>
switches, slide (NL)	146	<b>333</b>	logic cards	131	<b>279</b>	wire strippers	146	<b>336</b>
terminals and splices	136	<b>294</b>	logic ICs, fast	112	<b>250</b>			
thyristors	124	<b>270</b>	meters, digital panel	134	<b>288</b>			
trimmer, DIP	126	<b>271</b>	mixers, balanced	130	<b>276</b>			
tubing, shrinkable (ES)	138	<b>347</b>	op amp	128	<b>275</b>			
wiring mounts (ES)	138	<b>345</b>	op amp, dual	124	<b>268</b>			
			PC chart (DA)	140	<b>353</b>			
<b>Data Processing</b>			power supplies (AN)	142	<b>298</b>			
data recording system	120	<b>260</b>	reed relay, DIP	127	<b>274</b>	<b>Application Notes</b>		
data set	122	<b>261</b>	shift registers	124	<b>269</b>	acoustic data	142	<b>322</b>
file, paper-tape	122	<b>262</b>	transducers, voltage	130	<b>277</b>	capacitors	142	<b>297</b>
image processing (NL)	144	<b>324</b>	trimmer, DIP	126	<b>271</b>	detector, vector	142	<b>323</b>
intercoupler	123	<b>264</b>	<b>Packaging &amp; Materials</b>			die casting	142	<b>296</b>
keyboard terminal	123	<b>263</b>	beads, ferrite (ES)	138	<b>346</b>	diodes, VVC	142	<b>299</b>
logic ICs, fast	112	<b>250</b>	carts, instrument	144	<b>343</b>	light measurement	142	<b>321</b>
shift registers	124	<b>269</b>	connectors, PC (NL)	146	<b>332</b>	microwave components	142	<b>295</b>
			connectors, rf (NL)	144	<b>330</b>	power supplies	142	<b>298</b>
<b>ICs &amp; Semiconductors</b>			dielectrics (NL)	144	<b>325</b>			
diode, suppressor	124	<b>266</b>	extrusions, plastic	136	<b>293</b>			
diodes, VVC (AN)	142	<b>299</b>	extrusions, profile (ES)	138	<b>349</b>			
DTL substitutes (DA)	140	<b>352</b>	fiber optics	136	<b>292</b>			
IC packages	136	<b>291</b>	IC packages	136	<b>291</b>			
ICs, hardened	124	<b>265</b>	PC chart (DA)	140	<b>353</b>			
logic ICs, fast	112	<b>250</b>	plastics (NL)	146	<b>337</b>	<b>Design Aids</b>		
op amp, dual	124	<b>268</b>	shielding kit (ES)	138	<b>348</b>	cost analyzer	140	<b>351</b>
SCR, plastic	124	<b>267</b>	tape, contact (NL)	144	<b>344</b>	DTL substitutes	140	<b>352</b>
semiconductors (NL)	144	<b>341</b>	terminals & splices	136	<b>294</b>	magnetic pickups	140	<b>350</b>
shift registers	124	<b>269</b>	tubing, shrinkable (ES)	138	<b>347</b>	PC chart	140	<b>353</b>
thyristors	124	<b>270</b>	wiring mounts (ES)	138	<b>345</b>	templates	140	<b>354</b>
			<b>Production</b>					
<b>Instrumentation</b>			cost analyzer (DA)	140	<b>351</b>			
acoustic data (AN)	142	<b>322</b>	desoldering kit	132	<b>284</b>			
carts, instrument (NL)	144	<b>343</b>	die casting (AN)	142	<b>296</b>			
counter-timer, IC	135	<b>289</b>	extractor, DIP	132	<b>281</b>			
detector, vector (AN)	142	<b>323</b>	ovens, inert gas (NL)	146	<b>334</b>			
image processing (NL)	144	<b>324</b>						
instrumentation (NL)	147	<b>340</b>						
light measurement (AN)	142	<b>321</b>						
meters, digital panel	134	<b>288</b>						
power supplies (AN)	142	<b>298</b>						

# Small wonder:



**Our new "4th generation"**  
**12.5 MHz universal counter/timer**  
**Wonderful versatility.**  
**Wonderful small package.**  
**Wonderful small price.**

With the new Model 100A you can measure average frequency, frequency ratio, single period or time interval, or count total events. It has a crystal-controlled clock, Monsanto integrated circuit construction, and built-in compatibility with a rapidly growing assemblage of accessory modules.

With its \$575 price tag, FOB West Caldwell, New Jersey, you can have big-league counter/timer performance at costs never before possible. Small wonder we are selling and delivering Model 100A's just as fast as we can build them. Accessory modules are also comparably modestly priced.

For a demonstration of our "Small Wonder," the Model 100A universal counter/timer, or for full technical details call your local Monsanto Field Engineer, or contact us directly at: Monsanto Company, Electronic Instruments, West Caldwell, New Jersey 07006, (201) 228-3800.

## Monsanto

# IT'S A WINNER!

# VERSAWATT

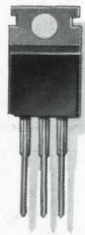

RECEIVED  
APR 3 1969  
CALMA CO.

Now, the contest is over! And a winning package for RCA transistors and thyristors has a new winning name: VERSAWATT! You gave us thousands of names. We picked VERSAWATT... because it most aptly describes the quality and versatility of our molded silicone package.

VERSAWATT is RCA's plastic unit on a solid-copper base which displays brute power dissipation capability—up to 50 watts in the transistor line; power handling capability up to 10 kW in thyristors. It is rugged. It has "volumetric" efficiency. It has compactness—a space-saving advantage over larger, equivalent types—that makes VERSAWATT an ideal package for PC board applications where hermetic types previously were employed.



VERSAWATT means versatility in mounting possibilities. RCA offers three basic configurations (you can devise your own option to fit your needs). These configurations are for PC boards and direct plug-in for TO-66 sockets.

VERSAWATT is a plastic package offering different chips for outstanding electrical performance—in transistors, from milliamperes to several amperes. In thyristors, 120- and 240-volt line operation VERSAWATT 8-ampere triacs have low thermal resistance—better than many hermetic types. They offer a high 100 A peak surge current capability.

VERSAWATT has proven reliability, backed by data from more than three years of field testing in commercial and industrial applications. An added plus: VERSAWATT transistor units employ Hometaxial-base construction, the industry's best answer yet for freedom from second breakdown.

Check the charts for units packaged as VERSAWATT transistors and thyristors. There are more to come. Right now, see your local RCA Representative or your RCA Distributor for more information. For technical data on specific types, write: RCA Electronic Components, Commercial Engineering, Section IFG-1 Harrison, N.J. 07029.

The winning entry, submitted by Mr. Donald P. Clark, of Attleboro, Mass., has won for him a 10-day round-trip vacation for two to Hawaii.

#### RCA VERSAWATT Transistor Family

TYPE	V <sub>CE</sub> (sus)**	h <sub>FE</sub>
2N5293+ 2N5294+	75 V	30-120 @ I <sub>C</sub> = 0.5 A, V <sub>CE</sub> = 4 V
2N5295+ 2N5296+	50 V	30-120 @ I <sub>C</sub> = 1 A, V <sub>CE</sub> = 4 V
2N5297+ 2N5298+	70 V	20-80 @ I <sub>C</sub> = 1.5 A, V <sub>CE</sub> = 4 V
2N5490* 2N5491*	50 V	20-100 @ I <sub>C</sub> = 2.0 A, V <sub>CE</sub> = 4 V
2N5492* 2N5493*	65 V	20-100 @ I <sub>C</sub> = 2.5 A, V <sub>CE</sub> = 4 V
2N5494* 2N5495*	50 V	20-100 @ I <sub>C</sub> = 3 A, V <sub>CE</sub> = 4 V
2N5496* 2N5497*	80 V	20-100 @ I <sub>C</sub> = 3.5 A, V <sub>CE</sub> = 4 V

+ $\theta_{J-C}$  = 3.5°C/W max. \* $\theta_{J-C}$  = 2.5°C/W max. \*\*R<sub>BE</sub> = 100 ohms

#### RCA VERSAWATT Triac Family

	V <sub>DROM</sub>	I <sub>GT</sub>	
		I <sub>I</sub> + III - modes	I <sub>I</sub> - III + modes
40668	200 V	25 mA max.	60 mA max.
40669	400 V	25 mA max.	60 mA max.

$\theta_{J-C}$  = 2.2°C/W max.