

# Electronic Design 14

VOL. 15 NO.

FOR ENGINEERS AND ENGINEERING MANAGERS.

JULY 5, 1967

**Power circuits in a tiny cube** supply 30 to 100 watts. All five members of the family – inverters, converters and regulators – are in this unique new half-cubic-inch

package. The electrically isolated 'terminator-dissipators' serve as mechanical housing, terminations and heat dissipators. For a look at some cubic art, see page 130.

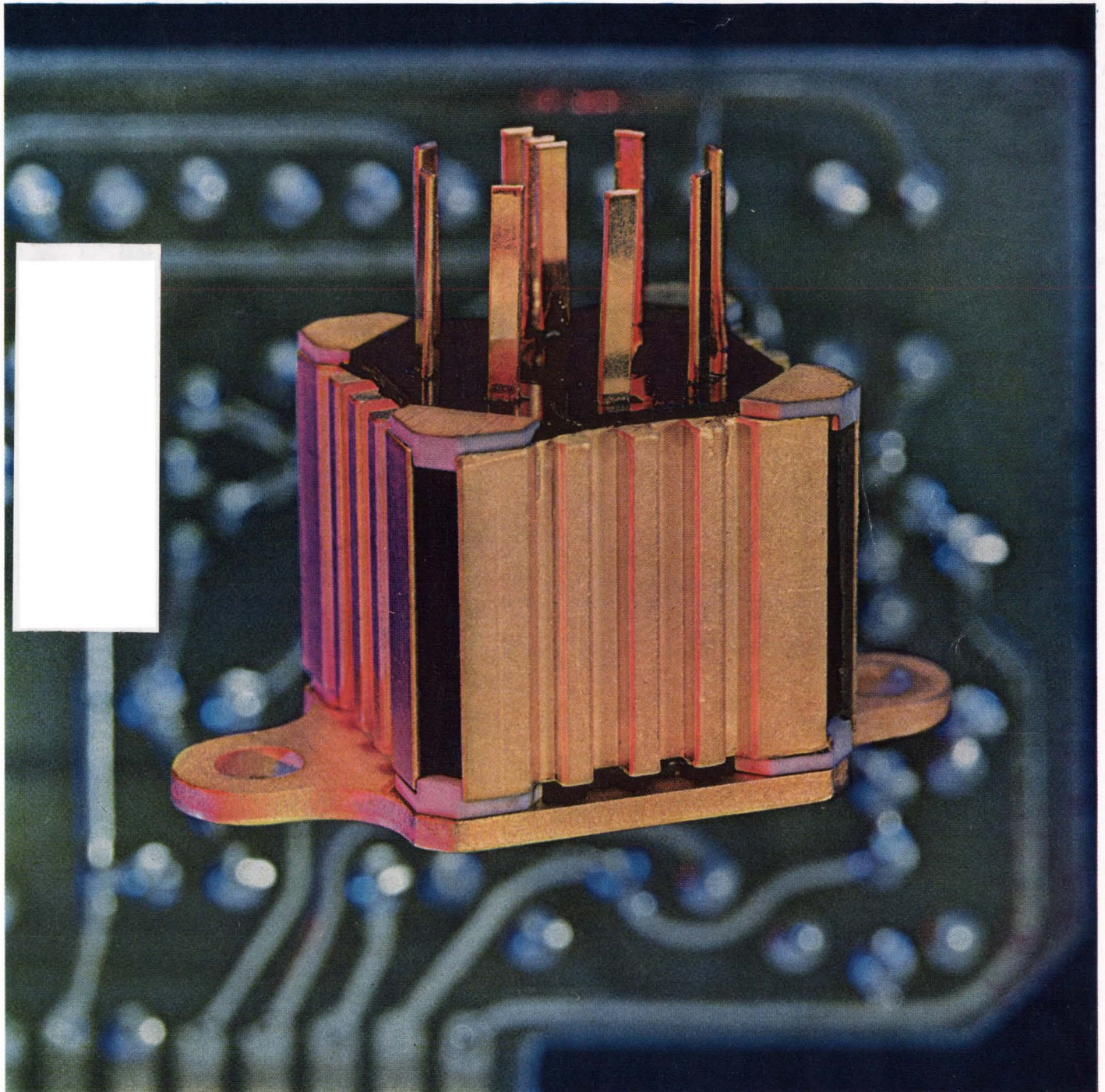

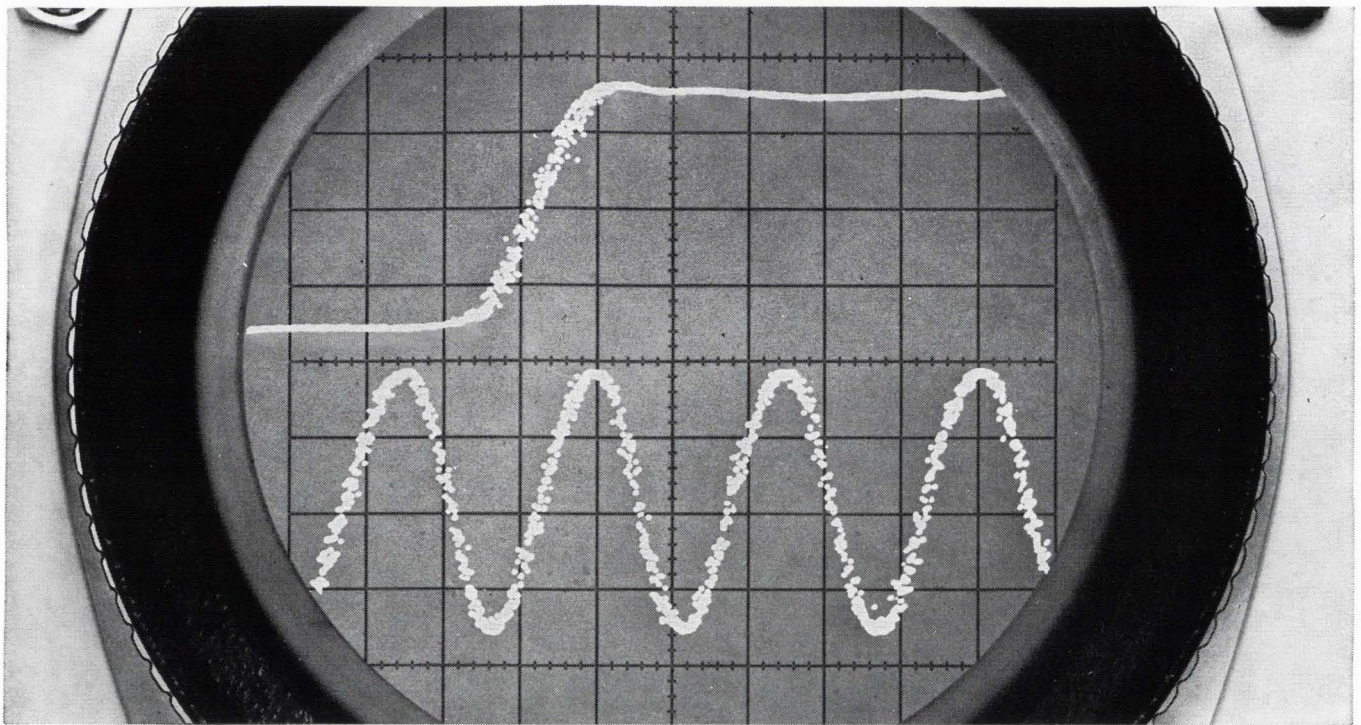

*Put this new design window in your lab*

## SEE WAVEFORMS TO **12.4 GHz** & BEYOND

For the first time, you can directly see 12.4 GHz phenomena, 28 psec rise time pulses, delayed sweep displays, and 40 psec TDR. And, for an encore, this new sampling scope system gives you less than 20 psec jitter for sharp displays, automatic triggering for fast easy trace set-up, and remote samplers which monitor feed-through signals with minimum loading. Time difference between channels is less than 5 psec for accurate phase measurements. You can build your system around the field-proven 140A mainframe (or the stop-action 141A with variable persistence and storage) using these all solid-state plug-ins:

**NEW DUAL-CHANNEL 1411A VERTICAL AMPLIFIER** functions with any of three dual-channel remote samplers, with sensitivities to 1 mv/cm: (1) Model 1430A with 28 psec rise time for optimum pulse response; (2) Model 1431A, DC to 12.4 GHz with an extremely flat bandwidth and low VSWR (1.4:1 to 8 GHz, 2:1 at 12.4 GHz); and (3) Model 1432A with 4 GHz bandwidth, 90 psec rise time. Additional versatility is provided by front panel recorder outputs, and A vs. B mode for accurate phase measurements. Price of the 1411A Vertical Amplifier: \$700. Samplers: \$3000 for 1430A and 1431A; \$1000 for 1432A.

**NEW 1425A TIME BASE & DELAY GENERATOR**, first with delayed sweep sampling, gives sharp, jitter-free magnification of complex signals or long pulse trains. It provides maximum sweep speeds of 10 psec/cm, triggering to 1 GHz and delay times as long as 5 ms. Straight-forward control nomenclature and layout make it easy to use. So does automatic triggering, push-button return to X1 magnification and an intensified dot which

locates the expansion point for you when setting up a magnified trace. \$1600.

Also available: Model 1410A Vertical Amplifier with 1 mv/cm at 1 GHz (\$1600), 1104A/1106A Countdown for triggering to 18 GHz (\$750), and 1105A/1106A 20 psec Pulse Generator (\$750). Mainframe prices: 140A, \$595; 141A, \$1395. With the versatile hp 140 Scope System, you get *better performance in any direction*: 20 MHz wide-band • TDR • high-sensitivity with no drift • variable persistence and storage – *and sampling*.

Get complete specs on the new hp sampling oscilloscopes. Write or call Hewlett-Packard, Palo Alto, California, 94304. Phone (415) 326-7000. In Europe: 54 Route des Acacias, Geneva.

087/11 R

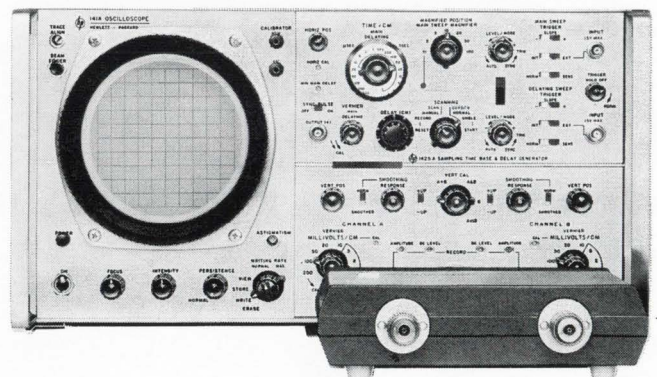

**HEWLETT**  **PACKARD**  
An extra measure of performance

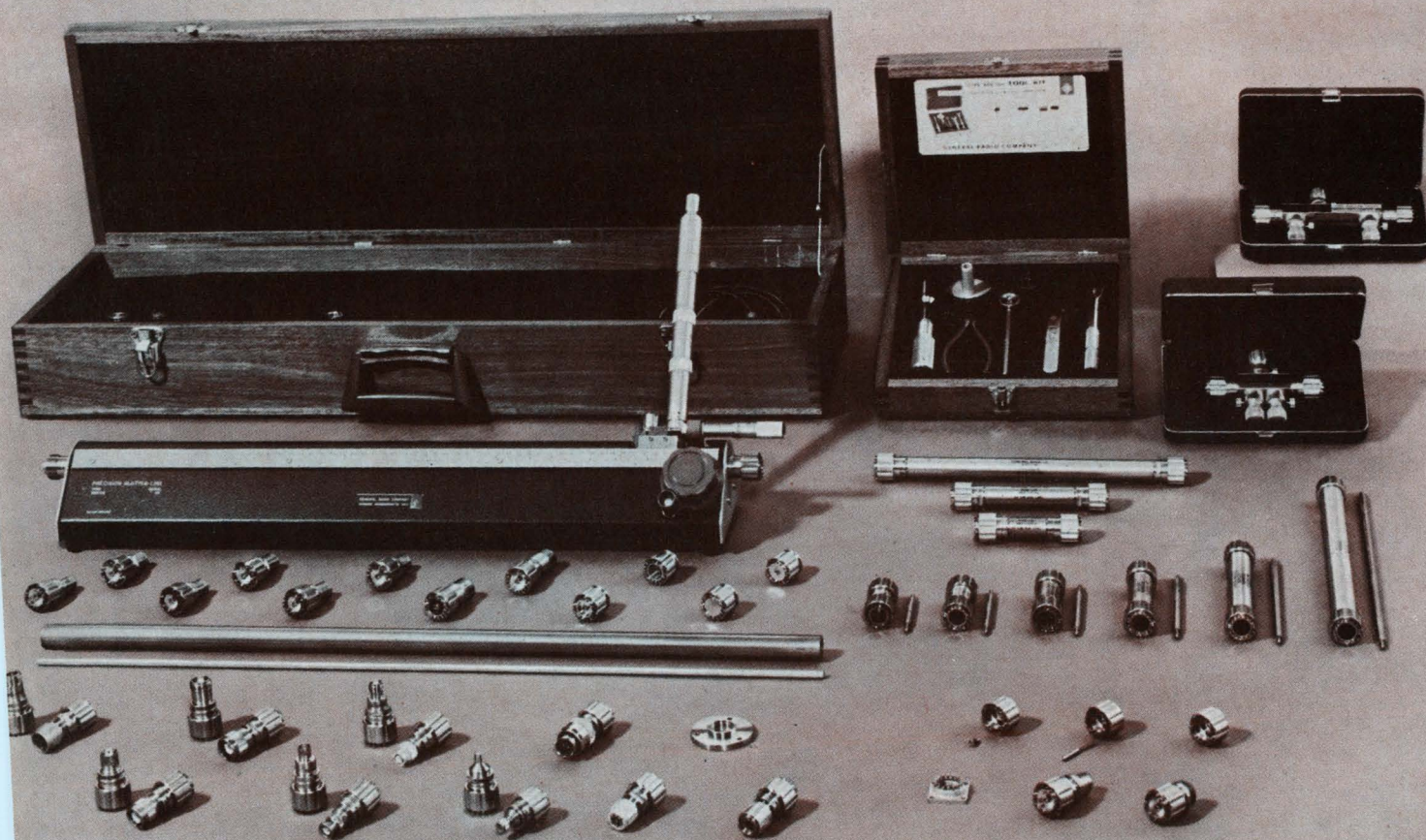

## Today's standards for precision coaxial measurements

The GR900 connector gives new meaning to accuracy in microwave measurements. With VSWR less than  $1.001 + 0.001 f_{\text{GHz}}$  to 8.5 GHz, characteristic impedance accurate to 0.1%, shielding better than 130 dB, and repeatability within 0.03%, the 14-mm GR900 has become a recognized industry standard.

Today the GR900 line of coaxial components contains air lines, standards, terminations, a slotted line, tuners, elbow, and adaptors to most other popular coaxial connectors (N, TNC, BNC, C, SC, OSM/BRM, GR874, Amphenol APC-7, and 7-mm Precifix). And the GR900 product line is still growing.

For high-accuracy microwave measurements, you won't find anything that will outperform the GR900. For complete information, write General Radio Company, W. Concord, Massachusetts 01781; telephone (617) 369-4400; TWX (710) 347-1051.

### GENERAL RADIO

ON READER-SERVICE CARD CIRCLE 2

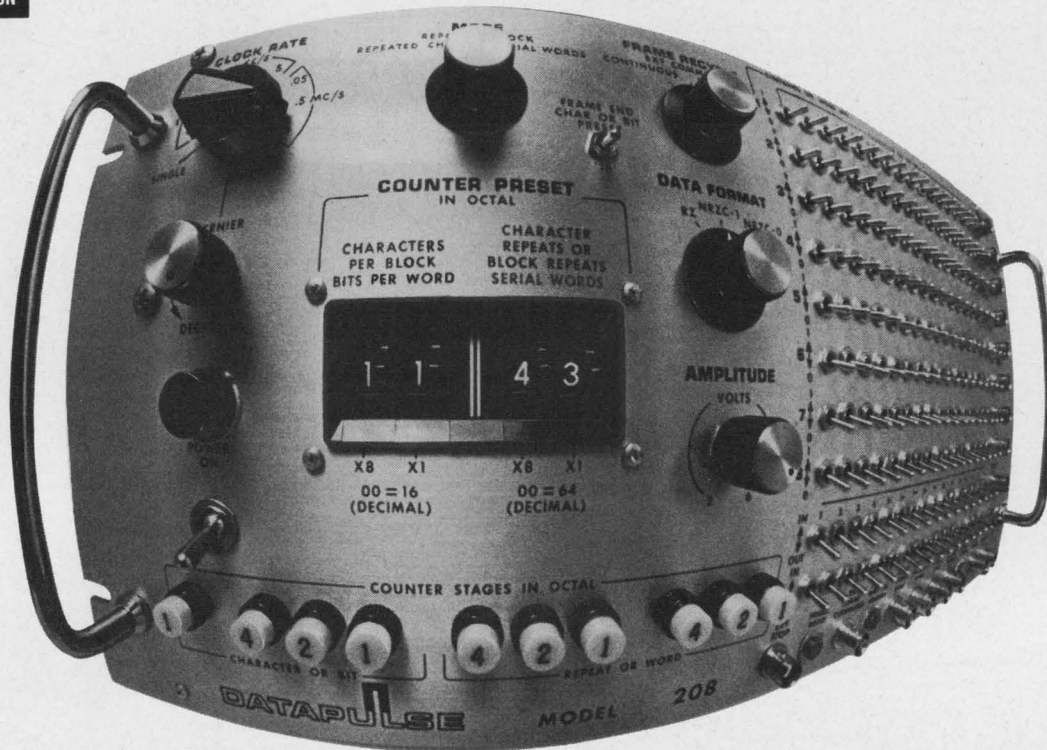

## A most unforgettable Character Generator

Before you design your own data simulator, discover the many faces of the Datapulse 208!

The basic 208 gives you 8 parallel channels, clock rates to 5 MHz, 1 to 16 serial bits plus repeats, RZ and NRZ outputs, and unequalled control over data format and content. Variable block length and blocks-per-frame let you simulate high speed paper or magnetic tape data. Digitally controlled repeats let you generate longer patterns. Eight 16-bit serial words may be commutated on a single line with digital control of words-per-frame for simulation of PCM data or multiplexing systems.

Your 208 can be different from all others. That's because its simple logic-block design is easily modified to meet your exact requirements.

The 208 is but one of seven Datapulse data generators, with clock rates to 20 MHz, word lengths to 100 bits, and from 1 to 6 channels.

Ask for our catalog for complete specifications.

Datapulse welcomes technical employment inquiries.

**DATAPULSE**<sup>®</sup>

---

## NEWS

- 13 News Scope
- 17 **Picosecond light pulses go begging**  
Electronic applications of ultrashort laser pulses await design of faster devices.
- 22 **Far-out communications for unorthodox wars**  
Army studies use of soil, water, rails and skin for transmitting messages.
- 26 **'Flame laser' requires no electrical supply**  
Burning CO radiates energy to excite CO<sub>2</sub> in a sealed tube.
- 29 Washington Report
- 36 **Low-cost display tested for computer 'utilities'**  
MIT laboratory terminal gives graphic input and output on memory CRT.
- 44 Laser cane helps blind around objects.
- 48 Rain data array aids microwave studies.
- 52 Letters
- 59 **Editorial:** It isn't the retrieval, it's what you retrieve.

---

## TECHNOLOGY

- 62 **Make IC digital frequency comparators** with just a few flip-flops and gates.  
Here are three designs that yield phase and frequency relationships.
- 68 **Ladder networks are easy to design** for D/A and A/D converters by a method that involves the solution of only three simple algebraic equations.
- 74 **Synthesize resistor-thermistor networks** to match any desired voltage-ratio-vs-temperature characteristic. It's easy with the direct method.
- 80 **Diode model is analyzed by computer** as one junction of a transistor. Analysis covers both linear and nonlinear circuit operation.
- 86 **Mismatching for low noise** in amplifiers becomes simple with a nomograph that shows the lowest noise figure in one step.
- 89 Semiannual Index of Articles, January to June, 1967.
- 102 Ideas for Design
- 114 NASA Tech Briefs

---

## PRODUCTS

- 130 **Cover Feature:** Power circuits in a tiny cube handle 30 to 100 watts.
- 150 **Test Equipment:** Ac-to-dc converter widens dynamic and frequency ranges.
- 174 **Production Equipment:** Production-line IC tests—lightning strikes twice.
- 180 **Microelectronics:** Second-generation IC op-amp—compensation in 30 puffs.
- |                    |                |
|--------------------|----------------|
| 134 Components     | 168 Materials  |
| 146 Semiconductors | 186 Microwaves |

---

## Departments

- |                       |                         |
|-----------------------|-------------------------|
| 118 Book Reviews      | 198 New Literature      |
| 194 Design Aids       | 202 Advertisers' Index  |
| 196 Application Notes | 207 Designer's Datebook |

Growth of good basic design makes **hp** oscillators

## YOUR BEST CHOICE FOR A WIDE VARIETY

Hewlett-Packard Oscillators are the progressive growth of the first successful Wien-bridge oscillator design introduced to the measurement industry by Hewlett-Packard in 1939. Now you can select from a variety of fifteen hp instruments using improved components and the well-known Hewlett-Packard RC oscillator design to give you the best price-to-performance ratio on the market! Choose from frequency ranges of 1 Hz to 10 MHz.

**General Purpose Oscillators.**—The *hp Model 200CD* is a direct descendant of the first Wien-bridge design. With its low price, high power, balanced output and low distortion, the 200CD is an ideal instrument for school, communications and military use.

You get a fully-transistorized and battery-powered signal source with easily-portable *hp Model 204B*. Amplitude and frequency control circuits give excellent stability over a range of 5 Hz to 560 kHz. You also get a completely floating output, isolated from chassis and ground. The 204B is ideal for field use.

**Test Oscillators.**—The *hp Model 651B* Test Oscillator is an advanced design, wide-band, solid state test oscillator! This line-operated instrument gives you a wide frequency range of 10 Hz to 10 MHz with highly stable amplitude and frequency. There are separate 50 $\Omega$  and 600 $\Omega$  calibrated outputs. A 75 $\Omega$  output is optional.

Battery-powered *hp Model 208A* Test Oscillator is a compact, lightweight, easily-carried laboratory or field source of 5 Hz to 560 kHz signals.

**Pushbutton Digital Oscillator.**—For your production line or wherever you have repetitive testing, the *hp Model 241A* Oscillator gives positive pushbutton frequency selection from 10 Hz to 1 MHz. You get repeatable test signals with three-digit frequency resolution. Set 4500 discrete frequencies!

### A Pick *hp Model 200CD* Oscillator For A Low-Cost, General Purpose Instrument

— When you need a low distortion signal independent of load—you'll get excellent results with *hp Model 200CD* Oscillator! Use it for generating subsonic to radio frequencies; testing servo and vibration systems; supplying medical and geophysical equipment; for checking audio circuits and systems.

The output of the 200CD is 600 $\Omega$  balanced, with a balanced accuracy of 0.1 to 1%, depending on frequency. Accurate frequency settings over a range of 5 Hz to 600 kHz are possible with the 85 dial divisions, effective scale length of 78 inches, and a vernier drive for precise adjustment. Frequency response is  $\pm 1$  dB over the entire range.

Distortion rating of sinewave output is less than 0.2% below 200 kHz. The modified *hp Model H20-200CD* provides a low distortion of 0.06% in the 60 Hz to 50 kHz range.

For excellence in design in a general purpose oscillator, pick *hp Model 200CD*. Price is only \$225.00

### B Pick *hp Model 204B* Oscillator for Portable, Highly-Stable Signal Source

Solid-state, battery-powered *hp Model 204B* Oscillator is an excellent choice for a source of stable, accurate signals in the field. You have an unusually low

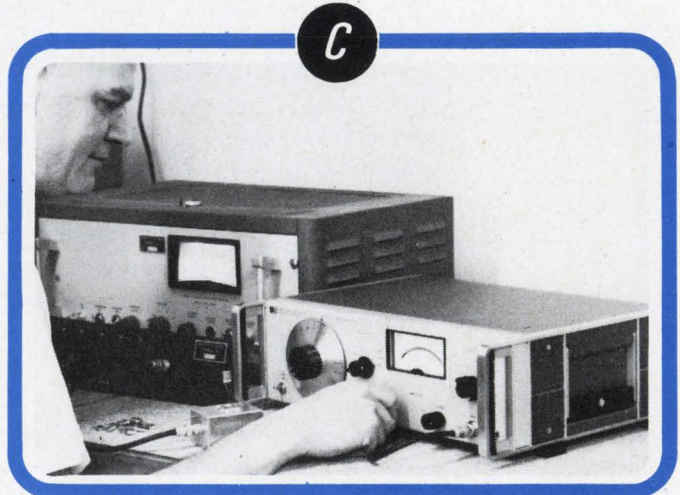
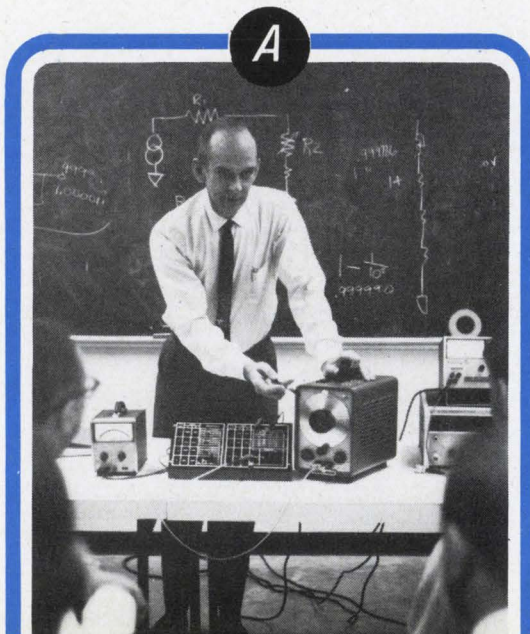
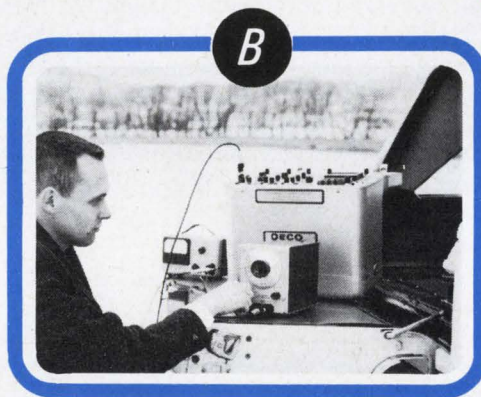

# OF LOW COST, SUPERIOR SIGNAL SOURCES

drift on warm-up; instantly available signals over a frequency range of 5 Hz to 560 kHz!

Stability is typically better than 5 parts in  $10^4$ —even at 560 kHz! Rapidly changing loads do not affect stability. Output is fully floating, flat within  $\pm 3\%$  at all settings of the dial and range switch.

Price of the hp Model 204B: Equipped with mercury batteries, \$315.00; with ac power supply in place of batteries (Option: 01), \$350.00; with rechargeable batteries and recharging circuit self-contained for ac or dc operation (Option: 02), \$390.00.

## C Pick hp Model 651B Test Oscillator for Accurate 10 MHz Frequency

**Range** — Outstanding flatness, stability and accuracy from 10 Hz to 10 MHz are yours with the hp Model 651B Test Oscillator. You get a typical  $\pm 0.1\%$  amplitude stability and  $\pm 0.02\%$  frequency stability, and a 1% accurate 90 dB output attenuator.

The 651B has two outputs: 200 mW into 50 $\Omega$ , and 16 mW into 600 $\Omega$ . Output attenuator has a 90 dB range in 10 dB steps, with a 20 dB coarse and fine amplitude controls for increased resolution in setting output voltage. Attenuator accuracy is  $\pm 0.1$  dB from  $-60$  dBm to  $+20$  dBm,  $\pm 0.2$  dB on  $-70$  dBm range. Output monitor is calibrated to read volts or dBm into a matched load. Price: hp Model 651B, \$590.00.

652A: The hp Model 652A is identical to 651A, with the additional ability to monitor output amplitudes within 0.25% over the entire frequency range of the instrument using the X20 expanded scale.

652A reads in percent for quick reading of frequency response measurements. Price: hp Model 652A, \$725.00.

208A: Add a meter for accurate setting of output voltage and an attenuator to the 204B, and you have the hp Model 208A Test Oscillator. Model 208A is calibrated in volts, covering 0.01 mV to 1 V full scale with a 2.5 multiplier to extend range to 2.5 V. Model 208A (Option: 01) is calibrated in dBm for 0 to 110 dB in 1-dB steps. Output is constant within  $\pm 3\%$  at all attenuator settings over 5 Hz to 560 kHz range. Price: hp Model 208A, \$525.00; hp Model 208A (Option: 01), \$535.00.

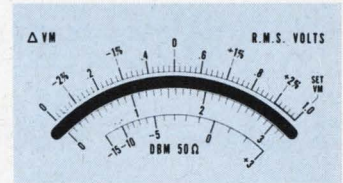

652A Expanded Scale Monitor

## D Pick hp Model 241A Oscillator for Pushbutton Repeatability

— Repeatability possible with the hp Model 241A digital oscillator makes it ideal for production line use—or in the laboratory where repetitive testing is a requirement. Set any frequency between 10 Hz and 999 kHz to three significant figures—simply by pushing buttons! This solid state instrument is designed with special hp precision resistors to provide typical frequency repeatability of 0.01%. Frequency accuracy is within  $\pm 1\%$  selected value on any range.

Infinite frequency resolution is provided by a vernier control, which also extends the upper frequency to 1 MHz. Output is flat within  $\pm 2\%$  over the entire range at any attenuator setting.

Use the 241A as a digital frequency source for filters and frequency sensitive circuits. Response test at audio and communication frequencies, or use it as a repeatable source in production testing. Price: hp Model 241A, \$490.00.

For full details on the wide variety of hp oscillators shown here and in our catalog, call your nearest hp field engineer. Or, write to Hewlett-Packard, Palo Alto, California 94304, Tel. (415) 326-7000; Europe: 54 Route des Acacias, Geneva.

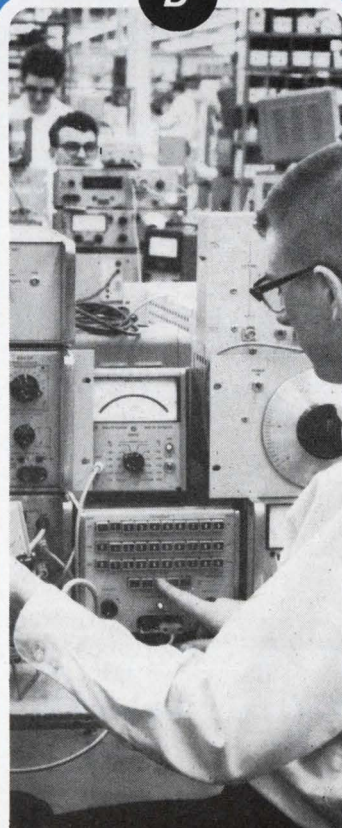

	200CD	204B	208A	651B	241A
Frequency	5 Hz to 600 kHz	5 Hz to 560 kHz	5 Hz to 560 kHz	10 Hz to 10 MHz	10 Hz to 1 MHz
Frequency Response (Rated load)	$\pm 1$ dB	$\pm 3\%$	$\pm 3\%$	$\pm 2\%$ to $\pm 4\%$	$\pm 2\%$
Accuracy	$\pm 2\%$	$\pm 3\%$	$\pm 3\%$	$\pm 2\%$ , $\pm 3\%$	$\pm 1\%$
Output	10 V, 160 mW/600 $\Omega$ , balanced	2.5 V, 10 mW/600 $\Omega$ , floating	10 mW, nominal 2.5 Vrms ( $+10$ dBm/600 $\Omega$ ), floating	3.16 V, 200 mW into 50 $\Omega$ , 16 mW into 600 $\Omega$ , floating	2.5 V, $+10$ to $-30$ dBm/600 $\Omega$ , floating
Distortion	0.2% to 0.5% (200CD) 0.06% to 0.5% (H20-200CD)	<1%	<1%	<1% to 2% MHz, 2% at 10 MHz	<1%
Price	200CD, \$225.00 H20-200CD, \$250.00	204B, \$315.00	208A, \$525.00	651B, \$590.00 652A, \$725.00	241A, \$490.00

ON READER-SERVICE CARD CIRCLE 4

097/10R

HEWLETT  PACKARD  
An extra measure of quality

# If You Want To Reduce Costs and Get Faster Delivery On Hi-Rel Silicon Transistors Take A Closer Look At MEG-A-LIFE II!



*-where the priceless ingredient is care!*

Investigate Motorola's tri-level assurance program, Meg-A-Life II<sup>†</sup>, as the practical approach to today's customized high-reliability transistor requirements:

Meg-A-Life II combines standardized processing with customized procedures . . . offering 28 types of silicon annular\* transistors, certified to any one of three reliability levels (Level 1, 2, & 3) — with the added flexibility of a full range of options to meet every special reliability requirement. (Meg-A-Life II is one of the most stringent standard hi-rel programs offered by any semiconductor manufacturer.)

Delivery time is faster because preliminary 100% processing tests, including life testing, are standardized and performed ahead of time. You select the suitable reliability level. Then, if you need additional tests and screens, they are performed after receipt of your order. Costs are cut because the time and expense of writing and negotiating custom specifications is eliminated . . . plus the cost of acceptance testing is prorated over the entire lot of Meg-A-Life II devices.

## TAKE YOUR CHOICE . . . THREE LEVELS OF MEG-A-LIFE II TRANSISTOR RELIABILITY ASSURANCE

**LEVEL 1** 100% reliability processing; Group A Electrical Inspection to military acceptance tests or equivalent; certified reliability data from latest lot of continuous production having completed Group B inspection (military tests or equivalent).

**LEVEL 2** Same as Level 1, plus 100% 96-hour burn-in and screening.

**LEVEL 3** Same as Level 2, except Group B inspection data for actual lot from which devices are shipped.

. . . plus Meg-A-Life options, including radiographic inspection, hermetic seal, temperature cycling, thermal shock, and shock.

## ORDER BROCHURE

Learn more about the modern reliability assurance program — Meg-A-Life II — ideal for both the smaller reliability order — or as the starting point for custom-tailored, more complex, reliability programs. Request the 6-page folder by writing Motorola Semiconductor Products Inc., Box 955, Phoenix, Arizona 85001.

<sup>†</sup>Trademark of Motorola Inc.

\*Annular semiconductors are patented by Motorola Inc.



**MOTOROLA**  
**Semiconductors**



# Use Algebra?

$$V_{INST} = V_{DC} (1 - e^{-Rt/L})$$

$$\omega = \frac{1}{\sqrt{LC}}$$

$$R_E = \frac{R_1 R_2}{R_1 + R_2}$$

# Use FORTRAN.

$$V_{INST} = V_{DC} * (1 - \text{EXP}(-R * T / L))$$

$$\text{OMEGA} = 1 / \text{SQRT}(L * C)$$

$$R_E = R_1 * R_2 / (R_1 + R_2)$$

That's because FORTRAN lets you communicate with the computer in your everyday language. Algebra.

For example, the algebraic step response equation above is practically written in FORTRAN already. To solve the problem you state:  $V_{INST} = V_{DC} * (1 - \text{EXP}(-R * T / L))$ . Then just enter the data. The computer does the rest. Leaving you with more time for engineering. Engineering the way you've always wanted it to be. With more freedom of design and more confidence in meeting deadlines.

FORTRAN is a powerful problem solver. But all FORTRAN is not alike. IBM FORTRAN gives you more. It extends the capabilities of FORTRAN with the Scientific Subroutine Package containing over one-hundred FORTRAN subroutines in statistics, matrix manipulation and general mathematics.

With your knowledge of algebra you don't have to spend much time learning FORTRAN. You're qualified. For special problems, IBM has other FORTRAN-based programs such as Electronic Circuit Analysis Program, Continuous System Modeling Program and the Project Control System. You can master them all quickly. We'll show you how. Send us this coupon.

IBM Data Processing Division, Dept. 805-202  
112 East Post Road  
White Plains, N. Y. 10601

Send me information on:

- FORTRAN
- Scientific Subroutine Package for System/360
- Scientific Subroutine Package for 1130 Computing System
- Computers in Electrical Engineering

Name \_\_\_\_\_

Position \_\_\_\_\_

Company \_\_\_\_\_

Division \_\_\_\_\_

Address \_\_\_\_\_

City \_\_\_\_\_ Zip Code \_\_\_\_\_

State \_\_\_\_\_

**IBM**<sup>®</sup>

ON READER-SERVICE CARD CIRCLE 6

# DESIGNER'S

P. R. MALLORY & CO. INC., INDIANAPOLIS, INDIANA 46206

## Rectangular case molded tantalum capacitor takes minimum space on circuit boards

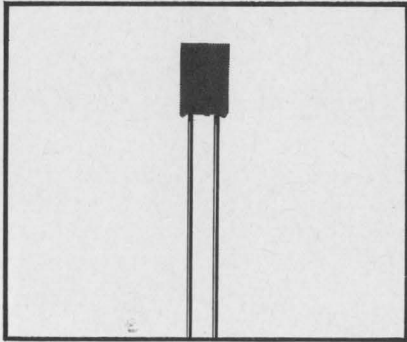

The new TIM miniature solid tantalum capacitor comes in a fully molded epoxy case in rectangular configuration which affords maximum efficiency of space utilization on printed circuit boards. The single standard case size measures .345" by .288" by .105" thick. Stand-off ribs are molded into the base to permit ease in soldering in printed circuits. Parallel leads are spaced .125" apart, fitting the newer

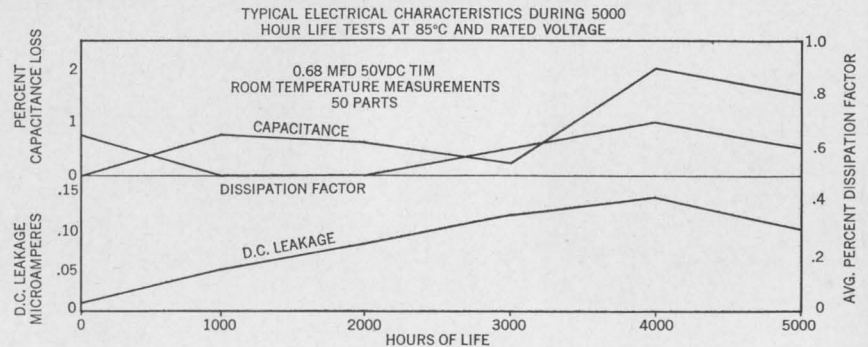

printed circuit designs. The small, uniformly sized case is well suited for automatic insertion.

This new capacitor meets exceptionally high standards of performance and reliability. Tests of 5000 hours, both for high temperature life and humid life, demonstrate the TIM's excellent stability of capacitance, DC leakage and dissipation factor . . . all of which

stayed well within specification limits.

Standard ratings extend from 12 mfd, 3 WVDC to .68 mfd, 50 WVDC. Standard capacity tolerances are  $\pm 20\%$  and  $\pm 10\%$ . The TIM is now in high volume production at attractive price.

CIRCLE 105 ON READER SERVICE CARD

## Special control and switch for "instant-on" color TV

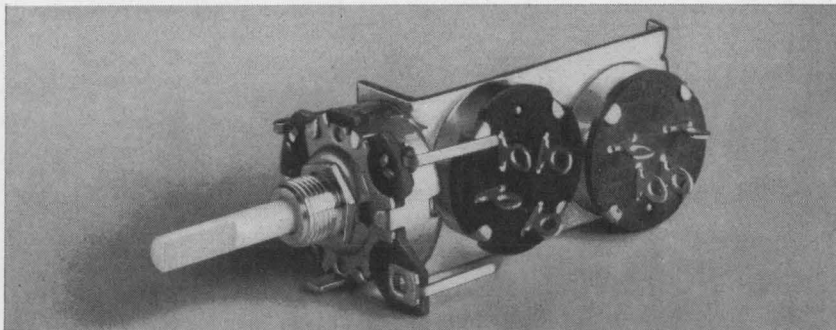

This "instant-on" control and switch for color TV demonstrates Mallory's ability to engineer and produce special assemblies to meet the requirements for specific applications in a variety of electrical and electronic products.

The assembly has two side-mounted DPST switches. In the "off" position, reduced voltage is applied to heaters, and pilot light and B+ voltages are cut off. In the "on" position, normal voltages are ap-

plied to all circuits. Switch action is push-pull.

Both switches are the Mallory type OAC, with proved long life and reliability. Switch ratings can be any desired combination of 2, 3, 5, or 6 amperes, 125 volts AC. This configuration can be supplied attached to any Mallory single or dual carbon control. We welcome inquiries for special assemblies, on your company letterhead.

## Extreme high and low values available in Mallory controls

Need a 100-megohm carbon control? Or a 50-ohm? You can get them from Mallory. And practically any value in between. All of them have the unique hard-surface Mallory element that consistently gives 100,000 cycles of rotational life. A broad range of standard and special designs can be supplied promptly.

CIRCLE 106 ON READER SERVICE CARD

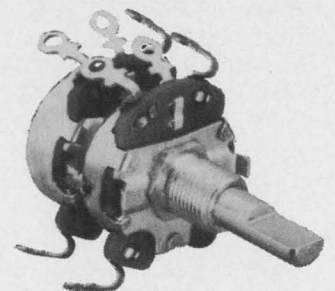

## The Rechargeable Batteries You Can Afford



New Duracell® rechargeable alkaline batteries. These are the batteries that will make a new generation of battery-operated devices possible. Because this battery now exists, portable TV sets, radios, phonographs, tape recorders and transceivers can be designed to function at lower operating costs.

The low initial cost of the rechargeable alkaline batteries is one reason why they promise so much for new designs. Another reason is their unique exposed band contact. It lets you design battery-operated equipment with built-in rechargers that automatically prevent charging when a primary cell is in the circuit. (See schematic.) This means that, when necessary, any primary battery can provide the power.

But that's not all. Duracell alkaline rechargeable batteries are lighter than most rechargeables. They come fully charged. They're available in 3 standard sizes, "D", "C" and "AA". And one glance at the discharge-cycles graph will tell you how little they cost to operate.

®Registered trademark of P. R. Mallory & Co. Inc.

**CIRCLE 108 ON READER SERVICE CARD**

### New molded-case miniature solid tantalum capacitors

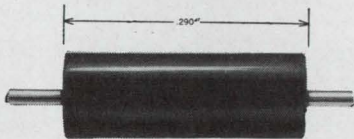

New Type TAC solid electrolyte tantalum capacitors give you, in molded case construction, nearly twice the CV ratings per cubic inch that you can get in MIL-C-26655 metal case solids. They have a fully molded epoxy case only 0.105" in diameter by 0.29" long, precisely molded to facilitate automatic insertion.

Extended life and humidity tests indicate performance of the TAC is exceptionally high. You can use them with confidence anywhere you need a solid tantalum capacitor, including MIL specification environments.

Standard temperature rating is -55°C to +85°C; can go to +125°C with voltage de-rating of 33%. Values range from 18 mfd., 3 WVDC to .47 mfd., 50 WVDC.

**CIRCLE 107 ON READER SERVICE CARD**

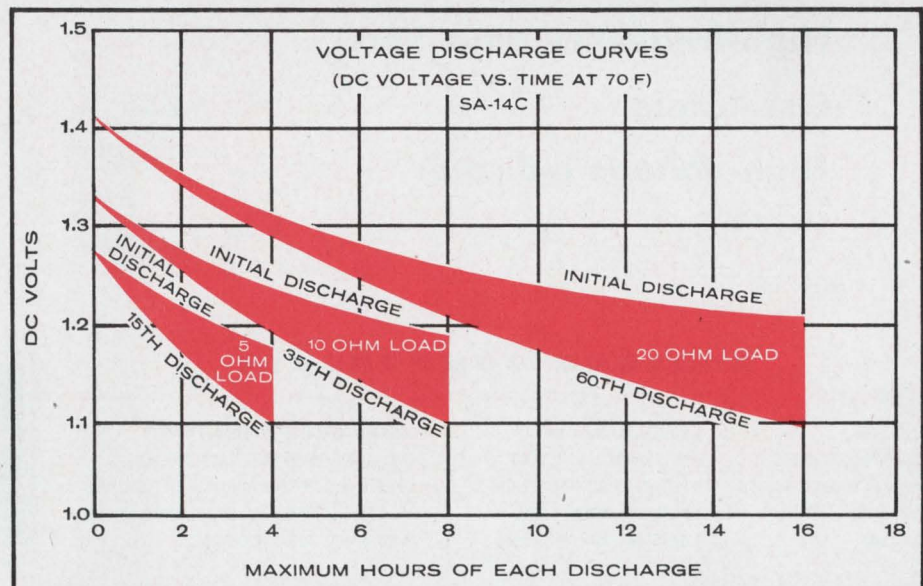
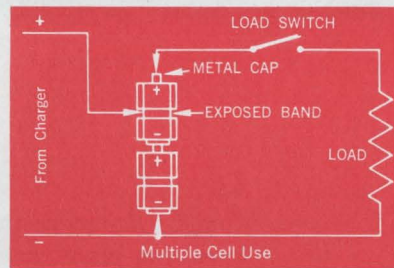

**Now from Sprague!**

# ECONOLINE<sup>\*</sup> SILICON PLANAR PLASTIC TRANSISTORS

can save you **30 to 40%**  
over metal-encased types

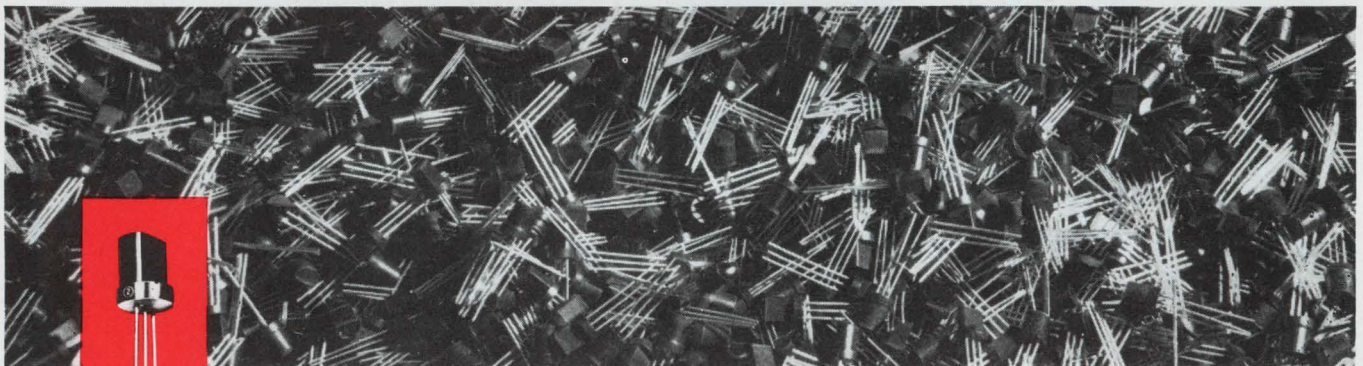

**56 POPULAR N-P-N TYPES IN VOLUME PRODUCTION  
FOR OFF-THE-SHELF DELIVERY**

- Small-signal amplifiers
- Medium-speed switches
- Large-signal amplifiers
- High-frequency amplifiers
- Oscillators
- High-voltage indicator drivers

Sprague Econoline transistors . . . quality planar devices in plastic packages. You save the cost of metal cans. And with dual source back-up, too. For further information and prices call your local Sprague office today.



**For comprehensive specifications write for catalog CN200 A to:**

**Technical Literature Service  
Sprague Electric Company  
347 Marshall Street  
North Adams, Mass. 01247**

\*trademark

## SPRAGUE COMPONENTS

TRANSISTORS  
INTEGRATED CIRCUITS  
THIN-FILM MICROCIRCUITS  
CAPACITORS  
RESISTORS

PULSE TRANSFORMERS  
INTERFERENCE FILTERS  
PULSE-FORMING NETWORKS  
TOROIDAL INDUCTORS  
ELECTRIC WAVE FILTERS

CERAMIC-BASE PRINTED NETWORKS  
PACKAGED COMPONENT ASSEMBLIES  
BOBBIN and TAPE WOUND MAGNETIC CORES  
SILICON RECTIFIER GATE CONTROLS  
FUNCTIONAL DIGITAL CIRCUITS

**SPRAGUE<sup>®</sup>**  
THE MARK OF RELIABILITY

'Sprague' and '®' are registered trademarks of the Sprague Electric Co.

# News

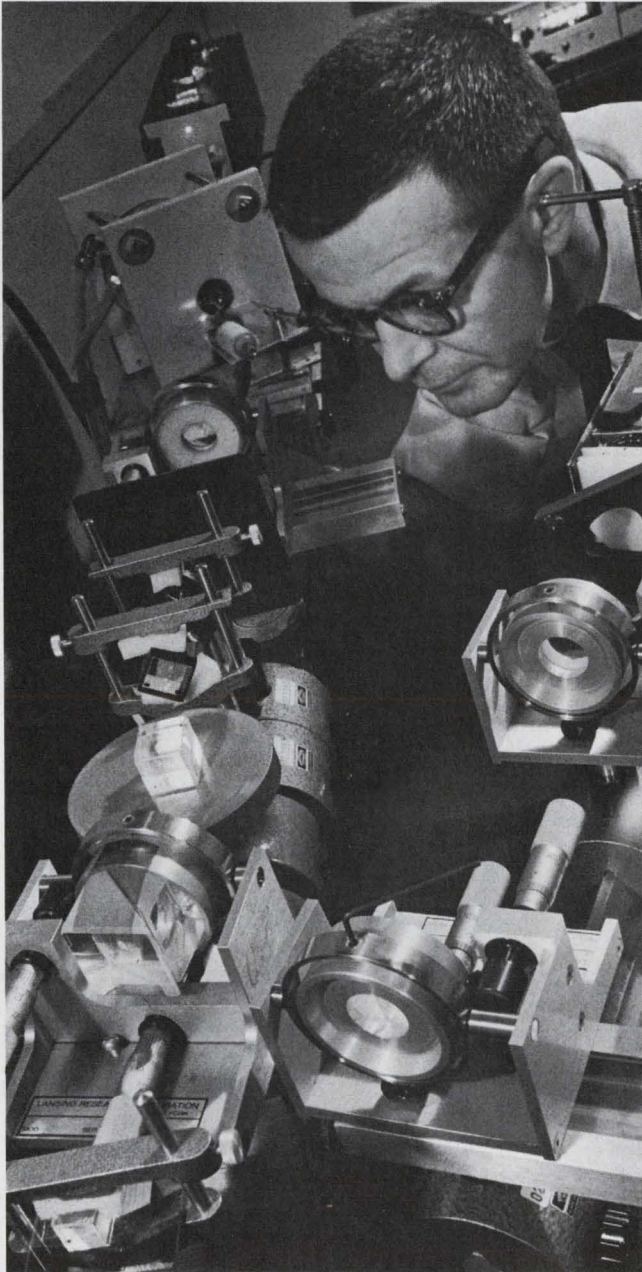

**Subnanosecond laser pulses** may advance art of optical ranging and computation. Page 17

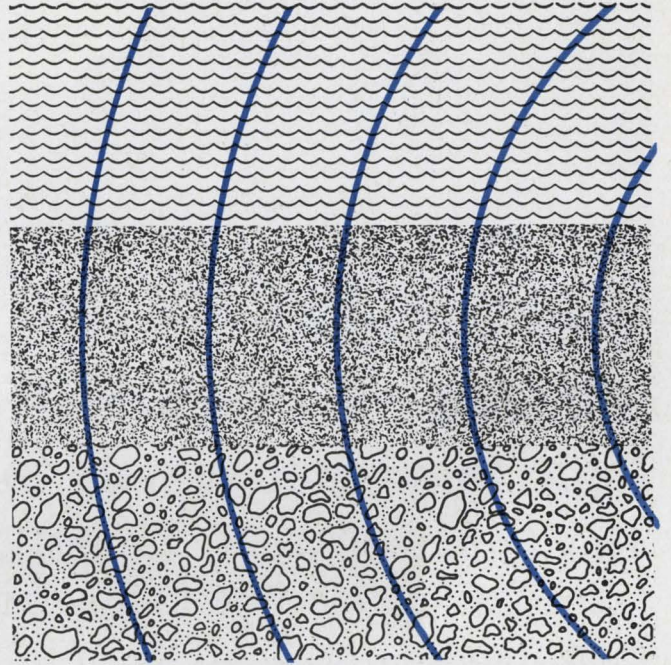

**Army studies use of soil, water, rails and skin** for transmitting wartime messages. Page 22



**Low-cost graphic display being tested** for use with computer time-sharing 'utilities.' Page 36

## Also in this section:

**'Flame laser'** uses burning CO to excite CO<sub>2</sub> in a sealed tube. Page 26

**IR light emitted from two lasers in a cane** helps the blind to 'see.' Page 44

**Rainfall data may guide the siting** of microwave facilities. Page 48

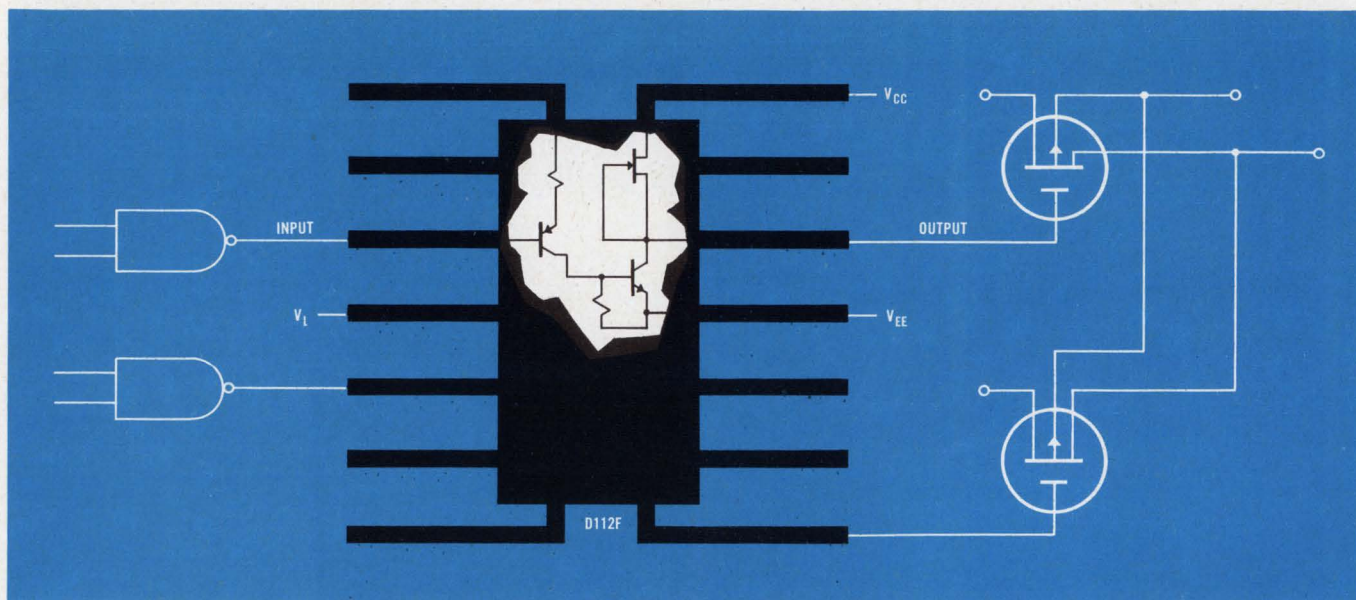

## Siliconix FET-Switch DRIVERS...amplify low-level logic to 30-volt signals for controlling FET Switches.

This family of six IC Buffer/Drivers provides flexible interfacing between logic circuits and MOS or junction FET Switches. Each Driver flatpack contains two independent circuits that deliver 30-volt output swings from input signals as low as 0.5 volt. Output levels may be preset to obtain

PERFORMANCE SUMMARY				
Type No.	Typ. Input Switching Threshold Voltage	Max. Input Drive Current Required	Max. Output Current	Inverting Function
D111F	0.8 Volt	0.1 mA	1.8 mA	YES
D112F	3.0	1.5	1.8	NO
D113F	0.8	1.0	1.8	YES
D119F	0.8	0.1	5.7	YES
D120F	3.0	1.5	5.7	NO
D121F	0.8	1.0	5.7	YES

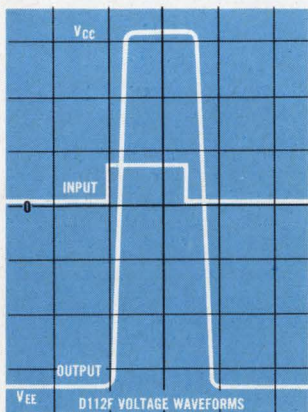

dc level shifting. Both inverting and non-inverting Drivers are available, which allows either N- or P-channel FET switches to be used & Siliconix also makes six-channel FET-Switch Drivers, a line of discrete and integrated (MOS or junction) FET-Switches, and Driver/FET-Switch combinations.

**FREE:** Applications, specifications, and prices on Siliconix FET-Switch Drivers ... mark inquiry card ... write ... or call (408) 245-1000.



**ALABAMA** Perrott Assoc., Inc. Huntsville (205) 837-2290  
**ARIZONA** Barnhill Associates Phoenix (602) 959-2115 Sterling Electronics, Inc. Phoenix (602) 258-4531  
**CALIF.** Hollywood Radio & Elec. Hollywood (213) 466-3181 Menlo Park (415) 322-3431 Kierulff Electronics, Inc. Los Angeles (213) 685-5511 San Diego (714) 278-2112 Elmar Electronics, Inc. Mountain View (415) 961-3611 Oakland (415) 834-3311 Electronics Supply, Inc. Riverside (714) 683-8110

**COLORADO** Barnhill Associates Denver (303) 934-5505  
**CONNECTICUT** Cramer Elec., Inc. Hamden (203) 288-7771  
**FLORIDA** Perrott Associates, Inc. Clearwater (813) 446-2535 Orlando (305) 275-1132 W. Palm Beach (305) 585-7761  
**ILLINOIS** Semiconductor Spec. Chicago (312) 279-1000  
**MARYLAND** Milgray Elec., Inc. Hyattsville (202) 864-6330  
**MASS.** Cramer Electronics, Inc. Newton (617) 969-7700  
**MINN.** Semiconductor Spec. Minneapolis (612) 866-3434  
**MISSOURI** Semiconductor Spec. St. Louis (314) 521-8866

**NEW JERSEY** Tech. Elec. Dist. Bergenfield (201) 384-3643  
**NEW MEXICO** Barnhill Assoc. Albuquerque (505) 265-7766 Sterling Electronics, Inc. Albuquerque (505) 247-2486  
**NEW YORK** Summit Dist., Inc. Buffalo (716) 884-3450 Milgray Electronics, Inc.

New York City (212) 989-1600 East. Semiconductor Sales Syracuse (315) 455-6641  
**OHIO** Alpine Industries, Inc. Dayton (513) 278-5861  
**OKLA.** Oil Capitol Elec. Corp. Tulsa (918) 836-2541  
**PENNSYLVANIA** Simco Elec., Inc. Philadelphia (215) 229-1880

**TEXAS** Sterling Electronics Austin (512) 452-0271 Dallas (214) 357-9131 Houston (713) 225-1321 Lenert Company Houston (713) 225-1465  
**WASHINGTON** Washington Elec. Seattle (206) 682-8981



**Siliconix incorporated**

1140 West Evelyn Avenue, Sunnyvale, California 94086  
 Telephone (408) 245-1000 TWX: 910-339-9216

ON READER-SERVICE CARD CIRCLE 8

## Telephone networks claimed ready for future computers

The telephone and telegraph companies are ready and able to meet the growing demands for computer data transmission, according to a senior scientist of Bell Telephone Laboratories, Inc. Dr. John Pierce told a recent IEEE conference on communications in Minneapolis that the Bell System "is working hard to meet the varying and growing needs for digital transmission with the extensive communication network now in existence."

His comments followed in the wake of some impatience expressed in industry at the slowness of the common carriers in responding to the needs of computer-data transmission.

Dr. Pierce, an executive director at Bell's Murray Hill, N. J., facility, said the use of the existing network "is certainly more flexible, faster and cheaper than trying to build a separate network which could be extensive enough to serve the small user and the large user alike."

Among current Bell projects that would benefit the computer industry, Dr. Pierce listed:

- Switched networks capable of handling 3600 bits per second.
- Private voice-grade lines capable of 7200 bits per second.
- Common-user, 50-kilobit switched network service.
- The conversion of analog telephone channels to digital channels able to carry ten times as much traffic as analog.

He reported that, though the leased line is cheaper, the switched telephone network is the most flexible form of common carrier. It is already in operation and is capable of "far greater than teletypewriter speed," he said. Data-Phone sets can now send 2000 bits per second, but in the near future will offer 3600 b/s, Dr. Pierce stated.

For regular service over specific

routes, he said, private-line circuits now offer a 150-bit channel for devices that operate up to 150 words a minute. Private-line, voice-grade facilities, however, can handle bit rates in the 2000 to 2400 range and are capable of expansion to 7200 or more b/s, Dr. Pierce noted.

Bell is now working on a common-user 50-kilobit switched network to communicate between computers or terminal devices and a computer. This, according to the scientist, would have a capability 12 times greater than that of a voice-grade line. He believes this will meet present commercial requirements, but conceded that it may not match future government needs.

Discussing the economic aspects of transmission, he stressed: "The more one can send over one transmission system, the cheaper a given amount of transmission will be."

He looked to new coaxial systems, terrestrial radio networks and huge microwave satellite communications links as immediate goals. Further in the future, Dr. Pierce foresaw transmission of communications by coherent laser light through buried tubes.

He also predicted that future telephone transmission will be mostly digital. Bell, he said, would soon cover the entire state of Massachusetts with its T1 transmission systems. These can send 1.5 million binary pulses per second for distances up to 50 miles.

## Mariner V spacecraft on course for Venus

The 540-pound Mariner spacecraft launched earlier this month is "functioning beautifully" and is expected to rendezvous with Venus on October 19, according to a NASA spokesman.

Mariner V is now predicted to

come within about 2500 miles of the planet on October 19, about seven times closer than Mariner II in December, 1962. The spacecraft's looping flight to Venus will cover nearly 217 million miles.

Mariner is trailing the Soviet Union's 2500-pound spacecraft, Venus 4, launched a couple of days earlier than Mariner. Experts believe that the Soviet spacecraft may be scheduled to reach Venus on Oct. 4, the tenth anniversary of the launching of Sputnik 1, or on Nov. 7, the fiftieth anniversary of the Bolshevik revolution. Others speculate that the Soviet craft will eject a landing capsule containing experimental devices. All the Soviet scientists said was that the spacecraft carries ultraviolet and infrared measuring instruments and will fly by the planet.

Experiments to be performed by Mariner V include investigations of the interplanetary magnetic field, the solar wind, charged particle fluxes, solar X rays and the abundance of electrons and hydrogen ions in space. When the spacecraft encounters Venus, additional experiments will investigate the concentration of hydrogen and oxygen in the planet's exosphere, the electron concentration in its ionosphere, the density of its atmosphere at various levels and the diameter and mass of the planet.

Of greatest interest to NASA scientists is the S-band occultation

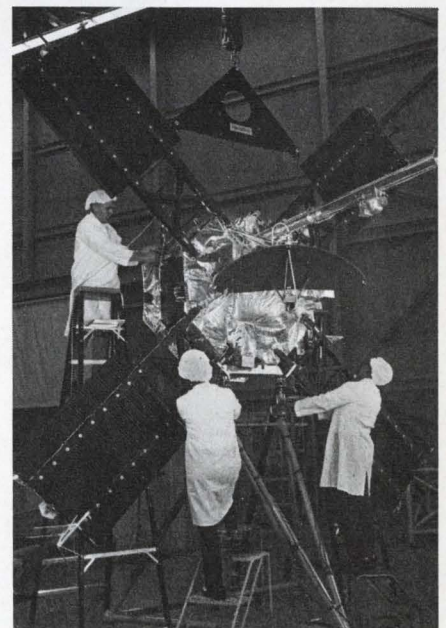

Mariner V gets final checkup by NASA scientists before launch.

experiment, which aims to determine the density of the Venusian atmosphere.

This experiment is similar to that carried by the Mariner IV spacecraft. If it is successful, information gathered may be applied to the design of future Voyager missions to Mars and possibly Venus in the 1970s.

## Sony shows 7-in. color TV with chromatron tube

A seven-inch portable color television set, which will incorporate the first commercial use of a chromatron picture tube in the U.S., will be marketed early next year by Sony Corp. of America.

The receiver is 8 inches wide, 10 inches high and 13 inches deep. It weighs 18 pounds, operates on ac or with nickel-cadmium batteries and consumes less than 45 watts ac or 35 watts dc.

In the early days of television, the chromatron single-gun tube was in competition with today's three-gun color tubes as the industry standard, but it lost out because of production and financing problems. The chromatron tube, developed by Nobel prize-winner Ernest O. Lawrence, uses a grid of parallel wires rather than a shadow mask of tiny holes as in today's sets.

A company spokesman said that all production problems had been solved. Company engineers asserted that the chromatron system was about 85% efficient at emitting the color signal within the tube as opposed to about 15% to 18% in the three-gun tube.

## Communication Satellite is planned in Europe

Cosat may be a highly useful communications link to many countries, but France views the satellite system as a U.S. tool.

Then why not develop her own communications satellite? France might like to, but it would cost too much.

The upshot has been a compromise arrangement: France and

West Germany have formed a partnership to develop and launch a joint communications satellite. Called Symphonie, it is to be shot into space in late 1970.

A Europa H rocket and a launching station under construction in French Guiana are to be used. The satellite's period of rotation is due to coincide with the earth's, to keep Symphonie in synchronous orbit over the equator.

In that position, the satellite will be able to beam radio, TV, telephone and telegraph messages within Europe and between Europe and Africa, the Middle East and the eastern parts of North and South America. The West Coast will be out of range.

The cost of the project has been estimated unofficially at slightly more than \$40 million, to be shared equally by France and West Germany.

Other countries have been invited to join the system. And one objective seems clear: Symphonie will enhance the European bargaining position when Comsat renegotiates its rights abroad in 1969.

## RCA expands in Italy as color TV grows

A boom in color television is expected to start in Europe this year, and the Radio Corp. of America is moving to share in it. The company has announced the formation of RCA Colore S.p.A. in Italy to manufacture and sell color-TV tubes to the member nations of the European Common Market.

The new enterprise is RCA's second expansion in Europe in the last year. Last August it announced plans to manufacture color tubes in Britain.

Several European countries are expected to begin color telecasts before the end of this year. They will include West Germany, the United Kingdom, France, Spain and the Netherlands.

RCA's president, Robert W. Sar-noff, forecasts that sales of color-TV sets will reach 300,000 by next year, nearly a million by 1970 and about 3.5 million by 1975.

"RCA's expansion program," he says, "is based on our belief that color television will develop in Europe along the same lines as in the United States."

## Amateur radio producers group to merge with EIA

The Amateur Radio Industry Association, whose members represent firms producing about 90% of the nation's ham equipment, voted to merge with the Electronic Industries' Association.

The ARIA steering committee, comprising some 20 manufacturers of amateur gear, took the preliminary steps at a recent meeting with the representatives of the EIA.

As EIA members, the ARIA firms will be eligible to participate in activities of EIA Marketing Services, Engineering, International and Industrial Relationships departments.

## New thesaurus to list 23,000 technical terms

A standard thesaurus of engineering and scientific terms used by the military, industry and the academic world will be published in September by the Dept. of Defense in conjunction with the Engineers' Joint Council.

The 1000-page volume, called *Thesaurus of Engineering and Scientific Terms*, will list more than 23,000 main terms, with generic relationships, cross-references and indexes. The new volume is intended to replace the *Thesaurus of Engineering Terms* issued by the Engineers' Joint Council in 1964.

Copies of the new volume can be ordered from the Engineers' Joint Council, 345 East 47 St., New York, N. Y. 10017. The price is \$19.50 for a soft-cover version and \$25 for the hard-cover. A magnetic-tape version with programs for computer manipulation will also be available.

## Patent Office planning new abstract journal

A new abstract journal planned by the U.S. Patent Office will give scientists and engineers a fast review of the technical content of all patents. A prototype issue of the journal will be published around Oct. 1.

Commissioner of Patents, Edward J. Brenner, invited anyone who was interested to write for a copy "and give us the benefit of your appraisal of its usefulness and suggestions for its improvement."



RCA  
integrated  
circuits

# RCA CA3020 LOW COST "UNIVERSAL" AMPLIFIER

- High gain • Low level to  $P_{out} = 1/2 w$
- DC to 6MHz • Price \$1.75 (1,000+)

Here's a new answer to economics, packaging, and performance for a broad spectrum of audio and RF applications—RCA-CA3020, a multi-stage, multi-purpose amplifier on a single monolithic silicon pellet. CA3020 is useful in portable and stationary sound systems; in military, industrial, and commer-

cial communications equipment; in servo-control systems and elsewhere. Available now for evaluation—and production line use. Write for Technical Bulletin and Application Note to Commercial Engineering, Sec. ICG7-1, RCA Electronic Components and Devices, Harrison, New Jersey 07029.

#### Specification Highlights

- 58 db typical gain in audio applications
- -3 db bandwidth 25 Hz to 6 MHz (typ)
- Operates with single power supply +3 to +9 VDC
- Built-in temperature tracking with voltage regulator—stabilized operation over -55°C to +125°C range
- Single-ended input at 40kΩ (typ); push-pull differential input at 600Ω (typ)
- High maximum power output 550 mW (typ) @  $V_{cc} = +9V$
- Push-pull output
- Squelch flexibility—three methods for applying squelch

ASK YOUR RCA DISTRIBUTOR FOR HIS PRICE AND DELIVERY

RCA Electronic Components and Devices



The Most Trusted Name in Electronics

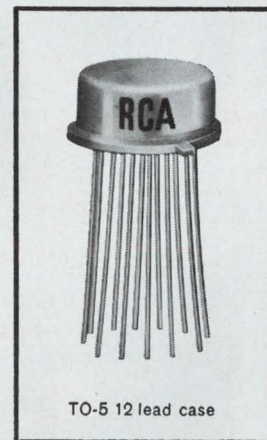
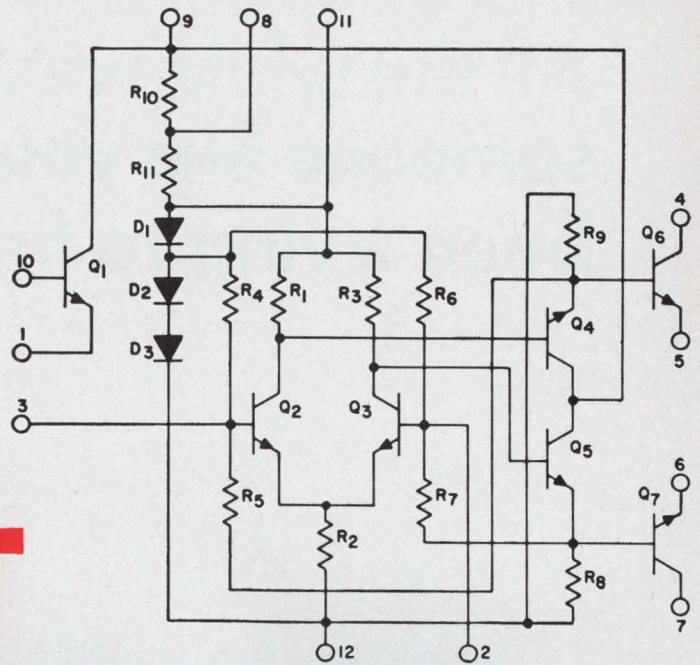

# All the while we've been looking for someone like you, you may have been trying to find someone like us.

As an Industrial Electronics Engineer, you may have been looking for a component standardization program that makes things easier for you.

You may have been looking for a line of capacitors and relays with the quality only long production process specification controls makes possible.

You may have been looking for a way to get your components within 48 hours of the time your order is received. If that's what you've been looking for, this coupon is all it takes to find it.

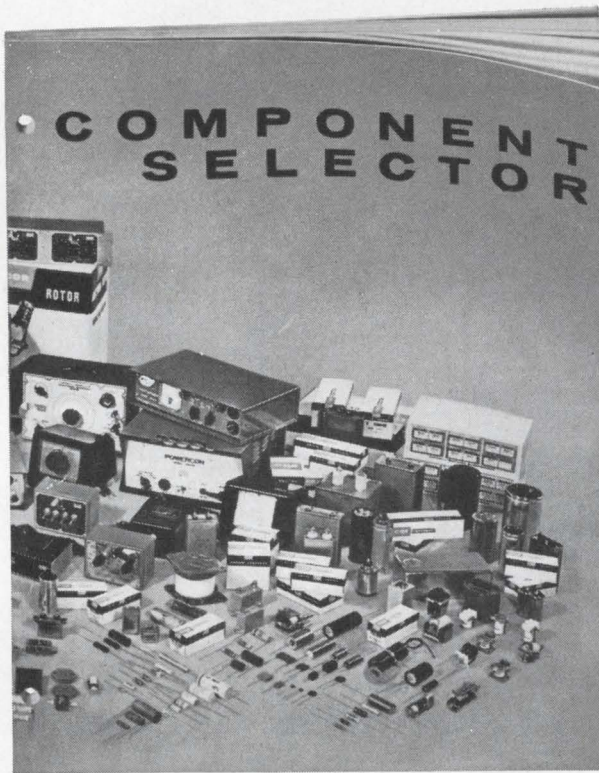

**CDE** **CORNELL-DUBILIER**

50 Paris Street, Newark, New Jersey 07101

Now that you've found me, please send me your new Component Selector so I can use a service like the one you've just described.

Name \_\_\_\_\_

Company \_\_\_\_\_ Title \_\_\_\_\_

Address \_\_\_\_\_

City \_\_\_\_\_

State \_\_\_\_\_ Zip \_\_\_\_\_

ED

# Picosecond light pulses go begging

## Electronic applications of ultrashort laser bursts await design of faster detectors and oscilloscopes

Richard N. Einhorn  
News Editor

Laser systems capable of generating optical pulses less than 1 picosecond wide—the shortest events ever produced by man—may usher in a new era of technology in which electrical and physical measurements are improved by orders of magnitude. They may well provide resolution for optical radar and range-finding down to 0.03 cm over a distance of miles. They may even make possible computer elements with dump rates approaching  $10^{12}$  bits per second and binary logic in time sequences on the order of  $10^{-12}$  seconds.

Sheer conjecture? Hardly. Pulses almost this brief are being generated in many U.S. laboratories and also, it is reported, in the Soviet Union. One group at United Aircraft Research Laboratories, East Hartford, Conn., has measured 4-ps pulses directly using an optical correlation technique. A lower limit of  $10^{-13}$  seconds for pulse generation has been predicted—equal in length to only 30 optical cycles. The U.S. Army Research Office is said to be so interested in the subject that it is planning a conference devoted to the theory and application of ultrashort pulses.

Dr. Charles H. Townes, who shared in the 1964 Nobel prize for physics for his role in pioneering the maser, commented recently on these innovations:

"In the long run, I think, short optical pulses will be very useful for optical memories, for coding and for communications. But it will require a long process of engineering development before we have other devices that will respond electrically to such short pulses.

"If devices that detect or utilize them are slow, then we can't take full advantage of them. However, now that we have these very short pulses, perhaps the other devices can be made better or faster."

This discrepancy in speed between

state-of-the-art optical and electrical devices was illustrated by Anthony J. DeMaria, principal scientist, quantum physics, at United Aircraft:

"We put pulses of 1 to 10 picoseconds into special photodiode detectors. Coming out of the diodes are electrical pulses of the order of 90 ps at the half intensity point, with amplitudes of 60 volts, occurring, say, every 1 or 2 ns.

"When the output of our detectors is fed to a standard 1-GHz traveling-wave oscilloscope (Tektronix 519), we cause the scope to ring. Our pulses are even faster than a specially modified 519, which is said by the manufacturer to have a rise-time of 135 ps and a frequency response of 3 GHz."

Thus, generation of ultra-short pulses is pushing the technological limits of both photodetectors and traveling-wave oscilloscopes.

Generating these ultrashort pulses requires special equipment. Bell Telephone Laboratories uses  $\text{CO}_2$  lasers in its experiments. Soviet scientists seem to favor semiconductor lasers at present, and have reported measuring down to  $10^{-11}$  seconds.

### Q-switching improved

Up to now, the narrowest pulse widths obtainable with standard Q-switching techniques have been lim-

ited to approximately 10 nanoseconds because of the requirement for one or more passes through the active medium in order to build up the laser pulse. DeMaria<sup>1</sup> describes United Aircraft's technique for overcoming these problems.

His source is a Q-switched  $\text{Nd}^{+3}$  doped glass laser. DeMaria claims that with a 16.5-cm-long oscillator and a 1-meter-long glass rod as an optical amplifier, his group has obtained peak powers of 3.7 and  $9.4 \times 10^{10}$  watts for durations of 20 and 8 ps, respectively—to the best of his knowledge the highest peak power so far reported by any laboratory.

A cell containing a saturable organic dye solution is placed inside the laser cavity (see Fig. 1). A Kerr cell and a polarizer (Glan prism) are also placed in the cavity. The Kerr cell is initially unenergized and the polarizer is adjusted for maximum transmission.

The Kerr cell is filled with a transparent material, which, when placed in a strong electric field, refracts doubly, and acts as a fast shutter for light beams. The dye cell is in effect a Q-switch as well as a passive amplitude modulator. As the pulse propagates through the dye cell, the leading edge is heavily absorbed and atoms jump from the ground state of a two-level quantum system to the excited state. As a result, the dye tends to saturate. This means that it attenuates high-amplitude portions of the pulse far less than the low-energy por-

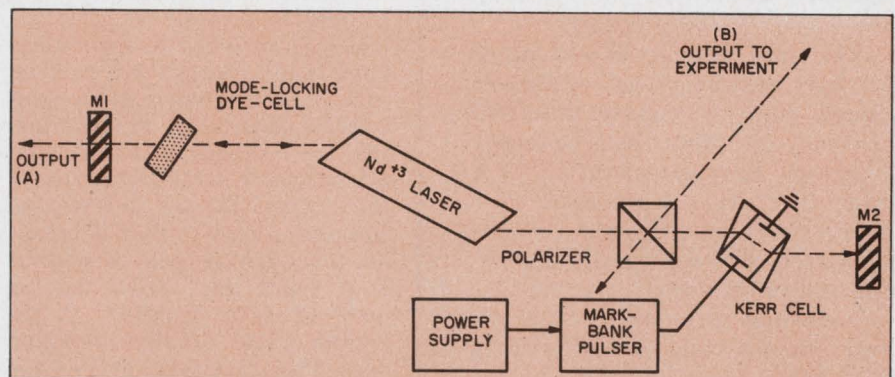

1. Subnanosecond pulses generated by laser oscillator are shaped by dye cell which attenuates low-amplitude portions more than it does high-amplitude portions. Saturable organic dye acts both as modulator and as Q-switch.

**(ps pulses, continued)**

tions. Then the passive modulator opens.

After the pulse has propagated through the system, the atoms return to the lower energy state, and the modulator closes. Reflecting the pulse back and forth between the two laser mirrors, *M1* and *M2*, continually sharpens the pulse until the harmonic content equals the over-all band-width of the system. Once this occurs, the pulse has reached its limit of narrowness.

The cell, then, phase-locks harmonically related longitudinal modes, oscillating in the laser cavity, to produce a train of optical pulses of a width limited only by the bandwidth of the phase-locked amplifying system. This approach is known as mode-locking. The dye solution in the laser cavity automatically adjusts its modulating frequency to the round-trip transit time,  $\tau$ , of pulses bouncing back and forth between the laser's mirrors. Such modulation requires that the relaxation time of the absorber be shorter than  $\tau$ . In addition, it must have an absorption line at the laser wavelength and it must have a line width equal to or broader than the laser line width.

**Laser pulses spark gaps**

The leakage radiation from the polarizer is focused onto the first gap of a Marx-Bank pulse generator (see box). When all the gaps break down, a fast-rise-time quarter-wave voltage pulse is applied across the Kerr cell. With the Kerr cell energized, the polarization of the pulse is rotated 45° for each pass. The pulse is eventually routed from the cavity by the polarizer.

The glass Nd laser is well suited to the generation of ultrashort pulses. It has a spectral line that consists of three homogeneously broadened lines approximately 40 Å wide that are superimposed in a staggered fashion to yield a nonhomogeneously broadened line approximately 100 Å wide.

According to DeMaria, there are two reasons that a mode-locked Nd<sup>3+</sup> glass laser should yield the highest available peak powers and the narrowest pulse widths:

- The peak power increases and

the pulse width decreases as the number of phase-locked modes increases.

■ Nd<sup>3+</sup> in a glass host has the broadest line width of known laser media.

There are two other ways to mode-lock the laser oscillator than the use of passive modulators, DeMaria says. One is to use an active modulator; the other is to use the nonlinear gain characteristics of the inverted population. The former requires critical adjustment of mirror spacing and modulating fre-

quency: the latter requires critical adjustment of the *Q* of the interferometer, the laser position and the gain of the system. Both of these methods also require compensation of the laser for optical-length perturbations of the feedback interferometer. This is crucial to the mode-locking of large solid-state lasers, owing to optical-length variation of the rods when the optical pumping flash occurs. Passive modulation, on the other hand, does not require any of these critical adjustments. (continued on p. 20)

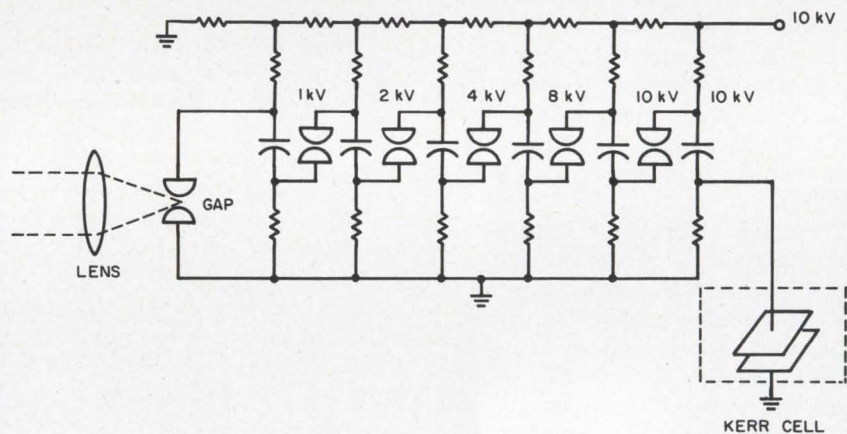
**Pulsar races the speed of light**

A device commonly used in high-energy physics experiments is now aiding the development of lasers that generate ultrashort pulses. The Marx-Bank generator, which delivers pulses with very short rise and delay times, enables the designer of a *Q*-switched laser to choose the region of an optical pulse train at which the system is to select a single pulse.

A Marx-Bank pulse generator is used to activate a Kerr cell, which is switched to maintain a laser-beam propagation medium in a low-*Q* condition. The circuit consists of an array of capacitors that are charged in parallel but discharged in series. A portion of the laser beam is focused through a lens, so that it breaks down an optical gap (analogous to a spark gap) from the top plate of each capacitor to the bottom plate of the preceding one. The resultant overvoltage propagates quickly down the chain (rise time of about 5 ns) until a high potential (10-50 kV)

can be applied to the Kerr cell. The object is to "beat" the speed of light as it bounces back and forth between the laser mirrors, which are a fixed distance apart.

The discharge delay time of an overvoltage spark gap is the sum of two components: the statistical time lag and the formative time lag. The first is the delay between the application of an overvoltage and the appearance of a free electron, which initiates a breakdown of the gap. The second is the time taken to establish a discharge current after the free electron has appeared.

The illumination of spark gaps in most Marx-Bank circuits comes from the preceding discharges of adjacent spark gaps: the first gap illuminates the second, the second illuminates the third, and so forth. This will work, according to United Aircraft scientists, if the spark spectrum of the electrode material includes wavelengths that are capable of generating photoelectrons of that material.

1967  
AUGUST  
1  
TUESDAY

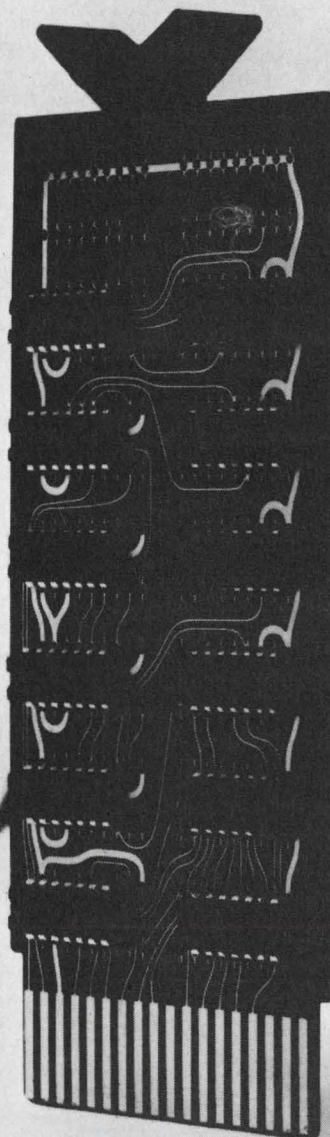

## Better monolithic I. C. modules: Sometimes it pays to wait.

Even DIGITAL waited. Until now, despite the technological accomplishment, there was just no way to get the cost and performance of I.C. modules significantly less than the cost and performance of discrete component modules.

But things have changed. DIGITAL will deliver, in August, a new line of integrated circuit modules — functional logic arrays of high speed TTL's in dual in-line packages, designed to operate from dc to 10 MHz. The module line encompasses every basic system function, and features high fan out, high capacitance drive capabilities, and excellent noise margins.

Waiting has had these advantages: the I.C.'s are the latest,

best, least expensive. Cost vs. performance are now vastly improved for the first time. Lowest cost per gate, for example. The technology of dual in-line TTL's has assets not available in previous I.C. modules.

The boards are identical in size to the FLIP CHIP™ modules, but with 36, rather than 18, pins. Pin sockets and mounting panels, as well as other standardized hardware, are available. All new hardware is compatible with the other FLIP CHIPS™.

We call the new line: M series. Write for further details now. Delivery in August.

**digital**  
MODULES • COMPUTERS

DIGITAL EQUIPMENT CORPORATION, Maynard, Massachusetts 01754. Telephone: (617) 897-8821 • Cambridge, Mass. • New Haven • Washington, D.C. • Parsippany, N.J. • Rochester, N.Y. • Philadelphia • Huntsville • Pittsburgh • Chicago • Denver • Ann Arbor • Houston • Los Angeles • Palo Alto • Seattle • Carleton Place and Toronto, Ont. • Reading, England • Paris, France • Munich and Cologne, Germany • Sydney and West Perth, Australia • Modules distributed also through Allied Radio

(ps pulses, continued)

Two of DeMaria's colleagues, H. A. Heynau, and A. W. Penney, Jr.,<sup>2</sup> pointed out that a mode-locked glass  $\text{Nd}^{+3}$  laser, in conjunction with fast photodetectors, can be used to evaluate electrical networks. The experimental arrangement shown in Fig. 2 has been used to generate, detect and observe the mode-locked laser pulses. The optical pulses were converted into electrical pulses by two specially housed diodes, an ITT F-4018 and an ITT F-4014. The rise times of these two diodes were calculated from optical pulse measurements to be 256 and 90 picoseconds, respectively. The oscilloscope used in these experiments was the modified Tektronix 519. It was necessary to use a traveling-wave oscilloscope because the relatively short pulse duration of the repetitive pulse train obtained from the mode-locked laser ruled out the inherently more sensitive, wider-bandwidth sampling oscilloscope.

The electrical pulses from the signal photodiode were applied directly to the coaxial deflection plates through a connector mounted on the side of the tube itself. This was done to prevent the delay cables from modifying the electrical pulses. The oscilloscope had to be triggered in advance of the signal by the triggering photodiode, which was chosen to offer less optical delay than the signal photodiode.

### Electrical networks tested

Heynau and Penney reported that they had evaluated several electrical networks, including coaxial cable and resistive impedance adapters, by means of mode-locked pulses.

While the results they obtained for the cables were generally in agreement with theory, they did find some anomalies, which, they say, warrant further study.

There were, however, no important disagreements in the case of the resistive adapters.

They suggest many other areas in which the ultrashort pulses could be used to great advantage:

- Evaluation of detectors, trans-

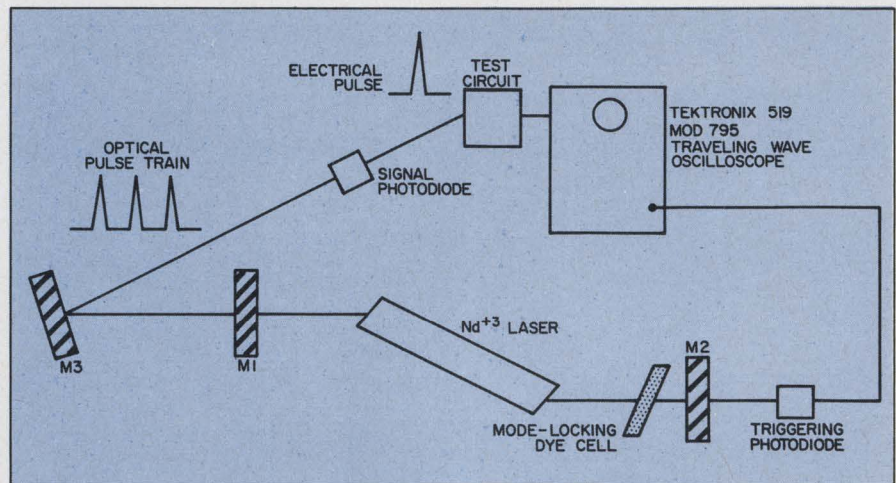

2. Optical pulses generated by mode-locked Q-switched laser exceed the response time of the photodiodes, which in turn respond faster than the fastest traveling-wave oscilloscope. A reference pulse triggers the oscilloscope in advance of the signal. This setup is used to test wideband devices.

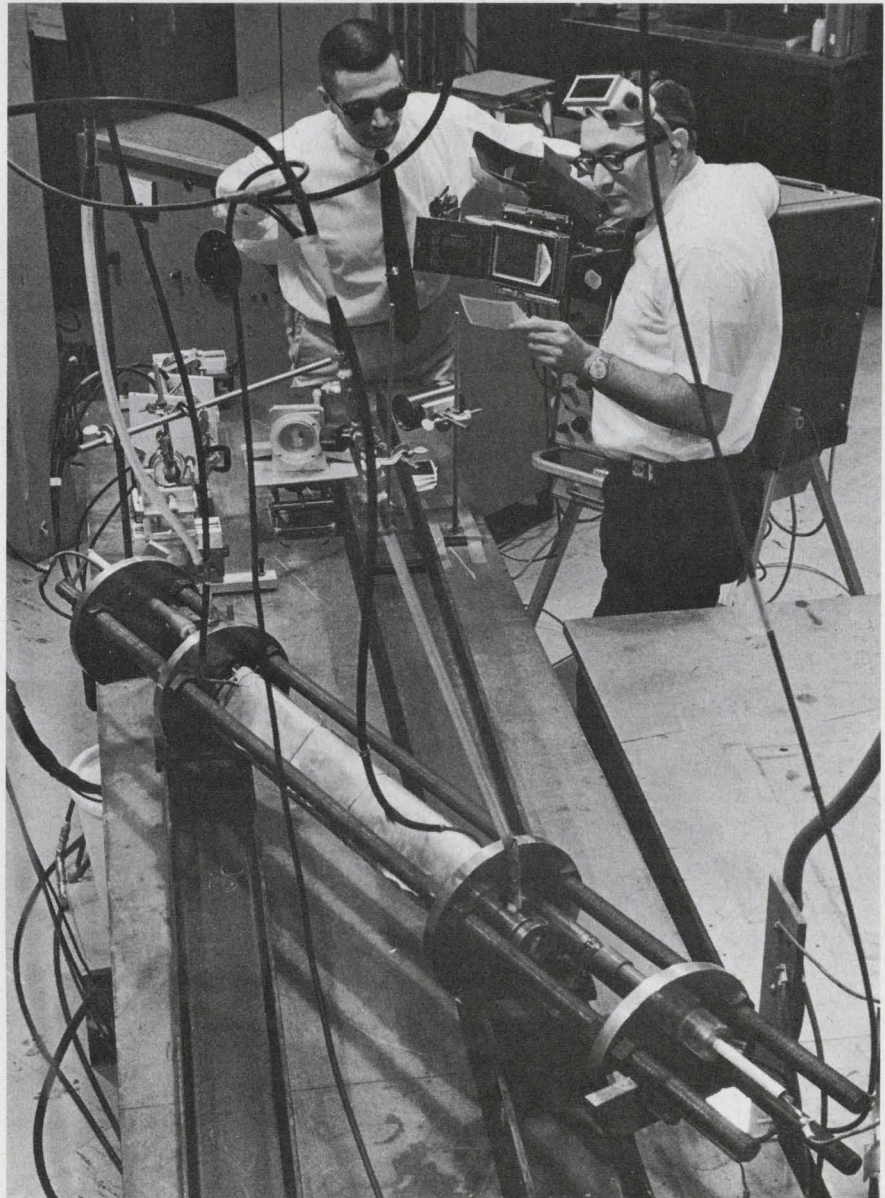

Glass laser uses optical amplifier (foreground) to attain gigawatt bursts. A. J. DeMaria (right) examines photograph of pulse taken from oscilloscope.

ducers, wide-bandwidth systems—anything that handles extremely fast pulses.

- Development of new components and systems, such as detectors, detector housings, fast electrical pulse termination resistors and pads, and direct time-domain display oscilloscopes.

- Coincidence and anti-coincidence network checkout.

- Ultrashort, high-repetition-rate sampling gate pulse trains.

But there is more, much more, that the engineer can do with these pulses. In the words of DeMaria, "Short optical pulses are at the same stage microwaves were right after World War II."

Designers who are truly interested in advancing technology cannot fail to be alert to such bountiful gifts from the laboratories. One golden opportunity lies in the area of optical computers, where velocity-of-light measurements are always a consideration.

DeMaria comments, "If you have a pulse 1 nanosecond wide, physically that's roughly 1 foot long through space. Our pulses are 0.03 cm long—shorter than anything else that's around. Optical memories, optical logic, the whole field of computers—the implications are definitely there for the engineer."

The mind staggers at the thought of dump rates of  $10^{12}$  bits per second or binary logic in time sequences of 1 picosecond.

If radar pulses of 1 nanosecond were available for ranging, engineers would be overjoyed, because 10-GHz microwaves in 1-nanosecond pulses would be equivalent to only 10 microwave cycles in length. With the ultra-short optical pulses it should become possible to measure distances of miles down to 0.03 cm—an accuracy almost beyond belief. ■ ■

#### References:

1. A. J. DeMaria *et al.*, "Generation and Amplification of an Ultrashort Optical Pulse," 1967 *IEEE Conf. on Laser Engineering and Applications Digest of Tech. Papers* (New York: IEEE, pp. 23-24).

2. H. A. Heynau and A. W. Penny, Jr., "An Application of Mode-Locked, Laser-Generated Picosecond Pulses to the Electrical Measurement Art" (Paper presented to the IEEE International Convention, New York, 1967).



## Stradivarius . . . and Nytronics make the difference!

A Stradivarius violin and a Nytronics High Q variable shielded inductor have much more in common than meticulous craftsmanship and quality materials. Both also have the special built-in ability to be precisely adjusted. This is a most desirable quality in an inductor, permitting the engineer to tune it accurately for most efficient performance in any given circuit simply by turning the adjusting head

Their range of 0.10uh to 12hy makes them ideal for all uses in any packaging technique. Hermetically sealed, with no physical contact between adjusting screw and the inductor itself, they provide a stepless adjustment of inductance over a minimum of  $\pm 5\%$  range from nominal — and without strain on printed circuit mountings. With an operating temperature of  $-55^{\circ}\text{C}$  to  $+125^{\circ}\text{C}$ , they meet the requirements of MIL-C-10535C, Grade 1, Class B.

Available from stock in the following package sizes:

WEE V-L—0.300" dia. x 0.400" high; range 0.10uh to 100,000uh  
 ATE-11 — 45/64" dia. x 3/4" high; range 0.01hy to 0.18hy  
 ATE-0 — 1 1/16" dia. x 1" high; range 0.22hy to 1.50hy  
 ATE-4 — 1 19/64" dia. x 1 1/4" high; range 1.80hy to 12.0hy

Nytronics off-the-shelf inventory also includes a wide range of capacitors, delay lines, and resistors. Write today for complete engineering data.



# NYTRONICS®

...for Precision Electronic Components

# Far-out communications for unorthodox wars

## Army studies use of soil, water, rails and skin to transmit messages when radio is impractical

Neil Sclater  
East Coast Editor

Somewhere at some time in some near-impenetrable jungle country, two U.S. Army special forces may be closing in on an enemy camp from opposite sides. They have marched independently of each other for miles, and they must communicate now to make one final check before attacking. Conventional rf methods are out, because the signals might betray their presence to the enemy. Visual methods are impractical; the jungle is too dense. So the two forces use the surrounding soil and rock to relay their messages.

Implausible-sounding communications schemes like this are under investigation by the Army to meet the demands of unconventional warfare. Papers presented by the Army Electronics Command at the recent IEEE International Conference on Communication in Minneapolis outlined the following methods and reported they were showing promise for development:

- The transmission of messages through earth and water bound-

aries by means of audio frequency conduction current.

- Signaling through water, sand, pipes and railroad tracks by magnetic excitation.

- Communicating through soil and rock by seismic waves from transducers.

- Communicating with humans by "tapping" on the skin with low-current probes in prearranged codes.

### Conduction-current signals used

Very efficient battery-operated dc-ac solid-state inverters are being used by the Army as audio-range signal sources. The experimental system is demonstrating the practicality of earth current systems in the 400- and 850-Hz ranges.

Experimentation with communications through earth dates to World War I, but solid-state electronics has made the method more feasible. The maximum range achieved so far in the Army experiments is only about 400 yards, but even this may prove useful for certain operations.

The method depends on the loca-

tion of transmitting and receiving dipoles in a stream or river. Water acts as the transmission media. Water can also couple the audio signals to sandy or mud surfaces, which also may transmit the energy.

Army experimenters are using one transmitter, that is employing silicon-controlled rectifiers as switching elements in a power-conversion circuit. The power output of the transmitter operating at 400 Hz has been 120 watts. A newer 850-Hz inverter has an output power of 300 watts; it uses power transistors as the switching elements.

The audio signals are transmitted through dipole electrodes made up of 5-by-15-inch stainless steel plates mounted at the ends of a 10-foot fiber-glass pole. The electrode is placed below the surface of the water or in wet sand and is supplied with ac power through a 50-ohm cable.

The 400-Hz receiver is a wide-band transistor preamplifier in series with a low-Q tunable millivolt meter. The received signal is amplified so it can be heard through earphones. The receiving dipole electrodes are similar to the transmitting dipoles.

The receiver used in the 850-Hz test consists of a tuned amplifier

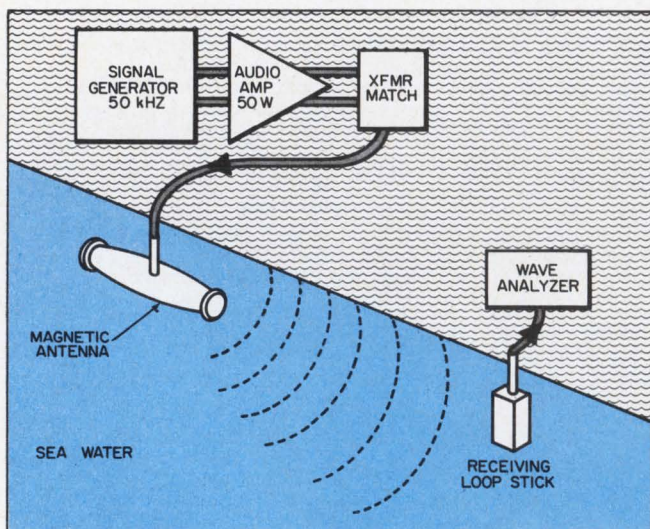

Magnetic excitation of sea water is used by the Army to transmit messages to a receiving loop stick more than 300 yards away. A similar setup transmits signals more than 10 miles when a railroad track is used as a duct.

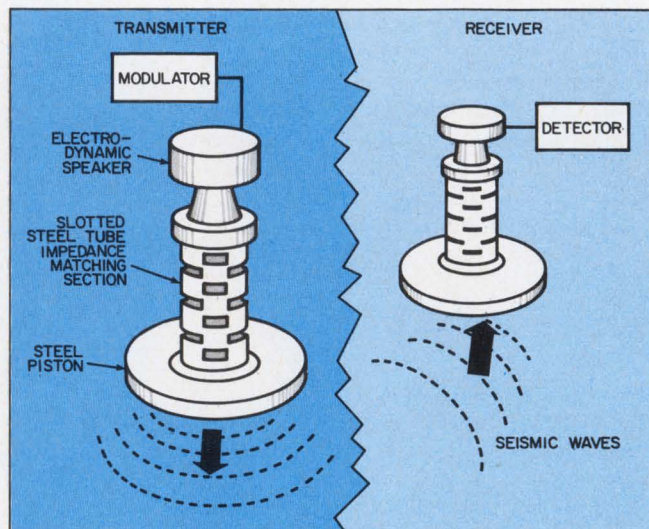

Continuous seismic waves transmit messages through soil and rock. Operating frequencies of about 80 Hz are modulated to permit reception at a mile and a half with the use of 200-W drive power.



Printed circuit board from General Radio Type 1680 Automatic Capacitance Bridge showing use of A-B Type CB ¼ watt fixed resistors and Type F ¼ watt adjustable resistors.

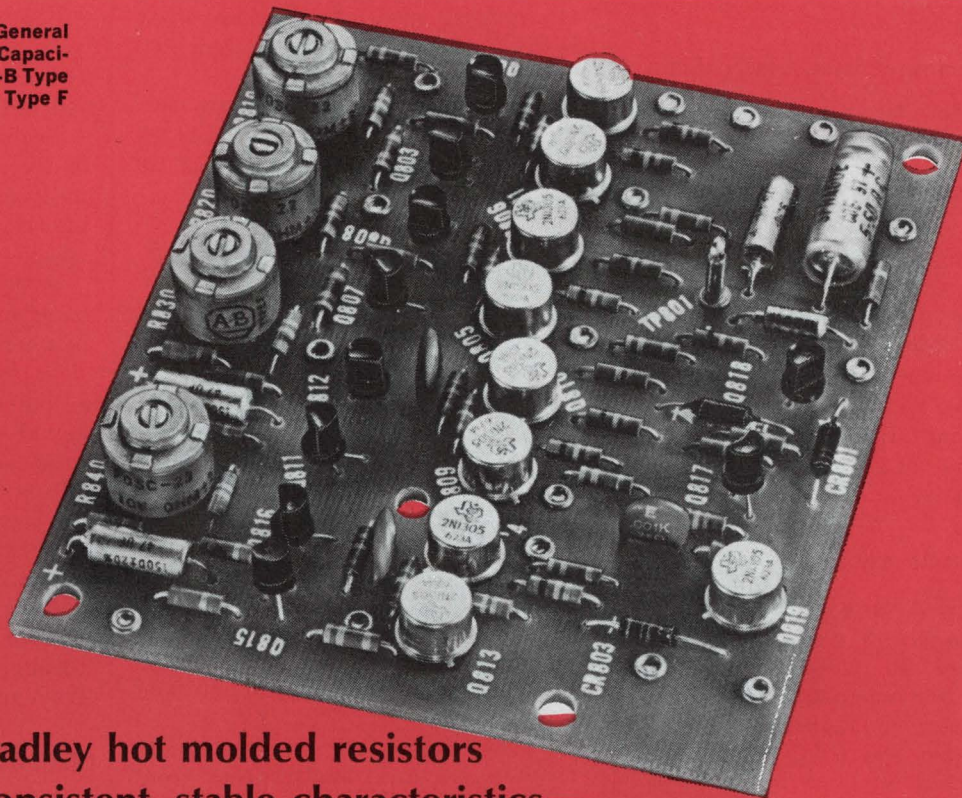

**"we use Allen-Bradley hot molded resistors because their consistent, stable characteristics—month to month and lot to lot—ensure repeatable measurements by our instruments."** GENERAL RADIO CO.



General Radio Type 1680 Bridge automatically measures capacitance and loss simultaneously, generates coded digital output data, and displays measured values in about one-half second. The basic accuracy is  $\pm 0.1\%$  and the range is from 0.01 pF to 1000  $\mu$ F.



**Type F variable resistor** with pin type terminals for mounting directly on printed wiring boards. Rated ¼ watt at 70°C. Total resistance values from 100 ohms to 5 megohms. Shown actual size.

**A-B hot molded fixed resistors** are available in all standard resistance values and tolerances, plus values above and below standard limits. Shown actual size.

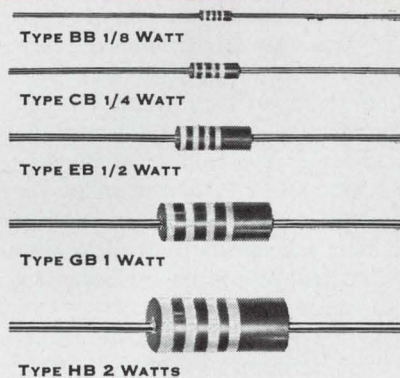

Just as surely as automatic equipment saves its users' money when it is in operating condition, it is virtually worthless when failure of a component has made the entire device inoperative. To insure the reliable and accurate performance of their new automatic capacitance bridge, General Radio designers selected Allen-Bradley hot molded fixed and variable resistors.

Allen-Bradley resistors are made by a hot molding process using completely automatic machines developed by Allen-Bradley. This results in such precise uniformity from one resistor to the next—year in and year out—that long term resistor performance can be accurately predicted. Furthermore, there is no known instance of catastrophic failure of an Allen-Bradley hot molded resistor.

The same manufacturing technique is used with the Type F variable resistors. Their solid hot molded resistance track assures smooth control from the very beginning and which improves with use—and are completely devoid of the abrupt changes to be expected of wire-wound controls. In addition, A-B variable resistors are essentially noninductive, permitting their use at frequencies far beyond range of wire-wound units.

For more complete information on the full line of Allen-Bradley quality electronic components, please write for Publication 6024: Allen-Bradley Co., 1344 S. Second St., Milwaukee, Wis. 53204. In Canada: Allen-Bradley Canada Limited. Export Office: 630 Third Ave., New York, N. Y., U.S.A. 10017.



**ALLEN - BRADLEY**  
QUALITY ELECTRONIC COMPONENTS

**(communications, continued)**

and null detector coupled to a wave analyzer. The receiving dipole, which is connected to a matching transformer, feeds this combination. Signal levels are indicated on the output meter of the detector's wave analyzer.

Signals from the 400-Hz system have been received closely at distances up to 220 yards.

The 850-Hz system is able to transmit signals that can be detected 750 yards away, but the ratio of the noise to signal has been high.

**Magnetic excitation method**

Buried pipes, railroad tracks, creeks, rivers, sea water and beaches are all possible transmission lines for magnetic-excitation communication. Magnetic couplers and antennas are being used to excite electrical currents and fields in man-made and natural substances on or below the earth's surface.

The Institute for Exploratory Research at Fort Monmouth, N. J., is experimenting with two forms of magnetic excitation: one in sea water and one through railroad tracks. The experimental frequencies are within the range of 48 to 50 kHz.

The transmitting antennas in both types of experiment are made of a sheet of iron-loaded silicon rubber and a sheet of Mylar rolled together to form a core for a wire coil. This solenoid is then encased in a cylindrical fiberglass shell about a yard long.

The drive circuit for the transmitting antenna employs simple laboratory equipment. The output from a signal generator is fed into an audio amplifier. Then the output signal from the amplifier is matched to the transmitting antenna by a coil and a capacitor.

Signals are received by a loopstick receiving probe—a coil wound on a ferrite rod encased in a plastic box. A 20-foot coaxial cable connects the probe to a battery-operated wave analyzer, which is used as a detector. The input of the wave analyzer is shunted by a capacitor to tune the pick-up probe to resonate at the transmitted frequency.

Kenneth Murphy and Ronald Johnson, Army physicists, say that received signals in sea water are

strongest one to two inches below the surface and range exceeds 300 yards.

The railroad track field tests have shown that signal attenuation is exponential and that a range of 10 miles can be obtained.

**Seismic communications**

Army investigators have found that while continuous-wave seismic signals, either amplitude- or phase-modulated, appear to have a communications potential, the problem is the conversion of primary power to useful elastic waves—a necessity for achieving effective range.

In their experimental work, the Army scientists devised two types of transducers, one for soft earth and the other for hard rock. One tunable receiver is being used to receive signals through both hard and soft media.

The transducers are essentially electrodynamic loudspeakers connected to a steel tube and piston assembly. When the unit is transmitting, force is transferred to the ground by the tube and piston. When receiving, the displacement of the seismic medium is transferred to the speaker by a reversal of this transmission process.

For soft media the speaker's resonant frequency can be varied from 83 Hz (loose sand and gravel) to 78 Hz hard clay). The soft-media transducers have a maximum driving power of 10 watts.

The hard-rock transducer has a normal operating frequency of about 80 Hz and a maximum driv-

ing power of 200 watts. The tube that connects the piston with the speaker on the transducers is slotted and acts as a quarter-wave transmission-line section. It matches the mechanical impedance of the medium piston boundary with the electrical impedance of the loudspeaker amplifier.

Army researchers have communicated on the surface over distances of about a mile and a half but believe this range can be improved. A pulse-amplitude-modulated-80-Hz signal was received with a signal-to-noise ratio of about 3 dB.

Sixty watts of power applied to the large transducer permitted communications through rocky soil over a distance of two-thirds of a mile.

Experiments have also been performed on transmitting signals through the ice of frozen lakes and from mines.

**Skin as a transmission medium**

The nerves of the skin are being considered by the Army as a "possible port of entry" for messages. The method uses electric currents to tap out signals on the skin's surface.

In experiments now being performed jointly by Fort Monmouth's Avionics Laboratory and Communications and Data Processing Laboratory, coded signals are being received by soldiers with electrical transducers strapped to their forearms. Current, adjustable by the soldier from 0.1 to 0.9 mA, is used as the stimulus.

Dr. John Hennessy and Dr. Herbert Bennett say that the investigations to date indicate that the electric tapping messages are effective both for primary communications and when used as a secondary cue in conjunction with an audio channel that has poor separation of noise and signal.

The best results in primary communications have been obtained when the signals were reinforced by time-delayed "shadow signals." The latter repeat the primary code and tests have shown that the delay time between the primary code and the "shadow" is best between 2 and 5 milliseconds.

The Army, according to Dr. Hennessy, would like to use skin communicators to direct men working on such assignments as disarming explosives. ■ ■

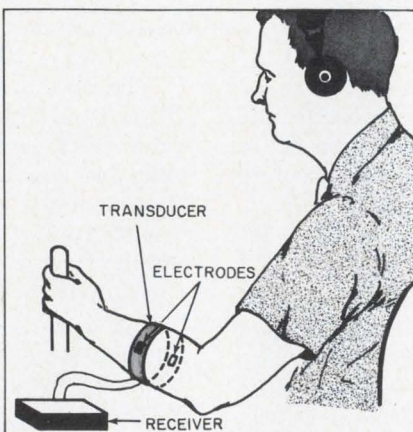

**Messages are sent through the skin** by pulsed low currents from electrodes on a transducer strapped to the forearm. Signals can be a primary source or can reinforce audio messages.

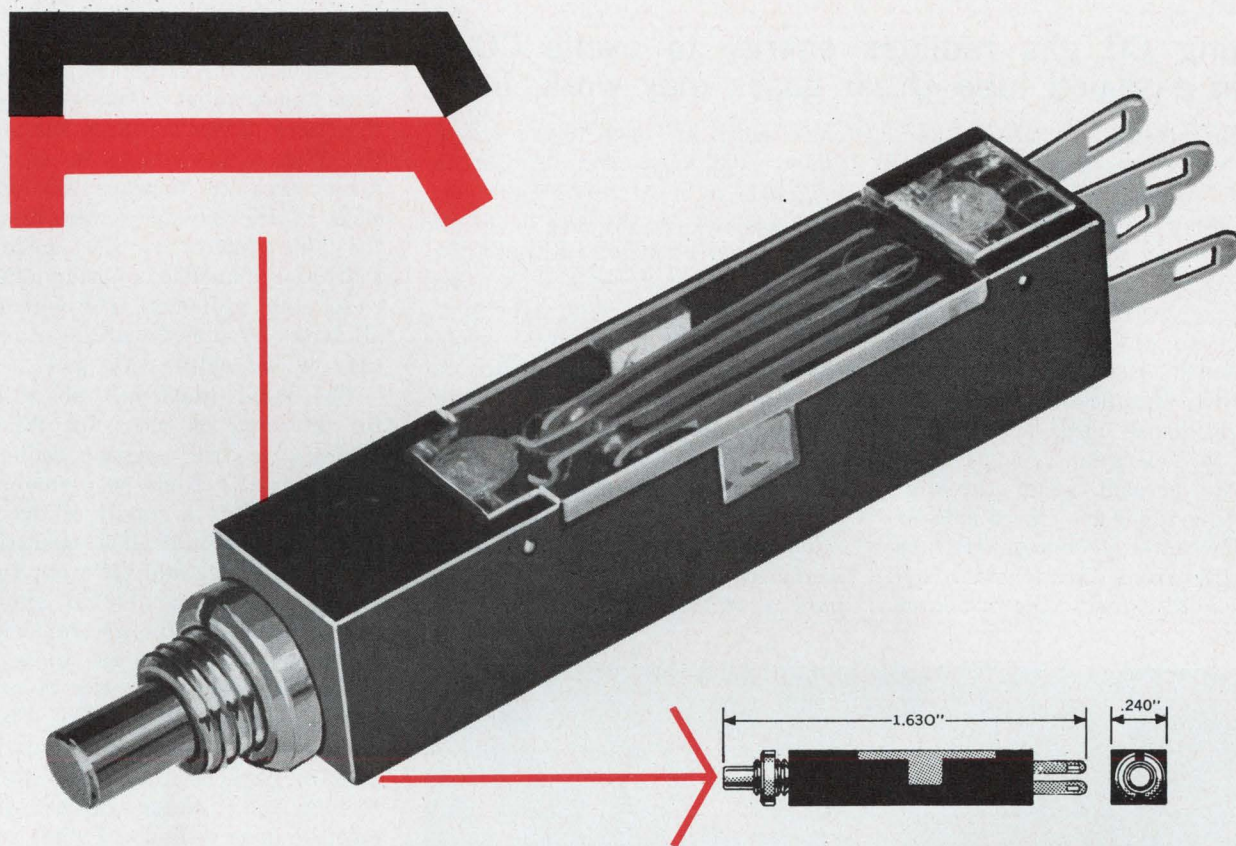

## ROWAN'S NEW PS SWITCH . . .

is a momentary action, two-circuit switch with a maximum contact rating of 500 milliamps, 50 volts AC or DC, and featuring:

1. Sub-miniature size measuring 1.63" x 0.24".
2. High density, modular pack of four switches (8 circuits) per ½ square inch.
3. Very long life, repeatedly tested in excess of 5,000,000 electrical operations.
4. Very low resistance—very low voltage drop.
5. Extremely low bounce.

The PS Switch is standard with either two N/O, two N/C, or one N/O and one N/C contacts. Weighing 2.2 grams, it is mounted in a 0.166" panel hole by means of either circular, hex or knurled nut. Square or round buttons are offered in any of five colors.



*For more information, call or write*

**THE ROWAN CONTROLLER COMPANY**

OCEANPORT, NEW JERSEY 07757

# 'Flame laser' requires no electrical supply

**Burning CO gas radiates energy to excite CO<sub>2</sub> within a sealed tube—Other gases may work, too**

Touch a match to a gas jet and, presto, out comes a laser beam.

That's what happens in a new "flame laser" invented by Dr. Irwin Wieder, principal scientist for the Carver Corp., Mountain View, Calif. Dr. Wieder, who prefers to call his development a "chemioptical resonant pumped" laser, believes that it will prove significant because the resulting device needs no electrical source for operation.

In the present setup three 4-meter-long tubes are placed side by side. The center one is a quartz tube filled with carbon dioxide under partial vacuum (1 torr); the two outer

ones, which are open to the atmosphere, hold long gas jets. Carbon monoxide is sent through the jets and lighted. As the CO burns, it combines with oxygen ( $2\text{CO} + \text{O}_2 = 2\text{CO}_2$ ) in the air. As the chemical bond takes place, energy in the form of radiation is released at about 4.4 microns. This energy pumps up the CO<sub>2</sub> in the center tube to higher energy states. As this excited CO<sub>2</sub> drops to lower energy levels, laser action occurs in the infrared region at about 10.6 microns.

The present equipment is very inefficient, Dr. Wieder reports. Outputs are in the range of 1 milliwatt.

This is accomplished with two burners, each about 4 meters long, and with flames about 7.5 cm long. Now that laser action has been achieved, Dr. Wieder intends to investigate some steps to improve efficiency, such as the use of reflectors and the substitution of CO<sub>2</sub> isotopes that offer transitions better matched to the radiation. He will also study the effects of changes in pressure of the active CO<sub>2</sub> gas.

The most important possibility for this type of laser, Dr. Wieder believes, is for compact units in which the CO<sub>2</sub> could be permanently sealed. Then a supply of CO gas and a flame would allow operation. Other molecules and different fuels should also be capable of similar laser action. The energy transitions in this type of laser are those between different vibration-rotation energy levels of the CO<sub>2</sub>. Flame processes are not completely understood by physicists, according to Dr. Wieder, and therefore further work must be done to find out what variations on the basic principles will prove feasible. He suggests that similar radiation processes are involved in explosions and that this might provide another type of excitation source for future lasers.

Dr. Wieder started his work on the flame laser before recent developments in CO<sub>2</sub> lasers, which are now the most powerful types available in the gas laser family. His interest in CO<sub>2</sub> centered on the presence of closely spaced vibration-rotation levels in CO<sub>2</sub> molecules, which appeared ideal for his flame-radiation experiments.

His initial experiments put the CO<sub>2</sub> in the same tube with the burning CO. This configuration did not prove successful, so he switched to the present three-tube setup.

The quartz tube that holds the lasing CO<sub>2</sub> has an inner diameter of 24 mm and a wall thickness of 1 mm. Germanium mirrors, with dielectric coating for 99.5% reflectivity at 10.6 microns, are used in the cavity.

Dr. Wieder's work is being supported by the Mobil Oil Corp. as well as the Carver Corp. ■ ■

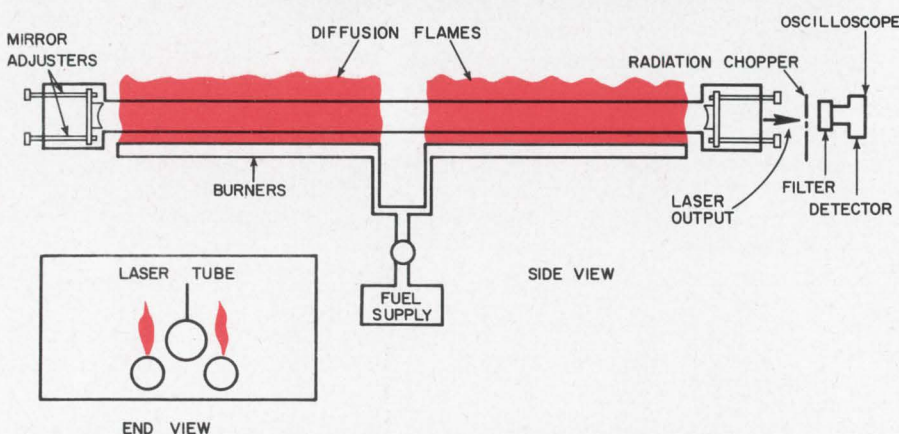

'Flame laser' requires no electricity, just a supply of CO gas to feed the burners and a match. Lasing action occurs in a 4-meter-long quartz tube filled with CO<sub>2</sub>. The laser tube is sealed; the burner tubes are open to the atmosphere. Dr. Irwin Wieder checks the output (top).

# Union Carbide's New Integrated Circuit Operational Amplifier

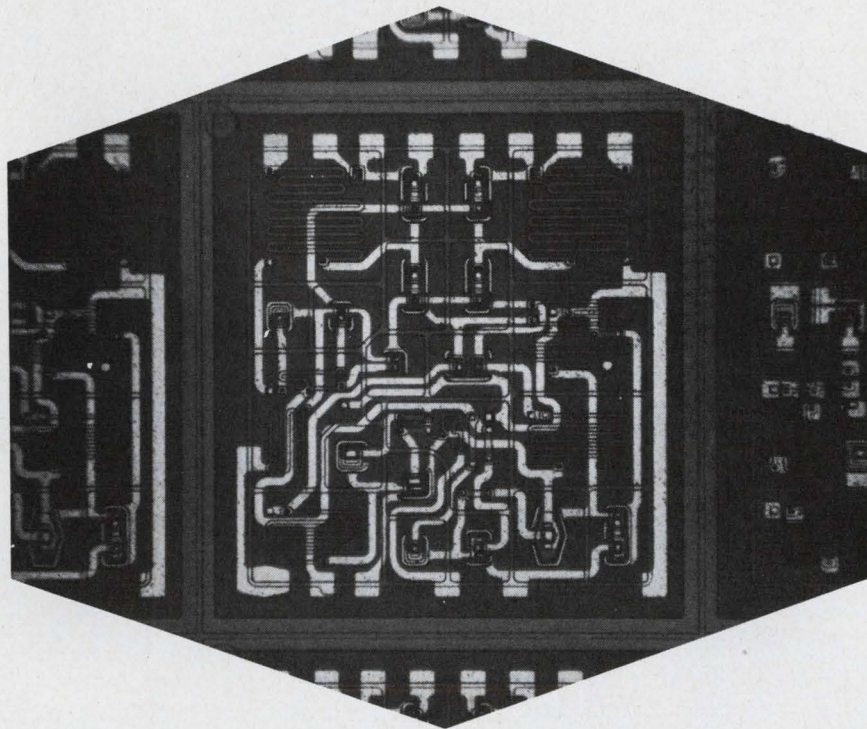

## The 15nA Operational Amplifier

### UC4000

- 15nA differential input offset current (max)
- 175pA/°C differential input offset current drift (max)
  - 5mV input offset voltage (max)
- 10 $\mu$ V/°C input offset voltage drift (max)
  - 50nA input biasing current (max)
  - $\pm 10$ V common mode voltage (min)
  - $\pm 10$ V output voltage swing (min)
  - 2mA output current drive (min)
  - 20,000 open loop voltage gain (min)
- $-55^{\circ}\text{C}$  to  $+125^{\circ}\text{C}$  operating temp. in TO-101
- Offset Voltage adjustable to zero with external potentiometer
  - Off the shelf delivery

*applications:* A to D converter • Bridge amplifier • DC amplifier • Differential amplifier  
Integrator (DC to AC) • Sample and hold amplifier



**ELECTRONICS**

Semiconductor Department / 365 Middlefield Road, Mountain View, California 94040 TWX: 910-379-6942; Telephone (415) 961-3300

ON READER-SERVICE CARD CIRCLE 15



Automated testing...

...helps make  $\mu$ -PACS  
the most reliable  
I/C modules in the  
industry

$\mu$ -PACS are 100% tested. We test the components, test the circuit boards, and test every finished PAC against stringent QC standards. In fact, we designed our own automatic PAC test system to perform more tests faster . . . like 85 static and dynamic electrical tests in less than 20 seconds. All to make sure the reliability we achieve in design is passed on to you in production.

Whether you face design of a one-shot black box, or an entire product line, why not rely on  $\mu$ -PACS. You'll never have to worry about reliability. They've been proven in hundreds of systems — and in test after test. And you get the best price/performance ratio available today. Write for our new brochure. It sums up all the facts. Honeywell, Computer Control Division, Old Connecticut Path, Framingham, Massachusetts 01701.

# Honeywell

 **COMPUTER CONTROL**  
DIVISION



## Electronic intelligence to be beefed up

The Pentagon and the White House are reported to be so impressed with electronic intelligence (Elint) that a substantial increase in funds and manpower is to be devoted to it.

Elint is relayed by the high-speed, unmanned and usually unarmed "winged rf probes" that have been flying "ferret missions" in Southeast Asia, over the fringes of China, Eastern Europe and the Soviet Union itself. These missions have brought back information on changes in codes, communications frequencies, IFF (identification, friend or foe?) procedures, radar locations and anti-aircraft systems and tactics so rapidly that a new information-processing wing of the huge National Security Agency building near Washington is already swamped. The wars in Vietnam and the Middle East have confirmed the intelligence garnered by Elint.

Top officials of the National Security Agency, the electronics-intelligence organization operation by the Pentagon, asked Capitol Hill in January for some 50 new "supergrade" employees. Career government employees normally earn a maximum of \$19,000 a year; supergrades receive up to \$25,890 for their extra talent and positions over thousands of employees, many of them in normal "top" government grades. The House Manpower Subcommittee is keeping its own counsel on the agency's unusual request, but is expected to grant it. Observers remark that a request for 50 supergrades bespeaks a major new Elint program.

Ferret missions, generally flown by RB-66s and more recently by RF-4s also, have been in use since the end of World War II. So effective have they become that much of the money allocated to a new weapon system

# Washington Report

S. DAVID PURSGLOVE,  
WASHINGTON EDITOR

is tied up in electronic countermeasures (ECM) to prevent "ferrets" picking up false information. Hitherto Vietnam has been the only area where real hostile actions have enabled the Pentagon to correlate Elint data with the procedures taken by an actual enemy under attack. Elsewhere one of the agency's toughest tasks has been to elicit genuine counterintrusion measures and communications from the barrage of false signals and meaningless messages put up by military forces at the approach of an unidentified aircraft or vessel. Last month's critical flare-up in the Middle East, with real radar and genuine communications in use, gave the Pentagon an unparalleled opportunity to observe an electronically ordered battle based on Soviet doctrine and hardware.

Now the Pentagon has a twofold reason to beef up NSA. Elint ships and aircraft—maintaining surveillance from afar but definitely not within the six-day crisis zone, Pentagon officers insist—have proven their value and that their use should be increased. The second reason is that the Pentagon now expects the Soviet bloc to make many changes in its communications and counterintrusion procedures in the wake of the Arab-Israeli conflict. Thus a new round in Elint, ECM and ECCM is believed to be in the offing.

## Technological Marshall Plan dead

There will be no major U.S. aid program of the sort that Italian Foreign Minister Amintore Fanfani has referred to as a "Technological Marshall Plan." For months, the White House has closed its collective ears and kept very still in the hope the thing would go away. On the contrary, however, European clamor about a "technology gap" that was somehow the willful fault of the U.S. and must be redressed by the

# Washington Report

CONTINUED

U.S. government has grown louder and more insistent. Finally, the White House broke its silence and sent the then Commerce Secretary-designate, Alexander Trowbridge, to Paris. Trowbridge put the message across obliquely—in an address to the American Chamber of Commerce in France—but he made it very clear.

Only Europe itself can redress the technological gap and the brain drain, Trowbridge said. He said an American aid program likely would not be much help because the roots of Europe's problem do not lie in technology; Europe has amply demonstrated its technological competence. Rather, he contended, the problem involves productivity, education, economies of scale, managerial environment, natural resources and markets. But, even if these were not the root problems, and a simple U. S. aid program would close the technology gap, Trowbridge asserted, the U.S. government still could not take on such a responsibility. The government cannot give away much American technology, Trowbridge pointed out, because most of it is private property.

The White House emissary was not entirely negative. Although he does not favor a formal government program for transferring information and hardware to Europe, he does favor—and will work for—more international conferences, joint undertakings and increased industry-to-industry contact. He believes Europe can pick up more U.S. technology and productive know-how by increasing its investment in U. S. industry. And, voicing what probably he believes is the crux of Europe's problem, Trowbridge stated bluntly that he would like to see Europe make better use of the technological information that it does receive. He suggested that this could be done through programs and centers similar to the U.S. Commerce Department's Office of State Technical Services—a program often likened to an Agricultural Extension Service for industry, with offices functioning in the manner of the County Agent's.

## U.S. to define auto electronics role

Directions that the government will take in the rapidly developing highway-automobile electronics market are expected to be clear by

late September. A number of Transportation and Commerce Department officials are planning to respond to IEEE's call for papers for its Sept. 21-22 Second National Automotive Conference in Detroit. Papers and exhibits at the Conference and presentations at collateral functions may spotlight several new programs now only in the planning stages, as well as survey the present Topics program and the traffic-safety spot-improvement program.

Topics (Traffic Operations Program to Increase Capacity and Safety) deals only with urban highways and is the government's first major move into city-streets projects. One of its chief interests is application of computers to receive and evaluate traffic flow data from remote locations and then control the flow of autos on urban freeways. The traffic-safety spot-improvement program identifies specific points of high accident probability and attempts to make them safer. This often involves traffic-counting and installing signal-regulating equipment. Both are programs of the Office of Traffic Operations in the Transportation Department's Bureau of Public Roads. Among the Office's avowed missions is the promotion of uniform traffic-control devices.

## Proxmire proposes budget cuts

End the SST program, all but eliminate funds for post-Apollo projects, substantially reduce troops in Europe, cut deeply into "pork barrel" Federal highway and Corps of Engineers projects. These are recommendations of the majority party's current "whiz kid" in the Senate, William Proxmire (D-Wis.) The man believed by many of his colleagues to be the only senator who could give Robert F. Kennedy serious presidential competition, but who will probably provide his most valuable support, believes that post-Apollo funds can be cut by over \$1 billion. He admits that such a cut "would postpone such projects as a soft landing on Mars, which has nothing to do with our present goals." On the Administration's request for \$198 million to get the supersonic transport under way, Proxmire contends that, "at a time when we must carefully scrutinize the priority of our expenditures, we certainly can forgo this expensive frill."

Significance? Although turning a deaf ear to dove Proxmire in foreign affairs, the White House listens with respect on almost all money matters. Proxmire is Chairman of the Senate-House Joint Economic Committee and number two Democrat on the Senate Banking and Currency Committee.



Just push a button to select one of five different functions and make measurements in a total of 23 ranges.

Measure (1) dc voltage in 3 ranges from 0.0000 to  $\pm 999.99$  volts with automatic and manual ranging. Accuracy:  $.005\% \pm 1$  digit. Sensitivity: 100 microvolts. Measure dc millivolts in 2 ranges from 00.000 to 100.00 millivolts. Accuracy:  $.02\% \pm 1$  digit. Sensitivity: 1 microvolt. Stability: 30 days with  $10^\circ\text{C}$  temperature variation. Push a button for (2) DC/DC ratios in 3 ranges from .00000:1 to  $\pm 99.999:1$ . Standard feature: automatic polarity selection. Push a button to measure (3) ac in 3 ranges from 00.000 to 1000.0 volts rms; (4) dc current in 6 ranges from 0.0000 microamperes to  $\pm 100.00$  milliamperes; (5) resistance in 6 ranges from 0.0000 kilohms to 100.00 megohms.

Each button lights up for positive identification. And this versatile instrument takes up just  $5\frac{1}{4}$  inches in a 19-inch rack. Model 533-4810, rackmount: \$2,750.

Also available: our new 530 Series DC DVM/Ratiometer, which measures dc voltage in 3 ranges from 0.0000 to  $\pm 999.99$  volts and DC/DC ratios in 3 ranges from .00000:1 to  $\pm 99.999:1$ . Accuracy:  $.005\% \pm 1$  digit. Automatic ranging and pushbutton function selection are included in both cabinet (half-rack) Model 531-1000 and rackmounting Model 531-3000 at \$1,495.

Prices FOB San Diego. Additional export charge. Better get full details now from your nearest Cohu engineering representative. Or contact Ken Walker, Manager, Instruments and Systems. Phone 714-227-6700, or write Box 623, San Diego, California 92112.



See us at WESCON, Booth 3001

NOW  
FIVE  
FUNCTIONS  
AT  
YOUR  
FINGERTIPS  
WITH  
THE  
FIRST  
TRUE  
PUSHBUTTON  
MULTIMETER—

## COHU'S NEW 530 SERIES



ON READER-SERVICE CARD CIRCLE 17

If  
you're  
talking  
**THERMISTORS**  
VICTORY  
talks  
your  
language

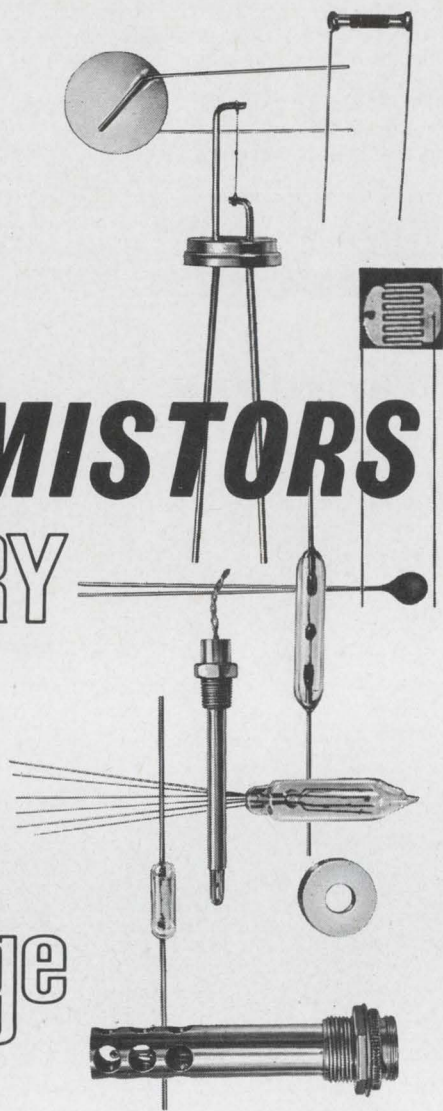

Thermistors provide precision measurement, compensation and control of temperatures, liquid levels, the flow of liquids and gases . . . WITH INSTANT RESPONSE.

Initially developed for the communications field and then the aircraft and space age, VECO thermistors have found their place in industry. From Office Copying Machines and Juke Boxes to Computers and CATV Distribution Systems, design engineers are finding more and more thermistor applications in every-day products.

VECO Thermistors are available in a wide range of sizes, shapes, resistance values and temperature coefficients. VECO's staff of experienced engineers is available to assist you in product application and circuit design.

Write for Catalog MGP681

VECO First in Progress • First in Service

J-8429



**VICTORY ENGINEERING CORP.**

Springfield Ave., Springfield, N. J. 07081  
Tel: 201-379-5900 TWX: 710-983-4430

ON READER-SERVICE CARD CIRCLE 18

NEWS

**Opaque ruby passes pulsed laser beam**

Two University of California physicists have passed light from a ruby laser through a ruby rod, which is ordinarily opaque to light on that wavelength when it emanates from an incoherent source.

Prof. Erwin L. Hahn of the Berkeley campus says that a short pulse above a critical amplitude propagates through an optically resonant medium as though it were transparent; below that critical threshold the light will be absorbed. He explains:

"As the light goes through, it is momentarily absorbed by the optical transition in the medium. But the energy absorbed from the leading edge of the pulse is later emitted back to the trailing edge. The light pulse thus goes through as though it hadn't given away any energy."

He compares it to bowling balls approaching a row of rigid pendulums: if the balls roll slowly, they lose all their energy. But if they are thrown fast enough to drive the first pendulum past the 180° point, it will swing around and smack the balls on the rear end. The balls are then sent on with renewed energy to the next pendulum.

"This is a rough analog of what the light pulse does," Hahn says, "and it also illustrates the threshold effect."

Hahn and his colleague, Samuel L. McCall, have observed these self-induced transparency effects only in ruby. He says, however, that the principle may make it possible to pass extremely short light pulses through other materials, provided that the width of the light pulses is short compared with the transverse relaxation time in the medium and the height is sufficient.

At room temperature the results are masked by an extremely fast transverse relaxation. Therefore, the researchers had to cool the experiment to 4.2° K, where the time constant is extremely long. With ultrashort pulses like those generated by DeMaria and others at United Aircraft Research Laboratories (see p. 17), these phenomena could be observed even at room temperature. ■ ■



## HERE'S AN I/C DIVIDE-BY-10 COUNTER THAT OPERATES IN EXCESS OF 100 MHz

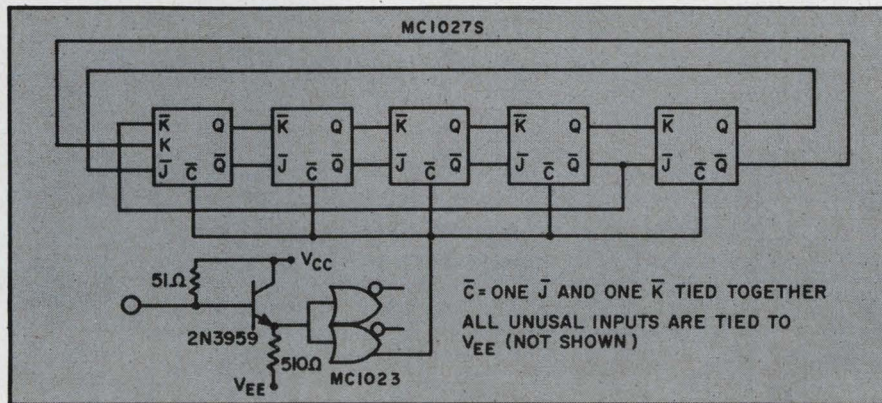

**(MECL II MADE IT POSSIBLE)**

Motorola's high-speed MECL II just smashed its own speed record ... with the introduction of the MC1027 integrated circuit J-K Flip-Flop. Specified for a toggle and shift frequency that's typically 120 MHz, this new circuit more than doubles the speed of any other J-K Flip-Flop now available in other logic families.

A new high-speed dual clock-driver, the MC1023, also announced with the flip-flop, is capable of driving 10 flip-flops or more, at high clocking rates — eliminating high-frequency drive problems for the designer. Together, the two units form the excellent high-performance Switchtail Ring Counter, shown above. Previously, this type of high-speed application would have been possible *only* with discrete components. Now, MECL II *makes it possible* with the advantages of size, weight and reliability that only Motorola integrated circuits can provide!

Other typical specifications include:

CHARACTERISTIC	MC1027 J-K FLIP-FLOP	MC1023 DUAL CLOCK DRIVER
Toggle Frequency	120 MHz	—
Propagation Delay	4.5 ns	2.0 ns (Fan-out = 10)
DC Fan-Out	25	25

For complete details, including data sheets, application notes and prices, circle the reader service number. Then, contact your franchised Motorola Semiconductor distributor for evaluation units that you can try right now. You'll see why MECL II is getting "rave notices" all over the country!



**MOTOROLA**  
**Semiconductors**

*—where the priceless ingredient is care!*

MOTOROLA SEMICONDUCTOR PRODUCTS INC. / P.O. BOX 955 / PHOENIX, ARIZONA 85001 / (602) 273-6900 / TWX 910-951-1334

ON READER-SERVICE CARD CIRCLE 19

# this is LSI..

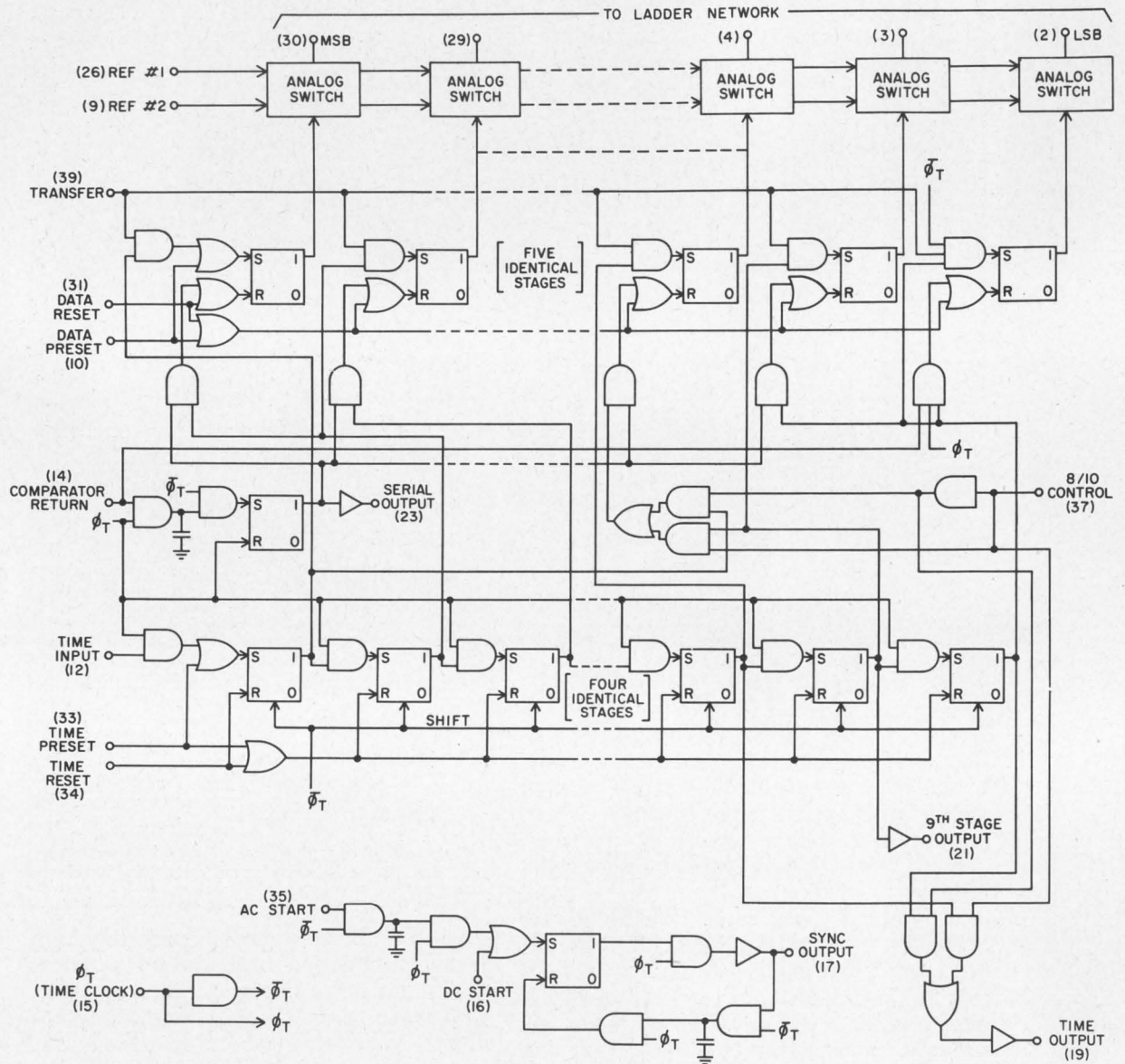

**Another MTOS First...** This Monolithic A/D-D/A Converter incorporates General Instrument's **exclusive** MTOS (Metal-Thick-Oxide-Silicon) process which provides Large Scale Integration without the need for high-cost discretionary wiring.

# the first available monolithic analog-to-digital digital-to-analog converter

And only General Instrument makes and delivers these advanced LSI devices...today!

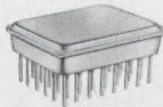

Actual Size

## **MEM 5014 A/D-D/A Converter..... \$268<sup>00</sup> each\***

General Instrument's MEM 5014 is a Monolithic MTOS Integrated Circuit containing 350 active components on a chip 62x104 mils. It performs all the logic and analog switching functions for 10-bit successive approximation analog-to-digital conversion. In addition, it operates in two other major modes—as a 10-bit digital-to-analog converter or a 10-channel analog multiplexer.

As an analog-to-digital converter, the MEM 5014 is used in conjunction with an external precision ladder network and voltage comparator. This mode provides both serial and parallel binary outputs. The MEM 5014 is packaged in a 40 lead hermetically sealed in-line package which can be soldered to a printed circuit board or used with a 40 pin socket. Write for complete data and application notes.

*\*in quantities of 100*



GENERAL INSTRUMENT CORPORATION • 600 WEST JOHN STREET, HICKSVILLE, L. I., NEW YORK

ON READER-SERVICE CARD CIRCLE 20

# Low-cost display tested for computer 'utilities'

## MIT laboratory terminal gives graphic input and output on memory CRT linked to a telephone line

The goal of a low-cost graphic display for time-shared computers is closer as a result of a recent development at the Massachusetts Institute of Technology. An on-line graphic terminal, now operating at the institute's Electronics Systems Laboratory, promises performance possible today only from more costly commercial graphic systems.

The MIT display console was designed by the laboratory for Project MAC, the institute's research program on time-shared computers. It sends and receives both alphanumeric characters and drawings.

The display can be fed by standard telephone lines. It includes a direct-view cathode-ray storage tube, a typewriter keyboard and a simple graphic input device.

The laboratory engineers believe that the prototype terminal could be built in large quantities for about \$5000 each. This price is more expensive than that of a teletypewriter but is comparable to that for

present commercial alphanumeric display stations.

The MIT laboratory is advancing the large-scale "public utility" computer concept, which calls for hundreds of low-cost remote terminals. While the engineers believe simple teletypewriter stations will continue to be useful, they assert that graphic man-machine "conversations" are essential in the computer utility to perform such services as design, problem simulation and industrial process control.

John Ward, assistant director of the systems laboratory, says: "Current commercially available, low-cost displays are unsatisfactory for the future needs of large-scale utility time-sharing. None of them offer, or are particularly well suited to providing, anything but an alphanumeric capability. They are essentially electronic typewriters."

Ward says that for graphic display, image storage is more promising than the "continuously re-

freshed" CRT display. He says that high-speed electronics for rewriting the picture are not needed (conventional displays must be refreshed by redrawing them 30 to 40 times a second to eliminate flicker from the CRT display). For more complicated pictures, Ward adds, the refreshing technique is costly, because the bandwidth of the internal display electronics must be increased to achieve the high speed required to form these pictures.

"By storing the picture created in image form as it comes off the telephone line, the only limit to picture complexity is the active area and resolution of the display device, and not the capacity of the memory or the writing rate," Ward notes.

Robert Stotz, Co-developer with Thomas Cheek of the laboratory's display, says: "The image of graphic input-output on the computer community is just beginning to be felt, but until low-cost graphic displays become readily available, this impact will be greatly impeded."

The low-cost display uses a standard high-resolution Tektronix five-inch storage tube, a 94-symbol standard keyboard, an electro-mechanical input device called the "mouse," and a control unit.

### Linked to phone line

The control unit connects with the telephone line, provides analog voltages to drive the display screen and establishes the format for the keyboards and graphical input signals to be sent to the computer.

The display station will connect, as a remote console, to the Project MAC time-sharing system by means of a dial-operated telephone line. The station's output data rate is 10 times that of a teletype.

Stotz says that one advantage of alphanumeric output on displays is that they more closely approximate human reading abilities. People can read much faster than the output of a teletypewriter.

New data are written only once, Stotz says, and they may be entered randomly on the display screen at

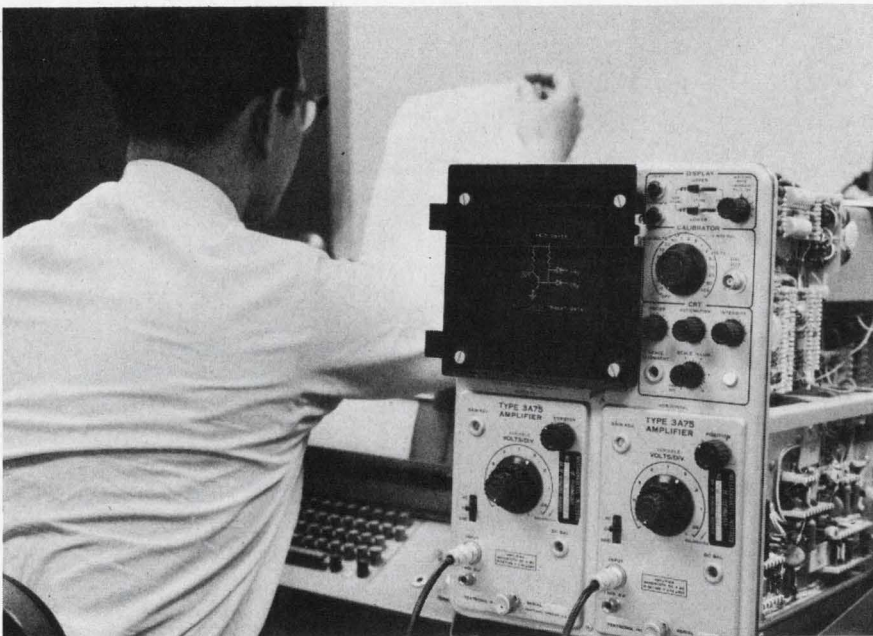

MIT's low-cost graphic display uses a modified Tektronix 564 oscilloscope. Thomas Cheek, co-developer of the system, checks the printout of input commands for test purposes. Hard copy will not be produced in final version.



# Communications capability? Clare puts you in control

In any area of the electrical/electronic disciplines, Clare capability can put you in control. In communications facilities—on land, at sea, or in aerospace. In productive process control, or high-speed data processing systems. In instruments, laboratory or industrial, or in aerospace or ground support systems. Contact switching can optimize control systems—wherever long life, high reliability, advanced capability, and maximum economy are needed. Let Clare put you in control.

C. P. Clare & Co.—worldwide.



Clare contact switching... for optimty in

Industrial Process Control   Electronic Data Processing   Aerospace and Ground Support   Communications   Instrumentation



ON READER-SERVICE CARD CIRCLE 21

# These 14 New Devices Make RCA

# the Triac Leader of the Industry

Now, RCA offers you the industry's broadest line of Triacs, with an unmatched choice of ratings and triggering characteristics in space-saving packages ... all at truly economical prices! Triacs are today's most modern, effective component for ac phase-control and load switching. Because they can perform the functions of two SCR's, Triacs make possible new economies in full-wave power circuit design and cost for industrial and commercial applications.

So for efficient, inexpensive solid-state control of motors, lighting, and heating, look to RCA, the Triac Leader. Your RCA Sales Representative will be happy to give you more details, including price and delivery. Also, ask him about RCA's complete line of SCR's. For additional technical data, write RCA Commercial Engineering, Section RG7, Harrison, N.J. 07029. See your RCA Distributor for his price and delivery.

\*Priced in quantities of 1,000 and up.

Current Rating $I_T$ (rms)	Low Voltage (100V)	120V Line (200V)	240V Line (400V)	Package
2.5A ( $I_{GT} = 3 \text{ mA max}$ )	40525	40526	40527	modified 3-lead TO-5
2.5A ( $I_{GT} = 10 \text{ mA max}$ )	40528	40529	40530	modified 3-lead TO-5
6A		40429	40430	TO-66
6A		40485	40486	modified 2-lead TO-5
6A		40431 (with integral trigger)	40432	modified 2-lead TO-5
15A		TA2834	TA2835	TO-66

RCA Electronic Components and Devices



The Most Trusted Name in Electronics

ON READER-SERVICE CARD CIRCLE 22



### Sensitive-Gate Triacs under \$1.00\*

Extremely high gate sensitivity...rms (on-state) current = 2.5A...and a price level that makes possible a new generation of controls for small appliances, induction motors, and sensing circuits. Maximum gate sensitivities of 3 mA or 10 mA are actually many times greater than that of conventional Triacs! This means simplified triggering circuits and reduced component costs. The 100V versions (40525 and 40528) sell for \$0.95\*; the 200V types (40526 and 40529) are priced at \$0.98\*; and the 400V units (40527 and 40530) are available at \$1.40\*!

### 6A Triacs in 2-lead TO-5 to Control up to 1440 Watts

With the new 40485 and 40486 6A Triacs, RCA doesn't have to use an expensive press-fit package to control a lot of power. Both types employ the low-cost TO-5 case which can be easily mounted on heat spreaders using mass produced pre-punched parts and batch soldering techniques for improved heat-sinking ability. The 40485 sells for only \$1.50\* and controls 720 watts. The 40486 can control 1440 watts and sells for \$1.98\*. And reliability is assured with surge current protection up to 100A!

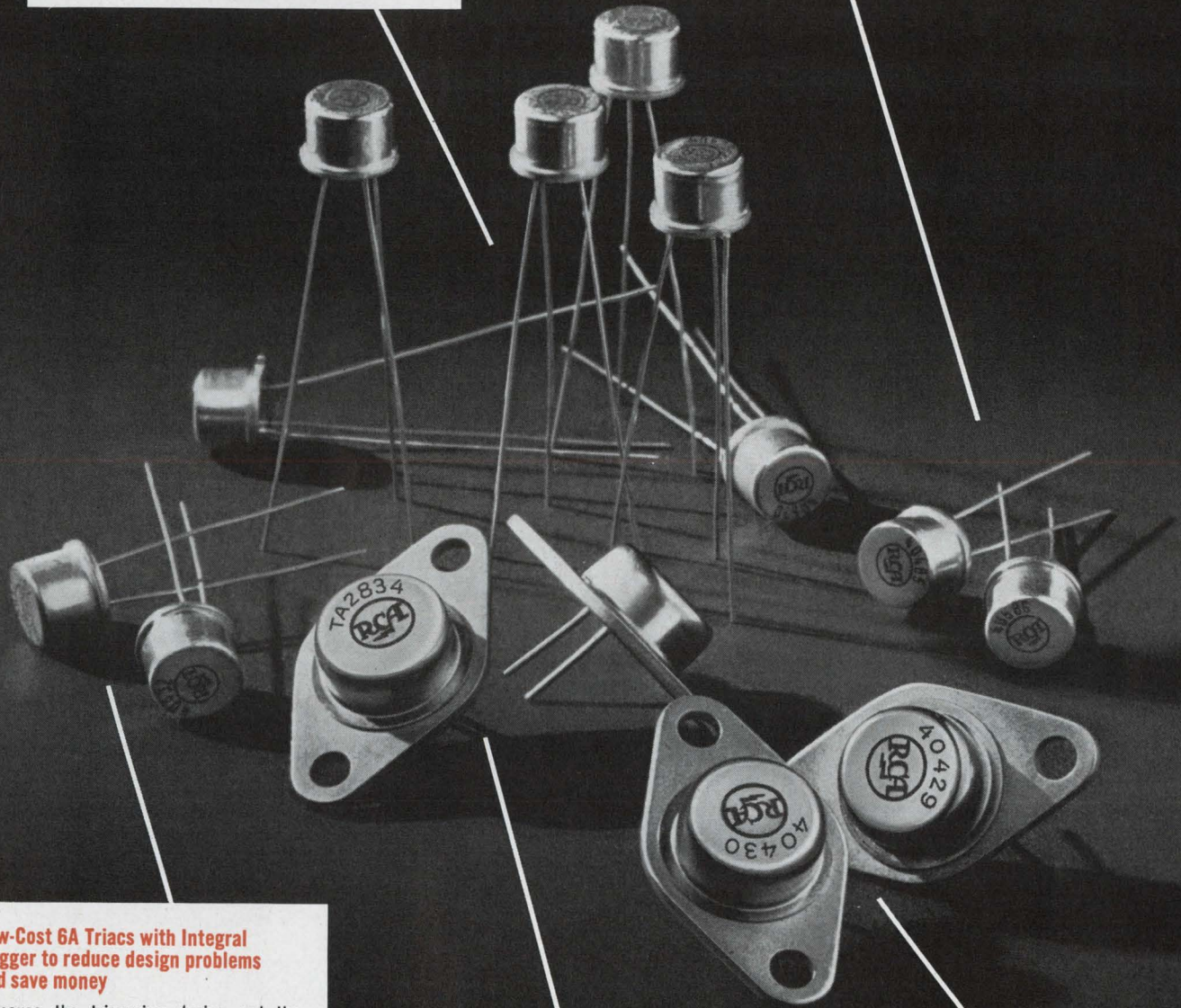

### Low-Cost 6A Triacs with Integral Trigger to reduce design problems and save money

Because the triggering device and the firing characteristics of the 40431 and 40432 Triacs are coordinated inside a compact TO-5 case, you don't have to worry about designing in additional triggering components. You benefit further from reduced circuit and assembly costs, plus improved packaging densities! So if your ac-load control circuits require a trigger, why not have it built-in for you? The 40431 controls 720 watts at 120V and costs \$1.80\*; the 40432 controls 1440 watts at 240V and costs only \$2.48\*.

### 15A Triacs for Load Control up to 3600W

RCA developmental types TA2834 and TA2835 Triacs extend solid-state control way up into the kilowatt range. These powerful TO-66 units have surge current protection up to 100A, plus all of the other design benefits of RCA's lower current Triacs. Possible applications include power supplies, heating controls, motor drivers, and many other industrial and commercial usages.

### 6A Triacs in Popular TO-66 Package

Need full-wave control of up to 1440 watts in a TO-66 package? RCA 40429 and 40430 Triacs are your answer... they feature high gate sensitivity, symmetrical triggering characteristics ( $I_{GT} = 25 \text{ mA max}$ ), and surge current protection up to 80A. The 200V 40429 costs \$1.50\*, the 400V 40430 only \$1.98\*.

(MIT display, continued)

rates compatible with the low input bandwidth of the telephone line. Speed requirements on the electronics are reported quite modest.

The electronics package accepts serial binary signal trains of commands and data and uses them to program internal vector and symbol generators. These generators provide vertical and horizontal deflection voltages for the CRT.

The display uses two binary rate multipliers to draw lines. By intensification of the beam after each step, a series of closely spaced dots is formed. This is seen as a constant intensity line.

MIT investigators used unconventional techniques for pulse integration and analog-to-digital conversion. Pulses produced by each multiplier are shaped to have a constant amplitude and duration and are then fed to an operational amplifier connected as an integrator. The polarity of the pulses is controlled in accordance with the sign of the vector component. The resulting amplifier output is said to produce to the same discrete-step characteristics as the up-down

counter and digital-to-analog converter combination used in more expensive displays.

Picture elements are constructed by connecting straight lines end-to-end. In so-called vector command, the incremental vector lengths are defined as 11-bit numbers (10 for magnitude, 1 for sign) that are loaded into horizontal and vertical registers. The information stored in these registers programs the binary-rate multiplier to produce synchronized, incremental x and y pulse trains. The pulse trains are fed into the operational amplifiers, where they are integrated and cause the CRT beam to trace out the desired line.

**Matrix maintains intensity**

For characters, a pair of counters step the beam through a matrix pattern, and a diode memory holds the specific intensity patterns for each symbol. This action causes the CRT beam to blank and unblank as it moves through the matrix. The initial positioning for the first symbol in a line of text is established by a previous set point, permitting full flexibility in choosing symbol locations.

A 7-by-9-dot matrix was chosen to display the 94 printable symbols of the standard code. A 96-word, 63-bit read-only memory for the symbol patterns was used. It is a 6720-bit diode matrix array on a single integrated-circuit chip.

Data transmission is in the form of fixed length characters with "stop" and "start" bits to insure continuous synchronization between source and receiver.

Lines can be placed on the cathode ray tube by means of the "mouse," a hand-held box moved around the screen. The mouse controls the position of a pointer or "cursor" that directs the electronics to give visible, but not stored visual, indications.

Wheels attached to potentiometers move with the motion of the mouse. Signals from the potentiometers are resolved into voltages that deflect the CRT beam. When the operator is satisfied that he would like to record the lines, he pushes a button. The vertical and horizontal components of the cursor's position are then digitized and sent to the computer. The program interprets the position values as either end points for drawing or location points for displayed data. ■ ■

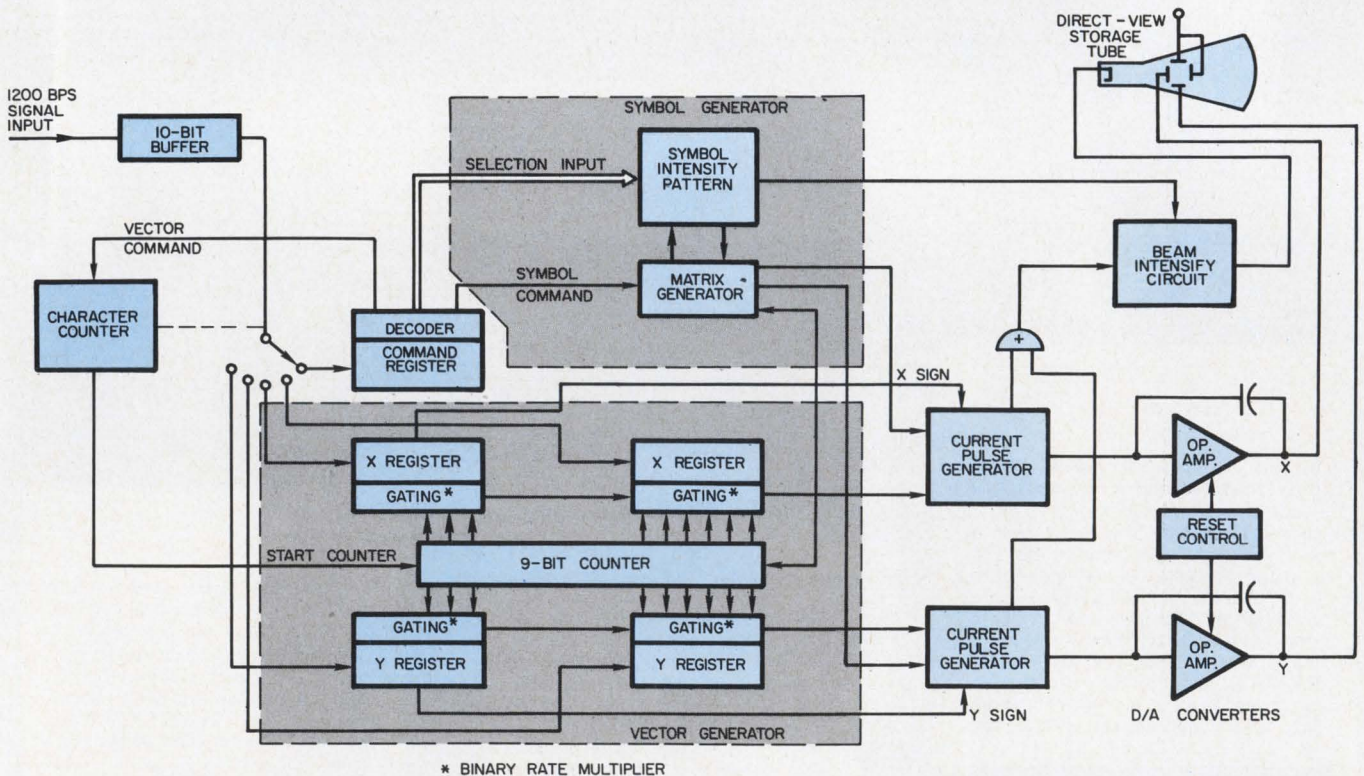

MIT advanced remote display station is a prototype unit to demonstrate low-cost image storage techniques for appli-

cation to utility time-sharing systems. It can send and receive both alphanumeric and drawings.



## Nearly everything that flies... flies with Cutler-Hammer power relays!

You've made us Number One. And we thank you.

For years, you've been buying more Cutler-Hammer power relays for your airborne projects than anybody else's.

Probably because our relays combine the utmost in small size, light weight and resistance to severe environmental conditions.

Now, we'd like to tactfully remind you that more and more of your fellow engineers are using our relays in ground support as well. And in ordnance and shipboard electronics, too.

Like in the tank above, and in trucks, radar, power systems and fire-control systems.

We're delighted. But not surprised. Because the relays are very much the same.

Same proved reliability under severe environmental conditions. Same in-process inspection and rigid quality control.

On your next project—ground, marine or airborne—specify Cutler-Hammer power relays. Call our local stocking distributor, or write for new Catalog LL-292-L217



Typical of Cutler-Hammer's full line are these 25-, 50-, and 100-amp hermetically sealed power relays (front), our new 175-amp hermetically sealed generator contactor, and a 400-amp environmentally sealed relay.

**Switch**  
**to No. 1**

More than just products:  
prompt availability,  
field help, innovation,  
quality assurance too.

  
**CUTLER-HAMMER**  
Milwaukee, Wisconsin 53201



# Precision

## Precision trimmers in all 4 popular styles

### RECTANGULAR

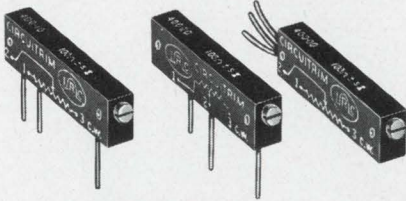

Series 400. Wirewound RT-12 case size with one extra model having staggered RT-11 P.C. pin placement for direct, space savings substitution.

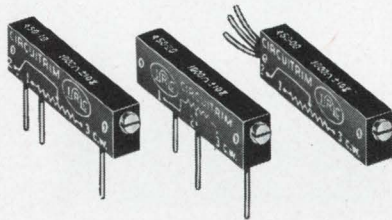

Series 450. Metal Glaze element provides essentially infinite resolution output. RJ-12 size to MIL-R-22097 requirements. Resistance values from 50Ω to 1 Meg. Standard tolerance is ±10% with 20% available for cost-saving applications.

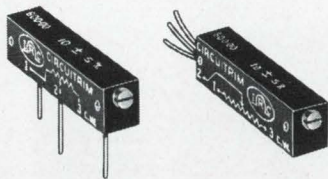

Series 600. RT-11 case size. Wirewound stability and military quality at industrial prices. Well-sealed lightweight diallyl phthalate case.

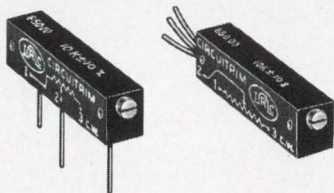

NEW Series 650. Metal Glaze resistive element built to MIL-R-22097, Characteristic C capability. ±250ppm/°C over range of 100Ω to 10K.

### ½-INCH SQUARE

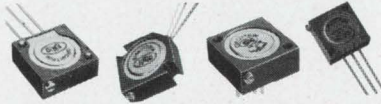

Series 205. Standard wirewound units for high quality industrial needs or all four RT-22 styles. Built, tested and marked to MIL-R-27208 specifications.



Series 251. RJ-22 styles. Metal Glaze infinite resolution from 100Ω to 1 Meg. Offered in ±5, 10 and 20% tolerances to provide exact performance requirements.

### ½-INCH ROUND



Series 100. Largest ½" round selection in the industry. Well-sealed for critical industrial or military use. Single turn, positive stops. Long (0.9") winding provides superior resolution and closer settings.



Series 150. Metal Glaze companion to wirewound model 100 above. Available in same configurations. 100Ω to 1 Meg. with choice of ±5, 10 and 20% tolerances.

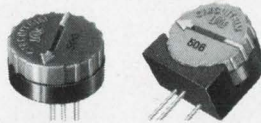

NEW Series 500. Most economical for commercial and industrial use. Two most popular adjustment and mounting configurations. Best wirewound resolution at lowest price.

### MINIATURE 5/16" CUBE

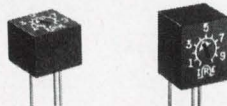

Series 300 wirewound and 350 Metal Glaze provide space savings in all P. C. board applications. Panel mount also available.

### PANEL MOUNTING

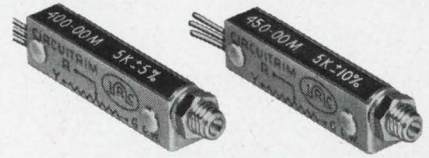

For wirewound Series 400 and Metal Glaze Series 450

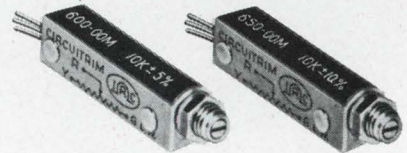

For wirewound Series 600 and Metal Glaze Series 650



For ½" square series

For ½" round series

For 5/16" cube series

### SINGLE TURN ROTARY

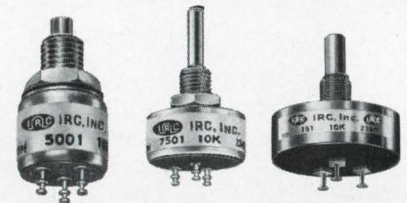

Sturdy metal-cased units for severe environmental conditions. Wirewound stability and ±5% resistance tolerance. Excellent linearity for close setting of comparison and control instrumentation.

Mod.	Case Diam.	Res. Range (Ω)	Power @40°C	Linearity
5001	½"	10 to 50K	2 W	±5%
7501	¾"	50 to 50K	2½ W	±1%
151	1½"	100 to 100K	3½ W	±0.5%

### MOUNTING VARIATIONS

IRC offers hundreds of different terminals, terminations, mounting variations and adjustments. Unique in the industry, they provide economy and unequalled design flexibility.

# Potentiometers

## Precision multi-turns for all applications

### LOW-COST COMMERCIAL/INDUSTRIAL



High performance and long life at lowest cost. 10 turns,  $\frac{7}{8}$ " diameter with only  $\frac{1}{8}$ " behind the panel. 2 watts @ 25°C., derates to zero @ 105°C. 100Ω to 100K, with all popular intermediate values.  $\pm 5\%$  tolerance and  $\pm 0.25\%$  linearity. Side terminals accept to #14 wire. Model 8400 has  $\frac{3}{8}$ "-32 bushing,  $\frac{1}{4}$ " shaft. Model 8500 has  $\frac{1}{4}$ "-32 bushing,  $\frac{1}{8}$ " shaft.



Model 7300 has 100 oz.-in. patented stop system and space-saving rear terminals. 10 turns, 2 watts @ 40°C., derates to zero @ 85°C. 100Ω to 100K.  $\pm 5\%$  tolerance,  $\pm 0.25\%$  linearity.

### MINIATURE HIGH PERFORMANCE



Industry's only  $\frac{1}{2}$ " metal-cased multi-turn trimmer with 100 oz.-in. stop system and  $\frac{1}{4}$ " diameter shaft. Maintains settings to  $\pm 0.1\%$  under severe shock and vibration. Rear terminals for closest packaging. Many shaft and bushing variations.

Model 5000: 10 turns, 1.5 watts, 25Ω to 100K.  $\pm 5\%$  tolerance

Model 5005: 5 turns, 1.0 watt, 15Ω to 50K.  $\pm 5\%$  tolerance

### METAL-CASED STANDARD PRECISION

IRC's exclusive line of metal-cased multi-turn potentiometers offer rugged protection and superior shielding. Field tested and approved in every phase of the electronics industry, their case sizes and power handling capabilities are based on widely accepted standards for good design and packaging. Hermetically sealed, panel sealed and moisture sealed versions are also available.



Model	Case Dia.	Turns	Resistance Range (Ω)	Linearity Std. (±)	Power @ 40°C
7500	$\frac{3}{4}$ "	10	50 to 250K	0.5%	3 W
7505	$\frac{3}{4}$ "	5	25 to 125K	0.5%	2 W
1000	1"	10	500 to 250K	0.5%	3 W
1005	1"	5	250 to 125K	0.5%	2 W
1215	1"	15	500 to 450K	0.1%	4 W
1220	1"	20	750 to 600K	0.1%	5 W

Standard tolerance:  $\pm 5\%$ . Temperature range: -55°C to 125°C. Closer tolerances and linearity available.

### RUGGED STOP MECHANISM

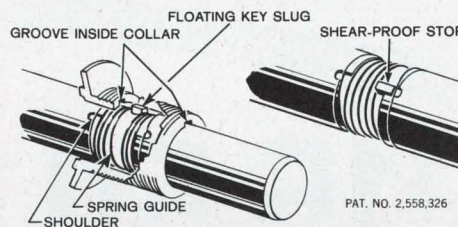

Electrical and mechanical functions of IRC metal-cased multi-turns are separate. Positive 100 oz.-in. patented stop mechanism in the shaft and bushing prevents damage to internal parts and catastrophic failure. The wiper contact assembly is relieved of stopping action. This assures setting accuracy, stability and long rotational life.

### REVODEx DIALS ELIMINATE READING ERRORS

IRC has a full line of turns counting dials for use with 3, 5, 10 and 15 turn potentiometers. Only 1 inch in diameter, they fit  $\frac{1}{4}$ -inch and  $\frac{5}{16}$ -inch diameter shafts. Choice of black or clear anodized aluminum finish.

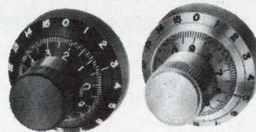

• Easy reading—angular surface gives maximum numeral size. Primary and secondary scale.

- Full range—000 to 999 to indicate up to 10 full turns (to 1499 for 15 turns).
- Accurate reading—reproducible to one part in a thousand. Can estimate to a fraction of a thousandth.
- Easy mounting—set-screwed directly to potentiometer shaft, there is no backlash and no need for extra panel holes.
- Long life—tested to 250,000 cycles with no appreciable wear.

WRITE FOR NEW PRECISION POTENTIOMETER CATALOG



IRC, Inc., 401 N. Broad St., Phila., Pa. 19108

ON READER-SERVICE CARD CIRCLE 24

(use time delay relays?)  
**CHECK AEMCO PRICES!**

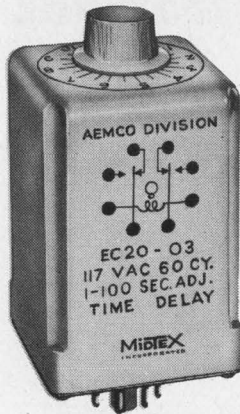

**NEW!**

**electronic reliability**

**\$17.50**

(1-24 quantity)

**ELECTRONIC RELIABILITY**  
 ±5% REPEAT ACCURACY

**1-100 SECOND ADJUSTABLE DELAY**  
 PLUG-IN CONVENIENCE

**DPDT OUTPUT RATED 10 A.**  
 LOW PRICE! QUANTITY DISCOUNTS!

Budget priced with plug-in convenience where critical timing parameters are not required. Delay adjusted by convenient single knob. Remote adjustment by use of external potentiometer (special order). 117 VAC input. DPDT output rated 10 A. AEMCO type EC.

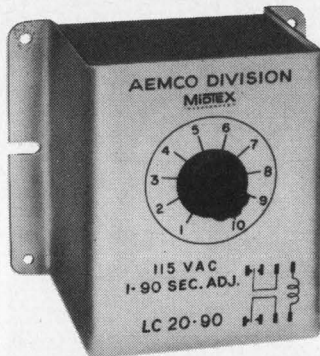

**REPLACES MOTOR TYPES**

**\$15.50**

(1-24 quantity)

**ELECTRONIC RELIABILITY**  
 REPLACES POPULAR MOTOR TYPES

**±5% REPEAT ACCURACY**  
 1-90 SECOND ADJUSTABLE DELAY

**DPDT OUTPUT RATED 10 A.**  
 LOW PRICE! QUANTITY DISCOUNTS!

Packaged to directly replace all popular motor type time delay relays... far more reliable than motor types. Budget priced—real savings when critical timing parameters are not required. 117 VAC input. DPDT rated 10 A. AEMCO type LC.

**NEED SPECIALS? Other packaging? Longer timing ranges? Other voltages? DC? Remote adjustment? Write or call outlining your needs. We're eager to serve you, too!**

**AEMCO DIVISION**

MANKATO, MINNESOTA 56001  
 formerly TELEX/AEMCO  
 PHONE A/C 507-388-6286



ON READER-SERVICE CARD CIRCLE 25

NEWS

**Laser cane helps blind avoid objects**

An experimental "seeing-eye cane" that uses pulsed laser beams to guide blind persons around objects has been developed by scientists at RCA Laboratories in Princeton, N. J.

Infrared laser beams from two gallium-arsenide diodes embedded in the cane are continuously reflected from two points—three and six feet—in front of the cane back to two built-in photoelectric cells.

The cells activate two pins in the cane handle, and the pins vibrate continuously in the user's hand.

The sudden intrusion of an obstacle in front of the cane scatters the laser beams and interrupts the vibration, thereby alerting the user.

The cane weighs less than 5 pounds and can be operated for 10 hours before its 1/2-C-size batteries must be recharged. Each diode has a peak output of 5 watts and is pulsed 20 times a second.

RCA says it is investigating an advanced version that would use an array of diodes to generate laser beams. An array of detectors would see only the return from the laser in the corresponding array position. The user would, in effect, be provided with a contour map of the area ahead of him. ■ ■

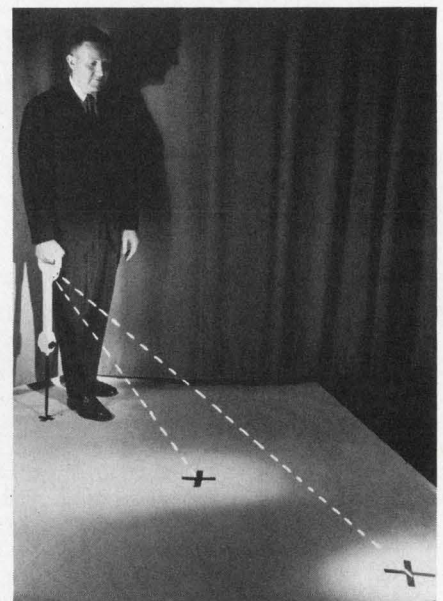

Experimental laser cane for the blind sends out two beams (dotted lines) three and six feet ahead of the user.

ON READER-SERVICE CARD CIRCLE 26 >

# We're all set to double-Cross you.

[and you'll love it.]



**We've doubled our plant and manufacturing facilities. So you can hand us twice as many of those tough jobs... or tough jobs twice the size. We mean the ones where you want zero defects. Which Cross promises and delivers.**

For instance, molybdenum and tungsten rolled down to  $\pm .0001$ " on a production run. Or rhenium tungsten, rhenium moly, columbium, zirconium, titanium, copper, nickel, alloys and other metals rolled to  $\pm .00005$ ". You name it . . . you've got it.

Cross has built its business by handling the tough jobs that had to be perfect. So pile your ribbon and strip problems on us . . . big, medium or small. *Challenge us with your close tolerance requirements. We're twice as ready as before to roll right over them.*

# H.CROSS

COMPANY

This **NEW G-V**

**QUICK  
CONNECT**

**THERMAL  
TIMING RELAY...**

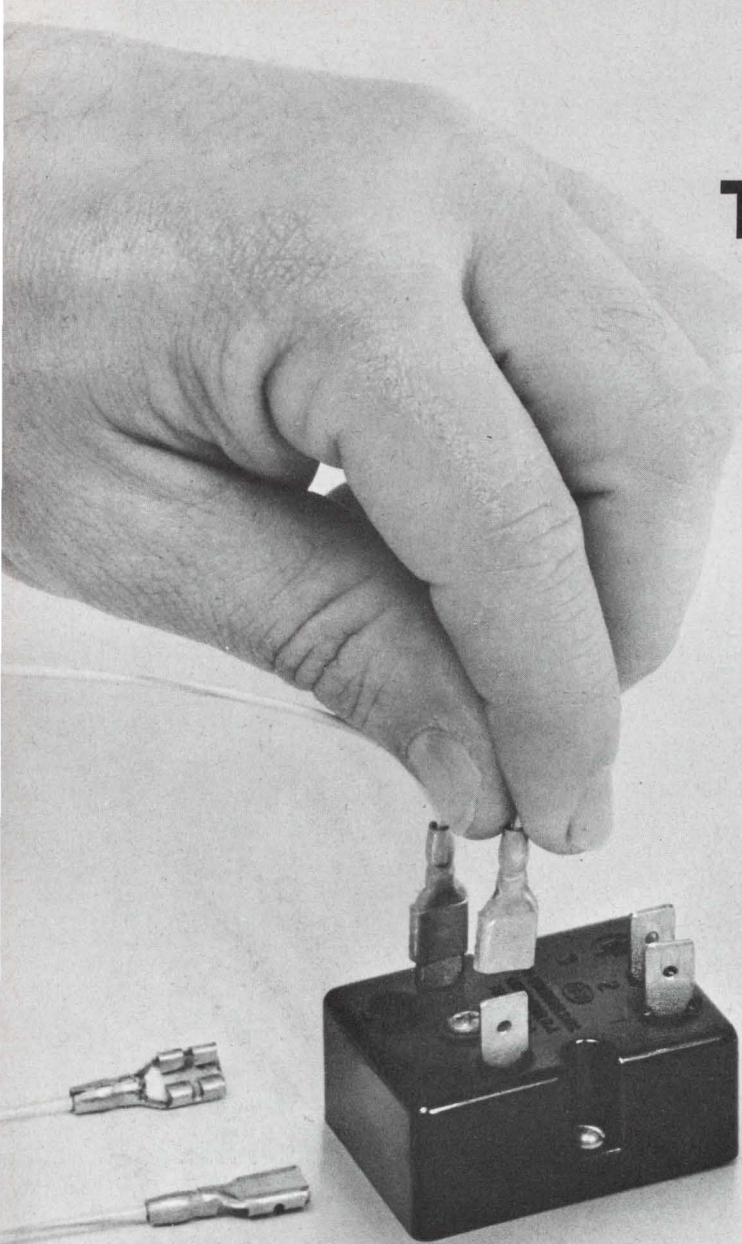

**THERMAL TIMING RELAY**  
For PC board mounting

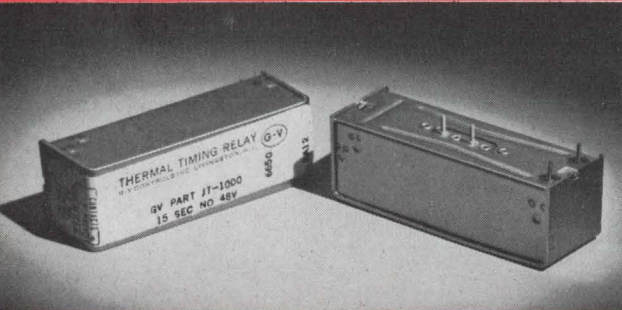

The JT Series is the only thermal relay designed to mount directly on pc boards without need for adapters or sockets. This design conserves space, reduces weight, allows greater packaging densities for pcb's. **Features:** time delays, 2 to 180 sec.; contacts, SPST, NO or NC; heater voltages, 6.3 to 230V. AC or DC; temperature compensated; operates in any position.

only from **G-V**

On Reader Service Card Circle 210

**SUBMINIATURE THERMAL  
TIMING RELAYS**

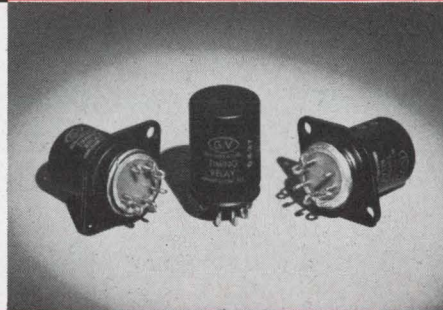

The LT Series relays provide hi-level performance in a subminiature hermetically sealed housing — space saving without loss of performance. Meets military standards. **Features:** height above mounting panel 40% of standard relays (7 pin flange mount); time delays, 2 to 75 sec.; operating temp.,  $-65^{\circ}\text{C}$  to  $\pm 85^{\circ}\text{C}$ ; operating voltages, 6.3 to 115V. AC or DC.

**G-V**

On Reader Service Card Circle 211

**HIGH PRECISION THERMAL  
RELAYS**

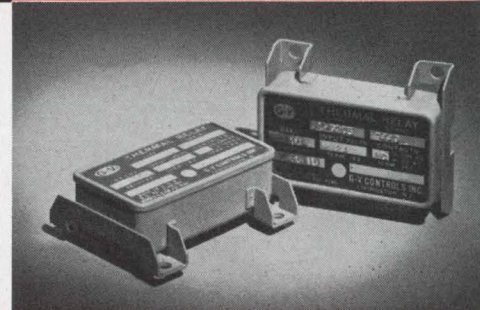

The PT Series relays provide the most precise performance available in thermal relays. Meet the exacting military requirements for reliability under extreme operating environments. **Features:**  $\pm 5\%$  tolerance over a temp. range of  $-55^{\circ}\text{C}$  to  $+125^{\circ}\text{C}$ ; 2000 Hz vibration; 50g shock; time delays, 3 to 180 sec.; heater voltages, 6.3, 28 and 115V. AC or DC.

only from **G-V**

On Reader Service Card Circle 212



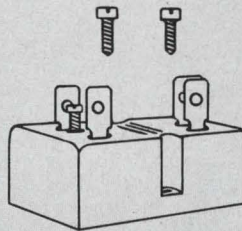

• Underwriters  
Laboratories,  
Inc. Listed

# reduces installation time and cost!

**NEW PACKAGING FEATURES EASY MOUNTING . . .**  
**PUSH-ON TERMINALS . . .** *it's from G-V*

The new G-V Quick Connect Thermal Timing Relays are rugged and versatile enough to withstand the most demanding industrial applications. They are a low cost series designed to reduce installation time and cost. Only two mounting screws are necessary, eliminating the need for special brackets, sockets or retainers. Push-on terminals provide flexibility of wiring, part location and equipment servicing. A dust-tight molded phenolic case houses a stainless structure with nickel-chromium heater winding, assuring long life and dependable service. The low profile Quick Connect thermal timing relays can be mounted in any position. Specifications include: Contacts, SPST, NO, NC; Resistive Rating, 2 amps 115V AC or 1 amp 28V DC; Heater Voltage, 6.3, 26, 115V AC or DC; Time Delays, 5-180 seconds; Time Delay Tolerance,  $\pm 20\%$ ; Heater Power,  $2\frac{1}{2}$  Watts, nominal. Suitable for continuous operation to 160°F. Ambient compensated.



**G-V CONTROLS INC.**

LIVINGSTON, NEW JERSEY 07039  
(201) 992-6200

On Reader Service Card Circle 216

## THERMETTE 9 PIN RELAY



Metal enclosed thermal time delay is dust proof and shatter proof — designed for industrial applications requiring reliable operation and long life. **Features:** temp. compensated; time delays, 2 to 180 sec.; heater voltages, 6.3, 26, and 115V. AC or DC; contacts, SPST, NO or NC.

• Underwriters Laboratories, Inc. Listed



On Reader Service Card Circle 213

## INSTANT RESET THERMAL TIMING DEVICES



Instant reset during or after timing is available by combining G-V's unique instant reset timing element with a magnetic relay. Widely used in communication systems and data processing equipment. **Features:** delay time, 2 sec. to 5 min.; ambient operating temp., 32°F to 185°F.

only from 

On Reader Service Card Circle 214

## DIRECT-LINE FIELD ENGINEERING SERVICE



G-V assistance is always available to help you design and produce a better product. G-V Regional Field Engineers in your area will assist you and your design group in new applications and proper selection of your controls. G-V Product Engineers will help you with special applications. When you require experience, products and services in electro-mechanical and solid-state controls . . . call your man from G-V.



On Reader Service Card Circle 215

Lack of panel space  
causing headaches?

Try the new MINISWITCH<sup>®</sup>  
by Digitran — for fast relief

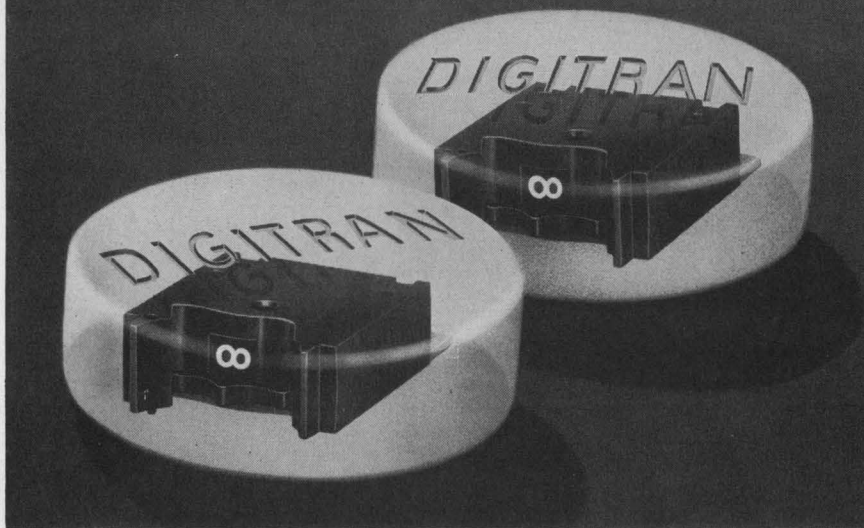

© TRADEMARK

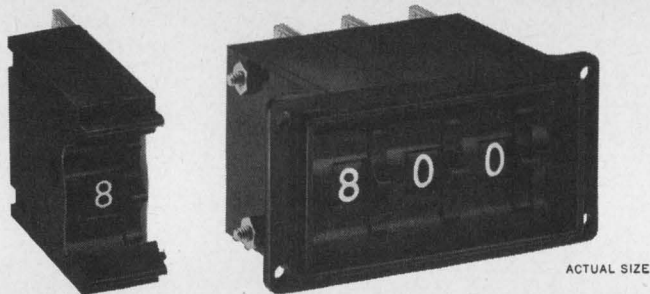

### The New 800 Series Miniswitch ...the smallest thumbwheel switch available

The Series 800 Miniswitch is specifically designed for instruments, controls or systems where panel space is limited. Each module requires an opening of .96" high x .5" wide. Any number of modules may be ganged into a single unitized assembly. Spacers are available for functional separation. Large, white dial numbers are set in a non-glare black background for easy reading.

**Features include:** Two, 8 or 10-position setting dials—direct conversion of dial position to 4-bit coded outputs. Provision for component mounting in output terminals on some models. **NEW—5 or 28 volt replaceable lighting**—any color—requires no solder or tools to replace lamps. Send for new Miniswitch Series 800 data sheet.

### THE DIGITRAN COMPANY



855 South Arroyo Parkway, Pasadena, California  
Phone: 213/449-3110

ON READER-SERVICE CARD CIRCLE 27

## Rain data array aids microwave studies

An unusual measuring system that provides practically instantaneous data on the density and distribution of rainfall is reported by Bell Telephone Laboratories, Inc.

Studies have shown that rain in the path of a microwave beam may scatter and attenuate the signals, particularly in the 10- to 100-GHz region.

Bell engineers have set up an array of 100 continuously measuring rainfall-rate gauges distributed in a 50-square-mile area surrounding the company's Crawford Hill Laboratory at Holmdel, N. J.

In each rain gauge, rainfall is funneled into an inclined channel

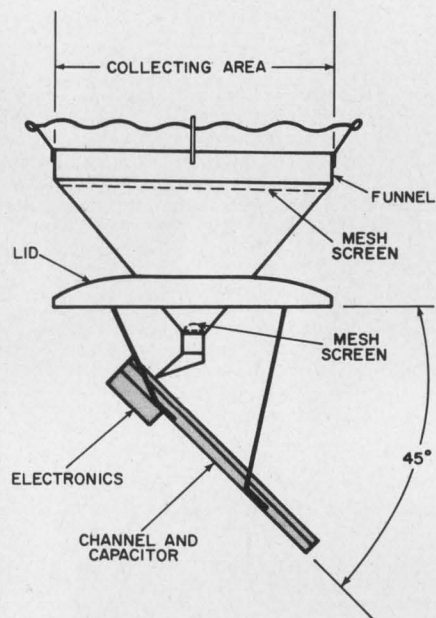

that runs between the electrodes of a capacitor. Changes in the volume of flow are measured by the capacitor, which in turn causes variations in the frequency of a signal produced by an oscillator on a telephone line. The 12-inch-long capacitor flow meter, with a signal-producing electronic package attached, is able to sense and measure rapidly rain activity from the first drop to rates in excess of 10 inches per hour. The information from the gauges is transmitted over telephone lines to recording equipment at the Crawford Laboratory for analysis. ■ ■

ON READER-SERVICE CARD CIRCLE 28 ➤

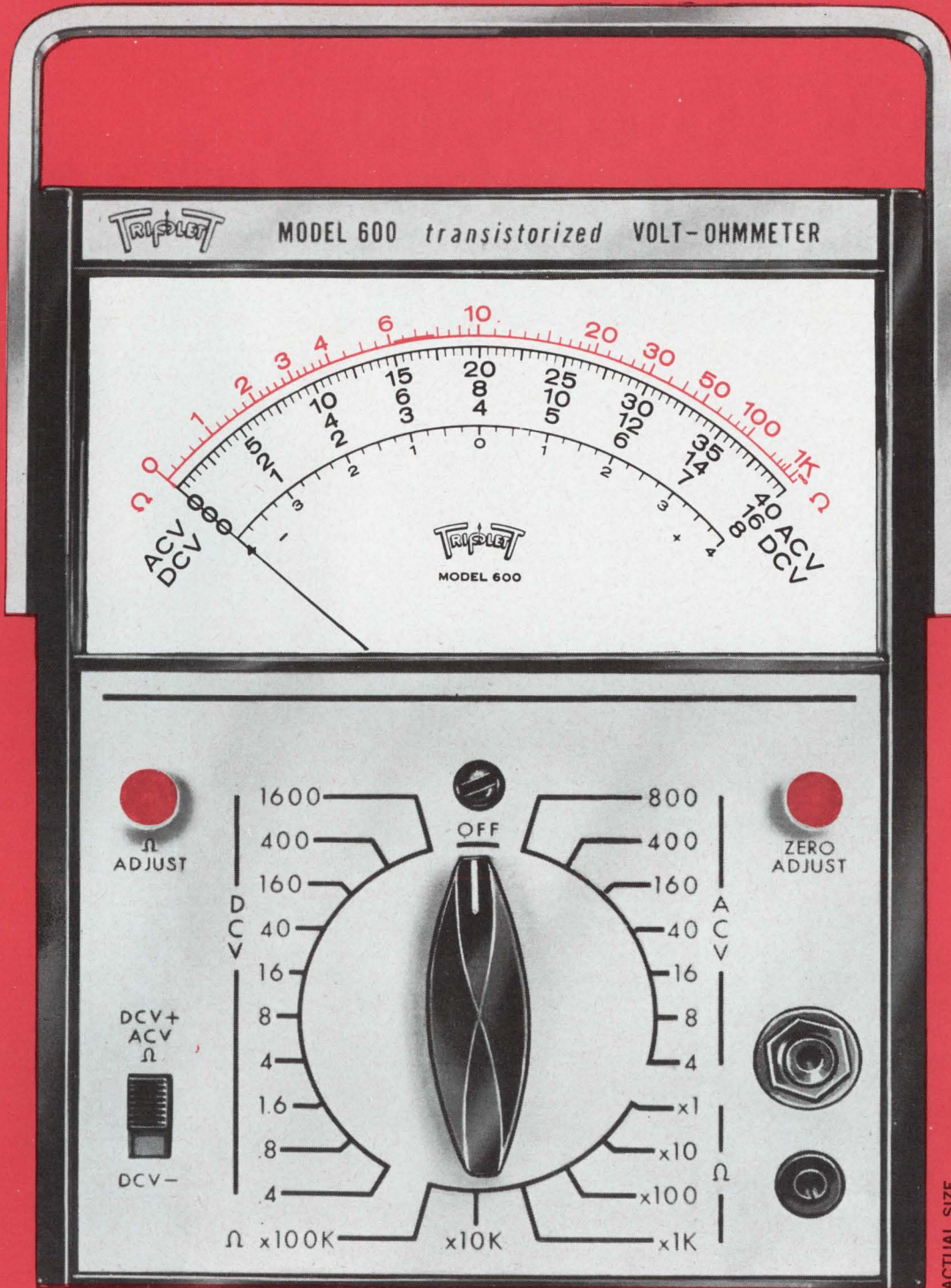

ACTUAL SIZE

# NEW SOLID STATE VOLT-OHMMETER

1. F-E-T Circuitry—Battery Operated with 11 Megohm Input Impedance (Field Effect Transistor).
2. 400 DC MV range at 2.7 Megohm Impedance for Solid State circuit testing.
3. One Selector Switch with 23 ranges plus a Polarity Reversing Switch.



Model 600 on stand handle leather case, \$14.00

Model 600 TVO  
(Transistorized Volt-Ohmmeter)

**\$78**

Suggested U.S.A. User Net  
Available Now At Your  
Local Distributor

# TRIPLET

ELECTRICAL INSTRUMENT COMPANY  
BLUFFTON, OHIO

# How to avoid the Accountant's "evil eye."



Simple—save him \$6,000 with the S-1.

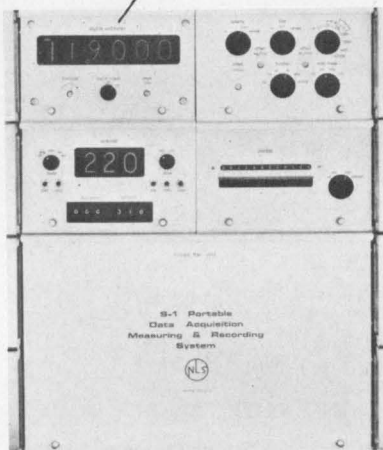

Yes, buy any other Data Acquisition System with the S-1's capability and you'll pay at least \$6,000 more. Only the S-1 offers this combination of functions and features for \$9,950. The S-1 was designed to satisfy the exacting requirements of systems engineers, and at the same time keep the grimmest budget watcher happy.

## BASIC S-1 RECORDER

**Inputs**  
200 Channels  
DC Volts

AC Volts  
Resistance  
Ratio  
All in 21" high package

## FEATURES

Multifunction Measurement Capability  
Small/Compact/Portable  
Integrated Circuit Construction  
Guarded 3-Wire Inputs  
Superior Signal Mode Rejection  
120 db Common Mode Rejection  
.001% Resolution  
.005% Accuracy

.0002% Temperature Stability  
1 Microvolt to 1000 Volts  
Automatic Function &  
Range Selection  
Active Filter

## ADDITIONAL OPTIONS

High Speed Printer  
Magnetic Tape  
Punch Paper Tape  
IBM Paper Tape  
IBM Punch Cards  
Flexwriter  
Typewriter  
Digital Clock

ON READER-SERVICE CARD CIRCLE 101



Originator of the Digital Voltmeter  
**NON-LINEAR SYSTEMS, INC.**  
DEL MAR, CALIFORNIA 92014

# DYNAMIC DUO!

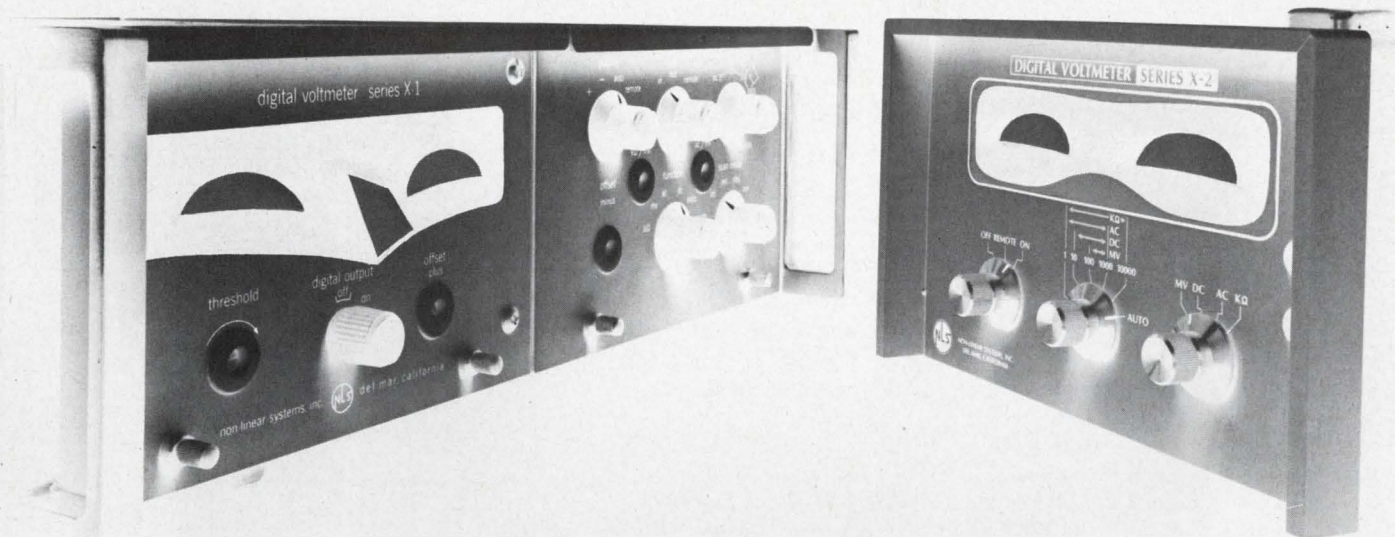

- X-2:** *Holy Accuracy, X-1, how do you do it? . . .*
- X-1:** Fear not, X-2, if you don't become a college dropout, you too, can achieve .005% Accuracy.
- X-2:** *You were designed to compete with those \$4,000 voltmeters, but I've got IC's.*
- X-1:** When I was in school, X-2, those IC's were costly and unavailable; however, with all your IC's, you can't give 23 millisecond readings!
- X-2:** *Well, X-1, I haven't had my logic courses yet. Can you integrate?*
- X-1:** I don't need to integrate, X-2, because I have an Active Filter that saves customers (who think they need a 5-digit integrator) \$1,700.
- X-2:** *You got me there, X-1, but if the customers don't need your .005% accuracy and high speed for \$2,450, they can buy me for \$980, and I'm half rack size too!*
- X-1:** Naturally, you're half rack size because you don't have Scan Counter, Range Memory, Range Hysteresis, Range and Polarity memory logic, and my Exclusive Threshold control.
- X-2:** *Holy features, X-1! Those other DVM's must be overpriced!*
- X-1:** We must not cast moral judgments on the integrity of our competition, X-2.
- X-2:** *You're such a good teacher, X-1 . . .*
- X-1:** Remember, X-2, that together, that is, you at \$980, and me at \$2,450, can conquer 80% of the requirements in DVM city.

**Next month** — Will the Joker win out? **See X-3.**



**NON-LINEAR SYSTEMS, INC.**  
DEL MAR, CALIFORNIA 92014  
[714] 755-1134/TWX: 910-322-1132

# Letters

## Pole-zero cancellation: analysis is expanded

Sir:

I read with interest your description of the pole-zero cancellation used by Thomas Emmen of Ortec to prevent baseline weave following RC differentiation of an exponential pulse [see "Computers, ICs help physicists probe nature," ED 6, March 15, 1967, pp. 42-48]. This technique is indeed quite worth while and permits spectral measurements to be made at high counting rates.

I believe the first time this technique was used was in a nuclear pulse amplifier, which I designed and described at the San Diego, Calif., meeting of the IEEE Nuclear Science Group in the fall of 1963. This was published in the January, 1964, issue of the *IEEE Transactions on Nuclear Science* ["Gamma Amplifier-Discriminator," Vol. NS-11, No. 1, pp. 323-328], although the mathematics was not described at that time. My amplifier is different [from Emmen's] in that I use delay-line pulse-shaping instead of RC shaping. Figure 1 shows the RC circuit which you described; Fig. 2 shows my delay-line circuit. In both circuits a fraction of the input signal is added to the shaped output signal.

The following analysis develops the mathematical description of this circuit and shows that proper setting for the potentiometer is a function of the delay-line loss,  $\alpha$ , and the ratio of the two time constants involved.

### Time period I: $t < T_2$

Analysis of the circuit is done in two time regions. The conditions for the first are shown in Fig. 2. Here  $t < T_2$ , where  $T_2$  is the two-way transit time of the delay line. Since the input of the amplifier is a virtual ground:

$$e_2(t) = e_1(t) \left[ \frac{R_0(2R_0)/(R_0 + 2R_0)}{2R_0 + [R_0(2R_0)/(R_0 + 2R_0)]} \right]$$

$$\begin{aligned} &= e_1(t)/4; \\ i_3(t) &= e_1(t)/4R_0; \\ i_1(t) &= e_1(t)/8R_0; \\ i_2(t) &= Ke_1(t)/R_2; \\ e_0(t) &= -R_F[i_1(t) + i_2(t)] \\ &= -R_F e_1(t) [1/8R_0 + K/R_2] \\ &= [-R_F/8R_0] [e_1(t) \{1 + [K/R_2/8R_0]\}]. \end{aligned}$$

Note that if  $K = 0$ , or the cancellation circuit is removed, this last expression reduces to:

$$e_0 = -(R_F/8R_0)e_1,$$

which is the usual value.

It should be observed that in the time interval  $t < T_2$ , the shape of the pulse is not changed.

### Time period II: $t \geq T_2$

When the signal has propagated down the line and hit the shorted end, it inverts and propagates back up the line with a total loss of  $\alpha$ . Thus, after  $t = T_2$  (Fig. 3):

$$\begin{aligned} i_3(t) &= -\alpha i_3(t - T_2)u(t - T_2) \\ &= [-\alpha e_1(t - T_2)/4R_0]u(t - T_2). \end{aligned}$$

Half of this current goes back to the source, so that the portion that joins  $i_1(t)$  is:

$$[-\alpha e_1(t - T_2)/8R_0]u(t - T_2).$$

The output of the amplifier is now:

$$\begin{aligned} e_0(t) &= -R_F \{ [e_1(t)/8R_0] \\ &\quad + [Ke_1(t)/R_2] \\ &\quad - [\alpha e_1(t - T_2)/8R_0]u(t - T_2) \}. \end{aligned}$$

In a nuclear-pulse-amplifier application, the signal  $e_1(t)$  is of the form:

$$e_1(t) = E_1 e^{-t/T_1}.$$

Thus:

$$\begin{aligned} e_0(t) &= [(-R_F E_1)/8R_0] \{ \epsilon^{-t/T_1} \\ &\quad + (8R_0 K/R_2) \epsilon^{-t/T_1} \\ &\quad - \alpha \exp[-(t - T_2)/T_1] \} \\ &= [(-R_F E_1)/8R_0] \epsilon^{-t/T_1} [1 \\ &\quad + (8R_0 K/R_2) - \alpha \epsilon^{T_2/T_1}]. \end{aligned}$$

For perfect baseline cancellation, (continued on p. 54)

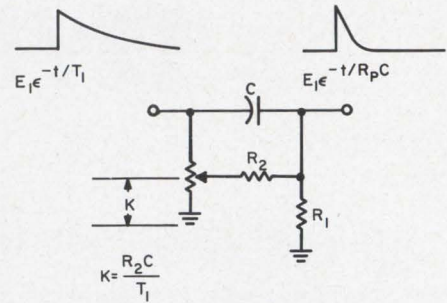

1. RC compensation brings the output signal to zero quickly in a pulse-counting system so that amplitudes of succeeding pulses are accurately indicated.

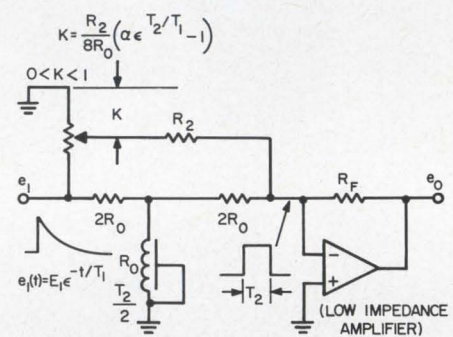

2. Delay-line pulse-shaping accomplishes a similar function to RC compensation. Note that  $T_2$  is the two-way transit time through the line. This circuit shows conditions for  $t < T_2$ .

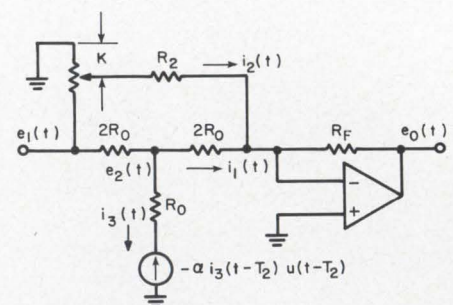

3. Equivalent circuit for  $t \geq T_2$ .

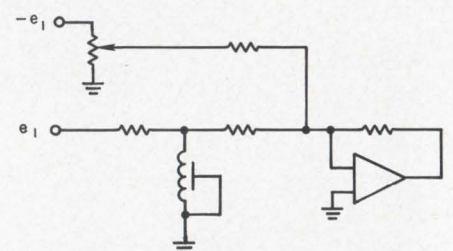

4. Inverted compensation scheme.

## RECORD DATA IN INK ON Z-FOLD PAPER AND READ IT LIKE A BOOK

The new Hewlett-Packard 7850 Series Rectilinear Fluid-Process Recorder produces ultra-clear traces on Z-fold paper or rolls. The numbered Z-fold pages offer more convenient access to recorded data. Contactless pen tip sensing and a low-pressure ink system produce traces of constant width throughout the recorder's

variable speed ranges of .025 to 200 mm. per second. Designed with modular, solid-state electronics, the 7850 Series Recorder provides high-resolution, permanent, rectilinear recording of up to eight variables from dc to 160 Hz.

A wide selection of 8800 Series Preamplifiers provides signal conditioning to the driver-amplifiers which drive the recording pens of the recorder.

The 7850 Series system includes a preamplifier power supply, a driver amplifier power supply and a cabinet to house the complete unit. The frequency response of the recorder is 160 Hz for 10 div p-p deflection and 60 Hertz maximum for full scale deflection. Maximum ac or dc non-linearity is 0.5% full scale. Additional features include: 14 electrically-con-

trolled chart speeds; built-in paper take-up; low ink supply warning light; plug-in ink supply cartridge that may be replaced while the recorder is in operation and complete modular construction of all components for easy maintenance:

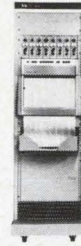

For complete information on the 7850 system, optional and related equipment, contact your local HP Field Office or write Hewlett-Packard Company, 175 Wyman St., Waltham, Mass. 02154.

HEWLETT  PACKARD

17701

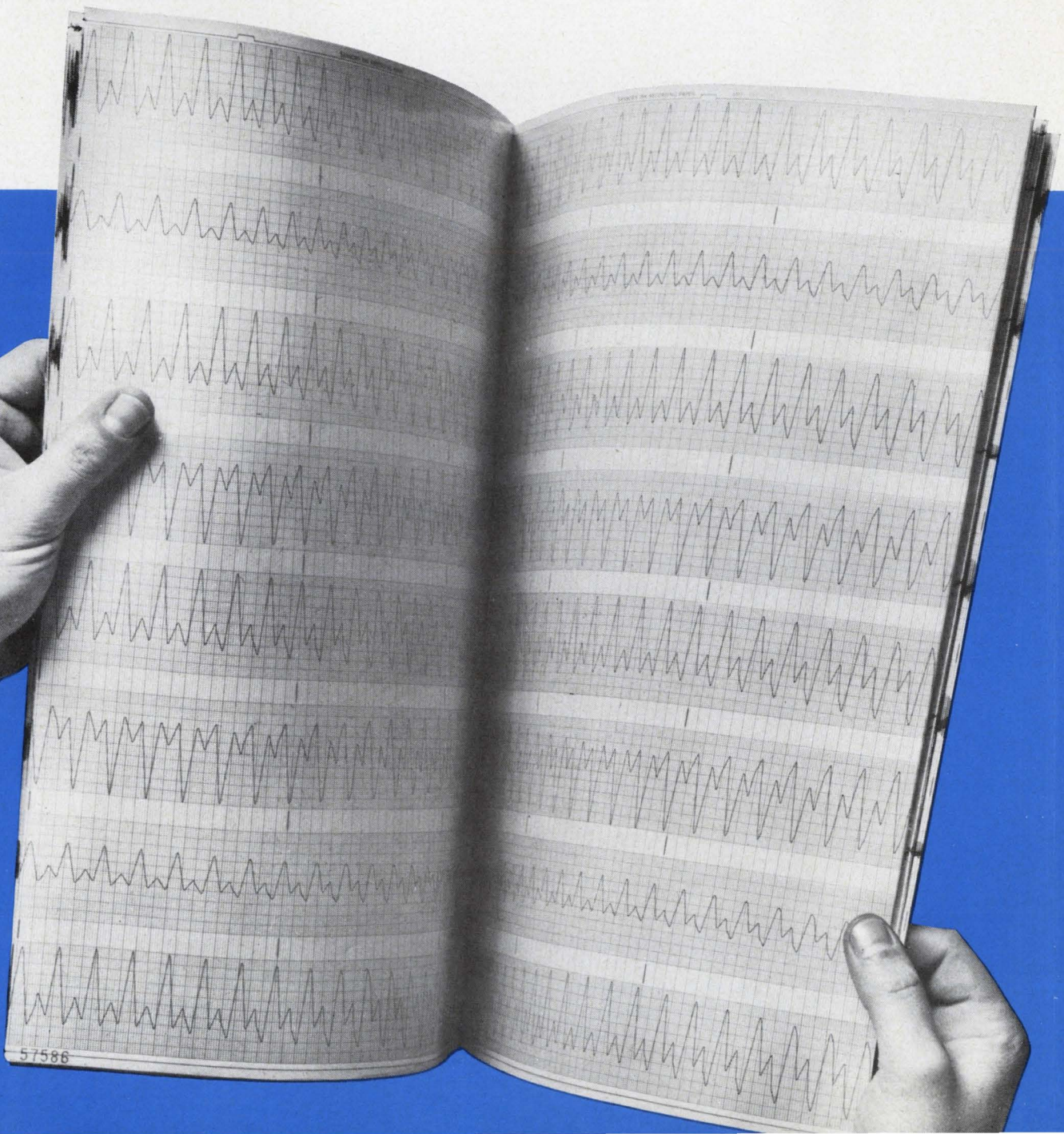

57586

# INTRODUCING THE LATEST IN A GREAT LINE OF 1 MHz CAPACITANCE BRIDGES

**NEW  
EVEN  
HIGHER  
RESOLUTION**



**IDEAL FOR SEMICONDUCTORS**

## MODEL 75D

New 3-terminal bridge provides exceptionally high resolution measurements of capacitance and loss down to extremely low values. Designed to ultimately replace the popular Boonton 75A and 75B series, the Model 75D contains many refinements adding to its accuracy, convenience of operation, and versatility.

- Capacitance measurements to 1000 pF; basic accuracy, 0.25%; resolution, 0.00005 pF
- Conductance measurements from 0.01  $\mu\text{mho}$  to 1000  $\mu\text{mhos}$ , or resistance measurements from 1000  $\Omega$  to 100 M $\Omega$ ; basic accuracy, 5%
- Effective inductance measurements from 25  $\mu\text{H}$  to  $\infty$
- Phase sensitive detector permits capacitance or inductance measurements independent of loss
- Accurate measurements of extremely low Q devices
- Ultra-high capacitance resolution with low test signal levels
- Remote measurements via coaxial cables
- Internal dc bias; dual external bias
- Provision for differential or comparison measurements
- Completely self-contained, including bridge circuitry, crystal controlled 1 MHz oscillator, and both amplitude sensitive and phase sensitive detectors.
- Price: \$1595, fob, Parsippany, N. J.

Write for complete technical data

**BOONTON  
ELECTRONICS**  
CORPORATION

ROUTE 287  
PARSIPPANY, N.J. 07054  
Telephone: 201-887-5110  
TWX: 710-986-8241

ON READER-SERVICE CARD CIRCLE 31

## LETTERS

(continued from p. 52)

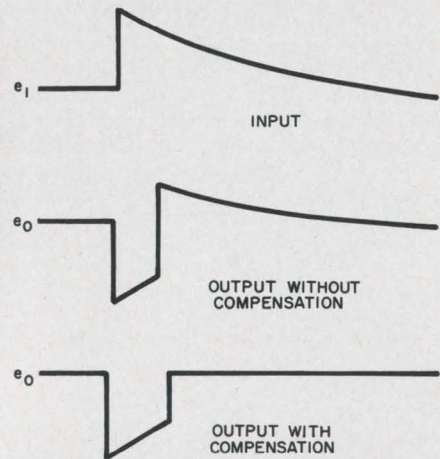

5. **Waveshapes** with and without compensation. Note the slow exponential return to zero of the output when no compensation is used.

this voltage should be zero. This can be accomplished if:

$$1 + 8R_0 K/R_2 = \alpha \epsilon^{T_2/T_1};$$

that is to say, if:

$$K = (R_2/8R_0)(\alpha \epsilon^{T_2/T_1} - 1).$$

It can be seen that the amount of compensation required depends on the line loss,  $\alpha$ , and on the ratio of  $T_2/T_1$ , the clipping time to the decay time of the input signal.

If the line is very lossy, or if the input decay time is very long, it may be necessary to apply an inverted signal to the compensating potentiometer, as shown in Fig. 4. This signal can usually be obtained within the preceding amplifier stage and does not have to be of the same amplitude.

Waveshapes of the input and the output with and without compensation are shown in Fig. 5.

(This work was performed under the auspices of the U.S. Atomic Energy Commission.)

Curtis Sewell, Jr.

University of California  
Lawrence Radiation Laboratory  
Livermore, Calif.

## Lf neutralizing circuit has to be corrected

Sir:

Figure 1 of our article on stabilizing power tubes ["Stabilize power tubes at uhf and vhf," ED 10,

(continued on p. 56)

ON READER-SERVICE CARD CIRCLE 32 ➤



# This is the lighted pushbutton switch with aerospace quality at commercial prices!

The MSC Series 12 Lighted Pushbutton Switch embodies aerospace quality and engineering features that reduce installation costs, increase performance and simplify maintenance . . . yet it is priced to compete with commercial grade units. Compare the features listed below. From the exclusive Twist/Lock front end removal that permits easy lamp, legend or color filter change without tools (and without the hazard of accidental switching during replacement), to the internally bussed common ground lamp circuits that cut installation time and costs by reducing solder connections, you'll find better features for better performance. You'll discover why the Series 12 has been specified for computers, data processing equipment,

industrial controls and commercial equipment where dependable, long-term performance is the prime consideration. You'll pay no more. Why settle for less?

## GET THE 20-PAGE CATALOG 2001

It details all of the many options offered by the versatile MSC Series 12 to solve any switching problem. Use the reader service card or write on your letterhead for an operating demonstration by your regional MSC specialist . . . in your office!

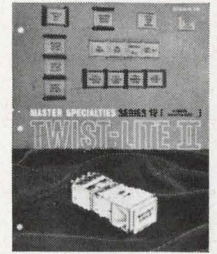

## Series 12

### TWIST-LITE® II LIGHTED PUSHBUTTON SWITCH

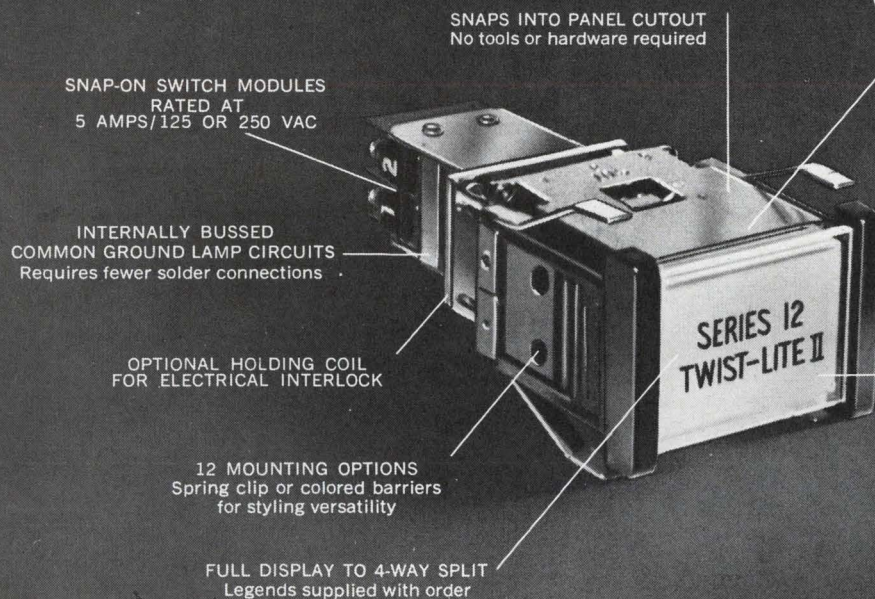

SNAP-ON SWITCH MODULES  
RATED AT  
5 AMPS/125 OR 250 VAC

INTERNALLY BUSSED  
COMMON GROUND LAMP CIRCUITS  
Requires fewer solder connections

OPTIONAL HOLDING COIL  
FOR ELECTRICAL INTERLOCK

12 MOUNTING OPTIONS  
Spring clip or colored barriers  
for styling versatility

FULL DISPLAY TO 4-WAY SPLIT  
Legends supplied with order

SNAPS INTO PANEL CUTOUT  
No tools or hardware required

COMPLETELY REMOVABLE  
FRONT-END ASSEMBLY  
Will not actuate switch  
when replaced.

4-LAMP  
VERSATILITY

INDIVIDUAL  
COLOR CONTROL

SILICONE RUBBER  
COLOR FILTERS  
for uniform light  
intensity and disbursement



EXCLUSIVE FRONT  
RELAMPING  
with Twist/Lock safety  
No tools required.

# Master Specialties Company



25 YEARS IN INFORMATION DISPLAY AND CONTROL DEVICES

# MSC

MASTER SPECIALTIES COMPANY 1640 MONROVIA • COSTA MESA • CALIFORNIA 92627 • (714) 642-2427 • TELEX 6-78433.

Regional Offices: Huntsville, Ala. (205) 536-7415 • Costa Mesa, Calif. (714) 642-0114 • Sunnyvale, Calif. (408) 245-9292 • Winter Park, Florida (305) 647-0100 • Chicago, Ill. (312) 282-7112 • Waltham, Mass. (617) 893-1020 • Haddonfield, N.J. (609) 428-0701 • Syracuse, N.Y. (315) 479-9191 • Valley Stream, L.I., N.Y. (516) 561-2334 • Cleveland, Ohio (216) 851-9700 • Dallas, Texas (214) 357-9459 • Houston, Texas (713) 228-2294 • Seattle, Wash. (206) 546-5161.

Also available from distributor stock at AVNET ELECTRONICS

WESTBURY, LONG ISLAND, NEW YORK • (516) 333-5800

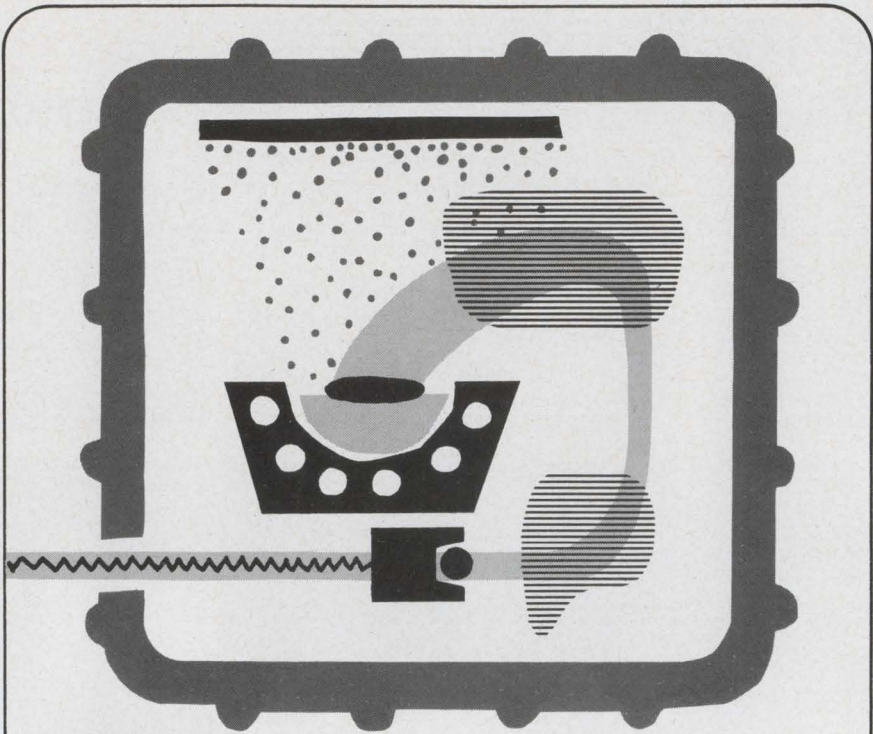

## LOOK WHAT'S HAPPENED TO HIGH-VACUUM EVAPORATION

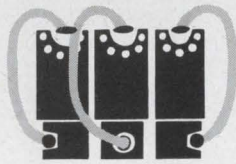
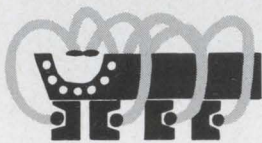

### YOU CAN NOW...

- Deflect electron beams 270° to put the emitter out of the range of evaporants and falling particles.
- Focus bent electron beams of 2 to 150 KW power with pinpoint accuracy.
- Operate electron-beam guns at peak efficiency for periods of 75 or more hours.
- Operate several electron-beam guns in one or in different vacuum chambers from a single constant-voltage power supply.
- Depend on electron-beam systems to evaporate or purify metallic and non-metallic substances on a commercial scale at costs competitive with other systems.

If you are using induction or resistance heated sources, or electron-beam gun systems more than two years old, you should read Temescal's new brochure, "The Electron Beam... A New Super Heat Source For Modern Industry." Write or telephone for your copy today. It will help guide you in selecting the system best suited to your operation.



**TEMESCAL**  
METALLURGICAL  
CORPORATION

2850 SEVENTH STREET, BERKELEY, CALIFORNIA 94710 • TELEPHONE (415) 841-5720

ON READER-SERVICE CARD CIRCLE 33

## LETTERS

(continued from p. 54)

May 10, 1967, p. 64] is incorrect. Your reader's comment that a solder dot is missing is not the error, however.

It is not desirable to tie the coil center tap directly to the capacitor center tap. Very seldom are the components so well balanced that the zero potential points actually are at the center. It is better to ground the capacitor center tap and feed the center of the coil with a choke. This allows the coil to move its zero potential point where the circuit wants it to be. All these comments are for the general case. Sometimes more ingenuity is required with this part of the circuit to suppress a parasitic. The correct diagram for our article is printed below.

Please note that there is an error in the grid circuit as well. There is no dc return to the control grid, as shown in the published article. This correction, too, has been incorporated in the revised circuit diagram.

We certainly apologize for the erroneous diagram we submitted and for any inconvenience this may have caused.

Robert I. Sutherland

Supervisor

EIMAC, Div. of Varian Associates  
San Carlos, Calif.

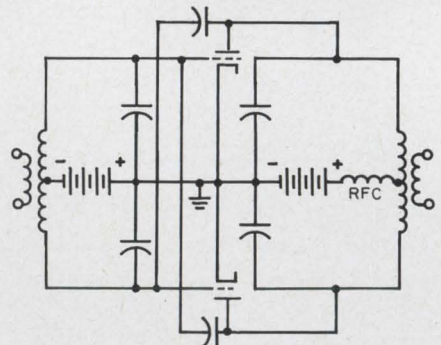

**Typical neutralizing circuit for  $I_f$**  is a version of a capacitance bridge. This circuit corrects errors in the schematic published in ED 10, May 10.

### Accuracy is our policy

In "Coupling circuit has dc dead zone," in the Ideas for Design section of ED 10, May 10, 1967, p. 96, there is an error in Fig. c. A solder dot should provide connection between  $B+$  and  $R1$ ,  $R2$  and  $R3$ .

ELECTRONIC DESIGN 14, July 5, 1967

# Here's how to save a ton of money building your own Linear Circuit:

- 1** Start with Fairchild's  $\mu$ A709C monolithic, high-performance, high-gain, differential amplifier. It's an off-the-shelf integrated circuit especially designed for industrial applications. It costs less than \$5.00 in quantities of 10,000, less than \$6.00 in 1,000 quantities, and only \$6.60 if you buy 100. Yet it offers high performance to a degree which allows you to use it in instrumentation applications.
- 2** Modify the  $\mu$ A709C to meet your exact requirements. It's simple. Just add a capacitor or a resistor or two. With every order of 25 units or more\* we'll include a free Linear Applications Handbook that shows you exactly how. And the  $\mu$ A709C is versatile enough to perform virtually any function. (For a partial list of what you can use it for, see below.)
- 3** Count your savings. Even if you spend another \$5.00 on auxiliary parts and assembly (and in most cases you'll spend far less) your total cost will be about half of what you'd pay for a ready-made circuit. Multiplied by 10,000 units that adds up to a ton of money.
- 4** Get started. Get the  $\mu$ A709C. It's readily available from shelf stock. Just call your Fairchild Distributor or the nearest Fairchild Sales Office.

\*In fact, this offer is good for orders of 25 or more of any Fairchild linear integrated circuit.

## Typical Characteristics $\mu$ A709C

(@  $T_A = 25^\circ\text{C}$ ;  $V = \pm 15\text{V}$ )

Open Loop Voltage Gain .....	45,000
Output Voltage Swing .....	$\pm 14\text{V}$ @ $R_L = 10\text{k}\Omega$
Input Voltage Range .....	$\pm 10\text{V}$
Input Resistance .....	250k $\Omega$
Input Offset Voltage .....	2mV
Input Offset Current .....	200nA

## Typical Applications:

PRECISION VOLTAGE SUPPLIES	HIGH $Z_{IN}$ TRANSDUCER AMPLIFIER
TEMPERATURE CONTROLLER	DELAY EQUALIZER
DIFFERENTIAL THRESHOLD COMPARATOR	CONSTANT CURRENT SOURCE
PREAMPLIFIERS	ADDER/SUBTRACTOR
HIGH GAIN, LOW DRIFT DC AMPLIFIER	METER AMPLIFIER
LOGARITHMIC AMPLIFIER	SAMPLE AND HOLD AMPLIFIER
MULTIPLIER	SWEEP GENERATOR
QUADRATURE OSCILLATOR	CURRENT TO VOLTAGE CONVERTER
PRECISION ANALOG GATE	NULL DETECTOR
SOLID STATE MOD/DEMODO	SIGNAL POLARITY SEPARATOR
PHASE DETECTOR	CLIPPER
ONE-SHOT MULTIVIBRATOR	SAWTOOTH GENERATOR
ASTABLE MULTIVIBRATOR	FREQUENCY METER
SINE WAVE OSCILLATOR	A TO D CONVERTERS
HALFWAVE RECTIFIER	GAIN CONTROL AMPLIFIERS
PEAK DETECTOR	HYSTERESIS COMPARATOR
FULLWAVE RECTIFIER	INTEGRATOR (DC OR AC)
PEAK TO PEAK DETECTOR	LEAD AMPLIFIER
BRIDGE AMPLIFIER	
DIFFERENTIATOR	
ACTIVE FILTER	
UNITY-GAIN BUFFER	

**FAIRCHILD**  
SEMICONDUCTOR

Write for detailed applications information.

# narda SOLVES YOUR **Peak Power** PROBLEMS — With less Equipment, Time and Expense and Improved Accuracy

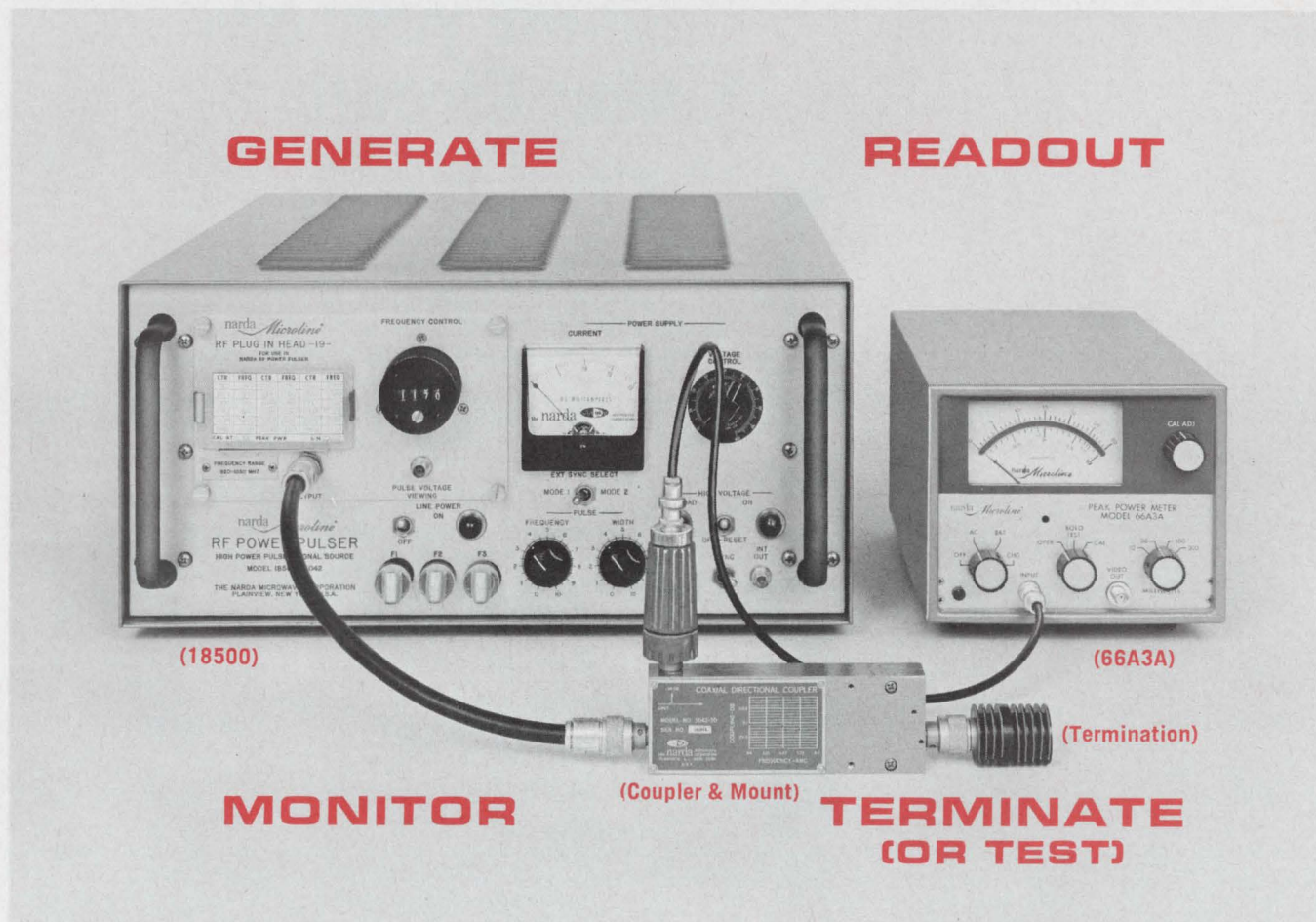

Narda's total capability for power measurements can satisfy any system or component test requirement with catalog test devices. This means convenience and economy to you. Give us your problem and we will help you solve it with a complete measuring set-up. The above peak power measurement set-up shows one of Narda's answers to a measurement problem.

#### NARDA MICROLINE 18500 RF POWER PULSER

- From 200 to 9500 MHz with 11 plug-in- r-f heads
- Continuously variable peak power to 5 KW depending on r-f heads
- Internal pulse generator
- Variable pulse width from .25 to 6.0,  $\mu$ sec depending on r-f head
- Continuously variable PRF from 150 to 4000 pps built-in DC to 4000 pps external
- External pulse viewing capability
- Multipulse capability

#### NEWLY IMPROVED PEAK POWER METER 66A3A — 33B3 BOLOMETER MOUNT

- New shielding effectiveness now permits power meter operation in high Peak Power environments
- Peak power output read **directly** from 0 to 300 mw. over frequency range of 0.5 to 12.4 GHz with Narda bolometer mounts
- Accuracy of  $\pm 5\%$  of full scale
- Transistorized, battery-operated, immediately operative
- Calibration accuracy of Narda bolometer mounts traceable to NBS

#### MAXIMALLY FLAT COAXIAL COUPLER — 3040 SERIES

- Frequency: from 0.125 to 12.4 GHz
- Flatness:  $\pm 0.2$  db over octave ranges
- Directivity: 20 DB
- Coupling: 10, 20, 30 db values (special on request) calibrated and permanently marked at 5 frequencies

#### MEDIUM POWER COAXIAL TERMINATIONS 370 SERIES

- Cover entire frequency range of DC to 12.4 GHz
- Power levels up to 40 watts average
- Small, lightweight — low cost

Call our factory or local representative for demonstration of this system or its catalog components.

narda *Microline*<sup>®</sup>

THE NARDA MICROWAVE CORPORATION • PLAINVIEW, L.I., NEW YORK 11803

516 - 433 - 9000 • TWX: 510 - 221 - 1867 • CABLE: NARDACORP PLAINVIEW NEWYORK

ON READER-SERVICE CARD CIRCLE 35

**Co-Publishers**

James S. Mulholland, Jr.  
Robert E. Ahrensford

**Editorial Director**

Edward E. Grazda

**Editor**

Howard Bierman

**Managing Editor**

Robert C. Haavind

**Technical Editors**

Jeffrey N. Bairstow  
Peter N. Budzilovich  
Maria Dekany  
Roger K. Field

**News Editors**

Ralph Dobriner, Chief  
Richard N. Einhorn

**East Coast Editor**

Neil Sclater

**West Coast Editor**

Ron Gechman

**Copy Editor**

Peter Beales

**New Products Editors**

David H. Surgan  
Daniel R. Butterly

**Directory Editor**

William Alvarez

**Washington Editor**

S. David Pursglove

**Editorial Production**

Dollie S. Viebig  
Karen L. Sherman

**Art Director**

Clifford M. Gardiner

**Art Assistant**

William Kelly

**Technical Illustrators**

Cheh Nam Low  
Sheila F. Ward  
Richard Hartman

**Production Manager**

Thomas V. Sedita

**Asst. Production Manager**

Helen De Polo

**Production Assistants**

Bernard Wolinsky  
Robert M. Henry

**Circulation Manager**

Nancy L. Merritt

**Reader Service**

Diane Mandell

## EDITORIAL



## It isn't the retrieval, it's what you retrieve

The Government has been trying hard to spend money on information retrieval. Too many engineers and scientists working on important projects have complained about the difficulty of obtaining the information they need for the job.

Much of the Government's money has gone to serious-minded scholars who puff on their pipes and contemplate great abstractions. They dream of the day when every library will be stored on a computer and all the computers will be interconnected by satellites, lasers and such. This is pretty safe musing, they realize, for by the time it all becomes reality their own work will have become securely irretrievable.

Fortunately, the Government seems to be changing its tack. Work is being done on a few systems more firmly based on what is feasible now. All the same, we believe the whole focus is on the wrong end of the pipeline.

It is the *input* to the information system that is the bigger problem, not the retrieval.

With some diligence, an engineer can amass quite a pile of material on his problem from libraries, department files and research organizations. But the quality of this material is what's at fault. How much of it really explains the theory clearly; or links the theory to practical possibilities? This kind of immediately useful information is hard to find.

When the authors of a recent theoretical article were asked to write about a real system problem and show how to apply their theory to it, they declined. It would be a monumental task, they said—and, besides, it wasn't covered by their Government contract. Their theoretical triumph is now on the library shelves, and it can be retrieved quite easily by any one of a number of key words. But it won't do systems engineers much good.

Too many books ostensibly written to update engineers keep their readers at bay by crafty tricks: an unexplained symbol or impenetrable technical jargon. Obviously the reader should have taken the same courses as the author (a PhD teaching at a leading engineering school). The sad thing is that often these blocks to understanding could have been removed quickly with a couple of simple sentences or examples.

The information problem won't be solved until engineers and scientists stop tolerating poor communication. Incomprehensibility does not equal brilliance. Only when this is realized will investments in information retrieval begin to pay off.

ROBERT HAAVIND

# New! 100 MHz in a ruggedized oscilloscope with 3.5-ns risetime at the probe tip

DC-to-100-MHz bandwidth at 10 mV/cm  
is NOW AVAILABLE  
in a plug-in oscilloscope  
with solid-state design . . .  
the Tektronix Type 647A and R647A.



**New Type 10A2A Dual Trace Amplifier.** The risetime and bandwidth are specified where you use it — at the probe tip. The vertical system performance with or without the new miniature P6047 10X Attenuator Probe is DC-to-100 MHz bandwidth with 3.5-ns risetime at ambient temperatures of 0° C to +40° C (+32° F to +104° F). Bandwidth is DC-to-90 MHz with 4.1-ns risetime over its entire operating range, -30° C to +65° C. The calibrated vertical deflection range (without probe) is from 10 mV/cm to 20 V/cm.

**Bright Displays.** The Tektronix CRT provides bright displays with its advanced design and 14-kV accelerating potential. It has a 6-by-10 cm viewing area and a no-parallax, illuminated, internal graticule.

**New Type 11B2A Delayed Sweep Time Base.** The Type 11B2A triggers to above 100 MHz internally and provides a calibrated delayed sweep. Calibrated sweep range is from 100 ns/cm to 5 s/cm, extending to 10 ns/cm on both normal and delayed sweeps with X10 magnification. Calibrated sweep delay is from 1 μs to 50 s and the plug-in also provides single sweep operation.

**Rugged Environmental Capabilities.** These instruments are capable of accurate measurements in severe environments and offer an extra margin of dependability and even greater accuracy in normal environments. Temperature: Operating -30° C to +65° C. Non-Operating -55° C to +75° C. Shock: Non-Operating 20 G's max, 2 shocks, each direction, along each of the 3 major axes. Vibration: Operating or Non-Operating 0.025" p-to-p, 10-55-10 Hz, (4 G's) 1 min cycles, 15 min each major axis. Humidity: Non-Operating meets MIL-STD-202B, Method 106A, except freezing and vibration, through 5 cycles (120 hours). Altitude: Operating 15,000 ft. Non-Operating 50,000 ft.

**New Type R647A Rack Mount.** The same DC-to-100 MHz performance also is available in a 7-inch-high rack mount oscilloscope, the Type R647A. Additional plug-ins include the Type 10A1 Differential Amplifier and the Type 11B1 Time Base.

Type 647A Oscilloscope (includes 2-P6047 Probes) . . . . .	\$1500
Type R647A Oscilloscope (includes 2-P6047 Probes) . . . . .	\$1625
Type 11B2A Time Base . . . . .	\$ 850
Type 10A2A Dual Trace Amplifier . . . . .	\$ 775

U. S. Sales Prices FOB Beaverton, Oregon

For complete information, contact your nearby Tektronix Field Engineer or write: Tektronix, Inc., P. O. Box 500, Beaverton, Ore. 97005.



*Environmental testing*



*. . . part of the Tektronix commitment  
to technical excellence*

ON READER-SERVICE CARD CIRCLE 36

# Technology

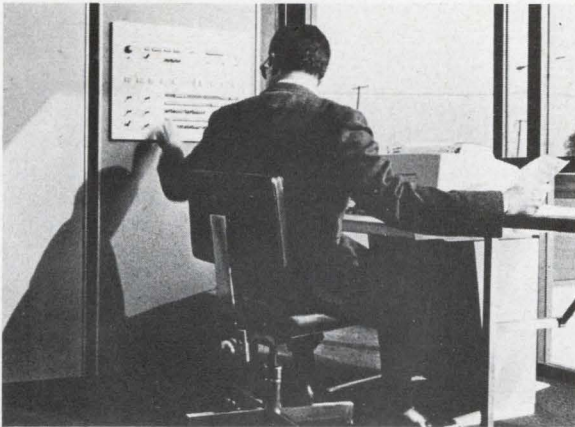

Diode model is analyzed by computer as a single junction of a transistor. Page 80

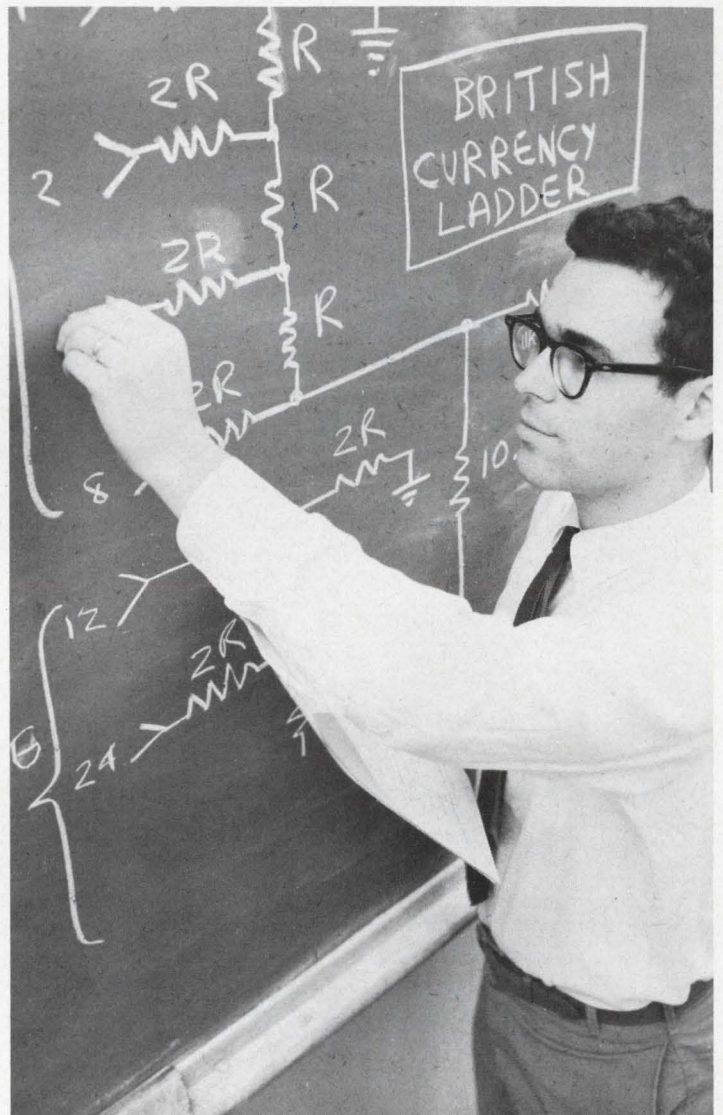

Ladder networks for D/A and A/D converters involve solving only 3 linear equations. Page 68

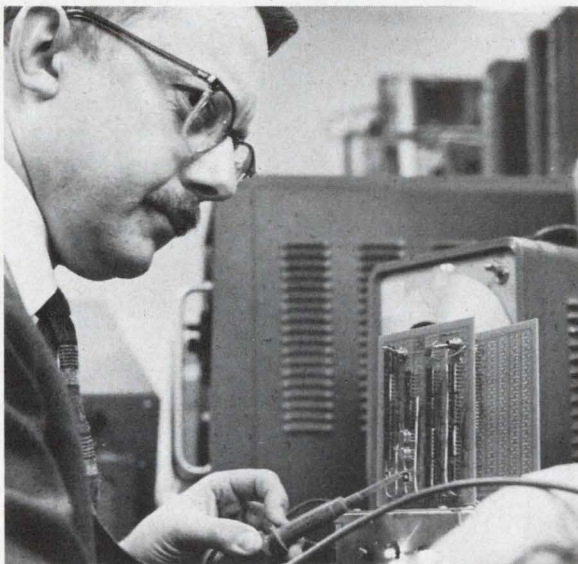

Digital frequency comparators are made with a few flip-flops and gates. Page 62

## Also in this section:

**Resistor-thermistor networks** are easy to synthesize by the direct method. Page 74

**Mismatching for low noise** in amplifiers is a one-step operation with a nomograph. Page 86

**Semiannual index of articles** for January to June, 1967. Page 89

# Make IC digital frequency comparators

with just a few flip-flops and gates. Here are three designs that yield phase and frequency relationships.

Digital integrated logic can be a powerful tool for measuring frequency and phase relationships between two unknown frequencies. Many digital circuits designed for this purpose, however, tell which of the two input signals is higher in frequency, but give no phase information if the frequencies are equal. Others give phase information alone and require the two frequencies to be equal or very nearly so; when the frequencies are far apart, some even give ambiguous results.

Here are three circuits that determine without ambiguity which of two inputs is higher in frequency, and for equal frequencies indicate the signals' relative phases. All three circuits can be designed with just a few integrated components of any logic type.

Figure 1 shows a number of possible pulse trains on the input of the comparator. The three circuits (Figs. 2, 3 and 4) are all logically equivalent; their output is that shown in Fig. 1.

**Hermann Ebenhoch**, Consumer Application Engineer, Fairchild Semiconductor Div., Fairchild Camera and Instrument Corp., Mountain View, Calif.

The output is 0 when  $f_2$  is greater than  $f_1$ ; is 1 when  $f_2$  is less than  $f_1$ ; and switches between 0 and 1 when  $f_2$  equals  $f_1$ . The three conditions of the output are termed high state, phase state, and low state, respectively. The relative widths of the square waves generated by the switching indicate the phase relationship of the two signals.

For the comparator's output to change from the phase state to either the low state or the high state, two or more pulses must impinge on one input before a pulse impinges on the other input. Three or more successive pulses on one channel can change the output from high state to low state or vice versa; while two, and only two, consecutive pulses lead from either of these outer states to the phase state. Thus, when used to match frequencies, the system has built-in error detection: the adjustable frequency must be brought up or down to, and just a shade past, the frequency with which it is matched, to drive the comparator into its phase state.

The first circuit (Fig. 2) uses flip-flop 2 (FF2) as the output. It is allowed to change states only if FF1 is in the 1-state. FF2's output levels are fed

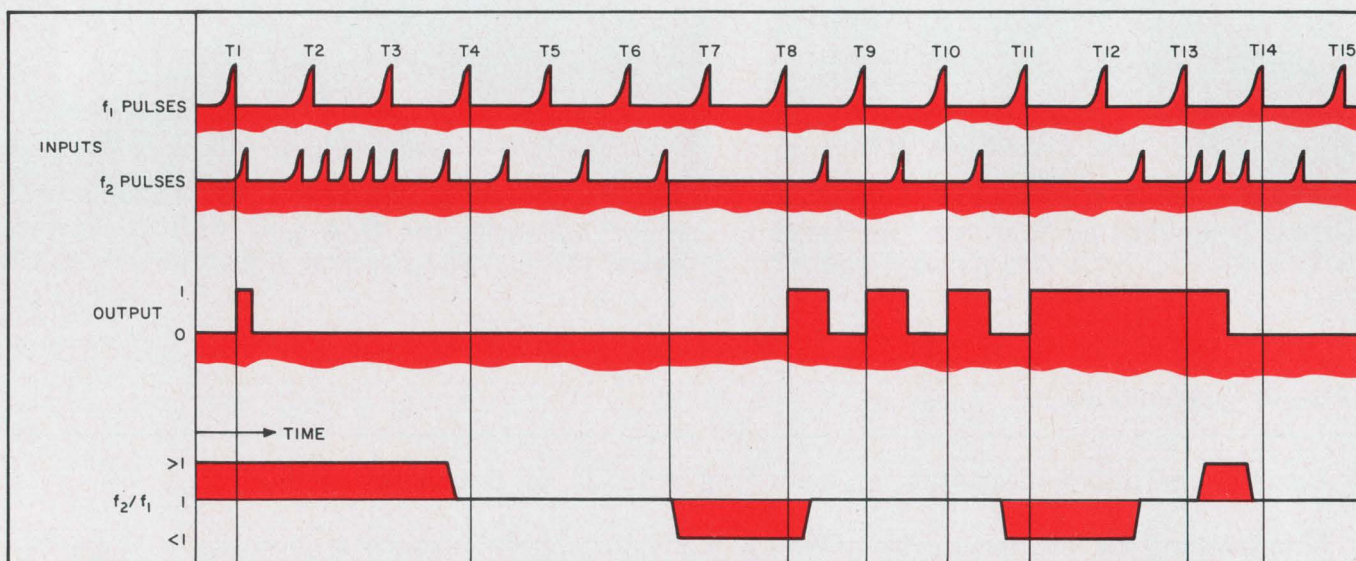

1. All three comparators respond alike to various pulse train inputs. When  $f_2/f_1 > 1$ , output stays low (see T1-T4). When  $f_2/f_1 < 1$ , output stays high (see T11-T13). When

$f_2 = f_1$ , output spacing indicates the phase relationship between the input signals (see T8-T11). In this chart,  $f_1$  is constant for clarity. In fact, it needn't be.



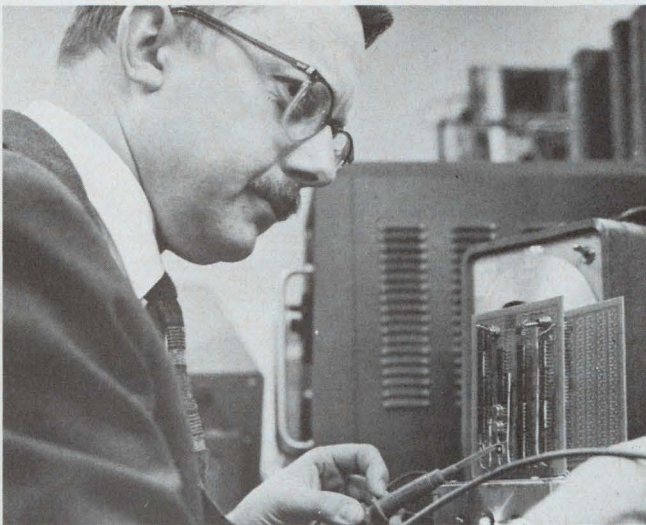

Fairchild Semiconductors' Hermann Ebenhoech checks out a digital design that incorporates one of his digital comparator circuits.

back to the control gates of *FF1*, to prevent it from changing to 0 during the phase state.

*FF1* does not change if both frequencies are equal. *FF1* can thus indicate the frequencies' equality. If, however,  $f_1$  is not equal to  $f_2$ , then *FF1* prevents *FF2* from changing its state. Two pulses are required to restore the system to the phase state.

This circuit has the advantage of indicating a frequency match without additional components. The output of *FF1* is quiescent if the frequencies are equal, and switches if they are unequal. (Circuits 2 and 3 both use an additional gate to indicate a frequency match.)

The second circuit (Fig. 3) uses R-S flip-flops with inhibit terminals. A pulse on an input will have no effect if the neighboring inhibit terminal is at a high potential.

*FF2* is the output flip-flop. In the phase state,

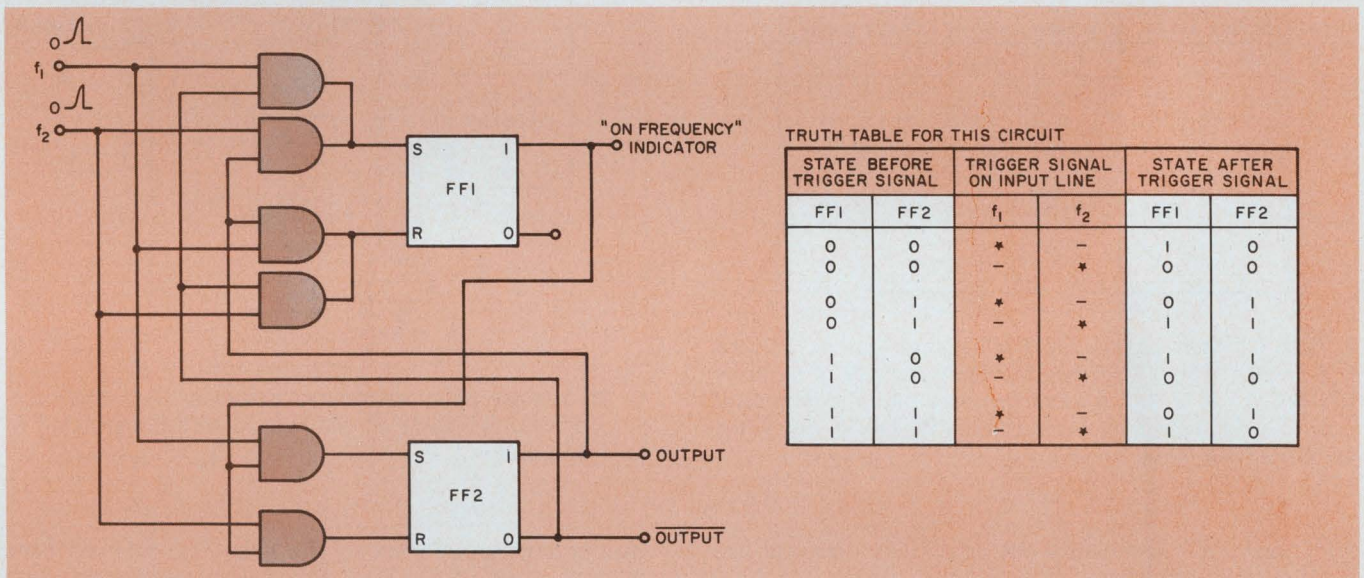

2. This circuit indicates a frequency match without the need for additional components (left). Its truth table

(right) uses a star to indicate a pulse on the input lines. A dash indicates no pulse.

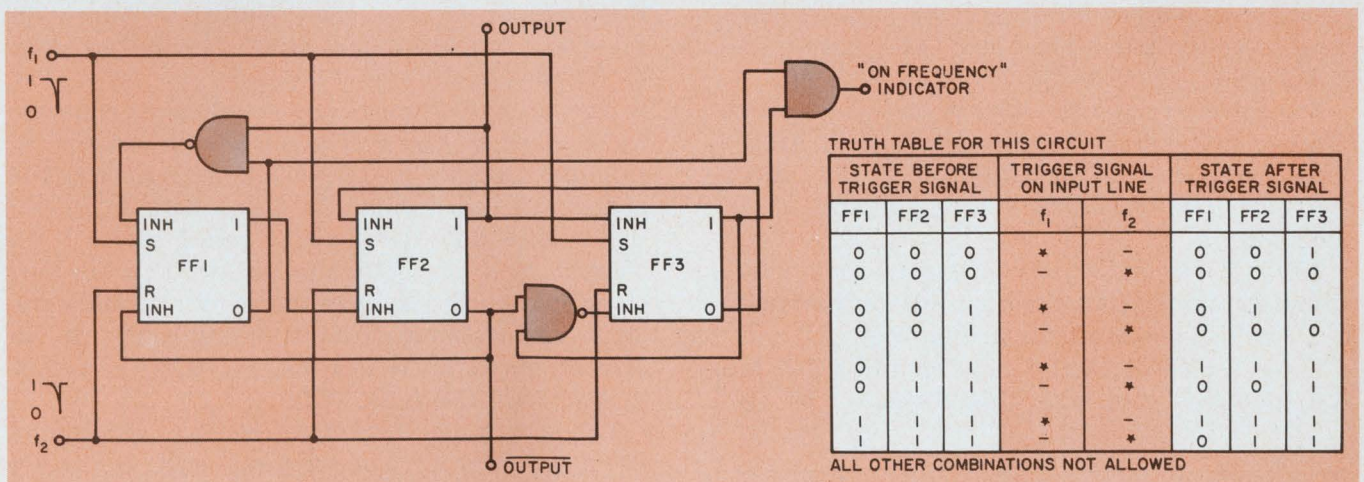

3. This circuit handles square wave inputs if it is built with capacitively coupled flip-flops. A high potential on an

inhibit terminal (INH) nullifies the effect of the adjoining input signal.

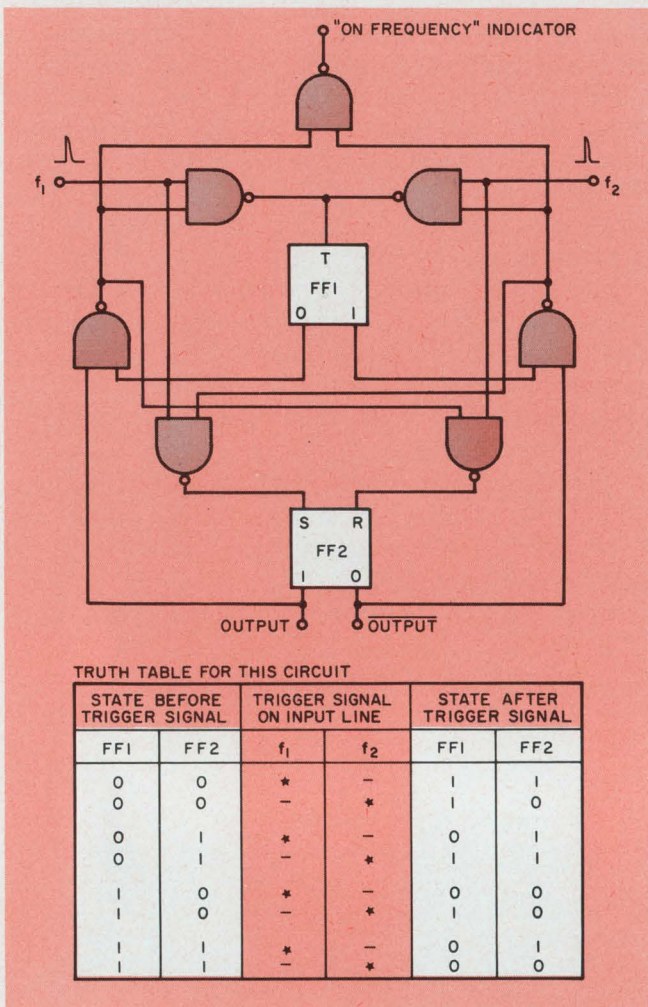

4. Both flip-flops change state in synchronization if  $f_1$  and  $f_2$  are equal. This circuit has the same number of parts as the one in Fig. 2, but it does require an additional gate if it is to indicate a frequency match. Its four lower gates can be on one chip.

$FF1$  and  $FF3$  are quiescent and their outputs are combined to indicate a frequency match.

Since, in this circuit, the inputs are fed directly to the flip-flops, there are no feedback paths as in circuits 1 and 3. Thus this circuit, if built with capacitively coupled flip-flops,\* can handle square-wave input signals. (The other two circuits must be fed short, sharp pulses.)

The third circuit (Fig. 4) has the same number of gates and flip-flops as circuit 1. Both its flip-flops change state in synchronization if  $f_1$  and  $f_2$  are equal. The four gates can be contained in one quad unit.†

All three circuits can be designed with any kind of logic provided that the appropriate flip-flops—R-S (or T)—are available in that logic.

The response of an R-S flip-flop and a J-K flip-flop to pulses occurring simultaneously on both

\*Editor's note: Fairchild's DT $\mu$ L 950, for instance.  
 †Editor's note: Fairchild (DT $\mu$ L 946), Motorola (MC 946) and Texas Instruments—all market quads.

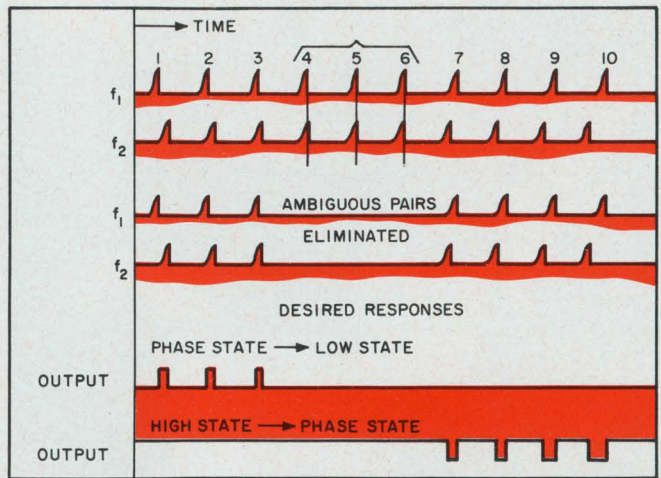

5. Ambiguous pairs of pulses never reach the comparator. The double-pulse eliminator nabbed pulses 4, 5 and 6 yet the comparator showed the state change.

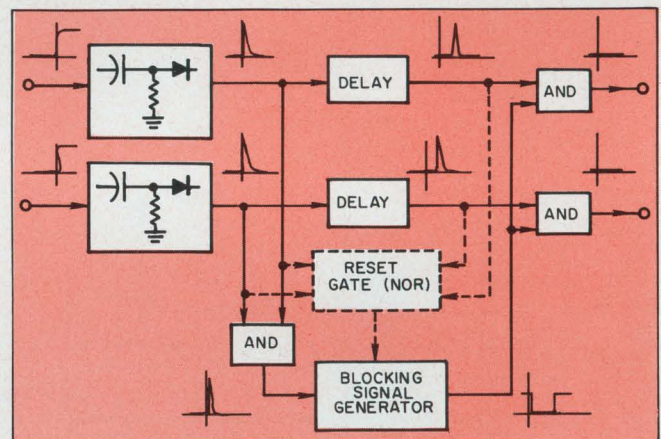

6. The double-pulse eliminator prevents two simultaneous pulses that appear on the two inputs from passing to the comparator.

inputs are in contrast to the response desired (see Fig. 5). If the pulses on the two input lines occur simultaneously, the dual pulse eliminator will prevent them from passing on to the comparator; hence the comparator will not accept ambiguous input signals. Its frequency range is increased and the upper frequency limit is set by the time delay of the actual circuits.

The block diagram of the double-pulse eliminator is given in Fig. 6. The differentiators are not essential, but they make possible the acceptance of noncritical waveforms. The delay between points A and B permits the blocking signal to reach the output gates ahead of the pulses. The blocking signal generator can take the form of a monostable or bistable multivibrator, or equivalent. In the case of the bistable solution, resetting is accomplished with the NOR gate.

In cooperation with the frequency eliminator, all three systems will perform well up to the frequency limits set by the switching times of the logic families employed in their construction. ■ ■

# In Making Masks for Electronic Components... ...there's no Margin for Error!

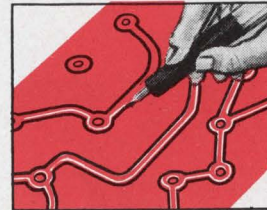

With sharp blade, outline the areas to be masked. Do not cut through the backing sheet. The Ulano Swivel Knife does the job quickly, easily.

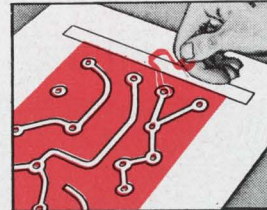

Now carefully peel off the film as outlined leaving a completed photo mask, positive or negative, that corresponds exactly to the desired pattern.

**THAT'S WHY EXPERIENCED DESIGNERS  
AND ENGINEERS ALWAYS INSIST ON...**

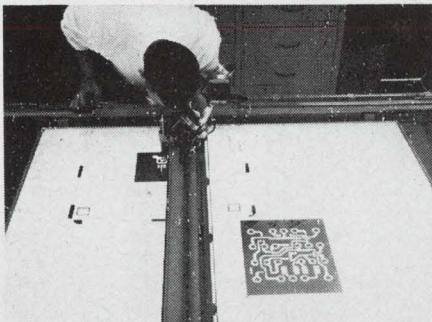

# RUBYLITH™

HAND-CUT MASKING FILM FOR THE GRAPHIC ARTS

**THE KNIFE-CUT, LIGHT-SAFE MASKING FILM  
LAMINATED TO A STABLE POLYESTER BASE**

The most versatile line of hand-cut masking films, including  
.0075—RUBYLITH 75 DR\*    .005 RUBYLITH 5 DR  
.005 AMBERLITH 5 DA

These new, thick Ulano films provide the positive answers  
where exact register assumes a critical importance.

*\*Available in sheets only, cut to your specifications.*

*by*

# Ulano™

ulano™

610 DEAN STREET, BROOKLYN, N. Y. 11238

NEW YORK • CALIFORNIA • CHICAGO • ZURICH

In Europe: ULANO A. G., Untere Heshlibachstrasse 22, Kusnacht 8700, Switzerland

*Write on your letterhead for special electronic test kit (no charge) No. 4127*

ON READER-SERVICE CARD CIRCLE 37

# Five new op amps from TI expand your linear IC spectrum

## Operational Amplifier Selection Guide

Typical Characteristics	SN523A SN5231L	SN524A SN724	SN525 SN725	SN526 SN726	SN5510	NEW				
						SN5511	SN52702	SN52709	SN52710	SN52711
Open-loop voltage gain, dB	72	63	90	66	40	65	68	93	64	64
Bandwidth (-3 dB), kHz	180	140	45	120	40,000	4000	-	-	-	-
Input impedance, k $\Omega$	15	1000	140	1000	6	5	25	400	-	-
Input capacitance, pF	55	60	250	50	7	-	-	-	-	-
Differential-input offset voltage, mV	2.2	12	1	3	3	1	2	3	2	1
Differential-input offset current, $\mu$ A	0.5	0.02	0.016	0.006	3	3.2	0.7	0.05	1	0.5
Differential-input offset voltage temperature coefficient, $\mu$ V/ $^{\circ}$ C	9	25	5	10	10	2	5	-	5	5
Maximum common-mode input voltage range, V	$\pm$ 5	$\pm$ 5	$\pm$ 7	$\pm$ 7	$\pm$ 1	$\pm$ 2.6	0.5 to -4	$\pm$ 10	-	-
Common-mode output offset voltage, V	0.5	-	0.25	0.22	3.1	.35	-	-	-	-
Output impedance, $\Omega$	200	200	10k	-	35	770	200	150	200	200
Maximum peak-to-peak output voltage, V	24	15	18	11.7	4.0	5.0	10.6	26	-	-
Common-mode rejection ratio, dB	90	55	100	77	85	95	80	90	-	-
Total Power dissipation, mW	100	120	100	132	165	170	70	80	110	130
Input current, $\mu$ A	5	0.08	0.45	0.05	40	3.2	4	0.2	25	25

With the addition of five new IC operational amplifiers, Texas Instruments provides linear system designers with the broadest range of performance characteristics available today. Now you can select an IC amplifier suited to your particular requirements of performance and price. Some of the new circuits challenge the finest discrete-component amplifiers in performance. Others cost less than a third as much as discrete-component equivalents. All offer the advantages of smaller, simpler, more economical systems and vastly increased reliability.

**New video differential amplifier offers unsurpassed stability**

The new SN5511 differential video amplifier provides excellent operational amplifier performance at frequencies extending into the low VHF range. It offers a flat 30 dB closed loop gain from dc to 30 MHz, an extremely low offset voltage of 300 mV typical, and a minimum of 80 dB common mode rejection.

Stability and versatility are enhanced by provisions for external compensating networks and gating, to clock the circuit on and off under minimal interface conditions. The external compensating networks may also be used to adjust frequency response and offset.

Circle 260 for data sheet.

**New general-purpose operational amplifier costs 30% of discrete equivalent**

The SN52702 is a high gain band-

width IC amplifier that offers distinct size and reliability advantages over discrete component counterparts, at about one-third the cost.

Matching of components within the chip assures excellent thermal stability. Drift is only  $5 \mu\text{V}/^\circ\text{C}$  and offset is typically 6 mV. Further stability is provided by both lead and lag external compensation.

Circle 261 for data sheet.

**New "premium" op-amp offers superior performance for critical applications**

The SN52709 IC has nearly twice as many components on the chip as conventional amplifiers... and correspondingly superior electrical characteristics. When compared with earlier IC amplifiers, differential input offset is an order of magnitude lower, output voltage is  $2\frac{1}{2}$  times higher, and large signal voltage gain is 20 times higher. Input impedance is ten times higher and output impedance is 50 percent lower. Two frequency compensating arrangements are provided.

The SN52709 is the new standard of performance for analog computer and other critical applications.

Circle 262 for data sheets.

**New differential comparator features fast response**

High speed is the big advantage of the SN52710. It responds in 40 nsec when a 5 mV overdrive is supplied. Low offset (6 mV max), high voltage gains (typically 1500), and high output level (4 V), are other features.

Circle 263 for data sheet.

**New dual comparator can stretch output pulses and sense amplitude variations**

The SN52711 is more than just two differential comparators in a single package. It can stretch output pulses and function as an amplitude-discriminating sense amplifier with an adjustable threshold. Despite these capabilities the cost is less than two comparable differential comparators.

Circle 264 for data sheets.

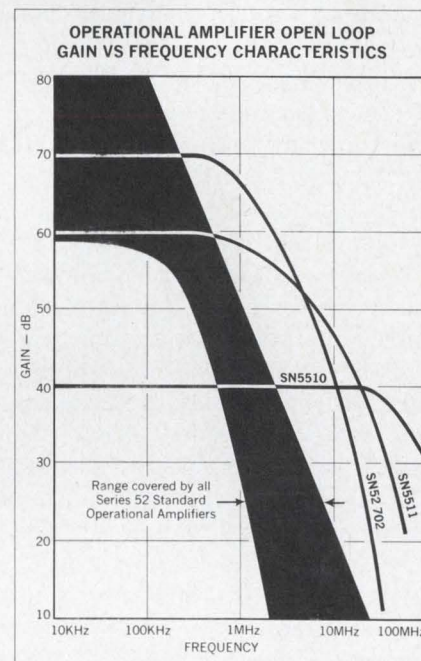

To learn more about these and other linear integrated circuits, contact your local TI sales engineer or authorized distributor... or write us at P. O. Box 5012, Dallas, Texas 75222.



**TEXAS INSTRUMENTS**  
INCORPORATED

# Ladder networks are easy to design

for D/A and A/D converters by a method that involves the solution of only three simple algebraic equations.

The design of ladder networks in analog-to-digital and digital-to-analog converters need not be a tough job. Even if an oddball binary code or a mixture of binary codes is involved, the procedure can be simplified to three linear equations. The resultant ladder network is built with identical resistive blocks or stages.

Since the circuit is constructed of resistors only, it does not have added frequency-sensitive elements, such as capacitors and inductors. No matter how many stages are added to the network, the resistive value at each node, looking either above or below, is the same:  $R$ .

The equations help to find the numerical values of the terminating resistor and the coupling resistors. Only two of these equations are needed for a ladder with identically coded binary inputs. All three equations are needed when the inputs are in different binary codes.

Ladder networks provide step attenuation in the converters. For the simpler case of identically coded binary inputs, consider the network in Fig. 1. This circuit will help establish the relationship between the base of the code and the component values of the ladder. Each of the four inputs makes twice the weighted voltage (or current) contribution of the previous input as the inputs approach the first input (1), the most significant digit. For example, an input at 1 contributes twice as much to the output as an input at 2.

This circuit is a basic building block. It can form one stage of a ladder network. The effects of loading by subsequent stages can be found by examining its equivalent circuit.

## Terminating resistor matches ladder

A Thévenin generator equivalent of the ladder in Fig. 1 is shown in Fig. 2a. Note that the terminating resistance of the circuit in Fig. 1 is  $2R$ . It turns out to be a matched termination, since it simulates an infinite length of ladder sections; therefore there is no reflection from the termina-

tion. The fact that  $2R$  is the proper termination can be seen from the analysis of the last stage (Fig. 2b): the  $2R$  termination makes the equivalent value of the last stage equal to  $R$ , too. By the same procedure, it can be shown that all other stages have the same equivalent value of  $R$ . The voltage sources that represent the input lines are assumed to be ideal; hence they have zero impedances. Therefore the input resistance—the Thévenin source resistance in Fig. 2a—is also equal in value to  $R$ :

$$R_s = R. \quad (1)$$

As already stated, all nodes of the network present the same impedance,  $R$ . Consequently, the outputs are determined only by how many stages separate them from the final output. This fixes the number of voltage dividers that they have to go through.

The Thévenin voltage equivalent,  $e_s$ , is the unloaded output voltage of the ladder network. The applied input voltages contribute successively less and less as one proceeds farther down the ladder inputs. The first input,  $e_1$ , looks into a voltage divider, shown in Fig. 2c. The grounded  $2R$  resistor in the figure represents the load for the remainder of the ladder. Therefore  $e_1$  contributes  $e_1/2$  at the output. The voltage dividers for  $e_2$ ,  $e_3$ , etc. can also be worked out. The final results show the relative voltage contributions at the input to be  $e_2/4$ ,  $e_3/8$ , etc. Therefore the output is:

$$e_s = \frac{e_1}{2} + \frac{e_2}{2^2} + \frac{e_3}{2^3} + \cdots + \frac{e_N}{2^N}. \quad (2)$$

$e_N$  is the last input to the ladder network. In A/D or D/A ladders  $e_1$  through  $e_N$  are generally equal voltages.

The loading of a ladder with various load resistors,  $R_L$ , will affect the output voltage range, but not linearity. As Eq. 2 shows, the output depends linearly on the inputs.

These considerations reduce the ladder in Fig. 1 to a voltage source and resistance that can be loaded down by other ladder groups through coupling resistances or a terminating resistance.

In fact, the ladder, as reduced in Fig. 2a, be-

Jay Freeman, Electronic Engineer, Sperry Gyroscope Co., Great Neck, L. I., N.Y.

comes one input to a larger ladder, shown in Fig. 3. Each input to the network in Fig. 3 is another ladder. The problem is to determine the values of the coupling resistances and terminating resistances, so that each input contributes the desired weighting. This weighting is referred to as the base,  $b$ , of the ladder.

For example, a BCD ladder would have a weighting or base of 10 between ladder groups. To design a ladder to this or any other base, the values of  $X$  and  $Y$  in Fig. 3 must be determined. Analysis will show that  $X$  and  $Y$  are simple functions of the base.

### Base is related to input weighting

To derive the basic equations, the problem may be phrased: Solve for  $X$  and  $Y$  so that each source contributes at the output of the network  $b$  times the voltage of the previous input, going down the ladder in Fig. 3. For example,  $e_{s(n-2)}$  should contribute  $b$  times as much as  $e_{s(n-1)}$  to the total output.

Since the Thévenin equivalent of the network can be loaded without affecting the linearity of the output response, as Eq. 2 demonstrates,  $R_L$  may for convenience' sake be set equal to  $X$ , the terminating resistance.  $X$  is selected so that  $Y$ , in series with  $X$  and in parallel with  $R$ , is equal to  $X$ , as shown in Fig. 4. Solve for  $Y$  in terms of  $X$ :

$$X = Y + XR / (R + X) \quad (3)$$

$$X - XR / (R + X) = Y \quad (4)$$

$$Y = X^2 / (R + X). \quad (5)$$

It is permissible to normalize by setting  $R$  equal to 1. The coupling resistance,  $Y$ , and the terminating resistance,  $X$ , will then simply be multiples of unity, making the algebra simpler. So, when  $R = 1$  in Eq. 5:

$$Y = X^2 / (1 + X). \quad (6)$$

Now solve for the relative values of  $X$  and  $Y$ , so that  $e_{s(n-1)}$  contributes  $b$  times the voltage contributed by  $e_{sn}$  at node 2 in Fig. 3. To do this, the voltage divisions must be calculated.

At node 2, the configuration that appears looking up the ladder and the one that appears looking down it are both the same as that shown in Fig. 4. These two like configurations in parallel with each other yield an equivalent resistance of  $X/2$ , since the input resistance of each is  $X$ . The voltage  $e_{s(n-1)}$  is distributed between the two sections. The effective resistance of the voltage divider is given by:

$$\begin{aligned} \frac{X/2}{(X/2) + R} &= \frac{X}{X + 2R} \\ &= \frac{X}{X + 2} \text{ for } R = 1. \end{aligned} \quad (7)$$

The input voltage  $e_{sn}$  is also divided between two sections: one consists of the terminating resistance,  $X$ , the other is the last stage of the ladder. The equivalent resistance at node 1 of the ladder is again given by:

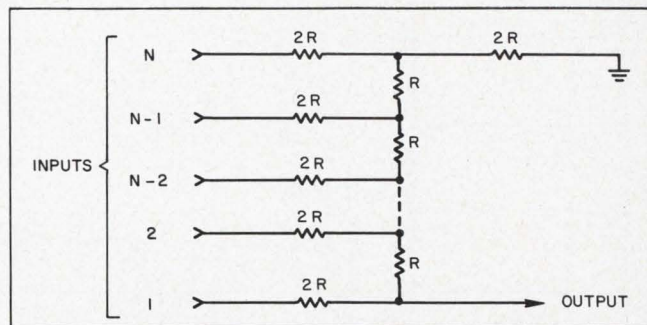

1. Each input of this binary ladder, contributes twice the voltage provided by the one above it:  $e_{out} = e_1/2 + e_2/4 + \dots + e_N/2^N$ .

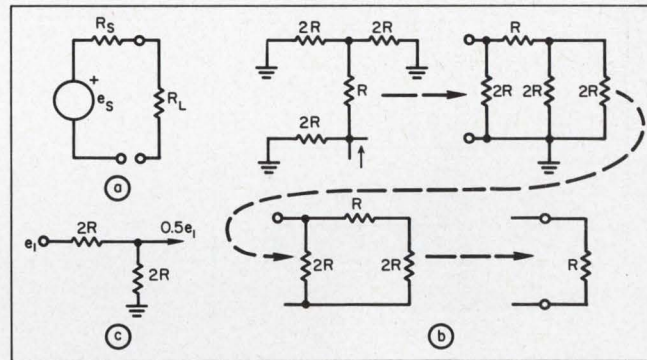

2. The effects of loading on the ladder by subsequent stages are estimated with its equivalent circuit (a). The equivalent resistance is found by removing the voltage sources (b) and assuming zero source resistances. The equivalent voltage,  $e_s$ , is the sum of the applied inputs. The analysis of the first input (c) shows that its contribution is  $e_1/2$ .

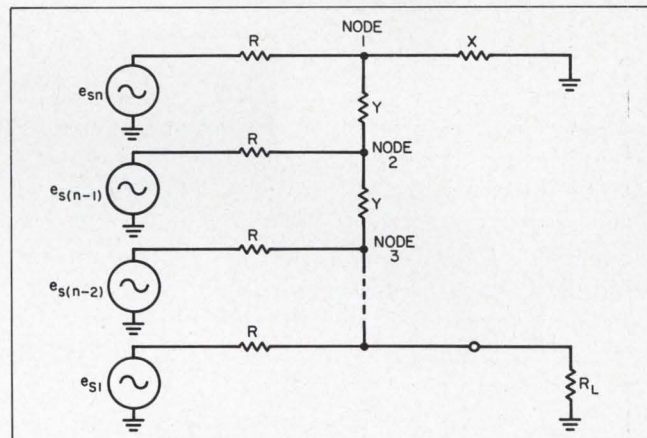

3. Each input of this network is a stage shown in Fig. 2. The terminating and coupling resistances ( $X$  and  $Y$ , respectively) determine the weighting, or the base, of the ladder, that adjusts the contributions of the inputs.

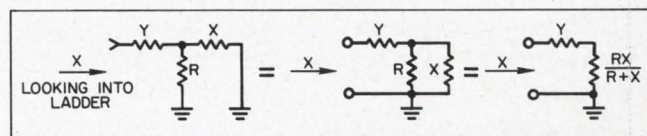

4. This circuit is the configuration that appears at any node in Fig. 3, up or down on the ladder. The terminating resistance,  $R_L$  in Fig. 3, has been replaced by  $X$ , to simulate an infinite series of sections.

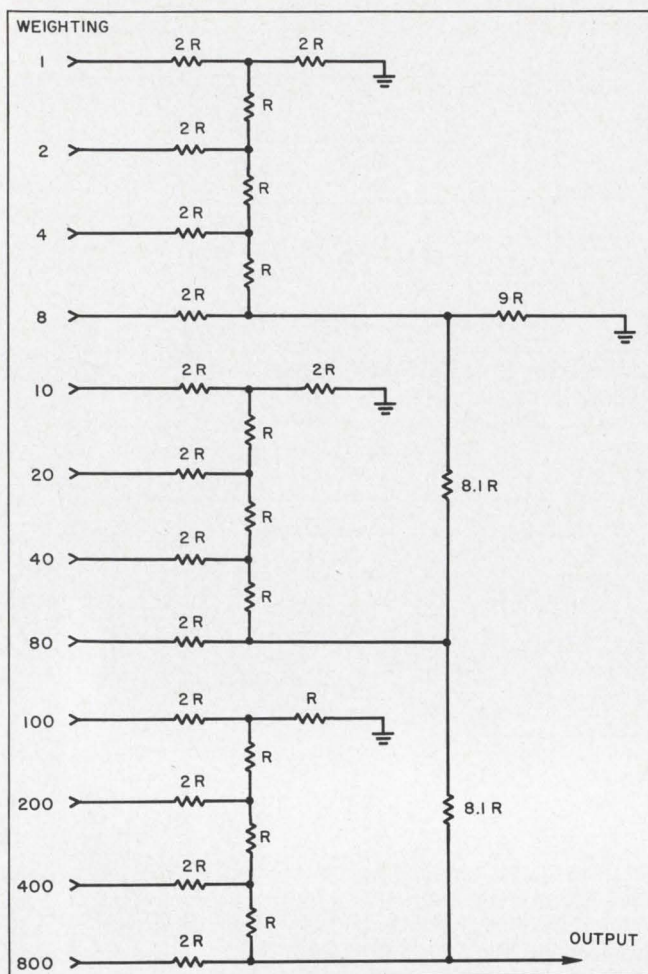

5. Binary-coded decimal ladder has a base of 10. The coupling resistors were found with Eqs. 14 and 15. The output voltage is proportional to the 12-bit BCD input.

$$\frac{X/2}{(X/2) + R} = \frac{X}{X + 2R} \quad (8)$$

The contribution of  $e_{sn}$  to the voltage at node 2 is determined by the two divisions through the voltage dividers at nodes 1 and 2. The division at node 1 is by  $X/(X+2R)$ . The division at node 2 is performed by the circuit in Fig. 4. To find the dividing factor, the voltage drop across the parallel combination of  $R$  and  $X$  must be found. The value of  $e_{sn}$  at node 2 is modified by the product of the two factors:

$$\frac{X}{X + 2R} \left[ \frac{RX}{R + X} / \left( Y + \frac{RX}{R + X} \right) \right] \quad (9)$$

Equation 9 may be normalized by letting  $R = 1$ :

$$\frac{X}{X + 2} \left[ \frac{X}{Y(1 + X) + X} \right] \quad (10)$$

The aim is to develop a ladder so that  $e_{s(n-1)}$  contributes  $b$  times the voltage contributed by  $e_{sn}$  at the output. Hence:

$$\frac{X}{X + 2} = b \frac{X}{X + 2} \left[ \frac{X}{Y(1 + X) + X} \right] \quad (11)$$

Simplifying Eq. 10 and solving for  $Y$  gives:

$$Y = (bX - X)/(1 + X) \quad (12)$$

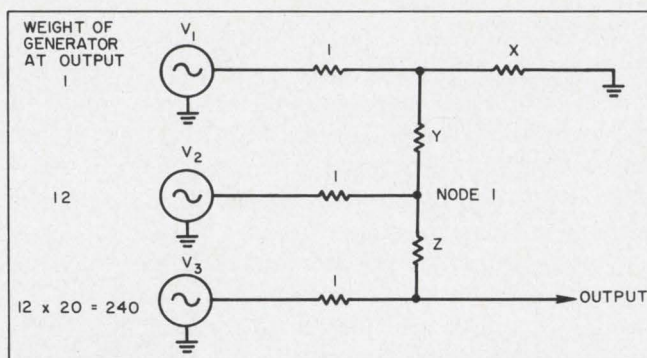

6. In mixed-base ladders the relative weights between adjacent stages (1, 12 and 20) are used to compute the coupling resistances,  $Y$  and  $Z$ . The weight of the last input is  $12 \times 20 = 240$ , relative to the first stage. The stages of the network are shown in their equivalent-circuit form.

Equations 6 and 12 yield the value of resistor  $X$ :

$$(bX - X)/(1 + X) = X^2/(1 + X) \quad (13)$$

Therefore:

$$X = b - 1, \quad (14)$$

and:

$$Y = X^2/(1 + X) = (b - 1)^2/b \quad (15)$$

Equations 14 and 15 provide the values of resistors  $X$  and  $Y$  for any base  $b$ .

To check the results, consider a simple example. The most common base is 10 in binary-coded decimal ladders. Solving for  $X$  and  $Y$  gives:

$$X = b - 1 = 10 - 1 = 9;$$

$$Y = (b - 1)^2/b = 8.1.$$

The ladder, shown in Fig. 5, has three 4-input decade groups, coupled by  $8.1R$  resistors. The size of the ladder is limited only by the realistic considerations of voltage source tolerances, resistor tolerances, temperature and aging characteristics. Each group accepts binary numbers between  $0000$  and  $1001$  (0 to 9 in decimal). The output voltage is proportional to the 12-bit BCD number.

### Mixed bases require third equation

The problem of constructing a ladder network with mixed bases will now be examined. Equations 14 and 15 can be used to solve for the termination resistance  $X$  and the first coupling resistance  $Y$ . If succeeding groups of inputs have the same base,  $Y$  is the same for these groups. But when the base is different, a third equation is required for the coupling resistors.

Consider, for instance, a ladder that converts British currency expressed in binary code, into an analog voltage. The currency has 12 pennies to the shilling and 20 shillings to the pound. This calls for a ladder where the first binary group has a weight of 1, the second has a weight of 12 relative to the first group, and the third a weight of 20 relative to the second group. The weight of the third group is 240 relative to the first group. The relative weights of adjacent groups are used



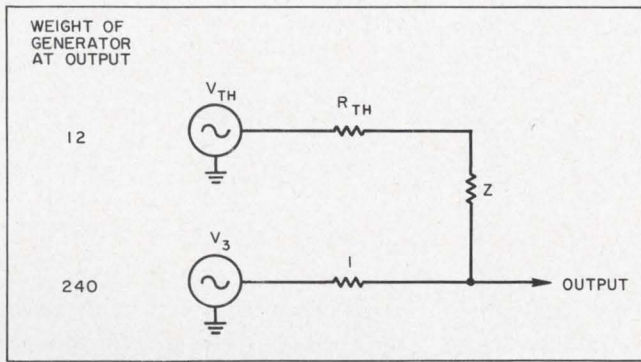

7. The last coupling resistor,  $Z$ , is found with a further simplification. A new equivalent circuit of the network is formed, to show how it appears to the last stage. Again, zero source resistances are assumed for all voltage sources, for the sake of simplicity.

to compute the coupling resistance between the groups.

The first group will count up to 12, the second up to 20, and the third up to any number limited by component tolerances. For example, the maximum amount of currency may be 16 pounds.

Figure 6 shows the ladder with each group reduced to its Thévenin equivalent circuit. The source resistance of each generator is normalized to unity. Resistors  $X$  and  $Y$  are found with Eqs. 14 and 15 ( $b = 12$  between the first and second stages):

$$X = b - 1 = 12 - 1 = 11;$$

$$Y = (b - 1)^2 / b = 121 / 12 = 10.0833.$$

To solve for  $Z$ , the first two input groups must be converted into a common Thévenin generator and resistor, as shown in Fig. 7. The new equivalent circuit simulates the effect of the weight-12 generator in Fig. 6. The resulting two inputs to the output terminals are then multiplied with the proper weighting function and summed.

To find the Thévenin equivalent of the first two stages, remove  $Z$  in Fig. 6 and calculate the equivalent resistance,  $R_{TH}$ , and voltage,  $V_{TH}$ . Note that sources  $V_1$  and  $V_2$  have zero source resistances. It is also possible to assume that  $V_1$ ,  $V_2$  and

$V_3$  are all 1-volt sources. Looking into node 1 with  $Z$  removed:

$$R_{TH} = \frac{1(X) / (1 + X) + Y}{[1(X) / (1 + X)] + Y + 1}; \quad (16)$$

$$V_{TH} = V_2 \frac{1(X) / (1 + X) + Y}{[1(X) / (1 + X)] + Y + 1} = V_2 R_{TH}; \quad (17)$$

$$V_2 = 1 \text{ (normalized)}$$

$$\therefore V_{TH} = R_{TH}. \quad (18)$$

To find  $Z$ , solve for the equation of the two voltage contributions at the output of the circuit in Fig. 7:

$$b V_{TH} / (R_{TH} + Z + 1) = V_3 [(Z + R_{TH}) / (R_{TH} + Z + 1)]; \quad (19)$$

$$b V_{TH} = V_3 (Z + R_{TH}); \quad (20)$$

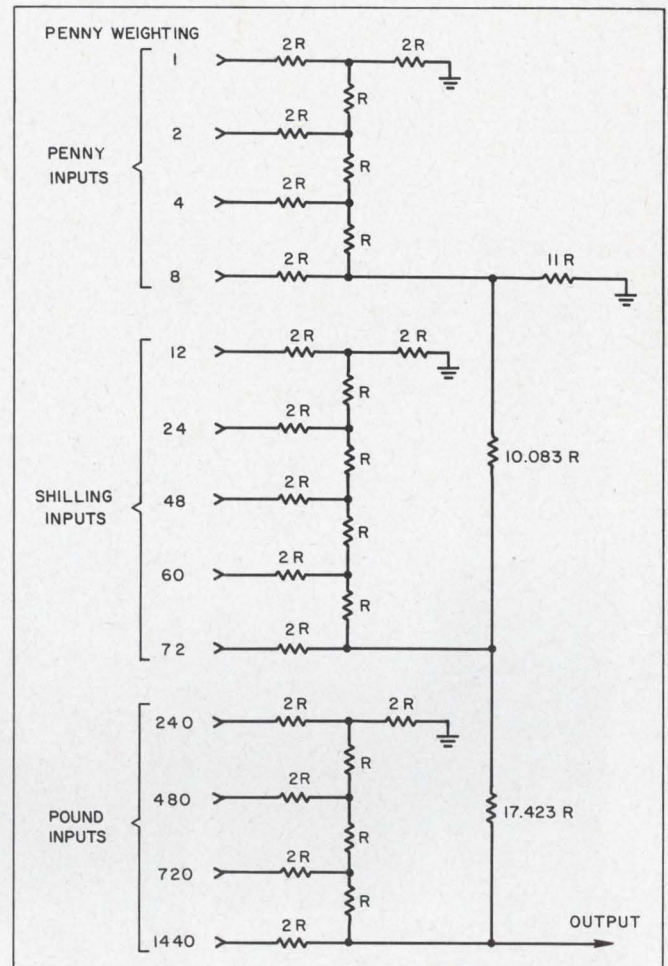

8. Mixed-base ladder converts binary representation of British currency to analog voltages. The relative weights of adjacent groups are used to compute the coupling resistances.

$$Z = (b V_{TH} - V_3 R_{TH}) / V_3 = [(b - V_3) R_{TH}] / V_3; \quad (21)$$

$$V_3 = 1 \text{ (normalized)}$$

$$\therefore Z = (b - 1) R_{TH}. \quad (22)$$

From Eqs. 16 and 22  $R_{TH}$  and coupling resistance  $Z$  are:

$$R_{TH} = (12/13 + 10.083) / (12/13 + 10.083 + 1)$$

$$= 0.917;$$

$$Z = (20 - 1) 0.917 = 17.423.$$

The complete British-currency ladder is shown in Fig. 8.

In summary, the three equations are:

- $X = b - 1$  — to find the ladder's terminating resistance.
- $Y = (b - 1)^2 / b$  — to find the coupling resistance for a single-base ladder, or the first coupling resistance in a mixed-base ladder.
- $Z = R_{TH}(b - 1)$  — to find the second and succeeding coupling resistances in mixed-base ladders.

$R_{TH}$  is the Thévenin resistance looking back into the ladder toward the termination resistance.

All these equations are based on normalized source resistances in the ladder groups. ■ ■



With **cdc** it's #4 that makes it a game!



*Whether it be in golf  
or in business,  
never ignore player #4*

Through the sheer impact of overwhelming advertising, many engineers and purchasing people are misled into believing there are only three broad based silicon semi-conductor manufacturers. Today, however, Continental Device Corporation can provide that essential competitive edge needed to assure high quality, low-cost semiconductor devices on firm delivery schedules.

Failure to utilize number 4 has caused many manufacturers to struggle against slow delivery and poor service. Start looking to number 4 to make it the game you would like to play.

*#4 is the name of the game.*

**HERMETIC RELIABILITY WITH  
DIMENSIONAL FLEXIBILITY**

**NEW MINI-MONO  
ASSEMBLIES**

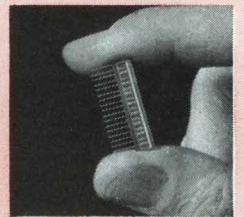

Plastic encased component assemblies utilizing Mini-Mono Diodes can lead to cost savings and improved reliability for both military and industrial users. These space saving modules can contain both active and passive components. They greatly reduce the number of individual parts which must be handled by the electronic manufacturer and improve his reliability because of the rigidly supported and electrically tested interconnections. Choice of electrical characteristics and shapes to meet your requirements. *Write for details.*

On Reader Service Card Circle 68

**20 LINE, 20 TEST I.C.**

**MEASUREMENT  
ADAPTER**

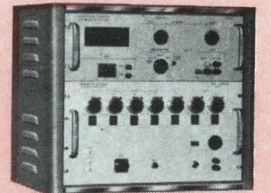

Shown is a 20 line, 20 test Integrated Circuit Measurement Adapter to allow for measurement of all types of Integrated and Discrete Circuits (digital and linear op amps), from 1 to 20 lines and from 1 to 20 tests. Individual tests are programmed on matrix PC cards and output is available as a Go-No-Go function or with full 4 digit data with self-contained DVM. Unit has capabilities for measurement from DC to 100 K Hz on digital and linear circuits. **Price of this unit, as shown, is \$6500.**

On Reader Service Card Circle 69

# MINI-MONO DIODE IN5315 & IN5316

The Mini-Mono 1N5315 & 1N5316 are silicon epitaxial diodes featuring small size and optimized power dissipation, logarithmic response to high current levels and nano second recovery. Glass Gettering & heavy surface Glassification insure immunity to reverse parameter degradation. These devices have been designed to exceed requirements of MIL S-19500.

The Mini-Mono 1N5315 & 1N5316 are hermetically sealed whiskerless glass diodes with symmetrical dumet studs. Total volume of these diodes is less than 1/9th of the standard subminiature DO-7 glass package.

### ELECTRICAL CHARACTERISTICS — IN5315 — SPECIFICATIONS AT 25°C (UNLESS OTHERWISE SPECIFIED)

SYMBOL	DESCRIPTION	MIN.	MAX.	UNITS
BV	Breakdown Voltage at 10 uA		100	volts
V <sub>F</sub>	Forward Voltage Drop at 0.1 mA	0.430	0.490	volts
V <sub>F</sub>	Forward Voltage Drop at 1 mA	0.540	0.600	volts
V <sub>F</sub>	Forward Voltage Drop at 10 mA	0.650	0.710	volts
V <sub>F</sub>	Forward Voltage Drop at 100 mA	0.750	0.900	volts
V <sub>F</sub>	Forward Voltage Drop at 200 mA		1.00	volts
I <sub>R</sub>	Reverse Current at 50 volts at 25°C		50	na
C	Capacitance at 1 volt		2.5	PF
Reverse Recovery to:		1.0 mA	I <sub>F</sub> = 10 mA,	
Circuit: Nanosecond Circuit			I <sub>R</sub> = 10 mA	4 nsec

### ELECTRICAL CHARACTERISTICS — IN5316 — SPECIFICATIONS AT 25°C (UNLESS OTHERWISE SPECIFIED)

SYMBOL	DESCRIPTION	MIN.	MAX.	UNITS
BV	Breakdown Voltage at 10 uA	100		volts
V <sub>F</sub>	Forward Voltage Drop at 0.1 mA	0.460	0.520	volts
V <sub>F</sub>	Forward Voltage Drop at 1 mA	0.570	0.630	volts
V <sub>F</sub>	Forward Voltage Drop at 10 mA	0.690	0.750	volts
V <sub>F</sub>	Forward Voltage Drop at 100 mA		1.00	volts
I <sub>R</sub>	Reverse Current at 50 volts at 25°C		50	na
C	Capacitance at 1 volt		2.5	PF
Reverse Recovery to:		1.0 mA	I <sub>F</sub> = 10 mA,	
Circuit: Nanosecond Circuit			I <sub>R</sub> = 10 mA	4 nsec

DEVICE	1-99	100-999
1N5315	\$1.60	\$.98
1N5316	1.40	.93

On Reader Service Card Circle 70



# EPOXY MATCHED: DUAL CHIP TRANSISTORS

These devices contain 2 isolated NPN Silicon Matched Transistors. They are designed primarily for small signal, low power audio frequency and general purpose differential amplifier applications in industrial service.

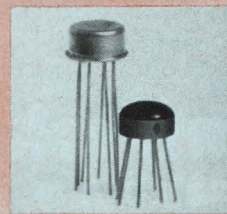

METAL CAN TRANSISTOR		EPOXY EQUIVALENT	
Device	Device	1-99	100-999
2N2639	CS2639	\$6.00	\$4.00
2N2640	CS2640	5.00	3.33
2N2641	CS2641	3.50	2.33
2N2642	CS2642	8.00	5.35
2N2643	CS2643	7.00	4.65
2N2644	CS2644	4.00	2.67

On Reader Service Card Circle 72

# RTL Mono Circuit

Continental Device Corporation's RTL family of monolithic circuits is really an extension of CDC's proven ability in the manufacture of hi-rel volume components. And when it comes to prices, CDC wins the game.



OPERATING RANGE: +15°C to +55°C

DEVICE	PART NO.	PACKAGE	1-99	100-999	1,000
Buffer	CMC219001	Epoxy TO-5	\$.80	\$.54	\$.36
Dual 2-Input Gate	CMC219141	Epoxy TO-5	.80	.54	.36
JK Flip-Flop	CMC219231	Epoxy TO-5	1.50	1.00	.67

On Reader Service Card Circle 73

# NEW EPOXY TRANSISTORS

With CDC the chip's the thing! Only the package changes. CDC uses the same stringent process controls in manufacturing dice for epoxy transistors as are used for all military and high reliability metal packaged devices.

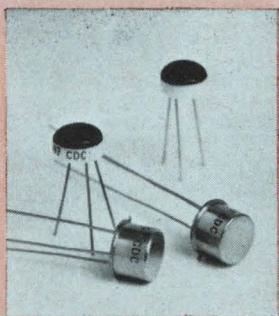

DEVICE	1-99	100-999	1000
2N2369	\$.70	\$.47	\$.30
2N3638	.46	.31	.28

On Reader Service Card Circle 71

Write for **FREE** data sheets  
and new 24-page  
color catalog!

**FREE** sample devices  
sent on request.



Contact your CDC representative or write  
*reliability...  
our first  
responsibility* the factory direct.

# cdc



CONTINENTAL DEVICE CORPORATION

12515 Chadoon Avenue  
Dept. D-7  
Harthorn, Calif. 90250

Phone: (213) 772-4551  
TWX: 910-325-6217

# Synthesize resistor-thermistor networks to match any desired voltage-ratio-vs-temperature characteristic. It's easy with the direct method.

Part 2 of a two-part article

An accurate and simple approach to designing thermistor-resistor networks is based on three points on the voltage-ratio-versus-temperature curve, which are used to match performance to specifications. Part 1\* described the principles of the direct method and its application to networks where the resistance varies with temperature. Now consider networks where the voltage or current ratio varies with temperature.

The synthesis of the transfer ratio involves only a few algebraic manipulations. The circuit that is developed in this way is one of two standard types.

These two basic resistor-thermistor networks are shown in Figs. 1 and 2. The network of Fig. 1 yields a  $V_o/V_{in}$  that increases with temperature when negative temperature coefficient (NTC) thermistors are used, and decreases with temperature when positive temperature coefficient (PTC) thermistors are used. The network of Fig. 2, on the other hand, yields a  $V_o/V_{in}$  that decreases with temperature for NTC thermistors and increases with temperature for PTC thermistors, or posistors.

## NTC thermistor yields increasing $V_o/V_{in}$

To apply the direct method of resistor-thermistor network synthesis to match a desired voltage-transfer-ratio-vs-temperature curve, consider first the NTC-thermistor network of Fig. 1. The voltage ratio as a function of temperature,  $V_o/V_{in}(T)$ , is:

$$\frac{V_o}{V_{in}}(T) = \frac{R_4}{R_4 + R_3 + \frac{R_2 R_1(T)}{R_2 + R_1(T)}} \quad (1)$$

Since the impedance level has no effect on the voltage ratio, three of the resistance values can be referenced to the fourth such that  $R_3 = n_3 R_4$ ,

$R_2 = n_2 R_4$  and  $R_1 = n_1 R_4$ . Substituting these into Eq. 1 yields:

$$\frac{V_o}{V_{in}}(T) = \frac{R_4}{R_4 + n_3 R_4 + \frac{n_2 n_1 R_4^2 r(T)}{n_2 R_4 + n_1 R_4 r(T)}} \quad (2)$$

Hence, all the resistance values are referenced to  $R_4$ , leaving  $V_o/V_{in}$  unchanged. A more useful form of Eq. 2 is:

$$V_{in}/V_o(T) - 1 = n_3 + n_1 n_2 r(T) / [n_2 + n_1 r(T)].$$

If  $\theta(T)$  is defined as equal to  $V_{in}/V_o(T) - 1$ , this equation becomes:

$$\theta(T) = n_3 + n_1 n_2 r(T) / [n_2 + n_1 r(T)]. \quad (3)$$

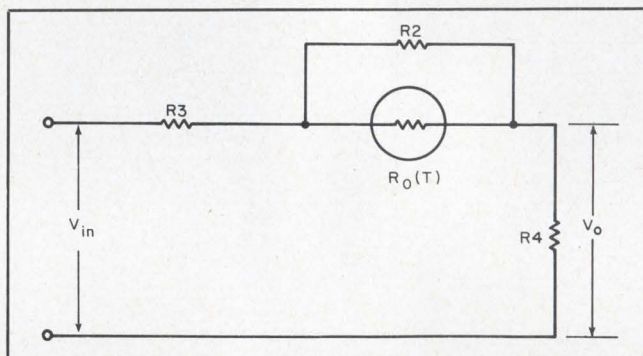

1. The ratio  $V_o/V_{in}$  of this network increases with temperature when an NTC thermistor is used. For positive temperature coefficient thermistors, the opposite is true.

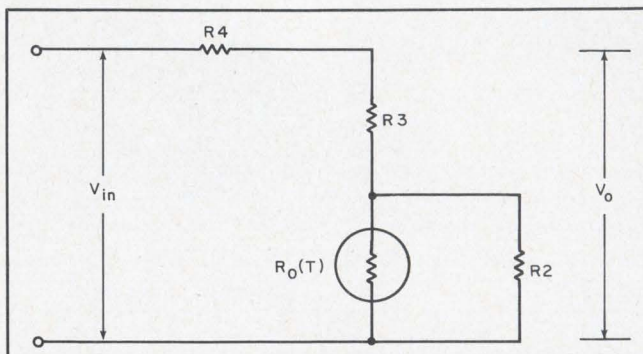

2. The ratio  $V_o/V_{in}$  of this network decreases with temperature when an NTC thermistor is used. For posistors, the opposite is true. The design of this and the circuit in Fig. 1 uses three simple equations.

\*See "Ease thermistor-resistor network design," ED 13, June 21, 1967, pp. 60-64.

Victor Weisenbloom, Electronic Engineer, Raytheon Co., Sudbury, Mass.

To match a given  $V_o/V_{in}$ -vs-temperature characteristic, a set of three equations must be generated to solve for the normalized unknowns,  $n_0$ ,  $n_2$  and  $n_3$ . Picking three points,  $Av(T_1)$ ,  $Av(T_2)$ ,  $Av(T_3)$ , on the desired characteristic, where  $Av = V_o/V_{in}$ , yields (through Eq. 3) three values of  $\theta$ :  $\theta(T_1) = C_1$ ,  $\theta(T_2) = C_2$ ,  $\theta(T_3) = C_3$ . Furthermore, finding  $r(T)$  on the thermistor manufacturer's normalized curves (Fig. 3) at the respective temperatures yields  $r(T_1) = r_1$ ,  $r(T_2) = r_2$  and  $r(T_3) = r_3$ .

The "generated" form of Eq. 3 then becomes:

$$\begin{aligned} C_1 &= n_3 + n_2 n_0 r_1 / (n_2 + n_0 r_1); \\ C_2 &= n_3 + n_2 n_0 r_2 / (n_2 + n_0 r_2); \\ C_3 &= n_3 + n_2 n_0 r_3 / (n_2 + n_0 r_3). \end{aligned}$$

This set is of the same form as that established as Eq. 6 in Part 1 for the case of resistance that varies with temperature. Therefore:

$$\left. \begin{aligned} n_0 &= (C_1 - C_2) (r_1 X + 1) (r_2 X + 1) / (r_1 - r_2), \\ n_2 &= n_0 / X, \\ n_3 &= C_1 - r_1 n_0 / (1 + r_1 X), \end{aligned} \right\} (4)$$

where:

$$\begin{aligned} X &= (Q - K) / (r_1 K - r_3 Q), \\ K &= (C_1 - C_2) / (C_2 - C_3), \\ Q &= (r_1 - r_2) / (r_2 - r_3). \end{aligned}$$

Once  $n_0$ ,  $n_2$  and  $n_3$  have been calculated, they

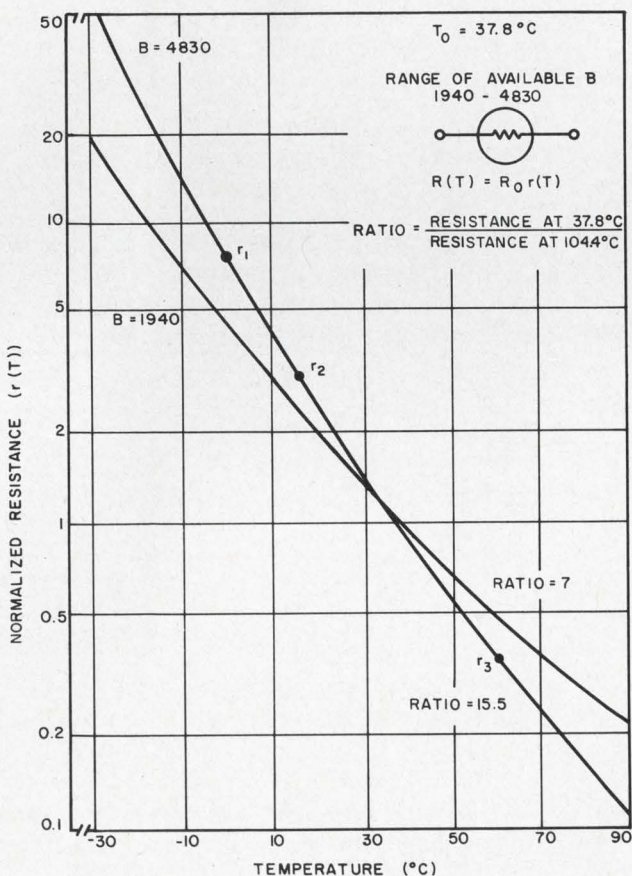

3. Range of available thermistor constant (B) is shown on the thermistor manufacturer's universal curves. From these curves the designer determines which value of B is most useful for a specific application.

can all be multiplied by any constant  $R_4$ , thus adjusting the impedance level while leaving the voltage ratio unchanged. The constraints on the values of the normalized resistors  $n_0$ ,  $n_2$  and  $n_3$  are the same as those established in Part 1 for the normalized resistors. This network (summarized in Fig. 4a) is highly suitable for a voltage transfer ratio that increases with temperature, and guarantees a match at three points on the desired characteristic.

#### Modified circuit yields decreasing $V_o/V_{in}$

For a voltage transfer ratio that decreases with increasing temperature, consider the NTC-thermistor network of Fig. 2. If three points are picked from the desired characteristic, an analysis similar to that for the network of Fig. 1 will guarantee a match at those three points. The derivation finds the element values in terms of the points on the desired characteristic and the corresponding points on the manufacturer's universal thermistor curve. The end result is again three equations (of the form of Eqs. 4), which are used to synthesize the required network. Once  $n_0$ ,  $n_1$  and  $n_2$  are known, they can all be multiplied by any convenient constant to adjust the impedance level. The technique is summarized in Fig. 4b.

In essence, therefore, for a monotonically in-

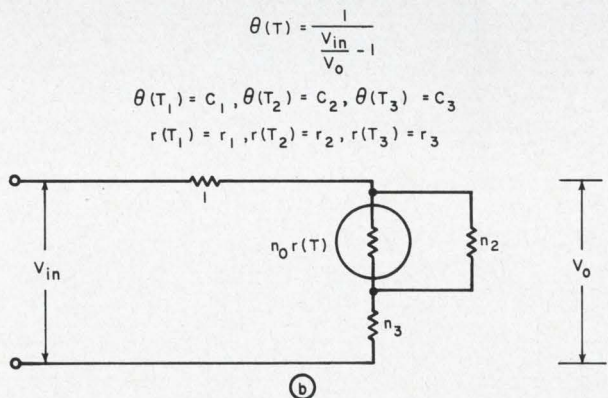
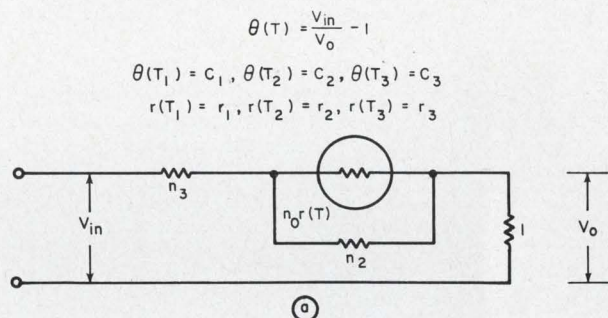

Q	K	X	$n_0$	$n_2$	$n_3$
$\frac{r_1 - r_2}{r_2 - r_3}$	$\frac{C_1 - C_2}{C_2 - C_3}$	$\frac{Q - K}{r_1 K - r_3 Q}$	$\frac{(C_1 - C_2)(r_1 X + 1)(r_2 X + 1)}{r_1 - r_2}$	$\frac{n_0}{X}$	$C_1 - \frac{r_1 n_0}{1 + r_1 X}$

CONSTRAINTS  $Q \geq K$   
 $r_1 > r_3$   
 $C_1 \geq \frac{(C_1 - C_2)(r_2 X + 1)r_1}{r_1 - r_2}$

4. Direct method of voltage-ratio synthesis is the same for both increasing (a) and decreasing (b)  $V_o/V_{in}$ .

**Table. Slope data for Fig. 5**

Temperature (°C)	Slope	Rate of change of slope
0	$3 \times 10^{-3}$	—
10	$3.5 \times 10^{-3}$	$5 \times 10^{-4}$
20	$5 \times 10^{-3}$	$1.5 \times 10^{-4}$
30	$6 \times 10^{-3}$	$1 \times 10^{-4}$
40	$6.5 \times 10^{-3}$	$0.5 \times 10^{-4}$
50	$6 \times 10^{-3}$	$0.5 \times 10^{-4}$
60	$5 \times 10^{-3}$	$1 \times 10^{-4}$
70	$4 \times 10^{-3}$	$1 \times 10^{-4}$
80	$3 \times 10^{-3}$	$1 \times 10^{-4}$

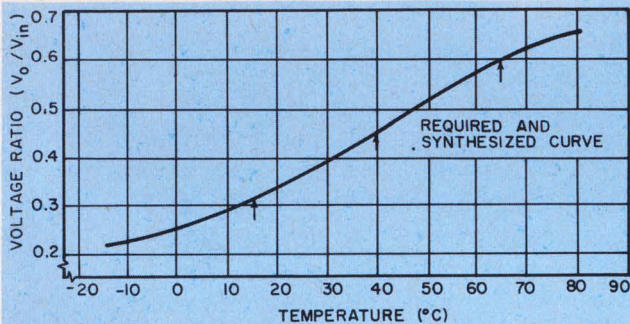

**5. Three points are chosen on the voltage-ratio-vs-temperature characteristic that is to be matched. One of these is at the point of maximum slope, and the others are where rate of change of the slope is greatest.**

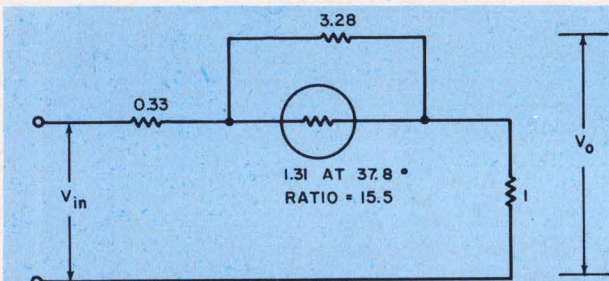

**6. All resistance values are related to resistor R4 (value of 1) in the normalized network produced by the direct method of voltage-ratio-vs-temperature synthesis.**

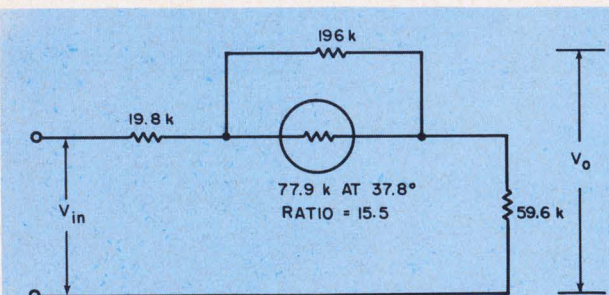

**7. Normalized network is converted into a practical network by selecting an available thermistor and multiplying the normalized resistor values by the ratio of the actual thermistor's resistance to that of the normalized thermistor.**

creasing or decreasing voltage ratio,  $V_o/V_{in}$ , the networks of Figs. 1 and 2 can be synthesized by the procedure just described. If a given  $V_o/V_{in}$  characteristic is decreasing to a minimum and then increasing with temperature, a combination of the two networks can be used.

**Design example demonstrates technique**

As an example of applying the technique described, assume that the voltage-ratio-vs-temperature characteristic of Fig. 5 is to be synthesized. Since the voltage ratio is increasing with increasing temperature, the network in Fig. 1 will provide a three-point match, assuming that the constraints are satisfied. The elements  $n_3$ ,  $n_2$  and  $n_0$ , normalized with respect to  $R_4$  are found by the direct method, and an arbitrary impedance level assigned on the basis of thermistor availability.

The three points on the curve of Fig. 5 that are to be matched are chosen—one at the point of maximum slope, and the other two at the points of maximum rate of change of the slope. On the assumption that the region of interest is from 0° to 75°C, the slope is calculated and tabulated in the table in 10° increments. The table shows that the maximum slope occurs at 40°C, and the maximum rate of change of slope occurs at approximately 15° and 65°C. Hence, for the purpose of calculating  $\theta(T)$ , choose  $V_o/V_{in}(15^\circ) = 0.315$ ,  $V_o/V_{in}(40^\circ) = 0.455$ , and  $V_o/V_{in}(65^\circ) = 0.6$ . From Fig. 4a, therefore,  $\theta$  is calculated as:

$$\begin{aligned} \theta(15^\circ) &= 2.18 = C_1; \\ \theta(40^\circ) &= 1.2 = C_2; \\ \theta(65^\circ) &= 0.67 = C_3. \end{aligned}$$

If a thermistor with a ratio of 15.5 is chosen,  $r_1$ ,  $r_2$  and  $r_3$  are found on the manufacturer's universal curves at temperatures  $T_1 = 15^\circ\text{C}$ ,  $T_2 = 40^\circ\text{C}$  and  $T_3 = 65^\circ\text{C}$ , respectively, to be:

$$r_1 = 3.3; \quad r_2 = 0.91; \quad r_3 = 0.29.$$

Once  $r_1$ ,  $r_2$ ,  $r_3$  and  $C_1$ ,  $C_2$ ,  $C_3$  are known, Fig. 4a gives:

$$\begin{aligned} Q &= (r_1 - r_2) / (r_2 - r_3) \\ &= 2.39 / 0.62 \\ &= 3.85; \end{aligned}$$

and

$$\begin{aligned} K &= (C_1 - C_2) / (C_2 - C_3) \\ &= (2.18 - 1.2) / (1.2 - 0.67) \\ &= 0.98 / 0.53 \\ &= 1.85. \end{aligned}$$

Since the constraints that  $Q > K$  and  $r_1 > r_3$  are satisfied, the analysis can be continued:

$$\begin{aligned} X &= (Q - K) / (r_1 K - r_3 Q) \\ &= (3.85 - 1.85) / (6.1 - 1.12) \\ &= 0.4; \end{aligned}$$

$$\begin{aligned}
n_0 &= (C_1 - C_2)(r_1 X + 1)(r_2 X + 1)/(r_1 - r_2) \\
&= (0.98)(2.32)(1.38)/2.4 \\
&= 1.31; \\
n_2 &= n_0/X \\
&= 1.31/0.4 \\
&= 3.28;
\end{aligned}$$

and finally

$$\begin{aligned}
n_3 &= C_1 - [r_1 n_0 / (1 + r_1 X)] \\
&= 2.18 - \{ (3.3)(1.31) / [1 + (3.3)(0.4)] \} \\
&= 0.33.
\end{aligned}$$

The solutions then are  $n_0 = 1.31$ ,  $n_2 = 3.28$  and  $n_3 = 0.33$ . The synthesized network is that of Fig. 6.

The impedance level is now adjusted by choosing a commercially available thermistor with a ratio of 15.5. On the assumption that the network impedance in this example is to be high, a thermistor where  $R_0 = 77.9 \text{ k}\Omega$  at  $37.8^\circ\text{C}$  is chosen. To adjust for this impedance level, all the impedances in Fig. 6 must be multiplied by  $77.9 \text{ k}\Omega / 1.31 = 59.6 \text{ k}\Omega$ . The completed network appears in Fig. 7.

The voltage ratio of the synthesized network can be calculated for purposes of comparison with the original required characteristic:

$$\frac{V_o}{V_{in}} = \frac{59.6 \text{ k}\Omega}{79.4 \text{ k}\Omega + 153 r(T) \times 10^2 / [196 + 77.9 r(T)]}$$

The data are plotted on the same set of axes as the given characteristic (Fig. 5). The error in the region of interest is shown to be negligible. ■ ■

#### Bibliography:

- Adler, Richard B., et al. *Introduction to Semiconductor Physics*. New York: John Wiley & Sons, 1964
- Del Toro, Vincent, and Parker, Sidney. *Principles of Control Systems Engineering*. New York: McGraw-Hill Book Co., 1960
- Farhi, Sivy, and Groves, Stanley. "Design of Resistive Temperature Compensation by Single and Multiple Thermistor Networks," *AIEE Trans.*, LXXX, Pt. 1, July, 1961, 246-253.
- Joyce, Maurice V., and Clarke, Kenneth K. *Transistor Circuit Analysis*. Reading, Mass.: Addison-Wesley Pub. Co., 1961.
- Kedson. "Thermistor Compensation Simplified," *EEE, X*, No. 7 (July, 1962).
- Saburi, O., and Wakino, K. "Processing Techniques and Applications of Positive Temperature Coefficient Thermistors," *IEEE Trans. on Comp. Parts*, Vol. CP-10, No. 1 (March, 1963), 53-67.
- Scarr, R. W. A., and Settingington, R. A. "Thermistors, Their Theory, Manufacture and Applications," *IRE Trans. on Comp. Parts*, Vol. CP-8, No. 1 (March, 1961), 6-22.
- Stern. *Theory of Non-Linear Networks and Systems*. Reading, Mass.: Addison-Wesley Pub. Co., 1965.
- Truxal, J. G. *Automatic Feedback Control System Synthesis*. New York: McGraw-Hill Book Co., 1955.
- Volz. "Temperature Compensation of Transistor Circuits." Research report conducted by the Dept. of Electrical Engineering of Pennsylvania State University for Keystone Carbon Co., Feb., 1965.
- Weinberg, Louis. *Network Analysis and Synthesis*. New York: McGraw-Hill Book Co., 1962

# Learn "How To Use" Zener and Reference Diodes In Your Circuits

... with this  
industry-  
acclaimed  
manual!

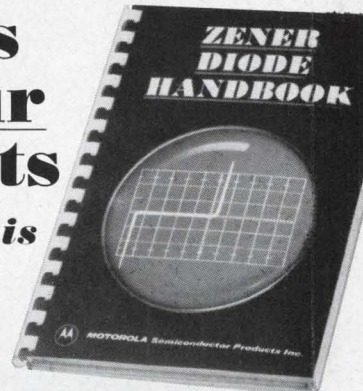

Now — for the electrical circuit designer who wants a single-source reference manual — the 4th applications-oriented edition of the Motorola Zener Diode Handbook! Full of useful, practical, "how-to-do-it" information like:

- Protective Circuits & Techniques
- Voltage Sensing Circuits & Applications
- Basic Voltage Regulation Using Zeners
- Reliability Considerations for the Designer
- Special Regulation Devices
- Understanding Zener Diode Characteristics

... and much more from the recognized industry authority.

For your personal copy, contact your franchised Motorola distributor or fill out and mail the coupon! Price \$2.00.

*Now!*

Please send me \_\_\_\_\_ copies of Motorola's new Zener Diode Handbook @ \$2.00 each

NAME \_\_\_\_\_

TITLE \_\_\_\_\_

COMPANY \_\_\_\_\_

ADDRESS \_\_\_\_\_

CITY \_\_\_\_\_

STATE \_\_\_\_\_ ZIP \_\_\_\_\_

Mail with check (payable to Motorola Inc.) to:  
Motorola Semiconductor Products Inc.,  
Box 955, Phoenix, Arizona 85001.



**MOTOROLA** Semiconductors

- where the priceless ingredient is care!

**NEW**

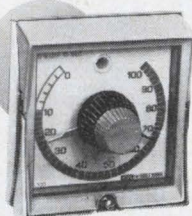

**SOLID STATE TIMER**

CA100

# **YOUR GREATEST CHOICE**

**NEW**

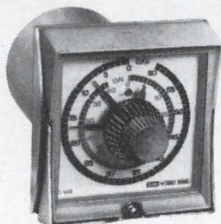

**ELECTROMECHANICAL DUAL-FUNCTION TIMER**

HG100

The Man from E.A.G.L.E.\* presents two samples that show the range in his bag of timing tricks. The CA100 solid state timer provides split-second control of continuous, high-speed, "on-off" cycles from 3 to 2000 times a minute. Housed in Eagle's famous Cycl-Flex case, the CA100 can be plugged in and taken out in seconds. Solid state circuitry eliminates moving parts, makes this timer great for dusty, dirty locations. At the other extreme the HG100 electromechanical dual-function timer does the job of two ordinary timers. With a single, easily-set dial it provides adjustable "on" and "off" time periods for cycles ranging from 30 seconds to 60 hours. It gives you unmatched ease of adjustment without setting cams or changing gears.

For detailed descriptions of one or both of these timers, get our CA Series Bulletin 322 and our HG Series Bulletin 320. Write Eagle Signal Division, E. W. Bliss Company, 736 Federal Street, Davenport, Iowa 52808; or call (319) 324-1361.

**BLISS**  **EAGLE SIGNAL**

A DIVISION OF THE E. W. BLISS COMPANY

\*E.A.G.L.E.—Engineering Assistance Given Locally—Effectively.

"For information on CA100 Timer circle reader service card number 241"

"For information on HG100 Timer circle reader service card number 242"



# 7.5 AMPS

10 WATTS  
TO-5

40 WATTS  
TO-59



A NEW CONCEPT IN POWER

# POWER

High current triple diffused planar NPN silicon power transistors are now available from Silicon Transistor Corporation in a choice of small packages. The STT2400—STT2406 25 MHz series comes in a TO-5 case and is priced from \$6.60 to \$21.40 per unit on orders of 100. The STT2800—STT2806 25 MHz series is in the TO-59 package and prices range from \$8 to \$24 per unit on orders of 100. They have a voltage

range of 30V-150V, maximum  $T_j$  is 200°C,  $C_{ob}$  is 200 pf. Typical applications include: high power, high frequency inverters and converters; switching type regulated power supplies; power linear amplifiers; compact power circuitry; RF power amplification. For more information, call or write today. For immediate delivery, contact your representative or distributor.

### TRIPLE DIFFUSED PLANAR—NPN

	Case	V <sub>CEO(sus)</sub> V <sub>EBO</sub>		I <sub>C</sub> max. P max.		h <sub>FE</sub>	h <sub>FE</sub> min.
		Volts	Volts	Amps	Watts		
STT 2400	TO-5	150	12	7.5	10	30-90	10 @ 6 Volts
STT 2401	TO-5	120	12	7.5	10	30-90	
STT 2402	TO-5	120	12	7.5	10	50-150	
STT 2403	TO-5	100	12	7.5	10	30-90	
STT 2404	TO-5	80	12	7.5	10	30-90	
STT 2405	TO-5	60	10	7.5	10	30-90	
STT 2406	TO-5	30	10	7.5	10	25 min.	10 @ 5 Volts
STT 2800	TO-59	150	12	7.5	40	30-90	
STT 2801	TO-59	120	12	7.5	40	30-90	
STT 2802	TO-59	120	12	7.5	40	50-150	
STT 2803	TO-59	100	12	7.5	40	30-90	
STT 2804	TO-59	80	12	7.5	40	30-90	
STT 2805	TO-59	60	10	7.5	40	30-90	15V
STT 2806	TO-59	30	10	7.5	40	25 min.	
TEST CONDITIONS	I <sub>C</sub>	200mA				2A	5A
	I <sub>B</sub>		10mA				
	V <sub>CE</sub>						

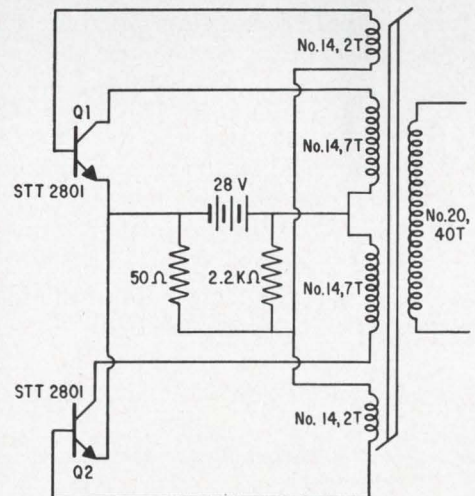

Silicon Transistor Corporation produces the broadest line of silicon power transistors in the industry.

## SILICON TRANSISTOR CORPORATION

Executive Offices and main plant: EAST GATE BLVD., GARDEN CITY, N.Y. 11530 (516) Pioneer 2-4100, TWX 510-222-8258

ON READER-SERVICE CARD CIRCLE 40



# Diode model is analyzed by computer

as one junction of a transistor. Analysis covers both linear and nonlinear circuit operation.

## Part 3 of a three-part series

Computer-aided circuit design requires good device models and accurate numerical values.

The modeling procedures for transistors were described in part 1 of this series.\* Part 2 showed how numerical values were assigned to the transistor model.† This final part describes the construction of the diode model and the measurements that determine the parameters.

The diode model shown in Fig. 1 is one junction of the transistor model. Like the transistor model, it covers both small-signal linear and large-signal nonlinear operation, accounting for both ac and dc components. A general description of the model, which is taken from *NET-1 Network Analysis Program 7090/94 Version* by Malmberg, Cornwell and Hofer is given in Part 1.

## Five parameters define diode model

The five parameters in Fig. 1 define the equivalent circuit of the diode. The diode resistances are  $R_B$ , the semiconductor bulk and contact resistance, and  $R_C$ , the junction ohmic leakage resistance.

The current generator,  $I$ , represents the diode junction current. It is related to junction voltage  $v$  by the equation:

$$I = I_s [\exp (q v / M k t) - 1], \quad (1)$$

where:

- $I_s$  = the diode saturation current,
- $q$  = electron charge,
- $M$  = emission constant (the factor by which the junction voltage and dynamic resistance are larger than the ideal values given by using  $q v / k T$ ),
- $k$  = Boltzmann's constant,
- $T$  = junction absolute temperature in °K,

\*See "Use a good switching transistor model," ED 12, June 7, 1967, pp. 54-59.

†See "Assign the correct numerical values," ED 13, June 21, 1967, pp. 60-66.

**Nathan O. Sokal**, President, and **Joseph J. Sierakowski**, Senior Engineer, Design Automation, Inc., Lexington, Mass., and **Jonathan J. Sirota**, Vice-President, Memory Technology, Inc., Waltham, Mass.

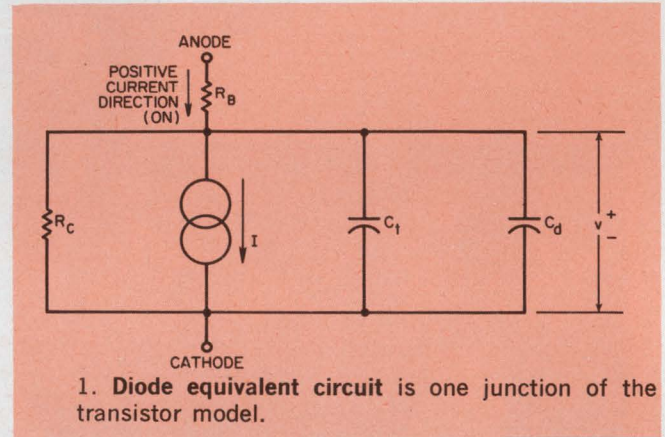

$v$  = bias voltage (positive for forward bias, negative for reverse bias).

$C_t$  is the junction transition (depletion-layer) capacitance, a small-signal capacitance which is a nonlinear function of junction voltage  $v$ :

$$C_t = D / (V_z - v)^N, \quad (2)$$

where:

- $D$  = proportionality constant,
- $V_z$  = junction contact potential (a positive number),
- $N$  = junction grading constant.

$C_d$  is the junction diffusion capacitance, a small-signal capacitance which is a function of junction current  $I$ :

$$C_d = q(I + I_s) / 2\pi M k T F, \quad (3)$$

where  $F$  is the intrinsic diode cutoff frequency.

The charge stored in the diffusion capacitance at a forward current  $I$  is  $I / 2\pi F$ . This can be verified simply by integrating  $C_d$  from zero current to the current  $I$ , expressing both  $C_d$  and  $v$  as functions of  $I$ . Thus  $F = 1 / 2\pi \tau$ , where  $\tau$  is the commonly used "charge storage factor" in  $Q_{STOR} = I \tau$ . The effect of transition capacitance on the apparent variation of cutoff frequency with  $I$  is similar to that discussed in Part 2 for the transistor cutoff frequencies.

The terminal voltage on the diode is defined as  $V_F$  in the forward direction and  $V_R$  in the reverse. As with the transistor parameters, three points on

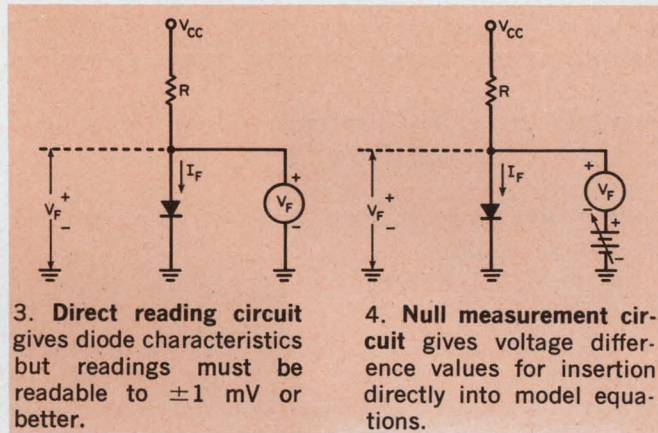
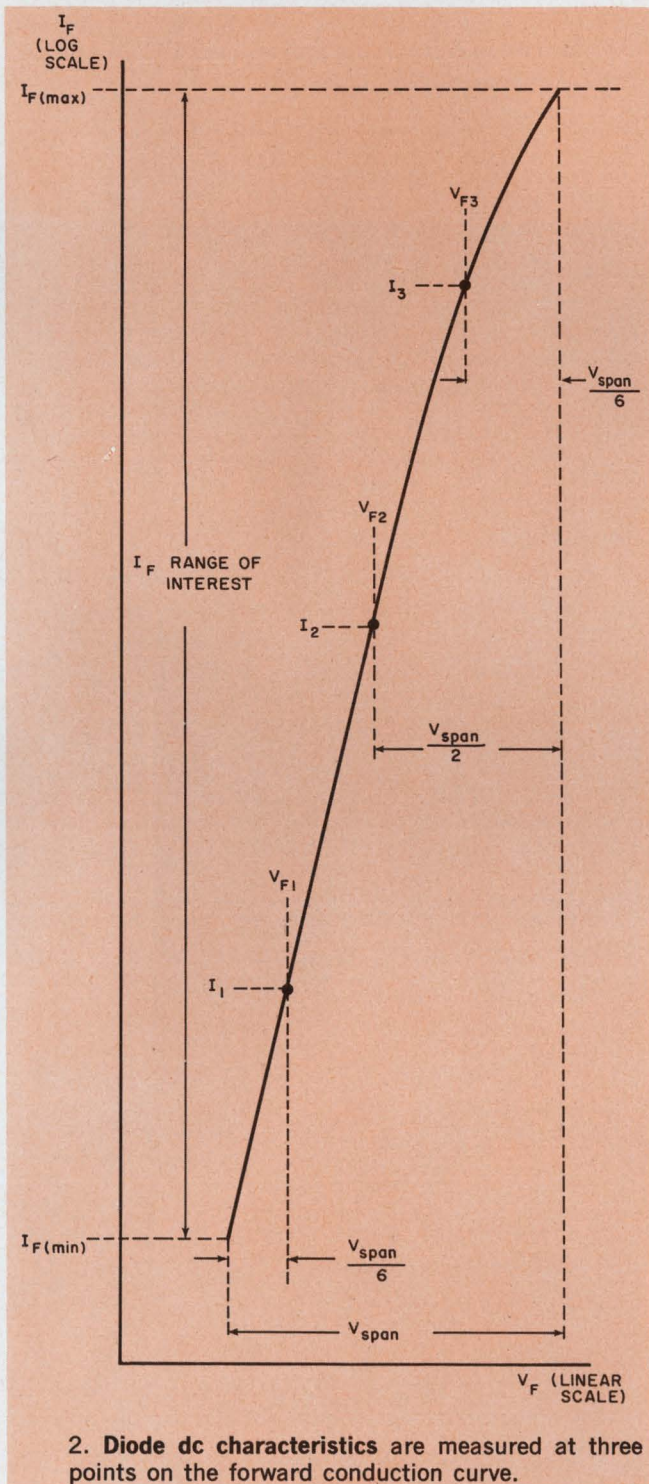

**Table: Diode constants and variables**

Symbol	Brief description
$C_A$	Average value of transition capacitance
$C_d$	Junction diffusion capacitance
$C_m$	Measured diode diffusion capacitance
$C_t$	Junction diffusion capacitance
$*D$	Transition capacitance proportionality constant
$*F$	Diode cutoff frequency
$*F'$	Apparent cutoff frequency
$I_F$	Forward current
$I_R$	Reverse current
$I_S$	Diode saturation current
$k$	Boltzmann's constant
$M$	Diode emission constant
$*N$	Junction grading constant
$q$	Electron charge
$R_B$	Diode ohmic series resistance
$R_C$	Junction ohmic leakage resistance
$T$	Junction absolute temperature
$T_S$	Diode storage time in test circuit
$v$	Junction voltage
$V_{CC}$	Dc supply voltage in test circuit
$V_F$	Forward terminal voltage
$V_R$	Reverse terminal voltage
$V_T$	Diode test voltage
$*V_Z$	Junction contact potential
$\tau$	Charge storage factor

\*Not used in dc steady-state calculations. Can be ignored if only dc steady-state analyses are being performed.

the diode forward conduction characteristics are needed:  $(V_{F1}, I_1)$ ,  $(V_{F2}, I_2)$ , and  $(V_{F3}, I_3)$ . The points should span the region of interest, as shown in Fig. 2. The measurement can be made either by the direct method (Fig. 3) or by the null method (Fig. 4).

The direct method can be used if the diode forward voltage can be read to a precision (not accuracy) of  $\pm 1$  mV.  $V_{CC}$  should be much larger than  $V_F$ . Choose  $R$  as  $R < (V_{CC(max)} - V_{F3})/I_3$ . Measure the desired three points on the diode forward characteristic by varying  $V_{CC}$ .

The null method uses two sources,  $V_{CC}$  and  $V_1$ .  $V_{CC} \gg V_F$ . The voltages should be measured with either a direct-coupled oscilloscope with 5-mV/cm sensitivity or a digital voltmeter with a resolution of 1 mV or better:

Measurement is performed in four steps:

- With  $V_1$  equal to zero, measure  $V_F$  at  $I_1$ . This is  $V_{F1}$ .
- Adjust  $V_1$  so that the voltmeter reads zero.  $V_1$  is now set to  $V_{F1}$ .
- Increase the current to  $I_2$ . The voltmeter reading is  $V_{F2} - V_{F1}$ .
- Repeat step 3 at a higher current to obtain  $V_{F3} - V_{F1}$  at  $I_3$ .

These readings are used directly in the equations which follow to determine the forward conduction parameters of the diode.

To determine the reverse bias parameters, a curve of the reverse current versus reverse voltages should be used for the reverse voltage range of interest, as in Fig. 5. The curve need not be extremely accurate because the reverse leakage is usually of minor importance; any value larger than a megohm will usually suffice.

### Equations for diode dc parameters

All measured quantities go directly into the equations that follow:

$$M = \frac{(V_{F3} - V_{F1}) [(I_2 - I_1)/(I_3 - I_1)] - (V_{F2} - V_{F1})}{\frac{kT}{q} \left[ \ln \left( \frac{I_{C2}}{I_{C1}} \right) - \ln \left( \frac{I_{C3}}{I_{C1}} \right) \right]} \quad (4)$$

$$R_B = [(V_{F3} - V_{F1}) - (MkT/q) \ln(I_3/I_1)] / (I_3 - I_1); \quad (5)$$

$$I_S = I_2 / \{ \exp[(q/MkT)(V_{F2} - I_2 R_B)] \}; \quad (6)$$

$$V_{F2} = (V_{F2} - V_{F1}) + V_{F1}; \quad (7)$$

$$q/k = 1.161 \times 10^4;$$

$$T = ^\circ\text{C} + 273.2.$$

If three points are known, use Eqs. 4 through 7.

If only two points are known, assume a value for  $R_B$ . An approximate value can be taken from the forward conductance specification. If it is known that a current  $I$  flows with  $V_F = 1$  volt, it can be assumed that approximately 0.25 volt is due

to  $I R_B$  drop. Then:

$$R_B \approx 0.25/I. \quad (8)$$

When only two points are known,  $M$  is taken from:

$$M = (q/kT) \{ [(V_{F2} - V_{F1}) - R_B(I_2 - I_1)] / \ln(I_2/I_1) \}. \quad (9)$$

If only one point is known, assume values for both  $R_B$  and  $M$ . To simulate a diode with low voltage drop and dynamic resistance,  $M$  can be chosen between 1.0 and 1.5. A diode with high voltage drop and dynamic resistance can be simulated by choosing  $M$  between 1.5 and 2.2.  $I_S$  is again found from Eq. 6.  $R_B$  can be assumed as before.

The usual range for the values of  $M$ ,  $R_B$ , and  $I_S$  are 1.0 to 2.2 for  $M$ ,  $10^{-5}$  to  $10^{-1}$  kilohm for  $R_B$ , and  $10^{-12}$  to  $10^{-6}$  mA for  $I_S$  (silicon), and  $10^{-8}$  to  $10^{-2}$  mA for  $I_S$  (germanium).

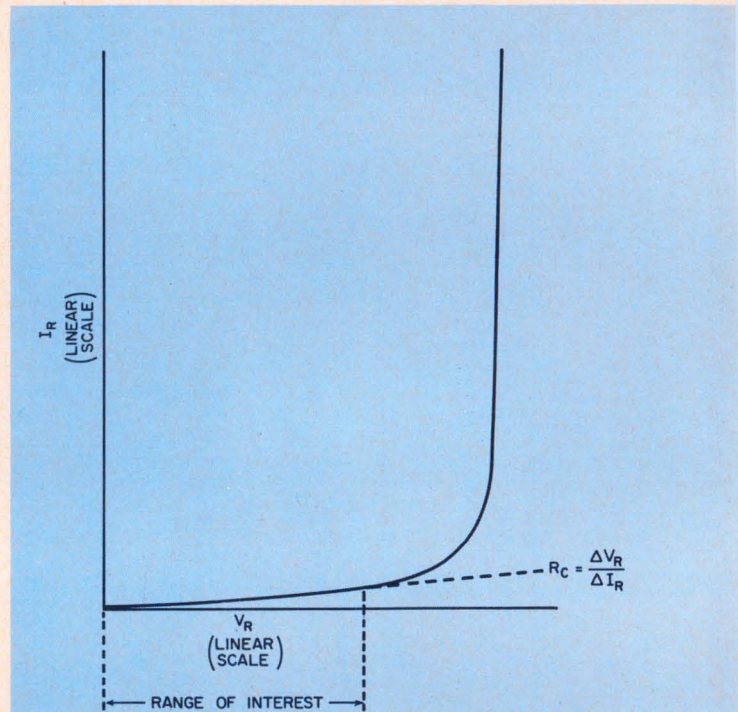

5. Diode reverse current characteristic gradient is used to determine  $R_C$ , the junction ohmic leakage resistance.

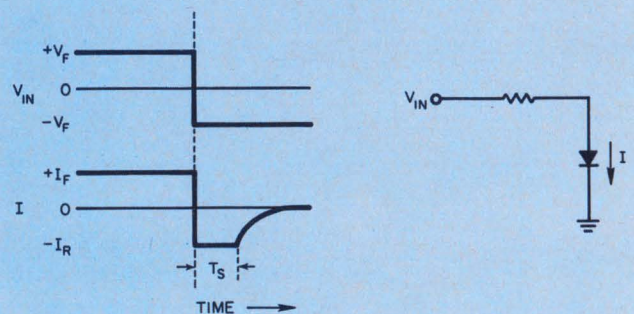

6. Storage time is measured to determine cutoff frequency. It is measured from the  $I_F/I_R$  transition to the point where  $I_R$  begins to decrease.

$R_c$  is found from the reverse characteristics of the diode with the best straight-line fit over the voltage range of interest, as in Fig. 5.

$$R_c = \Delta V_R / \Delta I_R \quad (10)$$

The diode transition capacitance is found by the same procedures as are used in Part 2 to determine the transistor transition capacitances.

### Diode cutoff frequency is derived from storage time

The diode cutoff frequency can be found from the diode storage time,  $T_s$ , when the diode is switched from a forward current,  $I_F$ , to a reverse current,  $-I_R$ , as in the test circuit of Fig. 6. The measurement should be made at values of  $I_F$  and  $I_R$  close to the values intended for actual circuit operation, if possible. The test current is assumed to switch instantaneously from  $I_F$  to  $-I_R$ .  $T_s$  is measured from the time of the  $I_F$ -to- $-I_R$  transition to the time that the reverse current magnitude begins to decrease, as shown in Fig. 6. If no clearly defined region of constant reverse current exists,  $T_s$  can be measured to the time that the junction voltage becomes zero. Time zero can be taken as the middle of the  $I_F$ -to- $-I_R$  transition. Note that this definition of storage time is not the same as another one in common use—the time until the reverse current (charging the transition capacitance to a reverse voltage) has decreased to a specified value, on the order of 10% of  $I_R$ .

As with the transistor cutoff frequencies, direct observation of the diode intrinsic cutoff frequency is obscured by the effect of  $C_t$  shunting  $C_d$ . Both these capacitances are varying during the turnoff transient. The apparent cutoff frequency is:

$$F' = \{\ln[1 + (I_F/I_R)]\} / 2\pi T_s \quad (11)$$

If the transition capacitance,  $C_t$ , is small compared with the diffusion capacitance,  $F'$  will be close to  $F$ . The shunting effect of  $C_t$  can be accounted for approximately by hand calculation, if desired, as follows.

The intrinsic cutoff frequency is:

$$F \approx F' / [1 - (F'/F_A)], \quad (12)$$

where:

$$F_A = [q(I + I_s)] / 2\pi M k T C_A \quad (13)$$

Here  $C_A$  is the value of the transition capacitance averaged over the storage time interval. It can be taken as the capacitance at a forward bias of  $V_F$ , which is the voltage at a forward current of  $I_F/2$ .

$$C_A = C_m [(V_Z - V_T) / (V_Z - V_F)]^N \quad (14)$$

Usually  $I_s \ll I$  and can be ignored. In Eq. 13  $I$  can be taken as  $I_F/2$ , so that:

$$F = \frac{F'}{1 - [F' 2\pi M (kT/q) C_A] / (I_F/2)} \quad \blacksquare \blacksquare$$

### Free reprints available

You may obtain a single reprint of the entire three-part series on transistor and diode models by circling 250 on the Reader Service Card.

# OSCILLATORS

< 1 Hz to 125 MHz



**FOR  
INTEGRATED  
CIRCUIT  
APPLICATION  
COMPATIBILITY**

If your new system is utilizing integrated circuits, let Accutronics assist you with your oscillator requirement. Operating on voltages as low as 3 volts the I.C. Series can provide an output level to drive all forms of gates, flip-flops, multivibrators, etc. Typical output levels would be 2 volts to 2.8 volts peak to peak with a 3 volt supply. Rise and fall times of <20 nanosec. are typical. Sine wave outputs can be provided with <5% distortion and frequency stabilities from  $\pm 0.0001\%$  to  $\pm .5\%$ . Can we be of service? Call collect Area 312, 232-2600.

### HG Series

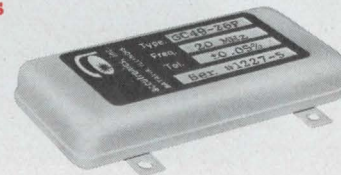

**PRICE: \$115.00 to \$185.00**

FREQUENCY: 1 MHz to 45 MHz  
 FREQUENCY TOLERANCE:  $\pm 0.005\%$  over temperature range  
 FREQUENCY ACCURACY:  $\pm 0.002\%$  or better at 25°C  
 TEMPERATURE RANGE: 0°C to +75°C  
 OUTPUT POWER: Will provide outputs to work into T<sup>2</sup>L, RTL, DTL, etc. circuitry when specified. Sine wave, 1V rms into 1K with 3 to 15% distortion depending on frequency.  
 OSCILLATOR VOLTAGE: 3 volts to 30 volts DC as specified  
 DIMENSIONS: 1½x3½x½" high

### NJ Series

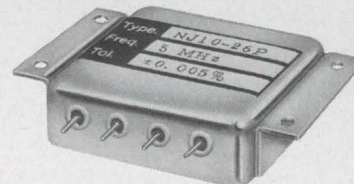

**PRICE: \$122.00 to \$197.00**

FREQUENCY: 500 KHz to 50 MHz  
 FREQUENCY TOLERANCE:  $\pm 0.005\%$  or better over temperature range  
 FREQUENCY ACCURACY:  $\pm 0.002\%$  or better at 25°C  
 TEMPERATURE RANGE: -20°C to +60°C  
 OUTPUT POWER: Will provide outputs to work into T<sup>2</sup>L, RTL, DTL, etc. circuitry when specified. Sine wave, 1V rms into 1K with 3 to 15% distortion depending on frequency.  
 OSCILLATOR VOLTAGE: 3 volts to 30 volts DC as specified  
 DIMENSIONS: 1½x1½x½ to 1½" high depending on frequency

## accutronics, inc.

628 North St., Geneva, Illinois  
 Area 312, 232-2600.

ON READER-SERVICE CARD CIRCLE 41

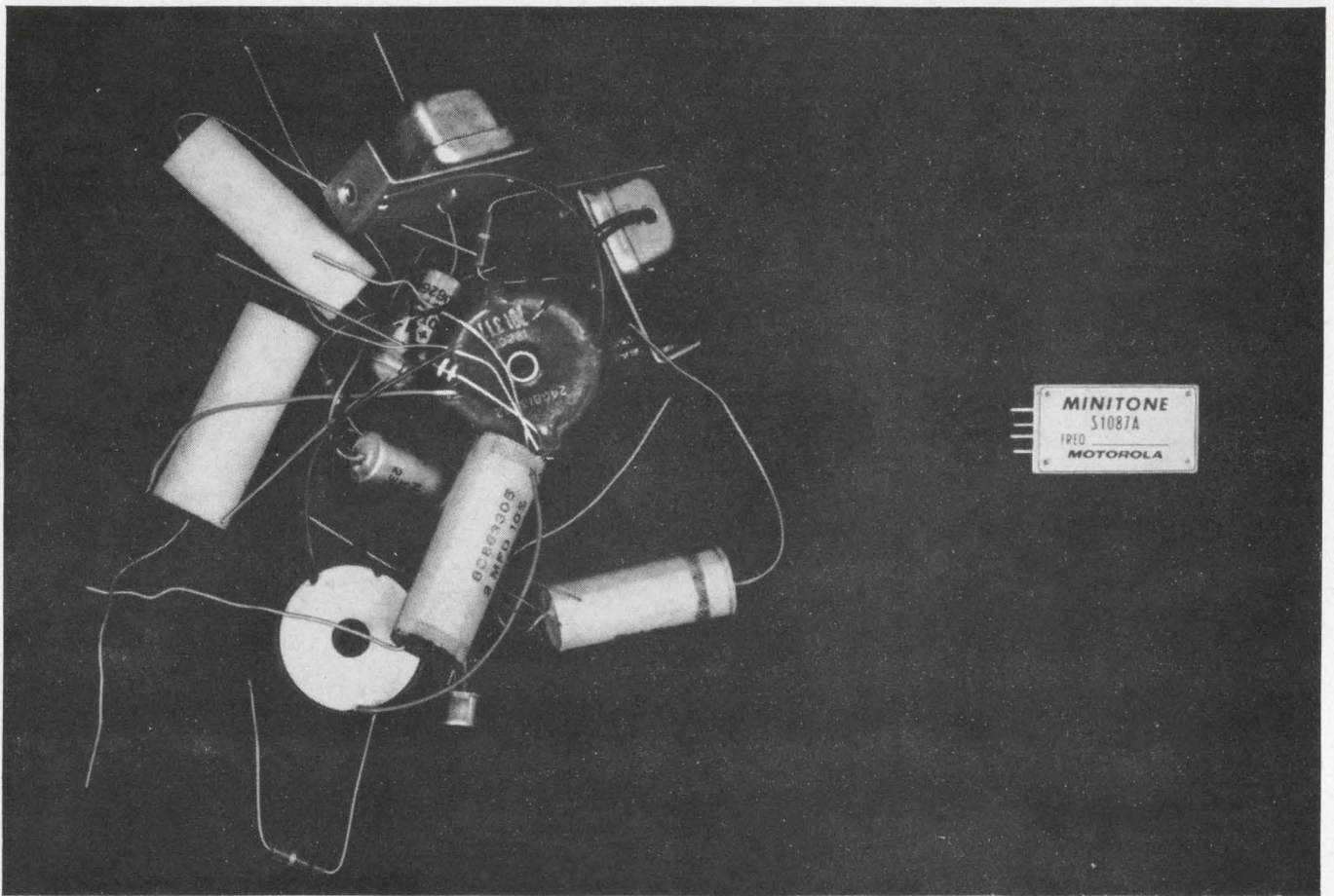

## Two ways to achieve selective signaling

### The MINITONE reed on the right does it better

Motorola's new miniaturized resonant reed either generates a highly stable audio tone, or provides very selective decoding. It does the job better because it's small, has excellent stability, and contains no contacts to wear out. And the MINITONE resonant reed is more economical; it eliminates the expense of extra components and design time needed to build highly selective tone oscillators and associated compensating circuits. Take a look at these facts:

SEE IT AT BOOTHS 3116 & 7 AT WESCON



<b>SMALL SIZE:</b> About 1/4 of a cubic inch in volume. Measures only 1.11" x 0.619" x 0.393".
<b>LONG LIFE:</b> No contacts to wear out or cause malfunctions; life comparable to solid-state devices. Plus 3-year warranty.
<b>HIGH STABILITY:</b> Frequency tolerance $\pm 0.1\%$ . Temperature stability better than $\pm 0.001\%$ per $^{\circ}\text{C}$ between $-30^{\circ}\text{C}$ and $+100^{\circ}\text{C}$ ( $25^{\circ}\text{C}$ reference).
<b>WIDE FREQUENCY RANGE:</b> From 67 Hz up to 3150 Hz.
<b>QUICK DELIVERY:</b> Over 200 standard frequencies available from stock.
<b>RUGGED CONSTRUCTION:</b> Exceeds E.I.A. standards for shock and vibration.
<b>PROVEN PERFORMANCE:</b> Reeds have been proven in thousands of demanding situations, such as in aviation, control systems and radio communications applications.
FOR MORE INFORMATION contact your Motorola representative. Or write for bulletin TIC-3214
<b>MOTOROLA COMMUNICATIONS AND ELECTRONICS INC.</b> 4900 West Flournoy Street Chicago, Illinois 60644. A subsidiary of Motorola Inc.

ON READER-SERVICE CARD CIRCLE 42

# Tips on cooling off hot transistors

See how circuit designers use IERC heat dissipators to protect semiconductors...improve circuit performance and life.

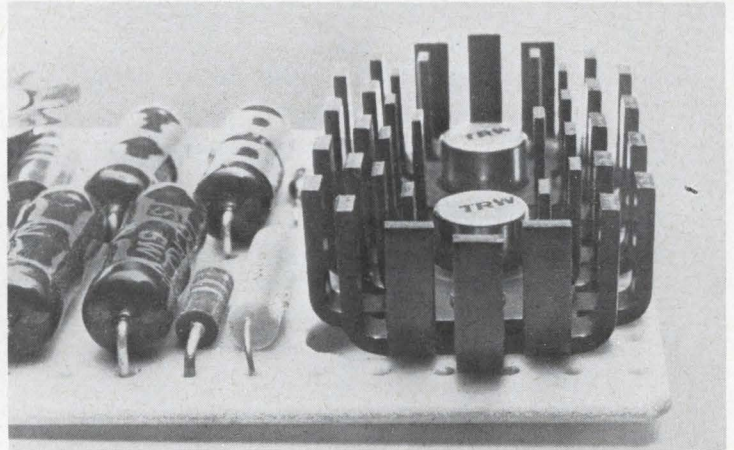
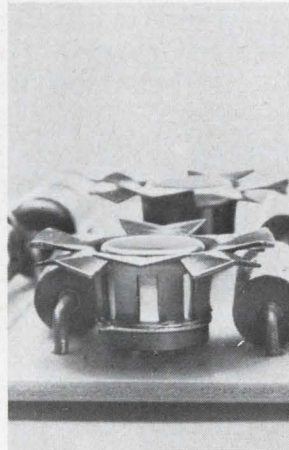
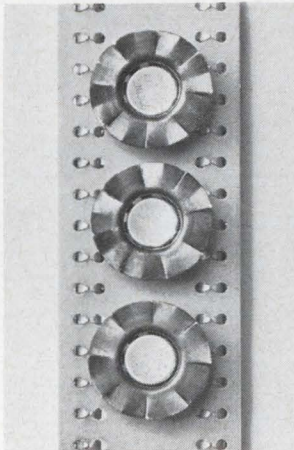

Fan-top dissipators for TO-5 and TO-18 cases drop temperatures dramatically; cost just pennies. T-shape adds almost nothing to board height; allows components to snuggle close to transistors. Spring fingers provide fast, press-on installation.

To cool off low-to-medium power transistors in TO-5 and TO-18 cases, use IERC's efficient LP's. Patented, staggered-finger design maximizes radiation and convection efficiency, radiates heat directly to ambient. Available in single or dual mounting for thermal mating of matched transistors.

IERC Thermo-Link Retainers provide efficient thermal links between transistors and chassis or heat sinks. (Also, excellent dissipation when used on p-c boards.) Integral BeO washers reduce capacitance up to 2/3. Fast, no-snap installation; transistors are firmly held.

New! Dissipators and retainers for plastic and epoxy transistors. 3 new series for RO-97A, RO-97 and X-20's. Permit a jump of 10% to 33% in operating power.

Free 8-page short form catalog discusses IERC's complete line of dissipators, retainers and tube shields. Gives specifications, prices, how to order. Send for your copy today.

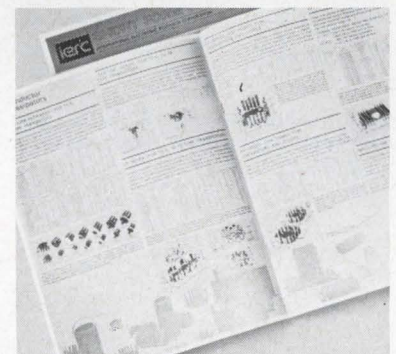
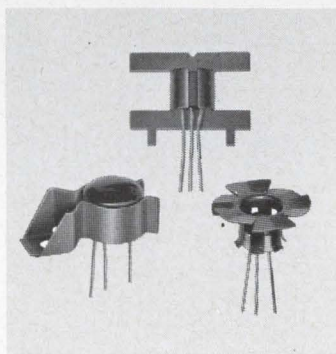
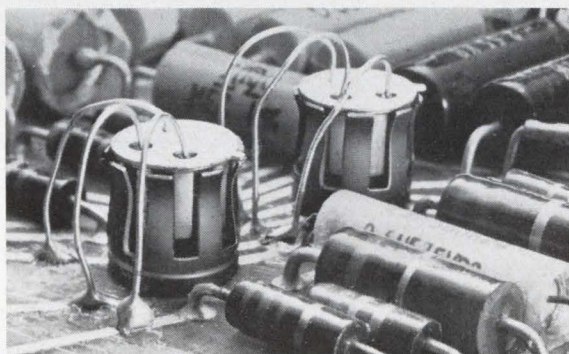

**Special insulating coating** — Insulube 448, a special non-hygroscopic finish developed by IERC, combines excellent dielectric properties, 50 K megs insulation resistance, and high heat emissivity. Also protects against salt spray, fungus, etc.

**Tough heat dissipating problem?** IERC engineers welcome your letter-head inquiry for specific information or assistance in selecting heat dissipators.

**ierc**  
SEMICONDUCTOR  
HEAT DISSIPATORS

INTERNATIONAL ELECTRONIC RESEARCH CORPORATION • A corporate division of Dynamics Corporation of America  135 West Magnolia Ave. • Burbank, Calif. 91502

ON READER-SERVICE CARD CIRCLE 43

# Mismatching for low noise

in amplifiers becomes simple with a nomograph that shows the lowest noise figure in one step.

In many systems the main design objective is low noise, instead of maximum power transfer. A deliberately created mismatch between an amplifier and its source will achieve this objective, provided that the mismatch ratio is the proper one. To find the ratio, use the nomograph below.

The theoretical explanation rests on a simple equation<sup>1</sup> that computes the noise figure:

$$F = 1 + (R_s/R_L) + R_n(1 + R_s/R_L)^2/R_s,$$

where:

- $R_s$  = source resistance,
- $R_L$  = input impedance of transistor, in parallel with the resistive component of the tuned circuit,
- $R_n$  = equivalent noise input resistor<sup>2</sup> of transistor.

The circuit in the figure helps to interpret the symbols.

The actual noise resistor of a transistor need not be known if a noise figure can be measured for any specific match or mismatch between  $R_s$  and  $R_L$ .

The noise figure is plotted in the nomograph for any mismatch ratio,  $R_s/R_L$ , as well as for different transistor noise resistors,  $R_n$ .  $R_n$  is normalized to the input resistance  $R_L$ . Since there is an optimum  $R_s/R_L$  for each  $R_n/R_L$  curve, there is only one  $R_n/R_L$  curve that applies to a given situation.

Assume, for example, a noise figure of 3.8 dB for the matched condition,  $R_s/R_L = 1$ . The 0.1  $R_n/R_L$  curve intersects this point in the graph. The null point of this curve occurs at a mismatch ratio of 0.3 for  $R_s/R_L$  or 3.3 for  $R_L/R_s$ . This optimum ratio improves the noise figure to 2.8 dB. In fact, there is no loss in sensitivity for mismatch ratios extending from the  $R_s/R_L = 1$  line to the point where the curve of maximum mismatch ratio intersects the noise figure curve. For  $R_n/R_L = 0.1$ , this range of mismatch ratio extends from  $R_s/R_L = 1$  to  $R_s/R_L = 0.09$ . ■ ■

**References:**

1. Mischa Schwartz, *Information Transmission, Modulation, and Noise* (New York: McGraw-Hill Book Co., 1959), Chap. 5.
2. W. A. Rheinfelder, *Design of Low-Noise Transistor Input Stages* (New York: Hayden Pub. Co., 1964).

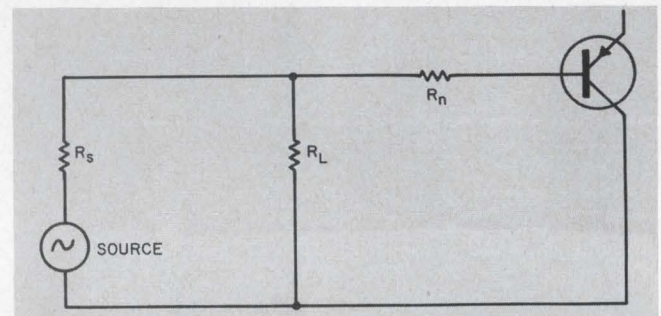

Typical preamplifier circuit includes the source and the amplifier. For optimum noise figure, a deliberate mismatch is introduced between the two.

**Herbert S. Antman**, Research Engineer, Edo Corp., College Point, N. Y.

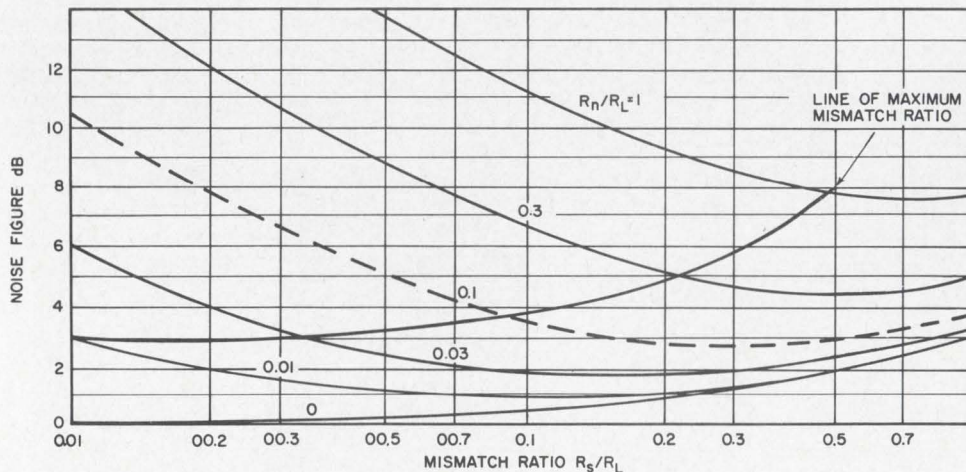

Noise figure and mismatch ratio are related in this graph. The dashed curve illustrates the example in the text. Once a noise figure has been measured for any known match, the optimum noise figure and the appropriate mismatch ratio can be read off.



# New CVC AutoMate™...The Decision Maker

## Just Touch The Control...

## AutoMate Does The Rest

An AutoMate™ control system will handle your vacuum cycle for production—and do it automatically. AutoMate is engineered to make human decisions without human errors. Think what this means:

*Finger-tip control* on the AutoMate Decision Control Center...relieves operators from further machine attendance.

*Automatic sequence operation*...the cycling decision is made and carried out in response to actual pressure in the system.

*Repeatable performance*...get exactly the same results every time.

So let AutoMate make the vacuum decisions to free your operator for more important tasks in your production process. Use AutoMate in electronics, optics, ceramics, metallurgy.

AutoMate gives you a complete system with automatic control center, chamber, pumping system, and gauge. These elements have been human-engineered into a new design that makes AutoMate stand for the latest technological advances in high-vacuum automation. Write for details. Consolidated Vacuum Corporation, Rochester, N.Y. 14603. Subsidiary of Bell & Howell.



**AutoMate Automatic Control Center** as installed on CVC's new systems. Just touch the control—AutoMate does the rest. This Control Center introduces a whole new era of automated high-vacuum systems. Watch for more... from CVC.



**This Babcock  
10 amp. relay  
also  
switches  
dry circuit  
with the  
same contact set**

Now, your Babcock 10 amp. full size crystal can relay will also switch dry circuit with the same set of contacts. These exclusive universal contacts have greatly simplified your relay stocking requirements. You can order one model to meet a given set of performance parameters without concern for load requirement — *at no cost premium*. Get complete information about this versatile relay, and the entire Babcock line, all with universal contacts.

Write Babcock Relays, Division of Babcock Electronics Corporation, 3501 Harbor Boulevard, Costa Mesa, California 92626; or telephone (714) 540-1234.



The Babcock Model BR7 relay will perform from dry circuit to 10 amps., with universal contacts, and is designed to meet critical aerospace applications.

**SPECIFICATIONS**

**SIZES**  
1.300" h. x 1.075" l. x .515" w

**WEIGHT:**  
Approx. 1.0 oz.

**CONTACT ARRANGEMENTS:**  
SPDT and DPDT

**PULL-IN POWER:**  
Low as 80 mw.

**LIFE:**  
100,000 operations, min.

**TEMP. RANGE:**  
-65°C to +125°C

**FROM THE BABCOCK FAMILY OF CRYSTAL CAN RELAYS**



**TWICE SIZE  
4PDT**  
dc to 10 Amps.



**FULL SIZE  
DPDT**  
dc to 10 Amps.



**HALF SIZE  
SPDT & DPDT**  
dc to 2 Amps.



**SIXTH SIZE  
SPDT & DPDT**  
dc to 1 Amp.

**WATCH FOR BABCOCK RELAYS ON THE EDN MOBILE DISPLAY — SOON IN YOUR AREA.**

# ELECTRONIC DESIGN

## semiannual index of articles

January-June, 1967

---

The articles in each section of this index are grouped under key words, which are intended to indicate the general topic to which the articles refer. The same article may be listed more than once, if its main concern is more than one of these generalized topics.

---

### Automatic Controls and Servos

- AIRCRAFT: Proximity switch senses status of undercarriage . . . . . NEWS, ED 13, p. 33.
- AUTOMATA: Will the machines eventually outwit man? . . . . . SR, ED 1, p. 82.
- COUNTERS: Variable preset counter uses inexpensive relays . . . . . IFD, ED 4, p. 113.
- DAMPING: Inertia damping lends itself well to high-velocity servosystems . . . . . ART, ED 8, p. 72.
- ELECTRIC CARS: 'Automatic' drive used for large electric vehicles . . . . . NEWS, ED 7, p. 14.
- INDICATORS: Ac level indicator lights a lamp . . . . . IFD, ED 12, p. 106.
- INFRARED unit spots circuit production flaws . . . . . NEWS, ED 4, p. 32.
- MOTOR-CONTROL: Motor has dynamic braking with a two-wire control . . . . . IFD, ED 6, p. 284.
- Ring counter reverses multiphase motor rotation . . . . . NASA, ED 7, p. 103.
- Simple circuits control dc motor speed . . . . . IFD, ED 7, p. 94.
- Solid-state circuit controls dc motor . . . . . NASA, ED 7, p. 102.
- Spst switch reverses PM dc motor rotation . . . . . IFD, ED 9, p. 245.
- Switch from hot to cool with one of these three solid-state motor speed control circuits . . . . . ART, ED 4, p. 98.
- Tuning fork locks motors in step . . . . . NEWS, ED 8, p. 44.
- PHASE: Monitor phase lead or lag automatically with IC logic . . . . . IFD, ED 8, p. 102.
- POWER SUPPLIES: Power supply protected by simple circuits . . . . . IFD, ED 8, p. 100.
- Protect power supply against overloading . . . . . IFD, ED 5, p. 110.

- Texas power utility goes fully automatic . . . . . NEWS, ED 6, p. 13.
- PROCESS CONTROL: Use ICs in process control . . . . . ART, ED 1, p. 118.
- SECURITY SYSTEMS: Car thieves foiled by digital ignition . . . . . NEWS, ED 8, p. 33.
- Electronic aids sought to outwit criminals . . . . . NEWS, ED 7, p. 17.
- Hidden mikes protect schools against vandals . . . . . NEWS, ED 5, p. 14.
- Simple components make up audible visual alarm . . . . . IFD, ED 12, p. 92.
- TRAFFIC CONTROLS: Sperry traffic system encounters roadblock . . . . . NEWS, ED 8, p. 13.
- Traffic light uses numerical display . . . . . NEWS, ED 3, p. 36.
- TURBINE: Fm unit monitors whirling turbine . . . . . NEWS, ED 11, p. 20.
- WATER TABLE: Fiberoptics sense water level . . . . . IFD, ED 2, p. 86.

### Careers and Management

- CONTRACTS: Make your next proposal sell the services and products you offer . . . . . C&M, ED 11, p. 96.
- Pinpoint your profits during the negotiation of incentive contracts . . . . . C&M, ED 4, p. 104.
- DESIGN: Look ahead before you freeze the design . . . . . EDIT, ED 10, p. 53.
- Stop wasting design time. Keep a good notebook of basic circuits . . . . . ART, ED 11, p. 75.
- JOB SECURITY: Life begins at 40. Will it for you? . . . . . EDIT, ED 8, p. 51.
- Needed: A way to tame the gypsy in us . . . . . EDIT, ED 4, p. 75.
- What happens to your job if peace breaks out? . . . . . EDIT, ED 6, p. 227.
- 250,000 new jobs seen under SST program . . . . . NEWS, ED 8, p. 14.

- OPPORTUNITIES: And where are the Steinmetzes of today? . . . . . EDIT, ED 5, p. 55.
- PERSONALITY TESTS: Cheat on personality tests by giving the tester what he wants C&M, ED 5, p. 92.
- SALARIES: Engineer salaries continue to climb . . . . . NEWS, ED 12, p. 13.
- WRITING: Cut the 'noise' out of your next article . . . . . C&M, ED 6, p. 270.

### Circuits and Mathematical Analysis

- ADDERS: Hybrid technique applied to a binary full adder . . . . . IFD, ED 10, p. 98.
- AGC CIRCUIT handles wide input range . . . . . NASA, ED 5, p. 100.
- ALARM SYSTEMS: Simple components make up audible visual alarm . . . . . IFD, ED 12, p. 92.
- AMPLIFIERS: Cascaded RF amplifier modules yield gain to 70 dB . . . . . PF, ED 10, p. 108.
- Design a dc level-shifting amplifier . . . . . ART, ED 10, p. 60.
- Design a log amp with tunnel diodes . . . . . ART, ED 11, p. 62.
- "Diode follower" provides undistorted variable pulse . . . . . IFD, ED 2, p. 84.
- Don't guess the spurious level of an amplifier . . . . . ART, ED 3, p. 70.
- FET cascode amplifier features small current variations . . . . . IFD, ED 4, p. 118.
- High input impedance obtained in differential amplifier . . . . . IFD, ED 4, p. 114.
- Low noise is achieved in wide-band amplifier . . . . . IFD, ED 1, p. 140.
- Noninverting operational amplifier has fixed zero offset . . . . . IFD, ED 12, p. 100.
- Put operational amplifiers to work . . . . . ART, ED 2, p. 66.
- Simplify feedback amplifier design . . . . . ART, ED 2, p. 52.

**index of articles, continued**

Stagger-tune the IC amplifier stages  
 .....ART, ED 9, p. 236.  
 Ultrastable op-amp needs no supply regulation ...PF, ED 1, p. 150.  
**CHOPPERS:** Parallel transistors cut chopper losses  
 .....NASA, ED 3, p. 106.  
**CLOCKS:** Four-layer diode clock has relay closure output.....IFD, ED 10, p. 92.  
**COMPUTER-AIDED DESIGN:** Assign the correct numerical values to transistor models ART, ED 13, p. 60. Computer-aided design workshop at IITRI .....NEWS, ED 1, p. 14. Computer-analyze your circuit .....ART, ED 12, p. 54.  
**SCEPTRE** gives designers new power .....ART, ED 6, p. 230. You don't have to be a programmer to use a time-shared computer to solve design problems.....ART, ED 8, p. 54.  
**CONTROLS:** Low-voltage IC controls high output ...IFD, ED 7, p. 96.  
**CONVERTERS:** Integrated logic converts frequency IFD, ED 7, p. 95. Resistance-to-frequency conversion can be made directly by modification of a Colpitts oscillator .....ART, ED 1, p. 108.

Sine- to square-wave converter is self-powered IFD, ED 8, p. 106. Temperature regulator circuit stabilizes converter IFD, ED 9, p. 244.  
**COPIER:** Oscilloscope used to copy Polaroid photographs.....IFD, ED 11, p. 118.  
**COUNTERS:** Simple logic reads out during counting .....NASA, ED 11, p. 107.  
**COUPLING** circuit has dc dead zone .....IFD, ED 10, p. 96. Probe in resonator wall changes coupling of filters.....IFD, ED 1, p. 146.  
**CRYSTALS:** Inductor ups crystals' bandwidth to 2% .....ART, ED 6, p. 244.  
**DELAY LINES:** Mix delay lines and transmission lines for a lossless, wideband network .....ART, ED 7, p. 90. Pulse-width discriminator eliminates delay line IFD, ED 2, p. 86.  
**DETECTORS:** Phase detector uses single transistor .....IFD, ED 12, p. 94. Pulse peak detector uses matched dual-input transistor.....IFD, ED 13, p. 96.  
**DETONATORS:** Semiconductor sets charges off safely .....NEWS, ED 9, p. 22.

**DIGITIZER:** Try this integrated-circuit digitizer .....ART, ED 3, p. 62.  
**DIODE:** Diode and battery form low-voltage Zener diode.....IFD, ED 13, p. 104.  
**DISCRIMINATORS:** Integrated switching circuit used as a discriminator .....IFD, ED 7, p. 95. Pulse-width discriminator eliminates delay line IFD, ED 2, p. 86.  
**DISPLAYS:** Block the sneak paths in a crossbar readout .....IFD, ED 6, p. 288. Electronic pad transmits hand-written messages ...IFD, ED 1, p. 138.  
**DRIVE CIRCUITS:** Bidirectional dc drive circuit has ac preamplifier .....IFD, ED 13, p. 102.  
**FAN-IN:** Microcircuit gate-extender makes fan-in reducer.....IFD, ED 8, p. 100.  
**FILTERS:** Active filter design made easy with hybrid RC modules .....PF, ED 4, p. 126. Controlled active RC filter circuitry gives lab unit wide applications .....PF, ED 3, p. 110. Coupling posts in comb-line filters boost performance .....IFD, ED 10, p. 90. If you need active filters with flat amplitude and time delay responses .....ART, ED 8, p. 78.

Make a filter out of an oscillator .....ART, ED 10, p. 56. Probe in resonator wall changes coupling of filters.....IFD, ED 1, p. 146. RC bandpass filter is adapted to miniaturized construction.....NASA, ED 11, p. 108. Take a fresh look at filters .....ART, ED 1, p. 114.  
**FREQUENCY DIVISION:** UJT and ac current source used to divide frequency .....IFD, ED 2, p. 82.

**Subject Listing**

- |                                    |                                  |
|------------------------------------|----------------------------------|
| Automatic Controls and Servos      | Military Electronics             |
| Careers and Management             | Missiles and Space               |
| Circuits and Mathematical Analysis | Navigation and Guidance          |
| Communications                     | Oceanology                       |
| Components                         | Packaging                        |
| Computers and Data Processing      | Physics                          |
| Consumer Electronics               | Power Sources                    |
| Editorials                         | Production Processes and Cooling |
| Industrial Electronics             | Radio Frequency Interference     |
| Industry (General)                 | Reliability                      |
| Materials                          | Research and Development         |
| Medical Electronics                | Semiconductors                   |
| Microelectronics                   | Telemetry                        |
| Microwaves                         | Test Equipment and Measurement   |
|                                    | Tubes                            |

**Departments keys**

- |      |                        |
|------|------------------------|
| ART  | Technical Article      |
| C&M  | Careers and Management |
| DD   | Design Decision        |
| EDIT | Editorial              |
| ENG  | Engineering Data       |
| DATA |                        |
| IFD  | Ideas for Design       |
| NASA | NASA Tech Briefs       |
| NEWS | News                   |
| PF   | Product Feature        |
| SR   | Special Report         |

- GENERATORS:** A four-layer diode forms double-pulse generator... IFD, ED 9, p. 243.  
Build a squarewave generator with \$3 worth of components... IFD, ED 13, p. 100.  
Design a high-voltage pulse generator with a tape-wound toroidal core... ART, ED 12, p. 66.  
Generate pulses by varying length of the termination line... IFD, ED 3, p. 94.  
Generate time functions digitally... ART, ED 5, p. 59.  
Generation of 3-phase square waves simplified... IFD, ED 8, p. 106.  
Pulse bursts generated with all-IC logic... IFD, ED 7, p. 97.  
Pulse generator uses IC logic... IFD, ED 10, p. 94.  
Random-signal generator uses Zener diode... IFD, ED 12, p. 98.  
Two SCRs form pulse generator... IFD, ED 13, p. 98.  
Two transistors give sawtooth in phase with line voltage... IFD, ED 4, p. 113.
- HUMOR:** These surrealistic circuits create more problems than they solve... ART, ED 1, p. 130.
- HYBRID CIRCUITS:** Pick the right hybrid technique... ART, ED 6, p. 250.
- ICs:** Design a better integrated circuit... ART, ED 4, p. 78.  
Get pnp class-B efficiency... ART, ED 6, p. 238.  
Integrated circuits shed their wires... NEWS, ED 4, p. 17.  
Looking for a 'universal circuit'?... ART, ED 3, p. 48.
- IMPEDANCE:** Simple circuit measures impedances at af... IFD, ED 11, p. 111.
- INSULATION:** Pocket radio detects corona or insulation breakdown... IFD, ED 11, p. 114.
- INTEGRATORS:** A novel integrator results by grounding its capacitor... IFD, ED 12, p. 90.
- INVERTERS:** Disregard load impedance in SCR inverter design... ART, ED 11, p. 68.
- LOGIC CIRCUITS:** Electron tunneling speeds logic switching... NEWS, ED 8, p. 36.
- MAGNETIC COILS:** Ease the design of magnet coils... ENG DATA, ED 3, p. 76.  
Simplify magnetic-core coil design... ART, ED 10, p. 78.
- MEMORIES:** Latching relay and SCR memorize last input pulse... IFD, ED 12, p. 92.
- MINIATURIZATION:** RC bandpass filter is adapted to miniaturized construction... NASA, ED 11, p. 108.
- MIXERS:** Improve FM performance with FETs... ART, ED 5, p. 63.  
Y-parameters simplify mixer design... ART, ED 7, p. 68.
- MODULATORS:** Amplitude modulator uses differential amplifier... IFD, ED 11, p. 116.
- MOTOR CONTROL:** Ring counter reverses multiphase motor rotation... NASA, ED 7, p. 103.  
Solid-state circuit controls dc motor... NASA, ED 7, p. 102.  
Spst switch reverses PM dc motor rotation... IFD, ED 9, p. 245.  
Switch from hot to cool with one of these three solid-state motor speed control circuits... ART, ED 4, p. 98.  
Tuning fork locks motors in step... NEWS, ED 8, p. 44.
- MULTIVIBRATORS:** Astable multivibrator has timing interval as long as one cycle per 6.7 minutes... IFD, ED 11, p. 110.  
Multi's duty cycle varies without affecting pulse shape... IFD, ED 3, p. 96.  
Precision one-shot uses inexpensive integrated circuits... IFD, ED 12, p. 100.  
Schmitt trigger hysteresis memorizes its last state... IFD, ED 3, p. 98.
- NOTEBOOK:** Stop wasting design time. Keep a good notebook of basic circuits... ART, ED 11, p. 75.
- OPTICAL READER** is not affected by light intensity variations... IFD, ED 4, p. 112.
- OSCILLATORS:** Af oscillator uses crystal and neon bulb... IFD, ED 11, p. 111.  
Crystal-controlled oscillator employs microcircuit... IFD, ED 11, p. 116.  
LC oscillator tank circuit built with just one FET... IFD, ED 5, p. 104.  
Low-drain SCS forms relaxation oscillator... IFD, ED 1, p. 144.  
MOSFET and bipolar form RC phaseshift oscillator... IFD, ED 9, p. 241.  
Photocell and resistor unload oscillator... IFD, ED 7, p. 98.  
Single transistor makes class-A oscillator... IFD, ED 8, p. 106.  
Two-transistor oscillator generates two frequencies... IFD, ED 3, p. 100.  
Voltage-tuned oscillator may be adjusted simply... IFD, ED 3, p. 98.
- PHASE SHIFTERS:** Shift phase with a simple, constant-gain circuit... IFD, ED 4, p. 114.
- PHASE TESTING:** Monitor phase lead or lag automatically with IC logic... IFD, ED 8, p. 102.
- POTENTIOMETERS:** Simple bridge circuit checks resistance element linearity... IFD, ED 10, p. 92.
- POWER SUPPLIES:** Design transistorized regulators for your power supplies... ART, ED 7, p. 76.  
Low-power, current-limited supply is simple to build... IFD, ED 4, p. 116.  
One power supply does the work of two... IFD, ED 9, p. 241.  
Power supply protected by simple circuits... IFD, ED 8, p. 100.
- Protect power supply against overloading... IFD, ED 5, p. 110.  
Voltage supply puts out two dc voltages... NASA, ED 4, p. 110.
- PULSE CIRCUITS:** One-transistor circuit ups pulse amplitude... NASA, ED 7, p. 100.  
Pulse rise and fall times varied independently... IFD, ED 5, p. 106.  
Simple circuit delivers clean pulses with good noise rejection... IFD, ED 3, p. 96.  
Simple circuit stretches pulses... IFD, ED 8, p. 108.  
Tunnel diode, shunted with a resistor, shapes pulses... IFD, ED 6, p. 282.  
UJTs and magnetic cores combine to generate pulses... ART, ED 8, p. 64.
- RAMP GENERATORS:** Potentiometer serves to vary ramp generator output linearly... IFD, ED 5, p. 104.
- RECEIVERS:** A-m receiver uses laser LO... NASA, ED 12, p. 104.
- RECTIFIERS:** Ideal rectifier uses equal-value resistors... IFD, ED 13, p. 96.  
Two-transistor circuit makes dc-coupled full-wave rectifier... IFD, ED 7, p. 97.
- RELAYS:** Ac time-delay relay uses unijunction transistor... IFD, ED 13, p. 106.
- SAMPLE-AND-HOLD CIRCUIT:** Capacitor improves sample-and-hold circuit... IFD, ED 9, p. 242.
- SCRs:** Fire SCRs directly from integrated circuits... IFD, ED 11, p. 110.
- SHIFT REGISTER:** Inexpensive NOR gate makes shift-register stage... IFD, ED 10, p. 91.
- SINE-WAVE GENERATOR:** Generate sine waves with sampling circuit... NASA, ED 4, p. 110.
- SWITCHING:** High voltages switched with a single transistor... IFD, ED 13, p. 98.  
Marry relays and semiconductors... ART, ED 5, p. 84.  
Power unbalance switch uses integrated circuits... IFD, ED 12, p. 96.  
Sequence is easy with this expandable, wide-range circuit... IFD, ED 11, p. 114.  
Solid-state circuit switches ac load... NASA, ED 8, p. 110.  
Switching solenoids with 75% power efficiency... NASA, ED 1, p. 137.  
Variable-duty-cycle switching circuit... DD, ED 6, p. 261.
- TEACHING:** Electronics taught with domino module... NEWS, ED 9, p. 33.
- TEMPERATURE:** Check the O-TC point in your FETs... ART, ED 9, p. 230.
- THERMISTORS:** Ease resistor-thermistor network design with this direct approach... ART, ED 13, p. 70.

## index of articles, continued

**THERMOCOUPLES:** Check thermocouple during operation . . . . . NASA, ED 12, p. 102.

**TRANSCEIVERS:** Rf voltage blocks receiver during transmit . . . . . IFD, ED 9, p. 244.

**TRANSFORMERS:** Coaxial cable on toroid yields wide-band transformer . . . . . NASA, ED 13, p. 108.

**TRIGGER CIRCUIT:** Simple trigger circuit controls flip-flop . . . . . IFD, ED 9, p. 243.  
Two MOSFETs and resistors make better Schmitt trigger . . . . . IFD, ED 10, p. 92.

**VOLTAGE REGULATOR:** FET stabilizes Zener current in a simple voltage regulator IFD, ED 11, p. 112.  
IC and four resistors compose inexpensive voltage regulator . . . . . IFD, ED 10, p. 96.

**VOLTAGE-SENSING** circuit is temperature-compensated . . . . . IFD, ED 10, p. 90.

**VOLTAGE SUPPLY** puts out two dc voltages . . . . . NASA, ED 4, p. 110.

**WAVE CONVERSION:** Sine-to-square-wave converter is self-powered . . . . . IFD, ED 8, p. 106.

**WAVEGUIDES:** Modified capacitive iris provides design flexibility . . . . . IFD, ED 9, p. 242.

### Communications

**AIRCRAFT:** Four-way rise in radio efficiency planned for jet . . . . . NEWS, ED 1, p. 34.

**ANTENNAS:** Nuclear-powered relay-satellites station proved feasible . . . . . NEWS, ED 4, p. 26.

**AUTODIN:** Centers to handle 32,000 messages an hour . . . . . NEWS, ED 3, p. 17.

**COMSAT** asks for plans for new satellite stations . NEWS, ED 5, p. 14.  
Lani Bird 2 poised to link U. S. with the Far East . NEWS, ED 3, p. 14.

**LASERS:** New gains made in optical communications . . . . . NEWS, ED 2, p. 21.

**MIXERS:** Improve FM performance with FETs . . . . . ART, ED 5, p. 63.  
Y-parameters simplify mixer design . . . . . ART, ED 7, p. 68.

**RADIO RELAY** system can be carried easily . . . . . NEWS, ED 4, p. 33.

**RECEIVERS:** A-m receiver uses laser LO . . . . . NASA, ED 12, p. 104.

**SATELLITES:** 8-in-1 satellite launching bolsters communications . . . . . NEWS, ED 3, p. 13.

**SPACE:** A seven-way race begins in

space communications . . . . . NEWS, ED 1, p. 13.  
Russian lunar TV simple but sharp . . . . . NEWS, ED 13, p. 20.

**SYNTHESIZERS:** Study the trade-offs for synthesizers . . . . . ART, ED 5, p. 88.

**TELEPHONY:** Picturephone to use silicon image sensor . . . . . NEWS, ED 6, p. 54.

**TELEVISION:** French color-TV tube challenges shadow mask . . . . . NEWS, ED 9, p. 13.  
Memory bank enhances TV studio transmission . . . . . NEWS, ED 12, p. 14.  
Multicolor CRT will have single phosphor coating . NEWS, ED 10, p. 14.  
Newspaper delivery by TV to be tested by RCA . . . NEWS, ED 13, p. 14.  
TV sets burgeon with miniature components . . NEWS, ED 13, p. 14.  
2500-MHz TV links medical facilities . . . . . NEWS, ED 2, p. 40.

**TRANSCEIVERS:** Rf voltage blocks receiver during transmit . . . . . IFD, ED 9, p. 244.

**TRANSMITTER:** Three-terminal diode is fm transmitter . . . . . NEWS, ED 2, p. 32.

### Components

**ANTENNAS:** Short-backfire antenna may be uhf boon . . . . . NEWS, ED 10, p. 33.

**ATTENUATORS:** Cut the size of your vhf attenuators . . . . . ART, ED 11, p. 84.

**CABLE:** Ribbon cable replaces coax in one-tenth the space . . . . . PF, ED 6, p. U128.

**CAPACITIVE VOLTAGES** are found easily with this simple nomograph . . . . . ENG DATA, ED 6, p. 266.

**CONNECTORS:** Choose the right power connector . . . . . ART, ED 8, p. 95.  
Plastic cap protects thermocouple connector . . . . . NASA, ED 13, p. 110.

**DECAPSULATE** components undamaged for reject analysis or recovery . . . . . ART, ED 12, p. 62.

**DISPLAYS:** Single-plane digital readouts shine from a tiny CRT . . . . . PF, ED 8, p. 137.  
Three lamps yield seven colors . . . . . IFD, ED 5, p. 108.

**MARKET:** Europe girds for battle with Goliaths of U.S. . . . . NEWS, ED 9, p. 24.

**MILITARY.** Army blasts industry for late deliveries . . . . . NEWS, ED 13, p. 13.  
Army reports a critical components 'gap' . . . . . NEWS, ED 12, p. 24.

**POTENTIOMETER** serves to vary ramp generator output linearly . . . . . IFD, ED 5, p. 104.  
Trimmer pots automatically tested for seven parameters . . . . .

. . . . . PF, ED 13, p. 144.  
Wiper-centering fixture allows easy alignment . . . . . IFD, ED 6, p. 288.

**PRINTED CIRCUITS:** Design reliable printed switches . . . . . ART, ED 13, p. 90.  
Electroless copper PC boards ease soldering and cut costs . . . . . PF, ED 13, p. 134.  
PC boards interwire PC boards, cut costs across the board . . . . . PF, ED 4, p. 168.

**RELAYS:** 'Signature' of relay allows quick check . . . . . NASA, ED 12, p. 104.

**SOLENOIDS:** Switch solenoids with 75% power efficiency . . . . . NASA, ED 1, p. 137.

**TIMING CELLS:** Electrochemical timing cell adds three new functions . . . . . PF, ED 11, p. 122.

### Computers and Data Processing

**ADDERS:** Hybrid technique applied to a binary full adder . . . . . IFD, ED 10, p. 98.

**AUTO SAFETY:** Computer simulates effects of head-on car crash . . . . . NEWS, ED 5, p. 21.

**BIOLOGY:** Computer speeds study of cells . . . . . NEWS, ED 1, p. 50.

**COMPUTER-AIDED DESIGN:** Army moves to adopt computer-aided design . . . . . NEWS, ED 9, p. 14.  
Assign the correct numerical values to transistor models . . . . . ART, ED 13, p. 60.  
Computer-analyze your circuit . . . . . ART, ED 13, p. 54.  
SCEPTRE gives designers new power . . . . . ART, ED 6, p. 230.  
Use a good switching transistor model in computer analysis of circuits . . . . . ART, ED 12, p. 54.  
You don't have to be a programmer to use a time-shared computer to solve design problems . . . . . ART, ED 8, p. 54.

**COPIER:** Computer data copier speeds distribution . . . . . NEWS, ED 5, p. 21.

**CRYOGENICS** promises a billion-bit memory . . . . . NEWS, ED 8, p. 13.

**DESIGN:** Building-block units aid computer designers . . . . . NEWS, ED 11, p. 50.

**DEVELOPMENT:** The large-computer debate: 3 paths, but which is best? . . . . . NEWS, ED 10, p. 13.

**DIGITAL CIRCUITS:** Tunnel-diode circuits pave the way to ultra-high-speed digital circuits . . . . . ART, ED 2, p. 74.

**DISPLAYS:** Plasma display panel writes with computer signals . . . . . NEWS, ED 13, p. 34.

**HOLOGRAMS:** Computer creates holograms digitally . . . . . NEWS, ED 8, p. 22.

ILLIAC TV development goes to Burroughs and Illinois U  
NEWS, ED 5, p. 21.

LEGAL DATA: Computers may store legal precedent  
NEWS, ED 5, p. 13.

LOGIC DEVICES: The logic element of 'tomorrow': cheap wire  
NEWS, ED 10, p. 24.

LOGIC SYSTEMS: Obtain complex logic functions with simple diode logic  
PF, ED 6, p. U208.  
28-volt IC logic to be used in aircraft  
NEWS, ED 12, p. 33.

MAPS: Scanner converts maps for EDP storage  
NEWS, ED 9, p. 44.

MARKET: IBM confirms probe of computer market  
NEWS, ED 4, p. 14.

MEDICAL: Hospital computer system to speed therapy  
NEWS, ED 3, p. 24.  
Medical Electronics: Many technical disciplines are involved  
SR, ED 4, p. 64.

MEMORIES: Core memory stack stores more bits to the inch  
NEWS, ED 1, p. 32.  
Laser loop: new concept for optical memory  
NEWS, ED 2, p. 24.  
Matched cores yield DRO/NDRO memory  
NEWS, ED 12, p. 40.  
Memory bank enhances TV studio transmission  
NEWS, ED 12, p. 14.

MILITARY: Army strengthens U.S. computer defenses against bombers  
NEWS, ED 6, p. 36.  
AUTODIN center to handle 32,000 messages an hour  
NEWS, ED 3, p. 17.

PERIPHERAL GEAR: Where LSI will really pack a wallop!  
NEWS, ED 6, p. 17.

PHYSICS RESEARCH: Computers, ICs to help physicists probe nature  
NEWS, ED 6, p. 42.

PROGRAMS: Computer programs available from NASA  
NEWS, ED 4, p. 14.  
U.S. computer programs are offered to industry  
NEWS, ED 10, p. 14.

SCIENTIFIC DATA: Improved data service offered to scientists  
NEWS, ED 3, p. 14.

SHIFT REGISTER: Inexpensive NOR gate makes shift-register stage  
IFD, ED 10, p. 91.

SOFTWARE: Computer makers strive to cure software ills  
NEWS, ED 5, p. 13.

SPEECH SIGNALS: Computerized vocal tract helps encode speech signals  
NEWS, ED 1, p. 32.

STATISTICS: National data bank to store statistics, not dossiers  
NEWS, ED 7, p. 13.

SWITCHING CIRCUITS: Electron tun-

neling speeds logic switching  
NEWS, ED 8, p. 36.

TAPE: Kodak to stop making magnetic tape in U.S.  
NEWS, ED 7, p. 14.  
Low-cost tape transport records 50-MHz signals  
NEWS, ED 13, p. 38.

TEACHING: Computer to speed Army's teaching of Morse  
NEWS, ED 4, p. 36.  
RCA dedicates computer education facility  
NEWS, ED 7, p. 14.

TERMINALS: Input for a computer—A pen and transparent tablet  
NEWS, ED 11, p. 26.  
Terminal packs away for computer commuter  
NEWS, ED 7, p. 14.

TESTING: Computerized probe measures 3-D parts  
NEWS, ED 7, p. 26.

TIME-SHARING: Computer 'utilities' move toward reality  
NEWS, ED 8, p. 24.  
Low-cost CRT units for time sharing  
NEWS, ED 5, p. 36.

WELDING: Electronic beam welds computer memories on assembly line  
NEWS, ED 5, p. 42.

### Consumer Electronics

AIR NAVIGATION: FAA to test ground aids for supersonic flight  
NEWS, ED 6, p. 13.

ART: Electronic art starts shaping up  
NEWS, ED 1, p. 42.

AUTO SAFETY: Computer simulates effects of head-on car crash  
NEWS, ED 5, p. 21.  
Two devices help light the way to car safety  
NEWS, ED 2, p. 14.

CLOCKS: A myriad of precision watches for land, sea and air  
SR, ED 1, p. 72.

COMPUTERS: IBM confirms probe of computer market  
NEWS, ED 4, p. 14.  
Terminal packs away for computer commuter  
NEWS, ED 7, p. 14.

CREDIT CARD may replace cash trading before 2000  
NEWS, ED 6, p. 14.

CRIME CONTROL: Car thieves foiled by digital ignition  
NEWS, ED 8, p. 33.  
Electronic aids sought to outwit criminals  
NEWS, ED 7, p. 17.  
Hidden mikes protect schools against vandals  
NEWS, ED 5, p. 14.

DISPLAYS: CRT is still leader in large-scale displays  
NEWS, ED 5, p. 33.  
Electronic display offers clearer view of stock quotations  
NEWS, ED 4, p. 36.  
Electronic pad transmits hand-written messages  
IFD, ED 1, p. 138.  
One-color sources yield six-color displays  
NEWS, ED 3, p. 21.  
Traffic light uses numerical display  
NEWS, ED 3, p. 36.

ELECTRIC CAR: Auto makers soft-pedal electric car's rebirth  
NEWS, ED 3, p. 13.  
'Automatic' drive used for large electric vehicles  
NEWS, ED 7, p. 14.  
Whom do the car makers think they are kidding?  
EDIT, ED 12, p. 51.

ICs finding wider use in consumer products  
NEWS, ED 12, p. 13.  
Phonograph joins the trend to ICs  
NEWS, ED 1, p. 33.

MOVIES: Process transfers from video tape to film  
NEWS, ED 6, p. 14.  
Sound movies may use SiC technique  
NEWS, ED 1, p. 37.

RADIO: Beanbag balances radio on any kind of surface  
NEWS, ED 7, p. 14.

TARIFFS: First tariff-cut details leaked by Japanese CIA  
NEWS, ED 13, p. 14.

TEACHING: New Westinghouse group aims at better teaching  
NEWS, ED 3, p. 13.

TELEPHONY: Picturephone to use silicon image sensor  
NEWS, ED 6, p. 54.

TEMPERATURE: Indoor temperatures are comfortable, thanks to solid-state heating and air-conditioning controls  
NEWS, ED 8, p. 14.

TV: French color-TV tube challenges shadow mask  
NEWS, ED 9, p. 13.  
Memory bank enhances TV studio transmission  
NEWS, ED 12, p. 14.  
Multicolor CRT will have single phosphor coating  
NEWS, ED 10, p. 14.  
TV sets burgeon with miniature components  
NEWS, ED 13, p. 14.

WALKIE-TALKIES: Study of frequency shift stirs walkie-talkie static  
NEWS, ED 4, p. 14.

### Editorials

BRAIN RESEARCH: No threat to man's individuality  
EDIT, ED 11, p. 59.

BUGGING: Don't make them throw all those bugs away  
EDIT, ED 1, p. 67.

CARS: Whom do the car makers think they are kidding?  
EDIT, ED 12, p. 51.

CREATIVITY: And where are the Steinmetzes of today?  
EDIT, ED 5, p. 55.

DESIGN: Look ahead, before you freeze the design  
EDIT, ED 10, p. 53.  
They just keep rolling along  
EDIT, ED 9, p. 77.

FLUIDICS: Is fluidics a fine friend or a fearsome foe?  
EDIT, ED 3, p. 45.

## index of articles, continued

- INDUSTRY:** It's time the U.S. encouraged industry to sound off...  
.....EDIT, ED 7, p. 59.
- JOB SECURITY:** Life begins at 40—will it for you?.....  
.....EDIT, ED 8, p. 51.  
Needed: A way to tame the gypsy in us .....EDIT, ED 4, p. 75.
- SHOWS:** We can take a lesson from Europe on trade shows.....  
.....EDIT, ED 13, p. 51.
- WAR & PEACE:** War is hell—and let's face it: it costs like it, too.....  
.....EDIT, ED 2, p. 49.  
What happens to your job if peace breaks out? .EDIT, ED 6, p. 227.

## Industrial Electronics

- AUTO RESEARCH:** Auto makers soft-pedal electric car's rebirth.....  
.....NEWS, ED 3, p. 13.  
'Automatic' drive used for large electric vehicles .....  
.....NEWS, ED 7, p. 14.  
Ford opens new lab for advanced research .NEWS, ED 11, p. 14.  
Two devices help light the way to car safety .NEWS, ED 2, p. 14.  
Whom do the car makers think they are kidding? .EDIT, ED 12, p. 51.
- INDICATORS:** Ac level indicator lights a lamp .....  
.....IFD, ED 13, p. 106.
- MODULES:** Photocell and lamp automate testing of subminiature modules .....  
.....DD, ED 12, p. 78.
- MOTOR CONTROL:** Motor has dynamic braking with a two-wire control .....  
.....IFD, ED 6, p. 284.  
Ring counter reverses multiphase motor rotation .....  
.....NASA, ED 7, p. 103.  
Simple circuits control dc motor speed .....  
.....IFD, ED 7, p. 94.  
Solid-state circuit controls dc motor .....  
.....NASA, ED 7, p. 102.  
Spst switch reverses PM dc motor rotation .....  
.....IFD, ED 9, p. 245.  
Switch from hot to cool with one of these three solid-state motor speed control circuits ART, ED 4, p. 98.  
Tuning fork locks motors in step .....  
.....NEWS, ED 8, p. 44.
- POWER STATIONS:** Texas power utility goes fully automatic.....  
.....NEWS, ED 6, p. 13.
- PROCESS CONTROL:** Infrared unit spots circuit production flaws .....  
.....NEWS, ED 4, p. 34.  
Use integrated circuits in process control .....  
.....ART, ED 1, p. 118.
- TEMPERATURE:** Indoor temperatures are comfortable, thanks to solid-state heating and air-conditioning controls .....  
.....NEWS, ED 8, p. 17.  
Simple thermometer converts temperature into voltage.....  
.....IFD, ED 3, p. 92.  
Temperature sensor has high stability .....  
.....NEWS, ED 6, p. 33.

- THERMISTORS:** Ease resistor-thermistor network design with this direct approach ART, ED 13, p. 70.
- TRANSPONDERS:** FAA trails airlines' use of radar transponders.....  
.....NEWS, ED 12, p. 14.

## Industry (General)

- AIRCRAFT:** Electronic firms await SST's economic boom.....  
.....NEWS, ED 2, p. 13.  
250,000 new jobs seen under SST program .NEWS, ED 8, p. 14.  
28-volt IC logic to be used in aircraft .....  
.....NEWS, ED 12, p. 33.
- COMPUTER PROGRAMS:** U. S. computer programs are offered to industry .....  
.....NEWS, ED 10, p. 14.
- DELIVERIES:** Army blasts industry for late deliveries .....  
.....NEWS, ED 13, p. 13.
- GOVERNMENT:** It's time the U.S. encouraged industry to sound off .....  
.....EDIT, ED 7, p. 59.
- IC CODING:** Europe adopts IC coding system .....  
.....NEWS, ED 11, p. 21.
- LASERS:** Beckman now selling Hughes laser products.....  
.....NEWS, ED 3, p. 14.
- MAGNETIC TAPE:** Kodak to stop making magnetic tape in U.S. ....  
.....NEWS, ED 7, p. 14.
- MAINTAINABILITY** specs bothering you? .....  
.....ART, ED 10, p. 86.
- MARKET:** Business looks good for 1967—but .NEWS, ED 1, p. 17.  
Common Market lures U.S. instrument makers .....  
.....NEWS, ED 11, p. 17.  
Europe girds for battle with Goliaths of U.S. ....  
.....NEWS, ED 9, p. 24.  
First tariff-cut details leaked by Japanese CIA .....  
.....NEWS, ED 13, p. 14.  
Industry ponders tariff cuts, riots, war threats NEWS, ED 12, p. 13.
- METEOROLOGY:** Ka-band radar tested as a weather aid for SSTs .....  
.....NEWS, ED 8, p. 42.  
Outlook for long-range weather forecasting .....  
.....NEWS, ED 6, p. 24.  
Radar mapper measures severity of storms .....  
.....NEWS, ED 12, p. 17.  
Weather Bureau expands disaster warning system .....  
.....NEWS, ED 12, p. 14.  
Weather satellites may aid friend and foe .NEWS, ED 10, p. 14.
- PATENTS:** Global electronic patent search system proposed .....  
.....NEWS, ED 13, p. 13.  
Patent-law overhaul headed for a battle .....  
.....NEWS, ED 1, p. 13.
- REPORTS:** U.S. sets uniform price for its R&D reports .....  
.....NEWS, ED 2, p. 14.
- SHOWS:** Common Market lures U.S. instrument makers .....  
.....NEWS, ED 11, p. 17.  
Europe girds for battle with Goliaths

- of U.S. ....NEWS, ED 9, p. 24.  
Expo 67 to provide fun and culture .....  
.....NEWS, ED 10, p. 38.  
Microwave show has practical theme .....  
.....NEWS, ED 12, p. 44.  
New technology keys Solid-State Circuits show NEWS, ED 5, p. 17.  
Physics show abounds in electronic devices .....  
.....NEWS, ED 4, p. 13.  
The engineer's view of technology: a summary of IEEE papers .....  
.....SR, ED 6, p. U90.  
We can take a lesson from Europe on trade shows.....  
.....EDIT, ED 13, p. 51.
- SPACECRAFT:** NASA and contractor take blame for Apollo fire .....  
.....NEWS, ED 9, p. 13.
- TEACHING:** Electronics taught with domino module .....  
.....NEWS, ED 9, p. 33.

## Materials

- CONDUCTORS:** Cut copper costs: use aluminum strip as a conductor . . .  
.....ENG DATA, ED 12, p. 86.
- DECAPSULATION:** Decapsulate components undamaged for reject analysis of recovery .....  
.....ART, ED 12, p. 62.
- ELECTRON DEPOSITIONS** cannot be measured .NEWS, ED 10, p. 14.
- MULTILAYER BOARDS:** Electroless copper PC boards ease soldering and cut costs .PF, ED 13, p. 134.  
Explore thin-laminate properties and limitations ART, ED 4, p. 84.  
Pick the proper prepreg.....  
.....ART, ED 5, p. 70.  
Ten steps to multilayer board design .....  
.....ART, ED 3, p. 54.
- RESEARCH:** Materials research too device-oriented .....  
.....NEWS, ED 10, p. 32.
- SOLDER:** Electroless copper PC boards ease soldering.....  
.....PF, ED 13, p. 134.  
Speed microelectronic soldering by using prealloyed-solder/flux creams .....  
.....ART, ED 11, p. 90.
- THERMOCOUPLES:** Plastic cap protects thermocouple connector..  
.....NASA, ED 13, p. 110.
- TOOLS:** Protect your panels from scratches and burrs .....  
.....IFD, ED 6, p. 289.

## Medical Electronics

- ACCESSORIES:** Electronic brace to aid paralytics' mobility.....  
.....NEWS, ED 7, p. 13.
- AUDIOLOGY:** Loudness analyzer imitates the ear's response.....  
.....NEWS, ED 12, p. 36.
- COMPUTERS:** Computerized vocal tract helps encode speech signals .....  
.....NEWS, ED 1, p. 32.  
Computer speeds study of cells .....  
.....NEWS, ED 1, p. 50.  
Hospital computer system to speed therapy .....  
.....NEWS, ED 3, p. 24.



**LASERS:** Beam-aiming device sharpens laser scalpel . . . . . NEWS, ED 10, p. 14.

**MARKET:** The outlook is rosy—for the initiated . . . . . SR, ED 4, p. 52.

**PIEZOELECTRICITY:** You can feel it in your bones . . . . . NEWS, ED 5, p. 14.

**RESEARCH:** Brain research is no threat to man's individuality . . . . . EDIT, ED 11, p. 59.  
Diseases fought before and after they occur . . . . . SR, ED 1, p. 76.  
It's largely a field of measurement . . . . . SR, ED 4, p. 56.  
Many technical disciplines involved . . . . . SR, ED 4, p. 64.  
Probing the mind's computer . . . . . SR, ED 11, p. 36.  
Sonar helping MDs to study the human eye . . . . . NEWS, ED 3, p. 32.

**TELEMETRY:** Electronic monitor warns doctors before symptoms appear . . . . . NEWS, ED 13, p. 20.  
French telemetry system checks car crash victims . . . . . NEWS, ED 11, p. 14.

**TELEVISION:** 2500-MHz TV links medical facilities . . . . . NEWS, ED 2, p. 40.

**TRAINING:** Electronic robot speeds training of doctors . . . . . NEWS, ED 9, p. 38.

### Microelectronics

**AIRCRAFT:** 28-volt IC logic to be used in aircraft . . . . . NEWS, ED 12, p. 33.

**BUGGING:** Don't make them throw all those bugs away . . . . . EDIT, ED 1, p. 67.

**CODING SYSTEM:** Europe adopts IC coding system . . . . . NEWS, ED 11, p. 21.

**COUNTERS:** IC bidirectional counters cost less . . . . . ART, ED 2, p. 58.

**DIGITAL SYSTEMS:** Photocell output squared with IC digital systems . . . . . IFD, ED 2, p. 84.

**DIGITIZERS:** Try this integrated-circuit digitizer . . . . . ART, ED 3, p. 62.

**DISCRIMINATORS:** Integrated switching circuit used as a discriminator . . . . . IFD, ED 7, p. 95.

**FAN-IN:** Microcircuit gate-extender makes fan-in reducer . . . . . IFD, ED 8, p. 100.

**FILTERS:** If you need active filters with flat amplitude and time delay responses . . . . . ART, ED 8, p. 78.

**FREQUENCY CONVERSION:** Integrated logic converts frequency . . . . . IFD, ED 7, p. 95.

**GENERATORS:** Four-layer diode forms double pulse generator . . . . . IFD, ED 9, p. 243.  
Pulse bursts generated with all-IC logic . . . . . IFD, ED 7, p. 97.  
Pulse generator uses IC logic . . . . . IFD, ED 10, p. 94.

Random-signal generator uses Zener diode . . . . . IFD, ED 12, p. 98.  
Simple circuit delivers clean pulses with good noise rejection . . . . . IFD, ED 3, p. 96.  
Two SCRs form pulse generator . . . . . IFD, ED 13, p. 98.  
Two transistors give sawtooth in phase with line voltage . . . . . IFD, ED 4, p. 113.

**HYBRID CIRCUITS:** Pick the right hybrid techniques . . . . . ART, ED 6, p. 250.

**ICs:** Design a better integrated circuit . . . . . ART, ED 4, p. 78.  
GE enters market for linear ICs . . . . . NEWS, ED 9, p. 14.  
ICs finding wider use in consumer products . . . . . NEWS, ED 12, p. 13.  
ICs shed their wires . . . . . NEWS, ED 4, p. 17.  
Noise measurements on ICs: dynamic tests—yes; dc—no . . . . . IFD, ED 1, p. 142.  
Phonograph joins the trend to ICs . . . . . NEWS, ED 1, p. 33.  
TV sets burgeon with miniature components . . . . . NEWS, ED 13, p. 14.

**LARGE-SCALE INTEGRATION:** Where LSI will really pack a wallop! . . . . . NEWS, ED 6, p. 17.

**LOGIC CIRCUITS:** Built-in avalanche emitter cuts noise in logic ICs . . . . . PF, ED 6, p. U188.  
New logic family claims higher speeds and easier interfacing . . . . . PF, ED 7, p. 112.  
Use four-phase MOS IC logic when power and chip area are at a premium . . . . . ART, ED 7, p. 62.

**MEDICAL ELECTRONICS:** Many technical disciplines are involved . . . . . SR, ED 4, p. 64.

**OSCILLATORS:** Crystal-controlled oscillator employs microcircuits . . . . . IFD, ED 11, p. 116.  
LC oscillator tank circuit built with just one FET . . . . . IFD, ED 5, p. 104.  
Low-drain SCS forms relaxation oscillator . . . . . IFD, ED 1, p. 144.  
MOSFET and bipolar form RC phase-shift oscillator . . . . . IFD, ED 9, p. 241.

**PHYSICS RESEARCH:** Computers, ICs to help physicists probe nature . . . . . NEWS, ED 6, p. 42.

**POWER:** Low-power current-limited supply is simple to build . . . . . IFD, ED 4, p. 116.  
Protect ICs against power supply failure . . . . . IFD, ED 5, p. 108.

**PROCESS CONTROL:** Use integrated circuits in process control . . . . . ART, ED 1, p. 118.

**REGULATORS:** IC and four resistors compose inexpensive voltage regulator . . . . . IFD, ED 10, p. 96.  
IC voltage regulator is externally adjustable . . . . . PF, ED 2, p. 92.

**RESEARCH:** New technology keys Solid-State Circuits show . . . . . NEWS, ED 5, p. 17.

**SCRs:** Fire SCRs directly from integrated circuits . . . . . IFD, ED 11, p. 110.

**SOLDER:** Speed microelectronic soldering by using prealloyed-solder/flux creams . . . . . ART, ED 11, p. 90.

**SWITCHES:** Complementary MOS arrays going to market . . . . . NEWS, ED 9, p. 21.  
Power unbalance switch uses integrated circuits . . . . . IFD, ED 12, p. 96.

**TESTING:** Noise measurements on ICs: dynamic tests—yes; dc—no . . . . . IFD, ED 1, p. 142.  
Photocell and lamp automate testing of subminiature modules . . . . . DD, ED 12, p. 78.

**THICK FILMS:** New packaging concept: Thick-film substrate in a vacuum tube . . . . . NEWS, ED 7, p. 24.

**THIN FILMS:** Army gets thin-film logic fuse for projectiles . . . . . NEWS, ED 3, p. 26.

**TRANSISTORS:** IC synthesizes 'complementary' UJT, stability rivals crystals . . . . . PF, ED 8, p. 132.

**UNIVERSAL CIRCUIT:** Looking for a 'universal circuit'? . . . . . ART, ED 3, p. 48.

**X-Y MATRICES:** 16-bit matrix built with four IC packages . . . . . IFD, ED 6, p. 286.

### Microwaves

**ANTENNAS:** Antimissile lens antenna tested . . . . . NEWS, ED 2, p. 36.  
Check antennas before building them; use the Monte Carlo technique . . . . . ART, ED 1, p. 124.  
Find the pattern of off-beat antennas . . . . . ART, ED 8, p. 86.  
Phased array antenna updates older systems . . . . . NEWS, ED 12, p. 13.  
Short-backfire antenna may be uhf boon . . . . . NEWS, ED 10, p. 33.  
Skeletal arrays will use computer to fill gaps . . . . . NEWS, ED 4, p. 22.  
Standing waves eliminated within antenna elements . . . . . IFD, ED 12, p. 90.

**BULK EFFECT:** New bulk-effect device offers 400 kW in X band . . . . . NEWS, ED 3, p. 14.

**CRYSTALS:** Inductor ups crystals bandwidth to 2% . . . . . ART, ED 6, p. 244.

**LASERS:** Laser pulses timed at four picoseconds . . . . . NEWS, ED 4, p. 42.  
Liquid lasers for high-power cw operation sought . . . . . NEWS, ED 9, p. 17.  
Parametric amplification achieved in infrared . . . . . NEWS, ED 2, p. 14.  
Rugged mirrors lift CO<sub>2</sub> laser's output . . . . . NEWS, ED 11, p. 32.

**MEDICAL:** Sonar helping MDs study the human eye . . . . . NEWS, ED 3, p. 32.

**METEOROLOGY:** Ka-band radar tested as a weather aid for SSTs . . . . . NEWS, ED 8, p. 42.

## index of articles, continued

- NAVIGATION: Iceberg hunters use microwave radiometry . . . . . NEWS, ED 1, p. 58.
- POWER SOURCES: Will LSA mode outmode Gunn oscillators? . . . . . NEWS, ED 6, p. 21.
- RADAR: Airborne radar may penetrate jungle canopy . . . . . NEWS, ED 10, p. 13.
- FAA trails airlines' use of radar transponders . . . . . NEWS, ED 12, p. 14.
- Radar mapper measures severity of storms . . . . . NEWS, ED 12, p. 17.
- SHOWS: Microwave show has practical theme . . . . . NEWS, ED 12, p. 44.
- TUBES: New solid-state devices vie with microwave tubes . . . . . NEWS, ED 13, p. 171.
- Stabilize power tubes at uhf and vhf . . . . . ART, ED 10, p. 64.
- WAVEGUIDES: Modified capacitive iris provides design flexibility . . . . . IFD, ED 9, p. 242.

## Military Electronics

- AIRCRAFT: AF seeks flight system to double aircraft life . . . . . NEWS, ED 1, p. 14.
- Proximity switch senses status of undercarriage . . . . . NEWS, ED 13, p. 33.
- ANTENNAS: Antimissile lens antenna tested . . . . . NEWS, ED 13, p. 36.
- Skeletal arrays will use computer to fill gaps . . . . . NEWS, ED 4, p. 22.
- BATTERY CHARGERS: Portable chargers for battlefield use on way . . . . . NEWS, ED 13, p. 42.
- COMMUNICATIONS: Centers to handle 32,000 messages an hour . . . . . NEWS, ED 3, p. 17.
- COMPONENTS: Army blasts industry for late delivery . . . . . NEWS, ED 13, p. 13.
- Army reports a critical components 'gap' . . . . . NEWS, ED 12, p. 24.
- COMPUTERS: Army moves to adopt computer-aided design . . . . . NEWS, ED 9, p. 14.
- Army strengthens U.S. computer defenses against bombers . . . . . NEWS, ED 6, p. 36.
- DETONATORS: Semiconductor sets charges off safely . . . . . NEWS, ED 9, p. 22.
- GENERATOR: Back-pack generator for battlefield use . . . . . NEWS, ED 12, p. 32.
- GYRO: Air Force gyro—a nimble thimble . . . . . NEWS, ED 11, p. 24.
- MAINTAINABILITY specs bothering you? . . . . . ART, ED 10, p. 86.

- MISSILES: U.S. missile designers seek harder hardware . . . . . NEWS, ED 4, p. 13.
- U. S. Navy is retiring 2 missile 'old timers' . . . . . NEWS, ED 8, p. 14.
- X-ray missile defense may get U.S. go-ahead . . . . . NEWS, ED 11, p. 14.
- RADAR: Airborne radar may penetrate jungle canopy . . . . . NEWS, ED 10, p. 13.
- RADIO RELAYS: Radio-relay system can be carried easily . . . . . NEWS, ED 4, p. 33.
- RESEARCH: Viet war spurs military R&D . . . . . NEWS, ED 1, p. 14.
- SATELLITES: 8-in-1 satellite launching bolsters communications . . . . . NEWS, ED 3, p. 13.
- STANDARDS: Navy sets new guidelines for electronics packaging . . . . . NEWS, ED 13, p. 14.
- TEACHING: Computer to speed Army's teaching of Morse code . . . . . NEWS, ED 4, p. 36.
- THIN-FILM LOGIC: Army gets thin-film logic fuse for projectiles . . . . . NEWS, ED 3, p. 26.
- WAR: War is hell—and let's face it: it costs like it, too . . . . . EDIT, ED 2, p. 49.

## Missiles and Space

- ANTIMISSILE SYSTEM: Antimissile lens antenna tested . . . . . NEWS, ED 2, p. 36.
- X-ray missile defense may get U.S. go-ahead . . . . . NEWS, ED 11, p. 14.
- APOLLO: NASA and contractor take blame for Apollo fire . . . . . NEWS, ED 9, p. 13.
- U. S. contract shakeup follows Apollo fire . . . . . NEWS, ED 11, p. 14.
- AURORA: Artificial northern lights—courtesy of NASA . . . . . NEWS, ED 2, p. 14.
- COMMUNICATIONS: A seven-way race begins in space communications . . . . . NEWS, ED 1, p. 13.
- 8-in-1 satellite launching bolsters communications . . . . . NEWS, ED 3, p. 13.
- Lani Bird 2 poised to link U.S. with the Far East . . . . . NEWS, ED 3, p. 14.
- Nuclear-powered relay-satellites station proved feasible . . . . . NEWS, ED 4, p. 26.
- COMSAT asks for plans for new satellite stations . . . . . NEWS, ED 5, p. 14.
- DESIGN: NASA invites industry to design for future . . . . . NEWS, ED 11, p. 13.
- ION ENGINES: Ion engines for spacecraft ready for use . . . . . NEWS, ED 1, p. 21.
- MANNED SPACECRAFT: Helping hands tested—master-slave manipulators for spacemen . . . . . NEWS, ED 6, p. 48.

- METEOROLOGY: Weather satellites may aid friend and foe . . . . . NEWS, ED 10, p. 14.
- MICROMETEORITES: Thin film measures "star dust" speed . . . . . NEWS, ED 2, p. 33.
- MILITARY: U.S. missile designers seek harder hardware . . . . . NEWS, ED 4, p. 13.
- U.S. Navy is retiring 2 missile 'old timers' . . . . . NEWS, ED 8, p. 14.
- MOON: Lack of magnetic field may hurt lunar explorers . . . . . NEWS, ED 4, p. 13.
- Lunar package to measure solar wind . . . . . NEWS, ED 8, p. 40.
- Lunar success will come in a small package . . . . . NEWS, ED 12, p. 20.
- Russian lunar TV simple but sharp . . . . . NEWS, ED 13, p. 20.
- NAVIGATION: Space travel made easy with novel displays . . . . . SR, ED 1, p. 88.
- Voyage to Jupiter, 21st-century style . . . . . SR, ED 1, p. 94.
- SOLAR CELLS: 'Window shade' solar-cell array is tested for spacecraft use . . . . . NEWS, ED 5, p. 42.
- TRACKING: Junior satellite tracker pierces the Iron Curtain . . . . . NEWS, ED 2, p. 14.
- VOYAGER: Three firms unite to bid for Voyager contract . . . . . NEWS, ED 4, p. 14.

## Navigation and Guidance

- AUTOMATION: Electronics eases work on the high seas . . . . . NEWS, ED 5, p. 26.
- COLLISION AVOIDANCE: CAS—aid to traffic safety in crowded skies . . . . . NEWS, ED 10, p. 17.
- New search for aircraft anticollision systems . . . . . NEWS, ED 2, p. 13.
- GYROS: Air Force gyro—a nimble thimble . . . . . NEWS, ED 11, p. 24.
- Fluidic gyro built for spacecraft use . . . . . NEWS, ED 5, p. 46.
- INERTIAL GUIDANCE: Commercial inertial guidance is ready for take-off . . . . . NEWS, ED 2, p. 17.
- LANDING AID: Slide projector helps aircraft land . . . . . NEWS, ED 13, p. 32.
- MICROWAVES: Iceberg hunters use microwave radiometry . . . . . NEWS, ED 1, p. 58.
- RADARS: Airborne radar may penetrate jungle canopy . . . . . NEWS, ED 10, p. 13.
- FAA trails airlines' use of radar transponders . . . . . NEWS, ED 12, p. 14.
- Ka-band radar tested as a weather aid for SSTs . . . . . NEWS, ED 8, p. 42.
- Radar mapper measures severity of storms . . . . . NEWS, ED 12, p. 17.
- SSTS: FAA to test ground aids for supersonic flight . . . . . NEWS, ED 6, p. 13.

TESTING: Autopilot test set 'flies' jet on land . . . . NEWS, ED 1, p. 53.

## Oceanology

AUTOMATION: Electronics eases work on the high seas . . . . NEWS, ED 5, p. 26.

MICROWAVE RADIOMETRY: Iceberg hunters use microwave radiometry . . . . NEWS, ED 1, p. 58.

POWER GENERATOR: Compact, 3-W undersea nuclear generator makes bow . . . . NEWS, ED 6, p. 36.

RESEARCH: The wild, mighty oceans—tamed at last . . . . SR, ED 1, p. 102.

## Packaging

BLACK BOXES: Design black boxes for systems integration . . . . ART, ED 5, p. 76.

LASERS: Put transistor in cryostat to pump GaAs laser diodes . . . . IFD, ED 1, p. 144.

STANDARDS: Navy sets new guidelines for electronics packaging . . . . NEWS, ED 13, p. 14.

THICK FILMS: New packaging concept—Thick-film substrate in a vacuum tube NEWS, ED 7, p. 24.

## Physics

COMPUTERS: ICs to help physicists probe nature NEWS, ED 6, p. 42.

PARTICLES: Physicist envisions the end of time . NEWS, ED 4, p. 14.

SHOW: Physics show abounds in electronic devices . . . . NEWS, ED 4, p. 13.

## Power Sources

CHARGERS: Portable chargers for battlefield use on way . . . . NEWS, ED 13, p. 42.

GENERATORS: Back-pack generator for battlefield use . . . . NEWS, ED 12, p. 32.  
Compact 3-W undersea nuclear generator makes bow . . . . NEWS, ED 6, p. 36.

GUNN OSCILLATOR: Will LSA mode outmode Gunn oscillators? . . . . NEWS, ED 6, p. 21.

LASERS: Double-barreled laser new power champ NEWS, ED 1, p. 52.  
Rugged mirrors lift CO<sub>2</sub> laser's output . . . . NEWS, ED 11, p. 32.

OVERLOADS: Power supply protected by simple circuits . . . . IFD, ED 8, p. 100.  
Protect ICs against power supply failure . . . . IFD, ED 5, p. 108.  
Protect power supply against overloading . . . . IFD, ED 5, p. 110.

PHOTOVOLTAIC DEVICES: Organic units make strides toward practi-

cality . . . . NEWS, ED 13, p. 24.

POWER SUPPLIES: Low-power, current-limited supply is simple to build . . . . IFD, ED 4, p. 116.  
One power supply does the work of two . . . . IFD, ED 9, p. 241.

REGULATORS: Design transistorized regulators for your power supplies . . . . ART, ED 7, p. 76.

IC and four resistors compose inexpensive voltage regulator . . . . IFD, ED 10, p. 96.

IC voltage regulator is externally adjustable. . . . PF, ED 2, p. 92.

SOLAR CELLS: 'Window shade' solar-cell array is tested for spacecraft use . . . . NEWS, ED 5, p. 42.

STAND-BY POWER: Turn on stand-by power simply and reliably . . . . IFD, ED 4, p. 116.

VOLTAGE SUPPLY puts out two dc voltages . . . . NASA, ED 4, p. 110.

## Production Processes and Controls

BONDING: Electronic eye sets semiconductor bond . . . . NEWS, ED 1, p. 36.

CRYOGENICS: Cryogenics promise a billion-bit memory . . . . NEWS, ED 8, p. 13.

Stevens to open study for study of cryogenics . . . . NEWS, ED 12, p. 14.

CRYOSTAT: Put transistor in cryostat to pump GaAs laser diodes . . . . IFD, ED 1, p. 144.

ICs: Use integrated circuits in process control . . . . ART, ED 1, p. 118.

INFRARED unit spots circuit production flaws . . . . NEWS, ED 4, p. 32.

THERMOMETER uses binary logic to measure from 10° to 25° K . . . . NEWS, ED 13, p. 22.

THICK FILMS: Thick-film substrate in a vacuum tube . . . . NEWS, ED 7, p. 24.

WELDING: Electronic beam welds computer memories on assembly line . . . . NEWS, ED 5, p. 42.

## Radio Frequency Interference

HUM: Ambient 60-Hz hum used to cut 60-Hz hum in equipment . . . . IFD, ED 7, p. 94.

TRANSCEIVERS: RF voltage blocks receiver during transmit . . . . IFD, ED 9, p. 244.

## Reliability

AIRCRAFT: AF seeks flight system to double aircraft life . . . . NEWS, ED 1, p. 14.

MAINTAINABILITY specs bothering you? . . . . ART, ED 10, p. 86.

POWER FAILURE: Protect ICs against power supply failure . . . . IFD, ED 5, p. 108.

POWER SUPPLIES: Power supply protected by simple circuits . . . . IFD, ED 8, p. 100.

Protect power supply against overloading . . . . IFD, ED 5, p. 110.

PRINTED CIRCUITS: Design reliable printed switches . . . . ART, ED 13, p. 90.

## Research and Development

AIRCRAFT: Four-way rise in radio efficiency planned for jet . . . . NEWS, ED 1, p. 34.

AURORA: Artificial northern lights—courtesy of NASA . . . . NEWS, ED 2, p. 14.

AUTO INDUSTRY: Auto makers soft-pedal electric car's rebirth . . . . NEWS, ED 3, p. 13.

Ford opens new lab for advanced research . . . . NEWS, ED 11, p. 14.

Whom do the car makers think they are kidding . . . . EDIT, ED 12, p. 51.

AUTOMATA: Will the machines eventually outwit man? . . . . SR, ED 1, p. 82.

BRAIN RESEARCH: Probing the mind's computer . . . . SR, ED 11, p. 36.

BULK EFFECT: New bulk-effect device offers 400 kW in X band . . . . NEWS, ED 3, p. 14.

CLOCKS: A myriad of precision watches for land, sea and air . . . . SR, ED 1, p. 72.

COLLISION AVOIDANCE: CAS—Aid to traffic safety in crowded skies . . . . NEWS, ED 10, p. 17.

New search for aircraft anticollision systems . . . . NEWS, ED 2, p. 13.

COMPUTERS: Systems research center set up by IBM in Europe . . . . NEWS, ED 5, p. 14.

CRYOGENICS promises a billion-bit memory . . . . NEWS, ED 8, p. 13.

Stevens to open center for study of cryogenics . . . . NEWS, ED 12, p. 14.

ELECTRONICS in the World of Tomorrow . . . . SR, ED 1, p. 71.

FLUIDICS: Fluidic gyro built for spacecraft use . . . . NEWS, ED 5, p. 46.

Is fluidics a fine friend or a fearsome foe . . . . EDIT, ED 3, p. 45.

HOLOGRAPHY: Computer creates holograms digitally . . . . NEWS, ED 8, p. 22.

'Fly's-eye' lens array snaps hologram images in natural light . . . . NEWS, ED 4, p. 26.

NASA describes its holographic research . . . . NEWS, ED 8, p. 14.

IEEE PAPERS: The engineer's view of technology: a summary of IEEE papers . . . . SR, ED 6, p. U90.

ION ENGINES for spacecraft ready for use . . . . NEWS, ED 1, p. 21.

## index of articles, continued

**LASERS:** AM receiver uses laser LO  
NASA, ED 12, p. 104.  
Beckman now selling Hughes laser  
products NEWS, ED 3, p. 14.  
Double-barreled laser new power  
champ NEWS, ED 1, p. 52.  
GaAs diffusion process triples diode  
laser power NEWS, ED 3, p. 33.  
Laser loop: New concept for optical  
memory NEWS, ED 2, p. 24.  
Laser pulses timed at four picosec-  
onds NEWS, ED 4, p. 42.  
Laser system tracks 4000-mph rock-  
et sleds NEWS, ED 6, p. 14.  
Liquid lasers for high-power cw op-  
eration sought  
NEWS, ED 9, p. 17.  
Narrow laser pulses captured on  
scope NEWS, ED 5, p. 37.  
New gains made in optical commu-  
nications NEWS, ED 2, p. 21.  
Parametric amplification achieved in  
infrared NEWS, ED 2, p. 14.  
Put transistor in cryostat to pump  
GaAs laser diodes  
IFD, ED 1, p. 144.  
Rugged mirrors lift CO<sub>2</sub> laser's out-  
put NEWS, ED 11, p. 32.  
Stripe contact simplifies laser  
diode's light pattern  
NEWS, ED 7, p. 26.  
**LSA:** Will LSA mode outmode Gunn  
oscillators? NEWS, ED 6, p. 21.  
**MATERIALS** research too device-ori-  
ented NEWS, ED 10, p. 32.  
**MEDICAL:** Diseases fought before  
and after they occur  
SR, ED 1, p. 76.  
Many technical disciplines are in-  
volved SR, ED 4, p. 64.  
**MICROMETEORITES:** Thin film meas-  
ures 'star dust' speed  
NEWS, ED 2, p. 33.  
**MILITARY:** Viet war spurs military  
R&D NEWS, ED 5, p. 13.  
**OCEANOLOGY:** The wild, mighty  
oceans—tamed at last  
SR, ED 1, p. 102.  
**ORGANIC PHOTOVOLTAIC** devices  
make strides toward practicality  
NEWS, ED 13, p. 24.  
**PHYSICS:** Computers, ICs to help  
physicists probe nature  
NEWS, ED 6, p. 42.  
**PLASMA PANEL** may oust CRTs for  
displaying computer digital signals  
NEWS, ED 13, p. 34.  
**REPORTS:** U.S. sets uniform price for  
its R&D reports  
NEWS, ED 2, p. 14.  
**SPACE:** Helping hands tested—mas-  
ter-slave manipulators for spacemen  
NEWS, ED 6, p. 48.  
NASA invites industry to design for  
future NEWS, ED 11, p. 13.  
Space travel made easy with novel  
displays SR, ED 1, p. 88.  
Voyage to Jupiter, 21-Century style  
SR, ED 1, p. 94.

**SPECTROMETRY:** Timing fork chops  
infrared radiation  
NEWS, ED 3, p. 38.  
**TELEVISION:** French color-TV tube  
challenges shadow mask  
NEWS, ED 9, p. 13.  
Multicolor CRT will have single  
phosphor coating  
NEWS, ED 10, p. 14.  
Newspaper delivery by TV to be test-  
ed by RCA NEWS, ED 13, p. 14.  
**TUBES:** Cold-cathode operated over  
6000 hours NEWS, ED 6, p. 49.

## Semiconductors

**BONDING:** Electronic eye sets semi-  
conductor bond  
NEWS, ED 1, p. 36.  
**COMPUTER-AIDED DESIGN:** Assign  
the correct numerical values to tran-  
sistor models ART, ED 13, p. 60.  
Computer-analyze your circuit  
ART, ED 13, p. 54.  
Use a good switching transistor  
model in computer analyses of cir-  
cuits ART, ED 12, p. 54.  
**DIODES:** Avalanche Zeners show  
sharper knees at lower voltages  
PF, ED 13, p. 120.  
Beam-lead Schottky diodes pro-  
duced, 1000 on a wafer  
PF, ED 8, p. 120.  
Diode and battery form low-voltage  
Zener diode IFD, ED 13, p. 104.  
Measure capacitance and resistance  
of forward-biased diodes  
ART, ED 4, p. 92.  
Three-terminal diode is fm tran-  
smitter NEWS, ED 2, p. 32.  
**DIRECTORY:** 1967 Semiconductor  
Reference Directory  
SR, ED 9, p. 93.  
Addenda to ELECTRONIC DESIGN  
1967 Semiconductor Directory  
SR, ED 12, p. 83.  
**FETs:** Simple tester checks FET  $V_D$   
and  $g_m$  IFD, ED 10, p. 91.  
Six new FET families cut cost, push  
performance PF, ED 8, p. 118.  
**LASERS:** GaAs diffusion process tri-  
ples diode laser power  
NEWS, ED 3, p. 33.  
Put transistor in cryostat to pump  
GaAs laser diodes  
IFD, ED 1, p. 144.  
Stripe contact simplifies laser  
diode's light pattern  
NEWS, ED 7, p. 26.  
**RECTIFIER:** Ideal rectifier uses equal-  
value resistors IFD, ED 13, p. 96.  
Thin-film rectifier has improved cur-  
rent rating NASA, ED 4, p. 108.  
**RESEARCH:** New technology keys  
Solid-State Circuits show  
NEWS, ED 5, p. 17.  
**TESTING:** Oscilloscope tests semi-  
conductors in circuit  
NASA, ED 10, p. 102.  
Probe analyzes semiconductors  
NEWS, ED 6, p. 66.  
Probe spots shorted transistor in a

parallel string IFD, ED 6, p. 284.  
Semiconductor wafers probed at  
rate of 20,000 per hour  
PF, ED 6, p. U132.  
**TRANSISTORS:** Silicon npn transistor  
has great potential—1000 volts  
PF, ED 2, p. 112.  
**TUNNEL-DIODE** circuits pave the way  
to ultra-high-speed digital circuits  
ART, ED 2, p. 74.  
**UJTs:** Plastic planar UJTs cost less,  
leakage cut to nanoamps  
PF, ED 4, p. 122.  
**VARACTORS:** Hyperabrupt junction  
gives varactor diodes tuning ratios  
to 21:1, Q to 300  
PF, ED 12, p. 116.  
Select varactors for voltage tuning  
ENG DATA, ED 12, p. 72.  
**Telemetry**  
**MEDICAL:** Electronic monitor warns  
doctors before symptoms appear  
NEWS, ED 13, p. 20.  
French telemetry system checks car  
crash victims  
NEWS, ED 11, p. 14.  
**SATELLITES:** Junior satellite tracker  
pierces the Iron Curtain  
NEWS, ED 2, p. 14.  
Comsat asks for plans for new satel-  
lite stations NEWS, ED 5, p. 14.  
Nuclear-powered relay-satellites sta-  
tion proved feasible  
NEWS, ED 4, p. 26.  
**SPACE:** Lunar package to measure  
solar wind NEWS, ED 8, p. 40.  
Russian lunar TV simple but sharp  
NEWS, ED 13, p. 20.  
Thin film measures "star dust"  
speed NEWS, ED 2, p. 33.  
**TELEPHONY:** Picturephone uses sili-  
con image sensor  
NEWS, ED 6, p. 54.  
**Test Equipment and Measurement**  
**AIRCRAFT:** Autopilot test set 'flies'  
jet on land NEWS, ED 1, p. 53.  
**AMPLIFIERS:** Go/no-go technique  
tests amplifiers  
ART, ED 10, p. 70.  
**AUTOMATIC SYSTEMS:** Serial com-  
parison technique improves per-  
formance of automatic test systems  
ART, ED 7, p. 84.  
**CALIBRATION:** Bridge calibrates  
high-voltage divider  
NASA, ED 8, p. 112.  
**CAPACITANCE:** Simplify capacitance  
measurements with this handy no-  
mograph  
ENG DATA, ED 6, p. 258.  
**CAPACITIVE VOLTAGES** are found  
easily with this simple nomograph  
ENG DATA, ED 6, p. 266.  
**COMPUTERS:** Computerized probe  
measures 3-D parts  
NEWS, ED 7, p. 26.

**COPIER:** Oscilloscope used to copy Polaroid photographs. . . . . IFD, ED 11, p. 118.

**CORONA:** Pocket radio detects corona or insulation breakdown. . . . . IFD, ED 11, p. 114.

**DETECTORS:** Thin-film detector has very wide range. . . . . NASA, ED 12, p. 102.

**DIODES:** Measure capacitance and resistance of forward-biased diodes. . . . . ART, ED 4, p. 92.

**DISTORTION:** Delay distortion can be eliminated from instrumentation systems. . . . . ART, ED 13, p. 84.

**ELECTRON DEPOSITIONS** cannot be measured. . . . . NEWS, ED 10, p. 14.

**FETs:** Simple tester checks FET  $V_p$  and  $g_m$ . . . . . IFD, ED 10, p. 91.

**FREQUENCY COUNTERS:** 'Thin-line' counters measure 1-3/4 inches tall with 9-digit readout. . . . . PF, ED 5, p. 114.  
Try this integrated-circuit digitizer. . . . . ART, ED 3, p. 62.

**ICs:** Noise measurements on ICs: dynamic tests—yes; dc—no. . . . . IFD, ED 1, p. 142.

**IMPEDANCE:** Simple circuit measures impedances at af. . . . . IFD, ED 11, p. 111.

**LASER** system tracks 4000-mph rocket sleds. . . . . NEWS, ED 6, p. 14.

**LOUDNESS** analyzer imitates the ear's response. . . . . NEWS, ED 12, p. 36.

**MEDICAL:** It's largely a field of measurement. . . . . SR, ED 4, p. 56.

**MODULES:** Photocell and lamp automate testing of subminiature modules. . . . . DD, ED 12, p. 78.

**NETWORKS:** Read network parameters on a meter or Smith chart. . . . . PF, ED 5, p. 116.

**OSCILLOGRAPHS:** Accessory adapts oscillograph for simultaneous microfilming. . . . . PF, ED 10, p. 144.

**OSCILLOSCOPES:** Real-time scope boasts 150-MHz bandwidth and 2.4-ns rise time at the probe tip. . . . . PF, ED 7, p. 106.  
'Spectral purity' can hide a lot of sins since test methods and definitions lack standard. . . . . ART, ED 13, p. 76.

**PHASE LEAD/LAG:** Monitor phase lead or lag automatically with IC logic. . . . . IFD, ED 8, p. 102.

**PHOTODETECTORS** calibrated in minutes. . . . . NEWS, ED 11, p. 48.

**POTENTIOMETERS:** Simple bridge circuit checks resistance element linearity. . . . . IFD, ED 10, p. 92.  
Trimmer pots automatically tested for seven parameters. . . . . PF, ED 13, p. 144.

**PULSE GENERATOR:** Threshold detector gives ns pulses. . . . . NASA, ED 6, p. 274.

**RELAYS:** 'Signature' of relay allows quick check. . . . . NASA, ED 12, p. 104.

**SEMICONDUCTORS:** Oscilloscope tests semiconductors in circuit. . . . . NASA, ED 10, p. 102.  
Probe analyzes semiconductors. . . . . NEWS, ED 6, p. 66.  
Semiconductor wafers probed at rate of 20,000 per hour. . . . . PF, ED 6, p. U132.

**STABILITY:** Angle position indicator employs inductive dividers for stability. . . . . PF, ED 6, p. U146.

**THERMOCOUPLES:** Check thermocouple during operation. . . . . NASA, ED 12, p. 102.

**THERMOMETER:** Self-calibrating thermometer uses binary logic from 10° to 25°K. . . . . NEWS, ED 13, p. 22.  
Simple thermometer converts temperature into voltage. . . . . IFD, ED 3, p. 92.  
Temperature sensor has high stability. . . . . NEWS, ED 6, p. 33.

**TRANSISTORS:** Probe spots shorted transistor in a parallel string. . . . . IFD, ED 6, p. 284.

**TURBINE:** Fm unit monitors whirling turbine. . . . . NEWS, ED 11, p. 20.

**ULTRAMICROMETER:** Device measures minute distance. . . . . NEWS, ED 9, p. 48.

**VOLTAGE:** Standard recorder permits ratios to be read directly. . . . . IFD, ED 6, p. 289.

**WATER TABLE:** Fiberoptics sense water level. . . . . IFD, ED 2, p. 86.

### Tubes

**CATHODE RAY:** Cold-cathode operated over 6000 hours. . . . . NEWS, ED 6, p. 49.  
CRT is still leader in large-scale display. . . . . NEWS, ED 5, p. 33.  
Plasma panel may oust CRT for displaying computer digital signals. . . . . NEWS, ED 13, p. 34.  
Single-plane digital readouts shine from a tiny CRT. . . . . PF, ED 8, p. 137.

**MICROWAVES:** New solid-state devices vie with microwave tubes. . . . . NEWS, ED 13, p. 17.

**PACKAGING:** Thick-film substrate in a vacuum tube. . . . . NEWS, ED 7, p. 24.

**POWER TUBES:** Stabilize power tubes at uhf and vhf. . . . . ART, ED 10, p. 64.

**TELEVISION:** French color-TV tube challenges shadow mask. . . . . NEWS, ED 9, p. 13.  
Multicolor CRT will have a single phosphor coating. . . . . NEWS, ED 10, p. 14.

# Bulova can supply the crystal you need



to match your specs!

Many years of supplying crystal control units for the most advanced military and space programs enable Bulova to offer a full line encompassing virtually the entire frequency spectrum—2 kc to 125 Mc for oscillator and filter applications. We can supply every type of packaging—including koldweld and glass sealed. Our military crystals meet latest MIL-C-3098D specifications. All reasons why you should make Bulova your single source of supply.

**HIGH PRECISION GLASS SEALED CRYSTALS** 1 Mc to 125Mc. Available in vacuum sealed, glass enclosures of the HC-26/U and HC-27/U type.

**Example: Precision SSB Crystals**

Frequency: 1 Mc to 5 Mc  
Holder: HC-27/U  
Tolerance:  $\pm .0025\%$  from  $-55^{\circ}\text{C}$  to  $+90^{\circ}\text{C}$ , or to specification  
Aging:  $3 \times 10^{-8}$  per week after one week stabilization at  $75^{\circ}\text{C}$

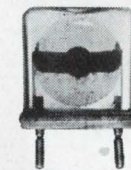

**KOLDWELD SEALED CRYSTALS**—low aging, high reliability, 1 Mc to 125 Mc. Now available in TO-5, HC-6/U and HC-18/U type cans sealed by the koldweld process to eliminate effects of heat and to reduce contamination.

**Example: TO-5**

Frequency: 15 Mc to 125 Mc  
Tolerance:  $\pm .0025\%$  from  $-55^{\circ}\text{C}$  to  $+105^{\circ}\text{C}$ , or to specification  
Aging:  $1 \times 10^{-7}$  per week after one week stabilization at  $75^{\circ}\text{C}$



Write or call for specifications on Bulova's complete line of crystals. Address: Dept. ED-17

## BULOVA

FREQUENCY CONTROL PRODUCTS

ELECTRONICS DIVISION OF BULOVA WATCH COMPANY, INC.

61-20 WOODSIDE AVENUE WOODSIDE, N.Y. 11377, (212) DE 5-6000

ON READER-SERVICE CARD CIRCLE 46

# Nobody but AE makes a Class E relay with all these terminals.

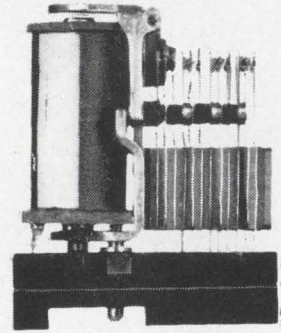

## Take your pick:

**1** *Solderless Wrap Terminals* eliminate the hazards of soldering. No splashes, heat or clippings. Faster, easier connections. And the technique is easy to learn.

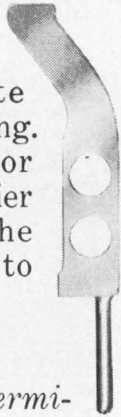

**2** *Taper Tab Terminals* accept solderless, slip-on connections which are crimped to each wire lead. Easy to connect or disconnect. Simplify circuit changes and relay substitutions.

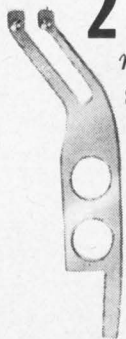

**3** *Solder Terminals*—the conventional way. For chassis and rack mounting where quick-connect methods aren't needed.



**4** *Printed Circuit Terminals* can be inserted directly into PC cards or boards. All terminals are soldered at one time by "flowing." This process can be automated.

You can get AE Class E relay with several types of plug-in sockets, too—that further in-

crease the number of mounting options.

But don't select the Class E relay because of wiring convenience alone. This is a miniaturized version of the premium-quality Class B—with most of its best features. Perfect contact reliability exceeding 200 million operations is common. That's why, even with ordinary solder terminals, the Class E is the most popular *quality* relay of its size!

For helpful information on the full line, ask for Circular 1942. Just write the Director, Relay Control Equipment Sales, Automatic Electric Company, Northlake, Illinois 60164.

## **AUTOMATIC ELECTRIC**

SUBSIDIARY OF  
GENERAL TELEPHONE & ELECTRONICS **GT&E**

ON READER-SERVICE CARD CIRCLE 47

# EIMAC

## 250 kW tetrode now ready for tomorrow's super-power transmitters

The EIMAC 4CV250,000C is the world's highest power tetrode. It is designed for service in super-power broadcast transmitters, and was developed on the foundation of technology which produced its "little brother," the hundred-kilowatt 4CV100,000C, now used by the USIA. The giant new vapor-cooled tube combines high power gain with long life. Vapor cooling is accepted as an efficient and economical method of cooling in advanced broadcast systems. As EIMAC's latest addition to its line of power tetrodes, the 4CV250,000C is ideally suited for service as an audio modulator, a pulse modulator, or a regulator, and as an rf amplifier in linear accelerators. Ready now for the super-power transmitters of the future, this 250 kW tetrode is another example of how EIMAC's experience in power tube technology paves the way for the developments of tomorrow. For a power tube to fit your needs—big or small—write Product Manager, Power Grid Tubes, or contact your nearest EIMAC distributor.

### TYPICAL OPERATION

(as a Plate-Modulated Power Amplifier at Frequencies below 30 MHz)

DC Plate Voltage	14 kV
DC Screen Voltage	800 V
Peak AF Screen Voltage (for 100% Modulation)	800 V
DC Grid Voltage	-800 V
DC Plate Current	29 Amps
DC Screen Current	3.6 Amps
DC Grid Current	1.8 Amps
Peak RF Grid Voltage	1200 V
Grid Driving Power	2.5 kW
Plate Output Power	292 kW

**EIMAC**

Division of Varian

San Carlos, California 94070

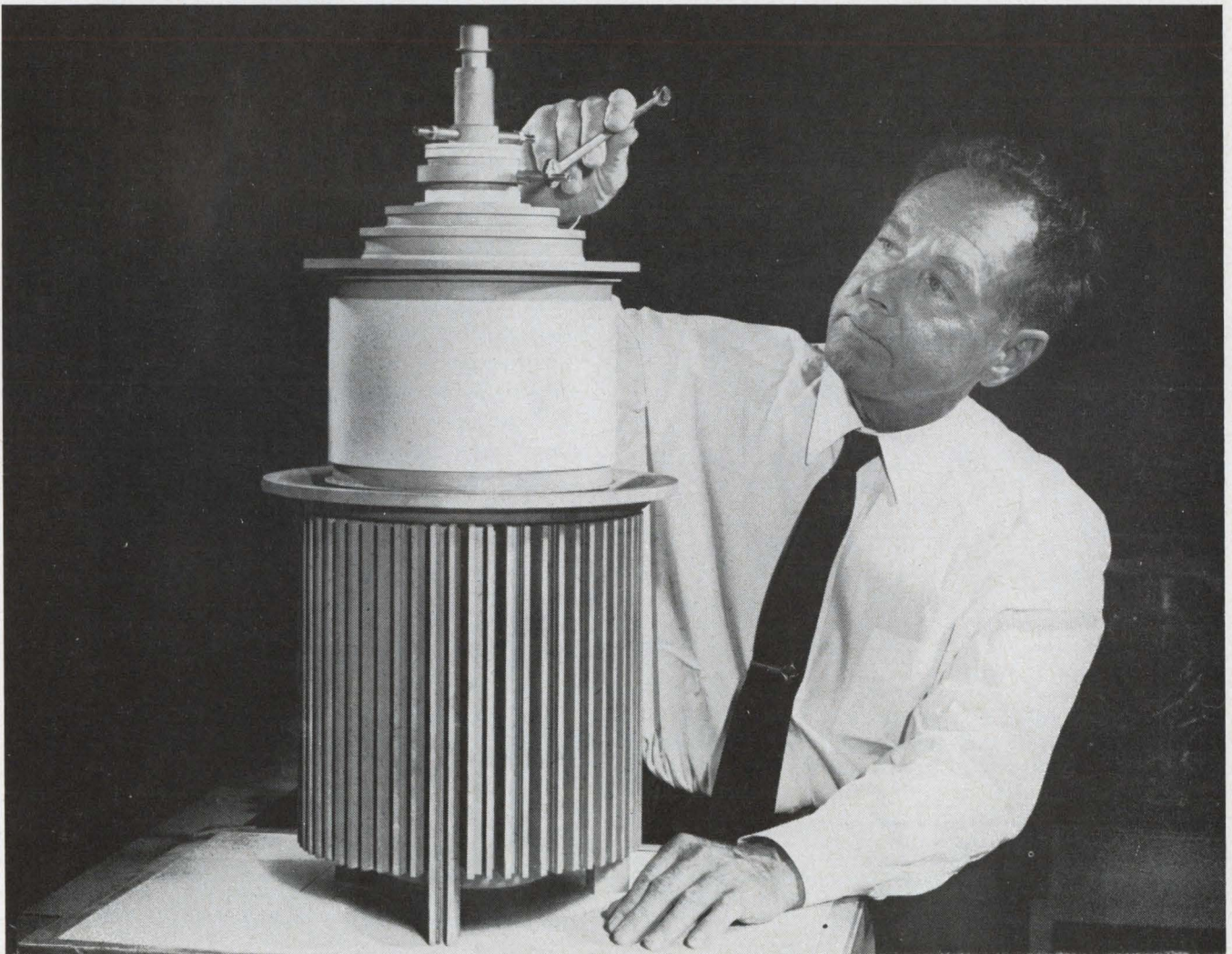

ON READER-SERVICE CARD CIRCLE 48

# Dc voltage modulator uses line frequency

A circuit had to be tested at two extremes of supply voltage and two extremes of clock voltage. The worst-case conditions were determined to be low supply voltage with high clock voltage, and high supply voltage with low clock voltage. To speed up the testing of the circuits at the worst-case conditions, the following modulator (Fig. 1a) was devised. The nominal voltage of the power supply was  $25 \pm 1$  volts dc and the clock voltage  $35 \pm 1$  volts dc.

Action in the circuit under test took place between 20 kHz to 200 kHz. Line frequency of 60 Hz was used to vary the voltages through their spread of  $\pm 1$  volt. The 115-volt line voltage was fed to a Variac to control the input voltage to two 2.5-volt filament transformers. Approximately 30 volts' input to these transformers produced the required 2-volts peak-to-peak for modulation. The filament transformers are connected out of phase to produce the worst-case conditions of 26-volt

supply and 34-volt clock and 24-volt supply and 36-volt clock (Fig. 1b).

The ac voltmeter at the variable transformer's output can be used to monitor the 2-volt peak-to-peak modulation. If a regulated 115 volts ac is used, this would not be necessary. An oscilloscope would then be required on the initial setup to determine the correct Variac setting to produce the 2-volt peak-to-peak.

A. Hirsch, Production Test Supervisor, Philco-Ford Microelectronics Div., Santa Clara, Calif.

VOTE FOR 110

## Composite amplifier has improved dc bias stability

An economical amplifier with high input impedance and almost complete insensitivity to normal bias and source drift can be designed without the need for matched transistor pairs or balancing circuits. The design for this circuit is based on a Darlington, or composite, configuration with a constant-current source, as shown in Fig. 1a.

Amplifiers with good low-frequency response can be constructed in several ways. One of the most common circuits (Fig. 1b) requires a capacitor for input coupling. The resulting low-frequency response is determined by the effective impedance in series with this capacitor. Because of the shunting effect of the bias network, however, this circuit has the disadvantage of limiting the input impedance. The approach also presents temperature sensitivity and stability problems.

On the other hand, dc amplifiers with high input impedances and good temperature versus output dc-level stability are possible with differential amplifiers. For many applications, however, the cost of the matched transistors or balancing circuits required by this approach is a drawback.

The asymmetrical circuit in Fig. 1a eliminates the need for paired transistors or potentiometers. Instead of comparing two signals, this circuit compares the input with ground. The emitter of  $Q3$  will always be at  $E_{in} - 3V_{be}$ . Slow variations of voltage at  $E_{in}$  are tracked at the emitter of  $Q3$  with negligible current drain from the constant-current source. Rapid shifts in  $E_{in}$  (signal frequencies) are bypassed through the capacitor  $C$ ,

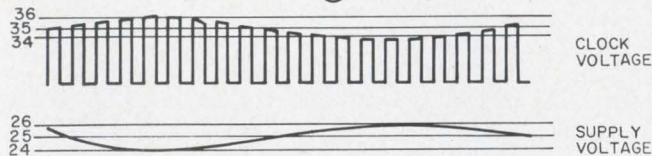
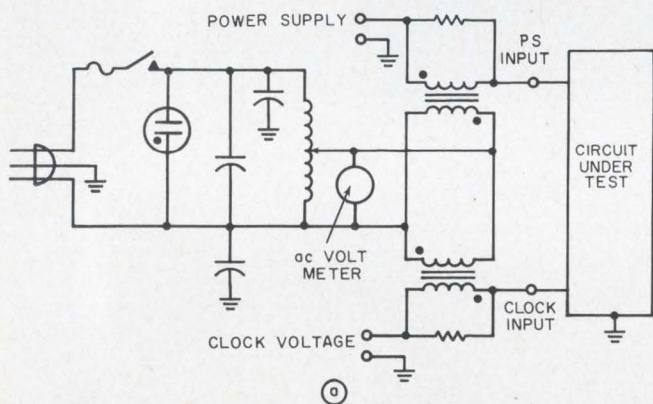

1. Power-frequency modulator uses a Variac and two filament transformers to vary out of phase two signal levels by  $\pm 1$  volt. The resultant wave shapes are shown in (b).

**VOTE!** Circle the Reader-Service-Card number corresponding to what you think is the best Idea-for-Design in this issue.

**SEND US YOUR IDEAS FOR DESIGN.** Submit your IFD describing a new or important circuit or design technique, the clever use of a new component, or a cost-saving design tip to our Ideas-for-Design editor. If your idea is published, you will receive \$20 and become eligible for an additional \$30 (awarded for the best-of-issue Idea) and the grand prize of \$1000 for the Idea of the Year.



VARIABLE  
BANDWIDTH  
MARKERS  
PINPOINT THE  
FREQUENCY



## ***Sweep Oscillator gives top performance in the 100 kHz to 110 MHz range***

All solid-state Hewlett-Packard 3211A Sweep Oscillators with RF and marker plug-ins meet virtually all of your swept frequency testing requirements. Variable bandwidth markers permit accurate, well defined marking under a variety of test conditions.

The main frame of the 3211A contains everything you could hope to find in a sweeper. RF plug-ins operate at fundamental frequencies with good linearity and spurious mixing products are eliminated. Plug-in markers offer not only variable bandwidth, but also Z-axis or pulse-type marking. An accurate 59-db attenuator makes the unit a valuable tool for testing both high- and low-gain circuits.

The 3211A is ideal for general testing in the video to VHF range where flat, linear output and an accurate marking system is required. Typical applications are: alignment, calibration and design of FM tuners and receivers and testing filters, amplifiers, transformers, resonant circuits and IF sections of TV receivers, radar and communications systems. For complete specifications, contact your local Hewlett-Packard field engineer or write Hewlett-Packard, Green Pond Road, Rockaway, N.J. 07866.

**HEWLETT**  **PACKARD**  
measuring instruments  
for science and industry

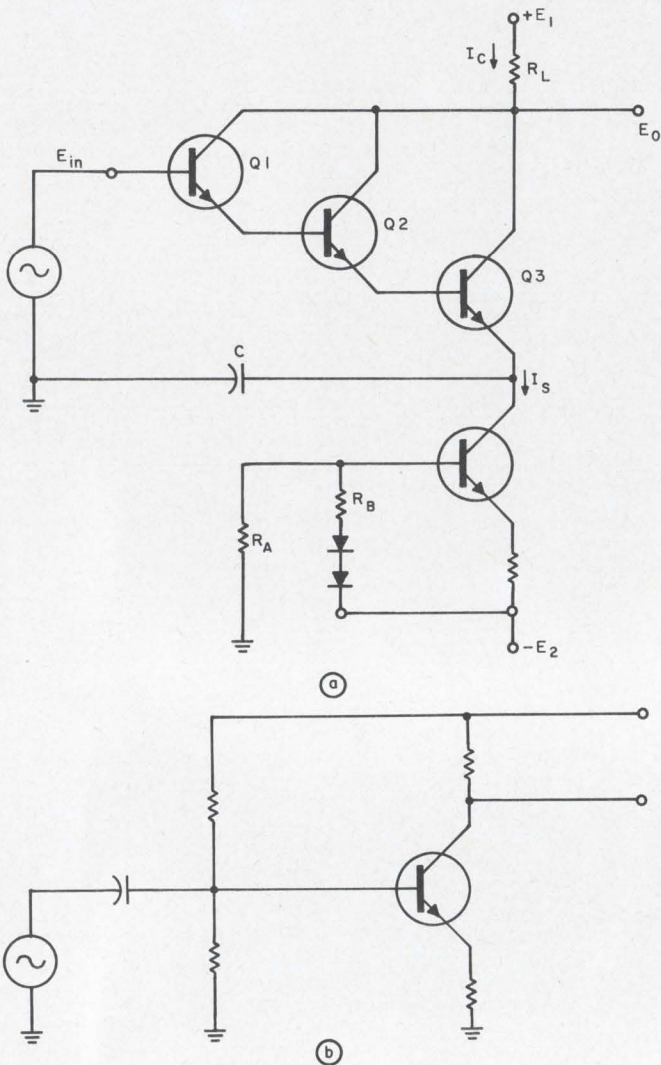

1. A simple dc amplifier (a) has high input impedance, is insensitive to bias and source drift, and uses neither the matched transistors nor the balancing circuits usually required to improve operation of a standard circuit (b).

however, and amplification results. Since slow changes at the emitter of  $Q_3$  draw negligible current from the source, the dc level at  $E_o$  is  $E_1 - I_C R_L$  for no-signal input.

Tying all the collectors of the transistors together helps to make the circuit less sensitive to  $\alpha$  temperature variations. With only one transistor:

$$E_o = E_1 - E_R$$

$$E_R = I_C R_L$$

where  $I_C = \alpha I_s$ . Then:

$$\Delta E_R / E_R = \Delta \alpha / \alpha.$$

With three transistors, on the assumption that  $\alpha_1 = \alpha_2 = \alpha_3 = \alpha$ :

$$E_R = I_C R_L (\alpha^3 - 3\alpha^2 + 3\alpha),$$

and

$$\Delta E_R / E_R = [3(\alpha - 1)^2 / (\alpha^2 - 3\alpha + 3)] [\Delta \alpha / \alpha] < \Delta \alpha / \alpha.$$

A temperature-compensating feature of this circuit is the use of the diodes in the constant-

current source. The number of diodes for effective compensation depends on the ratio  $R_B / (R_A + R_B)$ .

The input impedance depends primarily on the number of transistors in cascade, the value of load resistance  $R_L$ , the collector resistance of the first stage and the signal frequency.

As a result of the Miller effect on the upper frequency limit, the composite configuration is limited to low-frequency applications. In this design, however, the high input impedance at low signal frequencies and the  $\alpha$  insensitivity feature were selected as more desirable than extended frequency response. The upper frequency limit of the circuit can be extended by adding a cascoded common-base second stage, making the configuration less sensitive to the base-collector capacity of the composite stage.

*Carlos A. Riveros, Systems Development Div., International Business Machines Corp., San Jose, Calif.*

VOTE FOR 111

## Pin diode switches microwave oscillator

Turning a microwave solid-state oscillator on or off by such conventional means as removing the dc bias or gating the emitter to ground causes a deterioration in turn-on time. The deterioration is due to the heating and cooling of the transistor junction by collector-current flow and cutoff when the dc bias is removed. After turn-on, this thermal effect causes a time lag before the oscillator comes back to frequency. If the oscillator could be turned on and off while maintaining collector-current flow, then the thermal effect would be eliminated.

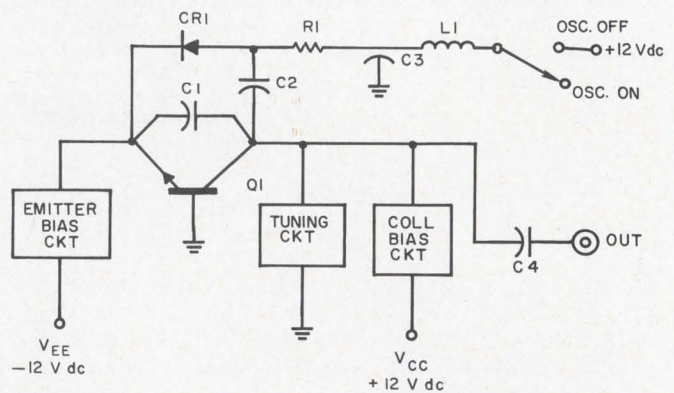

NOTE: MINIMUM LEAD LENGTH IN PIN DIODE CIRCUIT

- C1 = FEED BACK CAP (IF NEEDED)
- C2 = 1000 pF CHIP CAP
- C3 = 1000 pF CHIP CAP
- C4 = OUTPUT COUPLING CAP
- CR1 = HP 3001 pin DIODE
- Q1 = HIGH FREQ TRANS
- R1 = 1k $\Omega$
- L1 = 0.1 $\mu$ H RFC

Microwave oscillator is switched on and off by applying and removing forward bias to the pin diode, CR1.

Use the new Fluke 931A to measure virtually any waveform within 0.05% from 30 Hz to 50 KHz. Make these measurements without losing null sensitivity as the voltage decreases. For in the Fluke 931A, the null meter indicates percent deviation from the dialed voltage. Overall frequency response is 10 Hz to 1 MHz. Range is 0.01 to 1100 volts. Ten to one crest factor takes care of effects caused by voltage spikes and pulse trains. Other features include low capaci-

tance, high resistance input, inline digital readout with lighted decimal point, all solid state design, and linear recorder output. Meets MIL-SPEC shock and vibration requirements. Ten percent overranging cuts down range changing. Available with or without probe in both line and combination line rechargeable battery powered versions. Base price \$895. Call your full service Fluke sales engineer (see EEM) for a demonstration or write us for full information. See us at WESCON Booths 3209, 3210, 3211



**When you use the probe to make true RMS measurements with the Fluke 931A AC differential voltmeter, you don't do a thing to the circuit or the meter. All you do is move the input 30 inches closer to the measurement without added loading or loss of sensitivity. That's just one more reason AC metrology isn't the same anymore.**

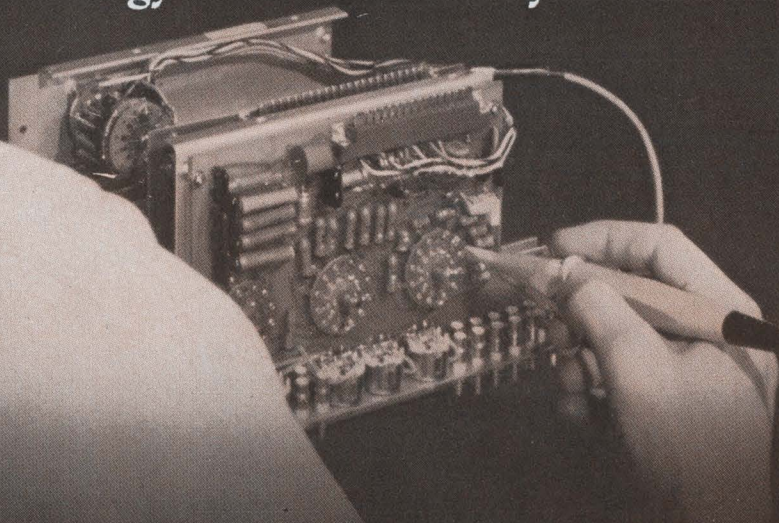

**FLUKE**

Fluke. Box 7428, Seattle, Washington 98133 • Phone: (206) 774-2211 • TWX: (910) 449-2950  
In Europe, address Fluke International Corporation • Suite D, Ambassador Hotel,  
Sophialaan 2, The Hague, The Netherlands • TELEX: 845-53239

The turn-on time would also be very rapid (about 50 ms), with a frequency error of approximately 500 kHz for an oscillator operating at 1500 MHz.

This can be accomplished by placing a pin diode (HP3001) in the feedback circuit of the oscillator (see schematic) either in place of or parallel with an existing feedback capacitor, depending on the amount of feedback the oscillator requires initially. When a forward bias is applied to the pin diode, its resistance will drop from 10 kΩ to about 10 ohms, producing sufficient loss in the feedback circuit to stop the oscillator functioning while maintaining collector-current flow (except for a small amount of current which will be drawn by the pin diode circuit).

To turn the oscillator off apply +12 volts to the pin diode circuit. Remove the +12 volts and the oscillator will turn on.

August Barone, Engineering Associate, Cutler-Hammer, Airborne Instruments Laboratory, Melville, N. Y.

VOTE FOR 112

## Logical clock phase correction for PCM data

A simple logical method, employing pulse width detection, corrects any improper phase relationship between received PCM data and a clock signal generated by a PCM telemetry system and synchronized with the data bit frequency. An incorrect phase relationship usually occurs when the telemetry system handles a biphasic form of PCM data. When the system clock is out of phase with the data, the wrong information will be decoded by the telemetry decommutation system. Usually the error will be an inversion of the actual incoming data. The telemetry unit may never acquire proper frame synchronization if this incorrect phase relationship exists, since a unique synchronization code may never be recognized.

Biphase PCM data contain data transitions every clock period regardless of data content. If the data are sampled at the 180° point of every clock period, a positive-going transition in the data at this time indicates a 0 data bit, while a negative-going transition indicates a 1 data bit. The telemetry system clock would usually be synchronized with the incoming data transitions; therefore, with either a 1 or 0 data bit. The bit-synchronized clock would thus be either in phase or 180° out of phase with the received data. Once the phasing problem is solved for biphase data, however, this type of data is much more useful than other PCM formats. This stems from the fact that biphase data contain data transitions every

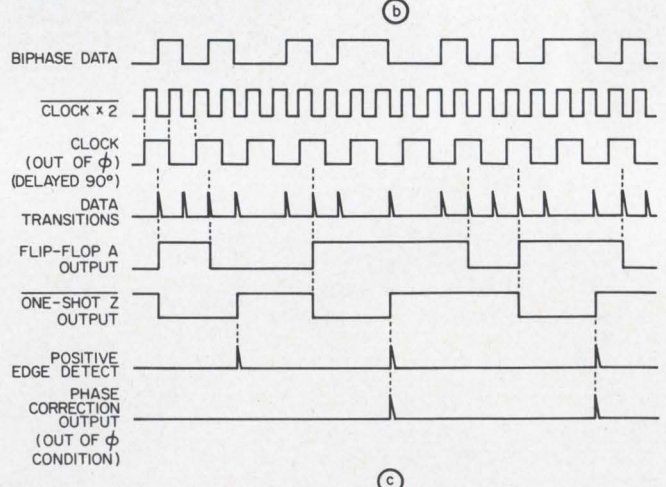
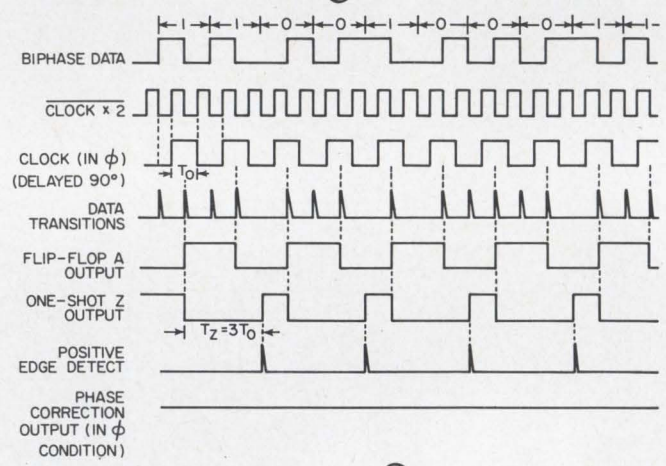
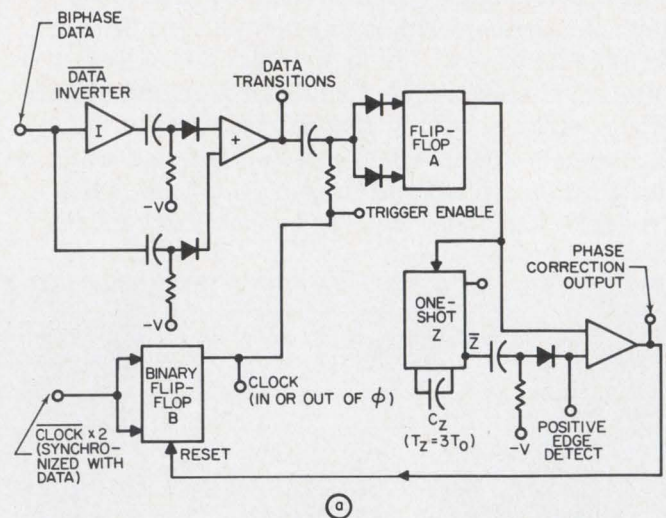

**Clock phase correction** for biphase PCM data is performed by the circuit shown in (a). Timing diagrams for in-phase and out-of-phase conditions appear in (b) and (c), respectively.

bit time. This allows a telemetry clock servo system to achieve bit and frequency synchronization faster than with the other data formats, since there are more correction signals available per unit time. Frame synchronization can also be achieved sooner, so that fewer useful data are lost.

Input signals required (see Fig. 1a) are the

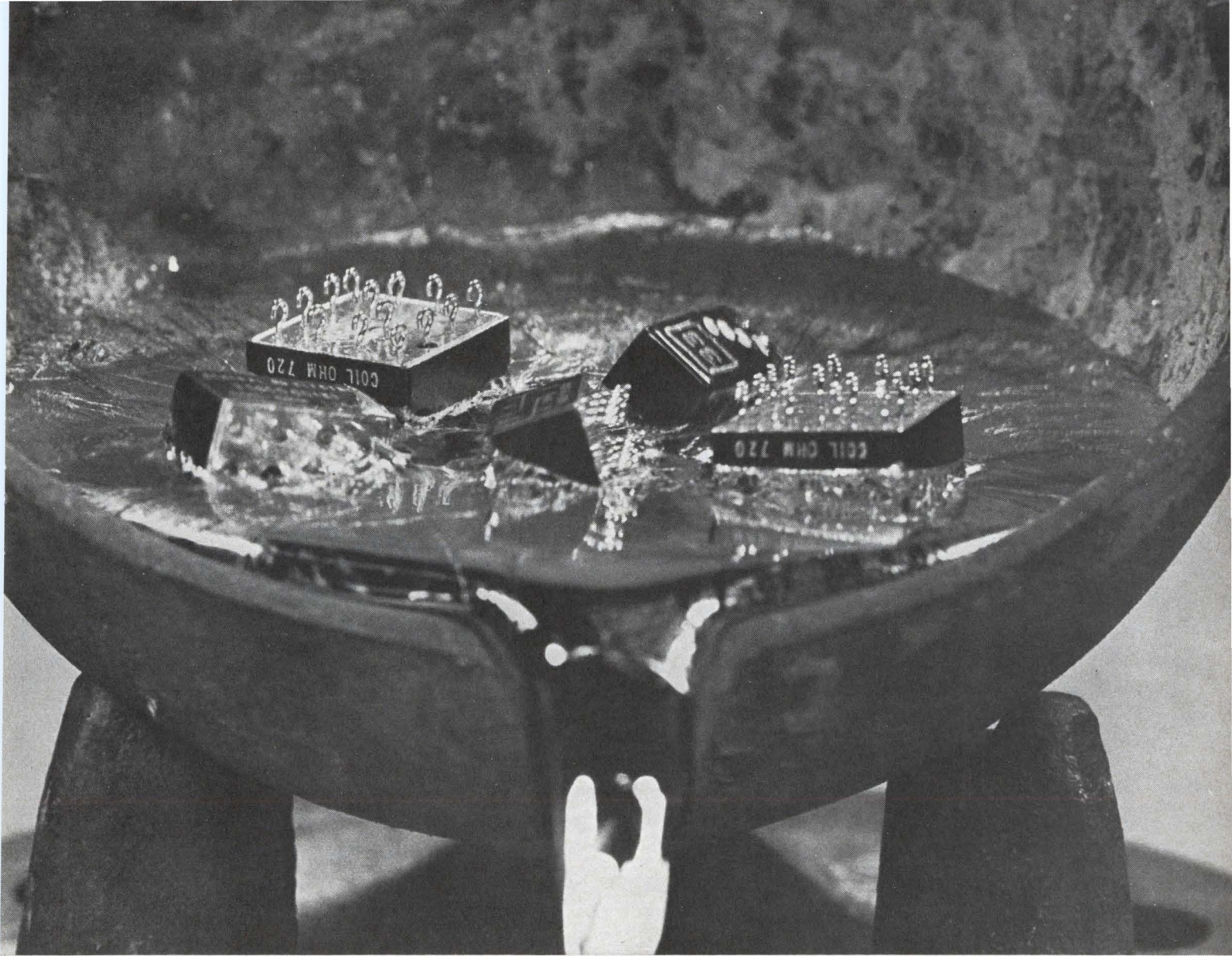

# Molten-solder temperatures won't hurt G-E 150-grid relays

During degassing, G-E 150-grid relays get even hotter than the 356F it takes to melt solder. And it's good for them. High-temperature degassing removes much more of the organic volatiles that can contaminate a relay at normal operating temperatures.

Not many relays can stand the heat. G-E 150-grid relays can because they have a polyimide coil insulation and a welded can-to-header seal. Polyimide insulation withstands 50% more heat than conventional fluorocarbons. And a weld won't melt like a soldered joint.

New materials and fabrication methods are constantly being developed and used by General Electric to make its sealed relays more reliable. Get the full story from your G-E Electronic Components Sales Engineer. Or write for bulletin GEA-8024B, Section 792-39, General Electric Co., Schenectady, New York.

*Specialty Control Department, Waynesboro, Va.*

**GENERAL**  **ELECTRIC**

digital form of the biphase input data, and a  $\overline{\text{clock}} \times 2$  signal, which is twice the frequency of the basic clock signal, inverted and synchronized with the data (a bar above the signal indicates inversion). The  $\overline{\text{clock}} \times 2$  signal should be available in most PCM systems, since the basic data clock would usually be generated by a high-frequency oscillator with a frequency divided down by a binary counter chain. This chain would be synchronized with the data transitions. The  $\overline{\text{clock}} \times 2$  signal taken from this counter chain is used as a trigger input for the binary flip-flop *B*, shown in Fig. 1a. Flip-flop *B* will then generate the basic data clock, delayed by  $90^\circ$ , either in phase or  $180^\circ$  out of phase with the data (Figs. 1b and 1c). The biphase *data* signal and the biphase  $\overline{\text{data}}$  signal generated by the inverter amplifier are differentiated at the input of the OR gate to detect the positive- and negative-going transitions of the data. All the data transitions, which will be detected at the output of the OR gate, are then used as the binary trigger input for flip-flop *A*, and the clock signal is used as the *Trigger Enable* input for *A*. The output of *A* will change state whenever there is a data transition present and the clock is in a 1 state. When the clock is in the "In  $\phi$ " condition, the output of *A* will be a square wave, one-half the basic clock frequency (as shown in Fig. 1b). The leading edge of *A* output is used to trigger one-shot *Z* which produces a pulse three times as long as the clock pulse width. The positive edges of the one-shot  $\overline{Z}$  pulse are then detected, and gated with the *A* output. Since the pulse width of the one-shot  $\overline{Z}$  signal is always greater than the *A* output in the "In  $\phi$ " condition, the positive edges of the  $\overline{Z}$  signal always occur when *A* output is in the 0 state; hence, there is no phase correction output from the AND gate (Fig. 1b). However, when the clock is  $180^\circ$  out of phase with the data, the *A* output (as shown in Fig. 1c) will no longer be a symmetrical square wave, because there is no longer a definite periodic coincidence of data transitions with the clock in the 1 state, as in the "In  $\phi$ " condition. Therefore, the pulse width of *A* can be greater than the  $\overline{Z}$  pulse width, and the detected, positive edges of the  $\overline{Z}$  signal can occur when the *A* output is in the 1 state (Fig. 1c). When these two signals are coincident, a phase correction output will be generated at the output of the AND gate and this signal can then be used to reset binary flip-flop *B* to correct the clock phase.

The data frequency at which the design will operate depends only on the value of capacitor  $C_z$ . This value should be chosen so that  $T_z = 3T_o$ , where  $T_z$  = pulse width of one-shot  $\overline{Z}$  signal and

$T_o$  = pulse width of clock signal.

Stanley Teich, Computer Engineer, Grumman Aircraft Engineering Corp., Bethpage, N. Y.

VOTE FOR 113

## Transfer function plotted on a storage oscilloscope

A convenient method of plotting characteristics of potentiometers or other networks requires only a storage oscilloscope or an X-Y plotter and a variable dc power supply.

Suppose the transfer function of a loaded potentiometer is to be plotted as a function of shaft angle or position, as in Fig. 1a.

The transfer function equation of this network, neglecting external loading at  $e_o$ , is:

$$e_o/e_i = [x(a+1-x)]/[a-x(1-x)],$$

where:

$x$  = some fraction of full shaft rotation,

$a = R2/R1$ .

The equipment for generating the transfer function is shown in Fig. 1b.

Potentiometer  $R_s$ , which is equal to  $R1$  unloaded (i.e., without  $R2$ ), is ganged with  $R1$  on the same shaft.

Connecting points *B* and *A* of Fig. 1b to the

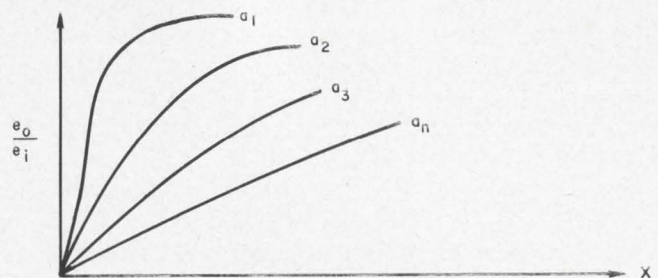
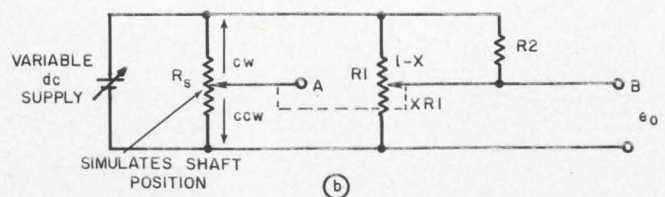
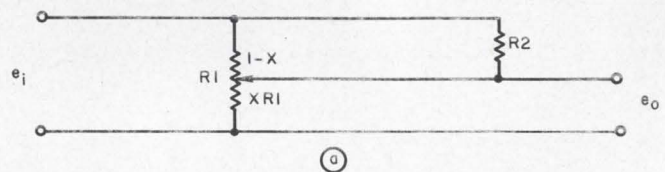

Transfer function of loaded potentiometer  $R1$  (a) can be plotted on a storage oscilloscope or an X-Y plotter with the circuit shown in (b). A set of transfer function curves vs potentiometer setting appears in (c).

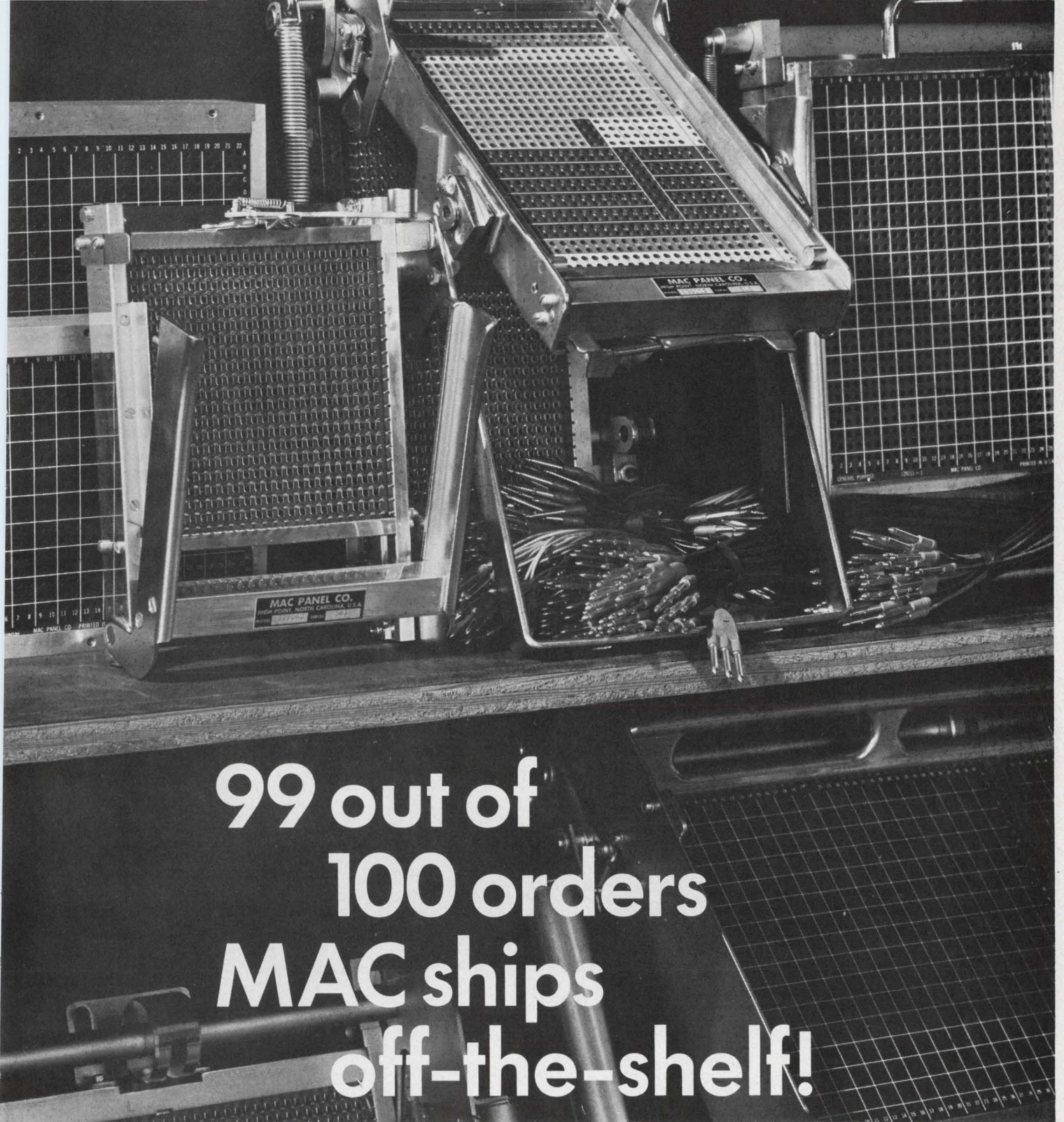

# 99 out of 100 orders MAC ships off-the-shelf!

(that 100th may take a little longer)

Every day we ship, from stock, plugboards in incredible variety — 200 to 5120 positions, fixed or removable. Receivers — standard, high shock and special design. We also ship — from stock — plugwires in diverse and varied configurations. MAC has a habit of having what you need on hand; we also

have the habit of shipping within 24 hours of receipt of orders. We work very hard to maintain both habits. So if you're tired of waiting four weeks, six weeks — or who-knows-how-long? — check with MAC. You'll find that nobody meets your requirements better. And nobody, but nobody, ships as fast. Even on those special orders.

If you're thinking this is just brag-and-boast, consider. An order will prove it, one way or the other. So order. We're ready.

## **MAC**

O.E.M. DIVISION

MAC Panel Co., Box 5027, High Point, N.C. 27261

oscilloscope's *y* and *x* inputs, respectively, and rotating the ganged potentiometers result in the pattern of Fig. 1c. Many curves can be plotted simply by changing *a*. They can also be displayed simultaneously. Various other network and transfer functions may be displayed in a similar way.

Ron Tolmei, Graduate Student, University of Vermont, Burlington, Vt.

VOTE FOR 114

## Temperature monitor tracks voltage drifts

An X-Y plot of FET or transistor parameters versus temperature is often needed to determine circuit performance completely. One instance is with the gate voltage drift of a FET when it is biased at a particular drain current. The X-Y plot can be used to advantage to find the proper bias current.

The temperature-monitoring circuit uses a current-limiting diode and a silicon resistor in the simple configuration of Fig. 1a. The current-

limiting diode (Motorola 1N5288 or Siliconix CL4710) provides a constant current, independent of power supply variations, for a silicon resistor. The latter has a positive temperature coefficient of 0.7%/°C and is placed in the oven close to the device under test. The balance potentiometer provides a reference zero for the temperature read-out. As shown, the sensitivity is approximately 11 mV/°C. This can be modified by changing the current-limiting diode or the Sensistor.

A typical use is shown in Fig. 1b. This circuit checks p-channel enhancement MOSFETs for gate voltage drift at a specific drain current. In one actual application, this setup provided the means for adjusting the drain current to the point where the  $V_{GS}$  drift was less than 0.25 mV for a 50°C temperature change. (The device used was a GI MEM551.)

Thomas H. Lynch, Technical Staff, Bunker-Ramo Corp., Canoga Park, Calif.

VOTE FOR 115

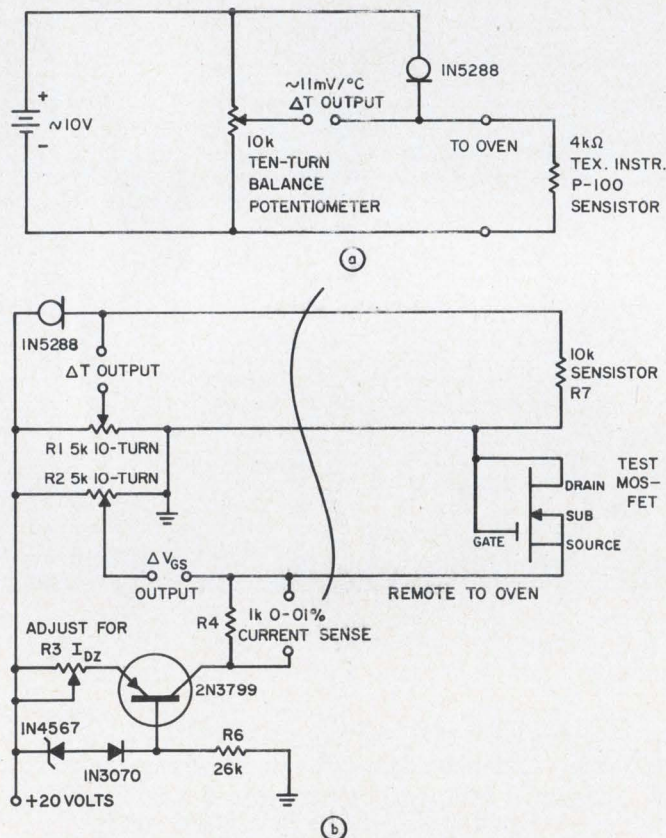

1. Simple temperature-monitoring circuit (a) is used to check p-channel enhancement MOSFET gate voltage drift versus temperature in the complete test circuit (b). The drain current is adjusted with potentiometer R3 until the desired drift characteristics are achieved.

## Simple circuit recognizes pulse width and amplitude

The illustrated circuit produces an output pulse when pulse widths of predetermined magnitude, or greater, are presented at the input.

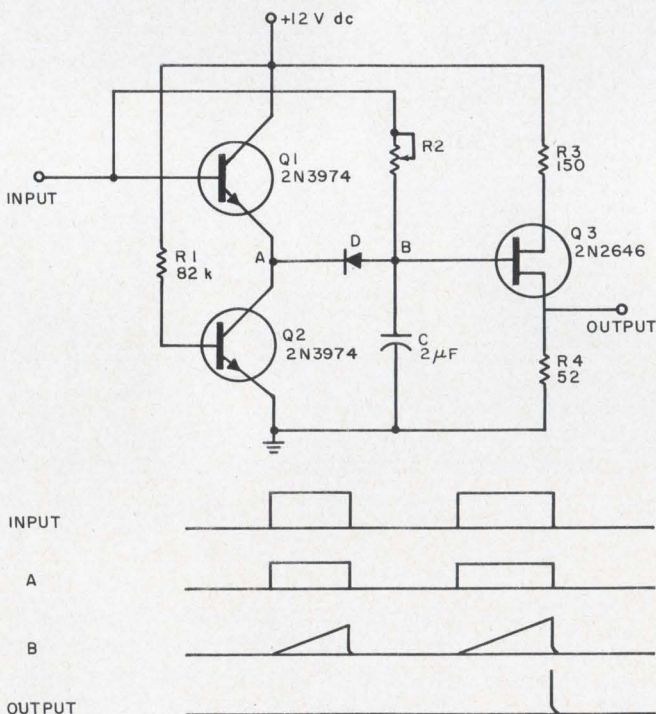

Output pulse is generated by the circuit only when the input pulse exceeds predetermined widths and amplitude. Value of C and the setting of pot R2 determine the minimum pulse characteristics required to produce an output.





## 70% integrated circuitry. (For good measure.)

We make our Model 7000 DVM with integrated circuits to give you a better instrument at lower cost.

For example, you get an accuracy of 0.01% of reading and 100 $\mu$ V resolution in our basic, \$1150.00 instrument. You get dual-slope integration which combines integration techniques and comparison to an internal standard to achieve both noise rejection and stability. That means you don't have to calibrate the instrument daily or weekly.

No red buttons, no screwdriver adjustments. You get low power operation that requires no fan and makes no noise. And you can get it all into half of a standard rack.

When it comes to options you can get five: Auto range, AC, Resistance, DC current, and BCD output. Each option is contained on a single plug-in circuit board. You can use any or all of the options simultaneously.

You can get the instrument with the first four options for \$1550.00.

Or all five for \$1595.00.

And, of course, you can get our data sheet and brochure for free.

**FAIRCHILD**  
INSTRUMENTATION

FAIRCHILD INSTRUMENTATION / A division of Fairchild Camera and Instrument Corporation  
475 Ellis Street, Mountain View, California, (415) 962-2011 / TWX: 910-379-6944

A pulse appearing at the input also appears at point A, reverse-biasing diode D. Capacitor C then commences to charge through R2. Charging continues as long as the original pulse is present. Selecting R2 and C will permit unijunction Q3 to fire for pulses of a specified width or greater.

The input pulse amplitude must be greater than  $\eta$  times B+ to fire Q3 (where  $\eta$  is the intrinsic stand-off ratio of the unijunction). The width of

input pulse that is recognized is adjusted by R2. To recognize pulse widths on the order of 50 ms, a potentiometer of about 40 k $\Omega$  is adequate.

If the input pulses are too narrow to fire the unijunction, point A, which follows the input, will go low. The diode will then be forward biased and C will discharge through D and Q2, preparing the circuit for sequential pulses.

Ben A. Tripp, Test Set Engineer, Northern Electric Co., Ltd., London, Ont., Canada.

VOTE FOR 116

## Five-bit counter saves a package

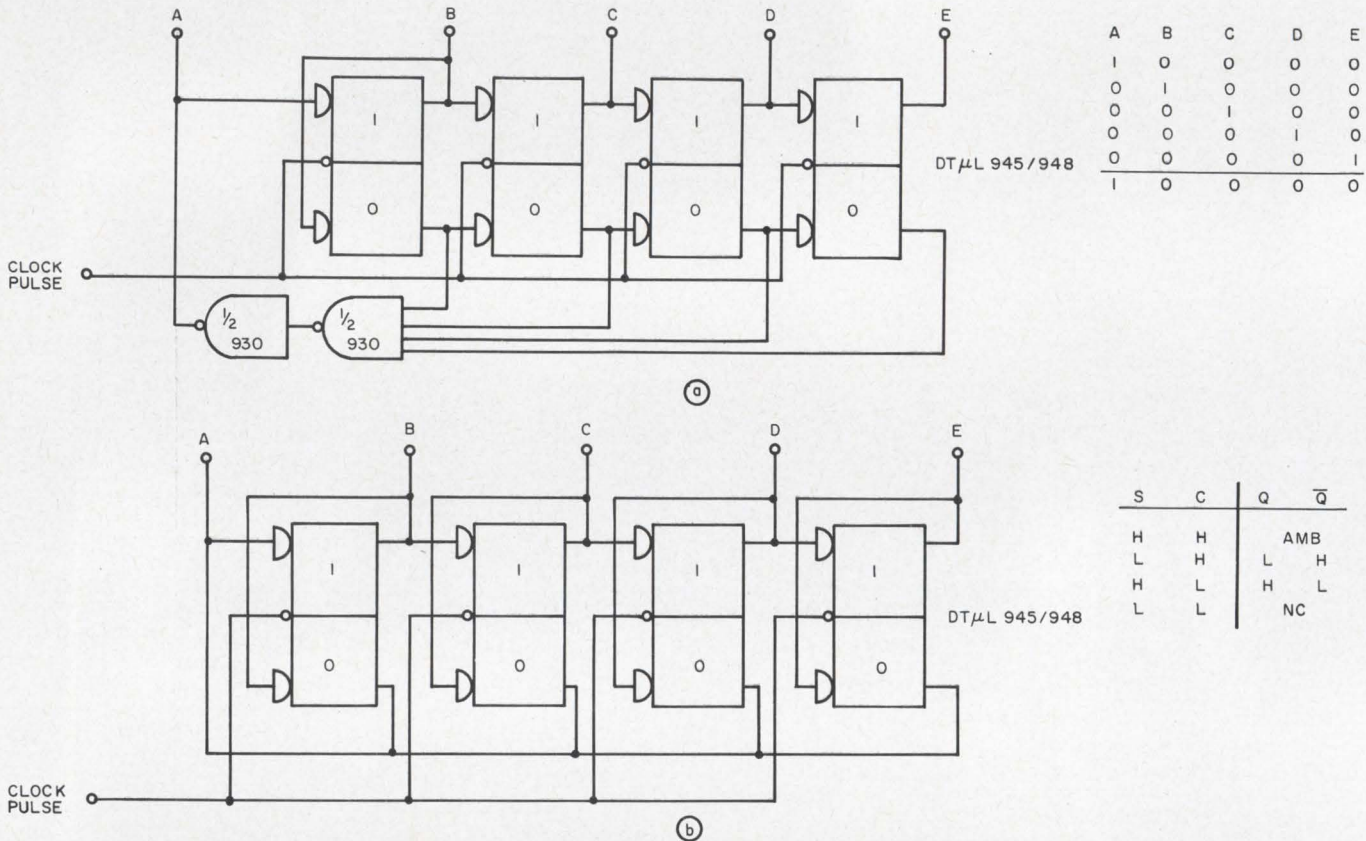

1. Five-bit shift counter has four-bit gate and inverter to complete the ring (a). Modified counter omits gate and

inverter and by wire ORing all 0 outputs keeps them all low if any one is low (b).

The generally accepted method for constructing a five-bit counter is outlined in Fig. 1a. Figure 1b shows a new method that saves one package containing a four-input gate and an inverter.

Uses for this counter might be as a bit feed-back shift counter or, with an additional flip-flop, as a binary or decade counter.

The DT $\mu$ L 945/948 clock-gated flip-flops operate on the master-slave principle. Information enters the 'master' when the trigger input voltage is high and transfers to the 'slave' when it goes low. Thus, in Fig. 1b, when BCDE are all 0, all 1 outputs are low and all 0 outputs are high. E will not change until the clock transformation is complete. Hence the low set input for the first flip-flop will have no effect until the next clock. The 0 outputs are wire ORed; thus B will not reset until all the outputs are low.

Orville L. Lykins, Systems Engineer, Fairchild Semiconductor, Mountain View, Calif.

VOTE FOR 117

### IFD Winner for April 1, 1967

James F. Teixeira, Sylvania Electronic Systems, Inc., Applied Research Laboratory, Waltham, Mass. His Idea, "Two-transistor circuit makes decoupled full-wave rectifier," has been voted the \$50 Most Valuable of Issue Award.

Cast Your Vote for the Best Idea in this Issue.



**Keep your  
contacts  
discrete, buddy.**

It's more reliable that way. We know, we kept that in mind when we set up our pin encoder network. Put in multiple discrete contacts instead of brushes. Results are no secret—30g vibration, 2,000 cps, 150g shock doesn't faze them. What's more, they're guaranteed during revolutions, 10,000,000 of them.

With that much working for you, how can you afford not to team up with the discrete encoders, pin contact encoders from Litton? Pass it along, buddy. Encoder Division, 20745 Nordhoff St., Chatsworth, California.



 **LITTON INDUSTRIES  
ENCODER DIVISION**

# MOS-FET memory stores signal for $10^6$ s

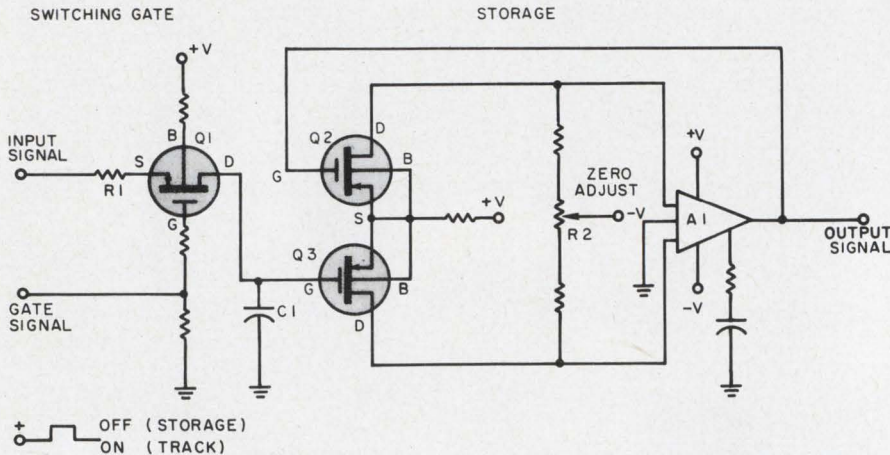

**Problem:** Design a system that can maintain the signal voltage at the output of an analog amplifier when the input signal is interrupted or removed. For some automatic control and instrumentation applications, it is desirable to store and read out the last input received prior to signal interruption so that no information is lost during the absence of input. In addition to a single-storage mode, the unit must have a tracking mode of operation, during which the output voltage of the unit must duplicate the input voltage.

**Solution:** Use MOS-FET (metal oxide semiconductor field-effect transistor) devices as voltage-controlled switches in a memory circuit and trigger them by an external voltage-sensing device. The circuit makes use of the zero offset switching capability and extremely high input impedance characteristics of MOS-FET devices.

The memory unit is composed of three main parts: a filter ( $R1$ ,  $C1$ ) that removes unwanted voltage variations or noise; an analog signal gate ( $Q1$ ) that switches the unit between its two modes of operation (tracking mode and storage mode); and a highly accurate unity-gain storage device ( $Q2$ ,  $Q3$ ,  $R2$ ,  $A1$ ) that provides a duplicate of the input voltage at its output terminals.

When the input signal is applied, an external sensing device turns input gate  $Q1$  on and places the unit in its tracking mode of operation. The voltage on capacitor  $C1$  represents the desired signal data and is applied to the unity-gain amplifier, which consists of a pair of MOS-FET devices,  $Q2$ ,  $Q3$ , and an integrated operational amplifier,  $A1$ . Balance control  $R2$  cancels any amplifier offset voltage.

Upon loss of the input signal, the input gate is switched off by an external voltage-sensing device. This action converts the unit from a tracking mode to a storage mode of operation. The last signal level received prior to signal dropout is stored in capacitor  $C1$  and maintained at the output terminals of the circuit. Leakage of charge from capacitor  $C1$  through the two MOS-FET devices,  $Q1$  and  $Q3$ , is impeded by the extremely high input and gate-off impedances of the MOS-FET devices. Since the time constants of the capacitor-MOS-FET impedances are extremely high, the voltage on the capacitor decays very slowly and can be considered essentially constant during the relatively short signal-dropout periods. When the input signal returns, the circuit is switched back into its tracking mode of operation by the external voltage-sensing device.

Selection of a capacitor of proper material has resulted in time constants in the order of  $10^5$  to  $10^6$  seconds—values much larger than the longest signal-dropout time anticipated.

The choice of time constant at the memory input is determined by the following:

- Amount of smoothing required.
- Amount of decay encountered during the gates' switching time.
- Expected time between signal dropouts.
- Time derivative of input signals.

*Inquiries concerning this innovation may be directed to: Technology Utilization Officer, Marshall Space Flight Center, Huntsville, Ala. 35812 (B66-10603).*

## Microcurrent generator accurately controls 1 pA

**Problem:** Control accurately the output of a current generator in the range of  $10^{-11}$  to  $10^{-3}$  amperes, to test low-current devices such as ion chambers.

**Solution:** Use operational amplifiers, current dividers and a transistor in a design that provides a current output that equals  $\text{antilog}(V_{in}/K)$ , where  $K$  is determined by circuit parameters, and can be controlled accurately.

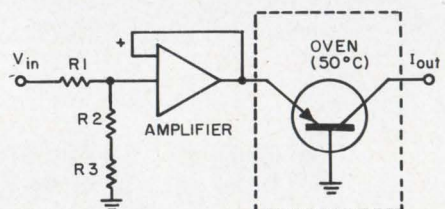

The microcurrent generator in the figure meets this requirement; i.e.,  $V_{in} = K \log V_{out}$ . The voltage divider,  $R2$ , is used to set the value of  $K$ . For this particular circuit to produce a current change of one decade,

# SPERRY

DIVISIONS OF  
SPERRY RAND  
CORPORATION

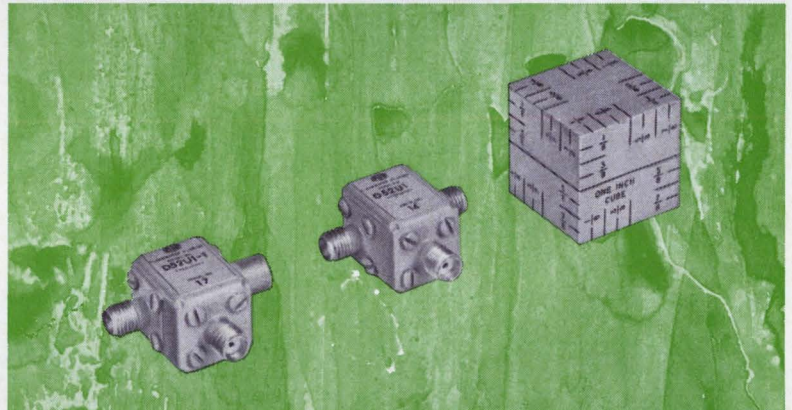
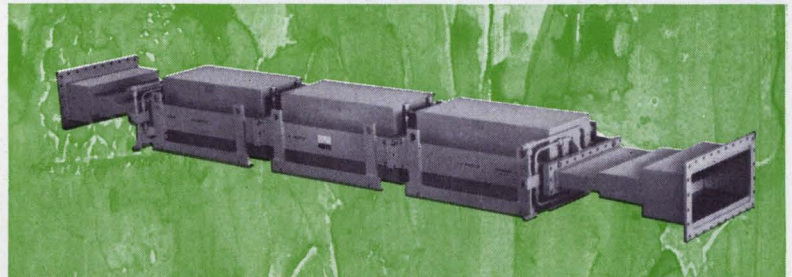
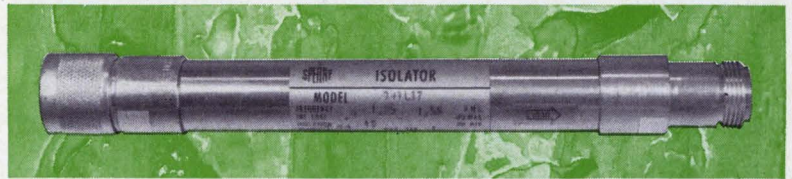
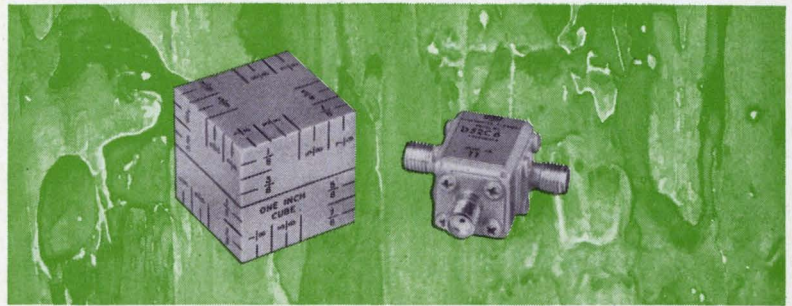

How much isolation does your microwave system need? How low must isolator insertion losses be?

Regardless of your answers, the right isolator or circulator is most likely to come from Sperry, no matter what frequency range you're working in.

After all, the coaxial isolator was invented at Sperry, and Sperry has set the pace in its development. Today the Sperry line is unquestionably the industry's most comprehensive.

You can get 217 models of standard Sperry isolators and circulators. Frequencies range from 0.1 to 40 GHz. Isolation can be as high as 40 db; insertion loss as low as 0.3 db. Remarkable custom development capability is also available.

Write for our new catalog and look over the line. Then, if you don't see exactly what you want, ask for it. Ask your Cain & Co. man or write Sperry Microwave Electronics Division, Sperry Rand Corporation, Box 4648, Clearwater, Florida 33518.

**SPERRY MICROWAVE ELECTRONICS AND  
SPERRY ELECTRONIC TUBE DIVISIONS**  
Sperry Rand Corporation  
Clearwater and Gainesville, Florida

## The world's most comprehensive line of microwave isolators/circulators is Sperry's.

ON READER-SERVICE CARD CIRCLE 55

# NEED A SPARK GAP, TWO ELECTRODE OR TRIGGERED?

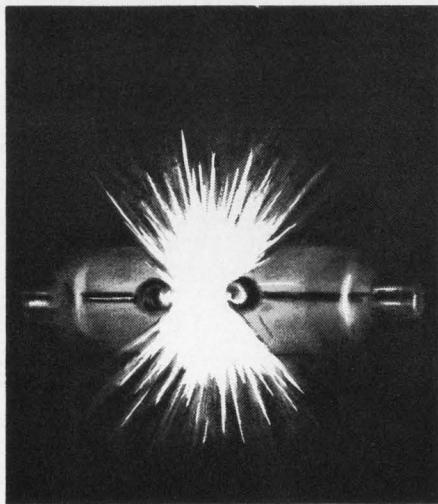

IT'S PROBABLY LISTED HERE

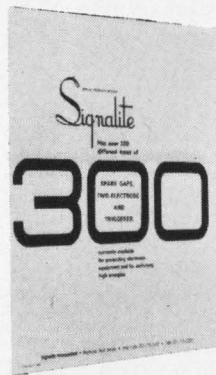

with over 300 others... complete with application notes, characteristics, mounting arrangements, photographs... etc.

IF NOT, WE'LL MAKE IT!

# Signalite

INCORPORATED

NEPTUNE, NEW JERSEY 07753  
Telephone: (201) 775-2490

Signalite has a wide range of microwave noise sources, glow lamps and circuit components to satisfy just about every application.

ON READER-SERVICE CARD CIRCLE 56

## NASA TECH BRIEFS

the voltage at the output of the operational amplifier must change by approximately 60 mV. Stabilizing the transistor by placing it in a temperature-controlled oven at 50°C provides a low-current limitation of the circuit of 10<sup>-10</sup> ampere. The circuit is adjusted so that each time the input voltage changes 2 volts in range, a one-decade change in current is produced. For example, a change from 2 to 4 volts provides a current change of one decade; a change from 2 to 8 volts causes a current change of 3 decades.

For the circuit shown:

$$I_{out} = 10^{-11} \text{ antilog}[(V_{in}/2) + 2].$$

Compensation networks may be added to improve the accuracy at the lower current levels.

For further information, contact Technology Utilization Officer, AEC-NASA Space Nuclear Propulsion Office, U.S. Atomic Energy Commission, Washington, D. C. 20545 (B66-10706).

## Switching transistor controls dc voltages

**Problem:** Design a sensing and controlling circuit for dc voltages using relay coils, in which the current in the relay coil is held to zero for all input voltages up to slightly below the threshold level.

The primary disadvantage of relay coils is that a current, proportional to the sensed voltage, is always in the relay coil, which tends to make the circuit susceptible to external disturbances such as electrical noise and mechanical vibrations.

**Solution:** A circuit in which the control relay is driven by a switching transistor that is biased to cutoff for all input up to slightly less than the threshold level.

In the block diagram (a), the control circuit (b) is used for

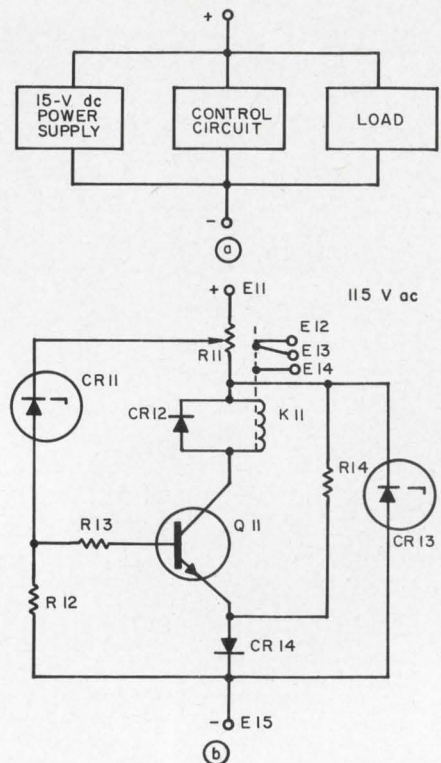

very accurate control of the 15-V dc supply that powers the load. For an input voltage of 15 volts, Zener diode CR13 will conduct and regulate the voltages across relay K11 and resistor R14. A constant current will be maintained in diode CR14. The forward voltage in CR14 will be at the same level as the emitter of switching transistor Q11. R11 is adjusted so that Zener diode CR11 does not conduct. Under these conditions the base of Q11 will be at zero volts. Q11 will be cut off and the voltage across K11 will be zero.

As the input voltage increases above 15 volts dc, CR11 will conduct and a potential difference,  $\Delta V$ , will appear at R12. When this potential difference exceeds the Q11 base-to-emitter voltage, the current in Q11 activates relay K11. When K11 is activated, contacts E12 and E13 are broken. This cuts off and locks out the 15-volt power supply controlled by the control circuit.

For further information, contact Technology Utilization Officer, AEC-NASA Space Nuclear Propulsion Office, U.S. Atomic Energy Commission, Washington, D. C. 20545 (B66-10591).

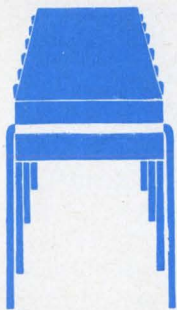
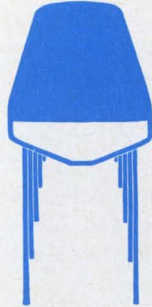
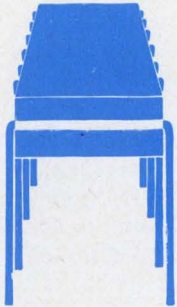
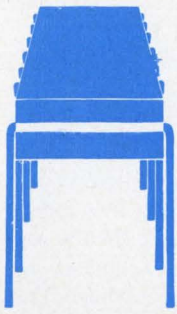

## You get all three in Philco's 9930 Series DTL.

*Philco's 9930 Series DTL: for military, commercial, and industrial applications.* In E-line epoxy dual in line packages, ceramic flat packs, and ceramic dual in line packages. Broad range of circuit functions. Temperature ranges: military and limited for ceramic flat pack and ceramic dual in line; 0 to 75°C for E-line.

Philco's 9930 meets the highest performance and reliability standards. Order now. Immediate delivery in volume quantities.

Call the sales offices and representatives of Philco-Ford: Philco Sales Office, El Segundo, California (213) 772-6226 / Santa Clara, California (408) 245-2966 / Philco Corp. of Canada, Ltd., Ontario, Canada (416) 44-2541 / Straube Associates, Boulder, Colorado (303) 443-8600 / J & J Associates, Hamden, Connecticut (203) 624-7800 / Philco Sales Office, Clearwater, Florida (813) 446-0124 / The John G. Twist Company, Chicago, Illinois (312) 777-2250 / R. O. Whitesell & Associates, Indianapolis, Indiana (317) 359-5374 / Fort Wayne, Indiana (219) 743-4411 / R. O. Whitesell & Associates, Louisville, Kentucky (502) 893-7303 / Philco Sales Office, Burlington, Massachusetts (617) 272-1600 / R. O. Whitesell & Associates, Detroit, Michigan (313) 862-2225 / Benton Harbor, Michigan (616) 927-2041 / Technical Associates, Inc., Minneapolis, Minnesota (612) 929-6721 / Technical Marketing Associates, St. Louis, Missouri (314) 427-3600 / Kansas City, Missouri (816) 523-7865 / Philco Sales Office, Ardsley, New York (914) 693-3700 / Graydon-Sherman Inc., Fayetteville, New York (315) 637-9611 / R. O. Whitesell & Associates, Cleveland, Ohio (216) 333-2585 / Dayton, Ohio (513) 298-9546 / Cincinnati, Ohio (513) 521-2290 / Philco Sales Office, Blue Bell, Pennsylvania (215) 643-2280 / Philadelphia line, Pennsylvania (215) 242-6420 / R. O. Whitesell & Associates, Pittsburgh, Pennsylvania (412) 242-0100 / Dunbar Associates, Inc., Dallas, Texas (214) 363-2536 / Philco Sales Office, Bellevue, Washington (206) 454-5061 / Philco Sales Office, Washington, D.C. (202) 298-7810.



PHILCO-FORD CORPORATION  
Microelectronics Division  
Santa Clara, California • 95051

ON READER-SERVICE CARD CIRCLE 57

**ENGINEERS:  
UNIVAC and you:**  
words to program  
a career by . . .

**"flip  
flop"**



**"FLIP-FLOP" (verb).**

In the "USA Standard Vocabulary for Information Processing" this word means one thing. But in terms of your career it could mean changing jobs too frequently; or changing from one career dead-end to another. So we encourage scientists and engineers and skilled programmers to ask any and all questions which can acquaint them with every aspect of a proposed move to UNIVAC.

Just for example, here are some of the positions we now want to fill . . .

- **Advanced Electronic Circuit Studies**
- **Integrated Circuits and Thin Film Studies**
- **Ultra-High Speed Integrated Circuit Interconnections**
- **Computer Manufacturing Engineering**
- **Industrial Engineering & Cost Analysis**

To make sure a change is a real step ahead, not a mere "flip-flop," write and tell us all about your experience, your desires, your hopes for the future. Include any questions about UNIVAC. We'll write back, as completely as we can. Write: John D. Hallenberg, Employment Manager, Dept. 508.

**Write today and make an  
appointment with tomorrow.**

**UNIVAC**  
DIVISION OF SPERRY RAND CORPORATION

data processing division  
2276 highcrest drive  
roseville, minn. 55113  
telephone 612-633-6170

An equal opportunity employer M/F

## Book Reviews

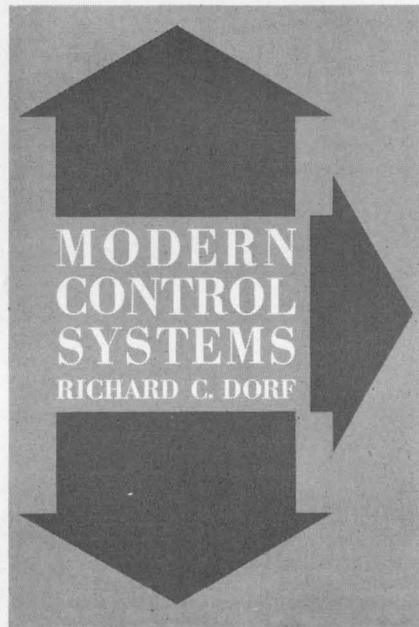

### Feedback control theory

*Modern Control Systems*, Richard C. Dorf (Addison-Wesley Publishing Co, Reading, Mass.), 387 pp. \$12.50.

In addition to well known techniques such as Bode diagrams, root locus, Nyquist criterion, Nichols diagrams and others, the book introduces new concepts in control systems analysis such as parameter sensitivity, state variables, and applications of computers.

Like most books on the subject, the practical side of this one—how to write transfer functions for a variety of physical systems, or how to fill the boxes on the block diagram with functions of the complex variable,  $s$ —leaves much to be desired. In fact, its shortcomings point up the need for a book of this kind.

The various analytical techniques, however, are well presented and the book should be of interest both to the control engineer and to circuit designers, provided the latter can adopt the simple approach of a servo engineer to the feedback problems.

—Peter N. Budzilovich

### Elementary circuit problems

*Circuit Problems and Solutions*, Vol. I: *Elementary Methods*, Gerald Lippin (Hayden Book Co., New York), 190 pp. \$3.95.

Here is an elementary guide for the student or hobbyist. Any point on basic electrical circuit theory can be found with ease—followed by problems and their solution. The reader needs to be familiar only with trigonometry and algebra.

The language is clear and concise. Lippin goes all the way through series-parallel resistance circuits and their solution by loop equations and Kirchoff's Laws. He then briefly covers magnetism and electromagnetism. The  $j$  operator is explained graphically and ac theory step by step. One chapter is devoted to time constants and the last to filter circuits.

### Quality control program

*Zero Defects: A New Dimension in Quality Assurance*, James F. Halpin (McGraw-Hill, New York), 228 pp. \$10.50.

This book is a management tool aimed at the improvement of the quality of goods and services produced or produced. It works toward reduction of defects by endeavoring to instill a constant, conscious desire to do the job right the first time. A how-to-do-it manual for establishing a ZD program, it outlines the stages of such a program step by step. The book is written so that the reader can select the specific techniques best suited to his particular organization.

### Latest SCR developments

*Silicon Controlled Rectifiers*, Allan Lytel (Howard W. Sams, Indianapolis), 128 pp. \$2.75.

This handbook explains the principles of operation of SCRs and tells how they are used in numerous practical control circuits. Phase-shift control of ac and dc power is clearly explained and examples of these circuits are given. The book discusses such circuits as ring counters, temperature controls, and voltage regulators. The chapter on SCR testing will be useful to anyone who works with SCRs.



# Free Career Inquiry Service

## Absolutely Confidential

Respond to the career opportunities advertised in this issue. Fill out and send us this handy resume. **Electronic Design** will do the rest – neatly typed copies of this form will be mailed to the companies of your choice, indicated by the circled Career Inquiry Numbers at the bottom of this page.

14

<b>Name</b>		<b>Home Phone</b>	
<b>Home Address (Street)</b>		<b>City</b>	<b>State</b>
			<b>ZIP Code</b>
<b>Age</b>	<b>U.S. Citizen</b> <input type="checkbox"/> Yes <input type="checkbox"/> No	<b>Security Clearance</b>	

Prime Experience	Secondary Experience

<b>Desired Salary</b>	<b>Availability Date</b>
-----------------------	--------------------------

**Employment History – present and previous employers**

Company	City, State	Dates	Title
		to	
		to	
		to	

**Education – indicate major if degree is not self-explanatory**

Degree	College	City, State	Dates
			to
			to
			to

**Additional Training – non-degree, industry, military, etc.**

---



---

**Professional Societies**

---

**Published Articles**

---

- Career Inquiry Numbers:**
- |     |     |     |     |     |     |     |     |     |     |
|-----|-----|-----|-----|-----|-----|-----|-----|-----|-----|
| 900 | 901 | 902 | 903 | 904 | 905 | 906 | 907 | 908 | 909 |
| 910 | 911 | 912 | 913 | 914 | 915 | 916 | 917 | 918 | 919 |

**ELECTRONIC DESIGN**  
850 Third Avenue  
New York, New York 10022

It took Hughes  
engineers  $3\frac{1}{2}$  years to  
create the  
SYNCOM  
story.

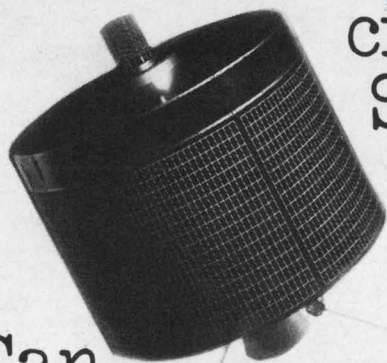

Can  
you write it?

Hughes Field Service and Support is urgently seeking qualified E.E.'s for a dual challenge—to your engineering know-how and to your writing ability. You will be closely associated with the latest and most advanced aerospace projects. As a Systems Writing Engineer, your assignment will be to **communicate** your knowledge of these projects.

The Syncom series is just one example of the magnitude and significance of the projects involved. Other subjects include space vehicles, weapons systems, electronic computers, guided missiles, radar and communications, programmed instructional devices, and systems trainers.

You will research drawings, specifications, and reports; you will interview project engineers and make first-hand examinations and inspections. Then you'll interpret and analyze this data and write engineering publications for use by other engineers on allied projects.

This is a demanding position and an important one. If you wish to rapidly broaden your engineering knowledge and gain systems-oriented technical experience, if you have a B.S.E.E. or a B.S. in Physics—and if you can write—please send your resume at once to: Mr. B. P. Ramstack, Hughes Aircraft Company, P.O. Box 90515, Los Angeles, California 90009. U.S. citizenship required.

**HUGHES**

HUGHES AIRCRAFT COMPANY  
FIELD SERVICE & SUPPORT DIV.

An equal opportunity employer

## BOOK REVIEWS

### Process-control systems

*Process-Control Systems*, F. G. Shinskey (McGraw-Hill, New York), 367 pp. \$16.50.

Here is a practical approach to the design of process-control systems. It is based on the time-domain principle rather than on operational calculus. Using this approach with time plots and simple numerical operations, the most complicated control loops can be analyzed and their performance predicted with "pencil-and-paper" methods. Beginning with a basic description of the properties of simple processes under feedback control, the book gradually introduces more advanced considerations. In this way it develops a procedure for designing complicated systems for the control of multivariable processes. Numerous examples of real applications are given.

### Transistor circuit design

*Transistor Circuit Engineering*, Basil L. Cochrun (Macmillan, New York), 445 pp. \$13.95.

This book is primarily devoted to the engineering design aspects of linear circuitry. The reader is expected to understand basic circuit theory and the physics of semiconductors. Following a review of these, the author develops the intrinsic characteristics of a hybrid- $\pi$  model from a circuit theory viewpoint, using flowgraphs and the superposition concepts of impedance. Variation of the intrinsic parameters of the model with temperature and operating point are then considered in conjunction with biasing—a topic which leads logically to the consideration of extrinsic parameters. Low-frequency amplifiers and low-frequency RC active filters are considered; then high-frequency amplifiers, both wide- and narrow-band, are taken up in turn. Noise, a common denominator of the limitations for all frequencies, is the next consideration. The final chapters examine feedback and stability and provide a modern development of field-effect transistors. Appendices are devoted to the latest techniques.

*"The secret of success in life...  
is for a man to be ready for  
his opportunity when it comes."—Disraeli.*

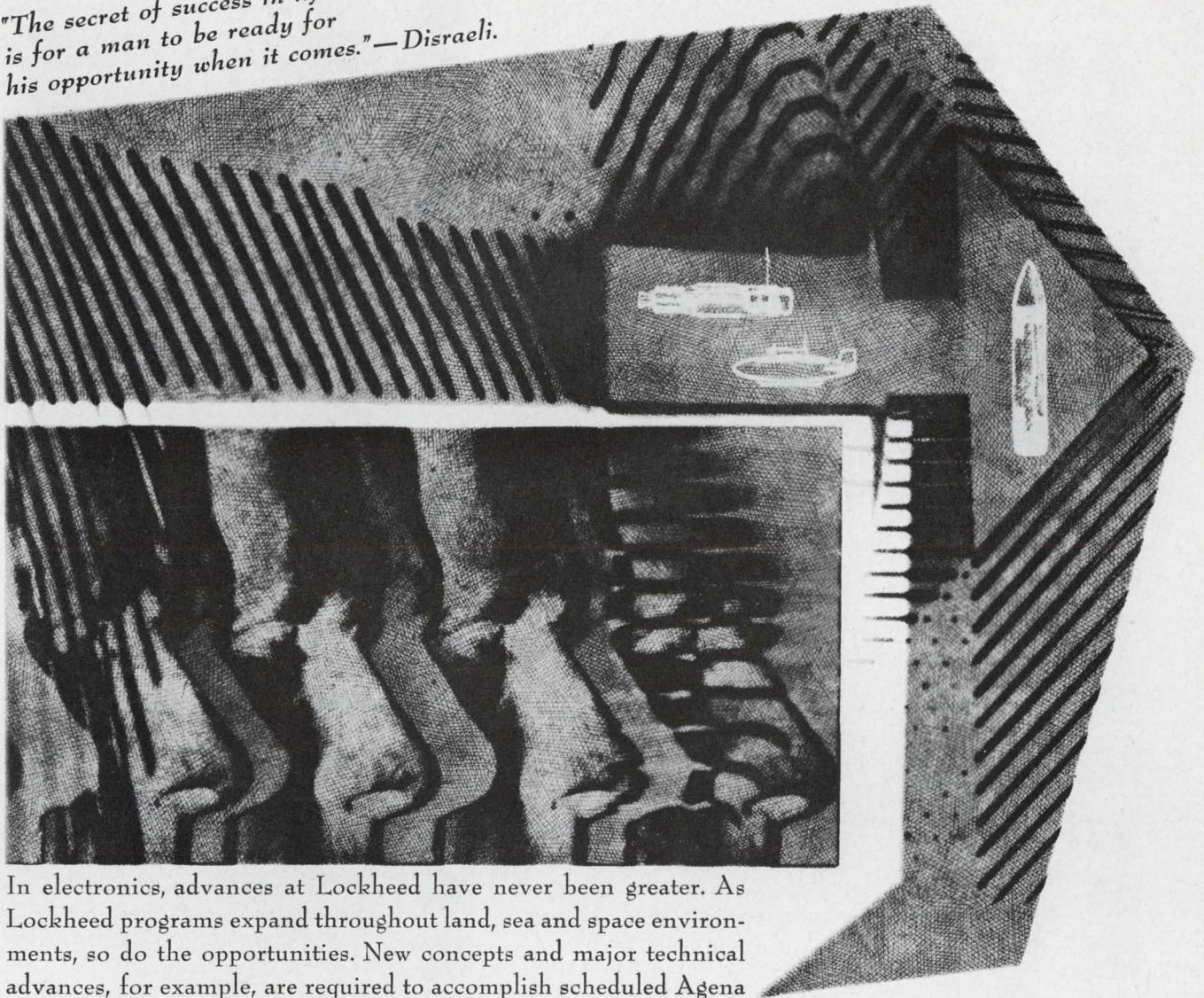

In electronics, advances at Lockheed have never been greater. As Lockheed programs expand throughout land, sea and space environments, so do the opportunities. New concepts and major technical advances, for example, are required to accomplish scheduled Agena flights in years to come—new approaches in digital communication systems for data transmission and command, optical and infrared sensors, solar power panels, power conditioning, digital and analog flight control systems. The number one deterrent force of the future—the Poseidon fleet ballistic missile—requires advances in postulation, establishing requirements, integration, design and use of electronics test and checkout equipment. While on land, advanced vehicle systems and hospital information systems pose unique problems. Undersea, Lockheed offers programs like the Deep Submergence Rescue Vehicle and ocean mining with fresh opportunities in such areas as undersea instrumentation. For more information, write Mr. R. C. Birdsall, P.O. Box 504, Sunnyvale, California 94088. Lockheed is an equal opportunity employer.

**LOCKHEED**  
**MISSILES & SPACE COMPANY**  
A GROUP DIVISION OF LOCKHEED AIRCRAFT CORPORATION

ON CAREER INQUIRY FORM CIRCLE 901

RF CIRCUIT ENGINEERS  
SYSTEMS ANALYSIS ENGINEERS  
SYSTEMS INTEGRATION ENGINEERS  
INDUSTRIAL ENGINEERS  
DIGITAL ENGINEERS

# SEARCHING FOR

## **OPPORTUNITY instead of promises?**

We can't promise you'll realize all your career objectives at ECI, but we will give you every opportunity. And we'll help you every way we can. The rest is up to you.

## **CHALLENGE instead of a chance?**

Challenges lead to accomplishments. Chances don't necessarily lead to anything. If you like the satisfaction of accomplishing things, you'll like working at ECI. We're objective oriented.

## **GROWTH instead of a groove?**

In our business you can't afford to stop learning ... to stop growing. At ECI you'll be pushing the state-of-the-art. There are few confining grooves when you explore the unknown.

## **And LOCATION too?**

If you're going to like your job, you might as well like where you're living. We'll pit the St. Petersburg area against anyplace in the U.S. for stimulating, comfortable living.

## **INVESTIGATE ECI!**

We have immediate openings in design and supervision. You'll work on systems and equipment in satellite communications, multiplexing, electronic switchboards, and advanced VHF/UHF communications using microcircuitry and state-of-the-art techniques.

Send your resume, in confidence, to K. S. Nipper, Supervisor of Professional Placement, Electronic Communications, Inc., Box 12248D, St. Petersburg, Florida 33733. (An equal opportunity employer.)



St. Petersburg Division  
Electronic Communications, Inc.

ON CAREER-INQUIRY FORM CIRCLE 902

## BOOK REVIEWS

### **Silicon integrated devices**

*Fundamentals of Silicon Integrated Device Technology, Vol. 1: Oxidation, Diffusion and Epitaxy*, R. M. Burger and R. P. Donovan, eds. (Prentice-Hall, Englewood Cliffs, N. J.), 495 pp. \$15.00.

This is the first volume of a series on the fundamentals of silicon integrated devices. It describes the practices and theories associated with three of the basic technologies employed in the fabrication of silicon integrated devices. The aim has been to provide a source of information for both the novice and the experienced practitioner. Much practical detail on implementing each process is included. The authors have attempted to identify both the capabilities and the limitations of oxidation, diffusion and epitaxy.

### **Carrier telephony**

*Basic Carrier Telephony*, David Talley (Hayden Book Co., New York), 198 pp. \$4.95.

This is a basic course in the principles and applications of carrier telephony and its place in the overall communications picture. An expanded and updated edition, it reflects important state-of-the-art developments and includes a new chapter on pulse-code-modulation carrier systems. Abundantly illustrated and requiring a minimum of mathematics, it should be useful to all those in the communications and electronics fields, particularly those responsible for engineering, operating and maintaining telephone services.

### **Radar techniques**

*Introduction to Radar*, Denis Taylor (Philosophical Library, Inc., New York), 125 pp. \$4.75.

This pocket book on radar and radar techniques begins with an account of their development during World War II. It discusses various later uses and applications, leading up to how such developments are affecting the modern world.

The material is presented such that the scientific and technical aspects should be easily grasped by a general reader.

Dr. Harold Goldberg,  
Vice President and  
Director, LTV Electro-  
systems; General  
Manager, Garland  
Division; co-author of  
"Principles of Guided  
Missile Design."



THE EXCITING SURGE OF ELECTROSYSTEMS

## CREATIVE SYNTHESIS: TECHNOLOGY IN MANAGEMENT

It's nice to have the boss speak your language.

Dr. Harold Goldberg, IEEE Fellow, weapons systems specialist, scientist and manager, typifies the technically oriented management at LTV Electrosystems.

The Garland Division is drawing upon its experience in electronics and mechanics to penetrate new markets for its guidance systems, RF and specialized antennas, digital communications, electronic warfare systems, space systems, automatic controls, large-scale parabolic antennas and other advanced systems.

Never has the career opportunity been greater than it is right now at LTV Electrosystems' Garland Division and throughout the entire company, where a whole new generation of electronic systems for military and civilian application is being developed.

LTV Electrosystems has grown — in only nine years — from annual sales of \$12.7 million, less than 1,200 employees and one facility to last year's record sales of \$123 million, more

than 8,500 employees (over 2,300 of whom are scientists, engineers and technicians) and a complex of 12 major facilities in five states.

For scientists and engineers who prefer to work at the most advanced level of electronics technology, our Garland and Greenville divisions and the Continental Electronics subsidiaries offer diverse opportunities in an exciting and productive environment.

Specialists in the following (and related) disciplines are invited to examine the advantages of a career with LTV Electrosystems: Analysis and design (RF and digital systems and circuits); electro-optics; transmitter design; airframe design; weights and stress analysis; electro-mechanical engineering; information theory; physics and scientific programming.

Write or call: Mr. Bill Hickey / Supervisor of Professional Placement / LTV Electrosystems, Inc. / P. O. Box 6118 / Dallas, Texas 74222 / Telephone (214) 276-7111. An equal opportunity employer — m/f.

**LTV ELECTROSYSTEMS, INC.**

A SUBSIDIARY OF LING-TEMCO-VOUGHT, INC.

ON CAREER INQUIRY FORM CIRCLE 903

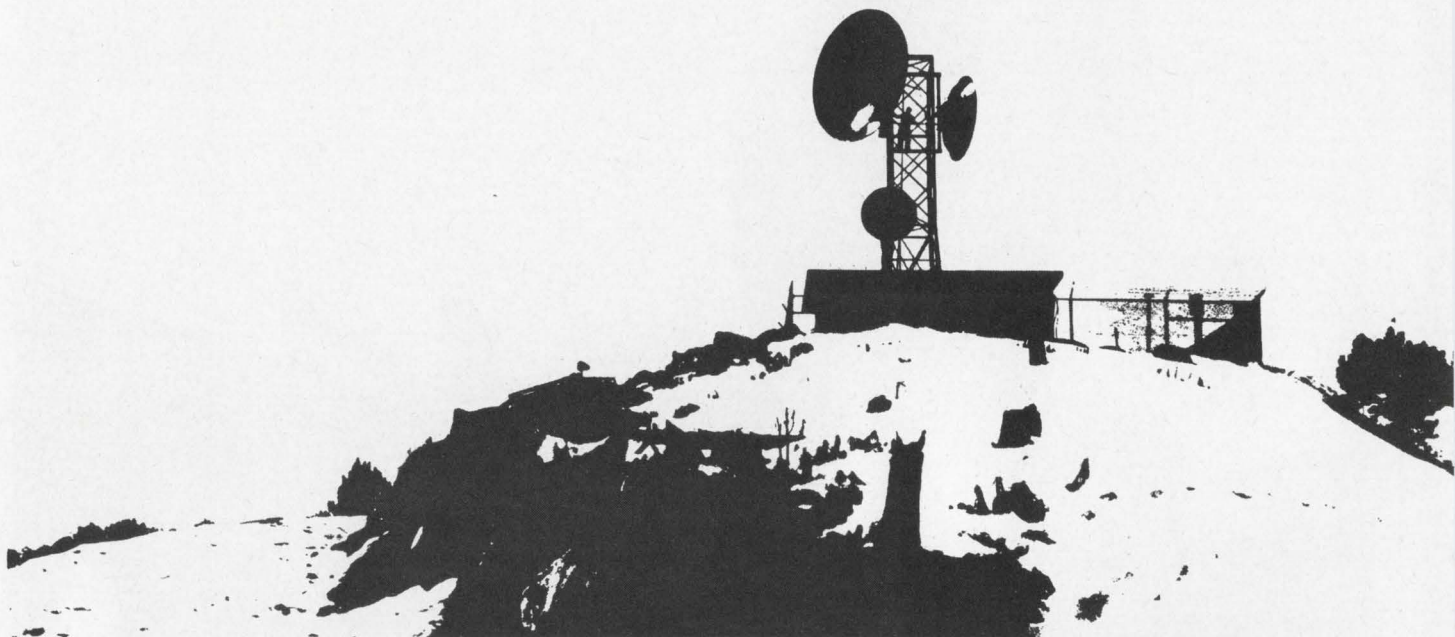

Microwave communication systems serving much of the free world.

Data processing and communication systems used by government and industry.

Specialized aerospace and military systems.



# What Does an EE Do at Collins?

He designs some of the most advanced communication equipment and systems in the world. Examples: all weather systems allowing aircraft to land under reduced minimums, microwave radio systems providing vital communication links across the United States and many foreign countries, data systems used by airlines and railroads, complete earth stations for satellite communications, automatically tuned single sideband maritime systems.

EE's find professional challenge and advancement in Collins' highly diversified technical environment. Collins' continuing growth provides openings for qualified EE's in a wide range of disciplines such as those listed.

- Flight Control Systems Engineers
- Communications Research Engineers
- Circuit Designers
- Process Engineers
- Electronic Packaging Designers
- Systems Engineers
- Microcircuit Designers
- Instrumentation Engineers
- Spacecraft Systems Engineers
- Reliability Engineers
- Field Support Engineers
- RF Systems Engineers
- Antenna Design Engineers
- Microwave Design Engineers
- Quality Engineers
- Transmitter Design Engineers
- Training Instructors
- Crystal Filter Engineers
- Maintainability Engineers
- Component Evaluation Engineers
- Data Systems Analysts
- Computer Programmers/Analysts
- Solid State I.C. Engineers (MOS)
- Data Communications Engineers

For additional information about careers at Collins, send your resume in confidence to Manager of Professional Employment, Collins Radio Company, Dallas, Texas, Cedar Rapids, Iowa, or Newport Beach, California.



AM-FM broadcast systems from microphone to antenna.

Avionic systems used by more than 50 commercial airlines.

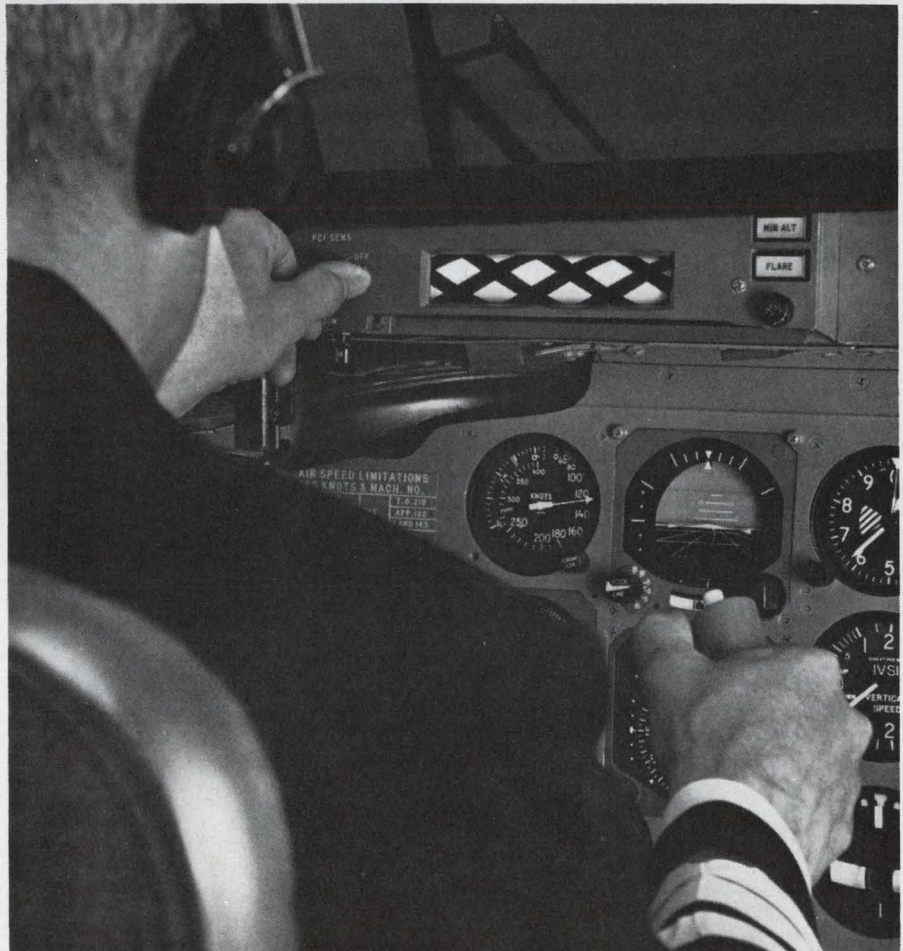

COMMUNICATION/COMPUTATION/CONTROL



an equal opportunity employer

COLLINS RADIO COMPANY / DALLAS, TEXAS • CEDAR RAPIDS, IOWA • NEWPORT BEACH, CALIFORNIA • TORONTO, ONTARIO  
Bangkok • Beirut • Frankfurt • Hong Kong • Kuala Lumpur • Los Angeles • London • Melbourne • Mexico City • New York • Paris • Rome • Washington • Wellington

ON CAREER-INQUIRY FORM CIRCLE 904

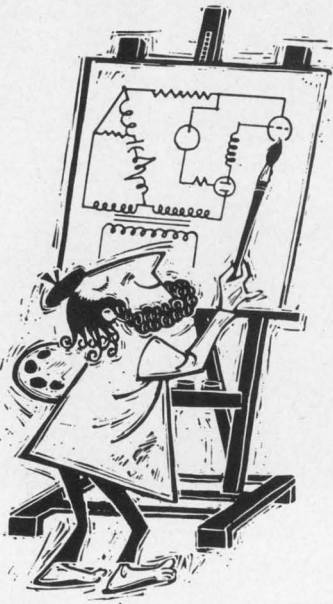

## CIRCUIT DESIGN

The strictly realistic art of circuit design relates directly to our projects in inertial guidance and digital computer systems. If you have fine-line experience in the design and development of micro-electronic circuits for servo, analog and digital applications, write Mr. Frank R. McCarter.

—An equal opportunity employer M/F—



**LITTON INDUSTRIES**, Guidance & Control Systems Division  
5500 Canoga Avenue, Woodland Hills, California

ON CAREER-INQUIRY FORM CIRCLE 905

COUGH...GASP  
...WHEEZE...  
COUGH...

### Sound familiar?

Many people have breathing problems—shortness of breath, persistent cough, too much phlegm—and they brush them off. They hardly notice—until their fun and work are interrupted, their happiness threatened, even their lives. Don't let it happen to you. It might be emphysema or some other respiratory disease. See your doctor. Use the coupon.

Paste on postcard

NTA, GPO, Box 2400, New York, N. Y. 10001



Send me the free booklet, "Your Breathing Troubles"

Name \_\_\_\_\_

Address \_\_\_\_\_

City \_\_\_\_\_

State \_\_\_\_\_

Zip Code \_\_\_\_\_

Published by National Tuberculosis Association, paid for by Christmas Seals.

## Electronics and electricity

*Electronics One-Seven* and *Electricity One-Seven*, Harry Mileaf, ed. (Hayden Book Co., New York), 992 pp. and 976 pp. Available as set of 7 individual paperbound vols.: \$20.95 and \$16.95 set, \$3.45 and \$2.75 ea.; or all 7 vols. in single cloth binding: \$14.96 and \$12.76, respectively.

*Electronics One-Seven* is a course on basic electronics. To teach a technology in a constant state of change, a special presentation has been adopted. Instead of using equipment which may become outdated as a starting point, the course begins with the concept of the electronic signal. Then electronic systems are seen as a series of "building blocks" that produce desired effects on the signal. This approach is thus oriented toward the functional purposes of equipment.

*Electricity One-Seven* is a course in the fundamentals of electricity. With only a minimum of mathematics, a reader can gain an understanding of the theory and practical background of electricity and electrical devices. Emphasis is on modern scientific concepts and interdisciplinary relationships.

## Communication satellites

*Communication Satellite Systems Technology*, Richard B. Marsten, ed. (Academic Press, New York), 1051 pp. \$12.00.

This collection of technical papers surveys communication satellite systems. The first three chapters cover the present state of the art. Commercial systems, military systems, and subsystem and component technological accomplishments applicable to future systems are considered. Chapters four and five center on high-powered systems and systems concepts and their applications. Included are contributions on multiple-access, direct broadcasting and TV networking, the national information grid, and communications from deep space. The final chapter provides an international sociological survey of the effects of communication satellite systems.



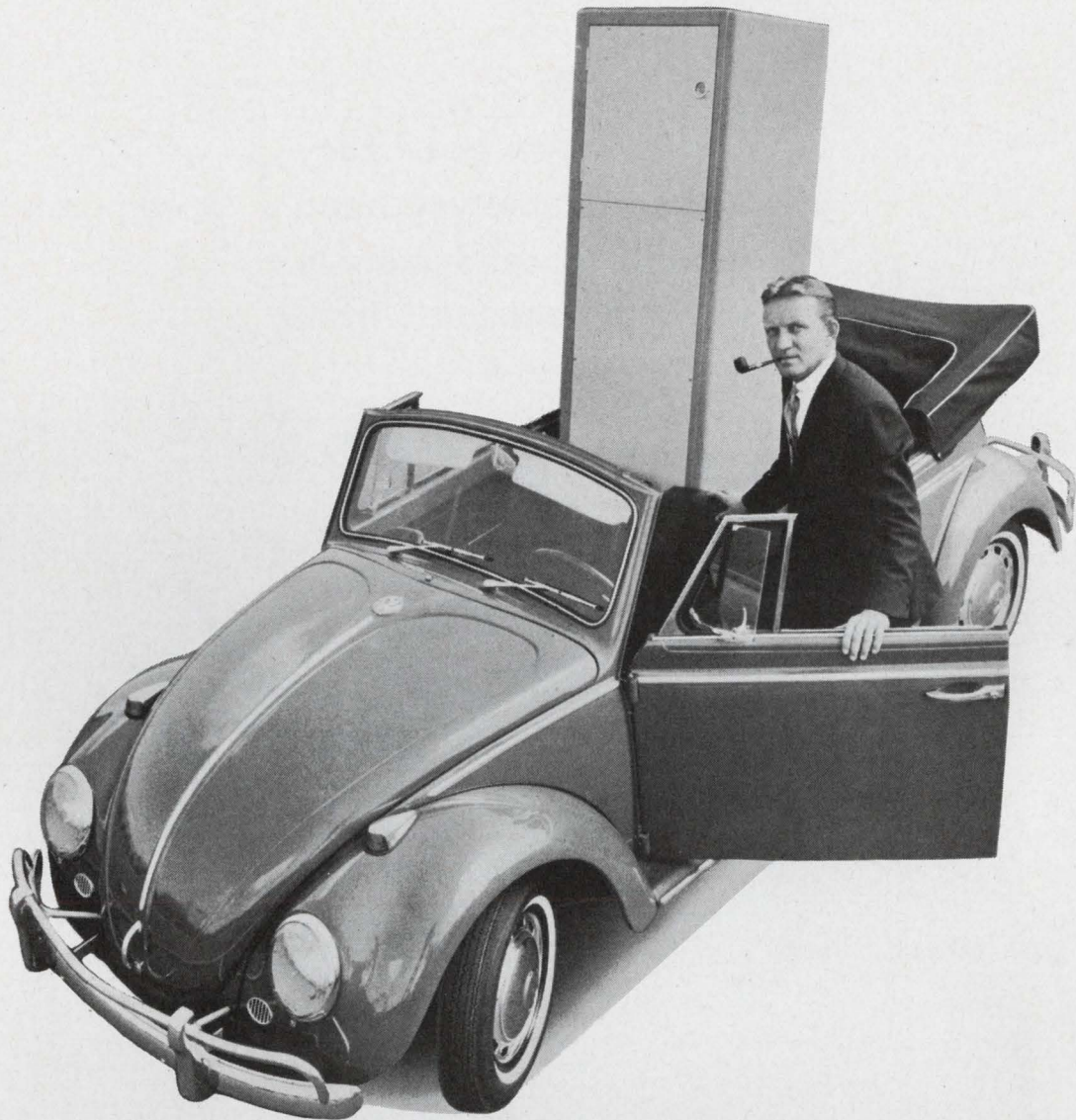

## EMCOR® I—another popular pioneer

EMCOR cabinets started the entire concept of modular enclosure systems, and we've refined them to the point where EMCOR cabinetry is an art... with contemporary, functional design, a tremendous choice of components, careful craftsmanship, and a beautiful choice of colors. You'll appreciate every detail.

And certainly, EMCOR I and the VW have much in common. They're

*EMCOR/distinguished cabinetry*

both pioneers. They're both highly versatile. They both perform like the leaders they are. And of course, they both offer lots of value for little dollars.

As vital as your instrumentation is, you should find the best cabinets for it. When you need a cabinet, or a system of cabinets, call your local EMCOR Sales and Service Engineer. Or write for our EMCOR I catalog.

Albany: 436-9649; Albuquerque: 265-7766; Alexandria: 836-1800; Atlanta: 939-1674; Baltimore: 727-1999; Binghamton: 723-9661; Bridgeport: 368-4582; Buffalo: 632-2727; Chicago: 676-1100; Cleveland: 442-8080; Dallas: 631-7450; Dayton: 298-7573; Del Mar: 454-2191; Denver: 934-5505; Detroit: 357-3700; Fort Lauderdale: 564-8000; Ft. Lee (No. N. J.): 944-1600; Ft. Walton Beach: 243-6424; Houston: 526-2959; Huntsville: 539-6884; Indianapolis: 356-4249; Kansas City: 444-9494; Los Angeles: 938-2073; Minneapolis: 545-4481; Newport News: 245-8272; N.Y.C. area: 695-0082; Orlando: 425-5505; Palo Alto: 968-8304; Philadelphia: 242-0150; Pittsburgh: 884-5515; Phoenix: 273-1673; St. Louis: 647-4350; Seattle (Bellevue): 454-5224; Syracuse: 471-7274; Tulsa: 742-4657; Utica: 732-3775; Valley Forge (So. N. J.): 265-5800; Wilmington, Mass.: 944-3930; Winston-Salem: 725-5384. EMCOR Reg. U.S. Pat. Off.

♦♦♦♦

**Ingersoll Products** 1025 West 120th St., Chicago, Illinois 60643

DIVISION OF BORG-WARNER CORPORATION

**electronic  
equipment**



ON READER-SERVICE CARD CIRCLE 58

**Yes. You can get every  
wire and cable you need  
for a computer system in  
one neat package...from  
Brand-Rex**

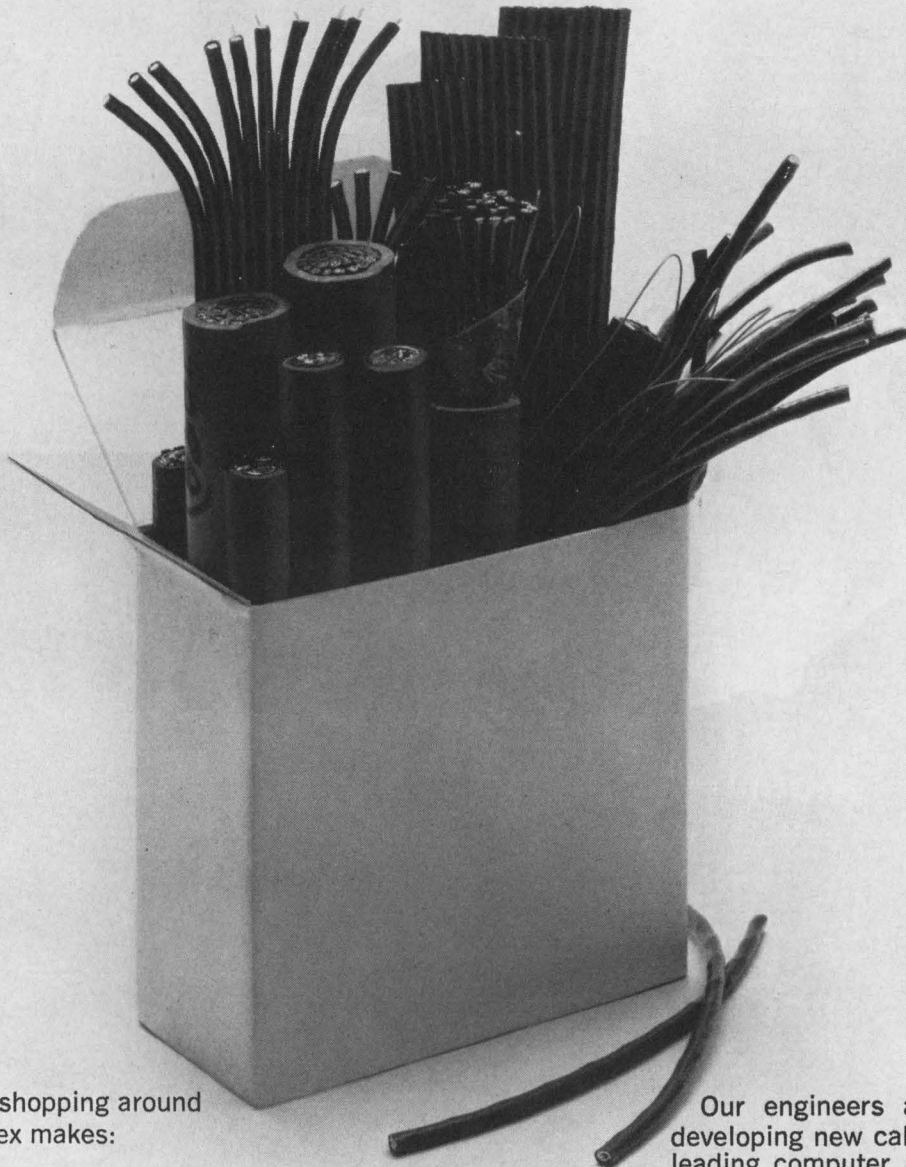

You save a lot of shopping around because Brand-Rex makes:

- **Back-Panel Wires**
- **Hook-Up Wires**
- **Miniature, Air-Spaced Coaxial Cable**
- **Power Supply Wires**
- **Patch Cord Wires**
- **Interconnecting Cables**
- **Communication Cables.**

You can have just about any configuration... single wire, round cable, ribbon cable, custom profiles...and your choice of insulations including Kynar, Polysulfone, Teflon (FEP and TFE), PVC, semi-rigid PVC, PVC/nylon, polyethylene, foamed polyethylene, FEP/nylon, Rulan and Neoprene. Matched colors if you want.

Our engineers are constantly developing new cable designs for leading computer manufacturers. So if existing Brand-Rex products don't meet your needs, we'll come up with new designs that will.

Hooking-up a computer system? Get all the wire and cable from one good source. Ask Brand-Rex.

AMERICAN ENKA CORPORATION  
**BRAND-REX DIVISION**  
WILLIMANTIC, CONNECTICUT 06226  
PHONE 203 423-7771



# Products

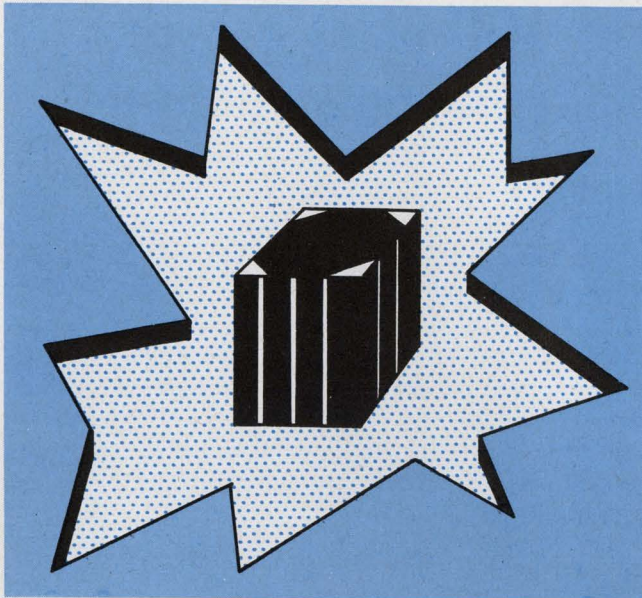

**Tiny cubes pack a 100-watt wallop.** Five different power circuits are offered. Page 130

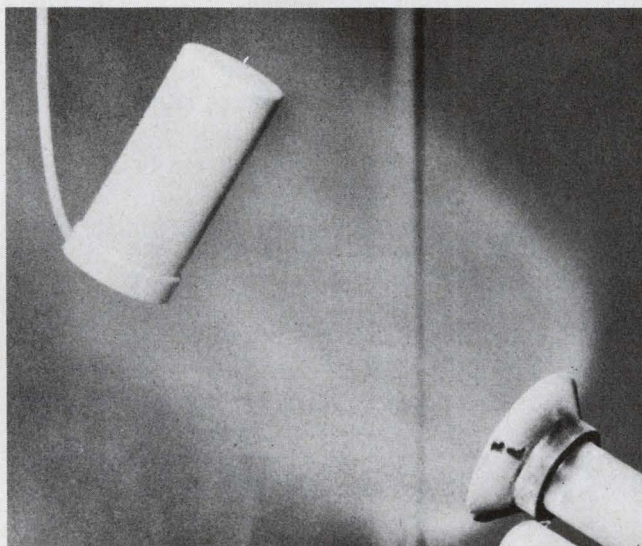

**Powdered epoxy electrostatically applied** to cold or heated parts, then cured. Page 170



**Transistors automatically tested** from dc to rf, classified and then sorted. Page 176

## Also in this section:

**Electronic switching** gives ac-to-dc converter wide dynamic range. Page 150

**Integrated circuit testers** offer premium performance at lower cost. Page 174

**Second-generation IC op-amp** eases circuit design, ups performance. Page 180

**Design Aids**, Page 194. . . . **Application Notes**, Page 196. . . . **New Literature**, Page 198

## Power circuits deliver 30- to 100-watt outputs in half-cubic-inch, three-quarter-ounce package

Powercube Corp., 214 Calvary St., Waltham, Mass. 02154. Phone: (617) 924-1758. P&A: \$190 to \$275 (1 to 9); 2 to 3 wks.

A new packaging concept puts power-handling capabilities many times that of conventional circuits into a cube a fraction of the size and weight of existing cards, modules, cans and sub-assemblies. In the same half-cubic-inch, three-quarter-ounce package, Powercube Corp., manufacturer of the devices, offers five different circuits capable of delivering from 30 to 100 watts. The units have integral heat-sinking, termination, interconnection and environmental protection. Modules available are:

- Dc-to-ac inverters delivering 30 W with voltages to 500 Vac.
- Dc-to-dc regulators with closely regulated 4-to-110-Vdc outputs.
- Ac-to-dc converters with outputs up to 500 Vdc and to 6 A.
- Ac-to-dc regulated converters with outputs to 110 Vdc, 2 A.

- Dc-to-dc pulse regulators to regulate wide voltage ranges at 90% efficiency.

Figure 1 is a cutaway view illustrating the "terminator-dissipator-isolator" concept.

The heat-generating components—rectifiers, Zener diodes and resistors—all terminate in "terminator-dissipators." The walls of the fully brazed package, which are the terminator-dissipators, also act as:

- Electrical terminations for the active elements.
- Electrical interconnections.
- A low-thermal-resistance path for heat dissipation.

The "isolators" provide the mechanical means for joining terminator-dissipators to each other and to the base.

To make maximum use of the package's heat-dissipating capabilities, it is necessary to couple all terminator-dissipators thermally. Electrical isolation, however, must still be maintained for each separate terminator-dissipator since they are at different potentials. These mechanical, elec-

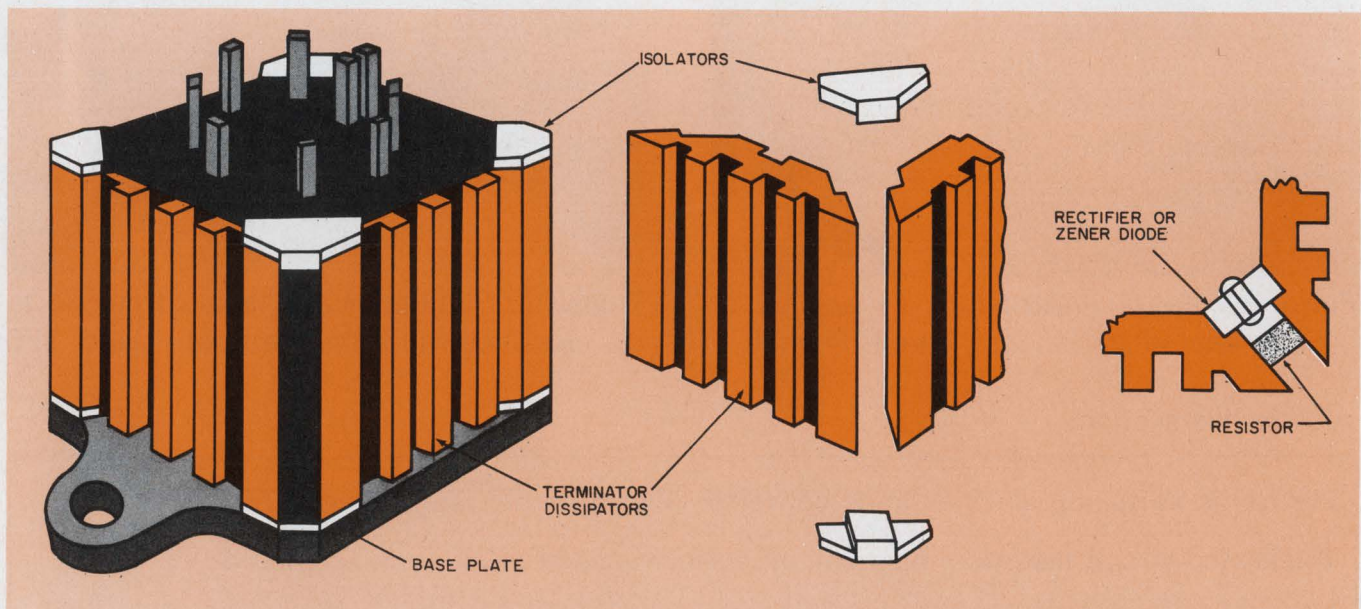

1. The module that packs a 100-watt punch: the terminator-dissipators, which are the physical walls of the package, also function as interconnections, heat dissipators, and terminations for the active elements. They are ther-

mally coupled, yet electrically isolated from each other and from the base, by the beryllia isolators. The base-plate, in turn, bridges the thermal path between each terminator-dissipator.

# Now—the broadest line of convection-cooled, all silicon, .015% regulated power supplies

For test equipment and lab use 0-10,-20,-40,-60,-120 VDC, from 0-.5 amp to 0-66 amps

## Features and Data

- Rack or bench use
- Full five year guarantee on materials and labor
- Convection Cooled
- Remote Programming
- Regulation—.015% or 1 MV (Line or Load)
- Temp. Coef. .015%/°C
- Completely Protected—Short circuit proof—Continuously adjustable Automatic current limiting
- Remote Sensing
- Constant I./Constant V. by automatic crossover
- Series/Parallel Operation
- No Voltage Spikes or Overshoot on "turn on", "turn off" or power failure
- Ripple—LK models—500  $\mu$ V RMS  
LH models—250  $\mu$ V RMS, 1 MV P-P
- Meet MIL Environment Specs

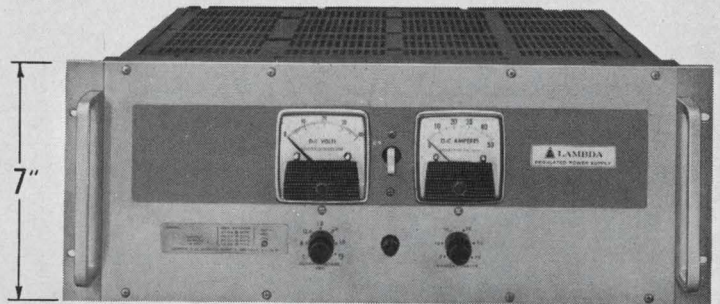

Full Rack 7" LK Series

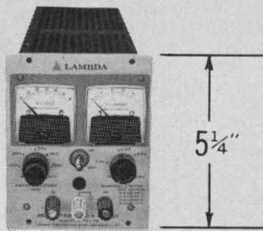

1/4 Rack LH Series

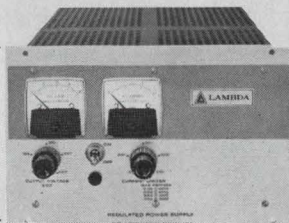

1/2 Rack LK Series-LH Series

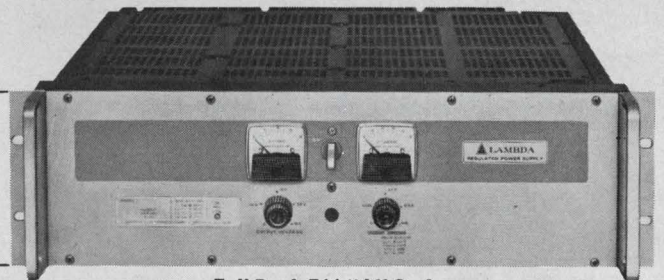

Full Rack 5 1/4" LK Series

### 3 Full-rack Models — Size 7" x 19" x 18 1/2"

Model <sup>2</sup>	Voltage Range	CURRENT RANGE AT AMBIENT OF: <sup>1</sup>				Price <sup>2</sup>
		40°C	50°C	60°C	71°C	
LK 360 FM	0-20VDC	0-66A	0-59A	0-50A	0-40A	\$995
LK 361 FM	0-36VDC	0-48A	0-43A	0-36A	0-30A	950
LK 362 FM	0-60VDC	0-25A	0-24A	0-22A	0-19A	995

### 11 Half-rack Models — Size 5 1/8" x 8 3/8" x 15 1/2"

Model <sup>2</sup>	Voltage Range	CURRENT RANGE AT AMBIENT OF: <sup>1</sup>				Price <sup>2</sup>
		40°C	50°C	60°C	71°C	
LK 340	0-20VDC	0- 8.0A	0- 7.0A	0- 6.1A	0-4.9A	\$330
LK 341	0-20VDC	0-13.5A	0-11.0A	0-10.0A	0-7.7A	385
LK 342	0-36VDC	0- 5.2A	0- 5.0A	0- 4.5A	0-3.7A	335
LK 343	0-36VDC	0- 9.0A	0- 8.5A	0- 7.6A	0-6.1A	395
LK 344	0-60VDC	0- 4.0A	0- 3.5A	0- 3.0A	0-2.5A	340
LK 345	0-60VDC	0- 6.0A	0- 5.2A	0- 4.5A	0-4.0A	395

### 3 Full-rack Models — Size 5 1/4" x 19" x 16 1/2"

Model <sup>2</sup>	Voltage Range	CURRENT RANGE AT AMBIENT OF: <sup>1</sup>				Price <sup>2</sup>
		40°C	50°C	60°C	71°C	
LK 350	0-20VDC	0-35A	0-31A	0-26A	0-20A	\$675
LK 351	0-36VDC	0-25A	0-23A	0-20A	0-15A	640
LK 352	0-60VDC	0-15A	0-14A	0-12.5A	0-10A	650

Model <sup>2</sup>	Voltage Range	CURRENT RANGE AT AMBIENT OF: <sup>1</sup>				Price <sup>2</sup>
		30°C	50°C	60°C	71°C	
LH 119	0-10VDC	0- 9.0A	0- 8.0A	0- 6.9A	0-5.8A	\$289
LH 122	0-20VDC	0- 5.7A	0- 4.7A	0- 4.0A	0-3.3A	260
LH 125	0-40VDC	0- 3.0A	0- 2.7A	0- 2.3A	0-1.9A	269
LH 128	0-60VDC	0- 2.4A	0- 2.1A	0- 1.8A	0-1.5A	315
LH 131	0-120VDC	0- 1.2A	0- 0.9A	0- 0.8A	0-0.6A	320

### 5 Quarter-rack Models — Size 5 3/16" x 4 3/16" x 15 1/2"

Model <sup>2</sup>	Voltage Range	CURRENT RANGE AT AMBIENT OF: <sup>1</sup>				Price <sup>2</sup>
		30°C	50°C	60°C	71°C	
LH 118	0-10VDC	0-4.0A	0-3.5A	0-2.9A	0-2.3A	\$175
LH 121	0-20VDC	0-2.4A	0-2.2A	0-1.8A	0-1.5A	159
LH 124	0-40VDC	0-1.3A	0-1.1A	0-0.9A	0-0.7A	154
LH 127	0-60VDC	0-0.9A	0-0.7A	0-0.6A	0-0.5A	184
LH 130	0-120VDC	0-0.50A	0-0.40A	0-0.35A	0-0.25A	225

- <sup>1</sup> Current rating applies over entire voltage range.
- <sup>2</sup> Prices are for non-metered models (except for models LK360FM thru LK362FM which are not available without meters). For metered models, add suffix (FM) and add \$25 to price of LH models; add \$30 to price of LK models.
- <sup>3</sup> Overvoltage Protection: add suffix (OV) to model number and add \$60 to the price of LH models; add \$70 to price of half-rack LK models; add \$90 to price of 5 1/4" full-rack LK models; add \$120 to price of 7" full-rack LK models.
- <sup>4</sup> Chassis Slides for full rack models: Add suffix (CS) to model number and add \$60 to the price.



**LAMBDA ELECTRONICS CORP.**

515 BROAD HOLLOW ROAD • MELVILLE, L.I., NEW YORK 11746 • (516) 694-4200 A  SUBSIDIARY

# Make us put our reputation on the line.

Call up 3 relay manufacturers: Line Electric and 2 others. Ask for a quote on 1000 MK's and a sample to be sent to you. After you've made the three calls, check these simple questions.

1. Which company representative sounded the most knowledgeable?  
 Line Electric.  Company A.  Company B.
2. Which company gave you the best price?  
 Line Electric.  Company A.  Company B.
3. Which company representative was the most courteous?  
 Line Electric.  Company A.  Company B.
4. Which company said delivery would be made in six weeks?  
 Line Electric.  Company A.  Company B.
5. Which company said there was no charge for the sample, and that it would be in your hands first thing in the morning, with a letter confirming the price?  
 Line Electric.  Company A.  Company B.

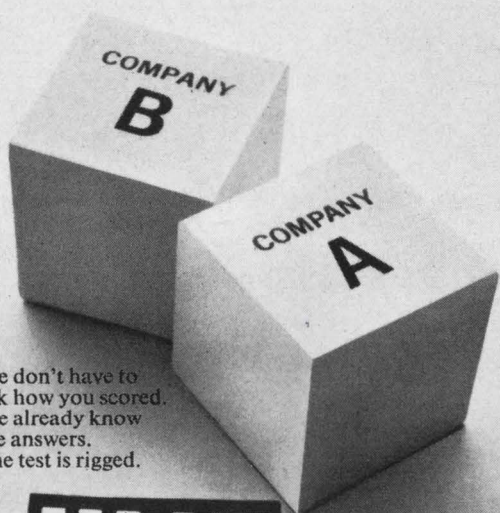

We don't have to ask how you scored. We already know the answers. The test is rigged.

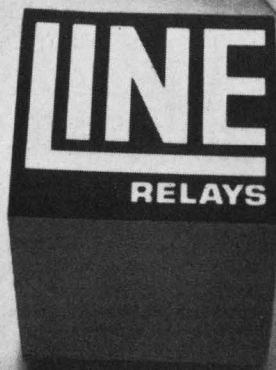

The Line Electric Company. Manufacturers of Relays and the best service in the business. Subsidiary of General Precision Equipment Corporation. Send for 64 page catalog:

305 U.S. Highway 287, Parsippany, N. J. 07054

ON READER-SERVICE CARD CIRCLE 61

## COVER FEATURE

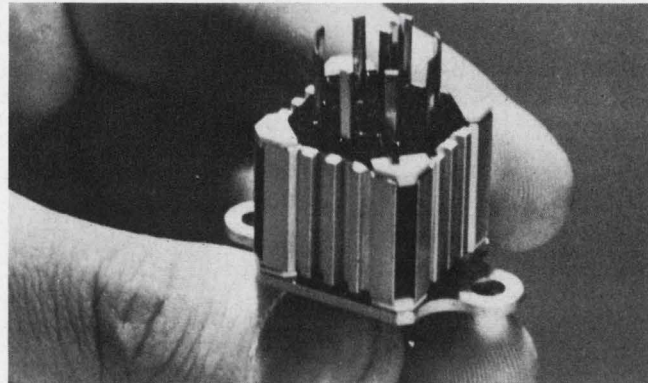

2. Power circuits the size of components. The fully brazed, void-free package measures 0.5 cubic inch, weighs 0.75 ounce.

trical, and thermal functions are all performed by the isolators. They are made of beryllia, an excellent electrical insulator with a high thermal conductivity. They are metallized to permit soldering or brazing, if necessary. The thermal and mechanical connection of the terminator-dissipators to the base through the isolators provides a thermally connected, yet electrically isolated base-plate.

The base-plate itself serves three functions:

- It bridges the thermal path between terminator-dissipators, providing for heat passage to all points of the package.
- It forms a mechanical means for mounting the device to an external chassis or heat sink.
- It provides a thermal path for heat transfer to an external heat sink. This allows *full* ratings by conduction alone; extremely desirable in space environments.

The design approach parallels a road recently taken by small-signal monolithic ICs (see "Integrated circuits shed their wires," ED 4, Feb. 15, 1967, p. 17). Just as Bell Laboratories' "beam leads" serve as connectors and heat dissipators, Powercube's "terminator-dissipator-isolators" do the same and more. As a single monolithic assembly performs functions of termination, interconnection, thermal dissipation, environmental protection and circuit operation, so do the new modules. Every material used in the package serves more than one function.

All in all, this technique avoids all of the size, weight and thermal pitfalls which have kept large power circuits bulky. Prepackaged components having active elements much smaller than their finished volume are not used. Separate heat sinks and isolating hardware are not needed. Encapsulation is not used for environmental protection. Terminals serving only as terminals are unnecessary.

CIRCLE NO. 251

ON READER-SERVICE CARD CIRCLE 62 >



## You won't find the new Alfred 10-watt amplifier here.

**Lowest price 10-watt amplifiers:** Alfred's 1 to 11 GHz TWT amplifiers with 30 db gain at 10 watts are designed for continuous performance under rigorous conditions. To protect the PPM-focused TWT, each unit includes Alfred's unique "total protection" circuitry. You can choose from 4 basic models:

### Frequency Range

Model	(GHz)	Price
5010	1-2	\$3,600
5020	2-4	3,400
5030	4-8	3,700
5040	7-11*	3,850

\*Model 5040 delivers 2 watts at 12.4 GHz.

**1-watt amplifiers for every application:** The 1 to 12.4 GHz amplifiers, capable of delivering 1 watt at 30 db gain, are priced within your budget. Only Alfred amplifiers provide 50 db gain and amplitude modulation range. Each unit contains "total protection" circuits; exceptional gain and phase stability are built in.

### Frequency Range

Model	(GHz)	Price
560A	1-2	\$2,150
561A	2-4	2,150
562A	4-8	2,550
563A	7-12.4	2,550

**For more information:** To arrange a demonstration and get complete details, call a full service Alfred Sales Engineer (see EEM), or, if you wish, write to 3176 Porter Drive, Palo Alto, California 94304. Phone (415) 326-6496.

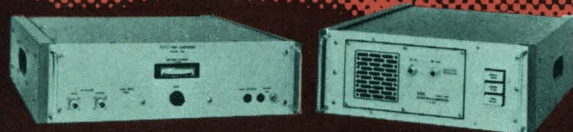

# ALFRED ELECTRONICS

Project responsibility opportunities are available for qualified engineers on Alfred Electronics' growing technical staff. An equal opportunity employer.

**But here —  
or in the laboratory  
or on the production  
line where the work's  
hard — you will!**

### Alkaline 1.5-V battery has 20-year shelf life



Mallory Battery Co., S. Broadway, Tarrytown, N. Y. Phone: (914) 591-7000.

A new battery lasts indefinitely—0 years or more—until activated. It is a 1.5-volt alkaline battery easily activated by turning the top terminal cap which releases the liquid electrolyte contained in the battery's structure. Until activated, the battery remains inert and in stand-by condition indefinitely. The battery is manufactured in the D size.

CIRCLE NO. 253

### Dc servomotors hit 1200 rpm in 1 ms

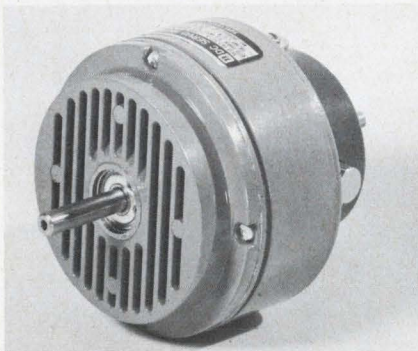

Honeywell, Inc., Precision Meter Div., Grenier Field, Manchester, N. H. Phone: (603) 625-6971.

Dc servomotors can reach 1200 rpm in 1 ms from dead stop. Acceleration of the 4.5-lb motor is 278,000 radians/s<sup>2</sup> initial at 2 V. Additional advantages for the 4-inch diameter motor are reported to be the 4200-rpm rated speed and 5.5-A rated current. Torque is 30 ounce-inches. The motor design eliminates all moving iron, leaving a moving-coil shell-type rotor configuration.

CIRCLE NO. 254

### Cycle timers control over 100 circuits

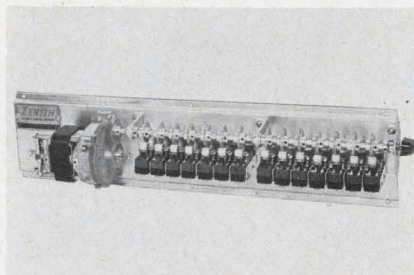

Zenith Controls, Inc., 152 W. Walton St., Chicago. Phone: (312) 642-3322.

Multicircuit cycle timers which control 2 to 100 or more circuits operate through adjustable or specially coded cams. Each contact is an spdt snap-action switch rated 15 A, 250 V non-inductive, 350 W tungsten lamp load. Contacts rated at 1000 watts and models offering individually mounted switches are available.

CIRCLE NO. 255

### Resistor networks accurate to 0.0005%

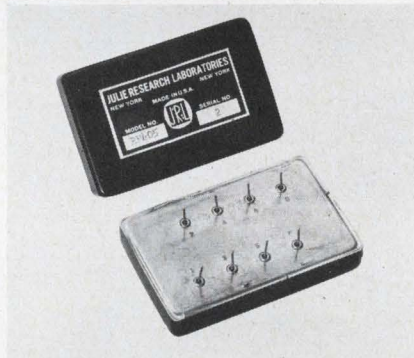

Julie Research Labs., Inc., 211 W. 61 St., New York. Phone: (212) 245-2727. P&A: \$20 to \$200; 1 to 3 wks.

Resistor networks for PC board plug-in cover a range from 10  $\Omega$  to 1 M $\Omega$  and offer standards lab accuracies. The networks are available in all accuracies ranging from 0.0005% to 0.1% absolute and  $\pm 0.0002\%$  to  $\pm 0.1\%$  ratio. Stability is  $\pm 0.0015\%$  per year absolute and  $\pm 0.0002\%$  ratio. The oil-filled units are enclosed in hermetically sealed metal cases which provide electrostatic shielding from environmental stress and change. Temperature coefficients from  $\pm 1$  to  $\pm 5$  ppm/ $^{\circ}$ C are standard.

CIRCLE NO. 256

### Four-quadrant multiplier spans dc to 10 MHz



Optical Electronics, Inc., P. O. Box 11140, Tucson, Ariz. Phone: (602) 624-3605. P&A: \$484; stock.

Four-quadrant analog multiplication from dc to 10 MHz with a 1% full-scale linearity is achieved by this module. Applications include modulation, wideband video and pulse variable gain amplification, high-speed analog computation and data correlation. Features include 10-M $\Omega$  input impedance, 100- $\Omega$  output impedance and 40-dB useful dynamic range.

CIRCLE NO. 257

### Capacitive transducer measures 3 psi



Lion Research Corp., 60 Bridge St., Newton, Mass. Phone: (617) 864-9313. P&A: \$700 and \$800; 2 wks.

Pressure transducers for laboratory and space applications are available for the pressure range of 0.05 to 3 psi full scale at an accuracy of better than  $\pm 1\%$ . Series 200 is a stretched-diaphragm hysteresis-free design with capacitance sensing of diaphragm position. Power requirement is 1 W ( $24 \pm 4$  Vac) and signal output is 0 to 5 Vdc.

CIRCLE NO. 258



# IN TWO CONVENIENT SIZES

*Small...*

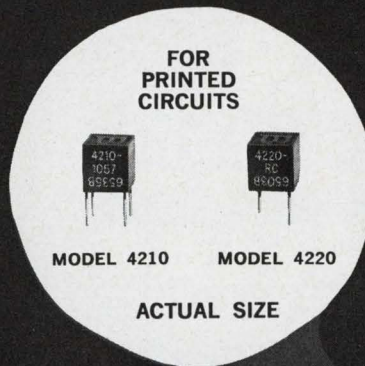

*& Now*

*Smaller  
Than  
Small...*

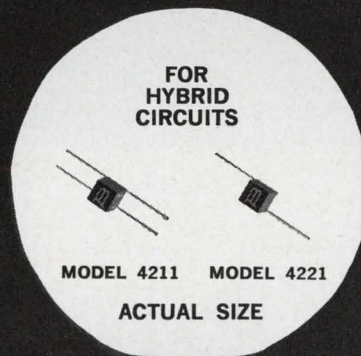

## MICROTRANSFORMERS AND MICROINDUCTORS

*from Bourns*

Introducing the new smaller than small models 4211 microtransformer and the 4221 microinductor. The units are packaged in a  $\frac{1}{8}$ " cube, sealed against cyclic humidity per MIL-STD-202B and designed specifically for use in hybrid circuits.

This ultimate performance to size ratio in microtransformers and microinductors is now available from Bourns in addition to the proven small  $\frac{1}{4}$ " cube models 4210 microtransformer and 4220 microinductor.

Both sizes exceed the environmental requirements of MIL-T-27B, Grade 5.

For those applications beyond the scope of the standard unit, design flexibility permits taps, wide turns ratio range, various core materials, split coils, and bifilar windings. Application engineering service is available for quick response on such special prototype units.

For additional information and detailed specifications on Bourns microtransformers and microinductors, contact your nearest Bourns sales office or representative, or write the factory direct.

### SPECIFICATIONS

Size  
Maximum operating temperature  
Frequency response  
Maximum distortion  
Power rating  
Insertion loss  
Primary impedance range  
Secondary impedance range  
Turns ratios

### MODEL 4210 MICROTRANSFORMER

$\frac{1}{4}$  x  $\frac{1}{4}$  x  $\frac{1}{4}$   
130°C  
±2 db, 400 to 250kHz  
±5% at rated power  
50MW at 1 kHz  
±3 db max.  
100Ω to 100KΩ  
3.2Ω to 10KΩ  
to 15:1

### MODEL 4220 MICROINDUCTOR

$\frac{1}{8}$  x  $\frac{1}{8}$  x  $\frac{1}{8}$   
105°C  
±2 db, 2K to 500kHz  
±5% at rated power  
25MW at 10kHz  
±3 db max.  
10Ω to 10KΩ  
10Ω to 10KΩ  
to 10:1

### SPECIFICATIONS

Size  
Maximum operating temperature  
Inductive range

### MODEL 4211 TRANSFORMER

$\frac{1}{4}$  x  $\frac{1}{4}$  x  $\frac{1}{4}$   
130°C  
.08 to 66 hy

### MODEL 4221 MICROINDUCTOR

$\frac{1}{8}$  x  $\frac{1}{8}$  x  $\frac{1}{8}$   
105°C  
0.1 to 3.5 hy



BOURNS, INC., TRIMPOT DIVISION • 1200 COLUMBIA AVE., RIVERSIDE, CALIF.  
TELEPHONE 714 684-1700 • TWX: 910 332-1252 • CABLE: BOURNSINC.

CHOPPERS • RELAYS • TRANSFORMERS • SWITCHES

# JAMES

SOLVES THE PROBLEM OF SWITCHING LOW-LEVEL SIGNALS

## Micro-Scan RELAY

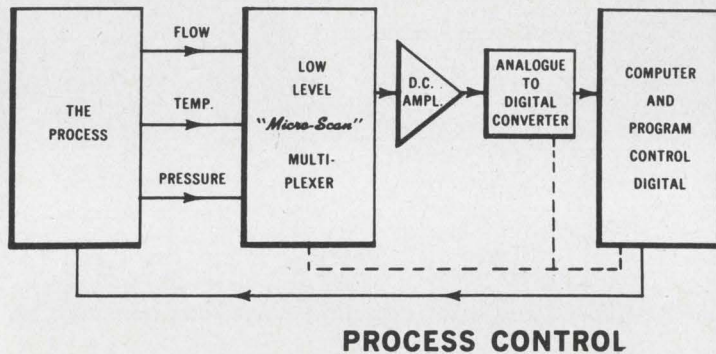
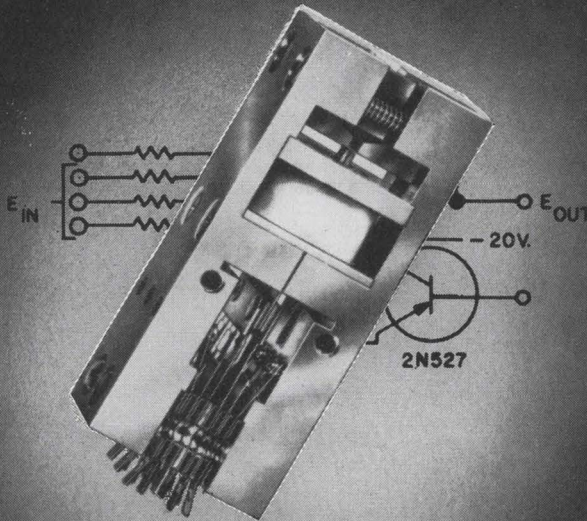

### LOW THERMAL CIRCUITS

Less than .5 microvolt offset for remote transducer switching.

### HIGH SHIELDING

Magnetic and electrostatic isolation of switching circuit—up to 150 db.

### HIGH OPERATING SPEEDS

As low as 650 microseconds pull-in and 750 microseconds dropout.

James Micro-Scan Relays are the specialized solution for multiplexing, direct digital control, and data sampling of measurements. Use it as a calibration or sampling switch in scanning devices; or as an integrator switch in analog acquisition equipment. The first choice where high operating speed, shielding, repeatability, and reliability are critical.

Write for full technical details.

# JAMES® ELECTRONICS INC.

4042 North Rockwell  
Phone 312-463-6500

• TWX — 312-222-0745

Chicago, Illinois 60618  
• FAX — JML

ON READER-SERVICE CARD CIRCLE 64

## COMPONENTS

### Round trimmer pot can mount vertically

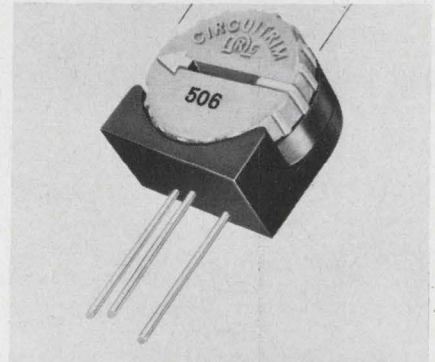

IRC, Inc., 401 N. Broad St., Philadelphia. Phone: (215) 922-8900. P&A: \$1.70 (500 lots); stock to 30 days.

A vertical mounting fixture transforms IRC's 0.5-inch round wire-wound trimmer into a front or side-adjust unit. The resistance element of the single-turn unit offers high resolution over a full 310°. Weldable and solderable PC pins on a 0.1-inch grid are standard. Rated at 0.5 watt at 25°C, the units are available from 10 Ω to 50 kΩ.

CIRCLE NO. 266

### Wideband transformers cover video frequencies



North Hills Electronics, Inc., Alexander Place, Glen Cove, N. Y. Phone: (516) 671-5700. P&A: \$32.50 (100 lots); stock.

Wideband video frequency transformers for operation from 1 to 20 kHz are available in various impedance ratios. Two groups have primaries unbalanced with the first series having the secondary unbalanced. The second series have the secondary balanced and center tapped. The vswr over the band is generally less than 1.5.

CIRCLE NO. 267

# 10 Amp *in* ISOLATED

# Collector Packages

from

# Soliton

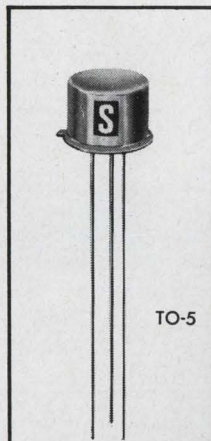

TO-5

10 W @ 100°C



TO-111

(7/16" hex)

30 W @ 100°C

Soliton's popular 10-amp NPN silicon power transistors are now available in Isolated packages. Designated the SDT 7470 and SDT 7B00 families, these devices offer high performance and reliability, plus small size! The TO-111 is the smallest stud package produced with 10-amp capability. All of the units feature low leakage currents, a uniform gain over wide current ranges and low saturation voltages. Typical characteristic curves are similar to the widely accepted 2N2811-14 Series. These isolated packaged devices may be utilized in many areas where the MHT 7400 Series and MHT 7000 Series are in use.

Type Number TO-111	Type Number TO-5	DESIGN LIMITS			PERFORMANCE SPECIFICATIONS					
		$V_{(BR)CBO}$	$V_{CEO(SUS)}$	$V_{(BR)EBO}$	$h_{FE}$		$V_{CE(sat)}$	$V_{BE(sat)}$	$I_{CBO}$	$f_T$
		Volts	Volts	Volts	$I_C = 5A$	$V_{CE} = 5V$	Volts	Volts	$\mu A$	$MH_z$
		$I_C = 10 \mu A$	$I_C = 0.1A$	$I_E = 10 \mu A$			$I_C = 5A$	$I_B = 0.5A$	$V_{CB} = 60V$	Typ.
SDT 7B01	SDT 7471	80	60	5	40	120	0.6	1.5	1.0	50
SDT 7B02	SDT 7472	100	80	5	40	120	0.6	1.5	1.0	50
SDT 7B03	SDT 7473	120	100	5	40	120	0.6	1.5	1.0	50
SDT 7B04	SDT 7474	140	120	5	40	120	0.6	1.5	1.0	50
SDT 7B05	SDT 7475	80	60	5	20	—	0.6	1.5	1.0	50
SDT 7B06	SDT 7476	100	80	5	20	—	0.6	1.5	1.0	50
SDT 7B07	SDT 7477	120	100	5	20	—	0.6	1.5	1.0	50
SDT 7B08	SDT 7478	140	120	5	20	—	0.6	1.5	1.0	50

DIAL 1-800-327-3243 FOR A NO CHARGE TELEPHONE CALL AND FURTHER INFORMATION

## Soliton DEVICES, INC.

1177 BLUE HERON BLVD. / RIVIERA BEACH, FLORIDA / (305) 848-4311 / TWX: (510) 952-6676

Leader in Germanium and Silicon Transistors, Cryogenic Thermometers, High Voltage Rectifiers, Hot Carrier Diodes, Temperature Compensated Zeners, Voltage Variable Capacitors, Random/White Noise Components, Microelectronic Circuits, and Power-Sink Interconnection Systems.

ON READER-SERVICE CARD CIRCLE 65

Eliminate Power Supply  
Obsolescence...Simplify  
Stocking Problems...Here are

## More Ways to Get Wide Range DC Power from ERA

SILICON  
71°C  
FREE AIR

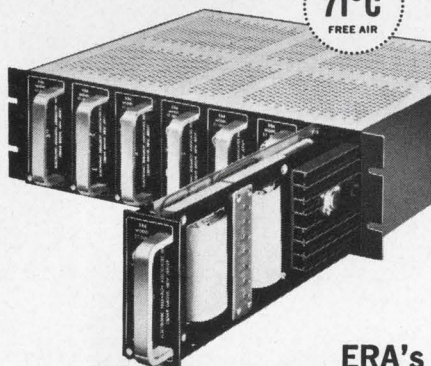

### ERA's New Wide Range SLIM-TRAN® DC Power Module for 19" Rack Mount or Multiple Module Assembly

New Slim-Tran Power Modules AC/DC power supplies provide DC output over a wide, adjustable voltage range. Practical plug-in design permits use of as many as 7 units in a standard relay rack assembly or grouped in a multiple module configuration. A single model can serve many voltage requirements.

#### STANDARD MODELS

Output* Voltage DC	Current* 71°C	Model	Price
1-63	0-1 amp	ST1000	\$155.00
1-33 Dual	0-1 amp Dual	ST1000-2	\$195.00
1-33	0-2 amps	ST2000	\$175.00

\*For higher current or voltage ratings two or more units may be connected in series or parallel.

#### SPECIFICATIONS

Ripple: Less than 800 microvolts RMS or 0.005% whichever is greater  
Line Regulation: Less than 0.01% or 5 mV for full input change  
Load Regulation: Less than 0.05% or 8 mV for 0-100% load change  
Transient Response: Less than 50 microseconds  
Operating Temperature: -20°C to +71°C free air, full ratings  
Temperature Coefficient: Less than 0.01% or 3 mV per degree C

Write for Catalog # 149



### ELECTRONIC RESEARCH ASSOCIATES, INC.

67 Sand Park Road, Cedar Grove, N. J. 07009  
Dept. ED-7 (201) 239-3000

SUBSIDIARIES: ERA Electric Co. ■ ERA Acoustics Corp.  
■ ERA Dynamics Corp. ■ ERA Pacific, Inc.

ON READER-SERVICE CARD CIRCLE 66

## COMPONENTS

### Hybrid IC op-amps up gain, thermal specs

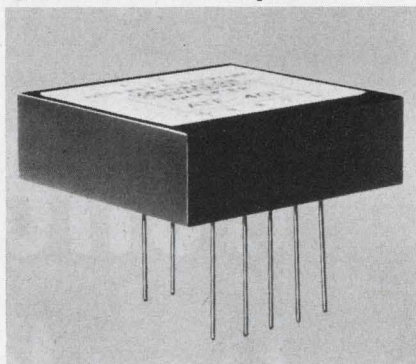

Amperex Electronic Corp., Semiconductor Div., Slatersville, R. I. Phone: (401) 762-9000. Price: \$17, \$19, \$29 (100 lots).

Hybrid thin-film op-amps are designed with low-noise input stages, internal frequency compensation and good thermal characteristics. The ATF401 has open-loop gain of 100,000, temperature range of -25° to +85°C and noise voltage of 5 μV. The high-gain 402 has open-loop gain of 200,000 and gain-bandwidth product of 2 MHz. Maximum current drift is 1 nA/°C from -25° to +85°C. Initial offset and noise voltage are 5 μV. The 403 is rated with 2 nA/°C current drift from -55° to +125°C. Open-loop gain is 100,000, initial offset is 7.5 mV, gain-bandwidth product is 2 MHz and noise voltage is 5 μV.

CIRCLE NO. 268

### Tiny connectors operable at 500°F

Statham Instruments, Inc., 12401 W. Olympic Blvd., Los Angeles. Phone: (213) 272-0371.

A high-temperature electrical connector weighs 2 grams and is reportedly the smallest hermetically sealed connector available in 1-, 2-, 3- and 4-contact configurations. Body diameter is 0.29 inch with total mated height of less than 0.75 inch. The unit operates in ambients ranging from -100° to +500°F. It can withstand heavy thermal shock from the upper to lower extremes without damage or degradation in performance. Body and pins are made of stainless steel, and each contact pin is individually insulated.

CIRCLE NO. 269

### FET switches handle microvolts

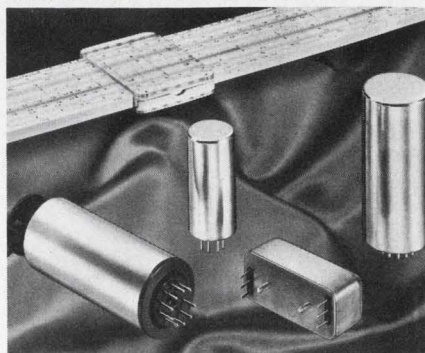

James Electronics, Inc., 4050 N. Rockwell St., Chicago. Phone: (312) 463-6500. P&A: \$27.43 to \$58.41; 6 to 8 wks.

Four double-throw, make-before-break FET switching systems are designed for microvolt-signal service as series shunt instrument choppers, half-wave modems, sampling switches or full-wave modulators. Each micromodulator incorporates a pair of balanced silicon FETs and a compensated magnetic drive system. The driving system operates from a 6.3-V sine or square wave source over a frequency range of 50 to 1000 Hz. The drive system isolates the units from normal transient noise signals and leakage present and permits the units to operate efficiently in the microvolt rather than the millivolt signal range.

CIRCLE NO. 270

### Dc calibration card remotely programmable

SRC, 2311 Pontius Ave., Los Angeles. Phone: (213) 477-4573. P&A: \$290; 4 wks.

A 6-level remotely programmable dc voltage calibration card has application in the testing of amplifiers, VCOs, A-D converters and DVMs or for calibration and signal simulation in data acquisition, telemetry or automatic checkout systems. The dc output voltage may be programmed to levels between 0 and 40 V by applying 24 Vdc to the rear connector. The first 5 levels are pre-selected resistors, and the voltage may be set by actuating the appropriate relay. The sixth level can be remotely programmed.

CIRCLE NO. 271

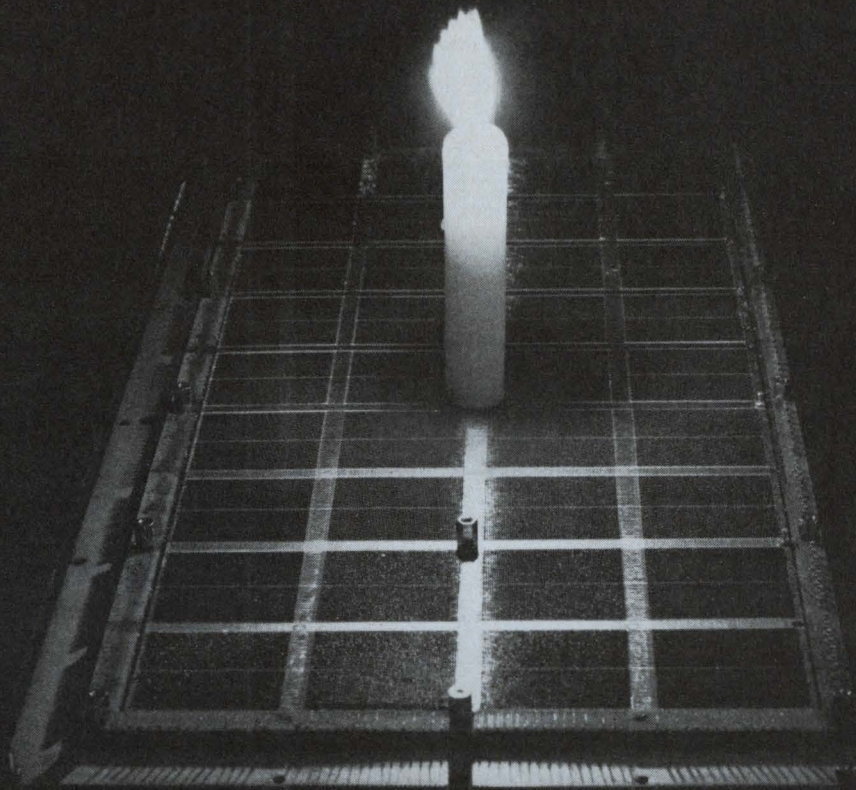

**in a memory system somewhere, one of our  
2<sup>1</sup>/<sub>2</sub> D stacks is celebrating its first birthday**

After we shipped that one, we started delivering stacks at the rate of nearly one a day. Several hundred to date. Capacities ranged from 4,096 to 16,384 words of 8 to 25 bits. Cycle times went from 900 to 650 nanoseconds. Some were off-the-shelf designs, some slightly modified.

All had wide operating margins and low system noise.

But one of the most important specs was reliability. For example, internal stack connections were reduced by 80%. Drive lines were shortened, and the inhibit winding was eliminated. The result was unsurpassed stack

dependability and increased operational speed.

With a brand new design, that first birthday is very very significant. Infant mortality has plagued many an engineer. Now we're confident any one of our stacks could be around for a golden anniversary.

There's a new four-page brochure waiting to be requested. It has all the specs. Write for Litpak 2C.

**EM electronic memories**

12621 Chadron Ave., Hawthorne, Calif. 90250, (213) 772-5201

# SWITCHING PROBLEMS? Solve Them With These HSI Sealed Switches

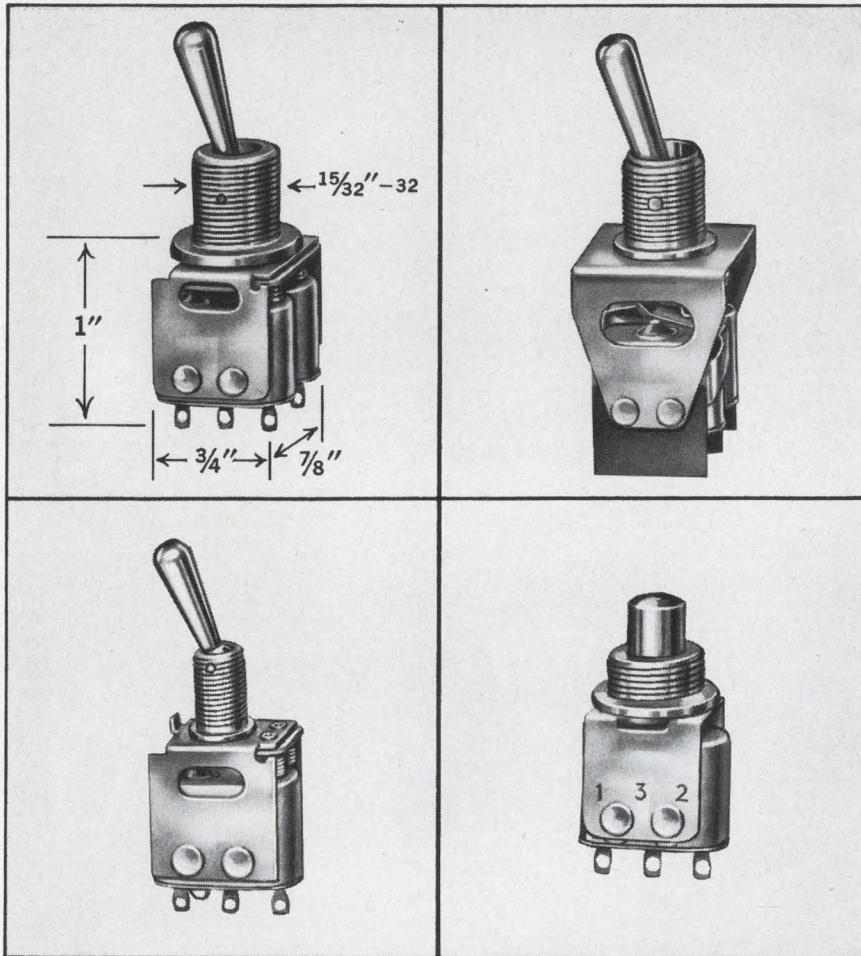

## Premium Performance in Sub-miniature Switches

6100 series toggle and push-button switches are rugged compact assemblies designed for use wherever stringent environment conditions must be met — such as aircraft, space, industrial, shipboard and armored vehicles. The precision snap-action switches in these assemblies are hermetically sealed. They meet the requirements of MIL-S-8805 Enclosure 4 and perform reliably with consistently low contact resistance under the adverse conditions that cause unsealed switches to fail.

Wherever reliable switching is a problem, solve it by specifying "HSI". Basic hermetically sealed switches are single pole double throw rated 5 Amp. resistive, 3 Amp. inductive, 28V D.C. For single and multiple circuits. Extremely compact. Complete data in Bulletin 61T-1 . . . send for your copy, today.



**HAYDON SWITCH & INSTRUMENT, INC.**

Where Optimum Performance is Standard

1500 Meriden Road, Waterbury, Conn. 06720/Area Code (203) 756-7441

ON READER-SERVICE CARD CIRCLE 126

## COMPONENTS

**Tiny wirewounds  
priced under \$1**

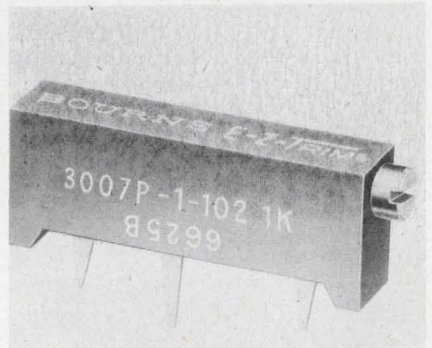

Bourns, Inc., Trimpot Div., 1200 Columbia Ave., Riverside, Calif. Phone: (714) 684-1700. P&A: 99¢ (1000 lots); stock to 3 wks.

Priced at 99¢, this wirewound adjustment pot is available in standard resistances of 10  $\Omega$  to .20 k $\Omega$ . Power rating is 1 watt at 40°C and operating temperature range is -55° to +125°C. Resistance tolerance is  $\pm 10\%$ . The unit has a 20-turn screwdriver adjustment and a self-locking adjustment screw.

CIRCLE NO. 272

**Gripping terminal aids  
component-PC bond**

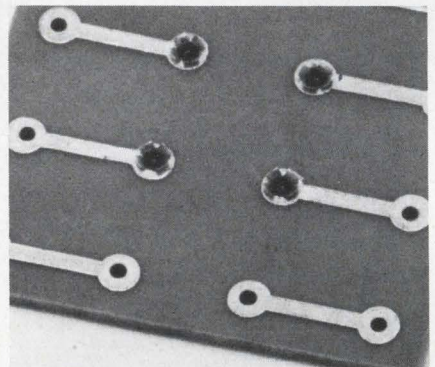

Berg Electronics, Inc., New Cumberland, Pa. Phone: (717) 938-6711.

Aimed at solving the problem of making reliable joints between circuitry and components mounted in holes on a PC board, this terminal has a gripping feature for mounting leads and components to the board. The Griplet holds leads and hook-up wires securely with "starfish" fingers which permit a stand-off if needed. High-reliability solder joints are reported because of metal-to-metal contact between leads and PC conductors.

CIRCLE NO. 273

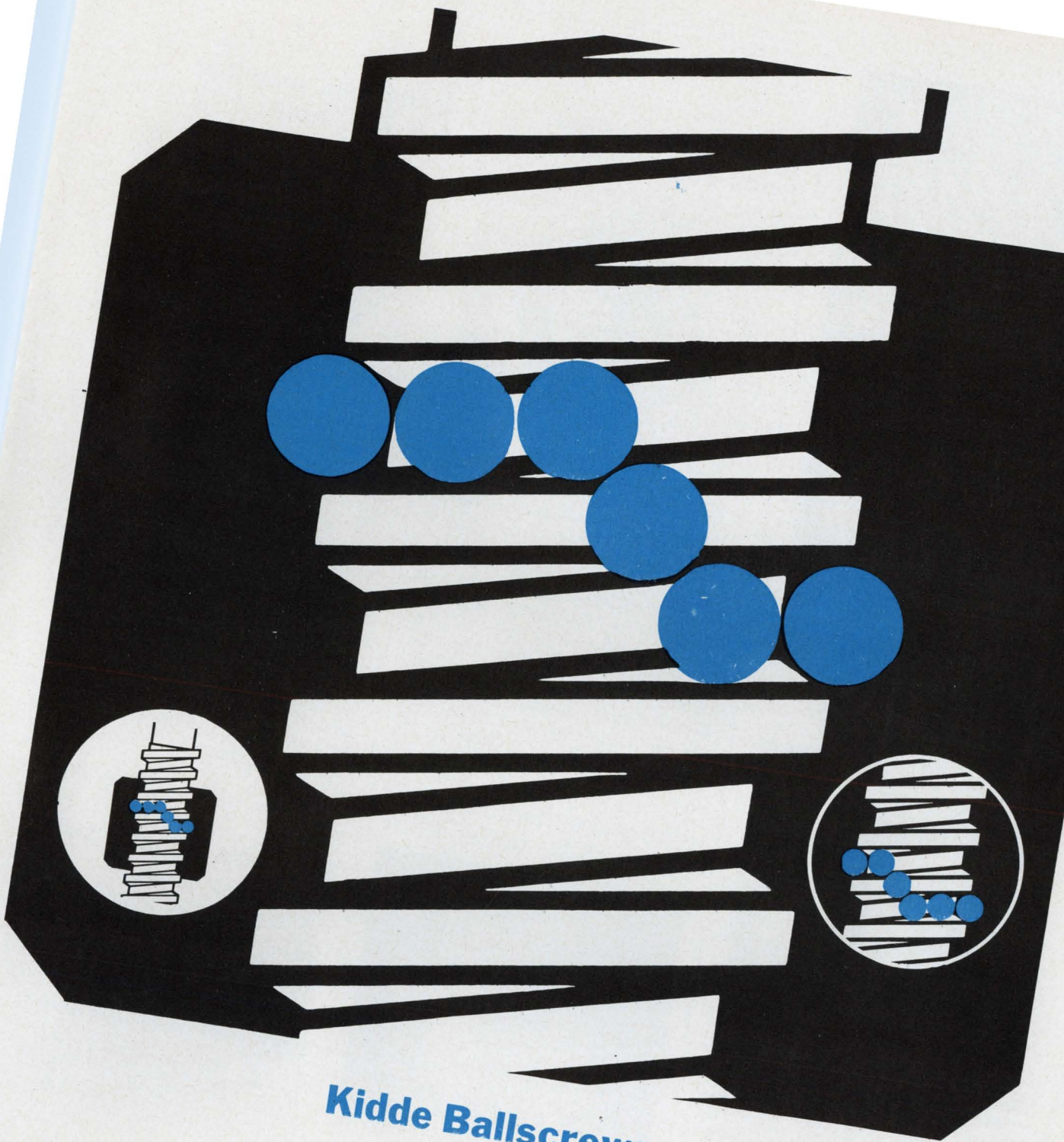

## Kidde Ballscrews

### SIZE AND WEIGHT PROBLEM SOLVERS

Kidde Ballscrews do more than solve friction problems of prime movers and drives. They can solve size and weight problems, too—and meet the demands for high efficiency transfer of motion and power. Here's why:

Their compact design results in smaller envelope dimensions. Weight is reduced because external tubes and fittings are eliminated. Kidde designs allow optimum usable power. due to extremely high efficiencies.

To solve these major problems, Kidde has designed a

wide range of Ballscrew sizes—from units less than 1" long to 32 foot custom assemblies. From 6" diameters down to 1/8"; sizes 3/16" to 1-1/2" (with various lead) are stocked.

Learn how Kidde Ballscrews can become your problem solver. Write for your free copy of "Standard and Precision Ballscrews." Walter Kidde & Company Inc., 675 Main Street, Belleville, New Jersey 07109.



# A fresh NEW STYLE IN METERS

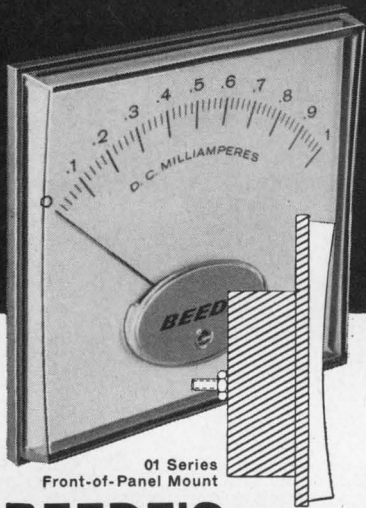

01 Series  
Front-of-Panel Mount

## BEEDE'S DESIGNER LINE

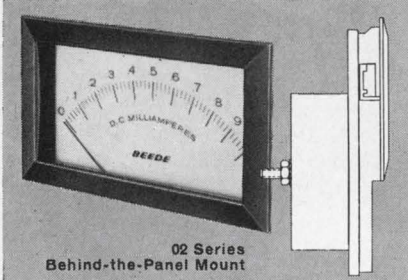

02 Series  
Behind-the-Panel Mount

But we didn't stop at handsome appearance. We insisted on functional design. And we got it. Exceptional readability. Look at the illustrations again. Even at these reduced sizes the scales are easy to read. To minimize reflection we made the windows concave. To harmonize with modern equipment colors, the escutcheon plate of the front-of-panel series is available in six standard colors. Also available on the escutcheon plate is the customer's name or logo.

The behind-the-panel series is easily installed from the front of the panel. A simple bracket secures the meter to the panel face. A translucent window above the scale permits mounting a bulb behind the panel for shadow-free illumination. All in all, equipment designers will find that Beede's new Designer Line meters offer the clean custom look previously available in expensive custom meters only. Both series are available in three popular sizes.

Our new Designer Line brochure with complete specifications and drawings is yours for the asking. Write or call today.

**BEEDE**  
ELECTRICAL INSTRUMENT CO., INC.  
PENACOOK, NEW HAMPSHIRE  
Area Code: 603-753-6362 TWX: 603-753-4727  
ON READER-SERVICE CARD CIRCLE 128

## COMPONENTS

### Line drive amplifier gains 1 to 1000

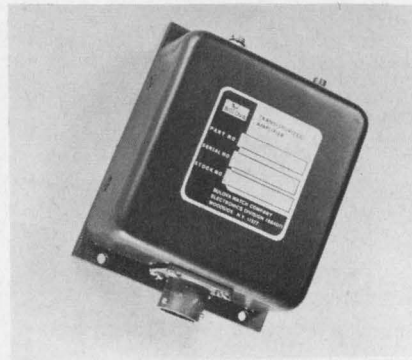

Bulova Watch Co., Inc., 61-20 Woodside Ave., Woodside, N. Y. Phone: (212) 335-6000. P&A: \$175; 8 to 10 wks.

This line drive amplifier has continuously adjustable gain from 1 to 1000 and a frequency response within  $\pm 1$  dB from 3 Hz to 15 kHz. Input impedance is 500 M $\Omega$ . The amplifier operates on a 28-V  $\pm 15\%$ , 40-mA supply. Linearity is within 1% and noise is less than 25  $\mu$ V.

CIRCLE NO. 274

### Sine wave modulator phase shifts under 1°



Natel Engineering Co., 7129 Gerald Ave., Van Nuys, Calif. Phone: (213) 782-4161.

A "true," sine wave modulator with less than 1° phase shift from 300 Hz to 5 kHz doesn't use a filter to provide the sine wave output. Null stability is  $\pm 2$  mV rms from  $-55^\circ$  to  $+71^\circ$ C. The unit provides a linear rms ac output voltage as a function of dc input. The phase of the ac output is determined by the polarity of the applied dc. Input signal is from 0 to  $\pm 100$  Vdc and output is from 3.5 to 30 V rms.

CIRCLE NO. 275

### Unity gain amplifier has FET input

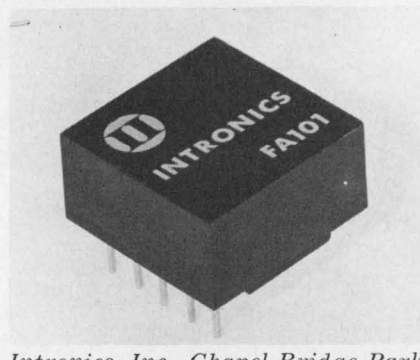

Intronics, Inc., Chapel Bridge Park, 57 Chapel St., Newton, Mass. Phone: (617) 332-7350. P&A: under \$80; stock to 4 wks.

With a FET input stage, this dc-to-200-kHz unity gain amplifier features an input impedance of  $10^{10}$   $\Omega$ . Output impedance is 10 m $\Omega$ . The module is designed for noninverting unity gain impedance transformation applications. Specifications include 50-pA maximum input offset current,  $\pm 10$ -V, 5-mA output and linearity better than 0.005%. Applications include signal buffering and instrumentation read in and read out.

CIRCLE NO. 276

### Multipole transfer switch stacks up small

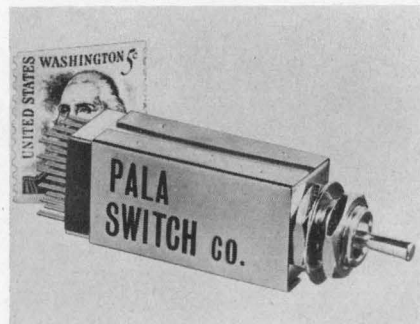

Pala Switch Co., P. O. Box 2234, Orange, Calif.

A multipole transfer switch for transistor circuitry requires only 0.36 in<sup>2</sup> of panel space. The new switch is a 10-pole double-throw type. Insulators are diallyl phthalate, blades are beryllium copper, contacts are coin silver and the exterior housing is brass. Current carrying capacity is 2 A resistive at 28 Vdc or 115 Vac.

CIRCLE NO. 277



# ARNOLD IS



## TAPE WOUND BOBBIN CORES

**Standard Cores of 4-79 Mo-Permalloy and Deltamax  
on Ceramic or Stainless Steel Bobbins . . .**

engineered for use in sophisticated data processing systems, high frequency magnetic amplifiers, static inverters, timing circuits, shift registers, ring counters, pulse transformers and as static magnetic memory elements. All tapes are rolled on a beta-ray controlled Sendzimir mill in standard gages of 1, 1/2, 1/4 and 1/8 mil and slit to standard widths of 0.031, 0.0625, 0.125 and 0.250. Cores are wound on semi-automatic machines, then annealed at extremely high temperatures in specially designed dry hydrogen atmosphere furnaces to obtain the final magnetic properties. Arnold maintains complete control over all phases of fabrication. Melting, processing, rolling and slitting of raw materials (nickel iron) to winding annealing and final test are all "in-plant" functions.

Write for Catalog TC-108B.

 **ARNOLD**  
SPECIALISTS in MAGNETIC MATERIALS

THE ARNOLD ENGINEERING COMPANY, Main Office: MARENGO, ILL.  
BRANCH OFFICES and REPRESENTATIVES in PRINCIPAL CITIES

ON READER-SERVICE CARD CIRCLE 129

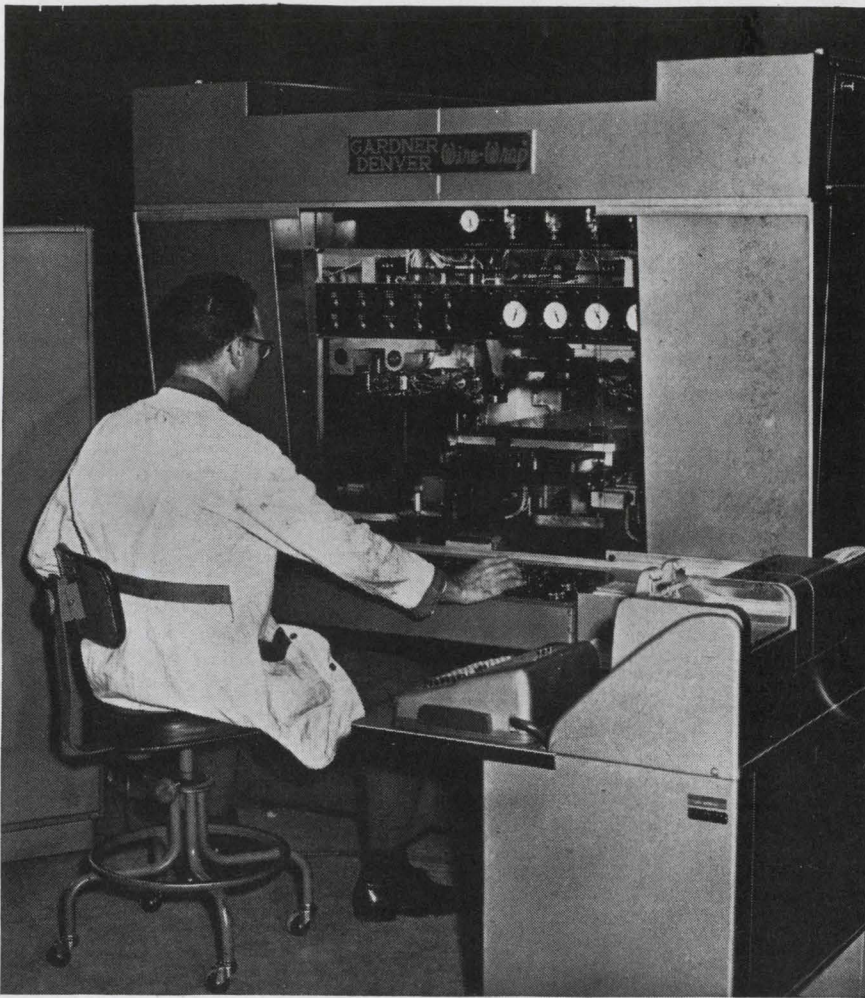

## Program wiring patterns from A to Z with automatic *Wire-Wrap*® machines

Only automatic "Wire-Wrap" machines provide the flexibility required for point to point wiring of modular electronic panels. Just program the circuit with punched cards or tape. Then "Wire-Wrap" machines take over—connecting wires at an average of 5 seconds per wire—as much as 25 times faster than hand soldering in most applications.

**Reliability**—These solderless wrapped connections are permanently tight—unaffected by temperature changes, atmospheric corrosion, vibration. More than 37 billion such connections are in use today without a single reported failure.

**Economy**—Cost savings in excess of 92% are common when compared to soldering and other techniques. Additional benefits include: No thermal damage to heat-sensitive materials . . . elimination of fire hazards . . . connections that are easily removed in plant or in the field.

Write for Bulletins 14-1, 14-121.

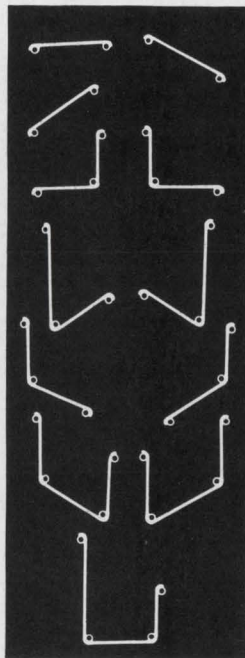

Typical wiring patterns made with automatic "Wire-Wrap" machines.

## COMPONENTS

### Conductive plastic pot linear to 0.05%

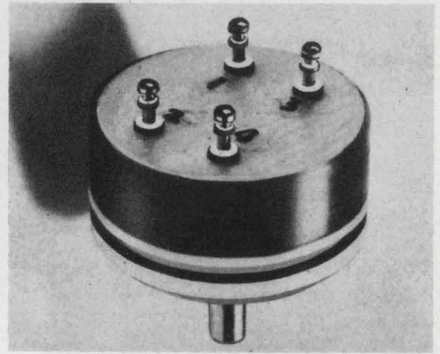

*E.W. Bliss Co., Gamewell Div., 1238 Chestnut St., Newton, Mass. Phone: (617) 244-1240.*

Linear conductive plastic pots offer highly accurate linearity characteristics: 0.05% absolute linearity in the centers of the operational range, tapering to 0.15% absolute linearity in the end regions. A typical unit has a resistance range of 100  $\Omega$  to 20 k $\Omega$   $\pm 10\%$ . Power rating is 1.3 watts at 25°C.

CIRCLE NO. 278

### Tiny magnetic reed switches 1 kVdc

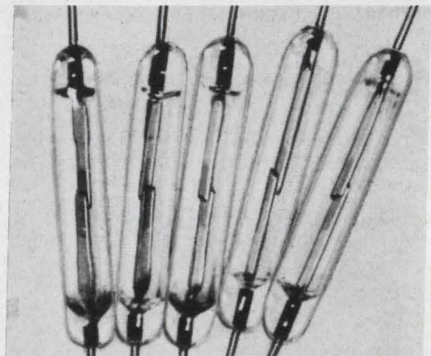

*Hamin, Inc., Lake & Grove St., Lake Mills, Wis. Phone: (414) 648-2361.*

Miniature high-voltage magnetic reed switches are for use in instruments such as oscilloscopes and digital voltmeters requiring switching of low-power, high-voltage circuits. The switch has a uniform glass diameter of 0.125 inch, glass length of 0.805 inch and an over-all length (including leads) of 2.25 inches. Maximum switching voltage rating is 1000 Vdc with maximum breakdown at 2000 Vdc. Maximum current rating is 1 mA and contact resistance is 0.1  $\Omega$ .

CIRCLE NO. 279



SEE WHAT AIR IS DOING NOW...SEE

**GARDNER - DENVER**

Gardner-Denver Company, Quincy, Illinois

ON-READER-SERVICE CARD CIRCLE 130

# Adlake Mercury Wetted Relay — Application Data

## Capacitance of Adlake Mercury Wetted Contact Relays Applicable for Low Signal Applications

**Typical Capacitance in Picofarads** — Graphs illustrate typical capacitance values for Adlake AWCA-16000 series relays. Fig. 1 is for unshielded relays. Fig. 2: Electro-statically shielded switch brought out to a separate pin. Fig. 3: Electro-statically shielded switch with case and shield tied together at a common pin. Interelectrode capacitance across contacts of a bare switch, without external wires, is less than 1.0 picofarad.

Abbreviation COMM. stands for the Combination of the Armature and Normally Closed Contact. N.O. is the abbreviation for Normally Open Contact; whereas the symbol # is the mean average for the 5 relays. Graphs are available on other styles of Adlake Mercury Wetted Contact Relays upon request. (Please state wiring configuration.)

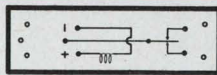

**AWCA 16011-S**  
Fig. 1

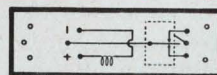
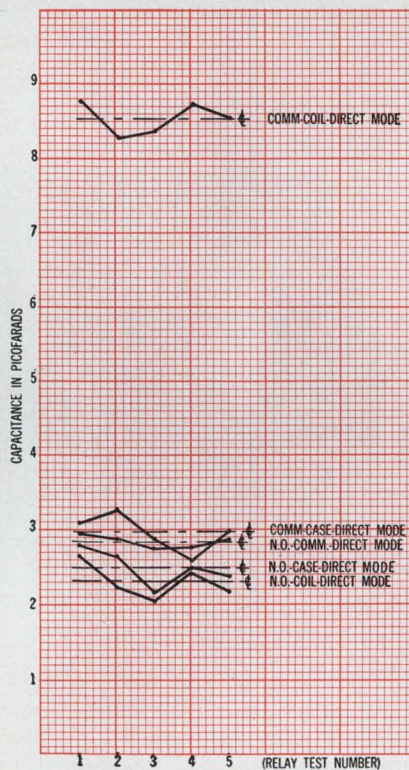

**AWCA 16016**  
Fig. 2

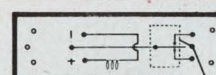
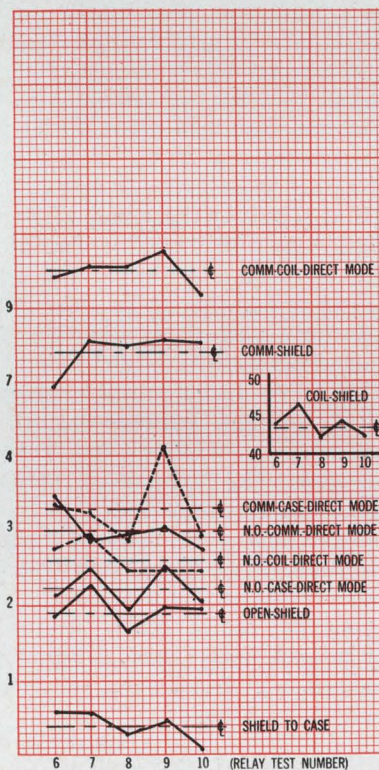

**AWCA 16018**  
Fig. 3

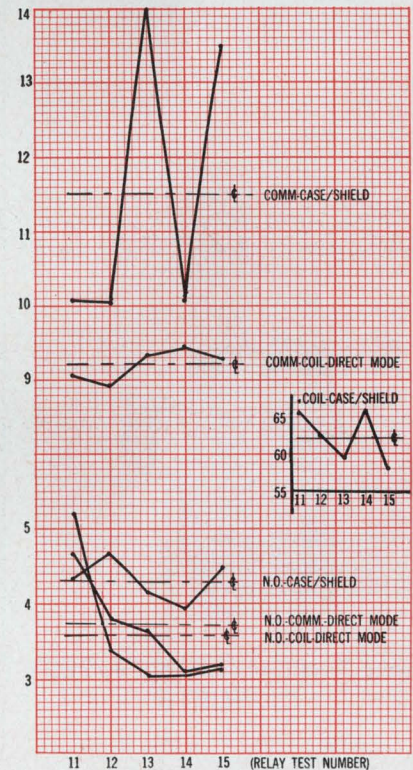

Data was obtained using a Beonten Electronics Corporation Capacitance Bridge, Model 75-A-S8 at 1MHz.

Backed by sound research and disciplined engineering, Adlake applies the industry's broadest line of mercury displacement and mercury wetted relays to the creative solution of design circuit problems. However unique or special your application, Adlake can assist you in

developing it. For prompt, personal and knowledgeable attention to your relay needs, contact the one source that is the complete source in the mercury relay field. Contact Adlake today for catalog and further information.



**THE ADAMS & WESTLAKE COMPANY**

Dept. 1077 Elkhart, Indiana, U.S.A. 46514

(AC 219) 264-1141

TRANSPORTATION EQUIPMENT • ARCHITECTURAL PRODUCTS • MERCURY RELAYS • DOORS AND ENTRANCES • CONTRACT MANUFACTURING

# BLUE M THERMAL SHOCK TEST

**CHAMBERS  
DESIGNED SPECIFICALLY  
FOR MIL-STD-202C**

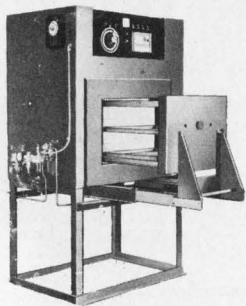

## 3-STAGE THERMAL CYCLING TEST CABINETS

**MEETS METHOD 102A, PREFERRED  
CONDITIONS C & D**

Meets spec. with only one chamber. In operation, work-load carriage moves laterally into conditioning chamber for exposure to  $-55^{\circ}\text{C}$ . or  $-65^{\circ}\text{C}$ . temperature for 30 minutes. It is then moved out, exposed to ambient conditions, transferred back into chamber for conditioning at  $+85^{\circ}\text{C}$ . or  $+125^{\circ}\text{C}$ . and out again to ambient. All automatic. Cycles repeated as required by spec. Special solenoid valves meter  $\text{CO}_2$  or  $\text{LN}_2$  for cooling, heat is controlled by patented POWER-O-MATIC 60<sup>®</sup> Saturable Reactor Control. Quality construction and instrumentation. Moderately priced.

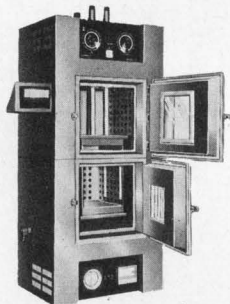

## DUAL THERMAL SHOCK TEST CABINETS

**MEETS METHOD 107B,  
CONDITIONS A, B, C, & F**

2.3 cu. ft. work chamber moves vertically from lower cold chamber to upper heat chamber as required by spec. Cold chamber uses  $\text{CO}_2$  or  $\text{LN}_2$  to reduce incoming load to  $-55^{\circ}\text{C}$ . or  $-65^{\circ}\text{C}$ .; solid-state control system. Heat chamber, with range to  $+204^{\circ}\text{C}$ . ( $+400^{\circ}\text{F}$ .), controlled by POWER-O-MATIC 60. Operation of both chambers is fully automatic—with reliability and accuracy to meet rigid spec. with ease.

**SEND FOR FULL INFORMATION**



**BLUE M Engineering Company**

A DIVISION OF BLUE M ELECTRIC COMPANY

Corporate Headquarters:  
BLUE ISLAND, ILLINOIS 60406  
Offices strategically located to serve you.

ON READER-SERVICE CARD CIRCLE 131

## SEMICONDUCTORS

### Hot-carrier diodes useful to X-band

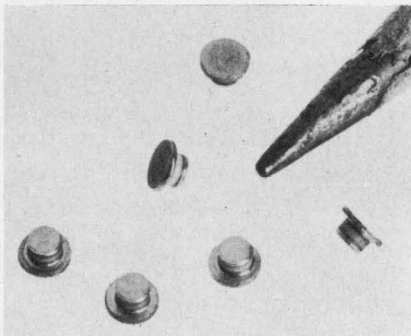

*Hewlett-Packard, 1501 Page Mill Rd., Palo Alto, Calif. Phone: (415) 326-7000. P&A: \$32.40 to \$99 (10 to 99); stock.*

A series of hot-carrier diodes are packaged to permit use in circuits operating at frequencies up to and including X-band. The 2511 diode is in a miniature, hermetically sealed, metal-ceramic package for stripline and coaxial mixer or detector designs. Package inductance and capacitance are 0.35 nH and 0.21 pF. In conventional mixer applications, the SSB noise figure is less than 6 dB at a carrier frequency of 3 GHz (LO power of 1 mW). The diode can withstand 15 ergs, and peak power dissipation (1- $\mu\text{s}$  pulses with 1% duty factor) is 4 watts. Cw power dissipation is 200 mW. The 2700 series diodes are in a symmetrical, ceramic package useful in waveguide, stripline and coaxial systems. The cylindrical package measures less than 0.06 inch in diameter and 0.05 inch in height. Package inductance and capacitance, typically 0.3 nH and 0.13 pF, make the series diodes useful in broadband mixer and detector applications at frequencies both above and below X-band.

**CIRCLE NO. 280**

### Dual-gate MOSFETs up vhf performance

*RCA, Electronic Components and Devices, Harrison, N. J. Phone: (201) 485-3900. Price: \$2.50 (vhf TV rf amplifier), \$2.25 (uhf TV mixer), \$2.00 (fm, rf amplifier), \$1.75 (fm mixer), \$1.50 (color demodulator).*

Five new dual insulated-gate MOSFETs are designed for televi-

sion and a-m and fm receiver entertainment products. They reportedly offer improvement in cross-modulation performance, substantially reduce oscillator radiation through the antenna, and feature as much as 60 dB of agc control utilizing the second gate of a single rf stage. The cross-modulation performance improves as agc causes the device to approach cutoff, with essentially no power being consumed for agc control by the second gate. The devices are n-channel, depletion-type, silicon dual insulated gate MOSFETs. With the exception of the demodulator, they are designed to provide improved performance in the vhf range. They feature low gate leakage currents, feedback capacitances in the order of 0.02 pF, transadmittance of 10,000  $\mu\text{mhos}$  at a drain current of 7 mA and a square-law transfer characteristic.

**CIRCLE NO. 281**

### Devices suppress 12-kW transients

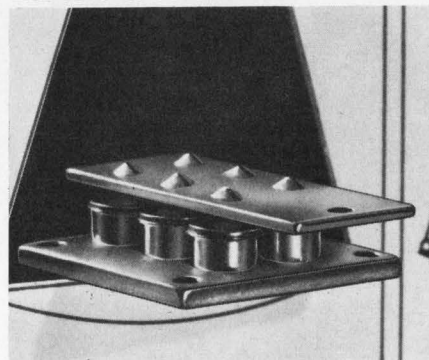

*Motorola Semiconductor Products, Inc., P. O. Box 955, Phoenix. Phone: (602) 273-6900. P&A: \$30 (100-up); stock.*

Solid-state transient suppressors are capable of protecting against power surges up to 12 kW. The devices use matched Zener diodes and are designed to be used individually in dc systems or as back-to-back pairs for applications up to 117 Vac. The suppressors have predictable temperature sensitivity and maintain their breakdown voltage levels relatively constant over an operating range of  $-65^{\circ}$  to  $175^{\circ}\text{C}$ . Ringing is nonexistent and the large quiescent currents encountered with voltage-dependent resistors are reduced to 50  $\mu\text{A}$ .

**CIRCLE NO. 282**

# AC line regulation problems ?

**—check  
the  
Sorensen  
line.**

✓	<b>Precision Regulation Required?</b> —Need $\pm 0.01\%$ ...maybe only $\pm 0.1\%$ ?—Sorensen's broad line of 'off-the-shelf' regulators can provide it.
✓	<b>Size and Weight Important?</b> —ACR units are less than half the size and weight of conventional units.
✓	<b>Stringent Distortion Requirements?</b> —FR models maintain less than 0.25% — even with an input line having 10% distortion.
✓	<b>Need Quick Response?</b> —All models of our FR Series respond to line and load changes within 50 $\mu$ s—less than 1 cycle.
✓	<b>Delivery/Price a Factor?</b> —Each standard model is available off-the-shelf.

However demanding your AC regulator checklist, the Sorensen line can bear a good hard look. Whatever your needs, chances are Sorensen has a unit for your application. We offer a broad range of off-the-shelf line regulators to choose from in the range 150VA to 15kVA. Our ACR Series, for example, feature silicon controlled rectifier regulation, printed circuit maintainability, and require minimal rack space. The .01 Series provides high precision regulation,  $\pm 0.01\%$ , for applications demanding the strictest accuracy and stability. Where fast response is an important consideration, the FR Series is unsurpassed. Sorensen's magnetic-amplifier S Series offers excellent low-cost regulation for a variety of applications.

Each Series is a carefully designed combination of power, performance and packaging,—to fill your specific requirements. Sorensen's AC regulation capability spans 25 years of experience in the design and production of regulators. Our standard product technology provides the firm basis for an outstanding custom design capability. Whatever your AC regulator problems, — check with Sorensen.

For details on Sorensen AC regulators, or for standard/custom DC power supplies or frequency changes, contact your local Sorensen rep. or: Raytheon Company, Sorensen Operation, Richards Ave., Norwalk, Conn. 06856.  
Tel: 203-838-6571.



ON READER-SERVICE CARD CIRCLE 81

## Ge planars have 4-dB NF at 2.25 GHz

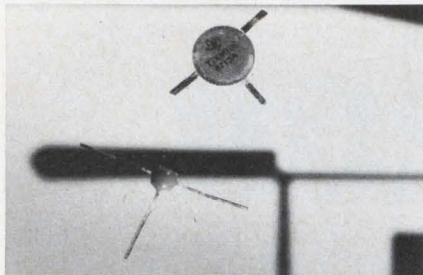

Texas Instruments, Inc., 13500 N. Central Expressway, Dallas. Phone: (214) 238-3741. P&A: \$250 (1 to 99); stock.

Low-noise, high-gain germanium planar transistors have a usable frequency range of 1 to 4 GHz. Designed for use in the 2.25-GHz telemetry band, the devices exhibit a typical noise figure of 4 dB (4.5 dB max) at 2.25 GHz. Typical  $f_T$  of the device is 2.6 GHz. The transistors are the TIXM105 in a common-emitter-configuration package for stripline applications, and the TIXM106 in a modified pellet-pack for thick or thin-film hybrid IC applications. Standard impedance is 50  $\Omega$  at both input and output leads. Applications include L- and S-band radar preamplifiers, phased-array radars, L- and S-band telemetry, and ECM gear requiring octave-bandwidth amplifiers.

CIRCLE NO. 283

## Silicon alloy diodes switch up to 50 W

TRW Semiconductors, 14520 Aviation Blvd., Lawndale, Calif. Phone: (213) 477-6061. P&A: \$2.50 (1000 up); stock.

Silicon alloy rf switching diodes provide up to 50-W switching capability at 250 MHz with 800-V breakdown. Maximum forward resistance at 100 mA is 0.7  $\Omega$ . Three configurations of the DO-14 package are offered. Type PSV-100L has wire leads, type PSV-100J has a miniature fuse-pin cathode end and wire-lead anode end and type PSV-100D has the miniature fuse-pin on both ends. The diodes are for use in low and medium-power switching, duplexing, phase-shifting and other rf applications now using mechanical coax relays.

CIRCLE NO. 284

## Diff-amp transistors in matched pairs

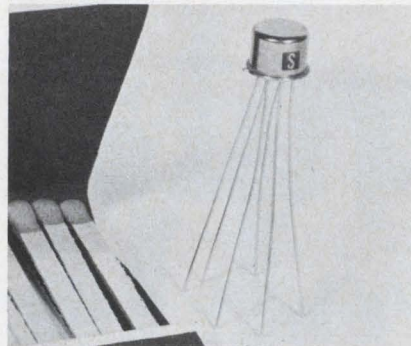

Solitron Devices, Inc., 1177 Blue Heron Blvd., Riviera Beach, Fla. Phone: (305) 848-4311.

Npn and pnp differential amplifier dual transistors are mounted in a six-lead TO-78 or TO-71 package. Since the chips are mounted on the same header,  $H_{FE}$  is matched to 0.9,  $V_{BE}$  is matched to 3 and 5 mV and  $V_{BE}$  tracking is matched to 10  $\mu\text{V}/^\circ\text{C}$ . Typical characteristics include  $h_{FE}$  of 175 at 10  $\mu\text{A}$ ,  $I_{CBO}$  of less than 1 nA at 45 V and noise figure of 2 dB at 10  $\mu\text{A}$ .

CIRCLE NO. 285

## Planar power transistors rated 15 and 20 A

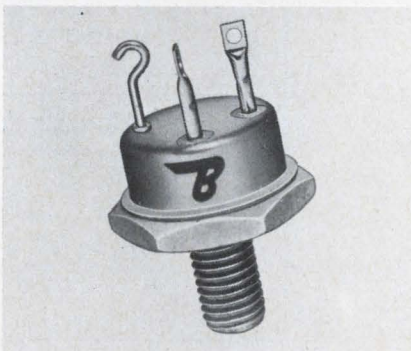

Bendix Corp., Semiconductor Div., Holmdel, N. J. Phone: (201) 946-9400. P&A: \$20.50 to \$35.50 (100 to 999); stock.

Six 15 and 20-A silicon planar power transistors, the B-148000 series, are designed for high-power nanosecond-switching and amplifier applications. Packaged to the JEDEC TO-61 outline with collector connected to case, the transistors feature  $V_{CES}$  from 80 to 120 V and  $V_{CEO}$  from 60 to 100 V.  $V_{CE(SAT)}$  is 1 V at 1 and 10 A.

CIRCLE NO. 286

## DELCO RADIO SEMICONDUCTOR DISTRIBUTORS

### EAST

Baltimore, Md. 21201—Radio Electric Service Co.  
5 North Howard Street/(301)-539-3835  
Binghamton, N. Y. 13902—Federal Electronics, Inc.  
P. O. Box 1208/(607)-748-8211  
Clifton, N. J. 07015—Eastern Radio Corporation  
312 Clifton Avenue/(201)-471-6600  
Newton, Mass. 02195—Greene-Shaw Company  
341 Watertown Street/(617)-969-8900  
New York, New York 10036—Harvey Radio Co., Inc.  
2 West 45th St./ (212)-582-2590  
Philadelphia, Penn. 19123  
Almo Industrial Electronics, Inc.  
412 North 6th Street/(215)-922-5918  
Pittsburgh, Penn. 15206—Radio Parts Company, Inc.  
6401 Penn Ave./ (412)-361-4600  
Woodbury, L. I., N. Y. 11797  
Harvey Radio Company, Inc.  
60 Crossways Park West/(516)-921-8700

### SOUTH

Birmingham, Ala. 35233  
Forbes Distributing Company, Inc.  
2610 Third Avenue, South/(205)-251-4104  
Miami, Florida 33142—Mountain Electronics  
Division of Mountain National Co.  
3730 Northwest 36th St./ (305)-634-4556  
Richmond, Va. 23220—Meridian Electronics, Inc.  
1001 West Broad Street/(703)-353-6648  
West Palm Beach, Fla. 33402—Mountain Electronics  
Division of Mountain National Co.  
1000 N. Dixie Highway/(305)-833-5701

### MIDWEST

Chicago, Ill. 60630—Merquip Electronics, Inc.  
4939 North Elston Avenue/(312)-282-5400  
Cincinnati, Ohio 45237—United Radio, Inc.  
7713 Reinhold Drive/(513)-761-4030  
Cleveland, Ohio 44125  
The W. M. Pattison Supply Co.  
Industrial Electronics Division  
4550 Willow Parkway/(216)-441-3000  
Indianapolis, Ind. 46225  
Graham Electronics Supply, Inc.  
122 South Senate Avenue/(317)-634-8486  
Kalamazoo, Mich. 49005—Electronic Supply Corp.  
P. O. Box 831/(616)-381-4626  
Kansas City, Mo. 64111—Walters Radio Supply, Inc.  
3635 Main Street/(816)-531-7015  
Minneapolis, Minnesota 55413  
Northwest Electronics Corporation  
336 Hoover St., N. E./ (612)-331-6350  
St. Louis, Mo. 63144  
Electronic Components for Industry Co.  
2605 South Hanley Road/(314)-647-5505

### WEST

Albuquerque, N. M. 87103  
Sterling Electronics, Inc.  
1712 Lomas Blvd., N. E./ (505)-247-2486  
Dallas, Texas 75201—Adleta Electronics Company  
1907 McKinney Ave./ (214)-742-8257  
Denver, Colo. 80219—L. B. Walker Radio Company  
300 Bryant Street/(303)-935-2409  
Houston, Texas 77001—Harrison Equipment Co., Inc.  
1422 San Jacinto Street/(713)-224-9131  
Los Angeles, Cal. 90015—Radio Products Sales, Inc.  
1501 South Hill Street/(714)-748-1271  
Los Angeles, Cal. 90022—Kierulff Electronics, Inc.  
2585 Commerce Way/(213)-685-5511  
Oklahoma City, Oklahoma 73102—Radio, Inc.  
903 North Hudson/(405)-235-1551  
Palo Alto, Cal. 94303—Kierulff Electronics, Inc.  
3969 East Bayshore Road/(415)-968-6292  
Phoenix, Ariz. 85005—Sterling Electronics, Inc.  
1930 North 22nd Ave./ (602)-258-4531  
San Diego, Cal. 92101—Milo of California, Inc.  
2060 India Street, Box 2710/(714)-232-8951  
Tacoma, Wash. 98402—C & G Electronics Company  
2502 Jefferson Ave./ (206)-272-3181  
Tulsa, Oklahoma 74119—Radio, Inc.  
1000 South Main Street/(918)-587-9124

### CANADA

Scarborough, Ontario—Lake Engineering Co. Ltd.  
123 Manville Rd./ (416)-757-3253



MARK OF EXCELLENCE

## DELCO RADIO

DIVISION OF GENERAL MOTORS • KOKOMO, INDIANA

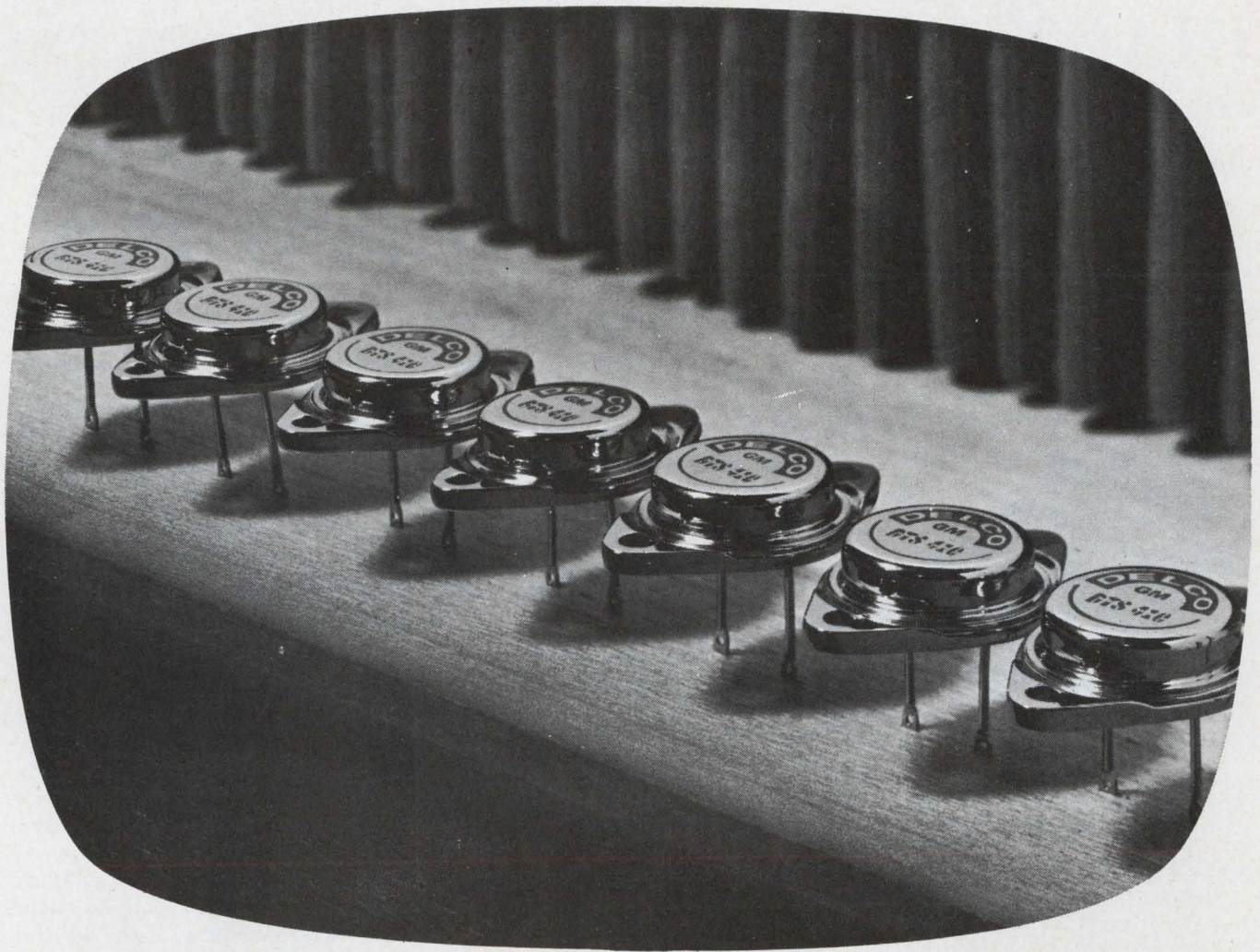

## *You should see us in living color*

Our transistors have carved quite a career in the entertainment world.

First, in our car radios. (We produce all GM car radios and the power transistors for them.)

Then, in television. (We originated the power sweep transistor—for both horizontal and vertical—which helped to make big screen transistorized TV possible and practical.) Several major TV manufacturers are using them.

Today, we have the experience and the capability to supply these transistors in the volume you need for large scale TV set production. For black-and-white or color.

We welcome your order.

**DELCO RADIO**

Division of General Motors  
700 E. Firmin St.  
Kokomo, Indiana • Phone (317) 459-2175



ON READER-SERVICE CARD CIRCLE 133

# GIANNINI on Frequency Manipulation

*"We can do just about anything you want with frequency—divide it, multiply it, measure it, alter it, sense it, produce it.*

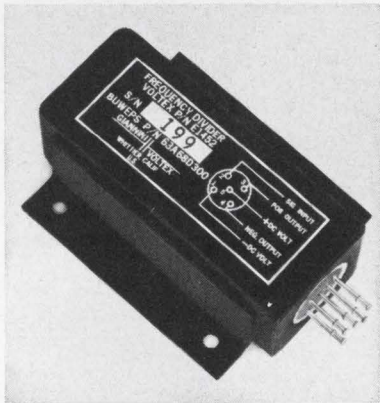

The little unit pictured above, for example, is a frequency divider. It brings 31.5 Kc down to 60 CPS. It weighs only 3¼ oz., measures just 1" x 1" x 2½".

Some typical uses of our frequency dividers are TV Horizontal or Vertical synchronization, event counting and time coding. You can undoubtedly think of many others.

We make frequency dividers which will provide discrete division with statistical tolerances of zero even under aerospace conditions, with any input and output specifications you want!

In fact, if you get the urge to manipulate frequency in any way whatsoever, a call on us might well solve your problem before it develops. Why not give it a try?

*Gabriel M. Giannini*

**GIANNINI** || **VOLTEX**

12140 E. RIVERA RD., WHITTIER, CALIF. 90606  
PHONE: 213-723-3371, TELETYPE: 213-685-6261

An Independent Company/An Equal Opportunity Employer

ON READER-SERVICE CARD CIRCLE 134

## Ac/dc converter widens dynamic and frequency ranges

*Pacific Measurements, Inc., 900 Industrial Ave., Palo Alto, Calif. Phone: (415) 328-0300. P&A: \$900; 30 days.*

Clever FET switching circuitry has widened the application areas and improved the performance of a new ac-to-dc converter. Key specifications include:

- 70-dB dynamic range
- 10-Hz-to-5-MHz response
- 300- $\mu$ V sensitivity

A FET series-shunt electronic switch is the key to the unit's operation. It affords switching at the precise instant of zero crossing of the ac input signal.

A sample of the incoming signal is applied to a high-gain amplifier driving a Schmitt trigger. The output of the Schmitt trigger drives a square-wave generator, which in turn drives the electronic switch. Two outputs, exactly 180° out of phase with each other are provided by the square-wave generator: one to drive the shunt switch, the other to drive the series switch. The series switch passes one-half of the ac

cycle, and the shunt switch provides a precise ground clamp during the other half-cycle. Thus the output of the switch is a half-wave rectified signal precisely clamped to ground. This signal is filtered, and the resulting dc voltage is exactly proportional to the magnitude of the input ac signal. Linearity is 1%.

The dynamic signal range, 300 mV rms to 1 volt rms, is not limited in any way by a rectifying semiconductor junction, nor is the speed of response limited by any peak holding capacitor.

The output voltage is unrestricted by any need to operate a rectifier in the current mode, rather than the voltage mode. The linearity does not depend on a large available signal to overcome the nonlinearities of a rectifying junction; the dynamic range is restricted only by noise and mixer unbalance at the low end, and by semiconductor device breakdown at the high end. The speed of response is determined by the capabilities of an output low-pass filter, which rejects signal frequency.

CIRCLE NO. 252

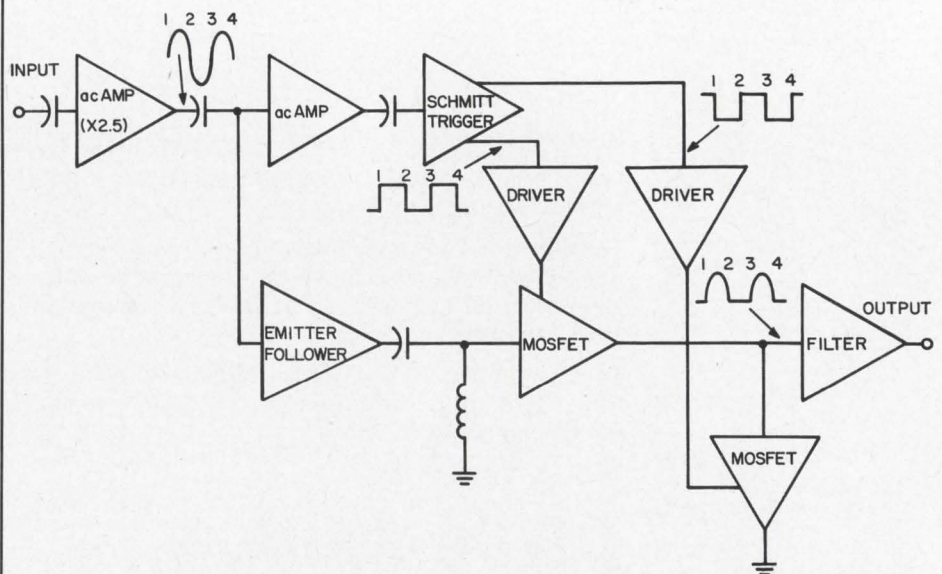

A zero-voltage FET series-shunt switch rectifies incoming ac. A sample of the input ac is amplified to drive the Schmitt trigger, which, in turn, drives the square wave generator. The generator has two outputs: one drives the shunt switch, the other the series switch.



**Dc voltmeter offers  
10- $\mu$  V null sensitivity**



Precision Standards Corp., 911 Westminster Ave., Alhambra, Calif. Phone: (213) 289-2453.

Featuring 100- $\mu$ V null sensitivity, this voltmeter has ranges of  $\pm 1100$  V,  $\pm 110$  V,  $\pm 11$  V, 1100 mV and 110 mV. With rated accuracy of  $\pm (0.005\%$  of input + 0.0002% of range + 5  $\mu$ V), the instrument features a 6-digit in-line readout with lighted decimal and incorporates a temperature-controlled Zener reference unaffected by shock, vibration or wide temperature excursions.

CIRCLE NO. 287

**Dc supply modules  
rated to 410 V**

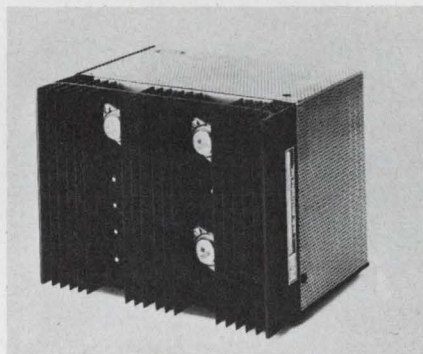

ACDC Electronics, 2979 N. Ontario St., Burbank, Calif. Phone: (213) 849-2414.

Higher-voltage dc power supply modules, including units to 410 V, extend the company's line from 0 V, 0.1 A to 410 V, 0.6 A. Voltage regulation of 0.01% is provided in the BX series and 0.5% in the BC series. All of the modules feature plug-in PC board construction, automatic overload and short-circuit protection, remote sensing and remote voltage adjustment.

CIRCLE NO. 288

**New! -- Ballantine  
Solid State AC Voltmeter**



Model 303

**2 Hz to 6 MHz, with 1% Accuracy  
at Midband -- Operates from Built-in  
Rechargeable Battery or Power Line**

**FEATURES:**

- ★ Frequency range of 2 Hz to 6 MHz
- ★ Voltage range of 300  $\mu$ V to 350 V (100  $\mu$ V sensitivity, 10 Hz to 1 MHz)
- ★ Optional models with probe for voltage range 1 mV to 1000 V
- ★ 1% accuracy, 30 Hz to 1 MHz
- ★ Built-in rechargeable battery or power line operation (Optional version for power line only)
- ★ Logarithmic indicator for uniform accuracy and resolution over entire scale
- ★ Floating signal ground
- ★ 10 M $\Omega$  input resistance
- ★ Model 800 kit available for rack mounting without modifications

**Prices:**

Model 303: Rechargeable battery/line, \$320  
Model 303-50: Rechargeable battery/line,  
with 1 kV 20 dB Probe, \$382

Model 303-01: Line powered only, \$290  
Model 303-51: Line powered only, with  
1 kV 20 dB Probe, \$352

Write for complete technical data today



**BALLANTINE LABORATORIES INC.**  
Boonton, New Jersey

CHECK WITH BALLANTINE FIRST FOR DC AND AC ELECTRONIC VOLTMETERS/AMMETERS/OHMMETERS, REGARDLESS OF YOUR REQUIREMENTS. WE HAVE A LARGE LINE, WITH ADDITIONS EACH YEAR. ALSO AC/DC LINEAR CONVERTERS, AC/DC CALIBRATORS, WIDE BAND AMPLIFIERS, DIRECT-READING CAPACITANCE METERS, AND A LINE OF LABORATORY VOLTAGE STANDARDS FOR 0 TO 1,000 MHZ.

ON READER-SERVICE CARD CIRCLE 135

# ECONOTAN<sup>®</sup>

MINIATURE  
SOLID TANTALUM  
CAPACITORS

## UP TO 35 WVDC

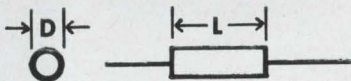

CASE SIZE	CT	CM	CL
DIAMETER	.095	.133	.180
LENGTH	.260	.320	.345
CUBIC INCHES	.00184	.00444	.00877

- Metal can/epoxy construction
- 2 to 35 WVDC voltage ratings
- .0047 to 68 mfd capacitance range
- $\pm 20\%$  and  $\pm 10\%$  standard tolerances
- $-55^{\circ}\text{C}$  to  $+85^{\circ}\text{C}$  temperature range
- 6% max. DF most values
- .5 to 2.0  $\mu\text{A}$  max. leakage
- 130% surge voltage specification
- 20,000G's, 10 msec shock specification
- 2,000 hour life test
- Mylar sleeves

**BEST DELIVERY  
IN THE INDUSTRY**

AVAILABLE ON REQUEST:

- TECHNICAL LITERATURE
- RELIABILITY DATA
- SAMPLE ECONOTAN<sup>®</sup> UNITS



**COMPONENTS, INC.**

**MAINE DIVISION**



SMITH STREET / BIDDEFORD, MAINE / 207-284-5956

ON READER-SERVICE CARD CIRCLE 136

## TEST EQUIPMENT

### Power sweep generator puts out 100 W



Solar Electronics Co., 901 N. Highland Ave., Hollywood, Calif. Phone: (213) 462-0806.

This power sweep generator produces triangular, square and sine waves at 100-watt levels with selectable sweep rates or manual control for use in performing audio susceptibility tests. It is useful in making transient studies of passive networks, square wave testing of amplifier systems and as a source of 400-Hz or other power frequencies. Frequency range is 15 Hz to 150 kHz. Sweep rates are one per minute, ten per minute or manual dial. The output is adjustable up to 100 watts into a 2- $\Omega$  load.

CIRCLE NO. 289

### Portable static inverter delivers up to 295 VA

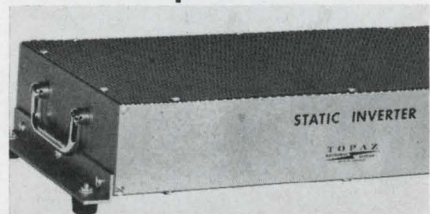

Topaz, Inc., 3802 Houston St., San Diego, Calif. Phone: (714) 297-4815.

Designed for mobile operation of instrument plotters and recording oscillographs, this inverter operates from 12 or 24-Vdc batteries and offers selectable outputs of either 115 or 230 Vac. Output power is 295 VA continuous and 375 VA intermittent. Overload capability of 50% allows the unit to handle normal startup requirements for both the oscillograph drive motor and the recording lamp.

CIRCLE NO. 290

## NICE TRY, GUYS

Man's first aerospace project, Babel I, utilized a straight-forward design concept: Travel into outer space would be effected by climbing a tower. However, it did not meet noise specifications, and the mission was aborted.

Now that Genisco offers a complete selection of power line filters and shielded enclosures you can avoid analogous difficulties.

Rated from 30 amps to 200 amps, 120 V to 250 V, single or three-phase power lines, the three series are designed for typical circuit breaker panelboards with or without requirements for power line filtering, and for use in shielded rooms and for installations requiring electrical distribution.



Although these power line filter assemblies meet MIL-F-15733, we do not recommend their use in towers extending beyond terrestrial limits. This application is not approved by The Chief Design Engineer.

**ON READER-SERVICE CARD CIRCLE 121**

## DIDJA HEAR THE ONE ABOUT THE BI-PLANAR NAB 14" REELS?

Seems like there's this Model 10-276 magnetic tape recorder for aircraft, shipboard, or field portable use. Now, it has this low inertia capstan drive motor, and 6 speed selectable servo to eliminate belts, pulleys, and like that. And get this: no pinch rollers and solenoids to create flutter and skew! Well, these Genisco guys are making a mint on the thing, but they



figure they'll come out with a Model 10-286 with 14" instead of 8.5" reels for customers who need longer record time! Then they go and stack the reels in a bi-planar configuration to save space. The funny thing is it works great. Not much of a story maybe, but they sure are nice tape recorders.

**ON READER-SERVICE CARD CIRCLE 122**

## EARN BIG \$\$\$\$ AS A TELEMETER PERSON !!!

Now you can learn telemetry in the privacy of your own home! Take this free aptitude test NOW!

1. (T) (F) A telemeter is what they put on the back of the TV to find out what you watch.

2. (T) (F) A telemetering checkout station is where you sign out for a telemetering.

Congratulations! You've just won our free correspondence course! Naturally you'll now want a Model A-180 or A-186 completely portable ground station. The A-180 completely de-multiplexes any standard FM/FM Signal. Ideal for checkout of airborne or sledborne applications. The A-186 has fourteen stunning channels. Its receiver is continuously tunable over the 215MC to 260MC band. So get on the road to success! Buy some of our telemetry stuff.  
**ON READER-SERVICE CARD CIRCLE 123**

## WHEEP! WHEEP! WHEEP!

As your missile speeds downrange you are secure in the knowledge that its electro-explosive device can be armed only by the precise signal you alone can send.

Or, horror of horrors, by an unfiltered random burst of identical frequency and duration.

As perspiration beads your brow you feel a sudden fondness for Genisco, renowned experts in RF hazard testing. How nice of them, you think, to have in stock or to design just the filters for the RFI and EMI protection my firing circuits need.

By golly, you conclude, next one of their ads I see I think I'll just

**ON READER-SERVICE CARD CIRCLE 124**

## IT JUST KEEPS ROLLIN', KEEPS ON ROLLIN' AROUND.

Going round and round is our new Model 1147 rate-of-turn table's main trick. It keeps at it no matter how much you abuse it.

Hydrostatic bearings give precise dimensional stability, excellent alignment, low runout and eccentricity, low mechanical noise, and long happy life. It rotates smoothly at less than sidereal rates (0.004°/sec.). And it's just as smooth up to 1500°/sec. Which is why particularly brilliant (and handsome) engineers picked it as the AGE gyro test table for the F-111 Aircraft System.

Great for the lab or just to tote around de field.

**ON READER-SERVICE CARD CIRCLE 125**



GENISCO TECHNOLOGY CORPORATION  
18435 SUSANA ROAD  
COMPTON, CALIFORNIA 90221

## Get a complete Electronic Package from Chassis-Trak of Indianapolis

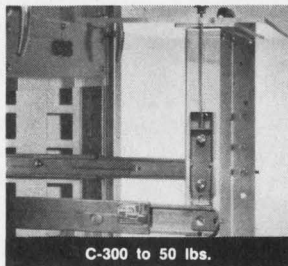

C-300 to 50 lbs.

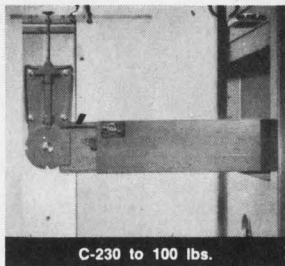

C-230 to 100 lbs.

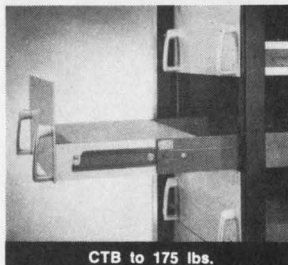

CTB to 175 lbs.

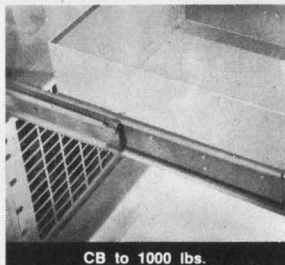

CB to 1000 lbs.

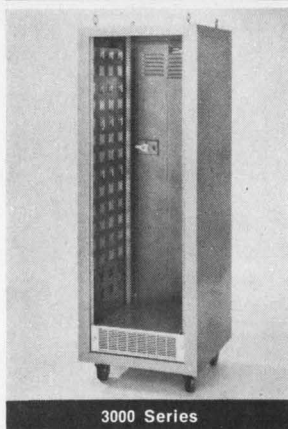

3000 Series

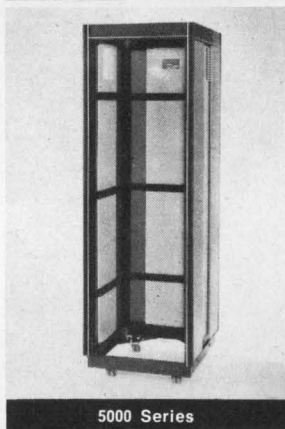

5000 Series

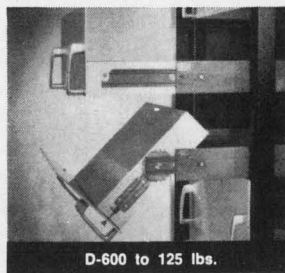

D-600 to 125 lbs.



VENT-RAK Modular Chassis

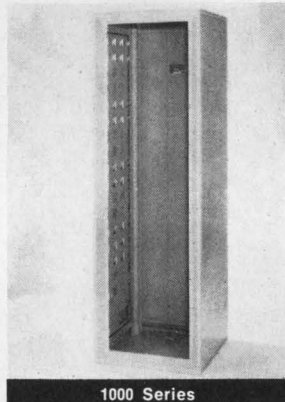

1000 Series



5050 Series

Whatever your electronic packaging needs, military or commercial, light-weight or heavy-duty, Chassis-Trak offers a complete line of slides in capacities from 50 lbs. to 1,000 lbs., hardware, and cabinets in a wide range of styles, sizes and materials. The *Chassis-Trak* of Indianapolis name on your electronic package is your assurance of quality and economical *versatility*.

To learn more about *total electronic packaging* write Chassis-Trak, Inc.



525 South Webster Avenue, Indianapolis, Indiana 46219

ON READER-SERVICE CARD CIRCLE 137

## TEST EQUIPMENT

### Servo device positions, actuates loads

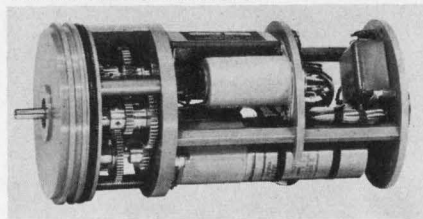

Control Technology Co., Inc., 41-16 29 St., Long Island City, N. Y. Phone: (212) 361-2133.

This "plug-in" servo device positions and actuates a variety of loads as part of an automatic control system. The 0.18-inch diameter output shaft is positioned in response to a dc command signal applied to the unit. Torque produced is 250 inch-ounces and the following speed is 36°/s. Accuracy of positioning is 0.1%. The unit contains a servo motor-generator, clutch-protected multiturn feedback pot, silicon transistor amplifier and gearing.

CIRCLE NO. 291

### Optical pot is high-speed sweeper

Industrial Control Co., Central Ave. at Pinelawn, Farmingdale, N. Y. Phone: (516) 694-3000. P&A: \$150; 4 to 6 wks.

This high-speed potentiometer and sweep or function generator generates a voltage proportional to shaft angle over one revolution by means of a simple optical assembly. Conventional brush or contact noise is absent from dc to the top rotating shaft speed of 12,000 rpm or 200 Hz. The shaft rotates a glass drum around a light source. A mask on the drum surface modulates the light flux, which falls on a photocell and develops a voltage. The mask pattern sets the voltage-shaft-angle relationship. Output waveshape is independent of shaft speed, and contains no noise components. Standard linearity is 5%. By changing the mask pattern, the unit becomes a function generator, developing a step or sine function or any waveshape that can be translated into proper mask geometry. Also, several outputs from a single device are possible. Housing is a size 15 synchro assembly.

CIRCLE NO. 292

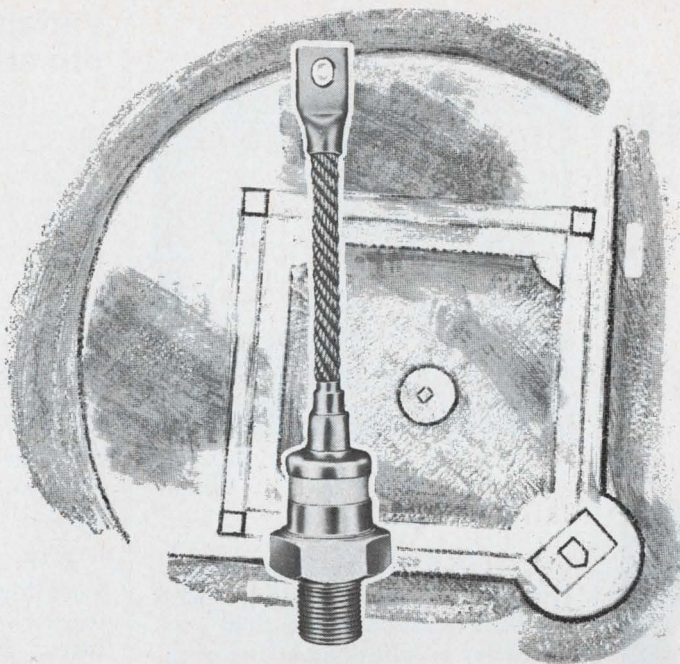

## Covers All Bases

IT'S ALL FOUR BASES FOR THE LEAGUE  
LEADING SCORER IN AVALANCHE DIODES

First Base:  $L \frac{di}{dt}$  transient protection

Second Base: Exact control of individual  
junction parameters

Third Base: To 1,600 PRV

Home: Savings in space and costs.  
(We have enough left over to circle 'em  
a couple more times—send the coupon!)

Send catalog data about  
Syntron avalanche diodes

283

Name/Title \_\_\_\_\_

Company \_\_\_\_\_

Street \_\_\_\_\_

City, State \_\_\_\_\_ Zip \_\_\_\_\_



Catalog with full  
information on Silicon  
Diodes and Assemblies.



**SYNTRON COMPANY**

283 LEXINGTON AVE. • HOMER CITY, PA. 15748

TELEPHONE 412-479-8011

Sales Representatives Coast-to-Coast

67R12

**Sensitive Research\***

solve your  
problems with  
**1/4%**  
Accuracies

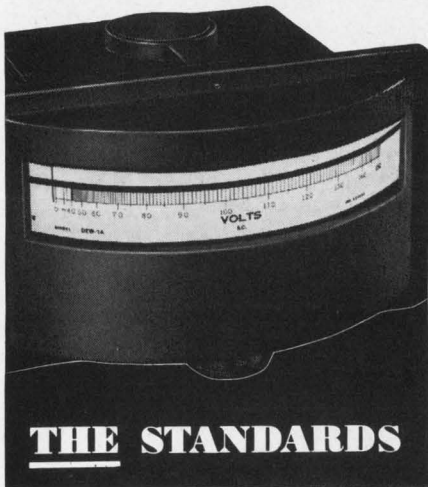

**IN AC/DC VOLTAGE, CURRENT,  
POWER, AND POWER FACTOR  
PANEL METERS**

- Accuracies to 0.25%
- Multi-range switching
- 5" or 7" scale lengths
- Edgewise or rectangular designs
- NBS traceability
- Reliable, friction-free diamond-tipped pivots

For complete data on the broad selection of *Sensitive Research* precision panel instruments, contact your local Singer Instrumentation representative, or write to: The Singer Company, Metrics Division, 915 Pembroke St., Bridgeport, Conn. 06608.



S-66-12

ON READER-SERVICE CARD CIRCLE 139

**TEST EQUIPMENT**

**Delay 5-V pulses  
for 3  $\mu$ s to 50 ns**



*MCG Electronics, 11-22 Joselson Ave., Bay Shore, N. Y. Phone: (516) 586-5125.*

A 2-to-5-V input pulse is delayed from 50 ns to 3  $\mu$ s by this unit with a delay resolution of less than 1 ns. The delay is calibrated at 100-ns intervals and the fine delay control can be locked to hold any delay. The output pulse is +2.5 V into 250  $\Omega$  with rise and fall times of approximately 15 ns. The delayed output exhibits a time delay variation of less than 50 ns at the 3- $\mu$ s setting from 25° to 75°C.

CIRCLE NO. 293

**PCM modules use  
MOS-FETs, DTL logic**

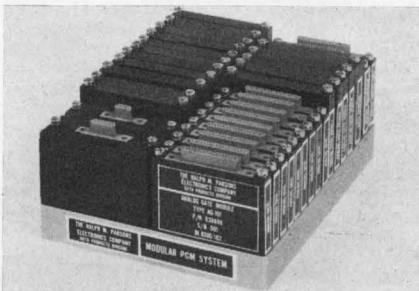

*Ralph M. Parsons Electronic Co., 151 S. DeLacey Ave., Pasadena, Calif. Phone: (213) 681-0461.*

Complete modular PCM systems or individual functional modules are available allowing adaptation to changing data requirements or original system design. DTL integrated circuitry is utilized for all digital circuitry and MOS-FET monolithic arrays are utilized for multiplexing analog signals. Total system sampling rates range up to 50,000/second and bit rates to 500 kHz are available.

CIRCLE NO. 294

**Variable filter offers  
6th order Butterworth**

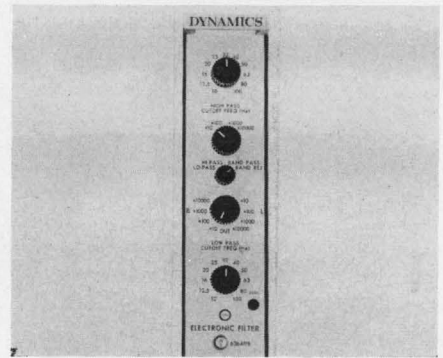

*Dynamics Instrumentation Co., 583 Monterey Pass Rd., Monterey Park, Calif. Phone: (213) 283-7773.*

A variable electronic filter offers a sixth-order Butterworth characteristic for high and low-pass band edges. Two frequency ranges are available: 1 Hz to 10 kHz and 100 Hz to 1 MHz. Low-pass or high-pass filtering can be independently switched out. Terminal slope on each skirt is 36 dB per octave. Cutoff frequencies can be selected over four decades.

CIRCLE NO. 295

**Triggered pulsers  
put out kiloamps**



*Pek, Inc., 825 E. Evelyn Ave., Sunnyvale, Calif. Phone: (408) 245-4111. P&A: \$885 to \$995; 2 to 4 wks.*

Pulse generators incorporating trigger transformers are designed for lab use or applications as flash lamp trigger units, spark gap trigger sources and high-power strobe supplies. The line includes three models offering long-term rms current ratings of 20, 30 and 60 A. Peak secondary ratings are 10, 14 and 12 kiloamperes.

CIRCLE NO. 296

ON READER-SERVICE CARD CIRCLE 140 ➤



# Pretty ugly.

That's what some people say about the Dialamatic Voltmeter. Even some of our salesmen and longtime customers. Now we admit the Dialamatic isn't exactly a thing of beauty. But we didn't build the Dialamatic to look pretty. We built it to fill a gaping hole in voltmeter technology.

The big advantage with the Dialamatic is speed and convenience. It's at least 4 times faster than conventional differential voltmeters. The unique Transfermatic Switch\* lets you carry from one decade to another with just one click

of the right-hand knob. No more cranking all the knobs back to zero just to advance one digit. And because of the non-saturating null amplifier, there's no more constant adjusting for null sensitivity. Actually, you have to flip the knobs yourself to find out how much simpler it works than a conventional voltmeter.

The Dialamatic operates in 4 ranges with accuracies to 0.01% (dc) and 0.2% (ac). And there are 6 models to choose from.

So unless you're looking for a voltmeter that looks like a

beautiful stereo amplifier, get one of our little uglies.

Model 201 (dc only) \$595  
 Model 202 (ac/dc) \$795  
 Model 203 (dc only with 100 $\mu$ v sensitivity) \$645  
 Model 204 (ac/dc with 100 $\mu$ v sensitivity) \$845  
 Model 205 (same as 203 but with 1 kv ref.) \$695  
 Model 206 (same as 204 but with 1 kv ref.) \$895

Battery versions also available.

## WAVETEK®

8159 Engineer Rd., San Diego, Calif., Tel. 279-2200  
 European Sales: 3000 Bern 9, Seidenweg 17, Switzerland

\*Patent applied for.

I see a West-Cap®  
ceramic  
capacitor  
in your  
future  
(I hope!)

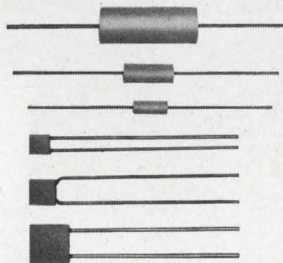
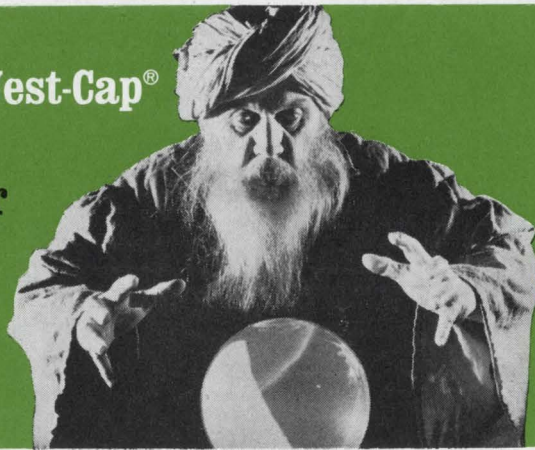

CAPACITANCE VALUES from 5pf to 10 $\mu$ f  
VOLTAGE: 50 to 500 VDC  
TOLERANCE down to 5%  
TEMPERATURE RANGE: -55°C to 150°C  
MEETS OR EXCEEDS MIL-C-11015



**SAN FERNANDO ELECTRIC MFG. CO.**  
1509 FIRST STREET ■ SAN FERNANDO, CALIFORNIA 91341  
TELEPHONE: (213) 365-9411 ■ TWX: (213) 764-5963

ON READER-SERVICE CARD CIRCLE 141

## IC PACKAGING PANELS

for high density packaging

**LOW COST  
HIGH PERFORMANCE  
FAST DELIVERY**

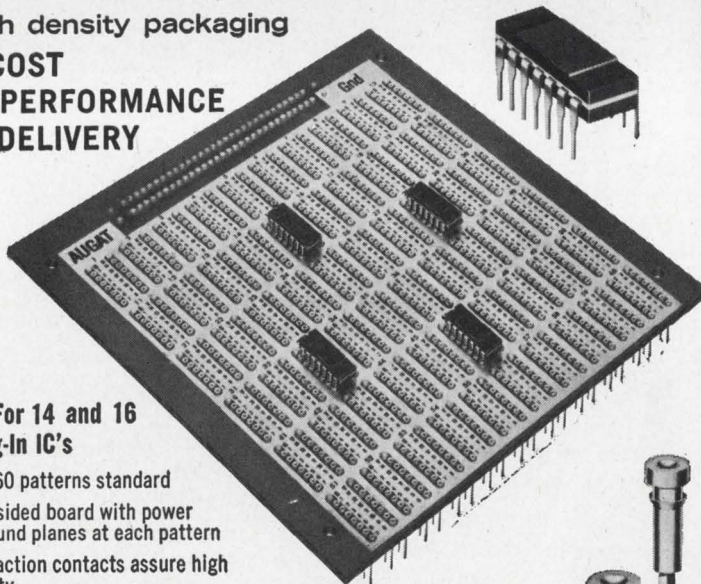

**PANELS For 14 and 16  
Lead Plug-In IC's**

- 30 and 60 patterns standard
- Double-sided board with power and ground planes at each pattern
- Wiping-action contacts assure high reliability
- Wire-Wrap® or solder pot terminations
- Custom designs invited

©Trademark Gardner-Denver Co.

Request Catalog 364 describing our complete line of integrated circuit products for Testing, Breadboarding and Packaging.

**AUGAT** INC. 31 PERRY AVE., ATTLEBORO, MASS. 02703

ON READER-SERVICE CARD CIRCLE 142

## TEST EQUIPMENT

### PAM/PDM conditioner computer controllable

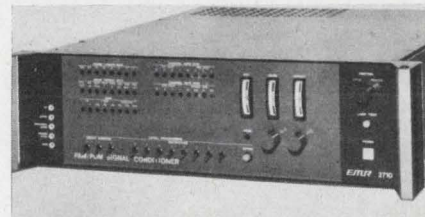

*Electro-Mechanical Research, Inc.,  
Box 3041, Sarasota, Fla. Phone:  
(813) 958-0811.*

Designed to prepare time-multiplex telemetry signals for computer entry, this unit can accomplish signal conditioning of both pulse amplitude modulation (PAM) and pulse duration modulation (PDM) signals. Signal conditioning may be performed manually or under complete computer control. The unit recovers time-multiplexed serial PAM or PDM pulse trains in the presence of noise, automatically generates pulse and frame synchronization, and converts each incoming data sample to a 12-bit parallel word.

CIRCLE NO. 297

### In-line wattmeter spans 30 kHz to 2 MHz

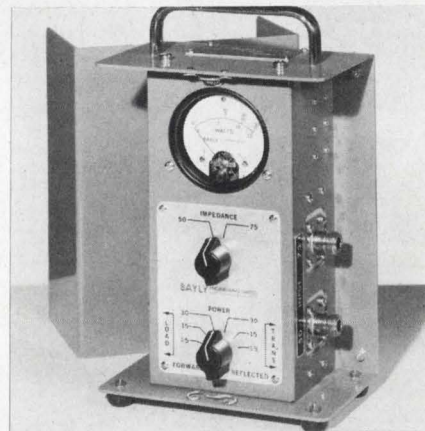

*Bayly Engineering Ltd., Hunt St.,  
Ajax, Ontario, Canada. Phone:  
(416) 942-1020.*

This in-line wattmeter reads forward and reflected power in 50- and 75- $\Omega$  coaxial systems over a frequency range of 30 kHz to 2 MHz. Two instruments are available with power ranges of 1.5, 15 and 30 watts and 50, 100 and 250 watts. Directivity of the couplers is 25 dB. Connectors are N or UHF female.

CIRCLE NO. 298

ELECTRONIC DESIGN 14, July 5, 1967



# DCL<sup>®</sup>

## DESIGNER'S CHOICE LOGIC

Signetics puts IC systems design decisions back in the hands of the systems designer.

Some IC families put severe limits on the decisions the systems designer can make. He's often held back by the speed, power, and noise immunity trade-offs built into the family by the IC manufacturer. Now Signetics Designer's Choice Logic changes all that. Signetics DCL<sup>®</sup> Series 8000 includes high speed TTL circuits, slower low power TTL circuits that offer high AC noise immunity, and low power DTL circuits that provide high DC noise margins. The series also includes large functional arrays for counting and storage applications. All elements in the 8000-Series are specified compatibly. And we've got a 46-page data

handbook — the most complete one of its kind ever offered — to guide you in using these flexible circuits. In designing with DCL<sup>®</sup> you can optimize your system performance without drawn-out calculations, expensive and time-consuming ground-plane designs, or extensive use of outboard discrete components. The handbook provides special sections directed to systems, evaluation and design engineers. Find out fast what can be done with our DCL<sup>®</sup> series, and how to loosen constraints on your designs. Write Signetics for your DCL<sup>®</sup> handbook: 811 East Arques, Sunnyvale, California 94086.

® REGISTERED TRADEMARK 1967.

**SIGNETICS  
INTEGRATED  
CIRCUITS**



A SUBSIDIARY OF CORNING GLASS WORKS

**SIGNETICS SALES OFFICES:** Metropolitan New York (201) 992-3980; Upper New York State (315) 469-1072; Southwestern (214) 231-6344; Western Regional (213) 272-9421; Eastern Regional (617) 245-8200; Mid-Atlantic (609) 858-2864; Southeastern (813) 726-3734; Midwestern Regional (312) 259-8300; Northwestern (408) 738-2710.

**DISTRIBUTORS:** Compar at all locations listed below. Semiconductor Specialists, Inc. (312) 622-8860; Terminal Hudson Electronics (212) 243-5200; Wesco Electronics (213) 684-0880; Wesco Electronics (405) 968-3475; Hammond Electronics (305) 241-6601.

**DOMESTIC REPRESENTATIVES:** Jack Pyle Company (415) 349-1266. Compar Corporation at the following locations: Alabama (205) 539-8476; Arizona (602) 9-4336; California (203) 245-1172; California (415) 697-6244; Colorado (303) 781-0912; Connecticut (203) 288-9276; Florida (305) 855-3964; Illinois (312) 775-5300; Maryland (301) 484-5400; Massachusetts (617) 969-7140; Michigan (313) 476-5758; Minnesota (612) 922-7011; Missouri (314) 428-5313; New Jersey (609) 429-1526; New Mexico (505) 265-1020; New York (518) 436-8536; New York (607) 723-8743; New York (716) 684-5731; New York (201) 471-6090; North Carolina (919) 724-0750; Ohio (216) 333-4120; Ohio (513) 878-2631; Texas (214) EM 3-1526; Texas (713) 649-5756; Washington (206) 725-7800.

**INTERNATIONAL SALES:** France, Germany, Italy, Belgium, Holland, Luxemburg, Spain — Sovecor Electronique, 11, Chemin de Ronde, Le Vesinet, (S.-&O.) France. United Kingdom, Ireland, Sweden, Denmark, Norway, Switzerland, Austria, Portugal — Electroil Ltd., Lakeside Estate, Colnbrook-By-Pass Slough, Buckinghamshire, Great Britain. Australia — Corning, 1202 Plaza Building, Australia Square, Sydney, N.S.W. 27-4318. Canada — Corning Glass Works of Canada, Ltd., Leaside Plant, Ontario, Canada (416) 421-150. Israel — Optronix, P.O. Box 195, Ramat-Gan, Israel 724-437. Japan — ASAHI Glass Co., Ltd., Corning Products Sales Dept. No. 2, 3-Chome Marunouchi, Chiyoda-ku, Tokyo, Japan.

ON READER-SERVICE CARD CIRCLE 143

# Environmental Benchtoppers—



**complete lab in 49 sq. ft.  
for under \$8,500**

**Tenney Jr. environmental test chambers** are field-proven, portable, self-contained units you plug into any standard AC outlet—on bench mobile cart. Use them separately, if you wish, for temperature, humidity or thermal vacuum tests. Use them together as a complete environmental test lab. All are maintenance-free, standard, and economically priced for immediate delivery.

**Tenney Jr. high-low temperature chamber**  
Mechanically refrigerated—hermetically sealed. No special piping or installation.  $-120^{\circ}\text{F}$  to  $+350^{\circ}\text{F}$  ( $20^{\circ}$  colder than  $\text{CO}_2$ );  $\pm 1/2^{\circ}\text{F}$  control;  $\pm 1/4^{\circ}\text{F}$  optional. 1,400-cu.-in. test area. Operates for 2¢ per hour.

**TH Jr.**  
Full performance humidity simulation at low cost.  
Humidity range: 20% to 95%.  
Humidity tolerance:  $\pm 1\%$ .  
Temperature range:  $+20^{\circ}\text{F}$  to  $+200^{\circ}\text{F}$ . Control tolerance:  $\pm 1/2^{\circ}\text{F}$ . 2-cu.-ft. work space.

**Space Jr. thermal vacuum space simulator**  
Deep space conditions for development and production testing ( $7.5 \times 10^{-8}$  Torr). Mechanically refrigerated.  $-100^{\circ}\text{F}$  to  $+350^{\circ}\text{F}$ ,  $\pm 2^{\circ}\text{F}$  control. One cubic foot work space. Blackened temperature surfaces.

For further information,  
write or call today.



1090 Springfield Rd., Union, New Jersey 07083 • (201) 686-7870

Western Division: 15700 S. Garfield Ave., Paramount, Calif. 90723

ON READER-SERVICE CARD CIRCLE 144

## TEST EQUIPMENT

### Dc microvolt-ammeter battery-operated

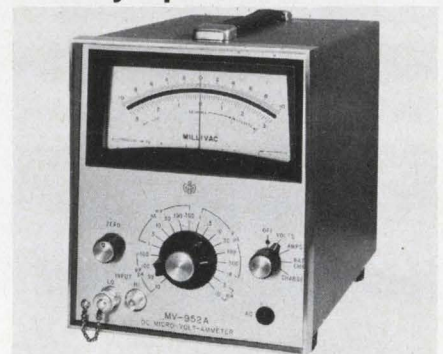

Millivac Instruments, Inc., 2818 Curry Rd. Ext., Schenectady, N. Y. Phone: (518) 355-8300. P&A: \$695, \$625 (ac only); 4 to 6 wks.

A dc microvolt-ammeter can be operated on either 115/230 Vac or on its own self-contained rechargeable NiCad batteries. Measuring ranges are from  $10 \mu\text{V}$  to 1 kV and from 10 pA to 10 mA. Basic accuracy on voltage is 1% and on current 2%. The input can be isolated from ground.

CIRCLE NO. 299

### Multichannel scanning at 6 calibrated rates

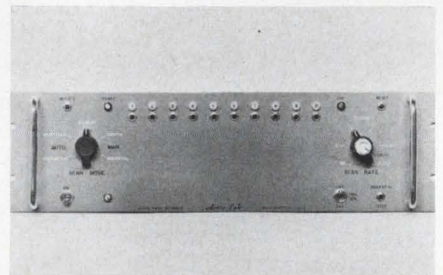

Astro Lab, 9371 Kramer Ave., Westminster, Calif. Phone: (714) 839-0741. P&A: from \$500; stock to 8 wks.

For automatic multipoint test and recording systems, this scanner contains all necessary control functions, including a trigger generator. Automatic sequential scanning is possible at calibrated rates of 60, 10, 1, 0.1, 0.01 and 0.002 seconds per step with a vernier control provided. Channel switching is optional with a choice of 1, 2 or 3-pole single-throw NO isolated reed relay contacts. The basic unit is available with 10, 20, 30, 40 or 50 channels in a 5-1/4-by-19-inch rack panel.

CIRCLE NO. 311

ON READER-SERVICE CARD CIRCLE 145 ➤

# There are two kinds of spectrum analyzers

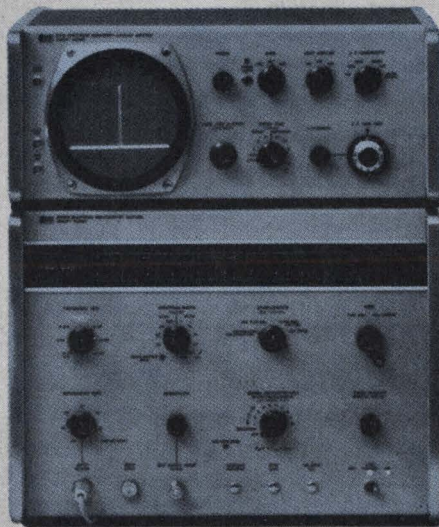

**This kind** has a swept first LO and high frequency first IF to permit viewing of wide (2 GHz) spectra, free from images, spurious and residual responses; calibrated 60 dB display range for accurate comparison of signals widely different in amplitude; RF attenuator for detecting overdriven input and for setting level; just one wideband (0.01-12 GHz), sensitive (-100 to -85 dBm) mixer with extremely flat response ( $\pm 1$  dB on fundamental mixing,  $< \pm 3$  dB for harmonics) over full 2 GHz sweeps. These and other unique features come to almost \$10,000.

**The other kind** of spectrum analyzer does not offer any of these performance features. That's why it costs half as much.

To find out more about 1967-style spectrum analysis, call your Hewlett-Packard field engineer for complete data on the 8551B/851B, or write Hewlett-Packard, Palo Alto, California 94304; Europe: 54 Route des Acacias, Geneva.

HEWLETT  PACKARD

**Most Precise  
Highly Dependable  
Extremely Compact**

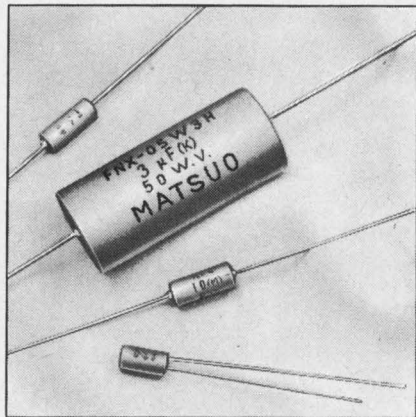

MATSUO ELECTRIC COMPANY LIMITED, guided by the abovementioned qualifications, have been able to produce capacitors, which have proven to be satisfactory in every respect. MATSUO capacitors, widely used for measurement equipment, computers and automatic controllers, enjoy great popularity among their numerous consumers.

**METALLIZED POLYESTER FILM CAPACITOR**

Type FNX-H

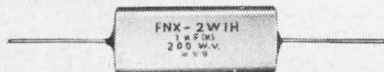

Operating temperature range:  $-40^{\circ}\text{C}$  to  $+85^{\circ}\text{C}$   
Standard voltage rating: 100V, 200V, 400V, 600V D.C.  
Standard capacitance value: .33 MFD to 10 MFD  
Standard capacitance tolerance:  $\pm 20\%$ ,  $\pm 10\%$

**SOLID TANTALUM CAPACITOR**

Type TAX hermetically sealed in metallic case



Operating temperature range:  $-55^{\circ}\text{C}$  to  $+85^{\circ}\text{C}$   
( $+125^{\circ}\text{C}$  with de-rating voltage)  
Standard voltage rating: 6V, 10V, 15V, 20V, 25V, 35V D.C.  
Standard capacitance value: 1 MFD to 220 MFD (E-6 series)  
Standard capacitance tolerance:  $\pm 20\%$

Type TSX encased in metallic case and sealed with epoxy resin



Operating temperature range:  $-55^{\circ}\text{C}$  to  $+85^{\circ}\text{C}$   
Standard voltage rating: 3V, 6V, 10V, 15V, 20V, 25V, 35V D.C.  
Standard capacitance value: 1 MFD to 220 MFD (E-6 series)  
Standard capacitance tolerance:  $\pm 20\%$

Type TSL encased in metallic case and sealed with epoxy resin

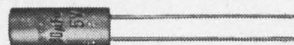

Operating temperature range:  $-55^{\circ}\text{C}$  to  $+85^{\circ}\text{C}$   
Standard voltage rating: 3V, 6V, 10V, 15V, 20V, 25V, 35V D.C.  
Standard capacitance value: 1 MFD to 220 MFD (E-6 series)  
Standard capacitance tolerance:  $\pm 20\%$

for full details, contact:

**MATSUO  
ELECTRIC CO., LTD.**

3-chome, Sennari-cho, Toyonaka-shi, Osaka, Japan.  
Cable Address: NCC MATSUO OSAKA

**TEST EQUIPMENT**

**Ac/dc multimeter  
is four-in-one**

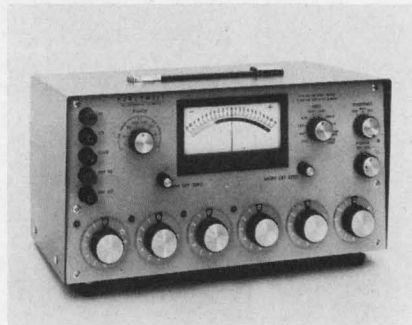

Honeywell, Inc., 4800 E. Dry Creek Rd., Denver, Colo. Phone: (303) 771-4700. P&A: \$1350; 30 to 60 days.

Designed to meet ac and dc measuring requirements, this multimeter also can be used as a voltage reference source, a ratiometer, a decade voltage divider and a null detector. Both rms and dc voltages can be measured up to 1100 V in four ranges, and ac/dc ratios using external reference voltages up to  $\pm 100$  V. Full-scale measurement ranges for both modes are given at 1, 10, 100 and 1000 V with 10% overranging for each range. The frequency range extends from 20 Hz to 20 kHz. Three basic elements make up the units. These are a Zener-regulated,  $\pm 11$ -V reference supply, an electronic null detector and a 6-decade Kelvin-Varley voltage divider with numerical readout.

CIRCLE NO. 312

**High line rejection  
in  $\mu$  V-ammeter**



Keithley Instruments, Inc., 28775 Aurora Rd., Cleveland. Phone: (216) 248-0400. Price: \$825.

Line frequency rejection of 75 dB over full scale for a 2% change in meter reading is featured in this

14-range microvolt-ammeter. The  $3\text{-}\mu\text{V}$ -to-1-V instrument also offers 180-dB common-mode rejection, 5-nV rms input noise, 2-nV resolution and 1- to  $100\text{-M}\Omega$  input resistance. The 14 current ranges run from  $3 \times 10^{-10}$  to  $10^{-3}$  A full-scale. Because of the high line frequency rejection, low noise and high common-mode rejection, the unit can be used as a microvoltmeter or null detector. The line rejection also allows the unit to detect dc signals in the presence of large ac voltages.

CIRCLE NO. 313

**Compact IC counters  
count at 10 MHz**



Hewlett-Packard, 1501 Page Mill Rd., Palo Alto, Calif. Phone: (415) 326-7000. P&A: \$350 (4-digit), \$425 (5-digit), \$475 (6-digit); stock.

Integrated circuit counters have a maximum counting rate of 10 MHz in a case one-third of a standard 19-inch rack in width. The counters have a 4-digit readout (5 and 6 are optional) using miniature side-viewing Nixies. The readout retains the most recent count until a new count is completed, for a continuous, non-blinking display.

Frequency and rate measurements are made with either of two count times: 0.1 and 1 s. The time between counts is adjustable between 50 ms and 5 s by a front-panel control, or a count may be retained indefinitely with the control in a hold position. Input impedance is  $1\text{ M}\Omega$  shunted by 30 pF. Input sensitivity is 0.1 V rms between 5 Hz and 10 MHz. An internal control allows either positive or negative pulses to be counted. The time base is derived from the power line, typically accurate within 0.1%.

CIRCLE NO. 314

Test these new  
cost-saving  
P&B relays  
in *your* circuits

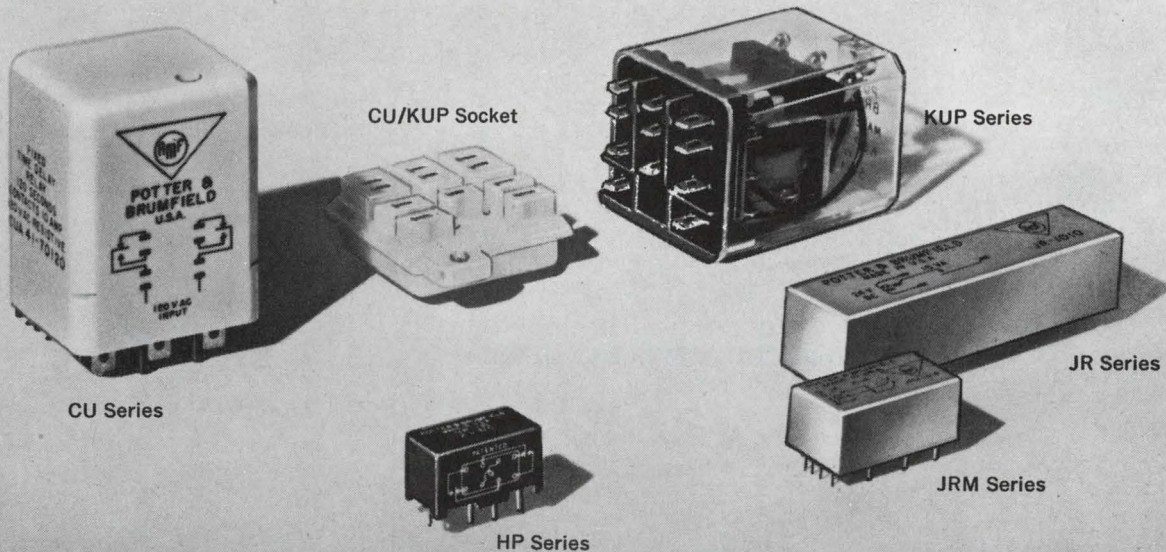

*Your local electronic parts distributor  
has them all for fast delivery*

**RELIABLE SOLID STATE TIME DELAY  
RELAY FOR ONLY \$12.50**

This new solid state time delay relay (CU Series) could be the biggest \$12.50 relay value you've ever seen. Timing tolerance is  $\pm 5\%$ . Internal DPDT relay is rated at 10 amperes. Fixed timing ranges: 10 and 120 seconds. Resistor adjustable ranges are 1 to 10 and 1 to 120 seconds.

Both AC and DC models are available. Standard .187" quick-connect terminals are pierced for solder connections. A special socket permits plug-in convenience.

**FOR LOW COST, HIGH DENSITY PACKAGING**

High density relay packaging becomes a reality with the low profile, 1/5 cubic inch HP Series. Height above terminals is only 0.49". Mechanical life is 10 million operations minimum.

The DPDT contacts are rated from low level to 2 amperes at 30V DC resistive or 0.5 ampere maximum at 120V AC. Coil voltages range from 6V to 48V DC . . . with 12- and 24-volt models standard.

**COST-SAVINGS UP TO \$2.40  
PER PLUG-IN RELAY**

This versatile KUP relay can be a cost-saving answer to your plug-in relay problem. Save up to \$2.40 each over similar relays with octal-type plugs. Get greater reliability, too. Relay has quick connect/solder terminals. Nylon socket (sold separately) rated for 10 amperes. One to three poles. Cover is heat and shock resistant Lexan. For DC or AC operation.

**REED RELAYS MAY REPLACE  
EXPENSIVE SOLID STATE DEVICES**

For applications where fast operate time, low power, high sensitivity, compact size and long life are required.

Both JR standard size and JRM miniature reed relays are available in assemblies of 1 to 4 switches. In a standard range of coil voltages and various combinations of Forms A, B and C contact arrangements.

These and 62 other basic relays are listed in Stock Catalog 100. Ask your distributor for your copy.



**POTTER & BRUMFIELD**  
Division of American Machine & Foundry Co., Princeton, Ind. 47570  
Export: AMF International, 261 Madison Ave., New York, N.Y. 10016

ON READER-SERVICE CARD CIRCLE 147

**CLOSE THE  
TOLERANCE / COST GAP**

WITH QUALITY **BW** MOLDED FLUOROCARBON PARTS

How does Booker & Wallestad close tolerance/cost gap?  
With the most advanced molding facility in the industry. A complete, self-contained tool and die shop steps away from the newest, automated injection molding machines. Highly trained men, drilled in the science of producing quality parts faster.

*Send part or print for quotation or write for free new facilities brochure.*

**BW** BOOKER AND WALLESTAD  
DIVISION OF THERMOTECH INDUSTRIES, INC.  
3326 Gorham Avenue • Minneapolis, Minnesota 55426

ON READER-SERVICE CARD CIRCLE 148

**FREE FOLDER**  
**ECCOSHIELD®**  
**RF SHIELDING MATERIALS**



Brand new six page folder in color describes a complete line of Eccoshield products to combat RFI—conductive plastic sheet and gaskets, adhesives, coatings, caulking compounds, metallic foil — the works.

*This valuable Folder is yours.  
Write or use Reader Service Card.*

**Emerson & Cuming, Inc.**  
CANTON, MASS.  
GARDENA, CALIF. • NORTHBROOK, ILL.  
Sales Offices in Principal Cities  
EMERSON & CUMING EUROPE N.V., Devel, Belgium

ON READER-SERVICE CARD CIRCLE 149

TEST EQUIPMENT

**Sweepers adapted  
for X-Y recording**

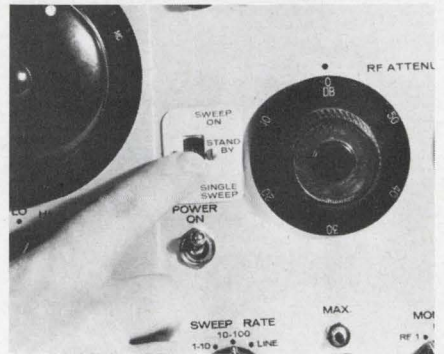

*Telonic Instruments, 60 N. First Ave., Beech Grove, Ind. Phone: (317) 787-3231. P&A: \$75; stock.*

An accessory switching circuit enables a sweep generator to scan a single trace. The use of the single-sweep accessory allows recording the output of the sweep generator on an X-Y recorder or a photographic film. Consisting of a 3-position switch circuit and a BNC output jack, the unit is designed for use with the Telonic SM-2000.

CIRCLE NO. 315

**Low-cost log amps  
centered at 60 MHz**

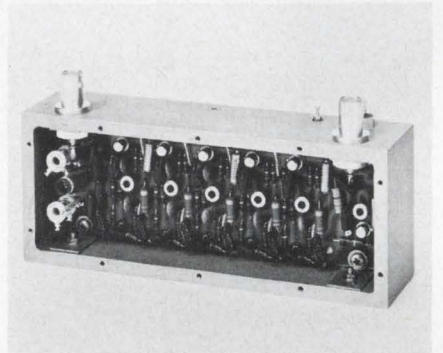

*RHG Electronics Lab., Inc., 94 Milbar Blvd., Farmingdale, N. Y. Phone: (516) 694-3100. P&A: \$325; stock to 30 days.*

Logarithmic amplifiers priced at approximately one-half of comparable units use PC construction. The units have a broadband untuned design and selective input filter to establish the operating frequency. Improved transient response is provided by a turn-off technique in the summing stages. Log accuracy is  $\pm 2$  dB, center frequency is 30 and 60 MHz, bandwidth is 2, 4 or 10 MHz and dynamic range is 60 dB.

CIRCLE NO. 316

# circuit problems?

**Signalite Glow Lamps have solved problems in these areas:**

- Voltage Regulation & References • Photo-Cell Drivers • SCR Triggering
- Timing • Photo Choppers • Oscillators • Indicator Lights • Counters
- Voltage Dividers • Surge Protectors • Logic Circuits • Flip-Flops
- Memory • Switching • Digital Readouts

Signalite glow lamps combine long life, close tolerance and economy, and are manufactured with a broad range of characteristics to meet individual application requirements. For a creative approach to your design problem . . . contact Signalite's Application Engineering Department.



**VOLTAGE REGULATORS BETTER THAN 1% ACCURACY** These subminiature voltage regulators are used in regulated power supplies, as reference sources, photomultiplier regulators, oscilloscope calibrators, etc. They are available in voltages from 82 to 143 V. They are used in multiples as regulators in KV ranges.

SEE Signalite Application News Vol. 3 No. 2 for TYPICAL APPLICATIONS.



**NEON LAMPS WITH TRANSISTORS** The A079 is recommended as an indicator light for transistor circuits, transistorized flip-flops, and other general low voltage operations. The advantages result from the low current and low voltage requirements, the absence of heat generated and extremely long life.

SEE Signalite Application News Vol. 2 No. 5 for TYPICAL APPLICATIONS.

## SIGNALITE APPLICATION NEWS



is used to communicate new and proven techniques and applications of Signalite's neon lamps and gas discharge tubes. Signalite Application News provides a forum for an exchange of ideas to keep the design engineer aware of the versatility of neon lamps and their many applications. Copies are available from your Signalite representative or by contacting Signalite.

Reader Service No. 193



**TRIGGER LAMPS FOR OPERATION OF SCR'S AND TRIACS** The A057B lamp is recommended for use as a triggering device for both SCR'S and TRIACS in motor speed controls and light dimmer circuits. Its properties of stable operation and high current capabilities qualify it for this application.

See Signalite Application News Vol. 2 No. 4 for TYPICAL APPLICATIONS.



**MEMORY SWITCHES** Neon lamps have proven to be an excellent memory switch since they store information and provide visual indication. The properties of neon lamps provide a large differential between breakdown and maintaining voltages, stable electrical characteristics and high "off" resistance (20,000 meg ohms). Other applications include switching, information storage, timing circuitry, etc.

SEE Signalite Application News Vol. 4 No. 3 for TYPICAL APPLICATIONS.

# Signalite

INCORPORATED

NEPTUNE, NEW JERSEY 07753  
(201) 775-2490



SUBSIDIARY OF GENERAL INSTRUMENT

# You name the meter. Ideal has it.

(or we'll make it for you)

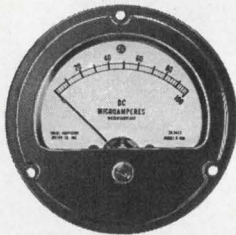
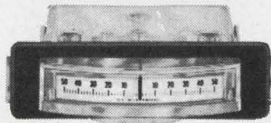
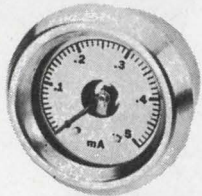
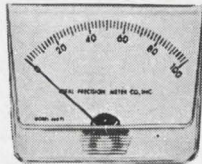
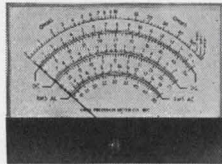

If one concentrates long and hard enough on panel meter development and engineering, one becomes expert.

IDEAL meters are used by all the Military and by leaders in defense and industry. For everything in meters—ruggedized or commercial, custom and stock, 1/2" to 7"—you can count on IDEAL, the proven leader.

Write for free 32-pg. catalog. Ideal Precision Meter Co., Inc., 218 Franklin St., Brooklyn, N.Y. 11222. (212) EVergreen 3-6904.

ON READER-SERVICE CARD CIRCLE 150

## TEST EQUIPMENT

### Dual dc supplies track to 6 V

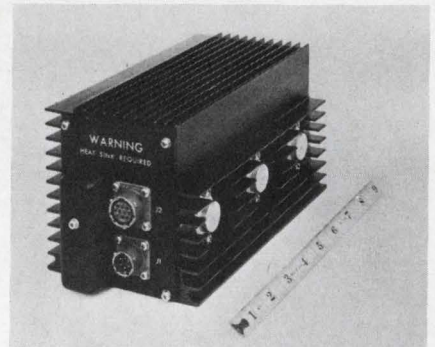

Cal-power Corp., 140 Kansas St., El Segundo, Calif. Phone: (213) 322-5320.

Dual-output, regulated dc power supplies provide outputs of +29 V at 6 A and -29 V at 3 A. Designed for 150-G shock application, the supply operates from a 115-Vac, 400-Hz, 3-phase input and provides  $\pm 0.05\%$  regulation with ripple less than 10 mV rms. Tracking of the outputs maintains a maximum differential voltage of 6 V including turn-on or a short circuit.

CIRCLE NO. 317

### Dc supplies up in V, I and stability

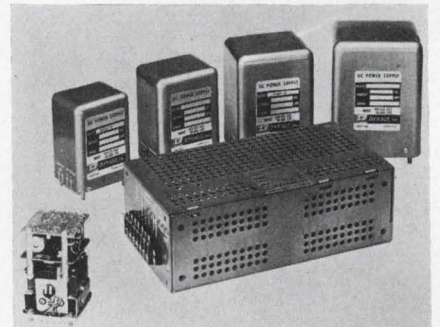

Dynage, Inc., 390 Capitol Ave., Hartford, Conn. Phone: (203) 249-5654. P&A: \$56 to \$210; 72 hours.

Modular and rack power supplies are available with increased voltage and current ratings with high stability as an option. The series offers a selection of power supplies from 0.5 to 252 Vdc and 0.025 to 6.4 A. Stability runs to  $\pm 0.001\%$  or  $\pm 120 \mu\text{V}/8 \text{ hrs}$  short-term, and  $\pm 0.005\%$  or  $\pm 600 \mu\text{V}/\text{month}$  long-term. Regulation for line and load combined is  $\pm 0.01\%$  and temperature coefficient is  $\pm 0.001\%/^{\circ}\text{C}$ .

CIRCLE NO. 318

## 1 KHz to 100 MHz

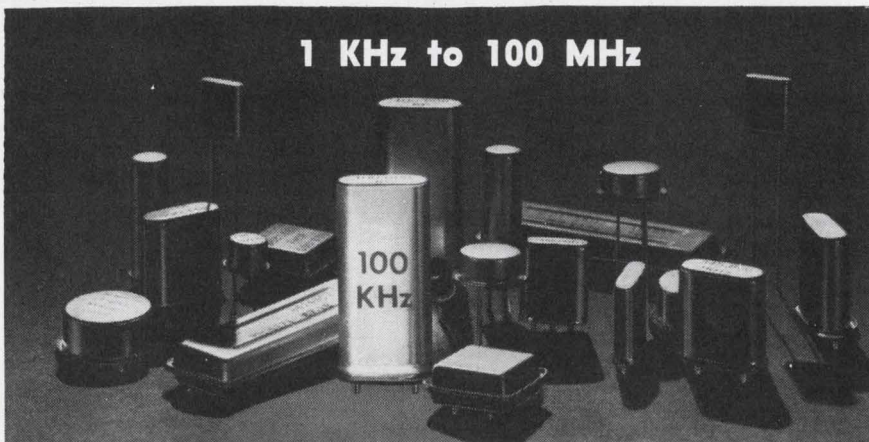

## Can a 100 KHz crystal get lost in the field of frequencies?

Not if you look at Reeves-Hoffman! We are artists in ultra-precision crystals . . . but we're also experts and efficient at meeting less-demanding requirements. For example, the 100 KHz crystal shown above, and specified below, can be supplied in production quantities for less than \$2.50 each. How much less? Let us quote.

Frequency	100 KHz
R <sub>i</sub> , ohms	1,800
L <sub>1</sub> , henries	67
C <sub>1</sub> , picofarads	0.037
C <sub>0</sub> , picofarads	5.78
Q	24,000

5° X crystal for filter or oscillator applications, fundamental extensional mode.



400 WEST NORTH STREET, CARLISLE, PENNSYLVANIA 17013

ON READER-SERVICE CARD CIRCLE 151



# why should you buy a relay that promises less ?

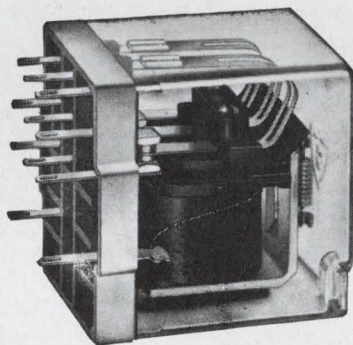

Because this one—the Guardian 1220—promises less of the things you *don't* want. Like wasted space, breakdowns, and high cost. The 1220 is an extremely compact relay. It has a new “Uni-Guard” one-piece switch that eliminates many internal solder connections. The terminal panel is used as the male plug, dispensing with radio-type plug, extra wiring, and sub-assembly. This advanced design boosts dependability, because with fewer parts, there are fewer reasons for breakdown. The U.L. recognized, 10 amp. DPDT or 3PDT 1220 is tightly enclosed (so, no problems from dust or moisture), and it's available from stock. Price? Only \$1.85 in quantities. Write today for our free Bulletin B4—it includes full technical specs, dimensions, mounting variations.

**GUARDIAN**  **ELECTRIC**

1550 West Carroll Avenue, Chicago, Illinois 60607

ON READER-SERVICE CARD CIRCLE 152

## Multiconductor flat cable easy to connect

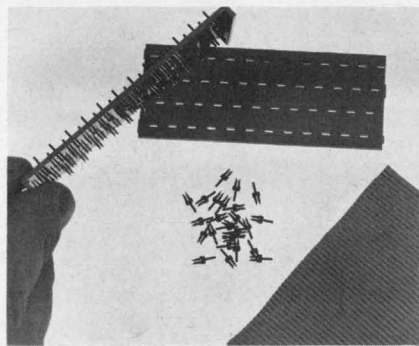

3M Company, 2501 Hudson Rd., St. Paul. Phone: (612) 733-4962.

A systems approach to multiconductor flat cable construction is designed for low-voltage application. Heart of the system is the flat cable, used as a multiconductive constant-impedance jumper for back wiring and interconnection of peripheral equipment.

Depending on application requirements, the cable's design can be varied to match most required impedance characteristics, with wire spacing available down to

0.0125 inch. Wire gauges range from AWG #33 to #24 and can be mixed in a given cable web. Most film insulations are available. Maximum width is 12 inches with a minimum width of 0.04 inch.

With PVC insulation, the cable has a temperature rating of 80°C. Close tolerances are possible in balanced impedance systems from 50 to 300 Ω. "U-type" connecting elements are used throughout the system to make speedy connections. These elements are self-stripping, constant-pressure contacts. Contacts are made by forcing the element points through the cable's insulation, and driving the legs down over the conductor. A base member supports the conductor and cable, providing narrow clearance wells to channel the legs of the elements as they pass through the cable.

CIRCLE NO. 319

## Can you

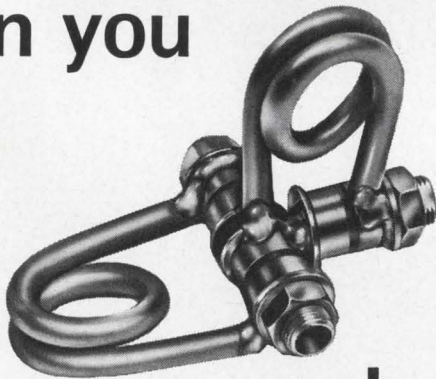

## do this?

These new Johanson glass capacitors are designed to bridge the gap between conventional trimmers and high frequency air capacitors. They have high Q—low inductance; they have high RF current characteristics, they can be soldered together with components to simplify circuitry and they are strong.

### Models include:



SG11054

**Series II:** High RF voltage low cost units with  $Q > 1200$  and TC;  $0 \pm 50$  ppm.



GQ11115

**Johanson GQ11115:** High voltage quartz capacitors which feature 7000 VDC; 2500 V peak RF at 30 mc and current capacity  $> 2$  amps.

### Also available are:

- Tuners and ganged tuners; linear within  $\pm 3\%$
- Differential capacitors
- Mil spec capacitors
- Microminiature capacitors .075" diameter and .1-1 pf

Write today for full catalog.

**Johanson MANUFACTURING CORPORATION**

400 Rockaway Valley Road, Boonton, N. J. 07005 (201) 334-2676

Electronic Accuracy Through Mechanical Precision

ON READER-SERVICE CARD CIRCLE 153

## Weldless Dumet in continuous lengths



General Electric Co., Lamp Metals Dept., 21800 Tungsten Rd., Cleveland. Phone: (216) 266-2970.

A new type of Dumet wire is available in continuous lengths without welds in the standard Dumet sizes from 0.008 to 0.1 inch. Improvements result from a continuous production technique called dip forming, in which a small-diameter rod of nickel-iron alloy is passed through a bath of molten copper. A copper coating adheres to the rod as it leaves the bath and forms a sheath with a 100% metallurgical bond. The composite is then drawn to size. The process permits closer tolerances in the thickness of the copper coating, which comprises 22% of the wire by weight. Low-oxygen, high-purity copper is used for the sheath; the core is 42% nickel-iron.

CIRCLE NO. 320

# High Current Regulated Power Supply Adjustable Output Voltage, 27-28 V.D.C. 1% Regulation 50-60 Cycle Operation Substantial Overload Capability

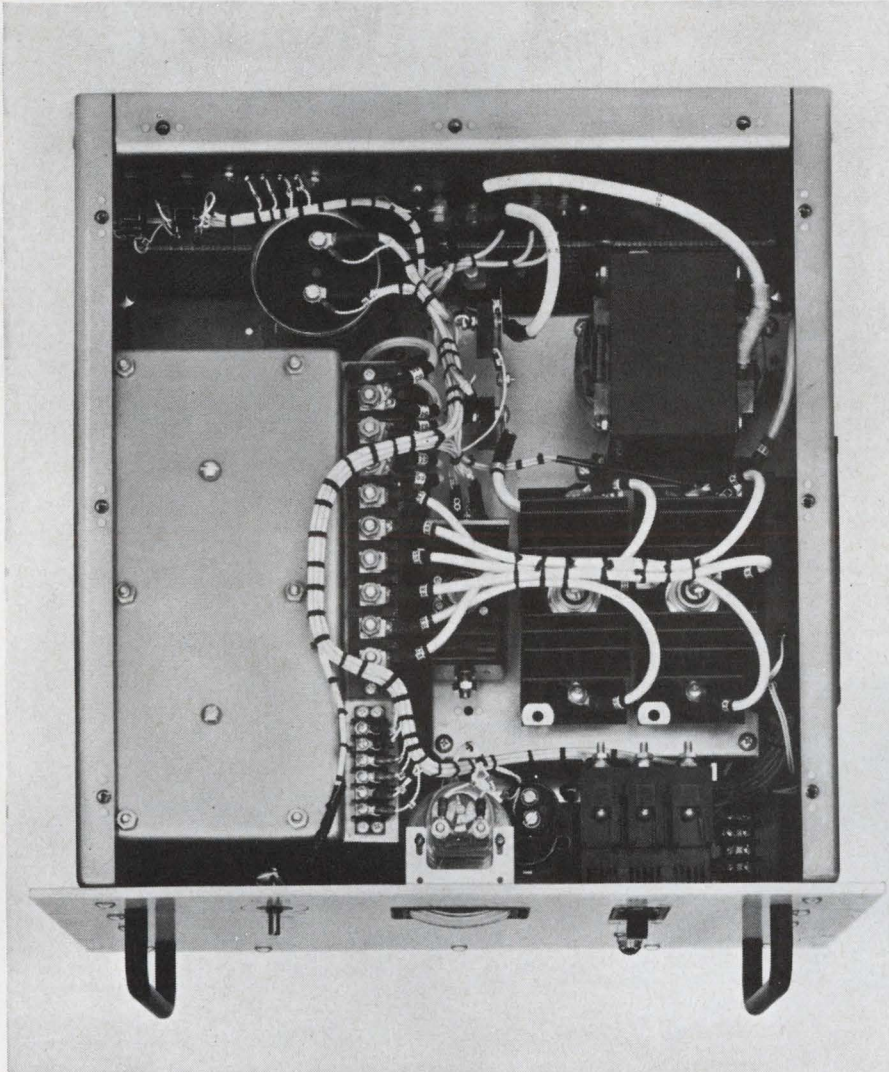

This unit was designed for communications equipment and is available in 25 amp. stages from 25 to 150 amps. It can be operated in parallel, has a remote sense feature, an inverse time circuit breaker and internal fan cooling. Overload capacity is 200% for 5 minutes; 400% for 4 seconds. Environmental capability encompasses a temperature range of  $-20^{\circ}$  to  $+130^{\circ}$ F. This equipment is designed for standard rack mounting and is compatible with the system into which it will be designed.

Like other Tung-Sol designed and built power supplies, this one meets precise performance requirements and high reliability standards. The price doesn't sound as though it was custom built.

If you are interested in this, or a power supply to meet other specs, we would like the opportunity to demonstrate that a Tung-Sol designed unit would be your best buy.

**CHATHAM PRODUCTS**  
Tung-Sol Division  
Wagner Electric Corporation  
LIVINGSTON, N.J. 07039. TWX 710-737-4421

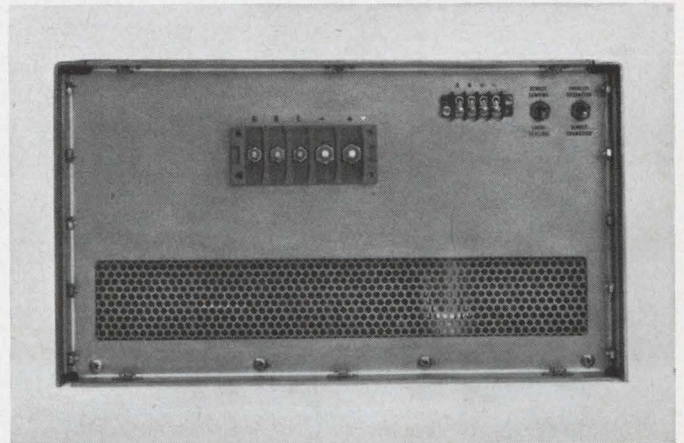
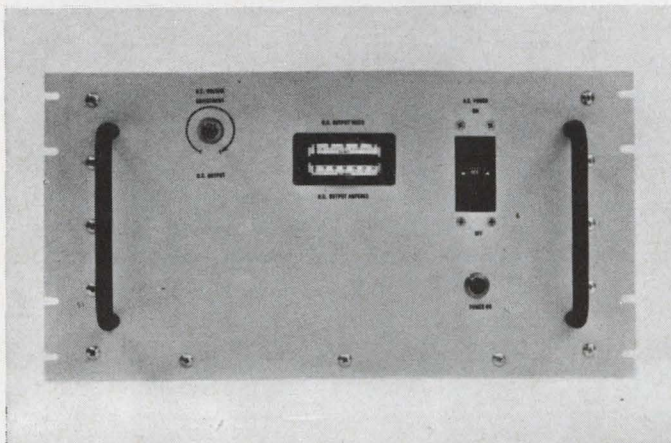

ON READER-SERVICE CARD CIRCLE 154

# TTL DTL

## Monitor lets you choose

No restrictions when you choose MONILOGIC™ IC circuit cards. Select from TTL or DTL types in dual in-line configuration. All are electrically, logically, and physically compatible with each other.

Take your pick from more than 140 different cards, the widest selection in the field. You get important systems-oriented extras with every card. Features like high fan-in and fan-out capacity, built-in auxiliary functions, top-mounted test points and Elco Varicon connectors.

Full specs are in our latest bulletin, which is yours for the asking.



**MONITOR**  
SYSTEMS INC.

Fort Washington, Pa. 19034 A Subsidiary of Epsco, Inc.

3713

ON READER-SERVICE CARD CIRCLE 155

## HYPOT® JUNIOR Breakdown Testers

**MODEL 411**  
0-2500 volts output  
**ONLY \$155**

### Make faster, safer AC dielectric strength tests

of electronic parts and components, small tools, appliances, motors, transformers, etc.

Simple to operate. Make breakdown, leakage and shorts tests to U.L., C.S.A., ASTM, NEMA, IEEE, MIL and EASA standards. 115 vac, 50/60 cycle input. Continuously adjustable output. Included are: complete metering, controls, safety features, case with removable cover, test leads, line cord, instructions.

#### VISUAL INDICATOR MODELS

Have neon "breakdown" light for breakdown, corona or arcing indication... and separate neon "leakage" light for leakage indication. 5 models from 0-1500 to 0-10,000 volts output. Priced from \$145 to \$245. Model 411 shown.

#### AUTOMATIC "SQUAWKER" MODELS

Provide audible and visual test indications. 4 models from 0-1500 to 0-6000 volts output. Priced from \$265 to \$290.

4-35-11

Get all facts . . . write for Bulletin 4-1.3



**ASSOCIATED RESEARCH, INC**

3769 W. BELMONT AVE., CHICAGO, ILLINOIS 60618

ON READER-SERVICE CARD CIRCLE 156

## MATERIALS

### Powdered epoxy resin applied electrostatically

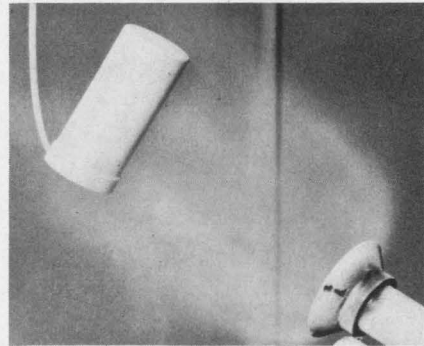

3M Company, St. Paul, Minn.,  
Phone: (612) 733-4033. P&A: \$1.79  
to \$3.40/lb; stock.

A powdered epoxy resin can be applied electrostatically to cold or heated parts and then heat-cured. The powder is specifically designed to accept an electrostatic charge. It may also be applied to heated parts by the conventional methods of fluid bed, spraying, vibrating bed or cascading. Curing may be accomplished at temperatures ranging from 300° to 450°F. Electrical strength is 500 V/mil, dielectric constant is 6.5 and dissipation factor is 0.028.

CIRCLE NO. 321

### Sockets hold leads with 3-leaf contacts

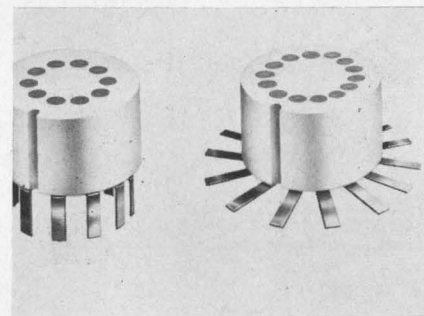

Chemelec Products, Inc., 8 Fellowship Rd., Cherry Hill, N. J. Phone: (609) 424-1470.

TFE fluorocarbon sockets for mounting transistors and ICs on PC boards use a 3-leaf design for reliability. In each pin hole are three beryllium copper leaves that bow in toward the center. When a lead is inserted, the leaves deflect to let it slide in, but press against it to assure good contact. A built-in barb prevents accidental pull-out. Contact resistance is 0.01 Ω.

CIRCLE NO. 322



## We produce the world's broadest line of tubes for electronic countermeasures.

They include CW magnetrons, TWT's, M-type BWO's, crossed-field amplifiers and BARRATRON<sup>®</sup> transmitting tubes. We make tubes for both active and passive applications — with versatility to match any system requirement. Come to Litton for your ECM tubes — you'll find we've got plenty to crow about. Electron Tube Division, 960 Industrial Road, San Carlos, California.

 **LITTON INDUSTRIES**  
ELECTRON TUBE DIVISION

ON READER-SERVICE CARD CIRCLE 157

## 'Hybrid' PC systems rigid and flexible

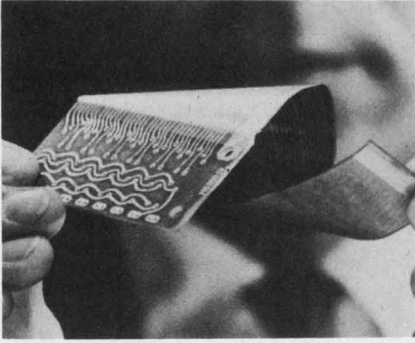

Rogers Corp., Rogers, Conn. Phone: (203) 774-9605.

"Hybrid" rigid-and-flexible printed circuits consist of a rigid laminate on which components can be mounted, combined with a flexible circuit, eliminating the need for external connections. Termination of the flexible lead-offs can be accomplished by all standard methods. A single hardboard connector with the rest of the circuit remaining flexible can be used for part of a system.

CIRCLE NO. 323

## Panel fastener aids rapid assembly

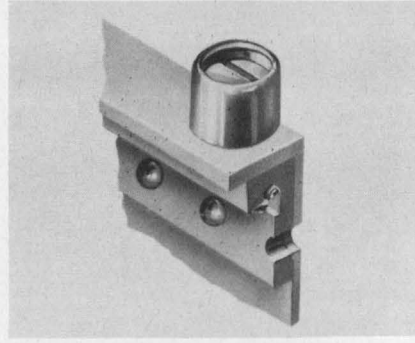

Dzus Fastener Co., Inc., 425 Union Blvd., West Islip, N. Y. Phone: (516) 669-0494.

To facilitate quick and easy installation of various required lengths of console and rack panels, a panel fastener has been designed as a complete assembly for one-step mounting. It is made of cadmium-plated steel. All components are precision fitted into one assembled fastener and packaged for simple, single-motion handling by hand, power or automated installation.

CIRCLE NO. 324

## Cable assemblies have low vswr

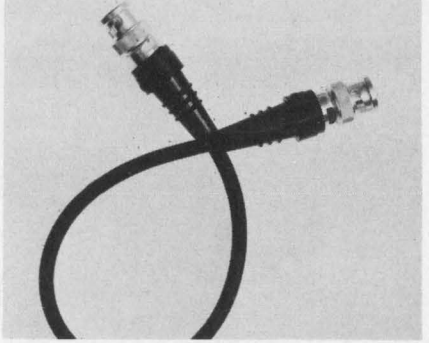

Stanford Applied Engineering, 340 Martin Ave., Santa Clara, Calif. Phone: (408) 243-9200.

These cable assemblies are designed for long life and good electrical characteristics. Vswr at 2.85 GHz is claimed to be as low as 1.01 to 1.04 within the mismatch range from 1 to 1.5%. A molded grip provides a safeguard against damage to the connector pin when making a quick disconnect. The assemblies are available in standard lengths and colors.

CIRCLE NO. 325

## With EASTMAN 910<sup>®</sup> Adhesive...

### Dependable braking in shaded-pole motors

To meet the demands for small physical size without sacrificing critical braking requirements, Barber-Colman Company manufactures compact, efficient motors for a wide range of electrical applications.

To insure quick, sure stops over a long period, EASTMAN 910 Adhesive is used to bond a cork disk to the end of an aluminum rotor and a second disk to the brass or aluminum bearing frame of the brake assembly. Pushed together by pressure applied to the rotor when power is shut off, these disks provide the actual braking as they rub together. Bonds made with

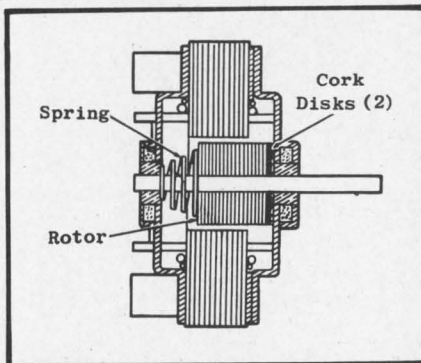

EASTMAN 910 Adhesive withstand this constant braking pressure.

EASTMAN 910 Adhesive will form bonds with almost any kind of material without heat, solvent evaporation, catalysts, or more than contact pressure. Try it on your toughest bonding jobs.

For technical data and additional information, write to Chemicals Division, EASTMAN CHEMICAL PRODUCTS, INC., subsidiary of Eastman Kodak Company, Kingsport, Tennessee.

EASTMAN 910 Adhesive is distributed by Armstrong Cork Company, Industry Products Division, Lancaster, Pennsylvania.

#### Here are some of the bonds that can be made with EASTMAN 910 Adhesive

Among the stronger: steel, aluminum, brass, copper, vinyls, phenolics, cellulose, polyesters, polyurethanes, nylon; butyl, nitrile, SBR, natural rubber, most types of neoprene; most woods. Among the weaker: polystyrene, polyethylene (shear strengths up to 150 lb./sq. in.).

ON READER SERVICE CARD CIRCLE 158



**There is no adhesive like EASTMAN 910<sup>®</sup> Adhesive**

**SETS FAST**—Makes firm bonds in seconds to minutes.  
**VERSATILE**—Joins virtually any combination of materials.  
**HIGH STRENGTH**—Up to 5,000 lb./in.<sup>2</sup> depending on the materials being bonded.  
**READY TO USE**—No catalyst or mixing necessary.  
**CURES AT ROOM TEMPERATURE**—No heat required to initiate or accelerate setting.  
**CONTACT PRESSURE SUFFICIENT.**  
**LOW SHRINKAGE**—Virtually no shrinkage on setting as neither solvent nor heat is used.  
**GOES FAR**—One-pound package contains about 30,000 one-drop applications. (Or in more specific terms, approximately 20 fast setting one-drop applications for a nickel.)  
 The use of EASTMAN 910 Adhesive is not suggested at temperatures continuously above 175°F., or in the presence of extreme moisture for prolonged periods.

See Sweet's 1967 Product Design File 6a/Ea.

**Now available! EASTMAN 910 Surface Activator**  
 When certain surface conditions inhibit rapid bond formation, use of EASTMAN 910 Surface Activator is suggested to restore the rapid polymerization of EASTMAN 910 Adhesive.

Think  
vertically.

Get your  
functional  
circuit  
designs  
stacked  
in a  
MicroCircuit  
Pack™  
ready to  
mount.

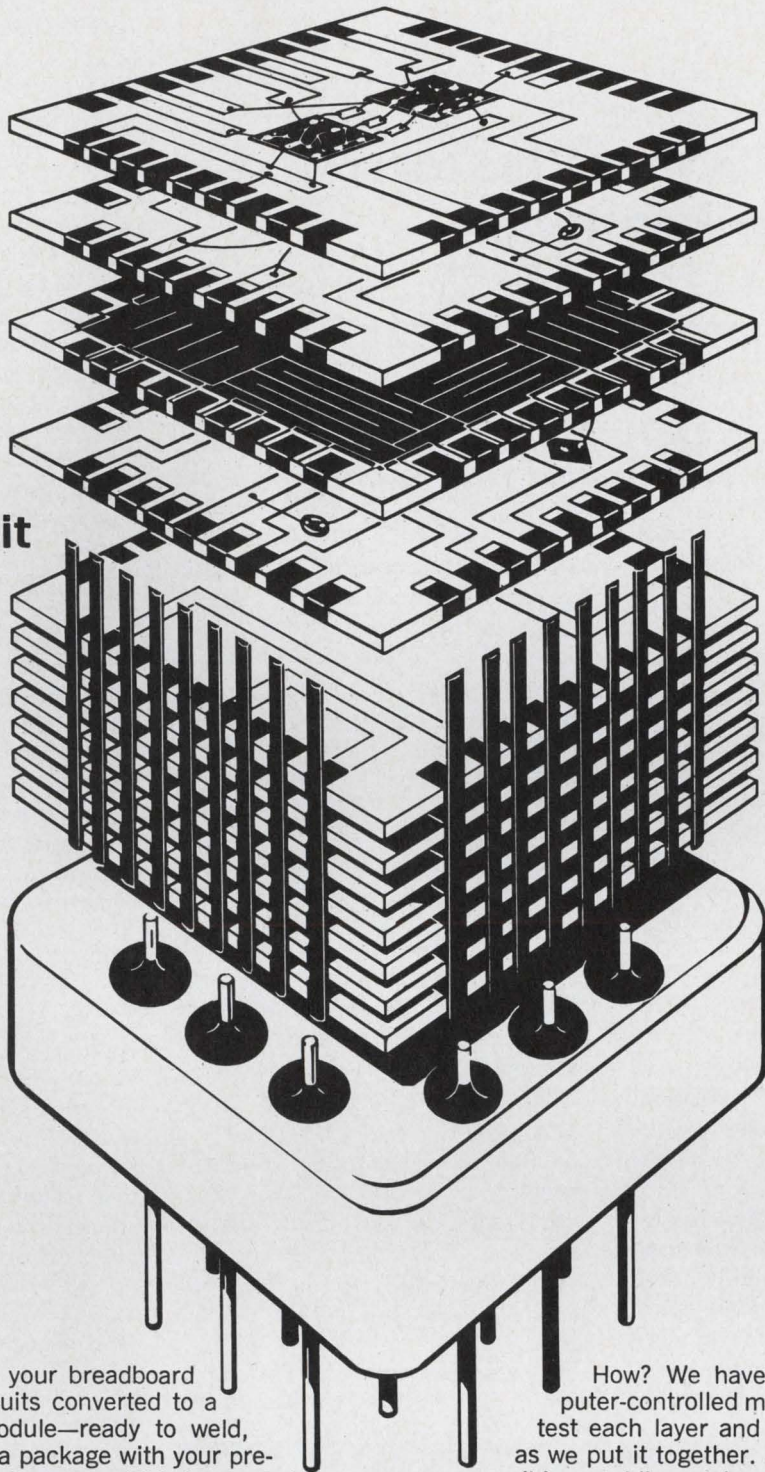

SEE US  
AT  
WESCON

Wouldn't you like to see your breadboard model of functional circuits converted to a fully microelectronic module—ready to weld, solder, or plug in? Want a package with your preferred mix of semi-conductors, monolithic integrated circuits, thin-film and discrete devices ready to perform a number of system functions, either analog or digital—one that combines all the advantages of vertical, multilayer stacking, welded interconnections, hermetically-sealed enclosure, and uniform modular assembly?

That's no pipe dream with Hamilton Standard's MicroCircuit Pack technology. We can deliver a custom-built module of up to 15 ceramic wafers, pretested to meet your design, in either evaluation or production quantities. And it will cost far less than you would think.



Actual size

How? We have developed flexible, computer-controlled methods of manufacture. We test each layer and each module step-by-step as we put it together. And we use electron-beam scribing, welding and sealing under ultraclean vacuum conditions. Results? Your packaged module is strong and reliable, will resist moisture and radiation, and will operate over a wide temperature range.

Whatever your system requirements might be, investigate going to MicroCircuit Packs direct. Consider all the in-between expenses you can save. For more information, price quotations, or assistance in component selection and system layout, contact the Marketing Manager, Electronics Department, Hamilton Standard, Windsor Locks, Conn., 06096. Phone (203) 623-1621, ext. 2012. TWX 710-420-0586.

**Hamilton Standard** DIVISION OF UNITED AIRCRAFT CORPORATION  
WINDSOR LOCKS, CONNECTICUT

U  
A

ON READER-SERVICE CARD CIRCLE 159

# Production line IC testers: lightning strikes twice

Users of integrated circuits should find incoming inspection a lot quicker, easier and cheaper, thanks to two new instruments. For instant go-no go decisions on digital ICs, Teradyne, Inc. is offering its ACT I. For a bit more analysis, Redcor Corp. has the series 990. Both handle up to 16-pin devices, and, both are priced in the \$5000 range.

## ACT I bows

*Teradyne, Inc., 183 Essex St., Boston. Phone: (617) 426-6560. Price: \$4850 (basic), \$100 to \$500 (cards.)*

Dubbed ACT I (Analogical Circuit Technique), Teradyne's new tester performs both functional tests and parameter measurements simultaneously. Operating features include:

- Voltage range of 0 to 8 Vdc.
- Current range of 0 to 50 mA.
- Over-all accuracy of 3 to 5%.

ACT I can do up to 10,000 parameter measurements in 1000 steps in 10 ms. Up to fifteen simultaneous analog measurements can be made at a 10- $\mu$ s logical step.

Programing is done by two 5 x 6-inch cards; one covering all devices within a particular family and grade, the other the individual model. To further simplify programing, Teradyne offers a unique mail-order service: programed cards are avail-

able for most popular ICs, or blank cards are offered with instructions. A pair of DTL cards (Series 846) are included with the basic unit.

The instrument handles circuits comprising up to 10 inputs, up to four outputs, one supply and one ground lead in TO-5, dual-in-line and flat packs.

Testing is completely automatic. No switches, dials, matrices, cross-points, or start buttons exist. Test sequencing occurs continuously. When a circuit is inserted in the test, the reject lamp goes out if the device passes, stays on if it fails. Operators can test at about 400 circuits per hour. A bowl-fed automatic handler will increase the rate to over 7000 per hour. Causes of rejects are displayed on front-panel lamps. Any rejected circuit is stepped through each failed test as the lamps display input and output logical conditions and show whether defects occur at the input, output or supply.

The cards are programed to detect:

- Shorts, opens or one-way shorts.
- Invalid logical outputs, high or low.
- Unacceptable fan-in or out, threshold level and output voltage level.
- Excessive supply current.

CIRCLE NO. 326

## Low-cost accuracy

*Redcor Corp., 7800 Deering Ave., Canoga Park, Calif. Phone: (213) 348-5892. P&A: \$4950, (taut-band meter), \$900 extra (DVM); Aug.*

Like Teradyne's, Redcor's tester can handle all digital ICs. With the same 0.1% power supply accuracy and regulation claimed for it as for \$50,000 systems, the unit includes a pulse generator, constant voltage supplies, constant current supply, a swept constant voltage supply and resistive and capacitive loads.

Unlike the Teradyne tester, the 990 is programed manually with a combination of pushbuttons and digital dial settings.

Its features include:

- A 0-to-100-V voltage range at any one of 4 selectable frequencies.
- A constant 100-mA supply.
- Power supply accuracy of 0.1%  $\pm$ 1 mV.

The 100-mA supplies can either sink or source current, thus maintaining regulation even when terminated through a resistance to a higher potential. With one of the constant voltage supplies used as the 0-to-100-V swept supply, frequencies of 0.5, 5, 50 or 500 Hz can be selected.

The pulse generator allows functional testing over a range of 1 Hz to 10 MHz. Redcor feels that this speed is sufficient for 95% of today's ICs. Pulse amplitude is continuously variable from 0 to 3 V on one range, 0 to 10 V on another. Repetition rates are selectable: 1, 10 or 100 Hz; 1, 10 or 100 kHz; or 1 or 10 MHz.

Selectable resistive loads vary in four decades from 10  $\Omega$  to 100 M $\Omega$ , capacitive loads in three decades.

CIRCLE NO. 327

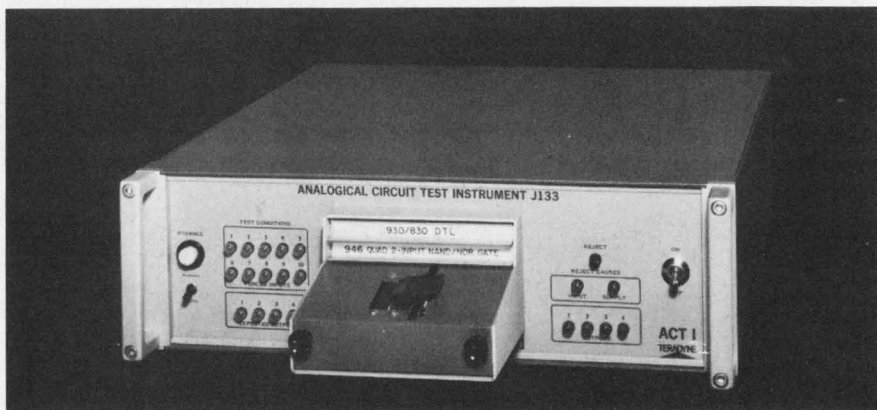

**A potent pair of testers.** Teradyne (left) and Redcor units both handle up to 16-pin digital ICs. Both are priced just under \$5000. Teradyne unit is programed with PC cards,

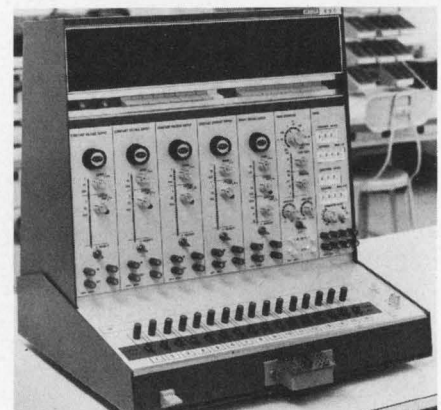

Redcor's model uses a combination of pushbuttons and digital dial settings. Teradyne's ACT I gives an accept/reject decision; Redcor's unit, a direct readout.



**MODERN DESIGN SERIES**  
**MINIATURE**  
**Neon Pilot Lights**

BNE Series  
 BNF Series  
 BND Series

1-piece body ideal for space limitations. BNE SERIES has compact lens system protruding slightly above panel. BNF SERIES' lens system extends more for greater illumination. BND SERIES' pilot assembly protrudes beyond panel to provide maximum light intensity. Write for details.

**ALCO® ELECTRONIC PRODUCTS, INC.**  
 LAWRENCE, MASSACHUSETTS

ON READER-SERVICE CARD CIRCLE 160

**COMPACT**  
**NUMERIC**  
**READOUTS**  
 AT REASONABLE PRICES

Displays 0-9 numerals by illuminating miniature lamps. Combination of lamps can be controlled with a matrix circuit (not supplied). Decimal points can be used as colon when 2 units are placed together. Indicator provides high illumination with a low voltage and current. Colored filters available. 6 & 12V. Figures 25/32" high. 20,000 hr. bulb life.

**ALCO® ELECTRONIC PRODUCTS, INC.**  
 LAWRENCE, MASSACHUSETTS

PRICES start at \$9.95  
 Quantity prices available

ON READER-SERVICE CARD CIRCLE 161

**CAST**  
**A**  
**GIANT**  
**SHADOW**

LE270295

Cool your "overheat" problem! Get the Littelfuse miniature heat fuse for thermal overload protection. 7/8" long x 7/64" dia. Fully insulated. Crimp style connections.

**LITTELFUSE**  
 DES PLAINES, ILLINOIS

ON READER-SERVICE CARD CIRCLE 162

ELECTRONIC DESIGN 14, July 5, 1967

**Reduce Hybrid Circuits With ...**

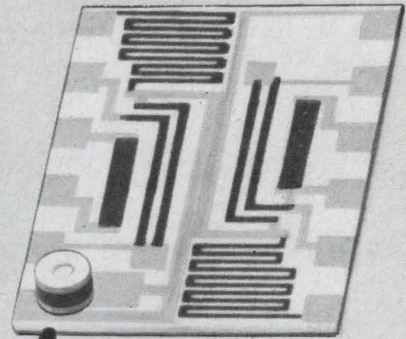

**PYROFILM**  
**MICROMINIATURE**  
**METAL FILM**  
**PELLET**  
**RESISTORS**

Pyrofilm's microminiature pellets introduce a completely new resistor concept and capability. Pyrofilm's pellet resistors reduce hybrid circuit size and are used in all microcircuit designs including: flat packs, microwave loads and attenuators, temperature compensated transistor circuits, load resistors, and offer

- Lower T.C.
- Better Stability
- Tighter Tolerances
- Solderable Terminals
- Low Voltage Coefficient
- Higher Resistance Values
- Good R.F. Characteristics
- Sizes .100" x .062" to .050" x .030"

Write for detailed Pellet Resistor bulletin.

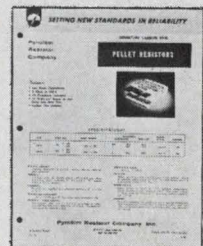

**PYROFILM**  
**RESISTOR**  
**COMPANY, INC.**

3 SADDLE ROAD • CEDAR KNOLLS, N. J.  
 (201) JEFFERSON 9-7110

ON READER-SERVICE CARD CIRCLE 163

**ATLAS**

Turned and  
Precision Ground

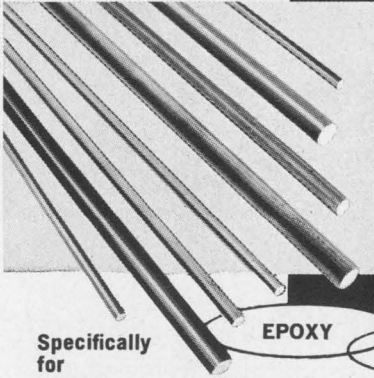

# PHENOLIC RODS

STOCK SIZES  
OR  
CUSTOM-MADE

Specifically  
for

EPOXY

BAKELITE

Glass Supported  
TEFLON

## RELAY and SWITCH applications

- Most sizes available for immediate delivery
- Stock sizes in any diameter from 1/2" to 3/8"\*
- Increments of .001" at no extra charge
- Unsurpassed accuracy guaranteed to  $\pm .001$ "\*

**COMPLETE  
FACILITIES  
FOR  
FABRICATION**

Atlas guarantees unequalled accuracy in the precision fabrication of parts from any of these materials. Send your blueprints and specifications for a prompt quote without any obligation.

\*Larger sizes and closer tolerances quoted on request.

**SEND FOR COMPLETE PRICE LIST**

**ATLAS FIBRE COMPANY**  
6970 N. Central Park Avenue  
Chicago, Illinois 60645

ON READER-SERVICE CARD CIRCLE 164

## Having Problems Ordering Cables?

CONTACT  
SOUTH BAY

Having problems with wire and cable delivery?

South Bay is capable of exceptionally rapid shipment of a wide variety of MIL-SPEC wires and cables.

Unique constructions made to your specifications or ours.

Quantity is no problem; large or small... call or write for immediate attention to your requirements...

**SOUTH  
BAY**



**CABLE CORP.**

17360 Gramercy Place • Gardena, California

ON READER-SERVICE CARD CIRCLE 165

## PRODUCTION EQUIPMENT

### Test transistors quickly from dc to rf

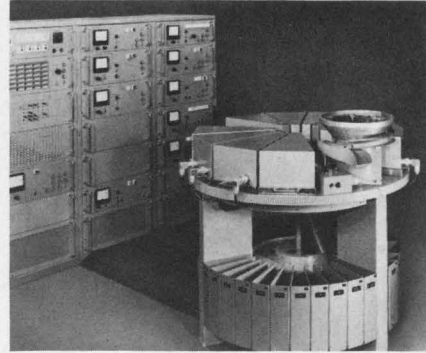

*Kulicke & Soffa, 135 Commerce,  
Fort Washington, Pa. Phone: (215)  
646-5800. P&A: \$40,000 to \$65,000;  
120 days.*

Series 2000 testers automatically handle and check transistors at rf frequencies up to 200 MHz, at a rate of 2000 transistors per hour. The unit performs a go/no-go test sequence of dc, pulsed dc, ac, and high-frequency tests. Parameters tested include  $I_E$ ,  $H_{FE}$ , power gain matching,  $F_T$ ,  $h_{FE}$ ,  $V_{CE(sat)}$  and  $V_{BE(sat)}$ . Fully automatic handling is provided for TO-3, TO-5, TO-18 and various plastic types.

CIRCLE NO. 328

### Adjustable assembly aids soldering

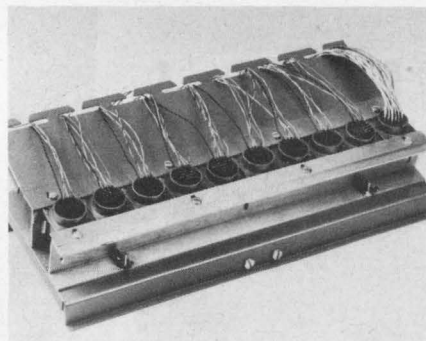

*Siks Manufacturing, Inc., 501 E.  
185 St., New York. Phone: (212)  
892-8566. Price: \$29.95.*

An adjustable soldering and assembly aid adapts to a variety of connector shapes, pc boards, switches and terminal boards. The device can be varied to allow different types of electrical and mechanical assembly operations. It is adjustable in height and width. The tool also provides support for loose wires during assembly or soldering and it prevents wire holder damage.

CIRCLE NO. 329

# Thank goodness we have competition in miniature power regulation.

## Now we can say we're No. 1

But more important — now you can say it:

Because we were first to enable you to build a precision power supply in minutes — using any DC power source.

And because now we've gone ahead and upped your capability 104 times.

You can choose from 104 different super/reg<sup>®</sup> precision miniature regulators — both shunt and series versions. Just connect rough DC from whatever source you have — semi-filtered, half-wave rectified transformer output, or even a battery — you get instant precision DC power where you need it: at the load itself.

Each super/reg power regulator is uniquely de-

signed for maximum heat transfer and power-handling ability. Ultra-compact configurations provide maximum flexibility over a wide range of voltage levels. Point-of-load installation eliminates distribution-line losses and cross-talk.

Write for complete data sheets and applications bulletins.

Make us prove our #1 claim — we'll be happy to do it 104 ways.

Trio Laboratories, Inc.,  
Plainview, L.I., N.Y. 11803.  
Tel: (516) 681-0400.

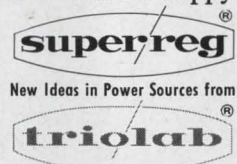

**Type 75TE Shunt Regulator**

- 75 Watt or 3 Amp capability
- Output voltages from 3.9-56 Volts
- .01% Regulation — output Z from .002 ohms
- Hermetically sealed TO-36 case

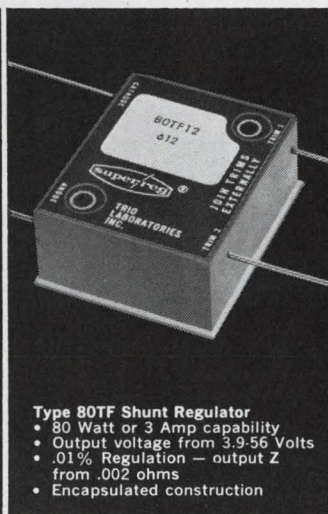

**Type 80TF Shunt Regulator**

- 80 Watt or 3 Amp capability
- Output voltage from 3.9-56 Volts
- .01% Regulation — output Z from .002 ohms
- Encapsulated construction



**Type 1AP Series Regulator**

- Economy priced
- Output voltages from 5-24 Volts
- 1% Regulation — output Z from .06 ohms
- Full 1 Amp load capability

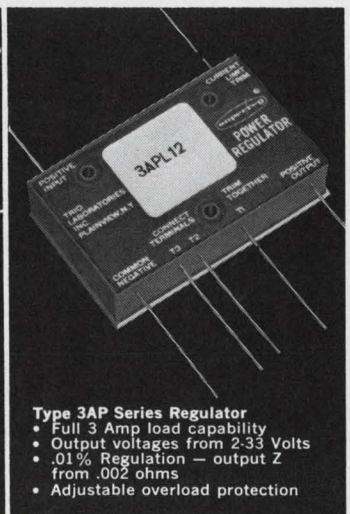

**Type 3AP Series Regulator**

- Full 3 Amp load capability
- Output voltages from 2-33 Volts
- .01% Regulation — output Z from .002 ohms
- Adjustable overload protection

ON READER-SERVICE CARD CIRCLE 166

**Push-pull, push-pull, push-pull, push-pull,  
push-pull, push-pull, push-pull, push-pull,  
push-pull, push-pull, push-pull, push-pull,  
push-pull, push-pull, push-pull, push-pull,  
push-pull, push-pull, push-pull, push-pull,  
push-pull, push-pull, push-pull, push-pull.  
That's the monotony of reliability.**

Monotonous reliability characterizes IMC's solenoids, even at 4 millisecond speeds. There's a whole catalog of them in stock at IMC's Western Division, in sizes and configurations for avionics, instrumentation, computer peripherals and other systems.

If you need to push-pull, or to Indicate, Measure, and Control using steppers, synchros, resolvers, flag indicators or solenoids, contact the Applications Section at 6058 Walker Ave., Maywood, Calif., 90270. Phone (213) 583-4785 or TWX 910 321 3089.

For the catalog or data sheets contact the Marketing Div., 570 Main St., Westbury, N.Y. 11591 or circle the inquiry number.



ON READER-SERVICE CARD CIRCLE 167

## Why you won't get burned with an IMC vaneaxial fan.

**Airmoving** capability. A vaneaxial fan is the most versatile of all the airmovers. It has a high aerodynamic efficiency over a wide range of specific speeds and offers the lowest noise level of any airmover when used properly. Primarily because of high efficiency. Delivers exceptionally well against high back pressures. **Mechanical** and other advantages. Long life—the motor is cooled by the air passing over it. Exceptionally good resistance to shock and vibration because there are no overhanging



parts. Good mechanical balance. Because of the rigidity of the moving parts and easy mounting in duct work (can be flanged at both ends). **Cost** is competitive with other types. **Competence.** IMC designs and produces the entire airmover (motors, impellers, housings, gas bearings) to the demanding requirements of the Minuteman, TFX, and other advanced projects. We also produce standard vaneaxials ranging from the IMCube (1-inch cube) to real big blasters, producing thousands of cfm.



IMC Magnetics Corp., Eastern Division, 570 Main St., Westbury, N.Y. 11591  
Phone (516) 334-7070 or TWX 510 222-4469

ON READER-SERVICE CARD CIRCLE 168

## PRODUCTION EQUIPMENT

### Aluminum plates cool high-density gear

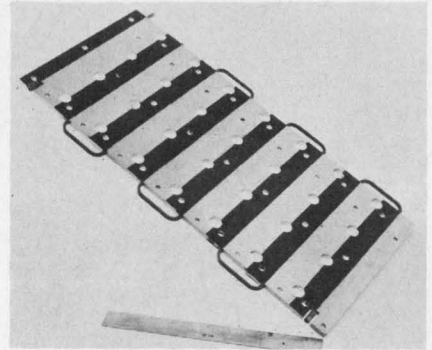

*Lytron, Inc., 71 Pine St., Woburn, Mass. Phone: (617) 933-7300.*

Precision cold plates for removing heat from high watt-density equipment are fabricated of aluminum with copper tubing. Typical specifications call for flatness within 0.0005 inches, including the dielectric segments. Dielectric strength of 300 to 500 MΩ at 500 Vdc is maintained and dielectric deposition is held to within 0.005 inches between segments.

CIRCLE NO. 330

### Flat packs, dual-in-lines tested in carriers

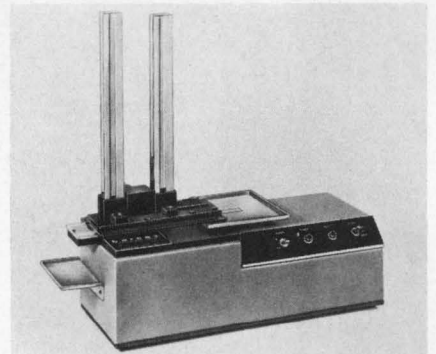

*Barnes Development Co., Lansdowne, Pa. Phone: (215) 622-1525. P&A: \$2395; 4 to 6 wks.*

For high-speed testing, this test handler accepts flat-pack and dual-in-line ICs in carriers. Accepting carriers manually loaded or from magazines (up to 150 units per 20-inch magazine), the handler will accommodate flat-pack devices with up to 14 leads, in sizes ranging from 1/8 x 1/4 to 3/8 inch and standard 14 or 16-lead dual-in-line packages. Typical test rates are up to 6000 devices per hour.

CIRCLE NO. 331

ELECTRONIC DESIGN 14, July 5, 1967

# Shhh!

Bodine has made  
a quiet motor...  
quieter

with noise-damped ball bearings...  
the next best thing to dead silence.

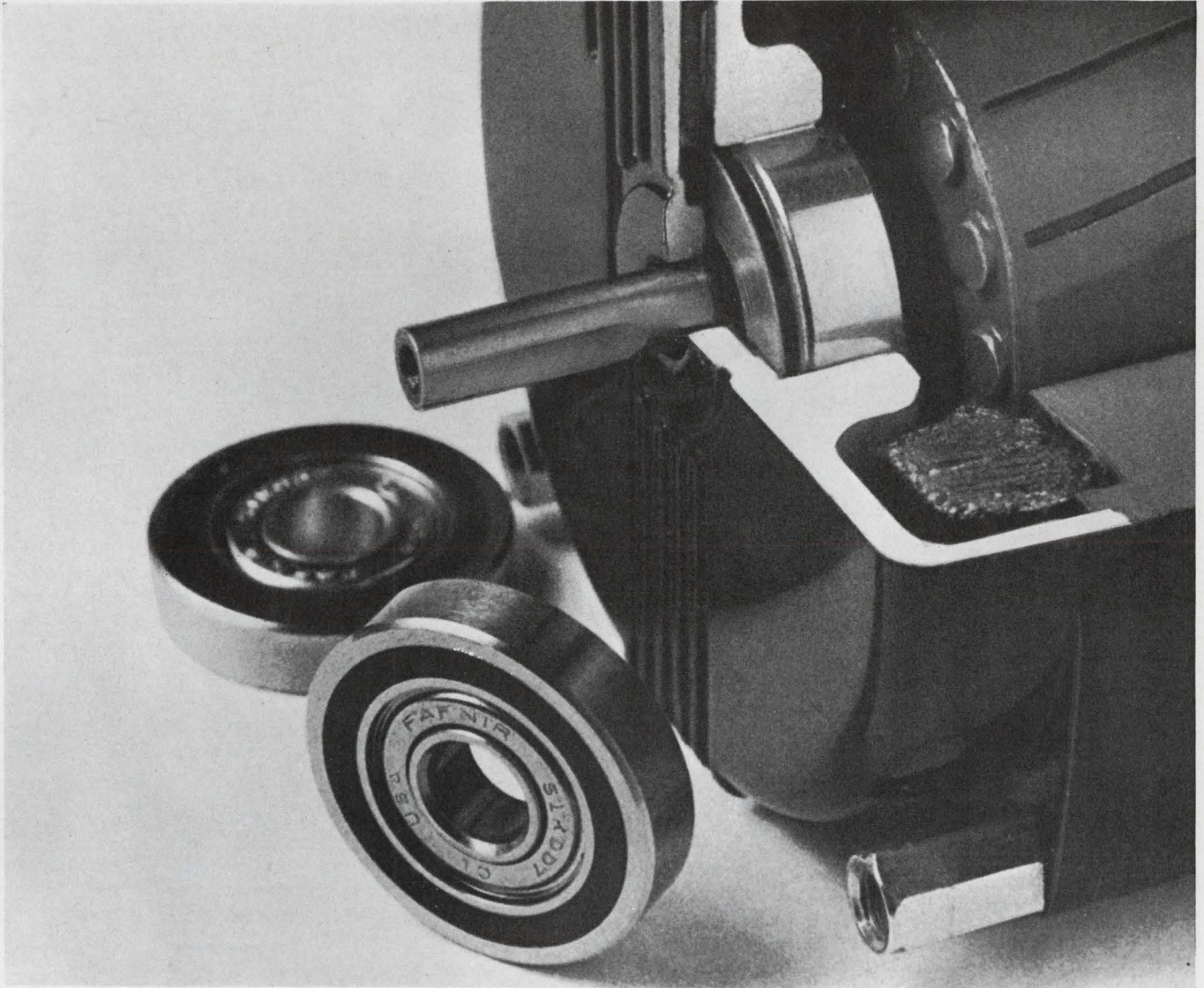

Bodine's K-2 fractional horsepower motor is now available with a special noise-damped ball bearing for equipment where extra-quiet operation is a must... equipment like medical instruments or sound recorders—where sound levels are especially critical.

Super-silent is the word for this new, noise-damped bearing. It's made with a unique combination of rubber and steel rings. A 1/16" thick rubber ring is bonded to the outside of the bearing—then a steel ring is bonded to the outside of the rubber ring. It is lubricated with low-torque-loss grease.

Result: What little sound there is in standard K-2 motors is reduced to a new low level.

Bodine K-2 motors and reducer motors are available from 1/2000 to 1/270 hp, synchronous or non-synchronous—and with spur or helical reduction gearing. Write for data sheet on this modification... and for bulletin S which describes over 275 stock types and sizes of Bodine motors—from 1/2000 to 1/6 hp.

Bodine Electric Company, 2528 West Bradley Place, Chicago, Illinois 60618.



*Bodine motors wear out—  
it just takes longer*

**BODINE**  
fractional/horsepower  
**MOTORS**  
...the power behind the leading products

ON READER-SERVICE CARD CIRCLE 169

# Second-generation IC op-amp: compensation in 30 puffs

National Semiconductor Corp., Microcircuits Div., 2950 San Ysidro Way, Santa Clara, Calif. Phone: (408) 245-4320. P&A: \$40 (MIL), \$8.80 (commercial), (100-up); stock.

Significant improvements over the industry-standard 709 monolithic operational amplifier have been made. National Semiconductor Corp., manufacturer of the new operational amplifier, reports the following advantages for its LM101 over the 709:

- Simplified frequency compensation (only a 30-pF capacitor is used).
- Wider ( $\pm 5$ -to- $\pm 20$ -V) supply voltage range.
- Higher (80,000 to 200,000) open-loop gain.
- Halved power consumption.
- Doubled input impedance.

Worst-case specifications for the two units at 25°C ambient and a 15-volt supply voltage are compared in the table. The new unit is available in MIL ( $-55^\circ$  to  $+125^\circ\text{C}$ ) or commercial ( $0^\circ$  to  $75^\circ\text{C}$ ) types.

One frequent objection to mono-

lithic operational amplifiers is the complexity of the frequency-compensation networks. Often these external networks physically dwarf the amplifier and double the number of interconnections needed. The LM101 overcomes this. It needs only a single 30-pF capacitor and a feedback resistor. Collector load resistors have also been designed out, so that the input stage can be operated at low currents. The LM101 simplifies compensation circuitry since it is a 2-stage, rather than a 3-stage circuit. It develops its high gain by using current sources, rather than resistors, as collector loads. Substituting transistors for resistors removes limitations on operation at low current levels. Also, transistors occupy far less chip surface area than large-value resistors (the 45-by-45-mil LM101 chip is about 20% smaller than the 709). The circuit can then be compensated with the simple RC network. The location of the compensation network and the fact that the input stage is run at low currents account for the puny 30-pF

compensation capacitor. The amplifier is stable for all feedback configurations, even capacitive loads.

The voltage-follower and the inverting amplifier shown below illustrate the simplicity of LM101 circuit designs. Even though fewer compensation components are used, the device has the same pin-for-pin configuration as the 709.

Other advantages are inherent in the new design. Unpredictable operation, which can occur with some amplifiers when they are driven outside their common-mode range, is eliminated. More controlled short-circuit protection is provided and the slewing rate has been improved.

The  $\pm 30$ -V differential input voltage range along with the ability to clamp the output at any desired level makes the amplifier useful as a voltage comparator.

The class-B output—with continuous short-circuit protection—provides at least a  $\pm 10$ -V output swing with a 2-k $\Omega$  load. And, the  $\pm 30$ -V differential input range reduces the chance of burnout from overloads.

It is no mere chance that makes the LM101 a pin-for-pin replacement for the 709. The designer responsible for the LM101 has some background in linear ICs. In fact, it was Bob Widlar who evolved the 709, while with Fairchild Semiconductor two years ago.

What's next? Widlar might even put the capacitor right on the chip!

CIRCLE NO. 332

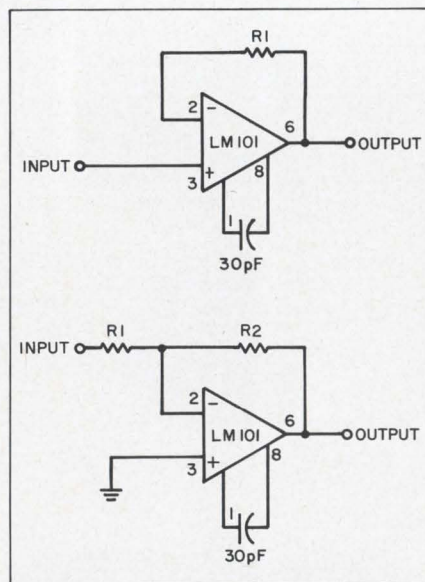

A resistor and 30-pF capacitor are all the compensation needed. Circuits are voltage-follower above and inverting amplifier below. R1 above is zero or equal to source resistance.

## Worst-case LM101 and 709 specs compared

Specification	709	LM101
Input offset voltage	5 mV	same
Input offset current	200 nA	same
Input bias current	500 nA	same
Input impedance	150 k $\Omega$	300 k $\Omega$
Input common-mode range	$\pm 8$ V	$\pm 12$ V
Common-mode rejection	90 dB	same
Voltage gain	25,000	same
Output voltage swing		
$R_L = 10$ k $\Omega$	$\pm 12$ V	same
$R_L = 2$ k $\Omega$	$\pm 10$ V	same
Power consumption ( $\pm 15$ V)	165 mW	75 mW
Power supply rejection	150 $\mu\text{V}/\text{V}$	same
Unity-gain bandwidth	500 kHz	same
Slewing rate	0.25 V/ $\mu\text{s}$	0.5 V/ $\mu\text{s}$
Temperature drift	3 $\mu\text{V}/^\circ\text{C}$	3 $\mu\text{V}/^\circ\text{C}$
Supply voltage range	$\pm 9$ to $\pm 15$ V	$\pm 5$ to $\pm 20$ V

“ I don't want to be a fink, but let me tell you what goes on inside Deutsch Subminiature Connectors. I've got nothing to lose: I'm expendable. That's what they call me—an inexpensive, plastic, expendable insertion/removal tool. And I've been in and out of more Deutsch Subminiature Connectors...well, there are Push-Pull, Bayonet Couplings, Rack and Panel, and Rectangular types. My job is to insert and lock in place—or unlock and remove—terminations from the wire side. And I can handle pin or socket contacts. (The wires are prepared with one standard crimping tool.) I do the job in seconds...and I do it with no other tools to help me. Of course, there's the assembly personnel...but they learn to work with me in no time at all. The speed with which I work eliminates error. And I've never damaged a connector yet: because I insert the terminations from the wire side, the interface is never touched; and because I'm made of plastic, I'd snap before I harmed the termination device. After I've pushed in the termination, tangs snap in behind a shoulder, securing it inside. Each cavity has a triple-seal to give extra protection against moisture and contaminants. The results are trouble-free, easy to maintain and easy to inspect. Deutsch Subminiature Connectors offer savings in weight and space, without loss of reliability. (For density they can't be beat.) They're completely environmental; available with hermetic receptacles; and meet or exceed existing Mil Specs. And with me on the job, there's no faster way of making terminations. There is a complete line of Deutsch wire-side release products including terminal junctions, feed-throughs, Jiffy Junctions<sup>®</sup>, adaptor junctions and component terminations. For more information write Deutsch, Electronic Components Division, Banning, Calif. ”  
Do it now. (Being an expendable tool, I might not be here next week.)

DEUTSCH 

SUBMINIATURE CONNECTORS

ON READER-SERVICE CARD CIRCLE 183

All the necessary controls and supervisions may be performed by you alone!

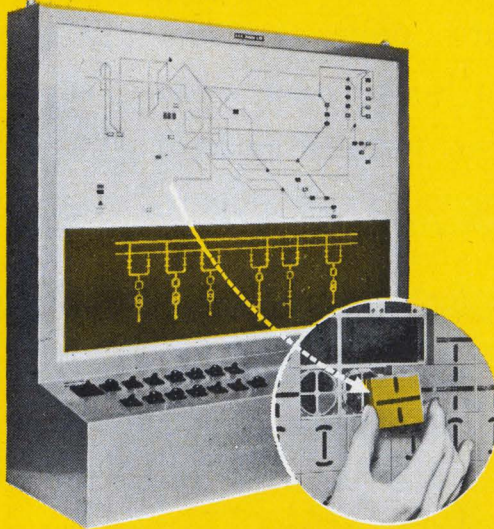

## LUMIBLOCK MOSAIC PANEL



**K.C.C. SHOKAI LTD.**

Head Office: No. 71, 4-chome Nadakita-dori, Nada-ku, Kobe, Japan  
Tokyo Office: No. 212, 2-chome Nishi-Okubo, Shinjuku-ku, Tokyo, Japan  
Cable: WMKCC KOBE Telephone: Kobe: (87)0271-3 Tokyo: (369)4111  
American Liaison Office: M. Kuroda, 1367 33rd Avenue San Francisco  
Representative: Western Switch-Board Co., Ltd. San Francisco

K.C.C. WIRE MARKER TUBING



### Principles

This switchboard, being equipped with multifarious standardized indications, and with the flow sheet applicable in accordance with the development of the plant construction, is capable of constantly supervising all such factors as the working conditions of the generator for the electric circuit, the working conditions of the branching system or an apparatus related thereto, the height and the direction of flows of filled materials in the vessel, and many other operational characteristics as a whole.

It is possible to mutually interchange the standardized constituents. Moreover, the range of indications by means of illumination is quite wide, the Lumiblock diagram is peculiarly well fit for numerous applications in various fields of industries.

In other words, Lumiblock may be advantageously used for the purpose of controls of power plants, mining industries, railroads, metallurgy, air fields, chemical plants, water-line pumps, etc.

### Methods of Applications.

The switchboard of this company is completely wired within, and is provided with the terminals, by means of which it is coupled with the exterior wirings.

This is an instrument furnished independently, not attached to other implements, or else, it is provided by arranging it in the shape of a board and in the form of a table.

These switchboards of this company are favorably received by the the company customers in France, England, Germany, Belgium, Italy, Switzerland and many other countries of the world to their entire satisfaction.

●For further details of the company's products, you are welcome to apply for a catalog.

ON READER-SERVICE CARD CIRCLE 184

## Order Compack Controllers from Stock

Save Space,  
Time,  
Money

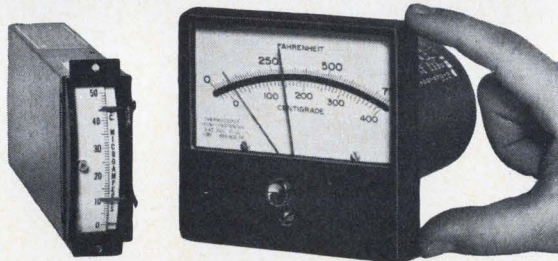

Everything about API Compacks is easy. They're space-saving controllers that simplify your design. You connect them quickly to any unamplified signal—AC, DC or temperature.

*In-stock Compacks come in the following general ranges:*

**NON-TEMPERATURE:** 0-10 to 0-100 microamperes DC, 0-1 to 0-50 milliamperes DC and AC, 0-10 and 0-50 millivolts DC. Special motor control range of 0-5 amperes AC. Single or double set point. On/Off, Cycling or Limit.

**PYROMETERS:** 0-300°F to 0-2500°F. Single or double set point. On/Off, Time proportioning or SCR Driver output.

Select upright-type Compack I or edge-reading Compack II, whichever suits you better.

Ask for: Bulletin 48 (non-temperature), Bulletin 49 (pyrometer models)

**api** INSTRUMENTS CO.  
CHESTERLAND, OHIO 44026 (CLEVELAND-216) 729-1611 • TWX: 810-427-9230

ON READER-SERVICE CARD CIRCLE 185

## MICROELECTRONICS

### Thin-film thermistors compatible with ICs

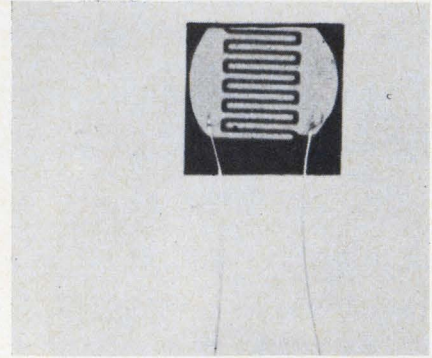

Victory Engineering Corp., Springfield Ave., Springfield, N. J. Phone: (201) 379-5900.

The A-thinistor, a deposited oxide thin-film thermistor, makes possible the production of temperature-compensated integrated circuitry without the use of discrete components. The thin-film thermistors are completely compatible with all types of integrated circuits. The deposited oxide unit is made by low-energy sputtering a bulk multiple oxide thermistor directly onto any one of a variety of substrates. The film properties very closely approximate the properties of a bulk thermistor. Satisfactory results are obtained with film thicknesses ranging from a few hundred to a few thousand angstroms. With the aid of suitable masks, the zero power resistance at 25°C may be adjusted to fall in the range of 1 kΩ to 5 MΩ.

Units have been sputtered successfully on substrates of beryllium oxide, aluminum oxide, quartz, aluminum foil and nickel foil. By proper adjustment of the sputtering parameters, as well as location in the bell jar, it is possible to maintain a substrate temperature of 70° to 80°C. Thus, the monolithic integrated circuit can be temperature-compensated as a last step without affecting the other components during the process.

Major fields of application are integrated circuit temperature compensation, measurement and control, surface temperature measurement and IR bolometry.

It is impossible to heat the film without heating the surface. Thus, there is no measurable lag when the film is used for surface measurement.

CIRCLE NO. 333

ELECTRONIC DESIGN 14, July 5, 1967



## Threshold-trigger multi for O-TC timers

Raytheon Co., 350 Ellis St., Mountain View, Calif. Phone: (415) 968-9211.

A threshold-triggered monostable multivibrator is designed for use with zero-temperature-coefficient timing components. The RM 288 has a good pulse-width stability from  $-55^{\circ}$  to  $+125^{\circ}\text{C}$ . Its temperature coefficient is guaranteed at  $0.005 \mu\text{s}/^{\circ}\text{C}$  ( $\pm 2\%$ ) for an output pulse width of  $50 \mu\text{s}$ . The device is available in four package configurations: 10-pin Q, 12-pin T, 14-pin dual-in-line and 14-pin J. It is compatible with 200 and 930 series ICs.

CIRCLE NO. 334

## Sense amplifier is monolithic, thin-film

Halex, Inc., 139 Maryland St., El Segundo, Calif. Phone: (213) 772-2545.

Thin-film and monolithic technologies have been combined to produce high-density packaging and improved performance in a new sense amplifier. The sense amplifier consists of an integrated circuit ( $\mu\text{A}711$ ), a thin-film input threshold circuit and a thin-film transistor output stage to improve over-all characteristics. Three sense amplifier circuits are contained in a single  $3/8 \times 3/8$ -inch 14-lead flat pack.

CIRCLE NO. 335

## Dipped mica caps operable to $125^{\circ}\text{C}$

Aerovox Corp., 742 Belleville, New Bedford, Mass. Phone: (617) 994-9661.

Designed for printed wiring and general-purpose applications, plastic-coated, dipped mica capacitors are available with radial leads. The units are available in five different models and 63 different types with capacitances ranging from 150 to 15,000 pF. Temperature range is  $-55^{\circ}$  to  $125^{\circ}\text{C}$  and tolerances are  $\pm 20$ ,  $\pm 10$ ,  $\pm 5$ ,  $\pm 3$ ,  $\pm 2$  and  $\pm 1\%$ .

CIRCLE NO. 336

# NEW!

**DRIVE  
THESE  
ULTRA  
SENSITIVE  
REED  
RELAYS ...**

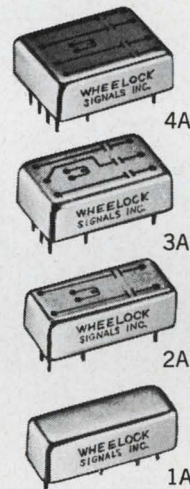

ACTUAL SIZE

**Directly  
from  
YOUR I.C.'s**

Wheelock announces a new generation of reed relays with the 442S Series. They are sensitive enough to be activated with I.C.'s, eliminating expensive driver stages . . . small enough to allow 40 2-pole relays to be mounted on a  $4\frac{1}{2}'' \times 5\frac{1}{2}''$  pcb.

- Operates on 60 milliwatts power
  - Contacts Rated at 7 watts
  - Occupies 0.05 cubic inches per pole
- PC board mount

BY *Wheelock* OF COURSE

Contact Wheelock first for any of your relay design problems.

**WHELOCK SIGNALS, INC.**  
273 Branchport Avenue  
Long Branch, New Jersey 07740  
(201) 222-6880

Write for detailed literature on the new 442S Series



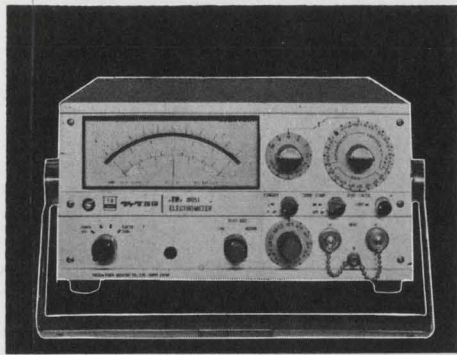

# UNANNOUNCED NEW ELECTROMETER -TR- 8651 FOR EASY AND HANDY MEASUREMENT

## FEATURES:

**-TR- 8651 ELECTROMETER** is conveniently used for:

Measurements of ● Semiconductor resistivity ● Insulation ● Piezo-electric charge ● Photo-electric current

**-TR- 8651 ELECTROMETER** measures:

● **Voltage** from 1 mV to 100 V f.s. (11 range) with  $\pm 0.5\%$  accuracy ● **Charge** from  $10^{-12}$  to  $10^{-5}$  coulomb f.s. ● **Current** from  $10^{-14}$  to 0.3 A f.s. ● **Resistance** from 100 to  $10^{14} \Omega$  f.s.

## SPECIFICATIONS:

### RANGE:

● **Voltage:** 1, 3, 10, 30mV, 0.1, 0.3, 1, 3, 10, 30 and 100V f.s. ● **Charge:**  $10^{-12}$  to  $10^{-5}$  coulomb f.s. (1× and 3× overlapping ranges) ● **Current:**  $10^{-14}$  to 0.3 A f.s. (1× and 3× overlapping ranges) ● **Resistance:**  $10^2$  to  $10^{14} \Omega$  f.s. on linear 1× and 3× overlapping ranges.

For further details, write to:



**Takeda Riken  
Industry Co., Ltd.**

285, Asahi-cho, Nerima-ku, Tokyo,  
Japan Cables: TRITRONICS TOKYO  
Phones: 930-4111

ON READER-SERVICE CARD CIRCLE 187

## MICROELECTRONICS

### Hybrid ICs for TV, audio use

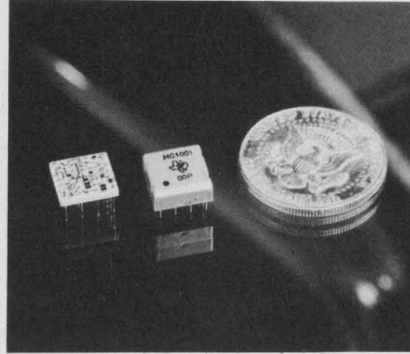

Texas Instruments, Inc., P. O. Box 5012, Dallas. Phone: (214) 238-3741.

Five hybrid integrated circuits are aimed at TV, radio and phonograph applications. One of the new units, reportedly the first for TV, is an fm sound system module, combining the functional equivalent of 30 components. The other units are four audio-output devices for radios and phonographs requiring 300 mW to 1 W. All combine individual inverted silicon transistor, diode and capacitor chips with thick-film resistors.

The fm module, designated HC1001, combines a wideband i-f amplifier, an fm detector, and an audio preamplifier in a 0.5-by-0.5-by-0.2-inch package. It is designed to accept 4.5-MHz TV i-f signals. Both a high-impedance output (35 V p-p) to drive standard vacuum-tube audio power stages and a low-impedance output (0.3 V rms) to drive transistorized audio outputs are included in the single unit. Audio from the IC's two-stage amplifier needs no preamplification for driving high-power transistor or tube outputs. The circuit's output stage can serve either as an emitter-follower for driving an external bipolar output, or as a common-emitter for driving a vacuum-tube output. A-m rejection is 35 dB, so that electrolytic capacitors usually found in detector circuits are not needed. Limiting sensitivity is 300  $\mu$ V, about half that of comparable circuitry.

The series of audio ICs includes low-input-impedance (1 k $\Omega$ ) circuits for a-m radios, and high-input-impedance (1 M $\Omega$ ) units for fm radios and phonographs. They deliver a minimum of 300 mW of

audio power, operating from a 9-to-12-V supply. A 40-Vdc supply can power these units as direct coupled amplifiers. For 1-watt systems, either the HC1004 low-input-impedance module, or the HC1006 high-input-impedance unit can be used. They differ only in input circuitry; the HC1004 uses an npn and the HC1006 a FET.

CIRCLE NO. 337

### Monolithic audio amp puts out 2 watts

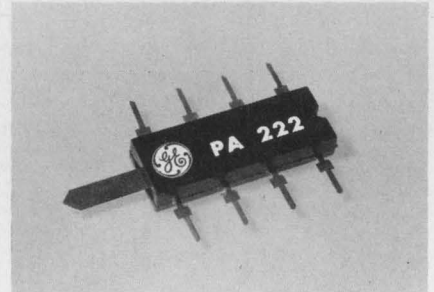

General Electric Co., Semiconductor Products Dept., Electronics Park, Syracuse, N. Y. Phone: (313) 574-2211.

General Electric has again taken the lead in the monolithic audio amplifier power race. One of three new dual-in-line linear ICs from GE, the PA237, has power output capability of 2 watts. It is a high-performance circuit that can be operated from 12 to 26-V power supplies. The device requires fewer stabilization and frequency-shaping components than competitive audio amplifiers.

The PA230 low-level amplifier can be used as either an audio preamp or an operational amplifier. It provides excellent sensitivity, and high open-loop voltage gain. Typical applications include tape cartridge recorders, players, hi-fi equipment, dictating equipment or any audio product that requires low input sensitivity. For higher power output, the PA230 can be used in conjunction with the PA222 (1-watt) or the PA237 (2-watt) audio amplifier. The PA189 i-f amplifier discriminator is designed for operation at 4.5 or 10.7 MHz. Application is primarily within the fm and TV markets. Specific uses include chroma-phase detector, chroma-reference oscillator, chroma-burst gate, quadrature detector, i-f and high-gain amplifiers.

CIRCLE NO. 338

# Resolve to get it.

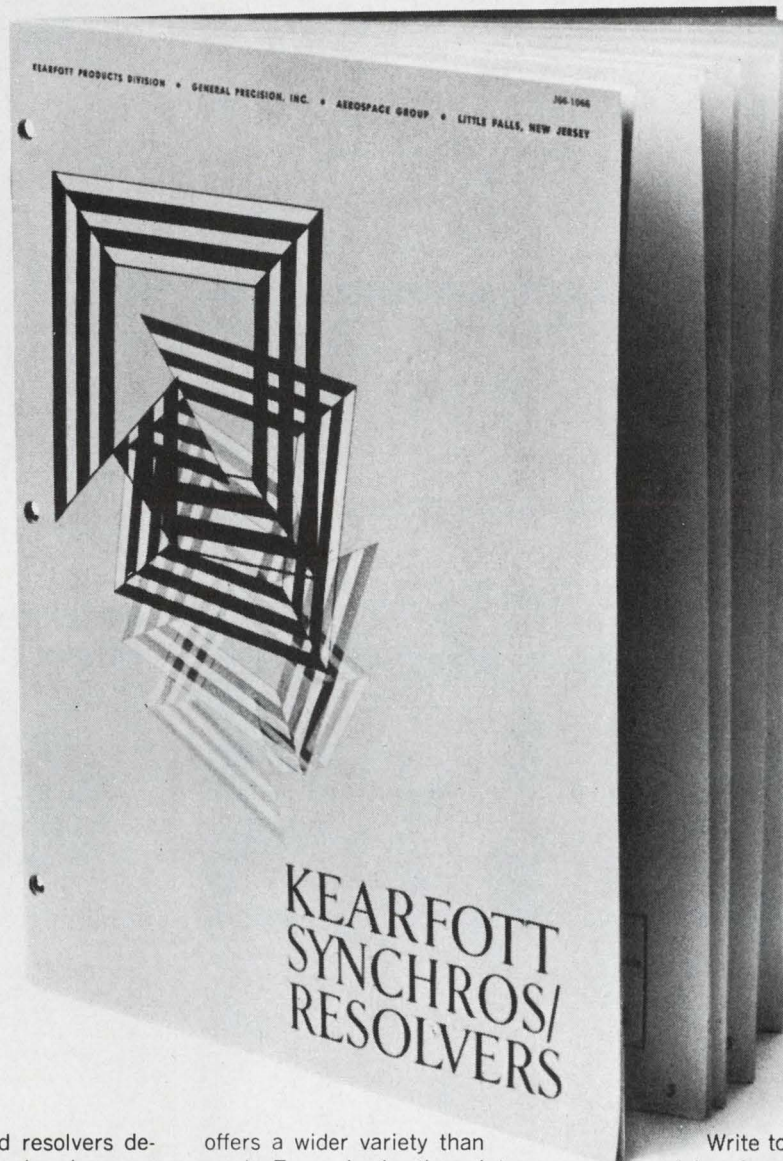

Most of the synchros and resolvers described in this new 32-page brochure are standard only in the sense that they are readily available at competitive prices. Any of the "standard" units can be quickly modified to suit your particular needs, providing thousands of opportunities for you to resolve *your* problems.

These components reflect the highest order of precision in design, construction and performance and are backed by twenty years of Kearfott engineering and production experience.

We don't think you'll find anyone that

offers a wider variety than we do. To emphasize the point, our catalog covers: Synchros, sizes 5 to 25; resolvers, sizes 5 to 28; winding compensated resolvers; resolver-amplifier combinations; multispeed units; transolvers; tandem synchros; custom-engineered units such as geared and gearhead synchros; rotary transformers; goniometers; phase shifters; etc.

Order the catalog. It's loaded with diagrams, dimensional data, electrical characteristics and application data. There's even a section on design basics.

ON READER-SERVICE CARD CIRCLE 188

Write today to: Kearfott Products Division, General Precision, Inc., Aerospace Group, 1150 McBride Ave., Dept. 1450, Little Falls, New Jersey 07424.

**KEARFOTT PRODUCTS DIVISION**

**GP GENERAL  
PRECISION INC.**

**AEROSPACE GROUP**  
LITTLE FALLS NEW JERSEY

A SUBSIDIARY OF GENERAL PRECISION EQUIPMENT CORPORATION.

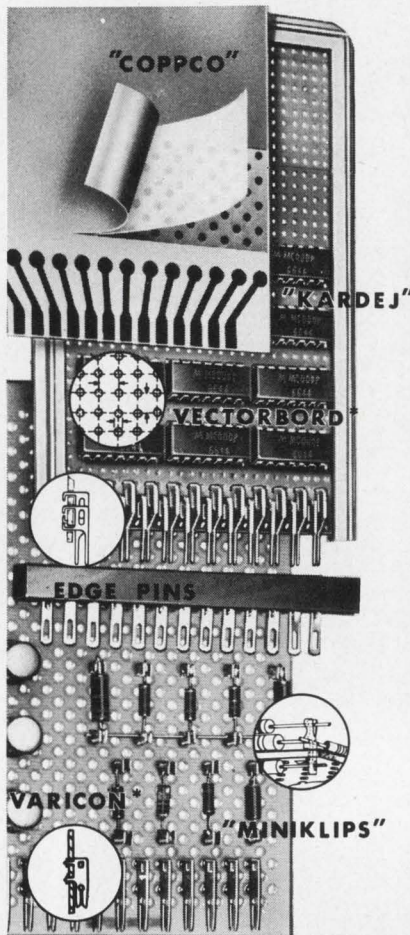

## VECTOR PLUGBORDS CUT CONSTRUCTION TIME

Why drill holes? Use prepunched Vector Plugboards to save time, work, and money.

- New "COPPCO"—Copper plus film plus Vectorbord\*. User "pokes" holes through.
- "KARDEJ"—Aluminum framing stiffens cards 1/32" to 1/16" thick.
- VECTORBORD:\* "P" Type—.042" holes, 0.1" grid for D.I.P.s; "M" Type—.025" holes on .050" grid for I.C.P.s; "G" Type—.062" holes, 0.2" x 0.1" grid for transistors and discrete components.
- EDGE PINS stake to card — fit New "VECTORCONN" receptacles.
- "MINIKLIPS"—Vector "Push Pins" and turned terminals for leads.
- ELCO VARICON\*, 12-47 contacts, or printed tabs.

\*Trademark

For complete information contact:

**Vector**

ELECTRONIC COMPANY, INCORPORATED  
1100 Flower Street, Glendale, California 91201

ON READER-SERVICE CARD CIRCLE 189

## MICROWAVES

### VTM oscillators deliver 500 mW

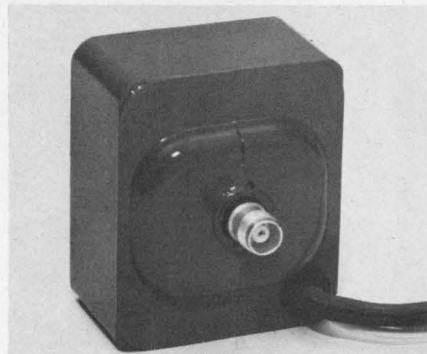

Varian, Bomac Div., 8 Salem Rd., Beverly, Mass. Phone: (617) 922-6000.

Voltage-tunable magnetron oscillators deliver at least 500 mW over 1.5 to 3 GHz. Power output is flat to  $\pm 1$  dB. Linear voltage tuning is accomplished by changing the potential of the anode, which has an FM sensitivity of 1.2 MHz/V. The magnetic circuit used results in a negligible external magnetic field, permitting the tube to contact ferromagnetic materials with no degradation in performance.

CIRCLE NO. 339

### Double balanced mixer weighs 0.2 ounces

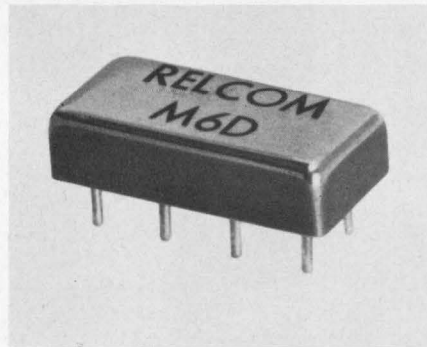

Relcom, 2164 E. Middlefield Rd., Mountain View, Calif. Phone: (415) 961-6265. P&A: \$50; stock.

In an 0.2-oz package, this double balanced mixer has a frequency range from 50 kHz to 200 MHz, with one port extending to dc. Minimum isolation is 45 dB at 30 MHz. Maximum conversion loss is 6.5 dB ssb at 50 MHz. Maximum noise figure is 6.5 dB at 50 MHz and switching time is less than 2 ns. Hermetically sealed and RFI shielded, the entire package occupies 1/16 in<sup>3</sup>.

CIRCLE NO. 340

# COSTS DOWN! WIRE FORMS PRECISION UP!

BY ARTWIRE Art Wire's high speed, automatic machines and production economies mean BIG SAVINGS for you... with guaranteed precision from the first to the millionth unit. Widest variety of wire components, made for today's automatic production lines, delivered on schedule to assure uninterrupted work flow.

Send a Sample or Blueprint for Estimates

Write for catalog.

**ART WIRE AND STAMPING CO.**

17 Boyden Place, Newark, N. J. 07102

ON READER-SERVICE CARD CIRCLE 190

## Step-recovery source is X-band LO

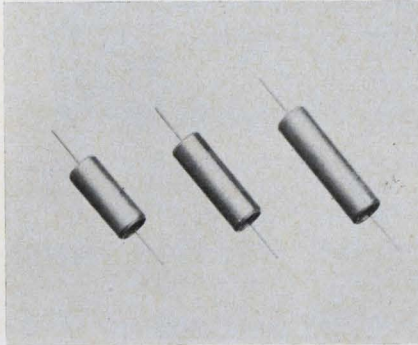

Edwin Industries Corp., Pickard Bldgs., 5828 E. Molloy Rd., Syracuse, N. Y. Phone: (315) 454-4407.

A step-recovery source designed for use as an X-band local oscillator in high-performance receivers has a maximum output of 10 mW at X-band frequencies for a 22-Vdc input. The bandwidth for a minimum of 7 mW is 400 MHz. Spectral purity is better than 60 dB, and noise is of the same order as that produced by a klystron. Varactor tuning is applied over the entire frequency band, and tuning voltage is  $\pm 10$  Vdc. Input is 17.5 to 28 Vdc, depending on required output power.

CIRCLE NO. 341

## Microwave switches insert in coax lines

Hewlett-Packard, 1501 Page Mill Rd., Palo Alto, Calif. Phone: (415) 326-7000. P&A: \$100 to \$175 (1 to 9); stock.

Broadband solid-state switching modules are packaged as coaxial sections that can be inserted as part of a coax line. The structure ensures broad bandwidth (dc to 18 GHz), low insertion loss (0.5 to 2.2 dB) and low vswr (1.5 to 2.3). The hermetically-sealed switching modules can be brazed into coaxial structures or clamped or pressed into place. They match semi-rigid coax lines with 0.141- and 0.188-inch ODs and are adaptable to lines with an 0.276-inch OD. The 50- $\Omega$  modules consist of two or more silicon pin diodes shunting the transmission line in a structure that functionally integrates the diodes and matching network into the line.

CIRCLE NO. 342

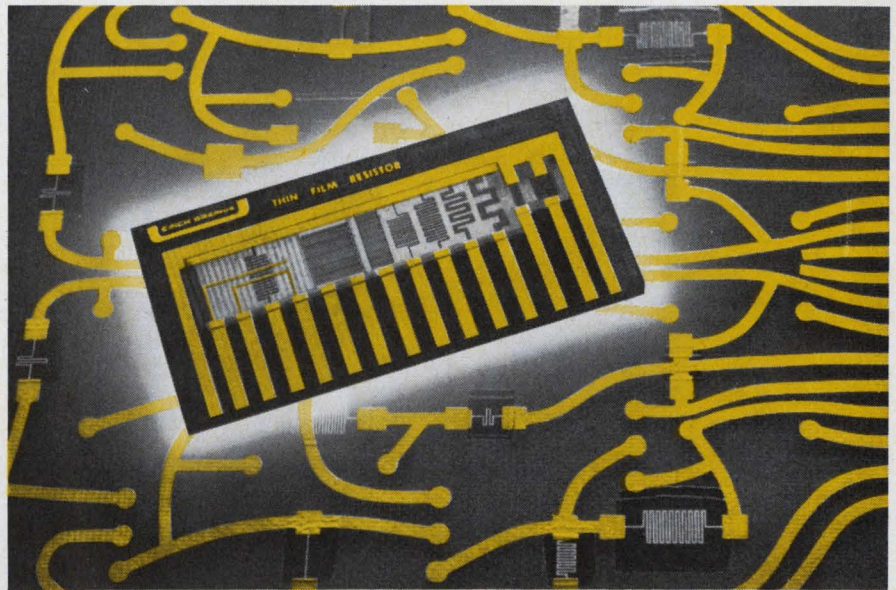

## Now... Thin Film Resistors from Cinch-Graphik

Now you can order thin film resistors as an integral part of the world's finest printed circuits. This Cinch-Graphik innovation offers packaging design flexibility and economy never before possible. These electronically deposited resistance patterns are only 2 millionths of an inch thick. They occupy virtually no space, weigh practically nothing, and are competitive in price and performance with discrete resistors. In addition, Cinch-Graphik's thin film resistors are stable, reliable and have electrical characteristics as good as ordinary resistors. Available in resistance values from 10 $\Omega$  to 150K $\Omega$ , these resistors can be utilized in single or multilayer circuits on standard printed circuit laminates. Other components or conductor paths can be placed directly on top of the thin film resistors.

### Specifications:

Value Range on Single Resistivity	10 ohms-150,000 ohms	(5000 hours @ 75°C @ 2 watts/in <sup>2</sup> )	Drift	always positive
Sheet Resistivity	10 ohms-50 ohms/sq.	Resistor line width and spacing	5 mils min.	Less than 2%
Resistor Tolerances	5%, 10%, 20%	Resistor thickness	600 angstroms @ 50 ohms sheet resistivity.	
Temperature coefficient of Resistance	+80 ppm	Power dissipation	2-4 watts/in <sup>2</sup>	

For additional details or specifications, call, write or wire:

# CINCH-GRAFIK

DIVISION OF UNITED-CARR



200 South Turnbull Canyon Road, City of Industry (Los Angeles), Calif. 91744 • Phone (213) ED 3-1201. Sales offices in 33 principal cities throughout the United States, Great Britain, Canada, Australia and West Germany. CONSISTING OF CINCH MANUFACTURING COMPANY, CINCH-GRAFIK, CINCH-MONADNOCK, CINCH-NULINE, UCINITE (ELECTRONICS) AND PLAXIAL CABLE DEPT.

ON READER-SERVICE CARD CIRCLE 191

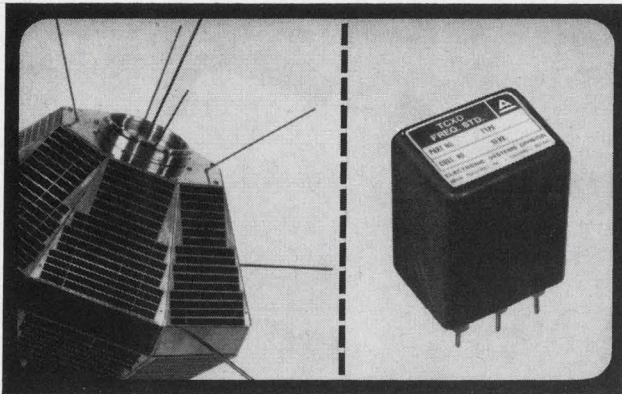

## TEMPERATURE COMPENSATED CRYSTAL OSCILLATORS

New Arvin TCXOs solve frequency management problems with oven-like accuracy in miniaturized communications and aerospace equipment.

- Volume, to one cubic inch
- No oven required
- 1 Hz to 200 MHz frequency
- Low power drain
- To  $\pm 5$  PP  $10^8$  stability
- Instant warm-up

All circuit values are computer optimized to provide precise, stable frequency standards. Units may be specified to conform to commercial, MIL, or NASA specifications. Write for Bulletin TCXO 101.

### ARVIN FREQUENCY DEVICES



2505 North Salisbury Street, West Lafayette, Indiana 47906  
ON READER-SERVICE CARD CIRCLE 198

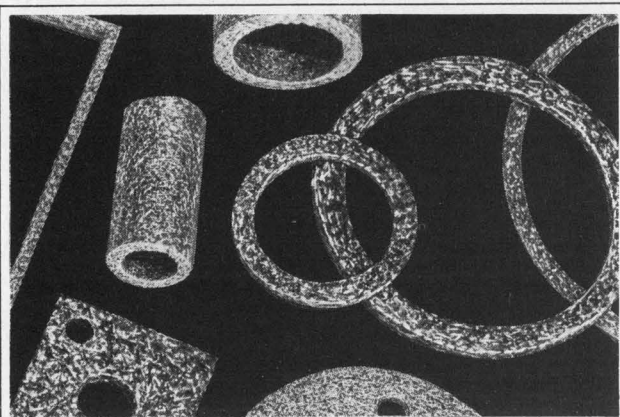

## Conductive Mesh Washers

...for grounding, shielding, and contact applications.

Metex Compressed RF Washers are inherently conductive and resilient... will compensate for joint unevenness. They consist of knitted wire mesh, die formed to size and shape under pressure. Each is made from a mesh knit of one or two

continuous wires. No joints, metal clips or shavings to cause trouble! Because they're compressible, no machined surfaces are needed. Metex Compressed RF Washers can be made in any shape. Write today for free samples, prices, literature.

### METEX Corporation

970 New Durham Road, Edison, N.J. 08817  
(201) 287-0800 • TWX 710-744-4530  
West Coast: Cal-Metex Corp., 509 Hindry Ave., Inglewood, Calif.



52

ON READER-SERVICE CARD CIRCLE 199

## MICROWAVES

### Microwave signal source based on Gunn diode



Flann Microwave Instruments, Ltd., Old Bridge St., Kingston-upon-Thames, Surrey, England. Phone: 01-546-7217. Price: about \$2800.

A solid-state signal generator for frequencies from 8 to 16 GHz is claimed to be the first commercially available unit to use a Gunn-effect diode as the signal source. Spectral purity is reportedly similar to that obtained with a klystron source on continuous wave. The Gunn oscillator is connected into a broadband high-Q coaxial resonator. A mechanically-driven tuning piston, actuated by a frequency-linearizing cam mechanism, is coupled to a digital counter and the front-panel frequency control. Output power is coupled to the RF connector through a matched piston attenuator. Modulation facilities include cw, square wave, frequency deviation and pulse. Delayed sync signals and an ability to synchronize with external signals of either polarity are built in. Typical cw spectral width is 15 kHz with power output of  $-3$  dBm. The range of output level is  $-3$  to  $-130$  dBm.

CIRCLE NO. 343

### Three-watt oscillator varactor-tuned

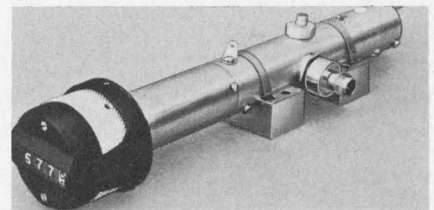

Applied Microwave Lab, Inc., Andover St., Andover, Mass. Phone: (617) 475-6100.

A 3-watt varactor-tuned cw oscillator is designated model 6300-385. Within the bandwidth of 1300 to 1500 MHz at 20 volts positive or negative bias, the oscillator permits 0.5% tuning. The unit requires an input power of 6 watts.

CIRCLE NO. 344

Where to begin...what equipment to select  
...what pitfalls to guard against in

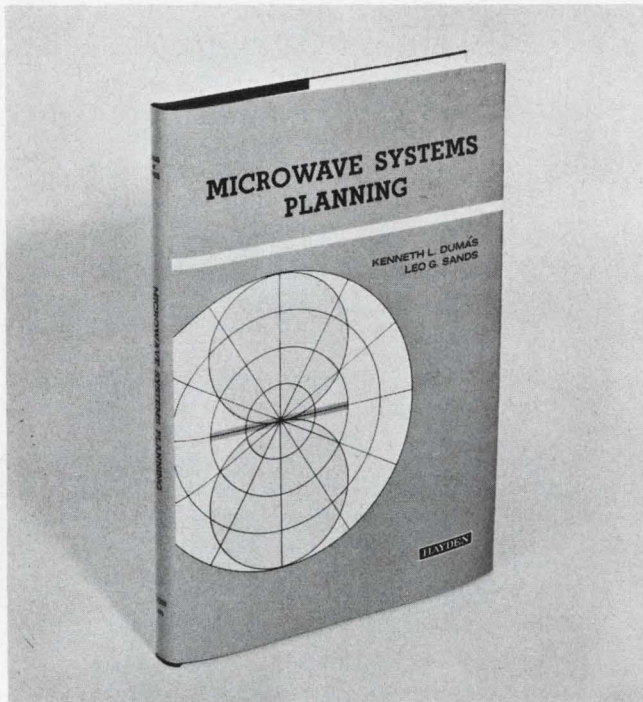

# Microwave Systems Planning

KENNETH L. DUMAS, and  
LEO G. SANDS

Here is an authoritative introduction to microwave systems, presenting for the first time in a single volume needed information that has been scattered up to now among many books, articles, and manufacturers' catalogs. With this convenient sourcebook at hand, managers, engineers, and technicians — all participants in the spiralling growth of communications facilities — have a comprehensive view of the theoretical and practical considerations of installing and operating point-to-point FM communication systems.

Written in a semi-technical manner, the book uses terms, phrases, and symbols commonly employed in the telephone industry, the greatest user of micro-

wave systems. It begins by providing a thorough groundwork in fundamental principles, from frequency and wave theory — including propagation — to hardware theory. The balance of the book is concerned with a thorough, objective investigation of the practical aspects of establishing a microwave path with a high probability of good performance.

**Chapters:** Fundamentals of Microwave Theory. Microwave Propagation Theory. Characteristics of Transmission Paths. Transmission Performance. Microwave System Performance. Microwave Communications Equipment Loading. Fundamentals of Antenna Systems. Microwave Equipment. Microwave Path Engineering. Antenna Orientation and System Measurement. **143 pages, illustrated, clothbound. \$8.00.**

Dept. JC-6, Hayden Book Company, Inc., 116 West 14 St., New York, N.Y. 10011  
Send me MICROWAVE SYSTEMS PLANNING for a free examination. At the end of ten days,  
I will either remit \$8.00 plus postage or return the book with no further obligation.

Name \_\_\_\_\_ Title \_\_\_\_\_

Company \_\_\_\_\_

Address \_\_\_\_\_

City \_\_\_\_\_ State \_\_\_\_\_ Zip \_\_\_\_\_

Check here if payment enclosed. Publisher pays postage with same return guarantee.  
(Foreign orders, except Canada, must include payment in \$ U.S.)

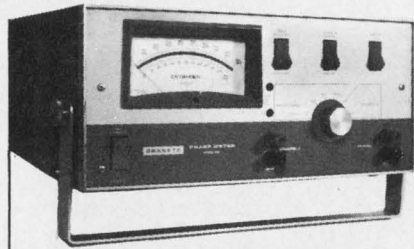

## PHASE METER FEATURES BROAD DYNAMIC RANGE WITHOUT INPUT LEVEL ADJUSTMENT.

- All solid-state     DC output
- Frequency range of 5 Hz to 500 kHz.
- 1° accuracy over most of range.
- Write or call today for full details on Series 301.

**DRANETZ**

**ENGINEERING LABORATORIES, INC.**  
1233 North Ave., Plainfield, N. J. 07062  
Telephone Area Code: (201) 755-7080

IMPEDANCE — ADMITTANCE METERS  PHASE METERS  TRANSFER FUNCTION COMPUTERS  
 INSTRUMENT TRANSFORMERS  OSCILLATORS  
 COMPLETE INSTRUMENTATION SYSTEMS.

ON READER-SERVICE CARD CIRCLE 226



**Direct reading  
punched tape  
programmers  
control—22, 42 or  
82 load circuits.  
Less than \$600**  
(82 channels)

Expressly designed for multiple circuit industrial control applications, this new Tape Reader combines the durability of toggle switches, the flexibility of a patchboard, the repeat accuracy of a cam timer, with the

advantages of punched tape programming.

For detailed information about this direct-reading low-cost Tape Programmer, write Mr. Kenneth Kraemer, Director of Marketing.



**INDUSTRIAL  
TIMER CORPORATION**

65 U.S. HIGHWAY 287, PARSIPPANY, NEW JERSEY

ON READER-SERVICE CARD CIRCLE 227

## MICROWAVES

### Signal monitor levels sweep generators

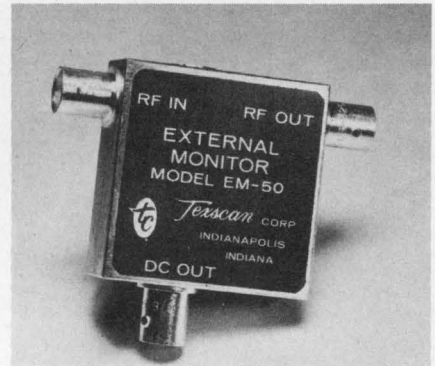

*Texscan Corp., 51 S. Koweba Lane, Indianapolis. Phone: (317) 632-7351. P&A: \$55; stock.*

This external monitor is a dual-purpose device designed to externally level sweep signal generators, as well as serving as a signal-monitoring device. The unit makes it possible to ensure a flat input to remotely located test positions. It is provided with a 50- $\Omega$  source resistor to set the impedance level at the input of the unit being tested. Frequency range is 500 kHz to 1200 MHz. Impedance is 50 $\Omega$  with a 3-dB insertion loss.

CIRCLE NO. 345

### Solid-state counter measures to 15 GHz

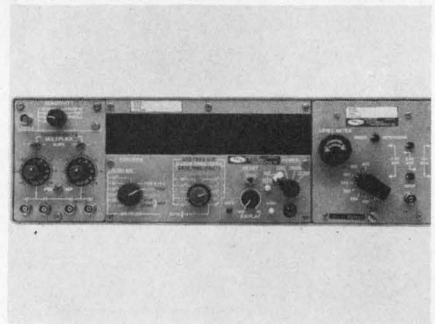

*American Electronic Labs., Inc., P.O. Box 552, Lansdale, Pa. Phone: (215) 822-2929. P&A: \$4350; late fall.*

Measuring directly to 100 MHz, this counter's frequency capability can be extended to 500 MHz to 3 GHz, and to 15 GHz with plug-in converters. The counter measures and displays frequency, period, multiple period average, frequency ratio, frequency ratio average and time interval with internal and external clock.

CIRCLE NO. 346



## Q-switched lasers deliver 50,000 MW

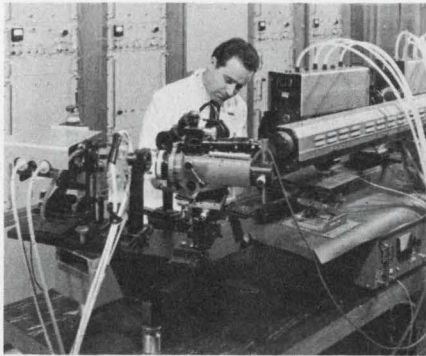

*Cogenel, Inc., 50 Rockefeller Plaza,  
N. Y. Phone: (212) 757-9130.*

Two neodymium-doped glass laser systems are said to produce the highest power and the highest brightness of any commercially available lasers. The laser delivers up to 50,000 MW with 250 joules in pulses with a duration of less than 5 ns. The high-intensity laser produces a coherent beam of brightness greater than  $4 \times 10^{16}$  W/cm<sup>2</sup>/steradian with 500 joules in pulses with a duration of some 30 ns and peak power of 17,000 MW.

CIRCLE NO. 347

## Slotted line system eases testing

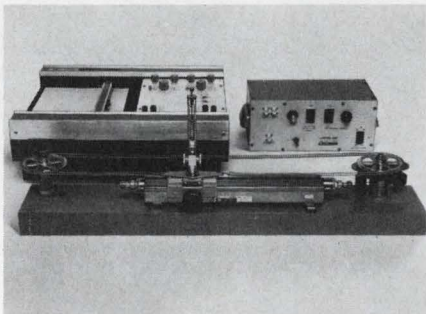

*Alford Manufacturing Co., 120  
Cross St., Winchester, Mass.  
Phone: (617) 426-2150.*

This recording system produces a high-resolution recording of the slotted line output as a function of probe position. The system facilitates production testing by relaxing the requirement for setting the swr indicator, by eliminating the requirement for accurate meter readings and by eliminating the manual recording of data. It operates with any swr indicator and recorder.

CIRCLE NO. 348

# HOW CAN YOU USE THIS NEW WRINKLE IN PLASTIC TUBING?

FLEXITE SHRINKDOWN TUBING is fast becoming an indispensable to design engineers. It shrinks 50% in diameter, upon application of moderate heat, to form a tough, tight-fitting sheath of plastic around objects of irregular shape. Primarily intended for insulation, it is also being used in many other ingenious ways. Like binding things together — adding strength and rigidity — protecting against abrasion, wear, breakage — resisting corrosion, heat, moisture — preventing vibration and noise — etc. How can **you** use it? We'll be glad to send you our "Hot Idea" experimental sample kit of all 3 types of Markel Shrinkdown. Just write for it. No cost or obligation.



## L. FRANK MARKEL & SONS

Norristown, Pa. 19404 • 215-272-8960

INSULATING TUBINGS AND SLEEVINGS  
HIGH TEMPERATURE WIRE AND CABLE

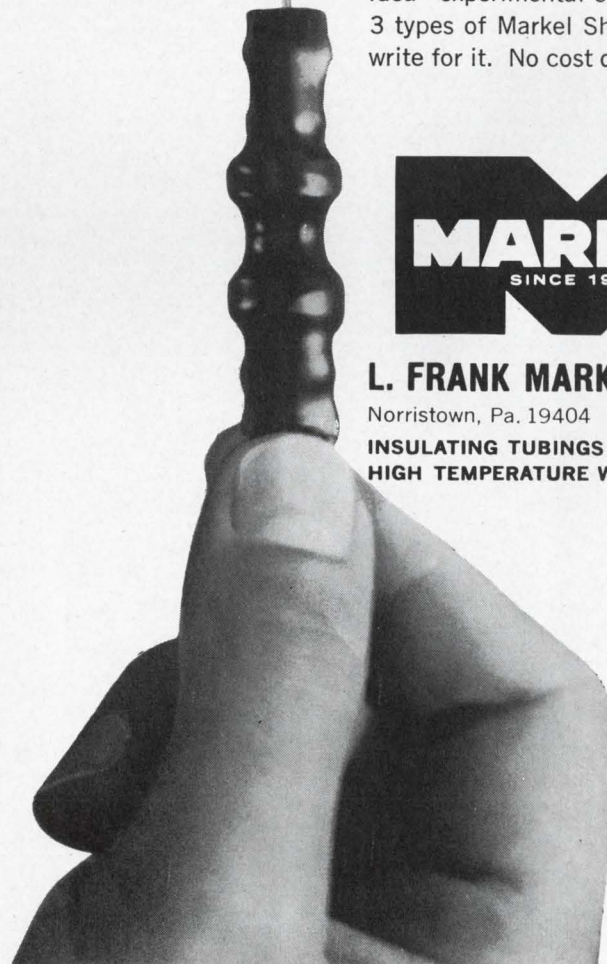

ON READER-SERVICE CARD CIRCLE 201

## MICROWAVES

### Resolver amplifiers range 0.5 to 60 MHz

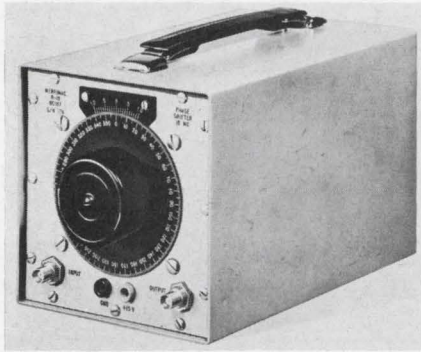

Merrimac Research and Development, Inc., 41 Fairfield Pl., Caldwell, N. J. Phone: (201) 371-1616. Price: \$950 and \$825.

A series of phase-shifters (resolver amplifiers) are available for i-f measurement and control applications in the 0.5-to-60-MHz range. They are continuously variable devices employing electromechanical phase-shifters and phase-stabilized solid-state amplifiers. They are available in standard 10- and 22-MHz versions, and a 30-MHz unit.

CIRCLE NO. 349

### Dc feed units handle 2.5 A

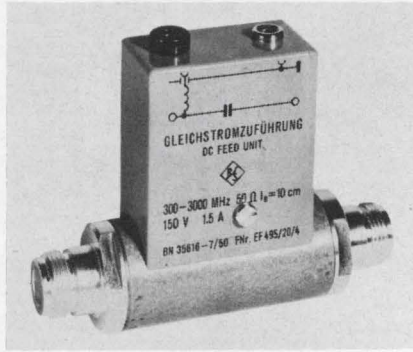

Rohde & Schwarz Sales Co., Inc., 111 Lexington, Ave., Passaic, N. J. Phone: (201) 773-8010. P&A: \$188 and \$198; stock.

Two 50-ohm dc feed units for microwave measurements provide a means of separating the dc bias circuit from the rf measuring circuit. Maximum bias current is 2.5 A with a maximum voltage across the capacitor limited to 150 Vdc. One model covers 30 to 100 MHz, with typical vswr of 1.04; the second covers 300 to 300 MHz.

CIRCLE NO. 350

### Afc/monitor cavity stable to 1 MHz

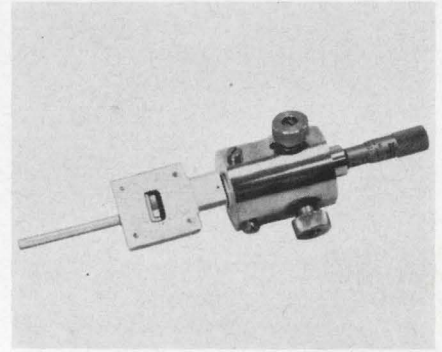

Microlab/FXR, 10 Microlab Rd., Livingston, N. J. Phone: (201) 992-7700.

Frequency stability of 1 MHz over a temperature range of  $-30^{\circ}$  to  $75^{\circ}\text{C}$  is offered by this afc and monitor cavity. It can be used to stabilize klystrons in any microwave discriminator circuit. The unit is hermetically sealed and filled with dry nitrogen. It offers a tuning resolution of  $\pm 0.5$  MHz and operates over a frequency range of 5.9 to 7.4 GHz.

CIRCLE NO. 351

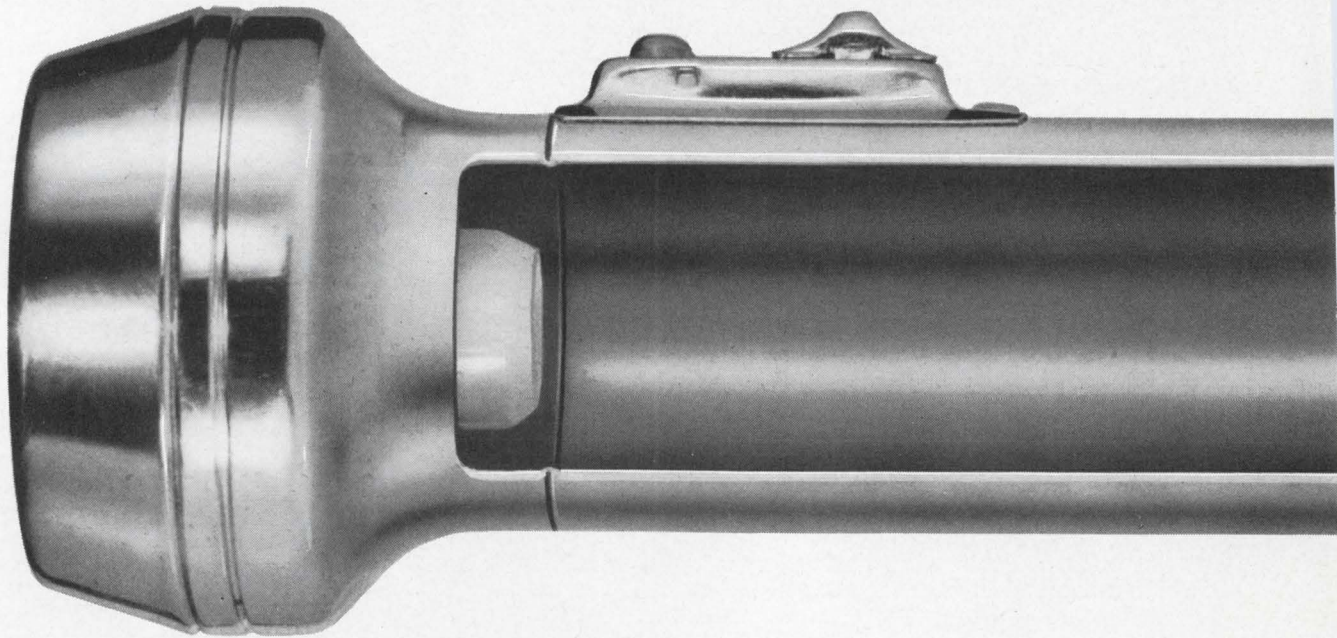

Looking for a more challenging opportunity? Join Sonotone's fast-growing engineering team in the skyrocketing field of nickel-cadmium battery design and development. An equal opportunity employer.

## Vswr system tops slotted line accuracy



Telonic Engineering Co., Box 277, Laguna Beach, Calif. Phone: (714) 494-7581.

With accuracy specifications claimed to be equal to or better than slotted line methods, this vswr test system spans 500 kHz to 1 GHz. The system makes direct-reading vswr measurements in the range of 1.02 to 3.00 with an extended range capability over any 17-dB return loss range. Typical worst-case system error is less than 4.1% and 1.77% accuracy is typical.

CIRCLE NO. 352

## Double-balanced mixer mounts PC boards

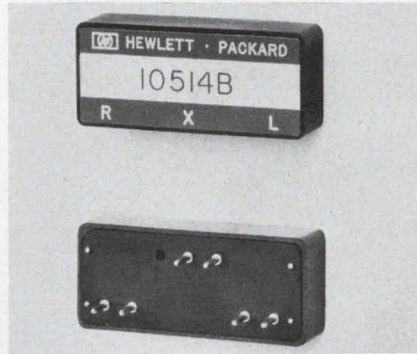

Hewlett-Packard, 1501 Page Mill Rd., Palo Alto, Calif. Phone: (415) 326-7000. P&A: \$75 to \$150; stock.

Broadband double-balanced mixers are housed in a compact (1.63 x 0.7 x 0.43 inch) package for mounting directly on PC boards or in stripline circuits. A third mixer is in a metal case with BNC connectors. Frequency range of the 10514B is 0.2 to 300 MHz at the LO and signal ports; the third port is decoupled. The 15034A spans 50 Hz to 150 MHz.

CIRCLE NO. 353

## Coax switches span dc to 2 GHz

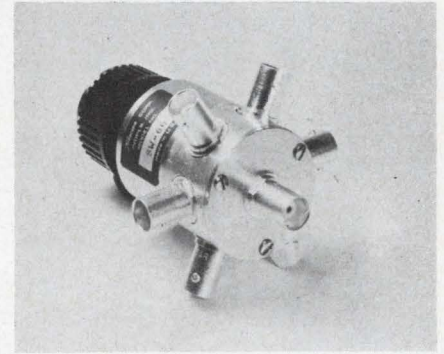

Texscan Corp., 51 S. Kowebe Lane, Indianapolis. Phone: (317) 632-7351. P&A: \$85; 3 to 4 wks.

Single-pole, six-position manually operated coax switches cover dc to 2000 MHz. Characteristic impedance is 50  $\Omega$ , insertion loss is less than 0.15 dB at 1000 MHz, vswr is less than 1.1 and isolation is greater than 70 dB at 1000 MHz. Wafers can be added for switching dc voltages. The unit can be supplied in single-pole, up to 6-position combinations.

CIRCLE NO. 354

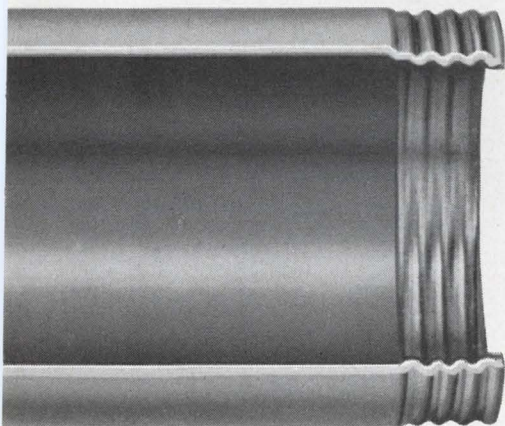

# Out for recharge... back in an hour!



The 1-hour rechargeable sealed cell is more than a laboratory phenomenon at Sonotone. Now in its final development and testing stages, this cell has shown long-time over-charge capability.

Leadership like this is nothing new at Sonotone. Not when you're the most experienced mass producer of sealed cells in the industry... with the broadest line in pro-

duction... with a cell that outperforms others in its class.

Good points to remember when faced with portable power problems. You'll find the problem-solvers at Sonotone.

**Sonotone Batteries** <sup>®</sup>  
portable power—from Titan to toothbrush

SONOTONE CORPORATION, BATTERY DIV., ELMSFORD N. Y. 10523

Aircraft, Missile and Satellite Batteries • Power Supplies • Battery Charger/Analyzer

ON READER-SERVICE CARD CIRCLE 202



# Can This Motor Run 5000 Hours

?



No, we can't guarantee it; but it may run longer! For example, a customer used a Clifton motor almost continuously for a year (8760 hrs.) and it still ran, though not up to specification.

Industry standard for servo motors is 1000 hours and all Clifton motors meet it. In addition, we are delivering motors to a 2000 hour life specification. Trade off on some parameters, and Clifton can develop a motor for you which will exceed by far normal life expectancy. Incidentally, when a guaranteed 5000 hour life motor *is* built, we feel Clifton "state-of-the-art" engineers will build it.

Why not have CLIFTON quality for your motor, generator, tachometer needs! Gearheads available also. Call your local Clifton Sales Office or 215-622-1000; TWX 510 669-8217.

**CLIFTON**   
DIVISION OF LITTON INDUSTRIES

ON READER-SERVICE CARD CIRCLE 204

# Application Notes

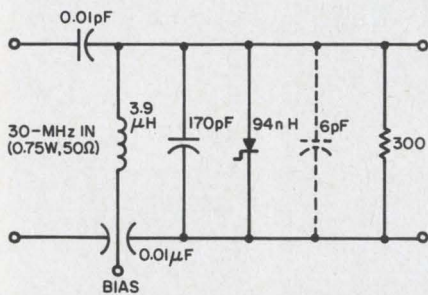

## Frequency multiplier design

A 24-page application note presents theory and practice of efficient frequency multiplier design using step-recovery diodes in the shunt mode. The note gives step-by-step procedures for designing an impulse generator and related circuits that convert an input sinusoidal rf drive waveform into a sinusoid at microwave frequencies. The 30-MHz impulse generator above is one example. Its efficiency of impulse generation exceeds 80%. Other examples include design procedures for a X10 multiplier with an output of 2 watts at 2 GHz and a X5 multiplier with a 5-watt output at 2 GHz.

Design aids in the form of full-page graphs can be used to find optimum circuit components. Methods of matching the multiplier input and output impedances to source and load are described and techniques for compensating the circuit for temperature changes are also discussed. The basic theory of the step-recovery diode and the theory of efficient impulse generator design are presented. Hewlett-Packard.

CIRCLE NO. 358

## Diff-amp applications

Signetics' SE505 is a general purpose, high gain differential amplifier with differential gain provided at each of the two outputs. Use of feedback techniques, as in operational amplifier circuits, makes this a versatile device. Circuits may be constructed to perform a great variety of functions with few external components. This 8-page note presents applications, including video, sense, logarithmic and band reject amplification. Signetics, Inc.

CIRCLE NO. 359

## Bandpass amplifier uses

Philco's PA 7601 is a bandpass amplifier for i-f and rf service in the frequency range of 40 to 150 MHz. It features a gain-control circuit which has a negligible effect on bandwidth and terminal impedances. Its terminal impedances remain relatively constant over the full frequency and temperature range, thus simplifying matching problems. The frequency response is determined to a large extent by external components, thereby giving application utility. Several different bandpass characteristics are discussed in this 8-page note. Philco/Ford Microelectronics.

CIRCLE NO. 360

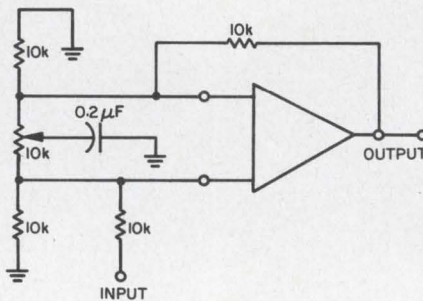

## Treble, bass control circuits

A variable frequency response can be realized for treble control by using the appropriate feedback elements in conjunction with the Westinghouse WC 161 operational amplifier. The circuit is shown above with a gain of two set by the 10-kΩ resistors in the feedback loop. A voltage divider is used at the input to bring the over-all gain to unity. The potentiometer is connected between pins 2 and 5 with a capacitor from the wiper to ground. Varying the potentiometer toward pin 2 causes the higher frequency feedback to be shunted to ground and increases the effective gain of the amplifier at these frequencies. Design procedures, performance characteristics and descriptions are given in this folder for the treble and a bass control circuit. Westinghouse, Molecular Electronics Div.

CIRCLE NO. 361

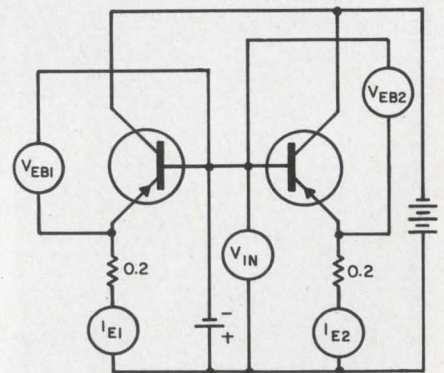

## Parallel power transistors

In the design of circuits which must handle extremely high power, designers look toward parallel operation of power transistors. Unfortunately, transistors of the same type do not always have identical characteristics. Unless proper precautions are taken, transistors in parallel will not accept equal portions of the load. One solution to the problem is to use emitter resistors. This application note consists of a graphical calculation with confirming experimental data. It shows to what extent collector currents can be equalized by means of 0.2-Ω emitter resistors at the 5-A level. Calculations and experiments are made on the circuit above and results given. Delco Semiconductor.

CIRCLE NO. 362

## Fm measurements

The use of a frequency meter or any other wideband fm discriminator for fm measurements is described in this 17-page note. Two techniques for measuring fm on signal carriers greater than 10 MHz are described, one of these being applicable to signals up to 12.4 GHz. Also described are techniques for measuring small values of fm, such as in measurements of wow and flutter on tape recorders or in evaluating incidental and residual fm in signal generators, and for measuring rf bursts or "chirp" signals. The note also presents procedures for calculating phase deviation from measurements of frequency deviations. Hewlett-Packard.

CIRCLE NO. 363

# Who says you need to clutter your system...

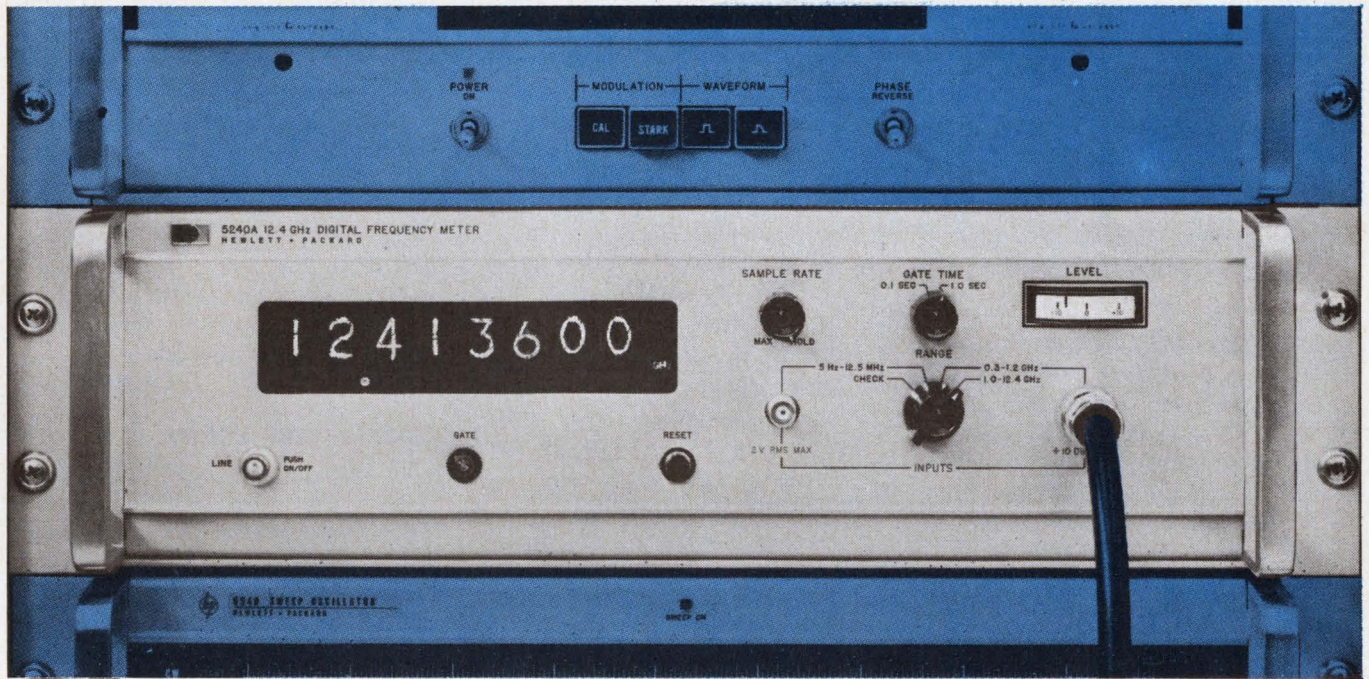

## ...to measure automatically 0.3 to 12.4 GHz?

He's wrong. Hewlett-Packard can supply an automatic, systems-oriented, single-package instrument to measure the widest microwave frequency range at the lowest price—\$4750.

The HP 5240A Digital Frequency Meter offers completely automatic tuning and direct readout from 0.3 to 12.4 GHz. No adjustments or calculations are necessary—just select the range desired (0.3 to 1.2 GHz or 1.0 to 12.4 GHz), connect the input signal, and read. Readout is inhibited until automatic phase lock is achieved. Therefore, the first reading made is automatically correct—no need to clutter your system with error-checking circuits. For extra usefulness, the internal counter

input is brought out so you can measure from 5 Hz to 12.5 MHz, too. This wide-range versatility makes it perfect for systems work and for rapid, error-free measurement for production and maintenance.

The 5240A uses special sampling techniques to maintain a low input VSWR (typically 1.2:1 to 1.8:1). The operator or system can measure from 0.3 to 12.4 GHz without adjusting for input sensitivity changes. More technical details are in the HP Journal, April, 1967.

Call your local HP field engineer for details on the 5240A. Or write Hewlett-Packard, Palo Alto, Calif. 94304; Europe: 54 Route des Acacias, Geneva.

HEWLETT  PACKARD

ON READER-SERVICE CARD CIRCLE 205

# New Literature

## Microwave mixer topics

A 36-page discussion focuses on mixers utilizing the point contact resistive microwave diode as the nonlinear element. The brochure begins with an explanation of the general considerations for mixers. Examples and explanations of designs include single-diode mixers, balanced mixers, diodes and diode holders. Sage Laboratories, Inc.

CIRCLE NO. 364

## Quick-snap switches

A catalog describing 400 switches in four sizes, for loads from 3 to 200 amperes ac or dc; single-pole to 12-pole single-throw and to 8-pole 4-throw is available. Contained in the catalog are dimensions, mountings, terminal arrangements, weights, torques, handle-positions, accessories and optional features. Electro Switch Corp.

CIRCLE NO. 365

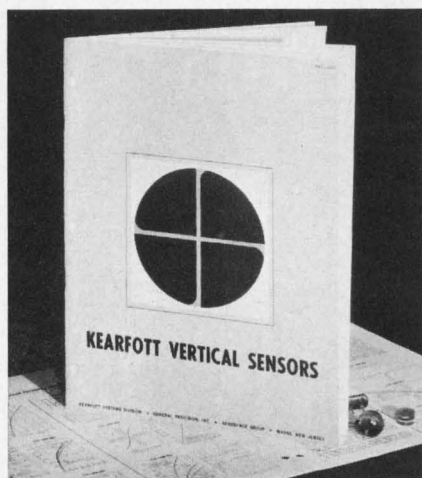

## Vertical and tilt sensors

A 12-page catalog describing a variety of pendulous and bubble-type vertical and tilt angle sensors is illustrated with performance curves, schematics, dimensional drawings and pictures. The brochure details high-accuracy and moderate-accuracy electrolytic and electromagnetic pendulous two-axis vertical sensors used in vertical gyros, antenna or camera stabilization systems, and in other missile, aircraft, ground vehicle, and shipboard gyro reference systems. General Precision, Kearfott Products Div.

CIRCLE NO. 366

## Electronic taping tips

Included in this 32-page, illustrated booklet are such taping topics as how to protect power input connections, wiring harnessing, circuit isolation protection and antenna and lead-in protection. Photos and instructions demonstrate how to take advantage of electrical tapes in a variety of servicing situations. Additional sections in the catalog tell how to avoid cold-weather difficulties and how to achieve high temperature stability even in areas of atmospheric or chemical contamination. 3M Company.

CIRCLE NO. 367

## Thermoelectric catalog

A catalog illustrating the manufacturer's types of plastics processing thermocouples and accessories contains descriptions on spring-loaded and leak-proof plastic melt thermocouples. Five types of melt thermocouples are described for various application requirements. Flush, 1/2- and 1-inch immersion lengths are offered. To complete the presentation, data are given on miniature protected thermocouples which measure liquid and gas temperatures. Thermo Electric.

CIRCLE NO. 368

## Frequency control data

A 20-page, 2-color catalog contains information on hermetically sealed low- and high-frequency resonators, crystals, ovens, packaged oscillators and associated components. Schematics and graphs are included in the presentation. Northern Engineering Laboratories.

CIRCLE NO. 369

## Stainless steel data

A 10-page booklet includes information on Uniloy stainless. Data are presented on hot working, heat treatment, cold working, welding, machining, corrosion resistance, oxidation resistance, physical constants, typical mechanical properties and chemical analysis of these steels. Universal-Cyclops Specialty Steel Div.

CIRCLE NO. 370

## Variable inductors handbook

A 16-page engineering handbook describes communications-grade variable inductors. The components are designed for circuit board mounting, and have a recommended frequency range of 800 Hz to 100 kHz. Listings give nominal inductance value, tuning ranges and dc resistances. Performance curves depict Q vs frequency, tuning range, inductance vs temperature, and self-resonant frequency vs true inductance. Sangamo Electric Co.

CIRCLE NO. 371

## Coaxial connectors

A 16-page technical bulletin describes the manufacturer's line of coaxial connectors, including captivated collet and Wirelok designs. An identification and dimension chart relates individual connector catalog numbers to the type of coaxial cable for which they were designed. Pages dealing with individual connector types such as "N" male, EIA, splice and TNC are contained in the catalog. Phelps Dodge Electronic Products Corp.

CIRCLE NO. 372

## Readout catalog

A brochure on single-plane rear-projection readouts contains 44 pages, detailing principles of operation for a complete line of readouts. Catalog photos and specifications on units, assemblies, accessories, lamps and prices are included. Industrial Electronic Engineers, Inc.

CIRCLE NO. 373

## Components reference

An 84-page catalog covers the field of components and is geared particularly to the needs of engineers and purchasing agents. The volume is a comprehensive reference work which contains dimensional drawings and technical data on standard plugs, jacks, connectors, clips, prods, terminals and associated electronic hardware in use today.

Available on company letterhead from Herman H. Smith, Inc., 812 Snediker Ave., Brooklyn, N. Y.



# When even the Best Carbon or Wirewound Pots won't do...

## CTS Cermet Pots Offer a Solution

### 6 WEEKS DELIVERY...NEW LOWER PRICES...

due to CTS automated production techniques and the industry's biggest output.

Consider these CTS Cermet Pot characteristics:

1. 20  $\Omega$  to 5 megohms resistance range.
2. Greater power/size ratio. (See captions.)
3. The environmental stability & higher wattage rating of wirewound.
4. The wide resistance range & infinite resolution of carbon.
5. Extremely high temperature capabilities.
6. Stability under extreme humidity.
7. No catastrophic failures.
8. Low noise. Long life.
9. Exceed MIL-R-23285 (Navy) metal film; far exceed MIL-R-94B.

Specify from the broadest line of thick film controls available.

New low prices begin at \$1.35 each in large quantities.



**Series 500**  
3/4" dia.  
1-1/2 watts @85°C



**Series 400**  
1-3/64" dia.  
3 watts @85°C



**Series 600**  
1/2" dia.  
3/4 watt @85°C

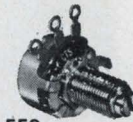

**Series 550**  
3/4" dia.  
2 watts @70°C



**Series 2-500**  
3/4" dia.  
1-1/2 watts @85°C  
Tandem Series 500

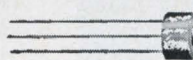

**Series 385**  
11/32" dia.  
1/8 watt @125°C  
For P.C. applications



**Series 660**  
3/8" dia.  
1/4 watt @125°C



**Series 600PC**  
1/2" dia.  
3/4 watt @85°C  
For P.C. applications



**Series 630**  
1/2" dia.  
1/2 watt @85°C

Request Cermet Catalog.



Founded 1896

**CTS OF BERNE, INC.**  
BERNE, INDIANA

Subsidiary of CTS Corporation, Elkhart, Indiana

**A NATURAL for  
Integrated Circuitry!**



## CONNOR-WINFIELD



**"IC" Series  
CRYSTAL  
OSCILLATORS**

Dimensions: 1.6" L. x 1.2" W. x 0.4" thick

### COMPATIBILITY PLUS VARIETY

- Available frequencies: 1 Hz to 400 kHz
- Square Wave Output. Duty cycle, 50%.  
Logic Zero <0.4V, Logic One >2.4V.
- Operates from 5 VDC  $\pm 10\%$  supply.

Model	Frequency Accuracy	Temperature Degrees C	Range Degrees F
IC5A1	$\pm .002\%$	+20 to +40	+68 to +104
IC5B1	$\pm .005\%$	0 to +50	+32 to +122
IC5C1	$\pm .005\%$	0 to +65	+32 to +149
IC5D1	$\pm .01\%$	0 to +65	+32 to +149
IC5E1	$\pm .01\%$	-25 to +70	-13 to +158
IC5F1	$\pm .02\%$	-25 to +70	-13 to +158
IC5G1	$\pm .02\%$	-55 to +70	-67 to +158
IC5H1	$\pm .05\%$	-55 to +70	-67 to +158

Other tolerances and temperatures on special order.



**CONNOR-WINFIELD CORP.**  
Winfield, Illinois 60190  
Phone: 312-231-5270

ON READER-SERVICE CARD CIRCLE 207

## THE MOST ADVANCED MATRIX PROGRAM BOARDS AVAILABLE

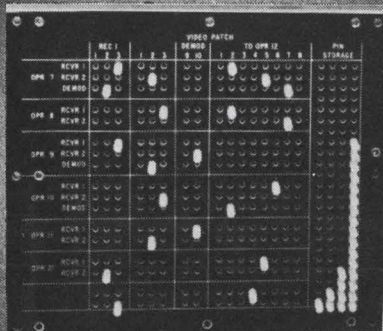

These X-Y switching matrices offer a rapid way to program and switch complex circuits. Insertion of a single pin can perform 1, 2, or 3 pole switching. CO-ORD Boards feature closed entry, Be-Cu contacts which are dust shielded within the "Solid Phenolic Block" package. Rugged shorting and "CO-AX" diode pins are available for 2 to 6 deck matrices. For more information on how you can use this simple and reliable program approach, contact . . .



**CO-ORD SWITCH**  
A DIVISION OF LVC INDUSTRIES INC.  
102-48 43rd AVE., CORONA, N. Y. 11368 • TEL: 212-899-5588

ON READER-SERVICE CARD CIRCLE 208

## NEW LITERATURE

### Computer techniques

A 32-page, two-color brochure entitled "Computers in the Life Sciences" describes computer techniques that can be performed with a general purpose laboratory computer while the experiment is taking place. Application examples are given for the behavioral sciences, cardiology, and neurology. A bibliography of articles on the use of computers in biomedicine is contained. Digital Equipment Corp.

CIRCLE NO. 374

### Superconductive magnets

A 12-page capabilities brochure describes the production of superconducting magnet systems. The catalog outlines design and fabrication techniques used in manufacturing magnets with field strengths of 50 kilogauss and upward. The brochure also lists specifications of standard superconducting magnets and custom-designed magnets including split pairs. Gardner Cryogenics Corp.

CIRCLE NO. 375

### TV tube reference

A 42-page illustrated reference book contains key characteristics and data on black-and-white and color TV picture tubes. The booklet provides a reference guide to picture tubes and TV receiver test tubes and contains illustrated comparisons of picture tube protection systems, basing diagrams and interchangeability data. Sylvania, Electronic Tube Div.

CIRCLE NO. 376

### Precious metal cladding

A 24-page, three-color booklet discusses the concept of the use of clad precious metals to replace solid precious metals in electronic applications. Examples are furnished and descriptions on how clad precious metals are made, showing the various forms of cladding available, are given. A chart details the dollars-and-cents savings made possible through changeover from solid to clad precious metals. Also furnished are guidelines for evaluating the economics of the composites. Handy & Harman.

CIRCLE NO. 377



# ALL TYPES OF ALUMINUM ENCLOSURES

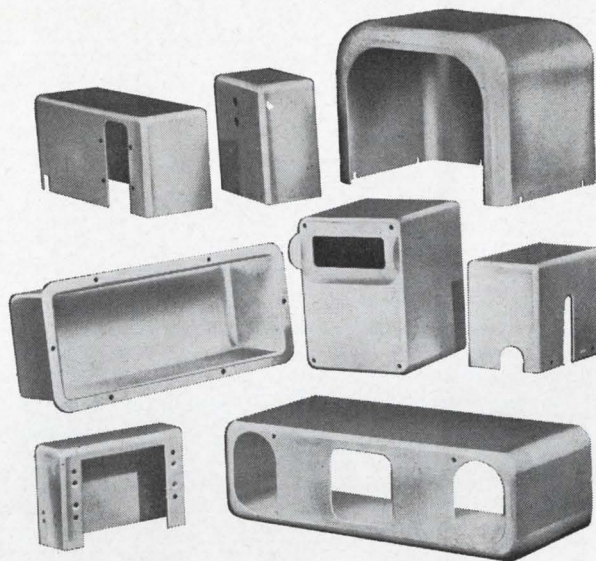

## Micrologic registration

EIA's Microelectronics Engineering Panel has issued the third in a series of formats for data for registration of semiconductor devices. The format provides for registration of semiconductor integrated bistable logic circuits including monolithic, multichip, film and hybrid bistable logic circuits.

Available for 50¢ from the Engineering Dept., EIA, 2001 Eye St., N.W., Washington, D. C. 20006.

## Microwave products catalog

A 12-page brochure covering microwave products details information on crystal video detectors, antennas, microwave components, filters, semiconductor diodes, infrared devices and testers and instruments. Also dealt with in the presentation are the areas of biophysical and electro-medical instrumentation, broadcast equipment and CATV. American Electronic Labs.

CIRCLE NO. 378

## Optical engineering brochure

An 8-page catalog on optical engineering entitled "Progress in Optics," describes and illustrates GE's capabilities, facilities and experience in optics. It includes its current activity in automatic design. General Electric Co., Electronics Labs.

CIRCLE NO. 379

## Silicone guide

Product information and data on silicones are given in this 8-page, 2-color catalog. Also included are data on sealants, anti-foam agents, additives, textile finishes, paper release coatings and chemicals. General Electric, Silicone Products Dept.

CIRCLE NO. 380

## Alumina and beryllia

An eight-page booklet describing the physical, electrical, chemical and thermal properties of alumina and beryllia ceramics contains applications for alumina and beryllia ceramic parts and assemblies. Components and assemblies are illustrated. Frenchtown/CFI, Inc.

CIRCLE NO. 381

For over fifty years, American Aluminum Company has fabricated all types of aluminum enclosures for the electronics industry.

Today's need for lightweight enclosures are great and American Aluminum's vast facilities can provide many sizes and shapes to fill your specific requirements.

May we quote your next enclosure need? You'll find our services rapid, precise, and dependable. Immediate attention, with emphasis on quality and reliability will be given.

## OTHER PRODUCTS & SERVICES OF AMERICAN ALUMINUM

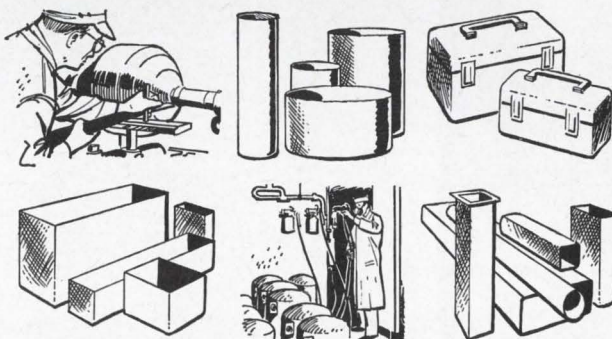

## SPECIALISTS IN CONTRACT MANUFACTURING OF ALUMINUM

COMPLETE FABRICATING FACILITIES FOR DEEP DRAWING, HEAT TREATING, SPINNINGS, ASSEMBLY, SHEET METAL, STAMPINGS, ANODIZING, WELDING, FINISHING.

Send for brochure "Aluminum Fabricating For Industry"



## AMERICAN ALUMINUM COMPANY

Manufacturers of Aluminum Products for Industry since 1910

230 Sheffield St. • Mountainside, N. J. • 201-233-3500

ON READER-SERVICE CARD CIRCLE 209

# Advertisers' Index

Advertiser	Page	Advertiser	Page	Advertiser	Page
API Instruments Co.	182	Eimac, A Division of Varian Associates	101	Metex Corporation	188
Accutronics, Inc.	83	Eldre Components, Inc.	206	Monitor Systems, Inc.	170
Adams & Westlake Company	145	Electronic Design	203, 204	Motorola Communications and Electronics, Inc.	84
Addison Wesley	205	Electronic Memories, Inc.	139	Motorola Semiconductor Products, Inc.	6, 33, 77
Aemco Division, Midtek Corporation	44	Electronic Research Associates, Inc.	138		
Alco Electronic Products, Inc.	175	Emerson & Cuming, Inc.	164		
Alfred Electronics	133			Narda Microwave Corporation, The	58
Allen-Bradley Co.	23	Fairchild Instrumentation, A Division of Fairchild Camera and Instrument Corporation	111	Non-Linear Systems, Inc.	50, 51
American Aluminum Company	201	Fairchild Semiconductor, A Division Fairchild Camera and Instrument Corporation	57	Nytronics, Inc.	21
Arnold Engineering Company, The	143	Fluke Mfg. Co., Inc., John	105		
Art Wire and Stamping Co.	186			Philco-Ford Corporation	117
Arvin Frequency Devices	188	G-V Controls, Inc.	46, 47	Potter & Brumfield Division of American Machine & Foundry Company	163
Associated Research, Inc.	170	Gardner-Denver Company	144	Pyrofilm Resistor Co., Inc.	175
Atlas Fibre Co.	176	General Electric Company, Specialty Control Department	107		
Augat, Inc.	158	General Instrument Corporation	34, 35	RCA Electronic Components and Devices	15, 38, 39, Cover IV
Automatic Electric, A Subsidiary of General Telephone & Electronics	100	General Precision Inc., Kearfott Products Division	185	Raytheon Company, Sorensen Operation	147
		General Radio Company	2	Reeves Hoffman Division of DCA	166
Babcock Relays, Division of Babcock Electronics Corporation	88	Genisco Technology Corporation	153	Rowan Controller Co., The	25
Ballantine Laboratories, Inc.	151	Giannini-Voltex	150		
Beede Electrical Instrument Co., Inc.	142	Guardian Electric Manufacturing Company	167	San Fernando Electric Mfg. Co.	158
Bishop Industries	206			Schweber Electronics	205
Blue M Electric Company	146	Hamilton Standard, Division of United Aircraft Corporation	173	Signalite, Incorporated	116, 165
Bodine Electric Company	179	Hammel Riglander & Co. Inc.	205	Signetics Integrated Circuits, A Subsidiary of Corning Glass Works	159
Booker & Wallestad	164	Hayden Book Company, Inc.	189, 207	Silicon Transistor Corporation	79
Boonton Electronics Corporation	54	Haydon Switch & Instrument Inc.	140	Siliconix Incorporated	12
Bourns, Inc.	135	Hewlett-Packard, Sanborn Division	53	Singer Company, The—Metrics Division	156
Brand Rex, Division of American Enka Corporation	128	Hewlett-Packard Cover II, 4, 5, 103, 161, 197	28	Solitron Devices, Inc.	137
Branson Corp.	194	Honeywell, Computer Control Division	28	Sonotone Corporation	192, 193
Bulova Electronics Division of Bulova Watch Company	99			South Bay Cable Company	176
Bunting Magnetics Co.	206	IBM Data Processing Division	7	Sperry Rand Corporation	115
		IMC Magnetics Corporation	178	Sprague Electric Company	10
CTS of Berne, Inc.	199	IRC, Inc.	42, 43	Syntron Company	155
Chassis-Trak Inc.	154	ITT Semiconductors, A Division of International Telephone and Telegraph Corporation	208		
Chatham Products Tung-Sol Division, Wagner Electric Corporation	169	Ideal Precision Meter Co. Inc.	166	Takeda Ricken Industry Co. Ltd.	184
Cinch-Graphik, Division of United-Carr Incorporated	187	Industrial Timer Corporation	190	Tektronix, Inc., Oscilloscopes	60
Clare & Co., C. P.	37	Ingersoll Products, Division of Borg Warner Corporation	127	Temescal Metallurgical Corp.	56
Clifton, Division of Litton Industries	195	International Electronic Research Corporation	85	Tenney Engineering, Inc.	160
Cohu Electronics Inc.	31			Texas Instruments Incorporated	66, 67
Components, Inc.	152	James Electronics, Inc.	136	Trio Laboratories, Inc.	177
Connor Winfield Corp.	200	Johanson Manufacturing Corp.	168	Triplett Electrical Instrument Company	49
Consolidated Vacuum Corporation	87				
Continental Device Corporation	72, 73	K.K.C. Shokai Ltd.	182	Ulano	65
Cornell-Dubilier Electronics	16	Kidde & Company, Inc., Walter	141	Union Carbide Corporation	27
Cross Company, H.	45				
Curtis Development & Mfg. Co.	207	LVC Industries, Inc.	200	Vector Electronic Co. Inc.	186
Cutler-Hammer	41	Lambda Electronics Corp.	131	Victory Engineering Corporation	32
		Line Electric Company	132		
Dale Electronics, Inc.	Cover III	Littelfuse	175	Wavetek	157
Datapulse Division of Datapulse, Inc.	2	Litton Industries, Electron Tube Division	171	Wheelock Signals, Inc.	183
Delco Radio, Division of General Motors	148, 149	Litton Industries, Encoder Division	113		
Deutsch Electronic Components Division	181			<i>Career Advertising</i>	
Digital Equipment Corporation	19	Mac Panel Company	109	Collins Radio Company	124, 125
Digitran Company, The	48	Mallory & Co., Inc., P. R.	8, 9	Electronic Communications, Inc.	122
Dranetz Engineering Laboratories, Inc.	190	Markel C Sons L. Frank	191	Hughes Aircraft Company Aerospace Divisions	122
Dzus Fastener Co., Inc.	207	Master Specialties Company	55	Litton Industries, Guidance & Control Systems	126
		Matsuo Electric Co., Ltd.	162	LTV Electrosystems, Inc.	123
Eagle Signal, A Division E. W. Bliss Company	78			Lockheed Missiles & Space Company	121
Eastman Chemical Products, Inc.	172			Univac, A Division of Sperry Rand Corporation	118

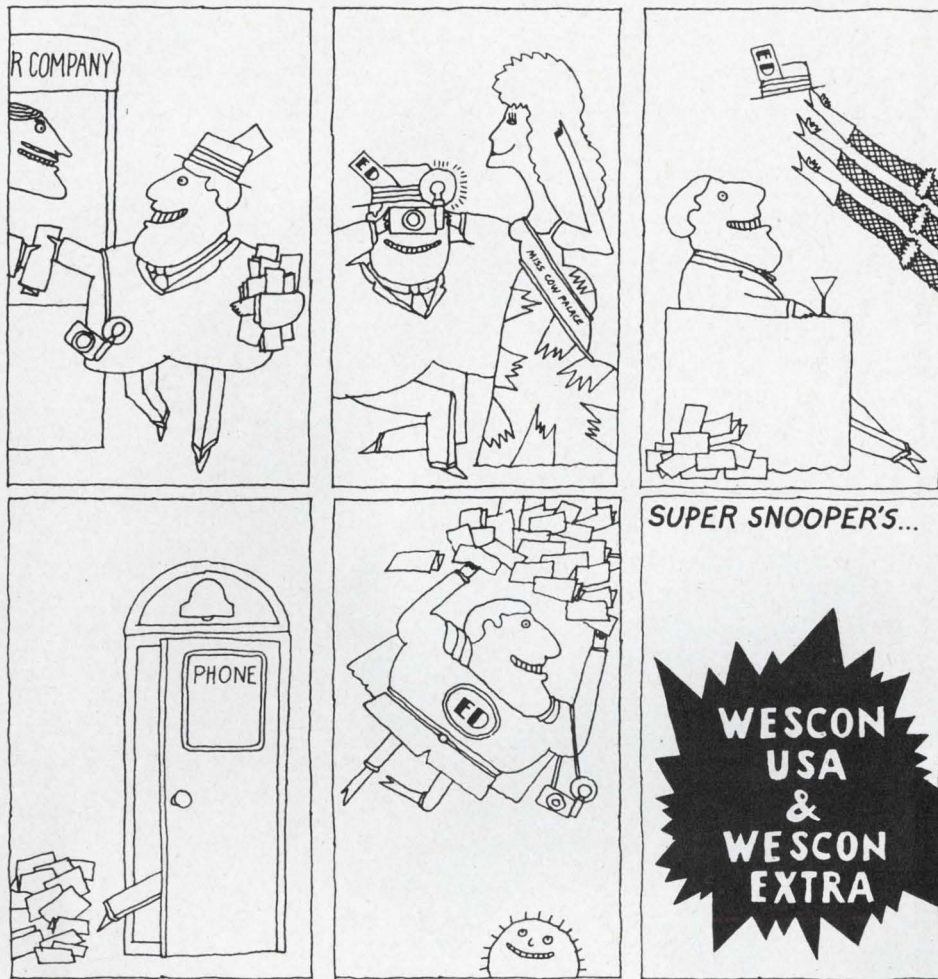

SELL PRIOR TO THE SHOW IN **WESCON USA**. YOUR PRODUCTS WILL BE SEEN BY **155,000 ENGINEERS AND ENGINEERING MANAGERS—THE MEN WHO SPECIFY**. **ELECTRONIC DESIGN'S SUPER SNOOPER** HAS BEEN WORKING VERY HARD ON **WESCON USA**... IT'S OUR REGULAR AUGUST 16<sup>TH</sup> ISSUE, AND IT ALSO CONTAINS COMPLETE EDITORIAL ON THE SHOW. **SUPER SNOOPER AND STAFF** WILL HAVE IT PACKED WITH **WESCON NEWS**, **WESCON NEW PRODUCTS**, **WESCON TECHNICAL SESSIONS** PLUS FEATURE ARTICLES ON THE SHOW AND **SAN FRANCISCO**. YOU CAN ALSO GET ADDITIONAL ATTENTION AT THE SHOW WITH **ELECTRONIC DESIGN'S WESCON EXTRA**... PUBLISHED FOR AND DISTRIBUTED AT THE SHOW... ITS **SUPER DUPER** COVERAGE OF PRODUCTS AND SESSIONS MAKES IT A MUST FOR MANUFACTURERS WHO WANT TO GET THE MOST OUT OF **WESCON**.

NOTE: ADVERTISE IN THE AUGUST 2 ISSUE OR AUGUST 16 (**WESCON USA**) ISSUE AND YOUR ADVERTISEMENT CAN ALSO RUN IN THE **EXTRA** FOR A SMALL PREMIUM. THE **EXTRAS** (15,000 OF THEM) ARE DISTRIBUTED AT SHOW TIME AT THE **COW PALACE** AND AT HOTELS THROUGHOUT **SAN FRANCISCO**. CALL YOUR **ELECTRONIC DESIGN** REPRESENTATIVE OR ED CLANCY 212 PLAZA 1-5530 FOR ALL THE DETAILS ON THIS SUPER BARGAIN. DON'T DELAY, CALL ED TODAY... **AUGUST 2 (A READER RECALL ISSUE) CLOSSES JULY 3. AUGUST 16 (WESCON USA) CLOSSES JULY 17.**

# IMPACT

Union Carbide Electronics, Mountain View, California has just placed the largest exclusive advertising campaign in magazine publishing history.

Their objective: To become an even greater factor in the fast-paced twenty-one billion dollar electronics industry.

Their campaign: 138 pages over the next 12 months.

Their magazine: **Electronic Design.**

Union Carbide Electronics and their agency, Hal Lawrence, Inc., decided the best return on their advertising investment would be achieved by concentrating in the magazine read by the greatest number of their prime customers and prospects.

They backed up their decision by scheduling multi-page semiconductor advertise-

ments in every bi-weekly issue of **Electronic Design.**

Advertisements that will be selling the men who specify what goes into what the sales department sells, the accounting department accounts, the production department produces.

138 pages over the next 12 months . . . that's **impact.**



## Electronic Design

**MOST READ BY THE MEN WHO SPECIFY**

Winner of Industrial Marketing and Jesse Neal Awards for Editorial Excellence in 1966

Hayden Publishing Co., Inc., 850 Third Avenue, New York 10022

Publishers of **Electronic Design** and **Microwaves** Magazines... Hayden, Rider and Ahrens Books

# Electronic Design Design Data from Manufacturers

Advertisements of booklets, brochures, catalogs and data sheets. To order use Reader-Service Card.

(Advertisement)

## Advertising Representatives

### New York 10022

Robert W. Gascoigne  
Thomas P. Barth  
Samuel M. Deitch  
William C. Repetto  
850 Third Avenue  
(212) PLaza 1-5530  
TWX: 867-7866

### Philadelphia

P. O. Box 206  
Merion Station, Pa. 19066  
(215) MO 4-1073

### Boston

Richard Parker  
7 Redstone Lane  
Marblehead, Mass. 01945  
(617) 742-0252

### Chicago 60611

Thomas P. Kavooras  
Berry Conner, Jr.  
720 N. Michigan  
(312) 337-0588

### Cleveland

(216) 247-7670

### Los Angeles 90303

Stanley I. Ehrenclou  
Terrence D. Buckley  
W. James Bischof  
2930 W. Imperial Highway  
Inglewood, Calif.  
(213) 757-0183

### San Francisco

Ashley P. Hartman  
175 South San Antonio Rd.  
Ste. 243  
Los Altos, Calif. 94022  
(415) 941-3084

### Southwestern 75206

Tommy L. Wilson  
6200 North Central Expressway  
Dallas, Tex.  
(214) EMerson 1-2311

### London W. 1

Brayton C. Nichols  
44 Conduit Street

### Verviers, Belgium

Andre Jamar  
1, Rue Mallar, 1  
(087) 253.85

### Tokyo

Yoshihiro Takemura  
International Planning  
Service, Inc.  
Room 231 Tokyu-Mita Bldg.  
1, Shiba-Mita Koun-cho  
Minato-ku, Tokyo



## Your New Electronics Hand Tool Catalog



The finest Peer Swiss made tweezers for all micro-miniature work. 42 different patterns in all alloys. SWEDISH PLIERS that feature the "Box Joint" construction by Lindstrom, for all your precision work.

CUTTING TWEEZERS, NIPPERS AND SCISSORS for special wire cutting problems in different areas.

Many other useful tools.

Write today—for your Catalog 167.

## Hammel, Riglander & Co., Inc.

P. O. Box 222  
New York, N. Y. 10014

**171**

## Introduction to Digital Electronics

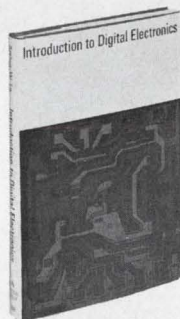

Engineers in digital systems, solid-state electronics, and computer science: Here is the first reference text to treat digital operations of various types of devices and circuits as a unified subject.

Written by Arthur W. Lo, Princeton University, the book covers: operation modes of switching elements (transistors, cryoelectric and optoelectric devices, magnetic and negative-resistance devices); major circuit configurations; random access memories. Ample references enhance the book's value. 223 pp, 207 illus. (1967) \$10.75. Send for your free 10-day examination copy by circling number.

## Addison-Wesley

Publishing Company, Inc.  
Reading, Mass. 01867

**172**

## Solids Go Established Reliability



Users of solid tantalum capacitors who wish to take the road to Established Reliability can now obtain a conversion chart MIL-C-26655B to MIL-C-39003A. Clarification of differences between the requirements of the two specs are included as well as comparison and cross reference charts of superseded parts. Since the new mil spec numbers are non-descriptive, this 8-page chart will enable you to check capacity and voltage when working from MIL-C-39003A numbers and vice versa.

## Schweber Electronics

Westbury, New York 11591  
516-334-7474

**173**

# Electronic Design

ELECTRONIC DESIGN's aim is fourfold. It aids progress in the electronics manufacturing industry by promoting good design. It gives the electronic design engineer concepts and ideas that will make his job easier and more productive. The magazine serves as a central source of timely, up-to-the-minute electronics information. And finally it seeks to encourage two-way communication between manufacturer and engineer.

**Want a subscription?** ELECTRONIC DESIGN is circulated free of charge to qualified engineers and engineering management doing design work, supervising design or establishing standards in the United States, Western Europe and the United Kingdom. If you think that you are entitled to a free subscription, use the postfree application form that you will generally find inside the back cover. When it is not included, write to us direct for an application form.

If you are not qualified, you may take out a paid subscription at the following rates: \$25 a year if you live in the U.S.A. or \$35 a year if you live elsewhere. Single copies may be purchased for \$1.50 each.

**If you change your address,** send us an old mailing label and your new address; there is generally a prepaid postcard for this inside the back cover. If you have been receiving ELECTRONIC DESIGN free of charge, you will have to requalify to continue doing so.

**We strive for accuracy.** We take the utmost pains to ensure the highest standard of accuracy throughout the magazine. A single mistake in practical design information can have serious consequences. But to err is human, and for all the care we take, an occasional error slips through. Whenever this occurs, we publish a correction at the earliest opportunity. You will find these corrections printed at the end of the Letters column. If you should spot an error, be sure to let us know. You may save your colleagues heartaches.

**Microfilm copies are available** of complete issues of ELECTRONIC DESIGN that have been published since the beginning of 1961, and of single articles. Complete issues cost 4¢ a page, individual pages cost 50¢ each; shipping and handling charges are extra. The minimum charge is \$3; delivery time runs from 10 days for single pages to five weeks for complete issues. For further details and to place orders, get in touch directly with University Microfilms, Inc., 300 N. Zeeb Road, Ann Arbor, Mich. 48106; telephone (313) 761-4700.

**Want to contact us?** If you have any inquiries about these or other matters, or if you have a manuscript outline or article idea, address your correspondence to:

Howard Bierman, Editor,  
ELECTRONIC DESIGN,  
850 Third Avenue,  
New York, N.Y. 10022.

## Design Data from

### Laminated and Molded Bus Bars For Power Distribution

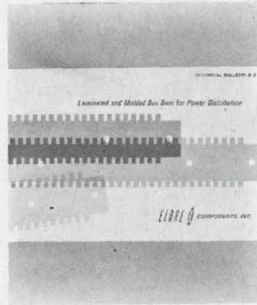

A 16 page Technical Bulletin is now available, describing a new concept in power distribution. Basic mechanical and electrical design principles, along with descriptive pictures and diagrams, are included in this bulletin. These compact buses can replace bulky cable harnesses and repetitive wiring for computer or modular application. This method of construction satisfies the demanding requirements of low inductance and resistance of high speed, solid state systems, while controlling electrical noises.

**Eldre Components, Inc.**  
1239 University Avenue  
Rochester, New York 14607

**174**

### The Magnet That Can't Be Demagnetized



New Bulletin 267-1 shows how to use Bunting Insulated Cylindrical Permanent Ceramic Magnets.

These versatile magnetic components resist demagnetization by vibration and electrical fields. Unlimited uses in holding, transferring, feeding and stabilizing materials and parts. No insulation required, can be mounted directly in steel. Complete range of sizes with magnetic strengths up to 45 lbs. holding force. 25 standard sizes in stock for immediate delivery.

**Bunting Magnetics Co.**

9245 Cherry Street  
Franklin Park, Illinois 60131

**175**

### Engineers' Relay Handbook

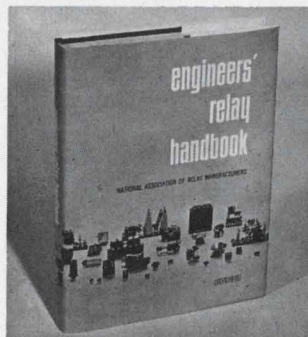

A definitive work that is fast becoming a standard reference text for the relay user. Prepared and edited by the National Association of Relay Manufacturers, this book is a complete guide to the principles, properties, performance characteristics, application requirements, specifications, and testing of relays. Systems and product engineers will find the Handbook an indispensable help in determining the correct types of relays for their applications. For further information about this unique sourcebook, write Dept. ED.

**Hayden Book Co., Inc.**

116 W. 14th Street  
New York, N. Y. 10011

**176**



# Manufacturers

Advertisements of booklets, brochures, catalogs and data sheets. To order use Reader-ServiceCard.

## Terminal Block Selector



A new 24-page, completely illustrated catalog contains photos, descriptions, ratings, engineering drawings, and prices of the complete line of Curtis terminal blocks. Included are printed circuit, insulated feed-thru, quick disconnect, track type, and high current terminal blocks. Handy selection chart quickly locates the perfect block for your particular requirements. Send today for your free copy. See us at WESCON, Booth 1013

**Curtis Development & Mfg. Co.**  
3236 North 33rd Street  
Milwaukee, Wisconsin 53216

**177**

## Quality Fasteners For All Design Applications



This 8-page catalog provides design data on the complete group of DZUS 1/4-turn self-locking fasteners for standard, high speed and panel applications, as well as universal high strength multiple thread fasteners for high tensile and shear stresses. Dzus stud assemblies, wire forms and receptacles offer an exceptional, wide variety of combinations from stock to fit specific fastening requirements. Diagrams and tables give full details for rapid, unlimited design selection. Condensed Catalog No. S-2 or comprehensive Catalog No. D-3 are available on request.

**Dzus Fastener Co., Inc.**  
Division 32  
425 Union Boulevard  
West Islip, L. I., N. Y. 11795

**178**

## Free Electronic Circuit Symbol Catalog

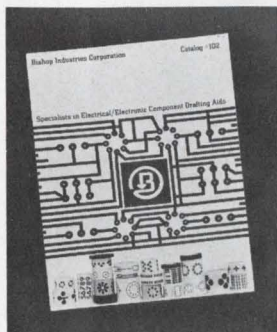

Save artwork and drafting time cut costs with thousands of electronic drafting aids and symbols featured in the new 28-page Catalog No. 102 from Bishop. In it are the industry's only selection of predrawn complete circuit component symbols; integrated circuits, logics, semiconductors, flatpacks, transistors, printed circuits, welded modules, etc. Also: tapes, pads, corners, connectors, schematic symbols, reference numbers and more. Included are illustrations, range of sizes and complete price information. Send today for your free copy.

**Bishop Industries Corp.**  
11728 Vose Street  
North Hollywood, California 91605

**179**

# Designer's Datebook

JULY						
S	M	T	W	T	F	S
						1
2	3	4	5	6	7	8
9	10	11	12	13	14	15
16	17	18	19	20	21	22
23	24	25	26	27	28	29

AUGUST						
S	M	T	W	T	F	S
6	7	8	9	10	11	12
13	14	15	16	17	18	19
20	21	22	23	24	25	26
27	28	29	30	31		

For further information on meetings, use Reader Service card.

**July 18-20**  
**Electromagnetic Compatibility Symposium** (Washington, D. C.)  
Sponsor: IEEE; J. S. Hill, Genisco Technology Corp., 10774 Tucker St., Beltsville, Md. 20705

CIRCLE NO. 469

**July 24-28**  
**Design Course on Automatic Electronic Test Equipment** (New York City)  
Sponsor: New York University; D. M. Goodman, N.Y.U. School of Engineering and Science, 401 W. 205 St., New York, N. Y. 10034.

CIRCLE NO. 470

**July 31-August 4**  
**Research Conference on Instrumentation Science** (Geneva, N. Y.)  
Sponsor: ISA; Instrument Society of America, 530 William Penn Place, Pittsburgh, Pa. 15219

CIRCLE NO. 471

**Aug. 13-17**  
**Intersociety Energy Conversion Engineering Conference** (Miami Beach)  
Sponsor: ASME, IEEE *et al.*; A. Merrick Taylor, Douglas Aircraft Corp., Inc., Santa Monica, Calif. 90406

CIRCLE NO. 472

**Aug. 22-25**  
**Western Electronic Show and Convention** (San Francisco)  
Sponsor: WEMA; Ted Shields, WESCON, 3600 Wilshire Blvd., Los Angeles, Calif. 90005

CIRCLE NO. 473

**Aug. 29-31**  
**Conference on Engineering Applications of Electronic Phenomena** (Ithaca, N. Y.)  
Sponsor: Cornell University, IEEE, ONR; Conference Committee, School of Electrical Engineering, Philips Hall, Cornell University, Ithaca, N. Y. 14850

CIRCLE NO. 474

# Every ITT 2N3375 gives you 66% more $P_{OE}$ than EIA specs demand

28V CLASS B POWER OUTPUT VS FREQUENCY

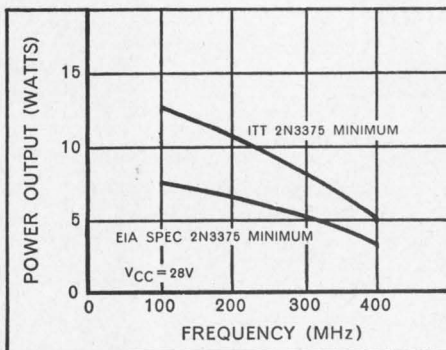

When you apply ITT 2N3375s, you get 5 watts minimum saturated power output at 400 MHz and  $V_{CC}=28$  V, tested 100%.

The secret lies in ITT's unusually close control of resistivity, combined with interdigitated construction.

To find out more about the superior performance of the ITT 2N3375, write today for your free copy of "VHF/UHF Power Transistor Amplifier Design" and complete 2N3375 specs. Or see for yourself — order sample quantities off-the-shelf from your ITT distributor or factory representative. ITT Semiconductors is a division of International Telephone and Telegraph Corporation, 3301 Electronics Way, West Palm Beach, Florida.

**ITT**  
SEMICONDUCTORS

FACTORIES IN WEST PALM BEACH, FLORIDA, PALO ALTO, CALIFORNIA, LAWRENCE, MASSACHUSETTS; HARLOW AND FOOTSCRAY, ENGLAND; FREIBURG AND NUREMBURG, GERMANY

ON READER-SERVICE CARD CIRCLE 224

**DALE**

# Carbon Film Resistors used by RCA for Video Data Terminal

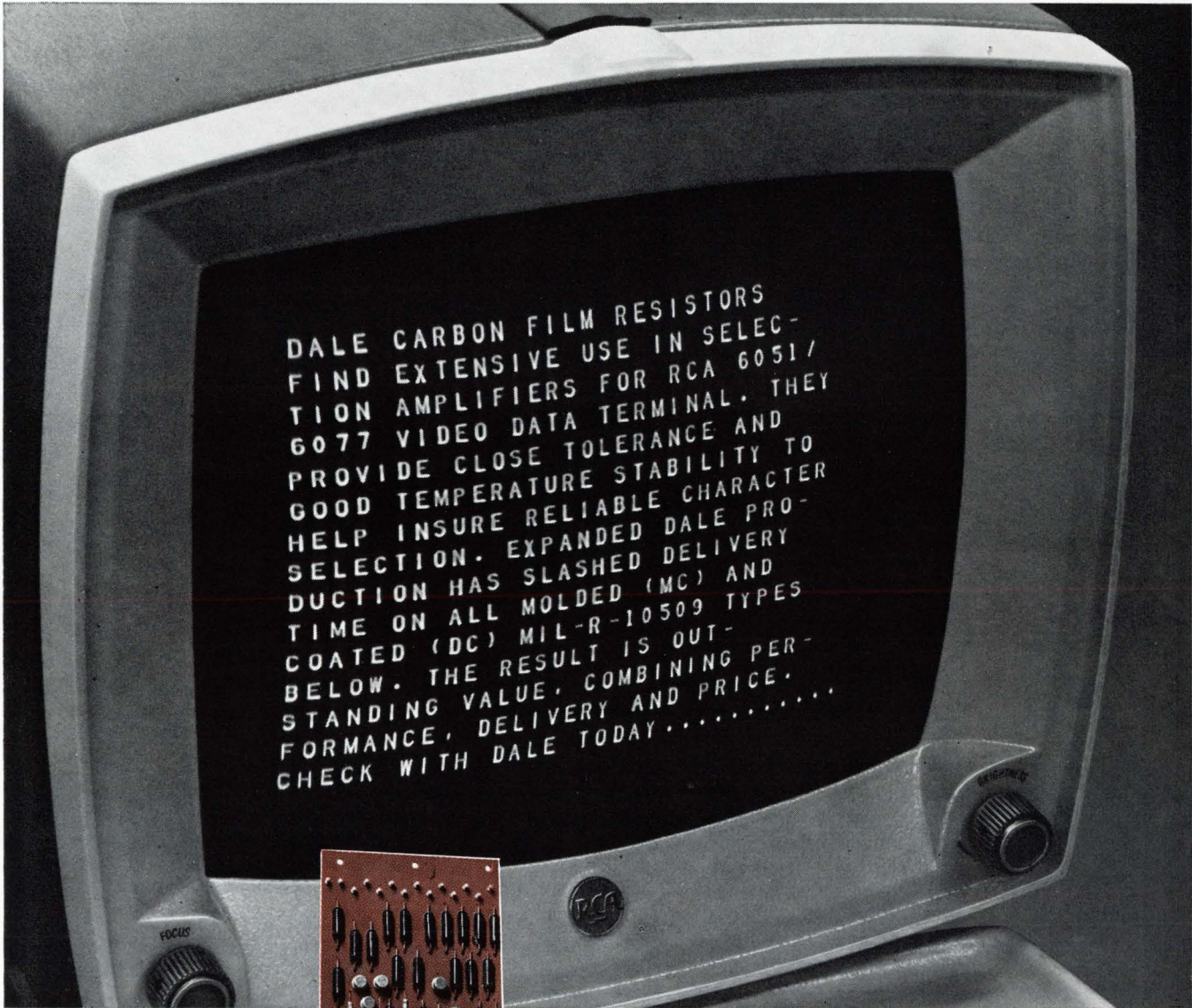

DALE CARBON FILM RESISTORS  
FIND EXTENSIVE USE IN SELEC-  
TION AMPLIFIERS FOR RCA 6051/  
6077 VIDEO DATA TERMINAL. THEY  
PROVIDE CLOSE TOLERANCE AND  
GOOD TEMPERATURE STABILITY TO  
HELP INSURE RELIABLE CHARACTER  
SELECTION. EXPANDED DALE PRO-  
DUCTION HAS SLASHED DELIVERY  
TIME ON ALL MOLDED (MC) AND  
COATED (DC) MIL-R-10509 TYPES  
BELOW. THE RESULT IS OUT-  
STANDING VALUE, COMBINING PER-  
FORMANCE, DELIVERY AND PRICE.  
CHECK WITH DALE TODAY.....

For a better  
quote and faster  
carbon film  
delivery... phone  
Dale today at  
402-564-3131.  
Write for  
resistor  
Catalog A.

## DALE CARBON FILM SPECIFICATIONS

DALE TYPE	MIL. TYPE	POWER RATING (WATTS)		MINIMUM RESISTANCE (OHMS)	MAXIMUM 1% RESISTANCE (OHMS)	MAXIMUM 2% RESISTANCE (OHMS)
		B*	D			
DC-1/10 MC-1/10	— RN-55	1/10 1/10	— 1/8	2	400K	400K
DC-1/8 MC-1/8	— RN-60	1/8 1/8	— 1/4	1	3 M $\Omega$	5 M $\Omega$
DC-1/4 MC-1/4	RN-10 RN-65	1/4 1/4	— 1/2	1	5 M $\Omega$	6 M $\Omega$
DCS-1/2 MCS-1/2	RN-20 RN-70	1/2 1/2	— 3/4	1	10 M $\Omega$	15 M $\Omega$
DC-1 MC-1	RN-25 RN-75	1 1	— —	1	15 M $\Omega$	30 M $\Omega$
DC-2 MC-2	RN-30 RN-80	2 2	— —	2	100 M $\Omega$	125 M $\Omega$
DC-5	—	5	—	5	150 M $\Omega$	300 M $\Omega$

Tolerance:  
.5%, 1%, 2%  
\*DC resistors  
meet Char. B,  
MIL-R-10509D  
requirements,  
but are  
dimensionally  
smaller.

**DALE****DALE ELECTRONICS, INC.**

1328 28th Ave., Columbus, Nebraska 68601  
In Canada: Dale Electronics Canada, Ltd.

SEE OUR SPECIFICATIONS IN  
**VSMF**  
THE MICROFILM CATALOG FILE

# From RCA "overlay"...

## The industry's best performing plastic RF-power transistor...

### 15 Watts min at 400 MHz

2N5017

Now... get in on the action with the rf-power advantages of RCA "overlay" in plastic!

RCA's new 2N5017 stud-mounted plastic transistor provides 15 watts at 400 MHz... 22 watts typ. at 225 MHz... operates from 28-v supply! And this circuit capability is delivered in a unique package that sets new standards for performance, ruggedness, and versatility at VHF and UHF frequencies.

**Performance**—the industry's lowest emitter and base inductances (0.1 nH and 0.2 nH respectively) result in optimum gain and power

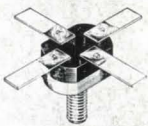

Strip-line leads can be easily soldered to terminal block with pins providing additional mechanical strength.

capability right up to 700 MHz... efficient for broadband and narrowband transmitters.

**Ruggedness**—unexcelled mechanical strength with short "anchor" pins eliminating problems due to lead breakage or vibration.

**Versatility**—"terminal block" structure permits choice of stripline, printed circuit (both flush and bottom-mounted), or lumped circuit mounting.

Call your RCA Representative today for more information on the 2N5017 for military, microwave, and industrial communications usage. If your applications still call for hermetically sealed packages, ask him about the RCA 2N5016—it offers similar electrical performance but in the popular TO-60 case. For technical data, write RCA Commercial Engineering, Section 1G/-1, Harrison, N.J. 07029.

Also Available From Your RCA Distributor

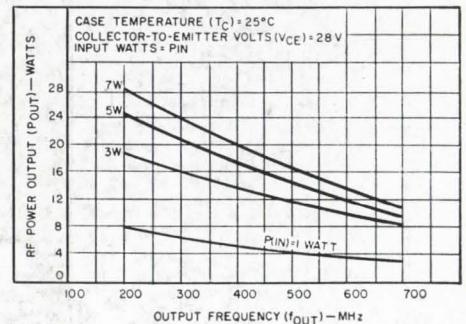

RCA Electronic Components and Devices

ON READER-SERVICE CARD CIRCLE 234



The Most Trusted Name in Electronics