

EDN[®]

ELECTRONIC TECHNOLOGY FOR ENGINEERS AND ENGINEERING MANAGERS WORLDWIDE

PROCESSOR UPDATES
PG 83

A CAHNERS PUBLICATION

April 9, 1992

Special Report: An inside look at Windows for engineering software

pg 122

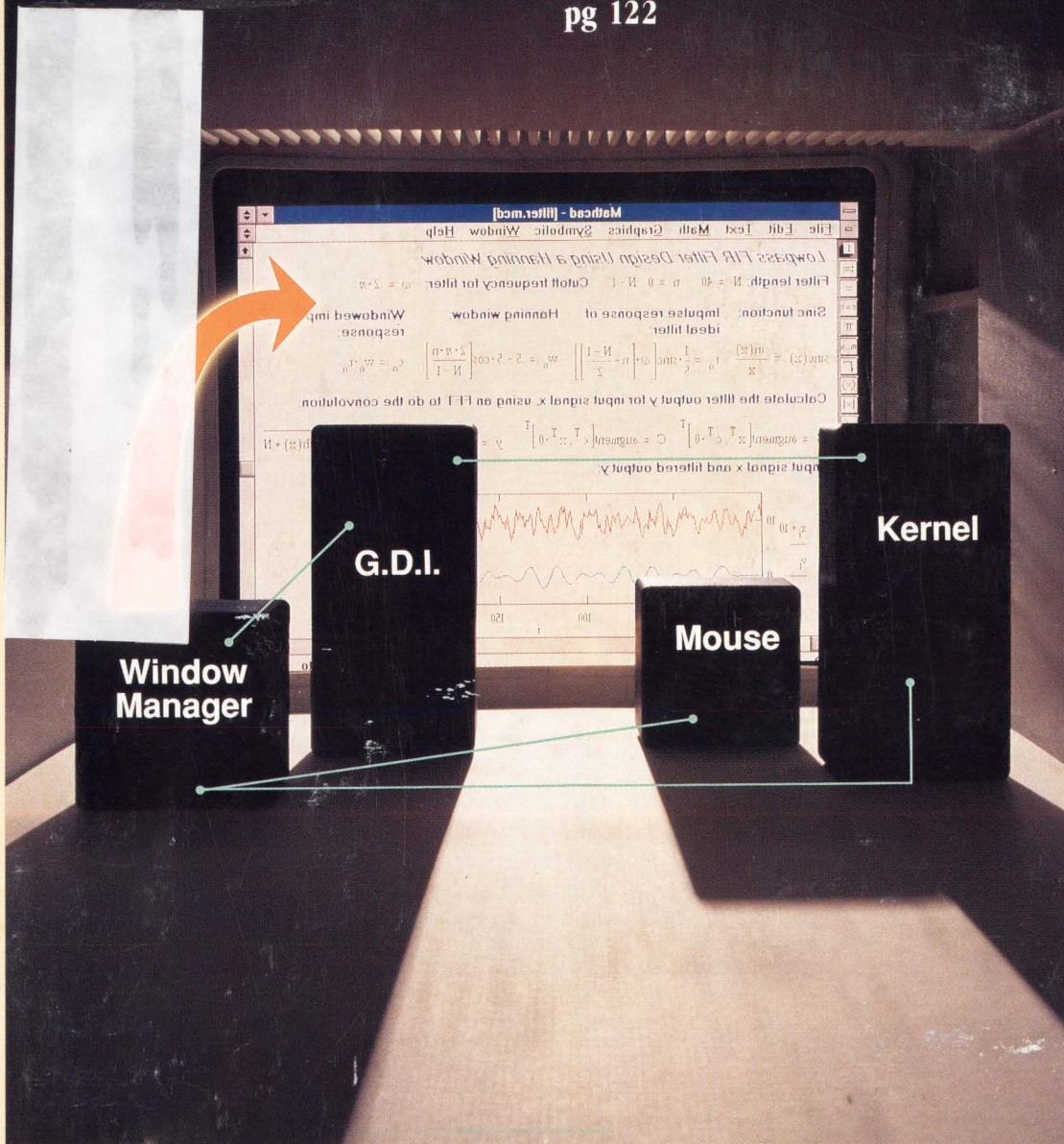

SPECIAL PROJECT

Hands-on FPGA
design project
Part 1
pg 98

SPECIAL REPORT

Windows and
engineering
software
pg 122

DESIGN FEATURE

Improve
reliability by
rigging pc boards
for in-circuit
programming
pg 135

TECHNOLOGY UPDATES

Design software
links active-filter
performance
with real devices
pg 45

FDDI routers and
bridges create
niche for content-
addressable
memories
pg 61

Product Updates
pg 73

HP scopes make digital designs easier to understand.

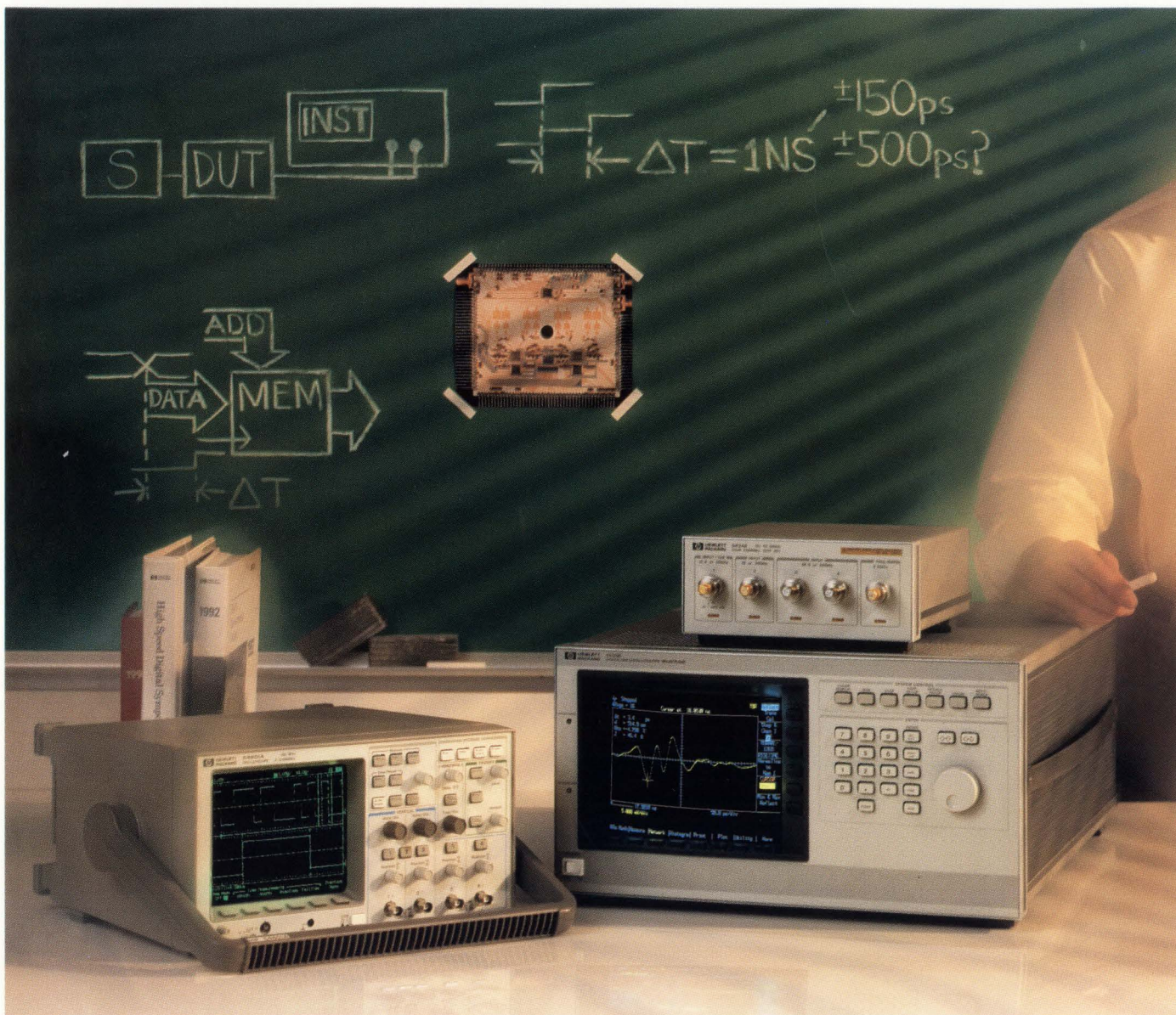

© 1992 Hewlett-Packard Co. TMCOL133A/EDN

Now there's a way to get the information you need.

Experience is the best teacher. And since 1980, HP has developed digitizing scope technology to help you understand how well digital designs are working. Or why they aren't.

When high-speed signal integrity issues are problems, the 50 GHz HP 54124 helps you learn why. If you need to make precision single-shot measurements, you can't go wrong with the 1 GSa/s, 4 channel HP 54512. And for general-purpose

use, the HP 54600 offers the look and feel of analog with the power of digital.

And scopes are only part of the picture. HP's unique high-speed digital symposium sheds light on leading-edge digital design issues. In-depth information on techniques and methods is available through seminars, application notes, and HP's worldwide network of field engineers and product specialists.

So, if you want a better under-

standing of digital designs, call **1-800-452-4844**. Ask for **Ext. 2890**,* and we'll send an information packet that explains how HP can help you find the answers.

There is a better way.



* In Canada call 1-800-387-3867, Dept. 440.

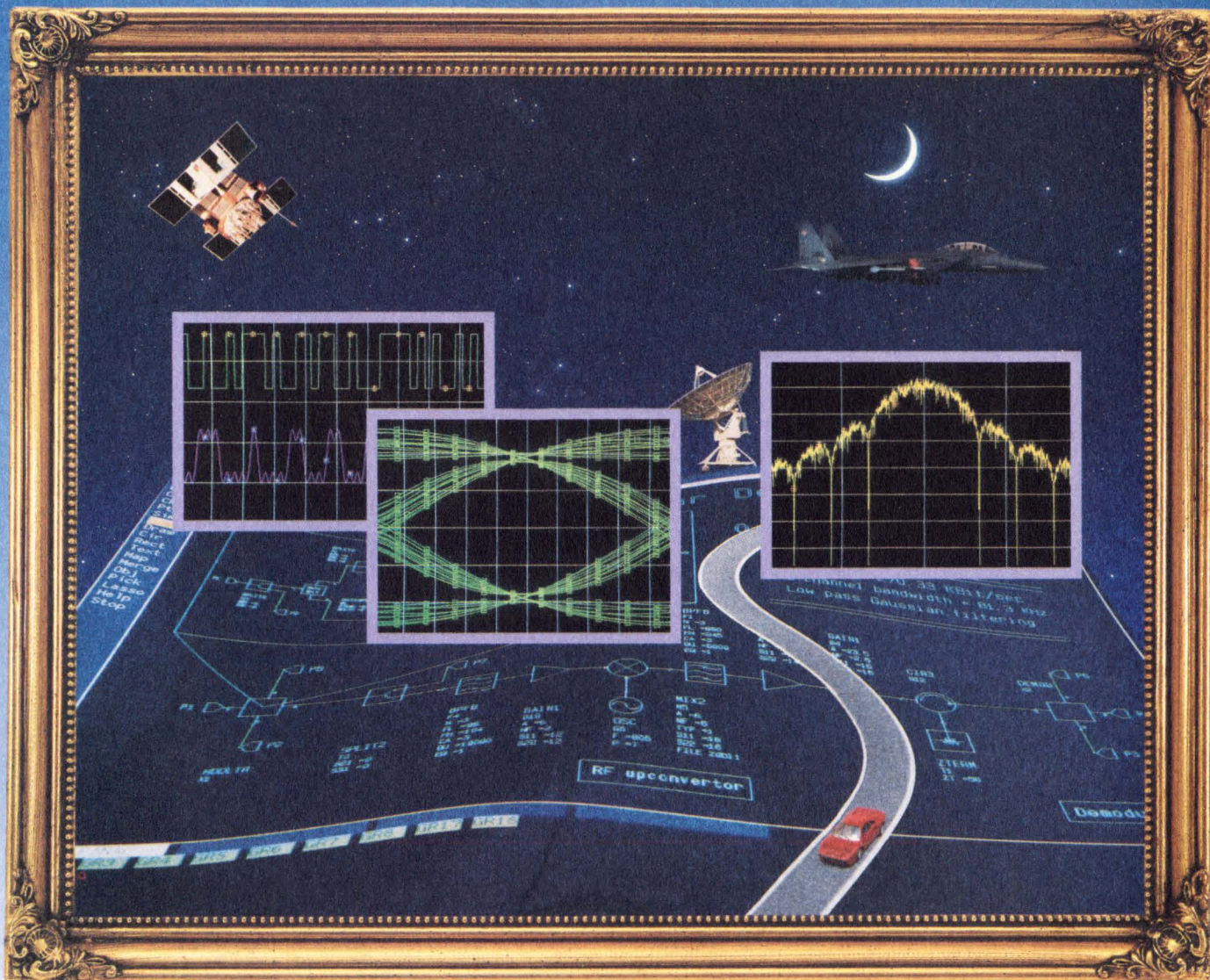

Modulation-Domain Simulation Gives You the Big Picture.

Introducing OmniSys Version 3.5.

Analyzing communication systems and complex modulated signals with the usual simulators? *Time-* and *frequency-*domain simulators like SPICE and harmonic balance are great, but circuit simulators don't give you the big picture. OmniSys®, EEsof's system simulator, gives you the new insight you need!

OmniSys lets you simulate system performance in the *modulation-domain* so you can see how your system will work with today's chirp, MSK, pi/4 DQPSK, and other complex modulated signals. Look at BER I-Q constellations, spectral regrowth, AM/PM distortion, and more. You'll see the effect of hardware trade-offs on your complete transmitter and receiver and you'll get your system to market faster without costly redesigns.

See the Big Picture with OmniSys.

Contact us for literature at (800) 34-EESOF...or, if you prefer, by FAX at (818) 879-6462. In Europe, call (49) 8105-24005 or FAX (49) 8105-24000.



Breaking the Barriers...

EEsof®

Configuration, Diagnostics Log Data to File Help Quit!
Data Acquisition and Control System

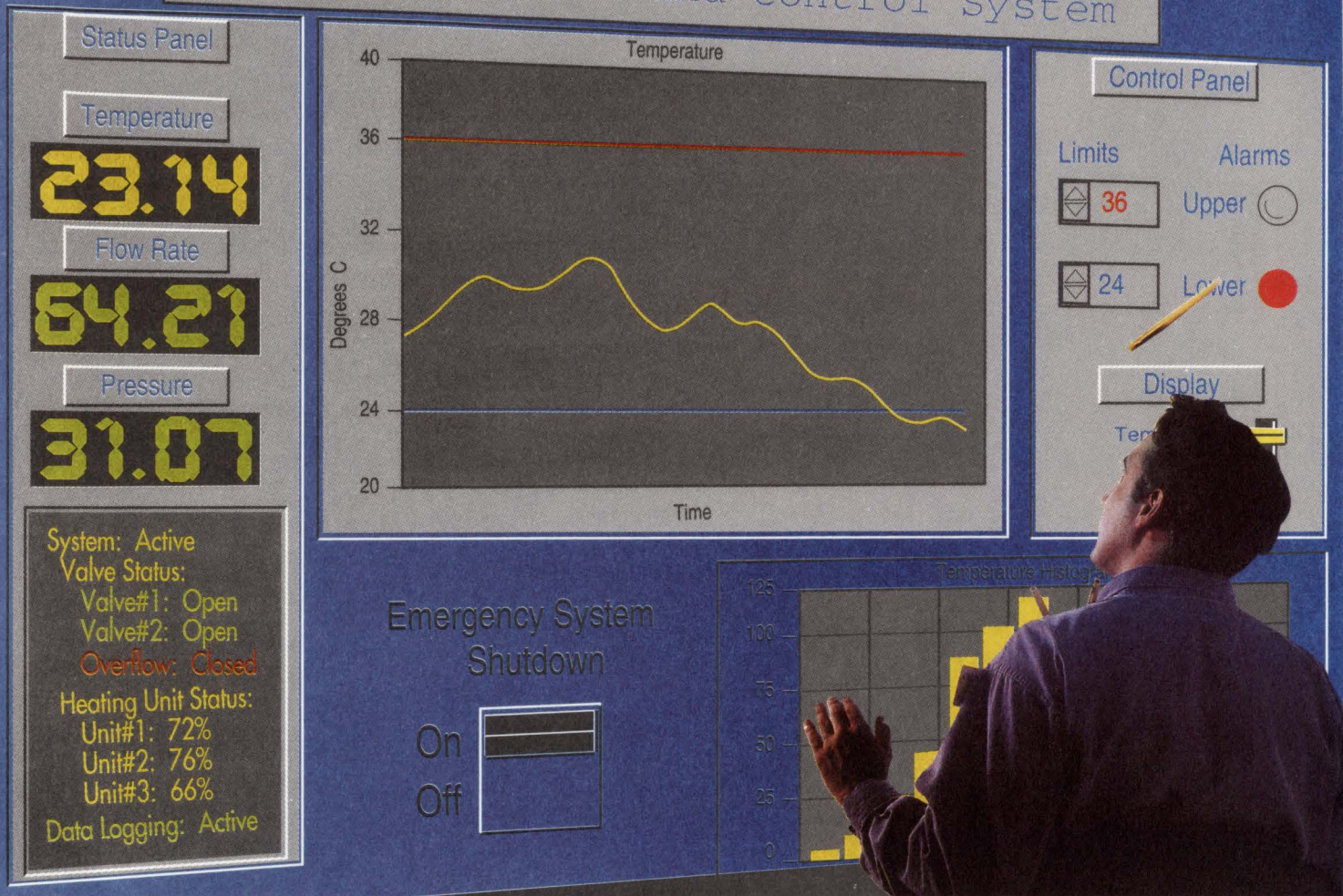

1. Install Data Acquisition Board
2. Turn on Computer
3. Launch LabWindows

When you start LabWindows®, you'll have all the software you need to develop your data acquisition and control system. LabWindows is a data acquisition, data analysis, and graphical presentation system — all in one. And it's backed by a complete line of plug-in boards and SCXI signal conditioning modules.

The Choice for Data Acquisition
With LabWindows, you can use any National Instruments plug-in board ranging

from low-cost to high performance. Select from A/D, D/A, digital I/O, timing I/O, or DSP boards for the PC/XT/AT/EISA and IBM PS/2. And now, with our *DAQ Designer™* system configuration software tool, you can easily determine the best plug-in boards and signal conditioning products for your application.

If you're ready to launch your data acquisition development, *Take a Look at LabWindows.*

For a **free** LabWindows Demo disk and your **free** copy of DAQ Designer call us at **(512) 794-0100** or **(800) 433-3488** (U. S. and Canada)

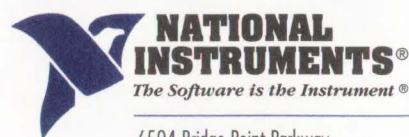

6504 Bridge Point Parkway
Austin, TX 78730-5039
Fax: (512) 794-8411

BRANCH OFFICES AUSTRALIA 03 879 9422 • BELGIUM 02 757 00 20 • CANADA 519 622 9310 • DENMARK 45 76 73 22 • FRANCE 1 48 65 33 70 • GERMANY 089 714 50 93
ITALY 02 48301892 • JAPAN 03 37881921 • NETHERLANDS 01720 45761 • NORWAY 03 846866 • SPAIN 91 896 0675 • SWEDEN 08 98 49 70 • SWITZERLAND 056 45 58 80 • U.K. 0635 523545

Product names listed are trademarks of their respective manufacturers. Company names listed are trademarks or trade names of their respective companies. © Copyright 1992 National Instruments Corporation. All rights reserved.

See us at Electro, booth 2201

Circle No. 2

THE TEMPUS™ CONNECTOR FROM ITT CANNON PROVIDES FASTER SIGNAL SPEED AND SPACE

Even if

SAVINGS. BOTH ARE ESSENTIAL WHEN DESIGNED FOR FUTUREBUS+. THIS INTERCONNECT

you're

SYSTEM MEETS WORLDWIDE DEMAND FOR HARD METRIC IN 2 MM PITCH. FOR DESIGN

not into

FLEXIBILITY, THE MODULES ARE STACKABLE. FOR INCREASED ELECTRICAL

Futurebus+,

PERFORMANCE, THE TEMPUS CONNECTOR HAS A SHORTER

this connector's

STUB LENGTH AND IS DESIGNED WITH A 45° CONTACT

still

ANGLE. LAPTOPS TO MAINFRAMES, IT MEETS HIGH

killer.

DATA RATE TRANSMISSION REQUIREMENTS.

CIRCLE NO. 3

ITT Cannon

1851 E. DEERE AVE., SANTA ANA, CA 92705-5720 (800) 845-7000

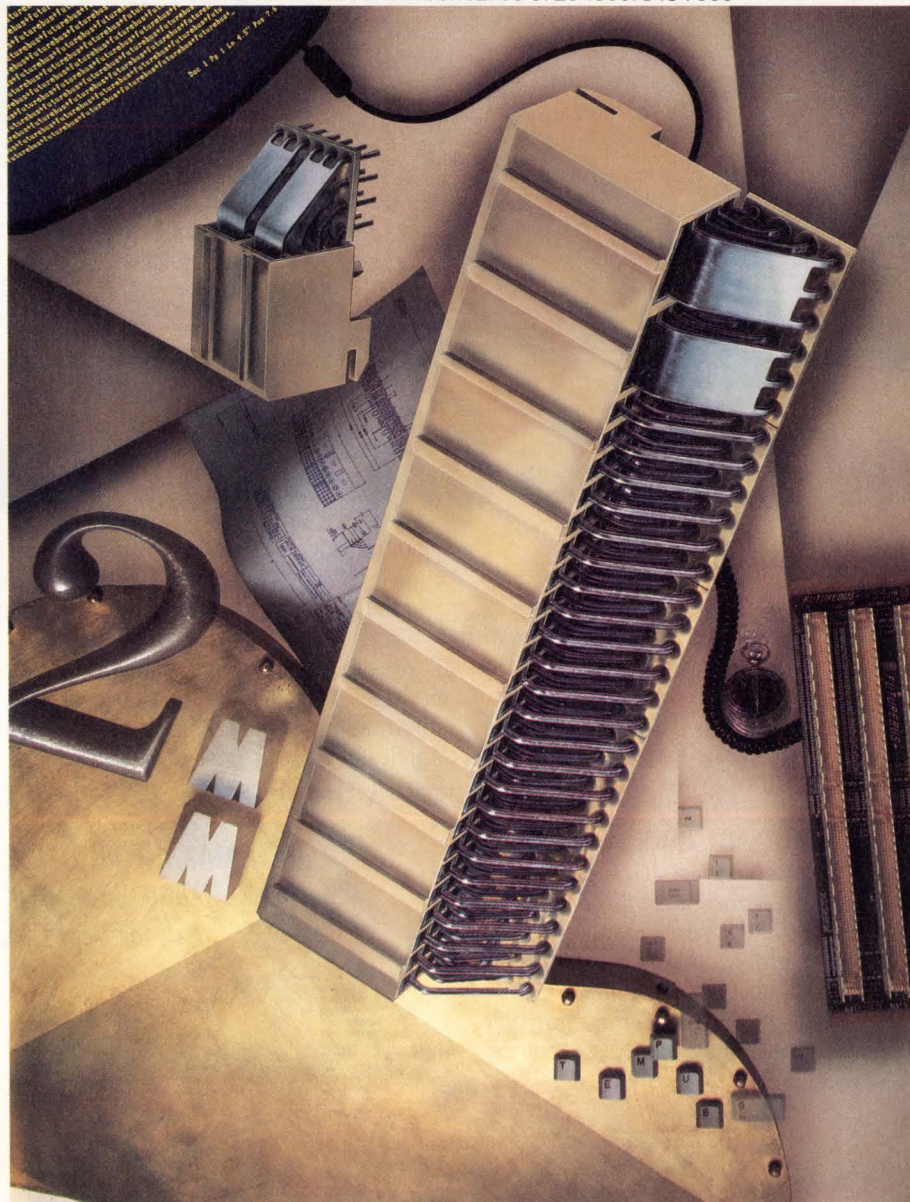

Destination	Flight	Gate	Status
FPGA	28 MHz	5000	DELAYED
GATE ARRAY	40 MHz	10000	DELAYED
FPGA Start-up	28 MHz	5000	CANCELLED
MAX EPLD	40 MHz	7500	BOARDING

Departures

High Performance Programmable Logic Seminars in Your Area. Don't miss them!
1-800-858-1810*. Ask for Dept. C42.

NOW TAKING OFF—MAX EPLD.

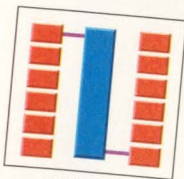

MAX® EPLD Architecture allows full utilization of 7,500 gates.

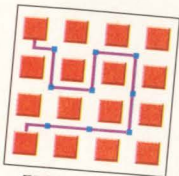

FPGA/Gate Array Architecture: prepare for lots of delays (speed depends on routing).

The 40 MHz PLD with Gate Array Capacity

If you want PLD design convenience with the density of FPGAs or gate arrays, Cypress has the best way to get you there without delay: our new MAX CY7C341 EPLD.

MAX 341's exclusive Logic Array Block (LAB) architecture always affords you the shortest interconnect path. Data glides between the 12 LABs with a singular, predictable interconnect delay. Count on full, 7,500 gate utilization, with no drop-off from MAX's 40 MHz performance. And MAX 341's nonvolatility and built-in security bit give you extra safety and stability.

Since MAX 341 is a field-programmable EPLD, you cruise above the NREs that can

cloud gate array solutions. You save even more in design-in time with MAX's PC-based development kit, which enables you to have a programmed solution in hours, not months.

Catch the entire MAX family of 28-, 44-, 68- and 84-pin devices in both (erasable) windowed ceramic or plastic packages. Call the Cypress hotline today for your free MAX information, including brochure and Data Book. Our Field Applications Engineers are ready to show you how MAX 341 can make your designs fly.

FREE MAX INFO HOTLINE:
1-800-858-1810*
Ask for Dept C41.



*In Europe, fax your request to the above dept. at (32) 2-652-1504 or call (32) 2-652-0270. In Asia, fax to the above dept. at 1 (415) 961-4201. © 1992 Cypress Semiconductor, 3901 North First Street, San Jose, CA 95134. Phone 1 (408) 943-2600, TELEX: 821032 CYPRESS SNJ UD, TWX: 910-997-0753. MAX is a registered trademark of Altera Corporation.



CYPRESS SEMICONDUCTOR

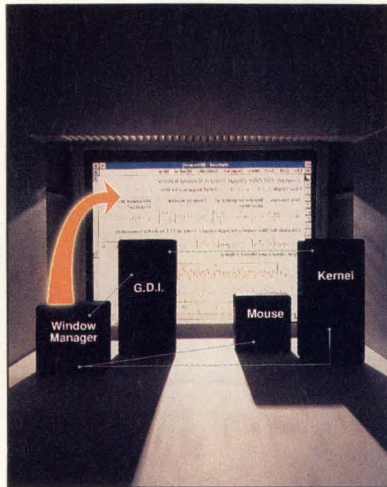

On the cover: When you talk about Windows, what often comes to mind is its user interface. A look at Windows' internal mechanisms, however, reveals an equally important perspective from which to weigh its pros and cons for use with engineering software. (Photo courtesy Mathsoft; design by Liz Schweber; photography by Peter Jones, Advanced Photographics, Custom Laboratory Services) **PAGE 122**

EDN Magazine offers Express Request, a convenient way to retrieve product information by phone. See the Reader Service Card in the front for details on how to use this free service.



EDN's hands-on FPGA project

SPECIAL PROJECT

If you're considering designing with FPGAs, this 2-part hands-on design project will show you exactly what is involved.—*Doug Conner, Technical Editor*

98

Windows and engineering software

SPECIAL REPORT

Fast 386/486 PCs have more than enough horsepower to run formidable engineering programs under a multitasking, virtual-memory operating system. The question is, does Windows 3.X have what it takes? —*Charles H Small, Senior Technical Editor*

122

Improve reliability by rigging pc boards for in-circuit programming

DESIGN FEATURE

By using some practical guidelines, you can rig a pc board's layout to meet commercial in-circuit-programmer specifications.—*Barry M Clark, Stag Microsystems Inc*

135

Design software links active-filter performance with real devices

TECHNOLOGY UPDATES

Analog filter-design software helps to not only perform filter designs' obligatory math quickly, but some programs can also select the right active and passive components to implement the filter.—*Anne Watson Swager, Technical Editor*

45

Continued on page 7

EDN®(ISSN 0012-7515, GST Reg. #123397457) is published 48 times a year (twice monthly with 2 additional issues a month, except for March and October, which have 3 additional issues and July and December which have 1 additional issue) by Cahners Publishing Company, A Division of Reed Publishing USA, 275 Washington Street, Newton, MA 02158-1630. Terrence M McDermott, President/Chief Operating Officer; Frank Sibley, Executive Vice President; Jerry D Neth, Senior Vice President/Publishing Operations; J J Walsh, Senior Vice President/Finance; Thomas J Dellamaria, Senior Vice President/Production and Manufacturing; Ralph Knupp, Vice President/Human Resources. EDN® is a registered trademark of Reed Properties Inc., used under license. Circulation records are maintained at Cahners Publishing Company, 44 Cook Street, Denver, CO 80206-5800. Telephone: (303) 388-4511. Second-class postage paid at Denver, CO 80206-5800 and additional mailing offices. **POSTMASTER: Send address changes to EDN®, PO Box 173377, Denver, CO 80217-3377.** EDN® copyright 1992 by Reed Publishing USA; Robert L Krakoff, President and Chief Executive Officer. Annual subscription rates for nonqualified people: USA, \$119.95/year; Mexico, \$169.95/year; Canada, \$181.85/year; all other nations, \$207.95/year for surface mail and \$329.95/year for air mail. Single copies are available for \$20 USA and \$25 foreign. Please address all subscription mail to Ellen Porter, 44 Cook Street, Denver, CO 80206-5800.

FLUKE®



PHILIPS

High Resolution Digital Meter:
4000 count digital readout; 20,000 count mode (Fluke 87) for 4 1/2 digit resolution

Backlit display: Makes it easy to read the DMM in dark, cramped quarters. Automatically shuts off after 68 seconds to save the battery.

Recorder: records minimums and maximums, plus true arithmetic average; audible Min Max Alert; selectable response times — 1 second and 100 ms (all models) plus 1 ms Peak Min Max (Fluke 87)

Holster with Flex Stand™: Protects meter and provides test lead storage. Flexible leg allows meter to be hung from peg, bent around a pipe, or used almost anywhere.

Analog Meter: High-speed analog display updates 40 times/second—as fast as the eye can follow; X10 Zoom bargraph mode (Fluke 83 and 85) makes high resolution offset measurements a snap.

Frequency counter: Accurate down to 0.5 Hz; also measures duty cycle

Capacitance meter: Autoranging, with manual ranging at the touch of a button



FLUKE 83	FLUKE 85	FLUKE 87
Volts, ohms, amps, diode test, audible continuity, frequency and duty cycle, capacitance, Touch Hold® relative, protective holster with Flex-Stand™	Volts, ohms, amps, diode test, audible continuity, frequency and duty cycle, capacitance, Touch Hold® relative, protective holster with Flex-Stand™	Volts, ohms, amps, diode test, audible continuity, frequency and duty cycle, capacitance, Touch Hold® relative, protective holster with Flex-Stand™
\$215*	\$255*	\$300*
0.3% basic dc accuracy	0.1% basic dc accuracy	0.1% basic dc accuracy
5 kHz acV	20 kHz acV	20 kHz acV
Analog bargraph and zoom	Analog bargraph and zoom	High resolution analog pointer
Three year warranty	Three year warranty	True-rms ac
		1 ms PEAK MIN MAX
		4 1/2 digit mode
		Backlit display
		Three year warranty

*Suggested U.S. list price

Multi-Meter

Meet the meter that brings an entire test bench to your job. The versatile Fluke 80 Series do-just-about-everything "Multi" Meter.

It offers everything you'd expect from an advanced handheld DMM, plus a lot you'd find only in dedicated instruments. Plus Fluke-exclusive features you can't buy anywhere else. All built with the most advanced surface mount design and single-chip ASIC technology for a thinner, tougher, more reliable package.

There's a fully annunciated display for clear operation. Duty cycle function. High-speed analog indicator. A protective holster with innovative Flex-Stand™ for easy, adaptable operation. Audible Input Alert™ to reduce the risk of damage to the meter, the user, and the unit being tested. Plus the strongest warranty in the business.

All good reasons to move up to the truly-multi Fluke 80 Series today. You'll find 80 Series DMMs at your Fluke distributor. For immediate, off-the-shelf delivery. Call

1-800-44-FLUKE, ext. 33 for the name of your nearest distributor.

John Fluke Mfg. Co., Inc. P.O. Box 9090 M/S 250C, Everett, WA 98206 U.S.; (206) 347-5400 CANADA: 416-890-7600 OTHER COUNTRIES: (206) 356-5500

© Copyright 1989, 1990 John Fluke Mfg. Co., Inc. All rights reserved. Prices and specifications subject to change without notice. Ad no. 00010

FROM THE WORLD LEADER IN DIGITAL MULTIMETERS.

FLUKE®

Home Office

275 Washington St, Newton, MA 02158
 EDN Bulletin Board: (617) 558-4241
 MCI: EDNBOS
 (617) 558-extension

VP/Publishing Director

Peter D Coley -4673

VP/Publisher

Roy Forsberg -4367

VP/Editor/Editorial Director

Jonathan Titus -4573

Executive Editor

Steven H Leibson -4214

Managing Editor

Joan Morrow Lynch -4215

Assistant Managing Editor

Christine McElvenny -4741

Gary Legg, *Senior Technical Editor* -4404
 Tom Ormond, *Senior Technical Editor* -4414
 Charles Small, *Senior Technical Editor* -4556
 John A Gallant, *Technical Editor* -4666
 John C Napier, *Technical Editor* -4690
 Dave Pryce, *Technical Editor* -4326
 Dan Strassberg, *Technical Editor* -4205
 Jay Fraser, *Associate Editor* -4561
 Carl Quesnel, *Associate Editor* -4484
 Susan Rose, *Associate Editor* -4738
 Julie Anne Schofield, *Associate Editor* -4619
 Helen McElwee, *Senior Copy Editor* -4311
 James P Leonard, *Copy Editor* -4324
 Gillian A Caulfield, *Production Editor* -4263
 Brian J Tobey, *Production Editor* -4309

Editorial Field Offices

Doug Conner, *Technical Editor*
 Atascadero, CA: (805) 461-9669
 MCI: EDNDCONNER

J D Mosley, *Technical Editor*
 Arlington, TX: (817) 465-4961
 MCI: EDNMOSLEY

Richard A Quinnell, *Technical Editor*
 Aptos, CA: (408) 685-8028
 MCI: EDNQINNELL

Anne Watson Swager, *Technical Editor*
 Wynnewood, PA: (215) 645-0544
 MCI: EDNSWAGER

Ray Weiss, *Technical Editor*
 Woodland Hills, CA: (818) 704-9454
 MCI: EDNWEISS

Maury Wright, *Technical Editor*
 San Diego, CA: (619) 748-6785
 MCI: EDNWRIGHT

Brian Kerridge, *Technical Editor*
 22 Mill Rd, Loddon
 Norwich, NR14 6DR, UK
 (508) 28435
 MCI: EDNKERRIDGE

Contributing Editors

Robert Pease, Don Powers,
 David Shear, Bill Travis

Editorial Coordinator

Kathy Leonard -4405

Editorial Services

Helen Benedict -4681

Art Staff

Ken Racicot, *Senior Art Director* -4708
 Chinsoo Chung, *Associate Art Director* -4446
 Cathy Madigan, *Associate Art Director* -4599

Marketing & Business Director

Deborah Virtue -4779

Marketing Communications

Kathy Calderini, *Manager* -4526
 Pam Winch, *Promotion Specialist* -4660

TECHNOLOGY UPDATES

**Content-addressable memories:
 FDDI routers and bridges create niche**

61

Content-addressable memories (CAMs) quickly compare input data to stored data. FDDI's 100-Mbps speed has created a commercial demand for these memories.

—John Gallant, *Technical Editor*

PRODUCT UPDATES

High-density PLD	73
Cache tag RAMs	74
Electrostatic plotter for E-size drawings	76
Modem ICs for fax and data duties	80

PROCESSOR UPDATES

68000 gate-array family	83
4-bit microcontroller	83
Low-cost 32-bit DSP processor	88
Single microcontroller chip for embedded designs	88

NEW PRODUCTS

Integrated Circuits	155
Computers & Peripherals	169
Components & Power Supplies	173
Test & Measurement Instruments	183
CAE & Software Development Tools	185

DEPARTMENTS

Inside EDN	9
News Breaks	17
Signals & Noise	23
Ask EDN	30
Editorial	39
Design Ideas	145
Career Opportunities	192
EDN's International Advertisers Index	196
EDN's Acronyms & Abbreviations	197

Cahners Publishing Company, A Division of Reed Publishing USA Specialized Business Magazines for Building & Construction Research Technology Electronics Computing Printing Publishing Health Care Foodservice Packaging Environmental Engineering Manufacturing Entertainment Media Home Furnishings Interior Design and Lodging. Specialized Consumer Magazines for Child Care Boating and Wedding Planning.

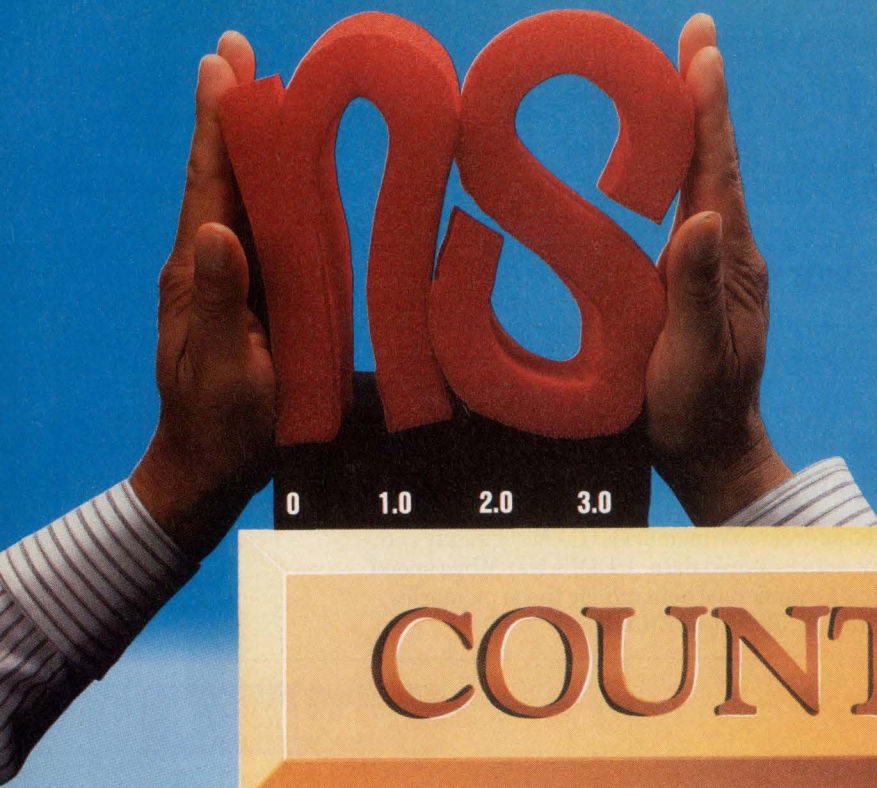

When Every Nanosecond Counts

Squeeze critical nanoseconds from your high-speed logic interface with the fastest FCT logic available. IDT's FCT-CT family offers speeds that are 50% faster than standard FCT or FAST logic families — as fast as 3.4ns (typical)!

The Perfect System Solution

As a system designer, you need the perfect combination of:

1. **Fastest speed**
2. **Low ground bounce**
3. **Low power consumption**

FCT-CT logic has true TTL compatibility for ease of design. The reduced output swings and controlled output edge rate circuitry ensure low system noise generation. No other technology offers higher speeds or lower power consumption.

The FCT-CT family is completely pin- and function-compatible with FCT logic, and is available today in all standard packaging.

FUNCTION	PROPAGATION DELAY (Max)	OUTPUT ENABLE (Max)	OUTPUT DISABLE (Max)
Buffers	4.1ns	5.8ns	5.2ns
Transceivers	4.1ns	5.8ns	4.8ns
Registers	5.2ns	5.5ns	5.0ns
Latches	4.2ns	5.5ns	5.0ns

Free Logic Design Kit

Call our toll-free hotline today and ask for **Kit Code 3061** to get a **1991 High-Speed CMOS Logic Design Guide** and **free FCT-CT logic samples**.

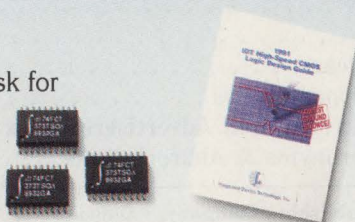

(800) 345-7015 • FAX: 408-492-8454

The IDT logo, CEMOS, BiCEMOS, and R3051 are trademarks of Integrated Device Technology, Inc.

CIRCLE NO. 5

12ns 256K SRAMS

Fastest cache solutions for RISC and CISC CPUs. 36+ ultra-high-speed sub-micron SRAMs for 33MHz processing & beyond are in the **SRAM Data Book**.



35mips RISC CHIPS AND MODULES

R3000A for the most mips at any MHz; R3051 for CPU, cache, & buffers on one chip. Modules, eval. boards & software complete the family. See them in the **RISC Data Book**.

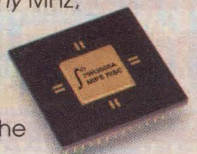

HIGHEST-PERFORMANCE MEMORIES

Fast FIFOs, dense dual-ports, BiCEMOS ECL, & memory modules. 120+ FIFOs & multi-port memories, 5ns ECL, & multi-chip modules are in the



Specialized Memories Data Book.



Call today for your new IDT data books with complete technical specifications and application information.



Integrated Device Technology, Inc.

The editors of EDN Magazine edition did a lot of poking, prodding, and tire kicking to bring you the stories in this issue. For starters, you'll find the first installment of Technical Editor Doug Conner's 2-part, hands-on FPGA series. As with most of EDN's hands-on series, this article blossomed from Conner's curiosity about some aspect of design; in this case, FPGA design. Rather than just telling you

Senior Technical Editor Charles Small looks under the hood of Microsoft Windows to gauge its suitability for engineering applications. Small also interviewed several software vendors and found them divided on their intentions regarding Windows. Some are converting their applications programs, others aren't. As part of his investigation, Small became one of the 12,000 beta sites for Windows version 3.1.

Technical Editor Anne Watson Swager also tried out some software for her Technical Update on filter-design packages. She discovered that most of these packages create designs for either switched-capacitor or continuous-time filters but not both types. Consequently, these software products are most helpful when you already know the type of filter you want to use. They'll save you time by automating the filter equations so you can leave the filter textbooks on your bookshelf. However, if you need help in deciding between filter types, or if you're trying to create an unusual filter, you might not be satisfied with most filter-design packages.

Finally, Technical Editor John A Gallant discovered a recent innovation while researching his Technical Update on content-addressable memories (CAMs). A lone inventor in Boulder, CO, has developed a method that makes CAMs out of conventional RAMs through a decidedly unconventional architecture. See the sidebar in Gallant's Technical Update for more details.

Steven H Leibson
Executive Editor

about the available design tools or interviewing some existing users, Conner wanted to let you know—first hand—just how easy or difficult it is for an experienced design engineer to learn how to use FPGA development tools.

He started just where you would, by defining a product that he wanted to design. Then he designed and built it using an FPGA as a key component. Along the way he took a class that taught him how to design with FPGAs, he learned how a simulator can prevent you from venturing down blind alleys, and he faced that moment of truth when the power is first turned on. All told, he had a lot of fun.

In this issue's Special Report,



Technical calculations made easy!

ALL NEW VERSION 3.0!



Mathcad - [mathcad.mcd] Help

File Text Math Graphics Symbolic Window Help

Dimensions of the aluminum block will be 3.5 feet by 4.5 feet by 1.4 inches.

$$V = 4.5 \text{ ft} \times 1.4 \text{ in} \times 165.286 \frac{\text{lb}}{\text{ft}^3} = 1.077 \times 10^3 \text{ lb}$$

(density of Al from the Mechanical Engineers' Handbook)

It supports (circular section, radius 2 inches) that works out to:

$$\left(\frac{1}{2} \pi r^2 \right) = 6.283 \frac{\text{in}^2}{\text{ft}} \text{ is also used going to be } 10^3$$

How about the coating - the sketch at the right shows the level of profile we want at the edges. The rate of loss depends on temperature, roughly like this:

The worst case is around 140 degrees so for a 6 month lifetime we need 6 months $(140) = 0.342 \text{ in}$. This will add quite a lot to the cost (this suit is expensive!) At \$165 per gallon, $165 \times 7.33 = 1209.45 \text{ dollars}$.

Now it's easier than ever to perform faster, more reliable engineering and scientific calculations.

- **Windows graphics features make Mathcad 3.0 the simple solution to complex analytic needs.** Dialogs, pull-down menus, and mouse point-and-click capabilities make it easy to combine equations, text, and graphics right on your screen and print it all in a presentation-quality document.
- **New Electronic Handbook Help facility serves as an on-line reference library.** Paste standard formulas, constants, and diagrams from searchable, hypertext Electronic Handbooks for instant use in your Mathcad worksheet.
- **Symbolic calculations with a simple menu pick.** Use expressions resulting from symbolic derivations in your numeric calculations or for further symbolic manipulation.
- **Mathcad works on PC DOS, PC Windows, Macintosh, or UNIX.** More than 120,000 engineers, scientists, and educators already use Mathcad for a variety of technical applications. Applications packs are also available to customize Mathcad for particular disciplines, including electrical, mechanical, and civil engineering and advanced math.

Call 800-MATHCAD or use this coupon to request a free 3.0 demo disk!

In Massachusetts, call 617-577-1017. Please specify diskette size:

3 1/2" 5 1/4"

For a free Mathcad 3.0 Introductory kit, clip this coupon and mail it back to us, or fax it to 617-577-8829. Or circle your reader service card.

Yes! Tell me more about Mathcad 3.0!

Name _____
 Title _____
 Company or Institution _____
 Address _____
 City _____ State _____ Zip _____
 Phone(_____) _____

MathSoft Mail this coupon to:
MathSoft, Inc.
 201 Broadway
 Cambridge, MA 02139
 USA
 EDN 13 TECH 3.0

CIRCLE NO. 6

EDN April 9, 1992 • 9

Soon, Eight Ho Computing Will



(actual size)

AMD Introduces The World's First 386 Microprocessor With 3-Volt Technology.

Two standard dry-cell batteries. There's really nothing special about them. Aside from the fact that they can run a powerful, portable 386 computer for a full eight hours. Provided, of course, that portable is built around a low-voltage Am386™ microprocessor.



The 25MHz DXLV and the 25MHz SXLV are available in POFP packaging.

Thanks to the low-voltage Am386 microprocessors, laptop, palmtop and notebook computer designs will become smaller, lighter, and more powerful than ever before.

With battery life of up to eight hours or more. That's a full day's worth of 386 performance—the per-

urs Of Portable Look Like This.

formance you need to run sophisticated applications like Windows™ 3.0.

And rest assured, the low-voltage Am386 microprocessors are proven compatible and comply fully with JEDEC standards for low-power, 3-volt computing. We can even supply you with the 3-volt EPROMs your systems will need. Other 3-volt system logic is also readily available.

For more information on the low-voltage

Am386 microprocessors call AMD today at **1-800-222-9323**. You'll never look at dry-cell batteries the same way again.



Advanced Micro Devices

*"We're Not Your Competition."*SM

LITTLE FOOT.



"SIZE IS POWER" DEBUNKING THE MYTH

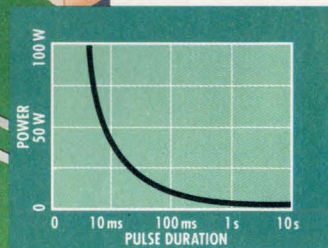
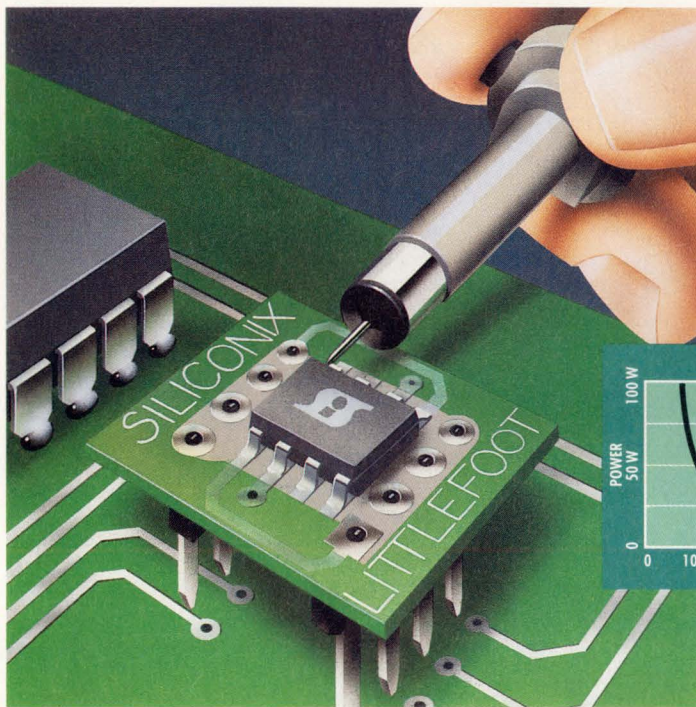

The myth of mass.

Many say, "Size is power." We say different, but understand a few of you

may have doubts. Sometimes it's just hard to believe a device so small can dissipate so much power. A full 2 watts.

But LITTLE FOOT™ does.

It also delivers the highest current rating available, up to 3.5 amps, in a tiny SOIC-8 package. This results from a combination of our unique copper lead-frame design that conducts heat directly from the backside of the die to optimize thermal performance, and our SiMOS 2.5 (2.5 million cells/sq.in.) technology that creates the industry's highest power density and lowest on-resistance. Just what you need for motor control, load switching, and DC/DC conversion in applications where space and heat are critical constraints.

How else can you design one or two powerful MOSFETs into your system in less than five one hundredths (0.05) of a single square inch?

Use the world's smallest evaluation board... and see for yourself.

Siliconix simplifies circuit testing by providing you with a mini-evaluation board. It's only 1/2" x 1/2". Just solder LITTLE FOOT to the mini-board and drop it into your socket. It takes only a few minutes to prove to yourself that 2 watts can be dissipated easily by this remarkable SOIC-8 packaging technology.

LITTLE FOOT is designed for manufacturability.

LITTLE FOOT simplifies your assembly process because Siliconix's SOIC packaging is compatible with the digital devices on your board. And its two-MOSFET capability means you use fewer components and get higher system reliability.

LITTLE FOOT cuts your costs and reduces set-up time. And there are no solder voids, no lead trimming, and no tube jamming. It can also eliminate steps in your production cycle to get your product to market faster.

Get the LITTLE FOOT big advantage.

It runs cooler, saves space, improves reliability, increases

efficiency, simplifies design, extends battery life, reduces costs, and cuts time to market. With this kind of designed-in performance it's not surprising that LITTLE FOOT sales have surpassed 20 million devices.

And that's fact — not myth.

LITTLE FOOT comes in different versions that are ideal for motor control, load switching, and DC/DC conversion.

- N-ch MOSFETs (duals & singles)
- P-ch MOSFETs (duals & singles)
- N- & P-ch MOSFETs

Voltage: 20-50V (200V coming)
On-resistance: 50-300 mΩ
Current Rating: 4.5A
Power Dissipation: 2W

Call our toll-free hot line now!
1-800-554-5565, ext 964. Ask for your LITTLE FOOT design kit and evaluation board. And remember at Siliconix we're bringing a seamless power interface to the digital world.

Siliconix

2201 Laurelwood Rd, Santa Clara CA 95056

We provide more
to a place few co

©1992 FORCE Computers, Inc.

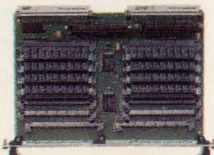
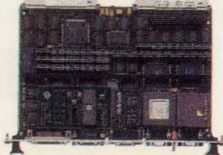
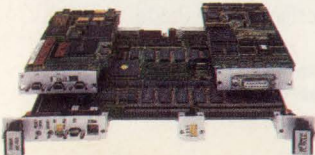

**e solutions because we've been
mpanies have dared to venture.**

When it comes to embedded systems design, nobody offers better solutions than FORCE.

But, we have to admit, we had a little help. From you.

At FORCE, we get inside the heads of our customers to learn about their requirements.

The result is the world's most advanced CISC and SPARC™ based VME single board computers, including the latest SPARC CPU-2E boards.

What else did you have in mind? How about bus extensions – like SBus and our own FLXibus™ Plus SunOS™ and the widest variety of real-time operating systems and kernels.

And when your designs need to evolve to the next generation, count on FORCE for the best in VME64/Plus™ or Futurebus/Plus™. Because better products come from better knowledge.

For a partner that can get your application up and running fast, call 800-237-8863, ext. 10. In Europe, call 49.89.608-14-0.

And thanks for keeping an open mind.

FLXibus, VME64/Plus and Futurebus/Plus are trademarks of FORCE Computers, Inc. All other brands or products are trademarks of their respective holders.

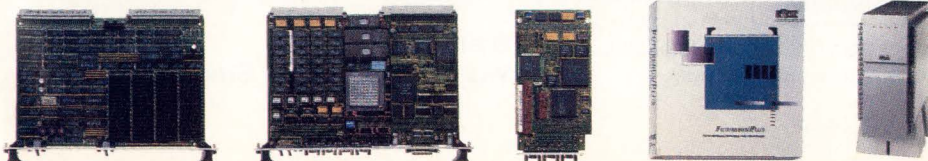

CIRCLE NO. 8



3165 Winchester Blvd., Campbell, CA 95008-6557
Prof.-Messerschmitt-Str. 1 W-8014 Neubiberg/München

SIEMENS

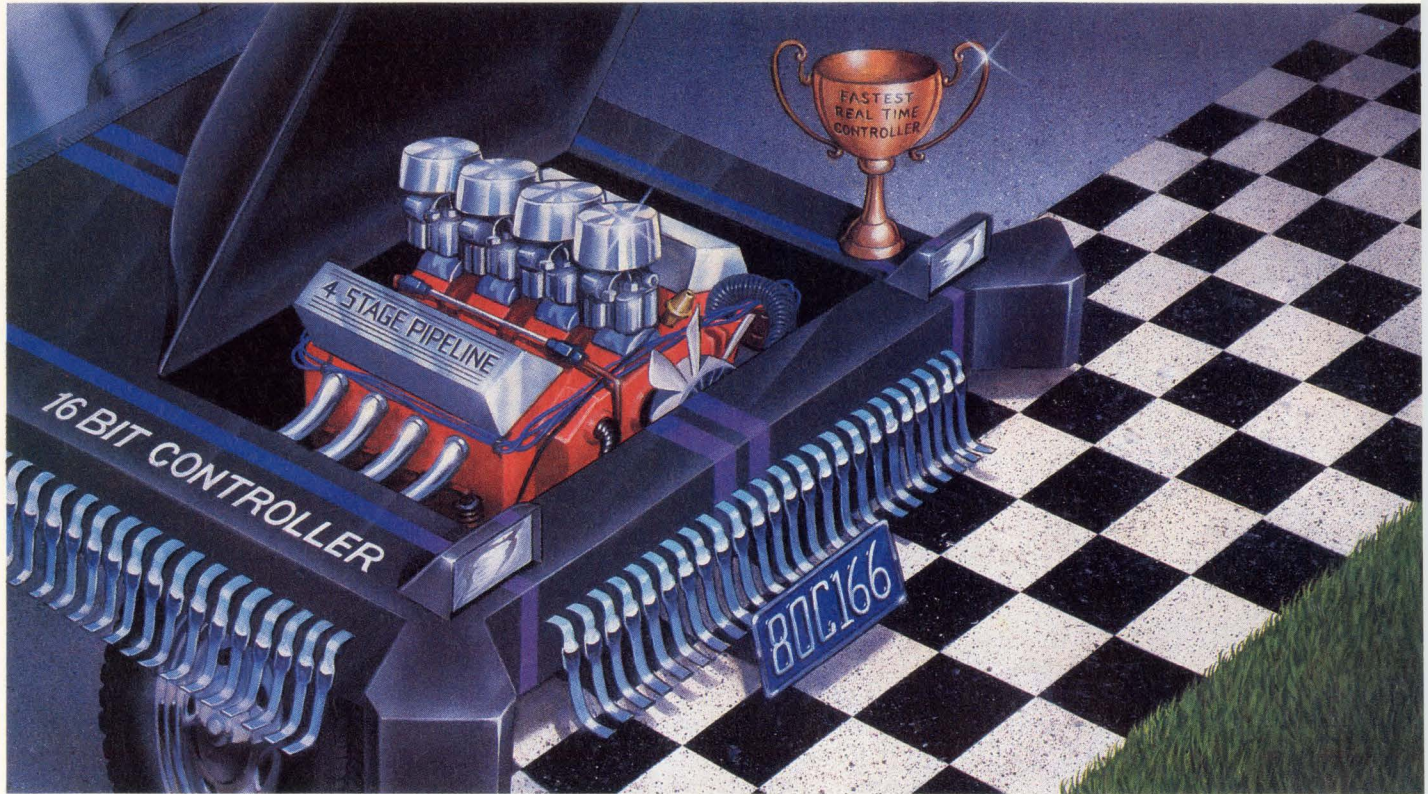

Introducing A New Level Of Performance, And The World Speed Records To Back It Up.

With the world's only 16-bit microcontroller 4-stage pipeline, the 80C166 gives you winning performance, from start to finish.

With its innovative combination of blazing CPU performance and peripheral functionality, the SAB80C166 has blown past the competition in embedded control speed and performance.

The Fastest Real-Time Controller In The World.

One reason for its amazing speed, up to 10 native MIPS, is a 4-stage CPU pipeline which can process four instructions simultaneously. This allows 90% of instructions to execute in 100 ns, letting you complete tasks in record time.

The 80C166 also gives you the most effective interrupt performance anywhere, with speeds as fast as 250 ns because the 64 levels of priority are arbitrated each machine cycle.



16- and 8-bit Microcontrollers

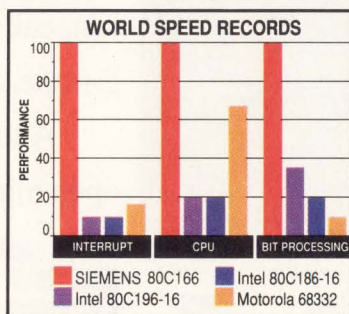

The fully vectored interrupt system allows the fastest identification of interrupt sources. Plus, through the use of a Peripheral Event Controller, which 'steals' just one machine cycle from the CPU, it lets you service peripherals without going through a standard interrupt procedure.

And with a full suite of development tools from world-class vendors, it's no wonder the competition can't keep up.

The Highly-Integrated 80C517A.

With the Siemens SAB80C517A, we've also brought this high-performance to the 8-bit microcontroller. It offers 10-bit A/D conversion, 32K ROM, 2.2K onboard RAM, and 32- and 16-bit arithmetic functions, while still retaining 8051 software compatibility. And it has 8 data pointers and 68 ports—more than any competitor.

To find out how Siemens can help you set some speed records of your own, call us at **800-456-9229**, and ask for literature package M14A016.

**Siemens
World Wide, Market Smart.**

Multiple sources for ISA bus—in two senses

Programmable dc sources are common building blocks in automatic test equipment (ATE). They differ from D/A converters by providing higher output currents (and sometimes, higher output voltages) and by offering outputs isolated from the system chassis. Some also operate in four quadrants; they source or sink positive or negative voltage or current, and they can absorb current from a positive-voltage load, and they can supply current to a negative-voltage load. Until about a year ago, when the first ISA bus plug-in programmable dc source appeared, if you were building PC-based ATE, your dc sources had to be external units, controlled via IEEE-488 or RS-232C.

Now Datel is offering a programmable dc source, the PC 462. It has four outputs totaling 22W, offers 200- μ sec transient response, and is unconditionally stable under all load conditions. Although lacking 4-quadrant capability, the \$1195 unit, which plugs into the 16-bit, PC/AT version of the ISA bus, provides dedicated positive and negative outputs; one pair is rated at $\pm 20.475V$ at 250 mA each, the other at $\pm 6.1425V$ at 1A each.

The board also includes an isolated 16-channel ADC that you can use to monitor the output voltages and load currents, two digital inputs, and two high-power digital outputs rated at 300V and 100 mA. The board's analog inputs and outputs have 12-bit resolution. A \$95 program provides a virtual-instrument interface under MS Windows V3.0. Datel Inc, Mansfield, MA, (508) 339-3000, FAX (508) 339-6356.—Dan Strassberg

DIP-size devices take the pain out of antialiasing

Until now, if you wanted a filter you could just drop onto a pc board and pretty much forget, you had to choose between very expensive programmable hybrid circuits or rather large modules built from discrete devices. Now, a family of small, moderately priced lowpass filters requires no external components, exhibits low noise, and requires little specialized knowledge to apply. The D70 series includes 4-, 6-,

and 8-pole models with Butterworth and Bessel characteristics and fixed user-specified, cut-off frequencies from 500 Hz to 50 kHz (2% tolerance). The filters are housed in 0.625 \times 0.3-in. dual-inline packages that measure 0.5-in. long in the 4-pole version (0.825-in. long in the 6- and 8-pole versions). The 8-pole devices are priced at \$49 (1). A 4-pole device costs \$19 (10,000). Even though the filters are made to order, delivery is four to six weeks ARO. Frequency Devices Inc, Haverhill, MA, (508) 374-0761.—Dan Strassberg

Intel gives away PLD/EPLD software

Intel is offering free copies of its PLDshell Plus software. The software includes a device compiler, a logic minimizer, a simulator, and a decompiler. The decompiler accepts JEDEC fuse maps. The compiler targets the company's 20- and 24-pin PLDs and EPLDs that are second-sourced from Altera. The compiler also swallows PALASM files. To receive the free software, call the Intel Literature Center at (800) 548-4725, or call your local Intel office and ask for Intel Packet #IB75.

—Charles H Small

FPGA combines 100-MHz clock rate with 2000-gate density

Quicklogic's QLI2x16 FPGA (field programmable gate array) is designed for high-speed counter operation: The logic supports 100-MHz (min) clock rates for 16-bit binary counters and as much as 150 MHz for Johnson counters with simple front-end control logic (the raw toggle rate is 180 MHz). The chip is the second in the pASIC FPGA family. Refinement of the basic circuit design and the addition of dedicated clock inputs and drivers with through-chip skip held to 1 nsec has improved performance by 15%.

The chip is built around a 10 \times 12 matrix of inter-

connected logic cells. Each cell consists of six AND functions, three multiplexers, and a D flip-flop, all of which are the equivalent of 20 or more virtual gates. This organization gives the FPGA an equivalent gate count of 2000 (min) logic gates. Unlike other FPGAs, this logic core is designed for logic control functions. It has 14 inputs folding into six ANDs with multiplex control and a dedicated D flip-flop. In addition, two gate outputs and two multiplex outputs directly exit the cell, supplementing the flip-flop output.

The chip comes in an 84-pin plastic leaded chip carrier with 68 bidirectional inputs and eight dedicated inputs. \$98 (100). Quicklogic Corp, Santa Clara, CA, (408) 987-2000.

—Ray Weiss

Ethernet connects data-acquisition system to Sun workstations

When you connect an externally mounted data-acquisition subsystem to a workstation, the two most common interfaces are IEEE-488 and RS-232C. However, workstations have Ethernet interfaces; using one of the other types of interfaces usually requires adding hardware. Moreover, Ethernet has the potential of 10-Mbps transmission (albeit with non-deterministic response). RS-232C is orders of magnitude slower; IEEE-488, which has comparable speed, has cable-length limitations that are restrictive in many data-acquisition applications—

Logic families operate fast on low-voltage supplies

Two logic CMOS IC families from Philips Semiconductor operate with V_{CC} in the 1.2 to 3.6V range. The first family, known as HLL (High-speed, Low-power, Low-voltage), exhibits a typical propagation gate delay of 2.5 nsec on a 3.3V supply. It uses 0.25 mW in an idle condition and 0.9 mW when switching at 1 MHz. The HLL family withstands 5.5V inputs, and you can interface inputs and outputs directly to TTL logic levels in mixed 3 and 5V logic systems. The second family, LV-HCMOS, features similar speed performance to Philips' established 5V HCMOS range of logic products. The new family is also pin- and function-compatible with HCMOS products, letting you replicate 5V logic designs on 3.3V supplies, resulting in approximately a 70% power savings.

The first products to appear in each range are 3-state octal inverting line drivers. At 25°C and with 3 V_{CC} , the 74HL33240 exhibits a maximum propagation delay of 3 nsec and a 3-state enable time of 3.6 nsec. Equivalent figures for the 74LV244 under the same conditions are 17 and 20 nsec, respectively. The 74HL33240, in a 24-pin plastic small-outline package, costs \$1.50 (100); the 74LV244, in a 20-pin plastic small-outline package, costs \$0.42 (100). The company forecasts 20 parts and shrink small-outline packages for each family by the fourth quarter of 1992. Philips Semiconductor, Eindhoven, The Netherlands, 40-722091, FAX 40-724825. In the US, Signetics Corp, Sunnyvale, CA, (800) 227-1817, FAX (408) 991-3581.—Brian Kerridge

particularly those in factories.

Strawberry Tree's I/O Station 464 is a data-acquisition unit housed in a 4.25 x 17 x 16.88-in. enclosure. You can mount the enclosure under a Sun workstation's monitor or at a distance from the workstation. In either case, you connect the unit to the workstation via 10Base-2, 10Base-5, or 10Base-T Ethernet. The unit holds four of the vendor's data-acquisition boards; eight types are available. The initial offering is intended for relatively low-speed applications (0.5 to 2 msec/point). A CPU in the enclosure linearizes the data and scales it in engineering units before placing it on the

network. The unit's pricing begins at \$3995. Strawberry Tree Inc, Sunnyvale, CA, (408) 736-8800, FAX (408) 736-1041.

—Dan Strassberg

Logic emulator runs at 8 MHz without tweaks

Pie Design Systems' Mars II series modular logic emulators let you emulate a large PLD, FPGA (field programmable gate array), or ASIC without programming a part or incurring a mask charge. Mars stands for modular, automatic, retargetable, and scalable. The modu-

larity arises from the division between the debugging circuitry and the emulation circuitry. Automatic refers to the emulator's ability to partition a logic design automatically and map it onto the emulation hardware. The company claims that its automatic partitioning software can produce emulations that operate at clock speeds to 8 MHz by identifying critical timing paths and treating these paths accordingly. Retargetable and scalable refer to the company's belief that the emulation architecture can immediately benefit from speed and density improvements made to the underlying FPGA technology used for the emulation circuitry.

The system's debugging module includes a 576-channel logic analyzer, a functional tester, and an emulation server that links the emulation modules to a host computer. The emulation module, called a logic-block module, contains the dynamically configured FPGAs that actually perform the logic emulation. Any number of emulation modules can share one debugging module.

Software for the system includes an object-oriented database manager that controls all of the emulation system's data files, a compiler that transforms EDIF-logic netlists into emulation files, functional test software that ensures that the emulation configuration matches the original logic design, and the logic-

analyzer control software. A system that can emulate 50,000-gate designs costs from \$208,000 to \$227,000. Additional emulation modules cost \$54,000 and provide 25,000-gate emulation per module. Pie Design Systems Inc, Sunnyvale, CA, (408) 738-8899, FAX (408) 738-8853.

—Steven H Leibson

Choose interface and form factor for your drives

You can choose an IDE (Integrated Drive Electronics) or a PCMCIA (Personal Computer Memory Card Industry Association) interface with disk drives from Ministor's 1.8-in. Miniport family. Most small disk drives include an IDE interface, but the Miniport models are among the first to also include compatibility with the PCMCIA standard, originally developed as a memory expansion bus for notebook computers. The series includes drives with 32- and 64-Mbyte capacities priced at \$280 and \$380, respectively (OEM qty). The drives feature 18-msec average seek times, an average latency of 6.67 msec, and a 256-kbyte buffer. A 5V supply powers the drives that consume 2.5W of power during read/write operations. The units feature a 2-level sleep mode that lowers power consumption to 0.1 or 0.005W. The drives can operate through a 20g shock and can withstand 200g of shock when not operating. Ministor Peripherals Corp, San Jose, CA, (408) 937-0165.—Maury Wright

Explore the Intricacies of Your PSpice Circuit Simulation . . .

Using the Design Center's Performance Analysis Feature

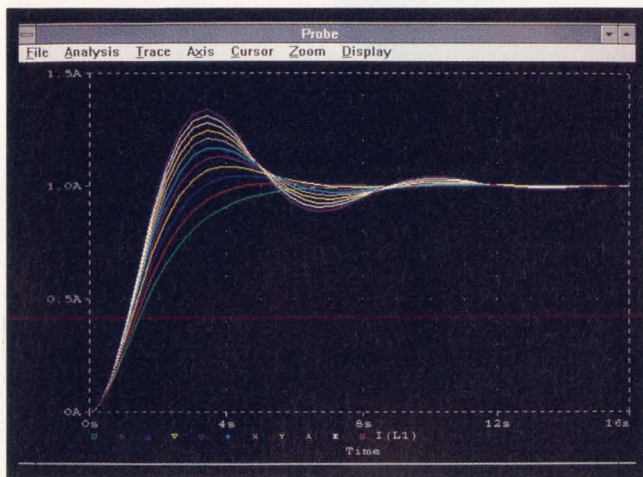

Current through an inductor with stepped resistance

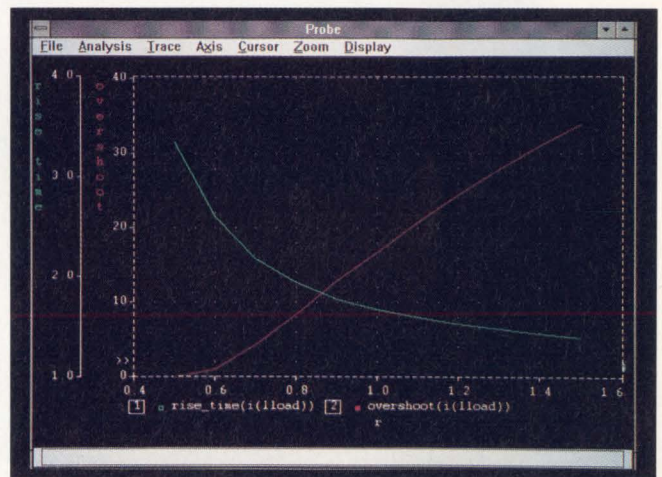

Rise time and overshoot as a function of resistance

In-depth examination and processing of PSpice simulation results is at your fingertips using the **Design Center's** graphical waveform analyzer with Performance Analysis. By applying any number of user-defined goal functions (such as pulse-width or overshoot) to multiple PSpice waveforms, your circuit's behavior can be tracked as a function of changing conditions (such as temperature, source voltage, or model parameter values). It's easy to plot quantities like propagation delay versus temperature, bandwidth versus Q, or pulse-width versus component value. Performance Analysis, along with the waveform analyzer's well-known high-resolution graphical display of simulation and post-processed results, makes it easier than ever to visualize trends in your circuit's behavior.

The **Design Center's** graphical waveform analyzer also supports multiple Y axes on a single plot, and simultaneous display of analog and digital waveforms. Interactive plotting capabilities provide you with complete control; axes can be freely defined, and traces can be added to the display in a variety of ways including fast Fourier transforms, derivatives, integrals, user-defined functions, and buses, as well as analog and digital waveform expressions.

PSpice and the graphical waveform analyzer with Performance Analysis are now an integrated part of our **Design Center** analog and digital circuit design environment. For further information on the **Design Center**, call us toll free at (800) 245-3022, or FAX at (714) 455-0554.



MicroSim Corporation

20 Fairbanks • Irvine, CA 92718

THE MAKERS OF PSpICE

PSpice is a registered trademark of MicroSim Corporation

RF TRANS

Over 50 off-the-shelf models...

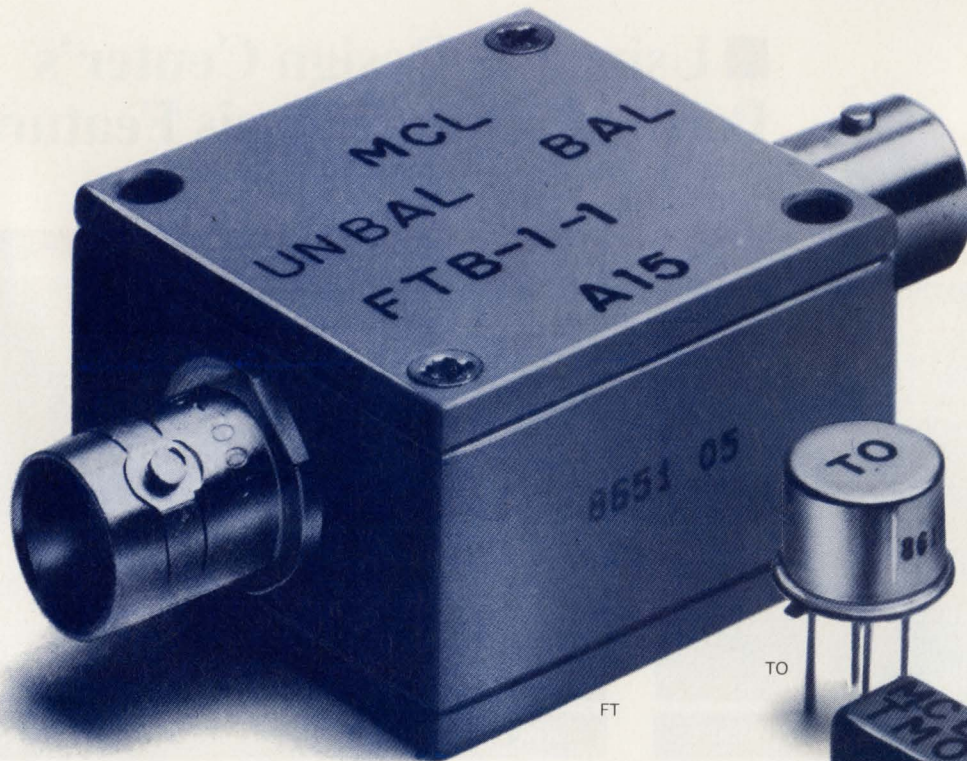

Having difficulty locating RF or pulse transformers with low droop, fast risetime or a particular impedance ratio over a specific frequency range?... Mini-Circuits offers a solution.

Choose impedance ratios from 1:1 to 36:1, connector or pin versions (plastic or metal case built to meet MIL-T-21038 and MIL-T-55831 requirements*). Ultra-wideband response achieves low droop and fast risetime for pulse applications. Ratings up to 1000M ohms insulation resistance and up to 1000V dielectric voltage. For wide dynamic range applications involving up to 100 mA DC primary current, use the T-H series. Coaxial connector models are offered with 50 and 75 ohm impedance; BNC standard; request other types. Available for immediate delivery with one-year guarantee.

Call or write for 68-page catalog or see our catalog in EEM, or Microwaves Product Data Directory.

*units are not QPL listed

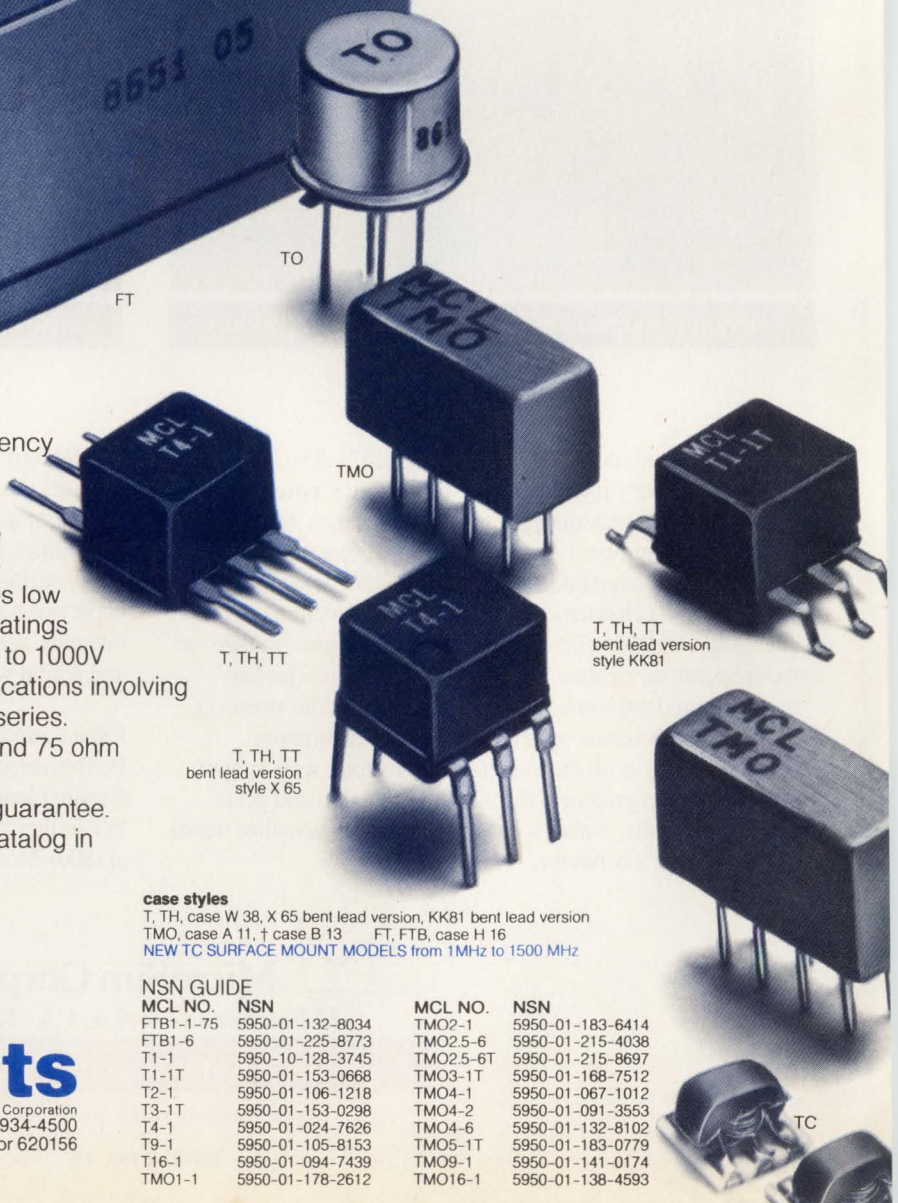

case styles

T, TH, case W 38, X 65 bent lead version, KK81 bent lead version
TMO, case A 11, † case B 13 FT, FTB, case H 16
NEW TC SURFACE MOUNT MODELS from 1MHz to 1500 MHz

NSN GUIDE

MCL NO.	NSN	MCL NO.	NSN
FTB1-1-75	5950-01-132-8034	TMO2-1	5950-01-183-6414
FTB1-6	5950-01-225-8773	TMO2.5-6	5950-01-215-4038
T1-1	5950-10-128-3745	TMO2.5-6T	5950-01-215-8697
T1-1T	5950-01-153-0668	TMO3-1T	5950-01-168-7512
T2-1	5950-01-106-1218	TMO4-1	5950-01-067-1012
T3-1T	5950-01-153-0298	TMO4-2	5950-01-091-3553
T4-1	5950-01-024-7626	TMO4-6	5950-01-132-8102
T9-1	5950-01-105-8153	TMO5-1T	5950-01-183-0779
T16-1	5950-01-094-7439	TMO9-1	5950-01-141-0174
TMO1-1	5950-01-178-2612	TMO16-1	5950-01-138-4593



finding new ways ...
setting higher standards

Mini-Circuits

A Division of Scientific Components Corporation
P.O. Box 350166, Brooklyn, New York 11235-0003 (718) 934-4500
Fax (718) 332-4661 Domestic and International Telexes: 6852844 or 620156

FORMERS

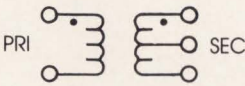
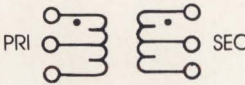
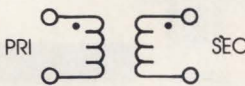
3KHz-800MHz from \$3²⁵

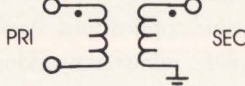
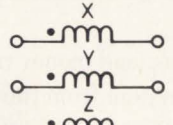
case style number see opposite page	MODEL NO.	Ω RATIO	FREQUENCY MHz	INSERTION LOSS			PRICE \$ Qty. (1-9)			
				3dB MHz	2dB MHz	1dB MHz				
A* 	T	T1-1T	1	.05-200	.05-200	.08-150	2-80	4.45		
		T1-6T	1	.003-300	.003-300	.01-150	02-50	6.95		
		T2-1T	2	.07-200	.07-200	.1-100	5-50	4.95		
		T2.5-6T	2.5	.01-100	.01-100	.02-50	50-20	4.95		
		T3-1T	3	.05-250	.05-200	.1-200	5-70	4.95		
		T4-1	4	2-350	2-350	.35-300	2-100	3.25		
		T4-6T	4	.02-250	.02-250	.05-150	0.1-100	4.45		
		T5-1T	5	3-300	3-300	.6-200	5-100	4.95		
		T8-1T	8	.03-140	.03-140	1-90	1-60	7.95		
		T13-1T	13	3-120	3-120	.7-80	5-20	4.95		
		T16-6T	16	.03-75	.03-75	.06-30	1-20	5.65		
		TH	T4-1H	4	10-350	10-350	15-300	25-200	5.95	
			TMO	TMO1-1T	1	.05-200	.05-200	.08-150	2-80	7.95
				TMO2-1T	2	.07-200	.07-200	.1-100	5-50	8.45
				†TMO2.5-6T	2.5	.01-100	.01-100	.02-50	05-20	8.45
		†TMO3-1T		3	.05-250	.05-250	.1-200	5-70	7.95	
	TMO4-1	4	2-350	2-350	.35-300	2-100	6.25			
	TMO5-1T	5	3-300	3-300	.6-200	5-100	8.45			
	TMO13-1T	13	3-120	3-120	.7-80	5-20	8.45			
B* 	TT	TT1-6	1	.004-500	.004-500	.02-200	1-50	6.95		
		TT1.5-1	1.5	.075-500	.075-500	2-100	1-50	5.95		
		TT2.5-6	2.5	.01-50	.01-50	.025-25	05-10	6.45		
		TT4-1	3	.05-200	2-50	2-50	1-30	6.95		
		TT4-1A	4	0.1-300	0.1-300	0.2-250	0.3-180	5.95		
		TT25-1	25	.02-30	.02-30	.05-20	1-10	9.95		
		TTMO	TTMO25-1	25	.02-30	.02-30	.05-20	1-10	11.95	
			TTMO1-1	1	.005-100	.005-100	.01-75	05-40	11.45	
			TTMO4-1A	4	0.1-300	0.1-300	0.2-250	0.3-180	13.95	
C 	T	T1-1	1	.15-400	.15-400	.35-200	2-50	3.25		
		T1.18-3	1.18	0.01-250	0.01-250	0.02-200	0.03-50	5.65		
		T1-6	1	.01-150	.01-150	.02-100	05-50	5.65		
		T1.5-1	1.5	.1-300	.1-300	2-150	5-80	4.45		
		T1.5-6	1.5	.02-100	.02-100	.05-50	0.1-25	5.65		
		T2.5-6	2.5	.01-100	.01-100	.02-50	05-20	4.45		
		T4-6	4	.02-200	.02-200	.05-150	1-100	4.45		
		T9-1	9	.15-200	.15-200	3-150	2-40	3.95		
		T16-1	16	3-120	3-120	7-80	5-20	4.45		
		T36-1	36	.03-20	.03-20	.05-10	1-5	6.95		
		TO	TO-75	1	10-500	—	10-500	40-250	6.95	
			TH	T1-1H	1	8-300	8-300	10-200	25-100	5.95
		T9-1H		9	2-90	2-90	3-75	6-50	6.45	
		T16-H		16	7-85	7-85	10-65	15-40	6.45	
		TMO	TMO1-02	1	1-800	1-800	2-500	—	9.45	
			TMO1-1	1	.15-400	.15-400	.35-200	2-50	6.25	
			TMO1.5-1	1.5	.1-300	.1-300	2-150	5-8	8.45	
			†TMO2.5-6	2.5	.01-100	.01-100	.02-50	05-20	7.95	
			†TMO4-6	4	.02-200	.02-200	.05-150	1-100	7.95	
TMO6-1	6		3-200	3-200	5-150	5-50	7.95			
TMO9-1	9		.15-200	.15-200	3-150	2-40	7.95			
TMO16-1	16		3-120	3-120	7-80	5-20	7.95			
D 	T	T2-1	2	.050-600	.050-600	.1-400	5-200	3.95		
		T3-1	3	5-800	5-800	2-400	—	4.45		
		T4-2	4	2-600	2-600	5-500	2-250	3.95		
		T8-1	8	.15-250	.15-250	25-200	2-100	3.95		
		T14-1	14	2-150	2-150	5-100	2-50	4.95		
		TMO	TMO2-1	2	.050-600	.050-600	.1-400	5-200	7.95	
	TMO3-1		3	5-800	5-800	2-400	—	8.45		
	TMO4-2		4	2-600	2-600	5-500	2-250	7.95		
	TMO8-1		8	.15-250	.15-250	25-200	2-100	7.95		
	FT	TMO14-1	14	2-150	2-150	5-100	2-50	8.45		
		FT1.22-1	1.22	.005-100	.005-100	.01-50	05-25	35.95		
		FT1.5-1	1.5	.1-400	.1-400	5-200	1-100	35.95		
	E 	FTB	FTB-1	1	2-500	2-500	5-300	1-100	36.95	
FTB1-6			1	.01-125	.01-125	.05-50	1-25	36.95		
■FTB-1-75			1	5-500	5-500	5-300	10-100	36.95		
F 	T	T-622	1	0.1-200	0.1-200	0.5-100	5-80	3.25		
		T626	1	0.01-10	0.01-10	0.2-5	0.4-2	3.95		

■ Denotes 75 ohm models

* FOR A AND B CONFIGURATIONS

Maximum Amplitude Unbalance
0.1 dB over 1 dB frequency range
0.5 dB over entire frequency range

Maximum Phase Unbalance
1.0° over 1 dB frequency range
5.0° over entire frequency range

CIRCLE NO. 18

C72-2 REV. B

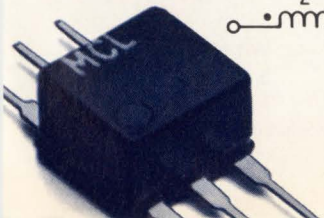



You Can Try Building Your Own Real-Time Operating System,

Building your own operating system for a real-time application can cost you up to a year in expensive programming time. And lost business opportunities. In a fast-moving market, it simply doesn't make sense to build. Not when VxWorks™ from Wind River Systems lets you move right in.

VxWorks gives you all the components and tools you need to start developing applications immediately. Which cuts your

HOSTS	TARGETS
Sun	68K
HP	SPARC
DEC	MIPS
IBM	i960

VxWorks supports multiple platforms.

costs dramatically. And because VxWorks offers a more full-featured development platform than any other off-the-shelf operating system, it gets your product to market

Or You Can Feel Right At Home With VxWorks.

faster. It's the one true turn-key solution, fully compatible with industry standards right out of the box.

Wind River Systems pioneered off-the-shelf high-speed UNIX® networking for real-time applications. And VxWorks still leads with the most complete, robust networking available. The lean, efficient wind™ kernel gives it unsurpassed multi-tasking speed and functionality.

So before you invest the time and money trying to build your own real-time operating system from the ground up, find out more about VxWorks. And feel right at home from day one.

1-800-677-1586.

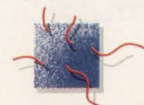

WIND RIVER
SYSTEMS

Real-Time Solutions for The Real World

How different people perceive the world

I remember talking with Charles Small about how different people perceive the world. I've worked as both a writer and visual artist, and it was fascinating to hear about the various modes of perception and expression.

At my workplace, a lot of thought and work is going into the development of practical user interfaces. Designing in-circuit emulators involves both engineering and programming skills, obviously. It strikes me that this development work is a new frontier.

*Kathy Madison
Pentica Systems Inc
Cambridge, MA 02139.*

(Ed Note: Essential reading is "The Visual Display of Quantitative Information" by Edward Tufte. Tufte, a statistician, rates graphics by an engineer as the greatest graphics ever produced. He has nothing good to say about art directors and computerized graphing programs.)

Switching from a PC to a workstation

In reference to Steven Leibson's editorial "Friendliness by the pound" (EDN, August 19, 1991, pg 55), I'd like to make a few points based on my experience transferring from a PC to a workstation.

[At our workplace] we operate a CAE program for analysis and design of electronic circuits in communications systems. We have been successfully utilizing the program on a PC for about five years. Toward the end of this period it became obvious that the PC was inadequate for our needs and that the software itself was being limited by operating under DOS, even with memory extension techniques like an LIM-compatible (Lotus-Intel-Microsoft) above-board and memory-management system.

At this point, the software house offered us a few choices:

1. Stay on a PC under DOS and use existing software (forever).
2. Stay on a PC, use OS/2, and get new hardware (extra memory, 386 machine).
3. Move to a workstation and use Unix.

Obviously (1) was not a valid long-term solution so we looked at (2) and (3). I attended shows and meetings on operating systems and learned a few key facts. The most important of these was if your application software runs better on one system than another (assuming similar hardware cost), ignore the OS and go for the best performance. With workstation prices falling and the proven track record for Unix, we went for option (3).

We got a shelf full of manuals (13 volumes), but we also got a condensed set of references similar in weight to the DOS manuals. So far, these have covered almost all we've needed to know. We also got good support from our software house. Our new workstation is a valuable addition to our development resources.

It's obviously more difficult to manage a workstation than a PC, but the extra effort to overcome teething problems is well rewarded. With regard to the technical editor, where was his software support? The Golden Rule here is to always make sure your system software is established on your platform and see it demonstrated before you decide. Workstations may not be necessary for the bit-time market yet, but their time will come.

*Chris Vernon
Racal Communications Systems Ltd
Bracknell, Berkshire, RG12 1RG, UK*

NEXT IN EDN

EDN's month-long exploration of FPGAs continues with the second part of Doug Conner's hands-on FPGA project, which will appear in EDN Magazine's April 23 issue. We wrap up our look at these devices in EDN News Edition's April 30 issue with a look at the hot new products in this field.

LCD Proto Kit

Everything you need to start your LCD application create complex screens in just a few hours!

240 x 64 pixel Supertwist LCD mounts directly onto CYB003 prototyping board.

Kit provides serial interface to IBM PC for quick prototyping. Board also supports displays up to 240 x 128 pixels.

Interface to 6 soft keys or 4 x 4 key matrix.

Dial 0-25k ohms for LCD contrast.

* The CY325 LCD Windows Controller provides parallel or serial high-level control of instrument-size LCDs. Up to 256 built-in windows support window-relative text, bargraphs, waveforms, and plots. Text and graphics are maintained in separate planes, facilitating special effects. Complete User Manual included.

Wirewrap area for custom circuitry or backlight.

RJ 11 serial jack for Rx/D, Tx/D, CTS, and GND, plus 2 spares.

5 Pin Power DIN.

Alternate Power Connector.

Add your own 8051 CPU for stand alone operation.

Kit also includes:

Power supply provides +5v and Gnd for board, -12v for LCD, and +12v spare.

Sample routines in 8051 Assembler and QuickBasic.

LCD Paint™ for creating your own graphics images.

4-wire RJ11 style cable with DB25F connector for your IBM PC.

LCD demo

Demo routines preprogrammed into 8751 for immediate gratification.

\$495 - Kit
Popular LCD Starter Kit.



(\$595 pre-assembled & tested)

*The CY325 CMOS 40-pin DIP and 44-pin PLCC LCD Controller IC are available from stock @ \$75/singles, \$20/1000s.

CyberneticMicroSystems

Box 3000 • San Gregorio CA 94074
Tel: 415-726-3000 • Fax: 415-726-3003

Whether it's 57 varieties, 31 flavors, 80 you know a leader by the

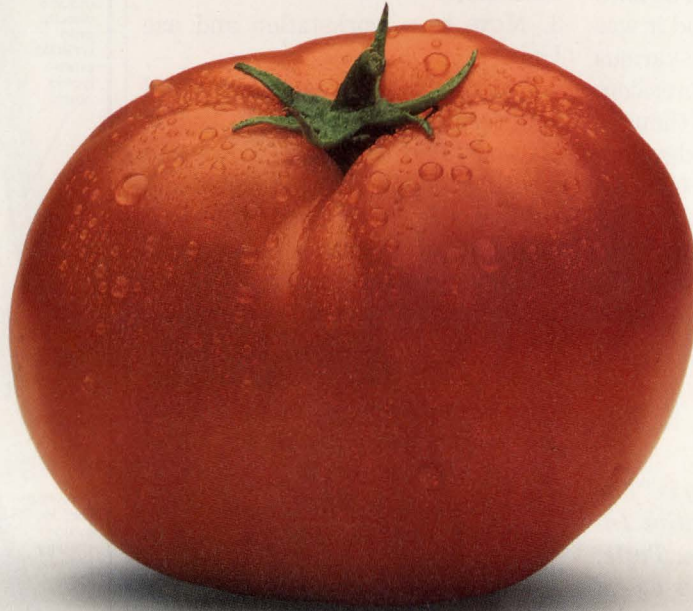

There is only one company that offers you a choice of more monolithic sampling analog-to-digital converters – 35 in all – than anyone else. Analog Devices.

But what makes us the leader isn't just the breadth of our product line. It is also its depth. For no other line of sampling ADCs encompasses a wider range of specs. A range that virtually guarantees we have the exact part for your specific application. Making it far easier for you to complete your design.

Incorporating a sample/hold front end onto an a/d converter is just one more example of our

billion served, or 35 sampling ADCs, breadth of its product line.

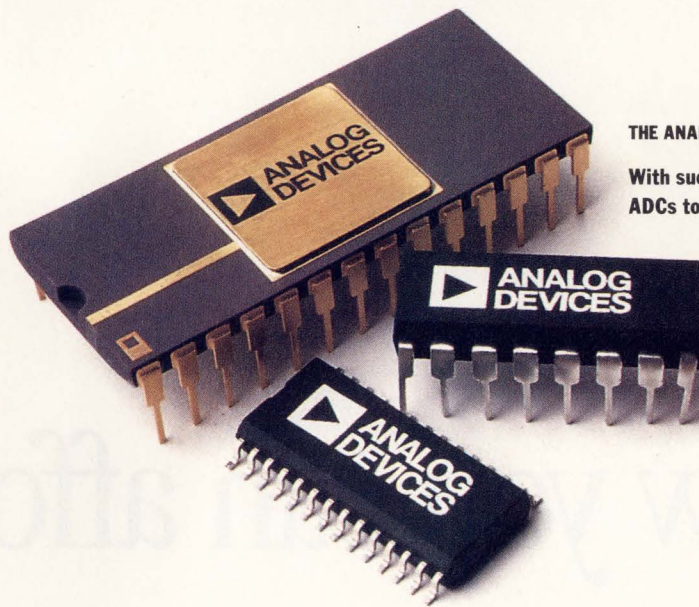

THE ANALOG FAMILY OF SAMPLING ADCs

With such a broad selection of sampling ADCs to choose from, you can find the exact part for your design.

For example, our family offers parts from 8 to 16 bits, from 50 kSPS to 1.25 MSPS, and some with up to 8 input channels. All low cost and easy to use.

expertise at integrating high-performance analog and digital circuitry on the same IC. And it is this same expertise that has made us the acknowledged leader in advanced mixed-signal technology.

So before you even think about beginning your next design, give us a call at 1-800-262-5643. Or write to us at the address below. We'll gladly send you a free copy of our complete monolithic sampling ADC guide.

It isn't very edible, but it does make for very tasteful reading.



CIRCLE NO. 22

Now you can afford to

Presenting a very small development in Ethernet.*
Chipsets that are matched to your system and your budget. In fact, they cost you as little as 5 square inches. Which, by the way, is less total real estate than any competitive solution. But sizable reductions don't stop with board space, because we're also reducing the price up to 30 percent.

Needless to say, true plug-and-play simplicity requires an intelligent network interface. So our new high-integration 82503 Dual Serial Transceiver goes beyond IEEE 802.3 to include automatic port selection, polarity switching and a jumperless interface to AUI or TPE.

For unmatched desktop performance, we offer

© 1992 Intel Corporation. Intel386 and Intel486 are trademarks of Intel Corporation. *Ethernet is a registered trademark of Xerox and Diamond is a registered trademark of Diamond Brands, Inc.



put Ethernet in any box.

a complete family of 82596 LAN coprocessors, each optimized to a specific Intel486™ CPU for maximum throughput. And our 82593 is the perfect LAN controller for Intel386™ SL notebooks.

Best of all, these true two-chip solutions give you the flexibility to simplify your design and deliver your product to market in the smallest of timeframes.

So look into today's hottest Ethernet chipsets. Call (800) 548-4725 and ask for Lit. Packet #YA23. And learn why we have the perfect match for your next box.

intel®

The Computer Inside.™

POWER SPLITTERS/ COMBINERS

the world's largest selection
2KHz to 8GHz from \$4⁹⁵

With over 300 models, from 2-way to 48-way, 0°, 90° and 180°, a variety of pin and connector packages, 50 and 75 ohm, covering 2KHz to 8000MHz, Mini-Circuits offers the world's largest selection of off-the-shelf power splitter/combiners. So why compromise your systems design when you can select the power splitter/combiner that closely matches your specific package and frequency band requirements at lowest cost and with immediate delivery.

And we will handle your "special" needs, such as wider bandwidth, higher isolation, intermixed connectors, etc. courteously with rapid turnaround time.

Of course, all units come with our one-year guarantee. Unprecedented 4.5 sigma unit-to-unit repeatability also guaranteed, meaning units ordered today or next year will provide performance identical to those delivered last year.

For detailed specs and performance data, refer to the MicroWaves Product Directory, EEM or Mini-Circuits RF/IF Signal Processing Handbook, Vol. II. Or contact us for our free 68-page RF/IF Signal Processing Guide.

finding new ways ...
setting higher standards

Mini-Circuits

A Division of Scientific Components Corporation
P.O. Box 350166, Brooklyn, New York 11235-0003 (718) 934-4500
Fax (718) 332-4661 Domestic and International Telexes: 6852844 or 620156

CIRCLE NO. 24

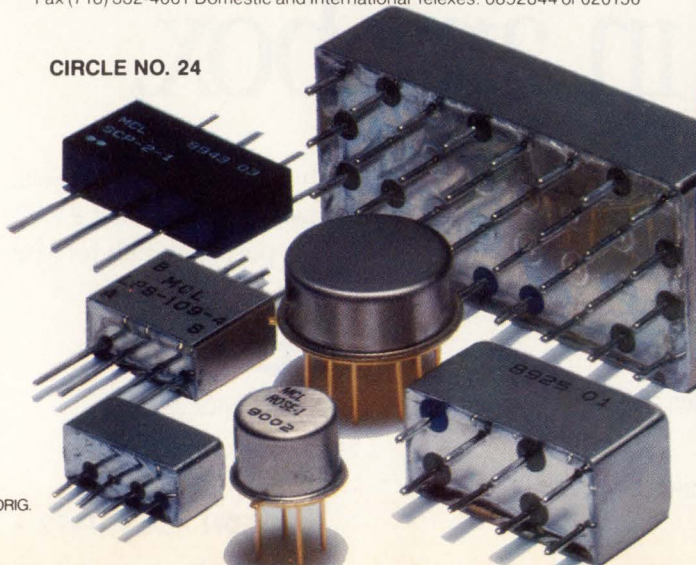

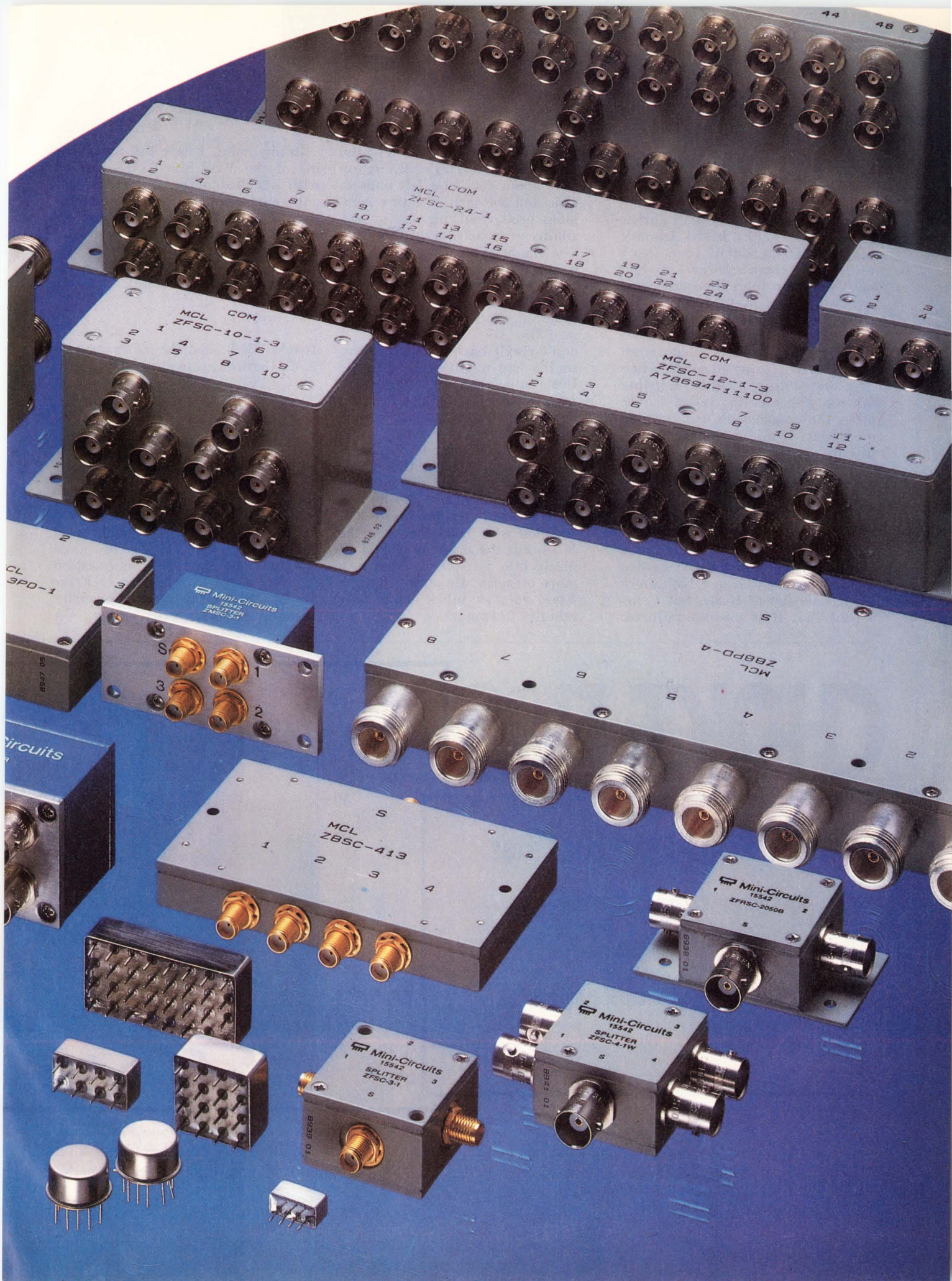

MCL COM
ZFSC-24-1

1 2 3 4 5 6 7 8 9 10 11 12 13 14 15 16 17 18 19 20 21 22 23 24

MCL COM
ZFSC-10-1-3

1 2 3 4 5 6 7 8 9 10

MCL COM
ZFSC-12-1-3
A78694-1100

1 2 3 4 5 6 7 8 9 10 11 12

MCL
ZBSPD-4

1 2 3 4 5 6 7 8 9

MCL
ZBSC-413

1 2 3 4 5

Mini-Circuits
15542
SPLITTER
ZFSC-2050B

1 2 3 4 5

Mini-Circuits
15542
SPLITTER
ZFSC-4-1W

1 2 3 4 5

Mini-Circuits
15542
SPLITTER
ZFSC-3-1

1 2 3 4 5

Mini-Circuits
15542
SPLITTER
ZFSC-3-1

Mini-Circuits
15542
SPLITTER
ZFSC-3-1

Mini-Circuits
15542
SPLITTER
ZFSC-3-1

Mini-Circuits
15542
SPLITTER
ZFSC-3-1

Ferengis, Romulans, and the Borg, beware

In reply to the request for information about Star Trek V2.0 in the January 2 issue of EDN, about 10 years ago I worked for a company where we had Star Trek on an Intel Microprocessor Development System (MDS). We spent a lot of lunch hours and spare time playing with it. As a result, we learned quite a bit about the program and produced a listing on paper. When I left the company, I took a listing with me, and over the years, I have gotten the program up and running on an Atari 520ST and worked intermittently on translating the program to C. What I've learned is:

- The program is written in Basic and is about 2000 lines long. The listing runs to 30 pages and has no PEEKs or POKEs.
- The object file on disk contains a Basic interpreter and an encoded version of the source. I don't know what version of Basic, but I suspect that it is custom tailored.

When you load this into an Intel MDS with 64 kbytes of RAM, you have about 400 bytes left unused. This and the lack of a save command pretty well rule out any possibility of modifying the program.

- The one bug that I remember was a tendency for certain input combinations—I don't remember exactly which ones—to crash the program. Since I put the program into the Atari with ST Basic, I don't recall having this problem, so the bug might well be in the Basic interpreter.
- At one point I tried putting Star Trek into another 8-bit system with 64 kbytes of memory using a commercially available Basic interpreter. I got about three quarters of the program in (by typing it) and ran out of memory. I don't believe you would have much better luck with Intel Basic on the MDS, but the program should fit nicely into a 16-bit machine with more memory. Be aware that my Atari version takes about four minutes to load.

In any event, I have the paper listing of the MDS Star Trek—covered with penciled notes, but still readable—and would be happy to send a copy to Ask EDN. Or, if you have access to an Atari 520ST, I could send a disk with the source code for the ST version and the text file of an expanded instruction manual.

Ken Bartlett
San Jose, CA

Thanks. We'll send the information on to M J Garraway in the United Kingdom.

The how and why behind root-sum-squared calculations

In the February 3 edition of EDN, Gary Altman requested a theoretical justification for the commonly used root-sum-squared (RSS) tolerance analysis. The answer to his question is given in *An Introduction to Error Analysis* by John R Taylor, University Science Books, Mill Valley, CA

CHOICE FIRS

HSP43168 Dual FIR Filter

- World's fastest standard FIR filter at 45 MHz
- Flexible for multiple configurations
- From two 4-tap filters to one 256-tap filter
- Stores 32 filter sets on chip; changes filters on the fly

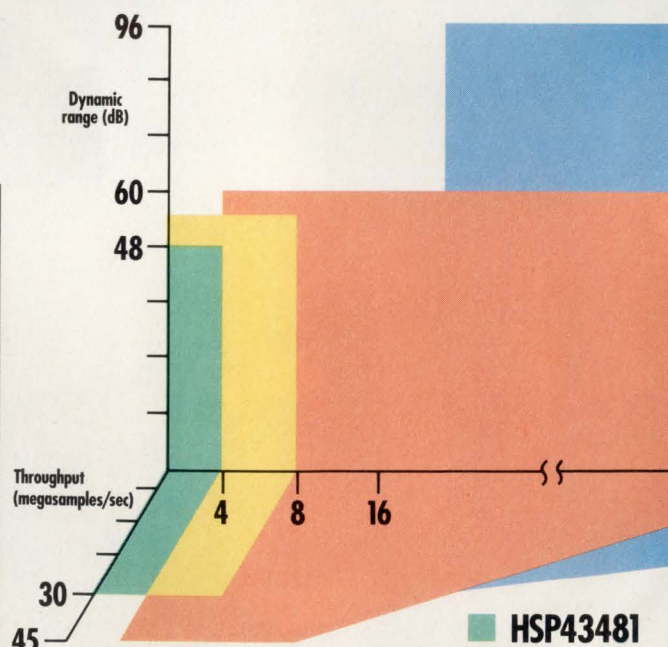

Nobody gives you more choices in programmable FIR filters than Harris. From the

45 megasamples per second throughput of our HSP43168, to the 512,000-equivalent-tap

precision of our HSP43220, Harris has a FIR filter that meets your digital filtering needs.

(\$19.50 paperback, \$24 hardbound). Chapter three develops tolerance equations suitable for electronic circuits. The inside cover summarizes the formulas. Every design engineer should read and understand this book.

Mr Altman has good reason to suspect the simplistic RSS approach; it is seldom correct. A dimensional check alone should set off a warning alarm. What could justify combining resistor tolerance, transistor gain tolerance, and offset voltage limits in this manner? Clearly, these diverse quantities need some conversion before they represent error contributions.

Begin the analysis with an algebraic equation for the observable properties of the design (voltage, current, force) in terms of component parameters. Parameters include resistance, capacitance, gain, offset, and leakage. Find a parameter's contribution to the observable properties' tolerance by taking the partial derivative of the equation with respect to that parameter. The result is an algebraic coefficient times the symbolic differential of the parameter. This coefficient

does the appropriate scaling and dimensional conversion; the differential is going to accept something related to the parameter's tolerance.

Next, assume the tolerances have a Gaussian (normal random) distribution around the mean value. Deduce each parameter's standard deviation from specifications or from measurements. (The standard deviation provides a more informative measure of tolerance.) Multiply each parameter's standard deviation by the associated algebraic coefficient to obtain a corresponding standard deviation for the observable properties. The individual tolerance contributions (standard deviations) combine as the RSS when the statistics are Gaussian, as we have assumed.

Combining simple tolerances in the RSS manner is only valid when all the algebraic coefficients are 1 after numerical evaluation. Such is the case for serial propagation delays in digital circuits and for similar cascaded contributions. In most cases, however, the RSS of tolerances is meaningless.

If any readers need further help, Intel Service Co offers production tolerance analysis and design reviews at reasonable cost.

*James A Kuzdrall, PE
President
Intel Service Co
Nashua, NH*

We received more than a dozen letters justifying root-sum-squared tolerance analysis, and yours said it best. Thanks.

Readers respond to Rieger's naggers

In the January 20, 1992, Ask EDN (pg 43), James Rieger posed three questions. The first question was about the ringer equivalence of devices hooked up to the dial-up telephone network. The second was about the characteristics of telecommunications devices for the deaf.

Approximately a dozen readers answered the first two questions. The best answers are printed here. The third

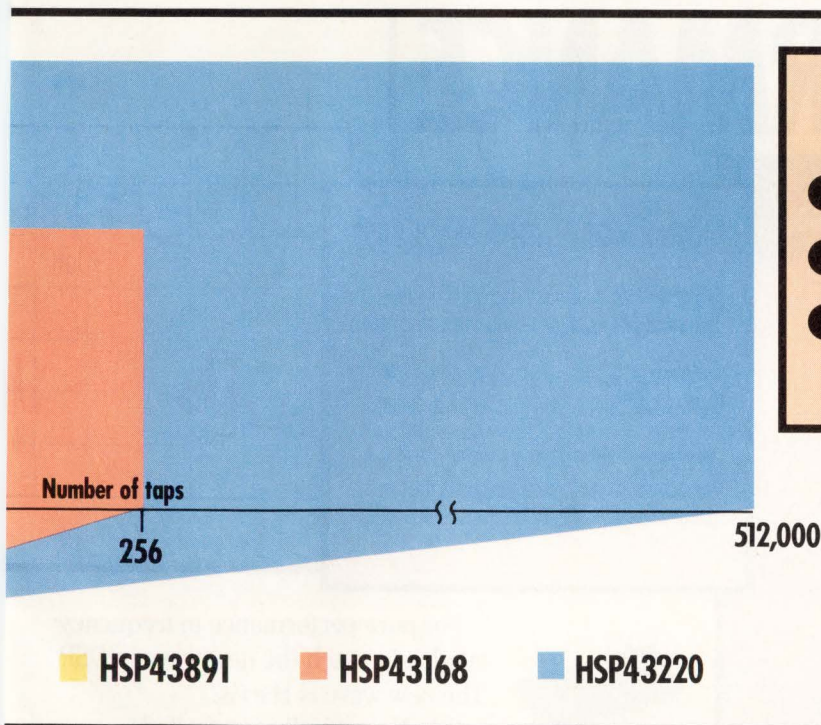

HSP43220 Decimating Digital Filter

- Highest precision FIR filter with 512,000 equivalent taps
- Optimal for very narrow band low-pass filtering
- High order decimate filter (up to 1024) and high tap FIR (up to 512) on single chip

**THE NEW
WAVE
IN DSP**

So why not give us a call today? With our broad line of DSP products — including NCOs, digital

filters and image processing — we're the new wave in DSP. Catch it. Call 1-800-4-HARRIS, ext. 1172.

HARRIS
SEMICONDUCTOR

question, about the carrier deviation for transmission of a satellite-relayed television signal, is still up for grabs.

Regulations define ringer equivalence

I can assist with Mr Rieger's query regarding ringer equivalency.

The definition of ringer equivalency is in the US Code of Federal Regulations, Title 47 (Telecommunication), Part 68 (Connection of Terminal Equipment to the Telephone Network), section 68.312 (On-Hook Impedance Limitations), paragraph d. This definition is implemented in the FCC Instructions to Form 730 (Application for Part 68 Registration). The purpose of 47 CFR 68, known in the industry as FCC Part 68, is the protection of the telephone network.

Two major types of ringers, A and B, are manufactured depending on the desired frequency coverage. The

ringer load is not necessarily all real. To determine the ringer equivalence number (REN), first measure the impedance of the ringer of a product as indicated: Type A ringer, 20 and 30 Hz; Type B, 15.3 through 68 Hz. The lowest impedance measured is used as the denominator. The numerator comes from FCC Part 68 based on the historical impedances of ringers: Type A, 7000 for 20 Hz; 5000 for 30 Hz; Type B, 8000. An example of this calculation is $REN = 7000 \div Z$ for a Type A ringer driven at 20 Hz.

FCC rules state that telephones and other equipment may be connected to a telephone line (called a loop) as long as the sum of their RENs is equal to or less than 5.0. There are two reasons for this requirement: (1) a ringing signal from a telephone central office contains sufficient energy to ring only so many loop-powered telephones of average design; and (2) if a telephone's ringing were not answered, telephone-company equipment would be tied up unnecessarily, generating excessive trouble reports. This last

situation would cause impairment of service to other customers.

Because complex impedance is not included in the definition of REN, and complex impedance affects the ability of the central office to deliver ringing energy, many telephone companies state in their tariffs that they will provide sufficient energy to cause ringing of equipment having a sum REN less than or equal to 4.0.

FCC Part 68 is being reviewed for possible updating by the Regulatory Issues Subcommittee of the Telecommunications Industry Association Engineering Committee. C L Berestecky of AT&T is chair of the subcommittee. The instructions to FCC Form 730, Application for Part 68 registration, are administered by William von Alven of the FCC Staff, Industry Administrative ad hoc Advisory Committee, Mr Ronald G Provost of Bell Communications Research, Chair.

*Clifford E Chamney
Member of Technical Staff
United Telecommunications Inc
Kansas City, MO*

PURE PERFORMANCE

	HSP45116	HSP45106	HSP45102
Phase accumulator size	32 bits	32 bits	32 bits
Phase control	16 bits	16 bits	2 bits
Frequency control	32 bits	32 bits	32 bits
Tuning resolution at maximum speed	0.008 Hz	0.008 Hz	0.009 Hz
Interface	Standard μ P	Standard μ P	Serial
Speed	33 MHz	33 MHz	40 MHz
Output	16 parallel	16 parallel or serial	12 parallel

DIGITAL MODULATION MADE EASY

QAM Implement nearly infinite levels of Quadrature Amplitude Modulation

PSK Implement all forms of Phase Shift Keying from DPSK to 8PSK

FM/FSK/FHOP Real time frequency control; change frequency in a single clock cycle

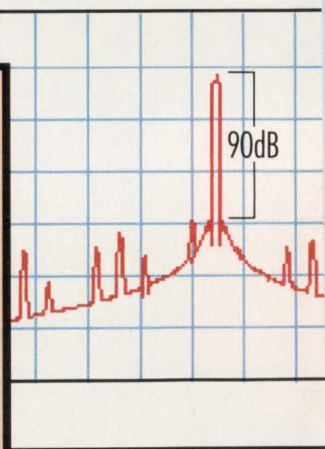

HSP45102
Shown Actual Size

For pure performance in frequency synthesis, catch the new wave in DSP. The new wave is Harris.

Our Numerically Controlled Oscillators (NCOs) offer spectral purity of better than 90 dB. Tuning resolution of 0.008 Hertz. 32-bit-wide

Address for TDD information

I have an address that might help James Rieger find out more about telecommunications for the deaf (TDD):

Telecommunications for the Deaf Inc
8719 Colesville Rd, Suite 300
Silver Spring, MD 20910
(301) 589-3786.

*Kouros Derakhshani
Transistor Devices Inc
Randolph, NJ*

Frequency pairs for TDDs

In answer to Mr Rieger's question about telecommunications devices for the deaf, I think I can shed some light on the subject.

The original teleprinters used on the National Deaf Phone TTY/TDD Network ran 60 wpm, or 45 baud, Baudot Code in compliance with the Weitbrecht FSK standards of 1400-Hz

mark and 1800-Hz space frequencies. These early TTYs (teletypewriter units) did operate at half duplex, and the go-ahead characters were typed at the end of each message to keep the operators from stepping on each other's fingers. All the early modems used acoustic coupling, but as phone regulations softened up, modems started appearing with both direct and acoustical coupling. Portable telecommunications devices also came out with Bell 103 standards and ASCII with 110/300-baud capabilities. The 103A3 frequency pairs are

Mode	Frequency	Mark frequency (Hz)	Space frequency (Hz)
Originate	T f1	1270	1070
Originate	R f2	2225	2025
Answer	T f2	2225	2025
Answer	R f1	1270	1070

I hope this answer helps Jim get some sleep. I'm sorry, but I don't feel qualified to answer his third question.

*Mike Phillips
Dartech Engineering
Winston, OR*

Still stumped by third nagger

James Rieger's third question was "What is the carrier deviation for transmission of a satellite-relayed television signal? Because the television waveform is asymmetrical, what is the position of blanking with regard to the band edges of the channel? Does white cause a positive deviation of the carrier frequency of a negative one?" Please contact Ask EDN if you can put this one to rest.

Ask EDN solves nagging design problems and answers difficult questions. Address your letters to Ask EDN, 275 Washington St, Newton, MA 02158. FAX (617) 558-4470; MCI: EDNBOS. Or send us a letter on EDN's bulletin-board system at (617) 558-4241: From the Main System Menu, enter SS/ASK_EDN and select W to write us a letter.

SPECTRAL PURITY OF THE HARRIS NCO FAMILY

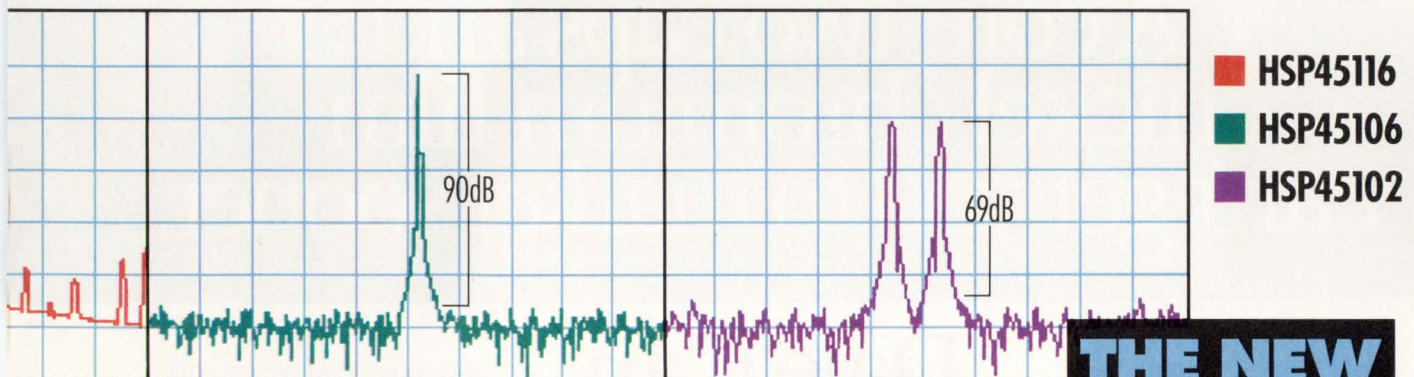

Typical spectral purity as measured by 2048 point FFT with Blackman window. The Harris family of NCOs will always have a spurious-free dynamic range better than shown.

phase accumulation. No one else offers NCOs that generate signals so pure with so much precision.

No one else offers NCOs with so many features, either. Our HSP45116 also implements Direct Digital Down Conversion on the same chip. And

our HSP45102 12-bit NCO has a footprint of just 0.28 square inches.

So get in tune with Harris. With our broad line of DSP products — including NCOs, digital filters and image processing — we're the new wave in DSP. Catch it. Call 1-800-4-HARRIS, ext. 1171.

**THE NEW
WAVE
IN DSP**

HARRIS
SEMICONDUCTOR



A core, two caps and
nickel chromium film
can't get you to market sooner.

Metal film resistance. Lots of people supply it, but at Dale® we have more ways to make it work to your advantage.

From the start, we'll give you more alternatives for fine-tuning resistance to your application — right out of the catalog. Low cost commercial to ultra precision.

High power. Ultra high or low value. Tight tolerance. Matched sets. Thick film chips, plus thin film chips for surface mounting. Qualifications include: MIL-R-10509, MIL-R-22684, MIL-R-39017, MIL-R-55182 and MIL-R-55342.

Dale® Can.



All guided by Statistical Process Control and Just-In-Time Delivery systems.

For high performance, high volume or both, Dale has products to meet your exact needs, plus

multiple sourcing to protect your production schedule.

Save time by contacting your Dale Representative or contact: Dale Electronics, Inc., Norfolk Division, 2300 Riverside Blvd., Norfolk, NE 68701-2242. Phone (402) 371-0080.



WAS THERE *some special*
reason we produced

The

WORLD'S

F I R S T

16 *meg*

D R A M ?

YES *there was.*

TO LET

you

CHANGE

the

WORLD.







Samsung began shipping DRAM chips in the new 16M density—in production volumes—during 1991. Our customers for the product include many of the world's premiere computer and workstation makers.

They tell us we are the first supplier to complete this next generation of memory.

We, in turn, see it as a significant milestone in the global effort toward elegance and power in computing.

Of equal significance, Samsung's completion of the generation marks something of a transformation in the worldwide map of supply. And we believe consumers

of electronic components will benefit from this.

Yet perhaps most important, is the fact that the 16-meg will indeed help the electronics community—in the U.S. and elsewhere—to do nothing less than change the world.

The new-generation DRAMS are a significant boon to the hugely beneficial

technology of today's workstations. Machines that allow us to better comprehend the world, and to

advance in areas as different as medicine and transportation, finance and filmmaking.

The new generation will also, in short order, facilitate ever-more-capable notebook and palmtop computers. Computers that will make us more productive—and will also define the workplace in a

whole new way.

In the near future, more will be heard from Samsung.

We are among the major makers of DRAMS in all organizations and densities, and we are an increasingly major supplier of SRAMS.

We make a wide line of fast, ultra-fast, and high-density SRAMS, up to 4M in density and 8 ns in speed.

Our specialty memories include ROMS, VRAMS, pseudo and cache SRAMS, EEPROMS, and FIFOs. And we also build superior ASICs, microcontrollers, MOSFETS, and RAM DACS.

And, of course, in DRAMS, there is always the 64-meg.

About which, we hope to be writing soon.

If we may provide further information of any kind,

please contact us via the coupon at left, or by telephone at 1-800-446-2760.

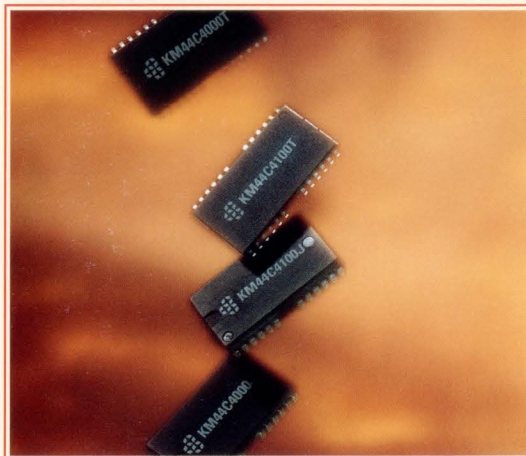

The world's first 16-meg DRAM.

Organization	Mode	Speed	Samples	Production
16M X 1	FAST PAGE	60/70/80	NOW	NOW
16M X 1	NIBBLE	60/70/80	NOW	6-92
16M X 1	STATIC COL.	60/70/80	NOW	6-92
4M X 4	FAST PAGE	60/70/80	NOW	NOW
4M X 4	STATIC COL.	60/70/80	5-92	8-92
4M X 4 (WPB)	FAST PAGE	60/70/80	5-92	8-92
4M X 4 (WPB)	STATIC COL.	60/70/80	5-92	8-92

2K and 4K refresh available.

YES. I want to learn about the next generation of memory. Please send more information.

Name _____ Title _____
 Company _____
 Address _____
 City _____ State _____ Zip _____

Return coupon to Marketing Communications, Samsung Semiconductor, 3725 No. First St., San Jose, CA 95134. Or call:

1-800-446-2760



A Generation AHEAD.

Don't tread on me



For some reason, we in the US seem to think that government interference is a good thing, even when it runs contrary to common sense. Two recent issues in the news prove the point: high salaries for company presidents and re-regulation of the cable-TV business.

In mid 1991, *Forbes* magazine reported that Steven J Ross of Time Warner Inc received more than \$78 million in compensation. No wonder Japanese executives complain that US companies pay their executives too much. Comments from the Japanese and reports in the press set off a storm of protest in Washington. Legislators have proposed rules and regulations that would limit executive pay and compensation. This is a wrong-headed approach. Frankly, executive pay is an irrelevant issue.

Most of us agree that performance should be rewarded and that many executives are overpaid for what they do. However it probably doesn't matter to you and me. So what if Apple Computer's John Sculley earns \$16 million per year? He has to do something with that money. It goes back into the economy, being spent and invested in many ways. It doesn't disappear.

Sculley's high salary expenditure may mean that Apple has less to spend on basic research, but it's up to the company's board of directors and its stockholders to determine that. I own no Apple stock, so whether Apple pays Sculley one dollar or \$16 million is irrelevant

to me. If Apple loses its competitive edge because it pays its executives too much, it's the investors who will lose. A more competitive computer company that spends its money better will take Apple's place.

Competition and risk are important concepts, often beyond legislators' understanding. Stripped of many regulations, the cable industry has become more competitive as investors have risked money on new ventures. As always, competition spawns variety. Here in the US, I can watch programs that range from religious services to first-run movies, and from rock-music videos to 24-hour newscasts. However, the increasing costs of cable-TV services have sparked Congress to consider re-regulating cable TV. Our legislators fear that networks will take over cable channels and will charge for broadcast programs that they provide for free today.

Today's innovative technologies mean that there will be more competition in the television arena, not less. Fiberoptic cables will broaden the spectrum of services, and small, start-up program suppliers will have easy access to our TV sets. It's unlikely that today's TV-program and network giants will obtain a stranglehold on our viewing habits. Even if they could, their monopoly would only be temporary. In the meantime, we could always turn off the TV and read a book . . . or a magazine.



Jesse H. Neal
Editorial Achievement Awards
1990 Certificate, Best Editorial
1990 Certificate, Best Series
1987, 1981 (2), 1978 (2),
1977, 1976, 1975

American Society of
Business Press Editors Award
1988, 1983, 1981

Send me your comments via FAX at (617) 558-4470, or on the EDN Bulletin Board System at (617) 558-4241 300/1200/2400, 8,N,1; on 9600-bps modems try (617) 558-4580, 4582, or 4398.

Jon Titus
Editor

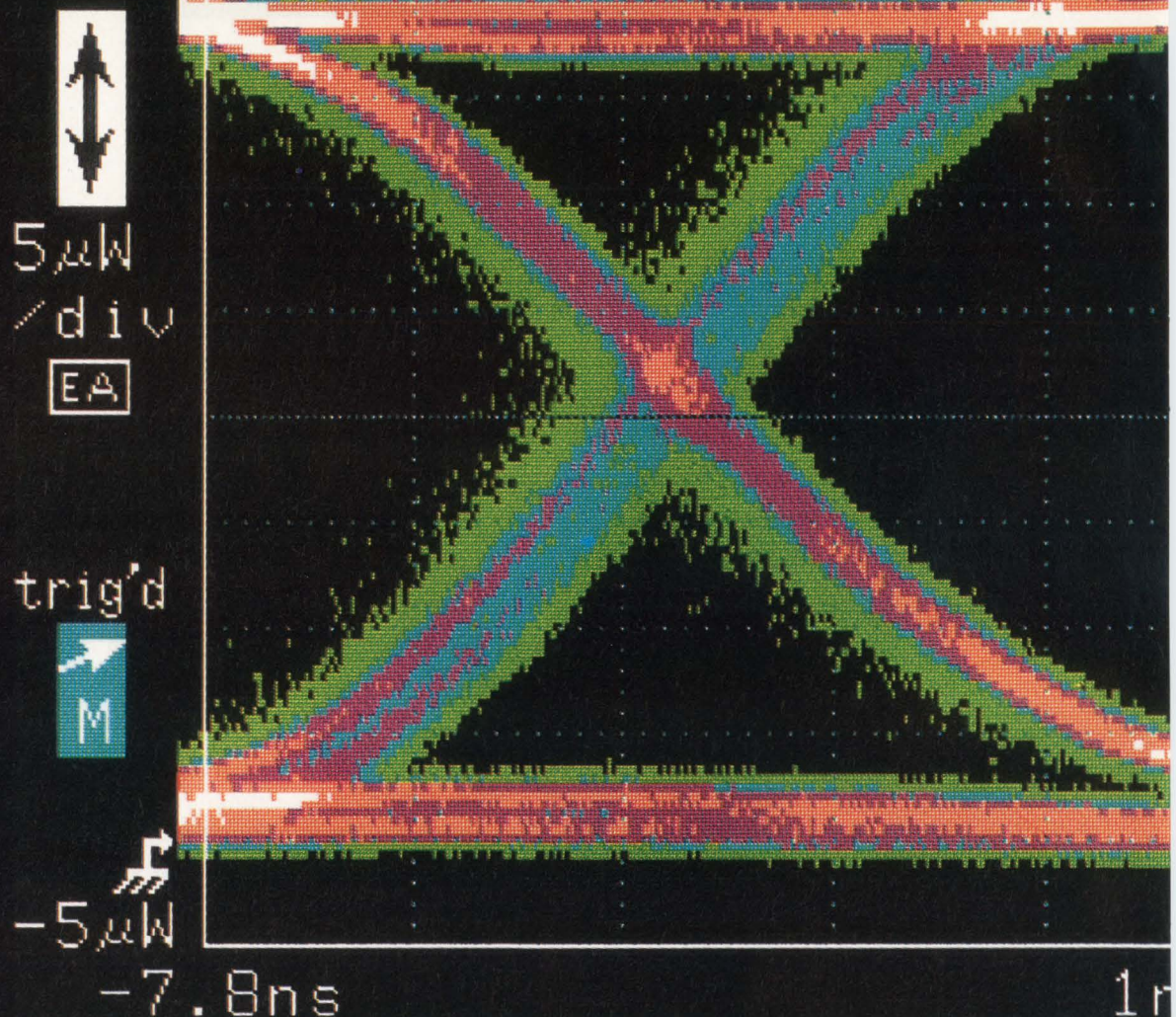

Rise (S)	Jitter (S)	Noise (S)
2.760 ns	144.8 ps	912.2 nW

WE'LL GIVE YOU



In a world so dependent on communicating, your customers don't take kindly to interruptions. So in the interest of keeping folks in touch with one another, Tektronix makes communications signal

analyzers that let you measure jitter and noise automatically. And bit error rate testers that can lock onto and test specific or pseudo-random patterns—even those millions of bits long. But these devices are just part of a sophisticated collection that includes optical-to-electrical converters,

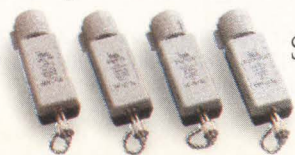

SDH/SONET reference



37A-188255 Copyright © 1991, Tektronix, Inc.

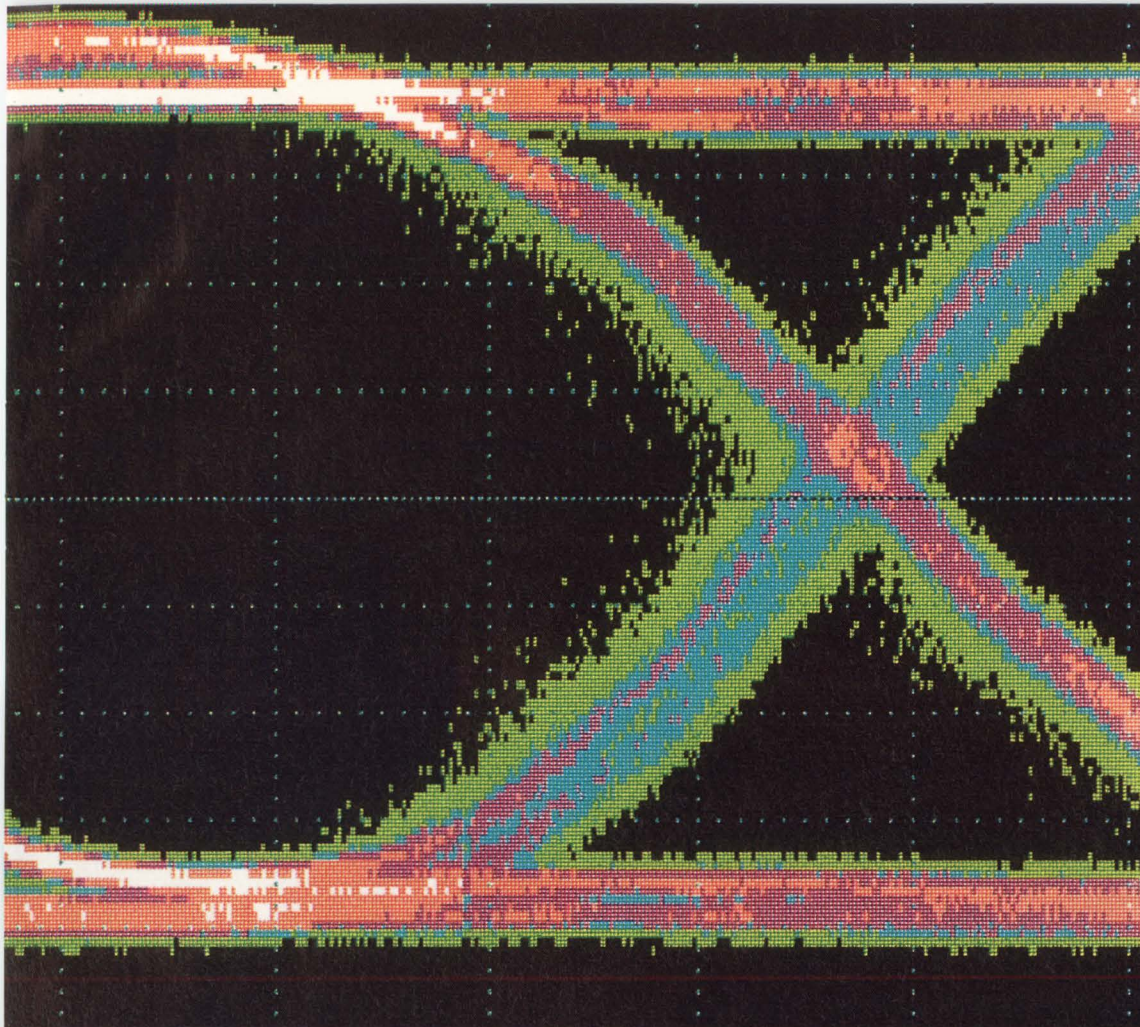

s/div 2.2ns

Measurements	Vert Size: R3
	5 μ W/div
	Vert Offset: R3
	20 μ W

THE JITTERS.

receivers, optical attenuators, and optical and metallic time-domain reflectometers. High-performance equipment for everyone from design engineers to field service technicians.

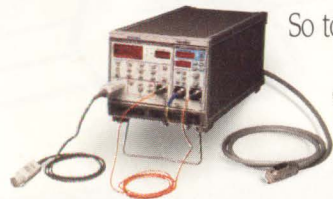

So to make sure your customers are getting all the right messages, talk to Tek today. We promise, we'll do everything we can to help you keep the lines of communication open. **TALK TO TEK/1-800-426-2200**

Tektronix
Test and Measurement

It Takes Some Characteristics To

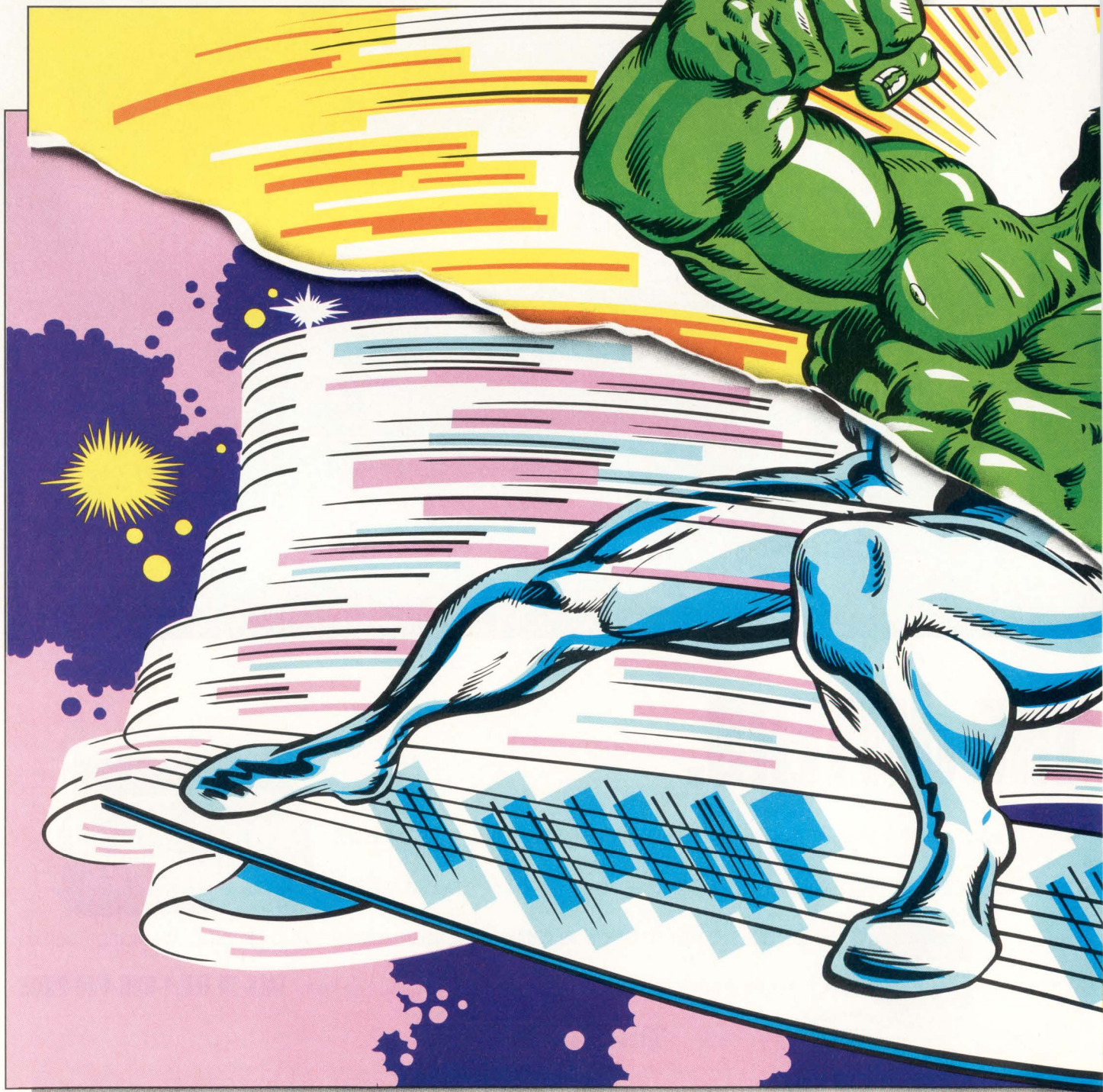

The Silver Surfer and The Incredible Hulk are trademarks of Marvel Entertainment Group, Inc. © 1991. All rights reserved.

Very Special Be #1 In EPROMs.

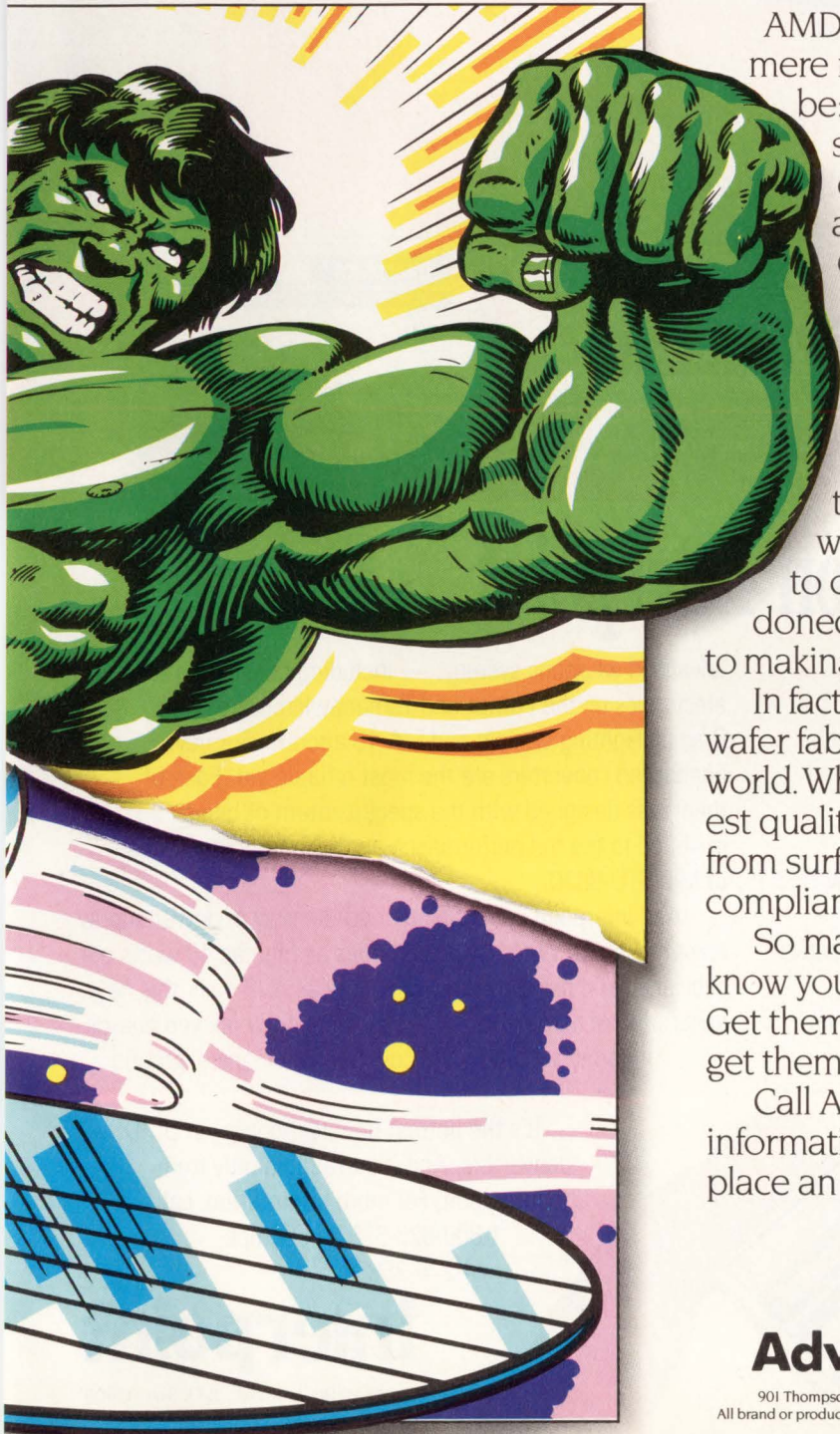

AMD EPROMs today are what other mere mortal EPROMs can only aspire to be: high density, of course. But also high speed. Able to store massive amounts of information, with lightning fast access times. All in our superior CMOS technology.

EPROMs have always been our strength—thanks to our unparalleled performance, selection, reliability, and quality.

That's why we sell more EPROMs than any other vendor.* Period. And we're ready to do the same for years to come. While other vendors have abandoned EPROMs, we're still committed—to making the fastest, highest density EPROMs.

In fact, we've got the most advanced EPROM wafer fab, assembly and test facilities in the world. Which produce the most reliable, highest quality EPROMs available. In everything from surface mount plastic to mil spec compliant packages.

So make yourself a hero. The instant you know your EPROM requirements, get them fast. Get them dense. Get them in volume. And get them right away.

Call AMD at **1-800-222-9323** for more information. Or call your local sales office to place an order.



Advanced Micro Devices

901 Thompson Place, P.O. Box 3453, Sunnyvale, CA 94088 © 1991 Advanced Micro Devices, Inc.
All brand or product names mentioned are trademarks or registered trademarks of their respective holders.
*Dataquest, March 1991, based on 1990 data.

Our newest line of defense against heat.

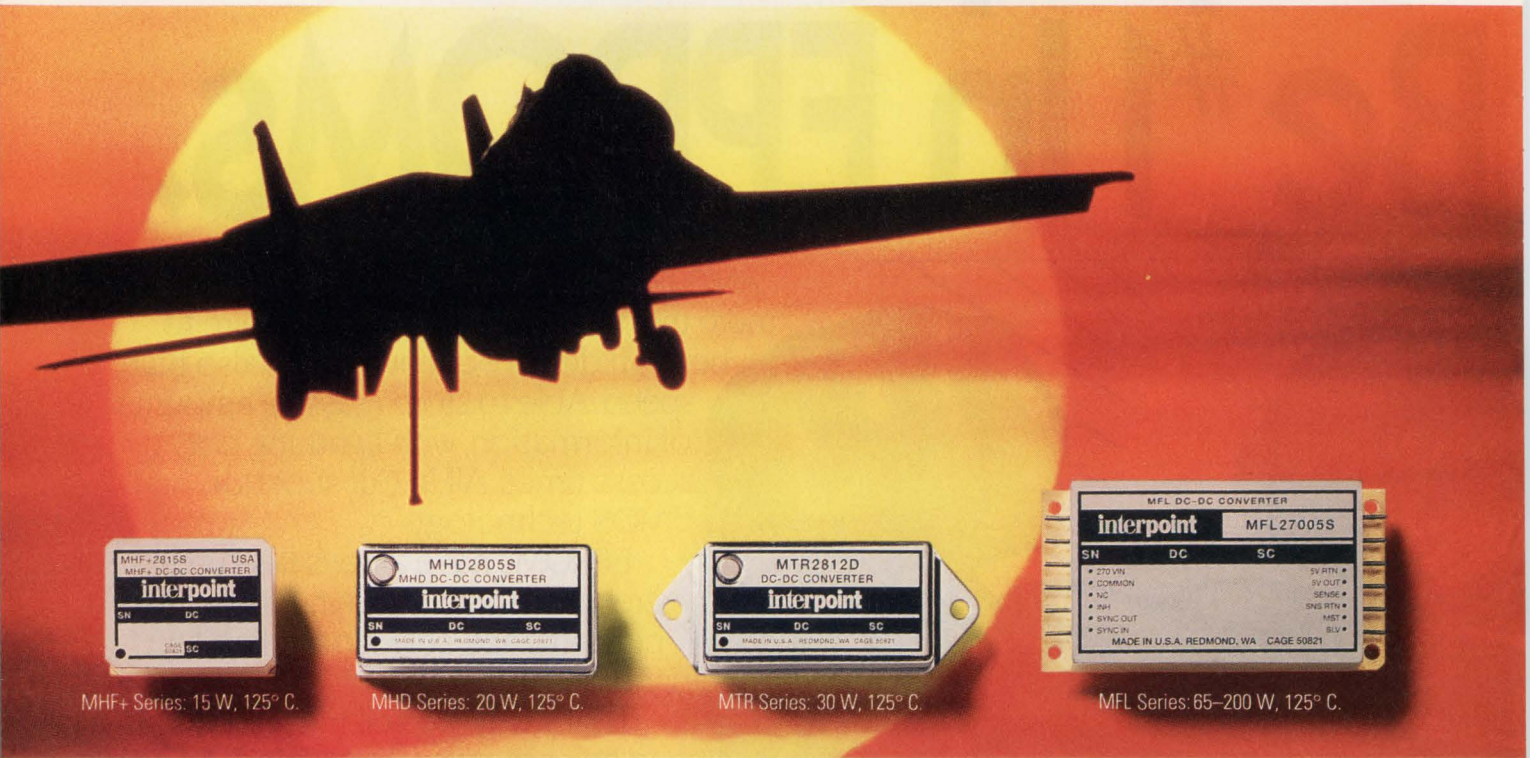

MHF+ Series: 15 W, 125° C.



MHD Series: 20 W, 125° C.



MTR Series: 30 W, 125° C.

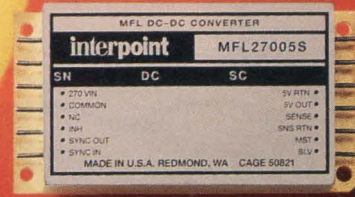

MFL Series: 65–200 W, 125° C.

Insist on Interpoint.

A full line of high-temperature DC-DC converters from the industry leader.

Get the hottest technology in board-mounted power supplies. Full military temperature range. Unsurpassed reliability. The lowest profiles. You can get it all with Interpoint's new line of DC-DC converters.

From arctic blasts to desert storms, Interpoint's new generation DC-DC converters stand up to the toughest military environments. They deliver full power over the entire -55° to +125° C. temperature range. And over an unprecedented power range, too. Interpoint can now offer you an off-the-shelf hybrid power supply for any power level from 2 to 200 watts.

For more than a decade, Interpoint DC-DC converters have proven their reliability in many of the world's most

MSA Series: 5 W, 125° C.

Interpoint's new line of DC-DC converters features constant PWM switching frequencies from 500 to 700kHz. Built-in sync. Parallel operation. Up to 50 dB audio rejection. Line and load regulation as low as 0.1%. And full MIL-STD-704 input for 28- and 270-volt systems.

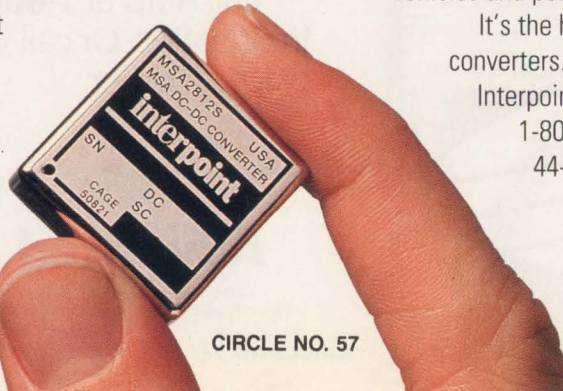

CIRCLE NO. 57

advanced weapons systems — including mission-critical electronics on the Patriot and Tomahawk missiles, the Bradley Fighting Vehicle and F/A-18 aircraft. Our new generation converters are the most reliable yet. Each of them was designed with the specific intent of being qualified to the full performance and reliability standards of MIL-STD-883C.

And Interpoint continues to lead the way in power supply miniaturization. With power densities as high as 40 watts per cubic inch and package heights as low as .270 inch, this new generation of converters is built for the tightly packed boards in today's military and commercial avionics, ground vehicles and portables.

It's the hottest new technology in DC-DC converters. And it's available only from Interpoint. For more information, call 1-800-822-8782. In Europe, 44-276-26832.

interpoint

10301 Willows Road P.O. Box 97005
Redmond, WA 98073-9705

Design software links active-filter performance with real devices

ANNE WATSON SWAGER, Technical Editor



Analog filter-design software helps to not only perform filter designs' obligatory math quickly, but some programs can also select the right active and passive components to implement the filter. First, be sure the software supports the filter ICs that best match your overall system requirements.

Active-filter design software takes the tedium out of a mathematically intensive job. Because equations so closely predict an analog filter's performance, software that solves those equations is obviously a useful tool. Without performing the math, it'd be virtually impossible to design any filter with predefined characteristics. "You can't hack filters on the bench," points out Jim Williams of Linear Technology. Software is also the best candidate to perform the numerous iterations required to optimize the filter for a particular characteristic.

Tremendous numbers of active-filter design packages exist (Ref 1), and are available from software vendors, IC vendors, and shareware-program vendors (such as those you'll find posted on EDN's Bulletin Board in the CAE special interest group—do a key word search for "filter"). IC vendor programs are either free or cost as much as \$40. Shareware vendors generally ask a registration fee of around \$30. Software vendors offer software starting above \$500.

The packages listed in Table 1 comprise a subset of all filter-design software that not only calculate a filter's parameters from filter specifications, but also provide a way for you to implement that filter. As a group, these software packages offer easy-to-use tools that span a range of features and prices. It's very easy to pick up any one of these

packages and go to work designing filters.

However, the package that will ultimately make the most of your filter-design time depends on the proposed filter. No design software will make you an expert, and most of the packages require that you know quite a bit about the filter you want to design. What are the required frequency and time-domain characteristics? Does your filter fit with one of the classical filter-response characteristics, such as Butterworth or Chebyshev, or will you need to be able to create a custom function?

All filter-design packages do at least one thing for you—calculate filter coefficients, f_n s, and Q s. Once it completes the calculations, the software can implement a physical filter by choosing real resistor and capacitor values. Some packages are intended for continuous-time filters only, others for switched-capacitor filters only. Of those that can

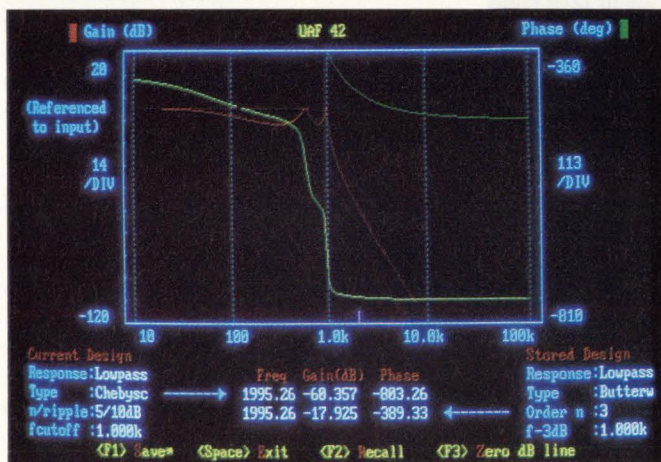

IC vendors' software offers useful help for a bargain. The Filter42 portion of Burr-Brown Corp's Filterpro, which the company provides for free, features on-screen prompts and graphical displays to guide the user through the selection of the filter type and active RC circuit values.

POWER To Configure

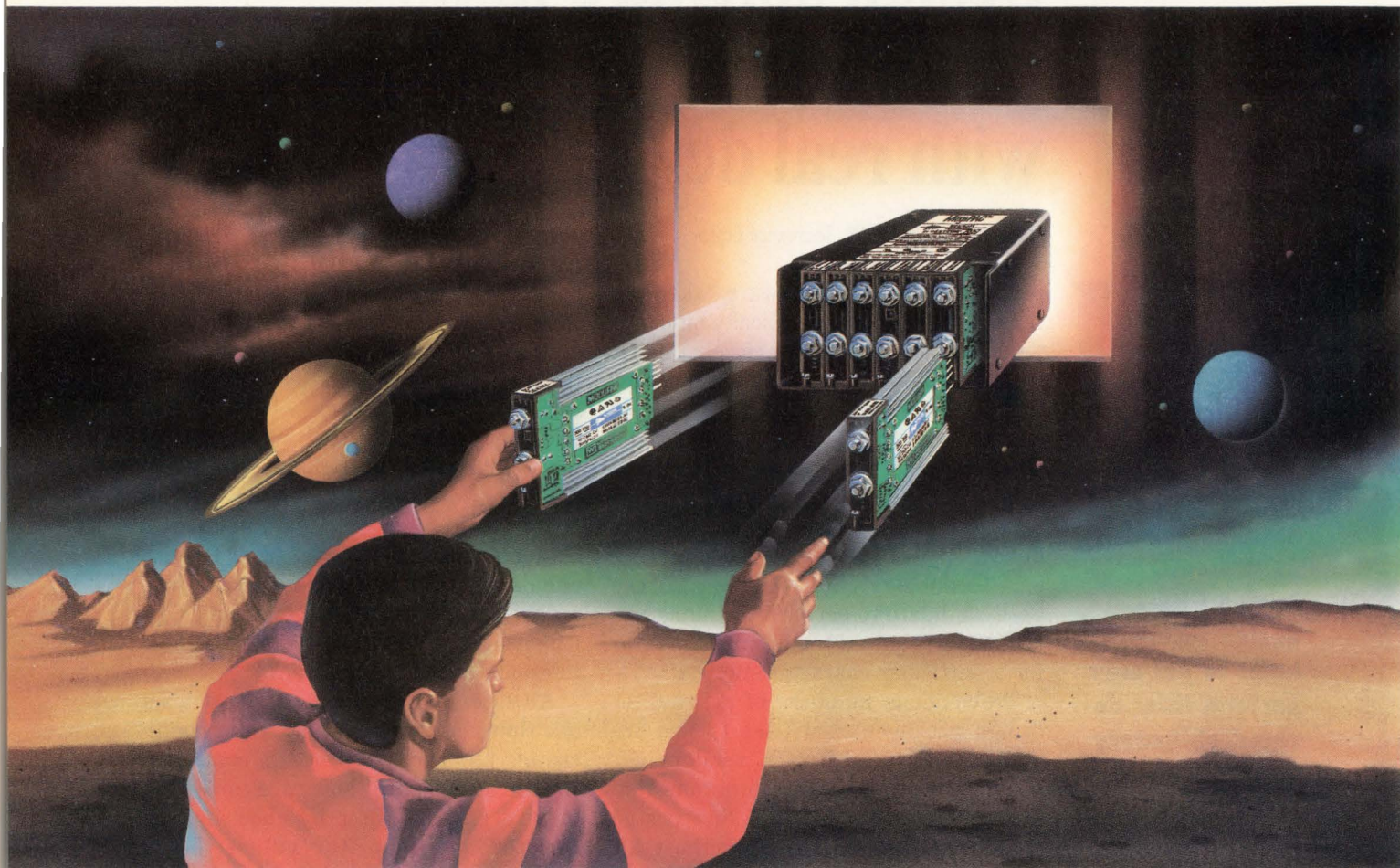

MegaPAC™

Power: Up to 1200 Watts
Input: 110/220 VAC, strappable; 300 VDC
Outputs: 1 to 8 isolated and fully regulated,
2 to 95 VDC
Size: 11.8"L x 6.0"W x 3.4"H



Plug into instant power supply configurability with the new MegaPAC switcher from our Westcor division. MegaPAC outputs can be configured in virtually an infinite number of voltage and power combinations using up to 8 slide-in

ModuPAC™ assemblies. Want to change a voltage or power level at your factory or at a customer site? No problem. . . shut down input power, slide out the ModuPAC you want to replace and slide in the new one. It's that simple.

MegaPAC's instant configurability takes Westcor's popular StakPAC to the next level of customization and flexibility. And its improved manufacturability means a substantial price reduction too! At the heart of each plug-in ModuPAC is a standard Vicor VI-26X series DC-DC converter module. . . over 1 million are operating reliably in systems world-wide. With potential applications around the globe, MegaPAC is designed to meet stringent UL, CSA, and IEC safety standards (approvals in process).

So take the risk out of specifying your system power supply. Contact us today and request ordering information. . . then sit back and relax. . . your custom-tailored MegaPAC will be delivered within four weeks.

Call VICOR EXPRESS (800) 735-6200 for information and be sure to ask for a MegaPAC data sheet. Or call WESTCOR (division of Vicor) at (408) 395-7050. Fax us at (508) 475-6715 or (408) 395-1518.



VICOR Corporation
23 Frontage Road, Andover, MA 01810

Component Solutions For Your Power System

CIRCLE NO. 31

IC FILTER-DESIGN SOFTWARE

select passive component values for continuous-time filters, the software doesn't necessarily support a wide range of the numerous circuit topologies.

The starting point

So, before even using the software, it's a good idea to briefly review the various types of active filters and their pros and cons. Two basic types of active filters exist: continuous time—typically those composed of op amps, resistors, and capacitors known as active RC—and switched-capacitor filters.

As their name suggests, continuous-time filters work from continuous streams of analog data. Switched-capacitor filters use a switched-capacitor network to emulate a resistor, thereby replacing most of the resistors in an active RC filter with switches and capacitors (Ref 2). Since a clock drives the switched-capacitor network,

these filters are a type of sampled-data system.

The biggest differences between active and switched-capacitor filters are size, noise, and ease of use. Switched-capacitor filters generally require much fewer parts than continuous-time types, for which op amps, resistors, and capacitors add up quickly as you increase the number of poles.

However, continuous-time vendors, such as Burr-Brown and Maxim, continue to develop filters with higher integration. Burr-Brown's UAF42 (\$6.95 (100)) contains three op amps that can implement a 2-pole filter. Maxim's MAX275 (\$3.75 (1000)) and MAX274 (\$4.95 (1000)) have built-in op amps and capacitors that, together with external resistors, can create fourth- and eighth-order filters in 20- and 24-pin packages, respectively.

Continuous-time filters have a leg up on switched-capacitor types

when it comes to very low noise requirements. The noise of the current generation of switched-capacitor filters is much lower than earlier devices. However, continuous time filters are still a better choice if signals are in the millivolt range.

Another way of expressing the noise issue is that continuous time filters have a wider dynamic range than switched-capacitor types. If you're looking for 100 dB of dynamic range, you'd be hard pressed to find a switched-capacitor filter to meet this requirement. A typical switched-capacitor filter exhibits noise on the order of 150 μ V of noise, making it impossible to achieve 100 dB of dynamic range. Such a filter could provide 80 dB, however.

Switched-capacitor filters can be easier to use than continuous-time filters because they don't require tuning adjustments to compensate for component tolerances. The

Table 1—Representative IC filter-design software

Vendor	Program	Filter implementation	Filter topology(s)	Filter type(s)	Filter response(s)	Commercial ICs supported	Price	Comments
Burr-Brown Corp	Filterpro (Filter 1, '2)	Active RC	Sallen-Key and multiple feedback	Lowpass	Butterworth, Chebyshev, and Bessel	Suggested op amps	Free	
	Filterpro (Filter 42)	Active RC with URF42 filter IC	Any state-variable filter pole pair.	Lowpass, highpass, bandpass, notch	Butterworth, Inverse Chebyshev, and Bessel	UAF42 only	Free	
International Microelectronic Products Inc	IMP42011 Filter Synthesis Tool Set	Continuous-time, programmable	Integrated biquad cells	Lowpass, allpass	Bessel, Equiripple	IMP42C55	\$995	Includes evaluation-system hardware.
Linear Technology Corp	FilterCAD	Switched capacitor	State variable	Lowpass, highpass, bandpass, notch	Butterworth, Chebyshev, and Elliptic	LIC1059, 1068, 1061, 1064, and 1164	\$40	You can obtain Bessel responses by manually entering pole and zero values.
Maxim Integrated Products	MAX274 Evaluation Kit	Continuous time	State variable	Lowpass, highpass, bandpass, notch, and allpass	Butterworth, Chebyshev, and Bessel	MAX274	\$20	Evaluation kit includes design software, evaluation board, and MAX274 IC.
Microsim Corp	Filter Designer (Standard and Advanced)	Active RC and switched capacitor	Active RC biquads (12 types), switched-capacitor biquads (5 types)	Lowpass, highpass, bandpass, and notch	Butterworth, Chebyshev, Inverse Chebyshev, and Elliptic	IMP's lowpass, programmable, linear-phase, continuous-time filters and Linear Technology's switched-capacitor filters.	\$600 (standard) \$1800 (advanced)	Macintosh versions also available.
National Semiconductor Corp	Switched Capacitor Filter Software Design Tools	Switched capacitor	State variable	Lowpass, highpass, bandpass, and notch	Butterworth, Chebyshev, and Elliptic	MF10, MF5, MFB, LMF100	Free	

IC FILTER-DESIGN SOFTWARE

switched-capacitor filter depends entirely on capacitor value ratios and not on absolute values, thereby removing any need to tune the filter other than setting the switching frequency. Also because a switched-capacitor filter doesn't rely on component tolerance, it can achieve somewhat higher Q values.

A switched-capacitor filter has the added elegant feature that the filter's cutoff frequency scales with the clock frequency. So, by changing the clock, you can modify the filter on the fly.

Switched-capacitor filters have been known to suffer from artifacts such as clock feedthrough and aliasing. Both of these effects have been reduced by IC designer's efforts. Putting a simple RC filter at the output of a switched-capacitor filter is sufficient to remove any clock-feedthrough artifacts and prevent aliasing.

Choose the architecture

These characteristics are all general distinctions between continuous-time and switched-capacitor filters. But within each type there are choices to be made. IC manufacturers generally implement switched-capacitor filters in a state-variable form. However, this general form is but one possible type of active filter architecture (Fig 1). Depending on the arrangement of the resistors and capacitors around the components, numerous combinations are possible (look in any filter textbook for examples).

These numerous combinations exhibit different filter characteristics, such as low or high sensitivity and wide or narrow range of Qs. Biquadratic filters, those whose transfer functions contain complete quadratic equations in both the numerator and denominator, can implement lowpass, highpass, and notch filters. A state-variable filter is one type of a biquad filter. Each filter architecture has its pros and

cons, the discussion of which already fills up volumes. Ref 3 is one place to start to learn more about the specifics of practical filter architectures.

It's all in the application

The next step after deciding on the filter topology is choosing a filter response, such as Butterworth, Chebyshev, Inverse Chebyshev, Bessel, and Elliptic, or choosing some nonclassical filter response. These classic filter responses and their characteristics are very well documented in textbooks and ven-

dors' application literature. Which response is best is purely a system-level decision. Fig 2 gives a very quick overview of the frequency and time-domain responses of the classical filters. A filter that has the desired frequency response can exhibit undesirable time-domain effects, such as excessive ringing.

With the filter topology and desired response in hand, filter-design software programs can not only calculate the filter coefficients, but go through the tedium of choosing passive component values for you

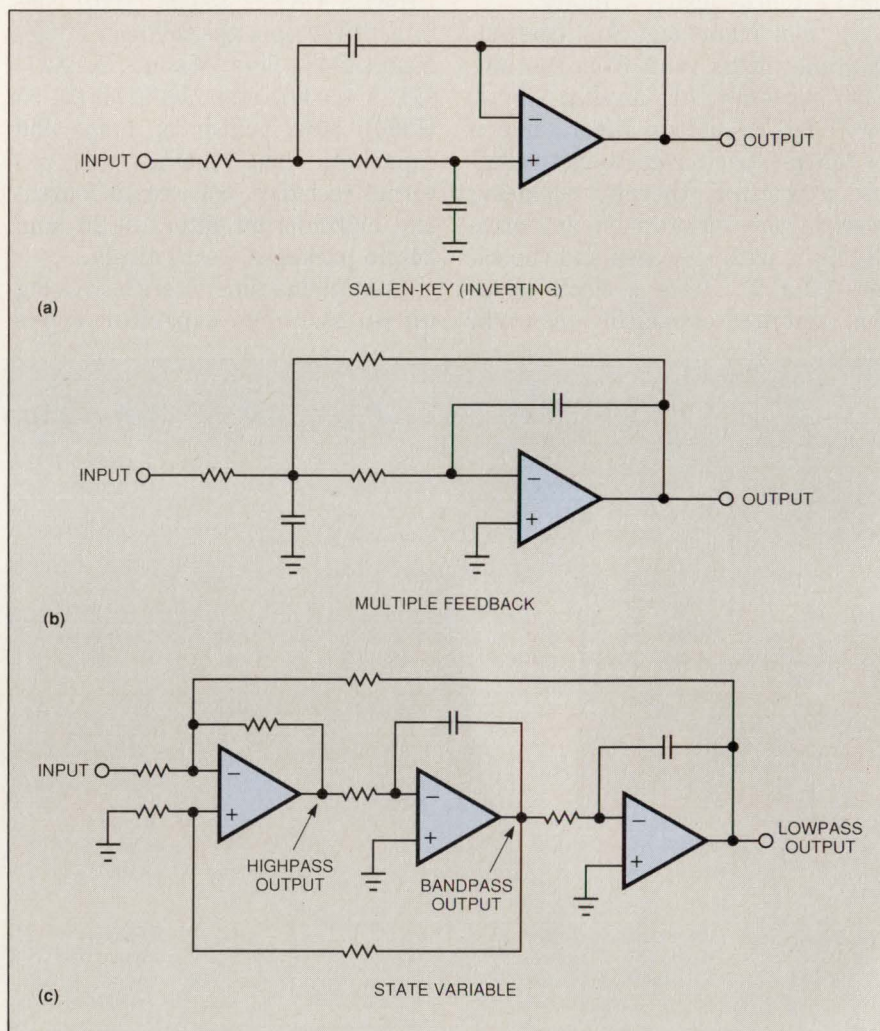
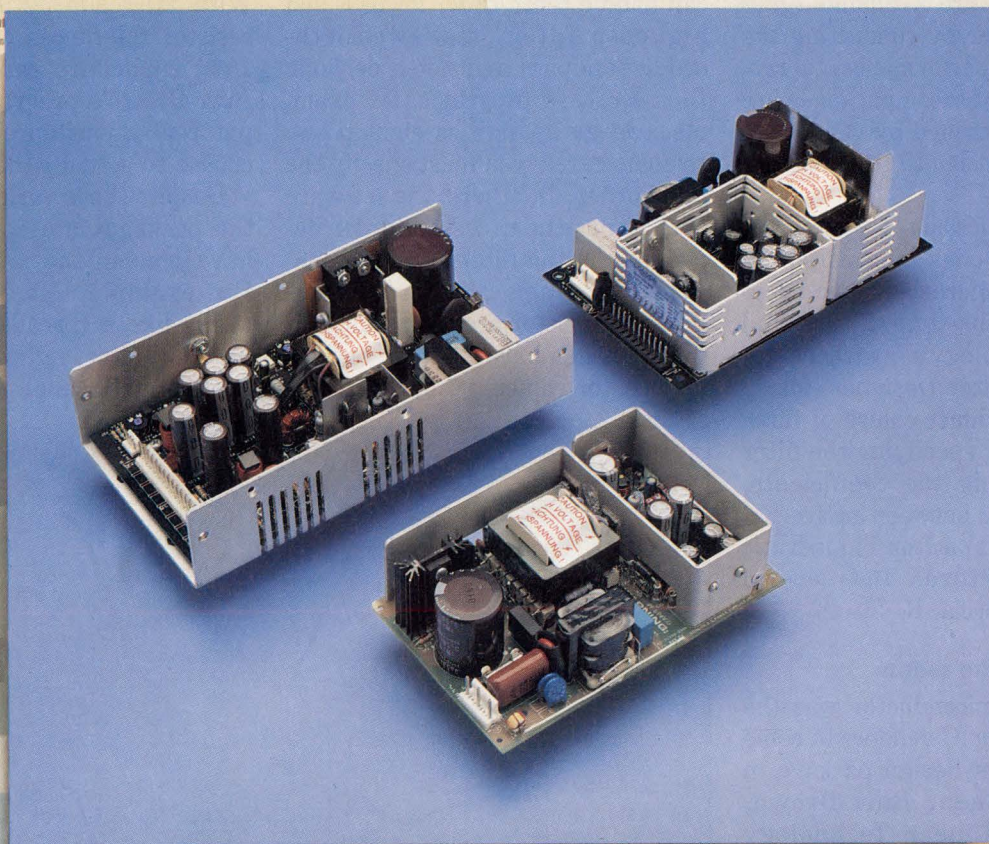

Fig 1—Different filter architectures have inherently different characteristics. For example, the sensitivities of a multiple feedback filter (a) are lower than that of a Sallen-Key (b). Also, unlike Sallen-Key and multiple-feedback filters shown, state variable filters (c) are a type of biquadratic filter, which means they can implement any filter type including lowpass, highpass, and bandpass. (Note that this figure only shows active RC implementations of the filters.)

Our new GP switchers have everyone's approval!



Condor's Global Performance (GP) switching power supplies offer full agency approvals, continuous range input and more!

Our newest switchers have the approvals you need (UL 1950, VDE Level B EMI, IEC 950, CSA and TUV) and the features you want, including:

- 71 models (single- and multi-output)
- Industry-standard packages
- 6 power levels (40 to 200W)
- Continuous input voltage (85-264V)
- OVP on all 5V outputs and single-output units

- Fully regulated outputs
- MTBF 100,000+ hours per Mil Hndbk 217E
- 8-hour burn-in with cycling (24 hours on medical versions)
- Computerized testing (data sheets furnished)
- 2-year warranty
- 30-day FREE evaluation (call us for samples)

If you're looking for world class performance, quick turnaround and competitive pricing, try our new GP switchers — the only approval they're missing is yours!

UL 544/IEC 601 MEDICAL VERSIONS ALSO AVAILABLE

All Global Performance switchers are available in full medical configurations. Call us for details.

CALL FOR OUR FREE CATALOG!

CONDOR

Condor D.C. Power Supplies, Inc.
2311 Statham Parkway
Oxnard, CA 93033 • (805) 486-4565
CALL TOLL FREE:
1-800-235-5929 (outside CA)
FAX: (805) 487-8911

IC FILTER-DESIGN SOFTWARE

as well. The software included in **Table 1**—by no means a compilation of all the software available—goes one step further by connecting the desired filter performance to real devices. Most of these packages are design tools provided by vendors to help make it easier to use their filter ICs.

However, Microsim's Filter Designer also includes information on International Microelectronic Products' continuous-time filters and Linear Technology's switched-capacitor ICs. Filter Designer clearly provides the widest choice of filter topology. After specifying the filter and determining the coefficients, you can choose between active-RC and switched-capacitor biquadratic filter architectures and several popular commercial IC filters.

Don't expect the moon

National Semiconductor was the first of the filter IC vendors to come out with a filter-design package in 1987. Since then, Burr-Brown, Maxim, and Linear Technology have joined in. These packages' interfaces are somewhat more glitzy than National's program, which just asks you a series of filter-specification questions, but ultimately these packages perform the same steps. The software first calculates mathematical filter parameters, and then implements a filter and chooses passive component values using one of their devices.

The abilities of these programs do have limits, however. Note that not all the software listed in **Table 1** can compute values for all filter response characteristics. All of the software packages do Butterworth and Chebyshev, but not necessarily Inverse Chebyshev, Bessel, and Elliptic. And, even though Maxim's software can calculate poles, zeros, and Q_s for highpass and notch filters, the MAX275 can't implement filters that include zeros.

Most of the packages place limits on filter order. National's program can handle tenth-order lowpass and highpass filters and twentieth-order bandpass and notch designs. Burr-Brown's programs, for example, can go as high as eight poles. In some cases, you must specify the filter order. In others, the software determines the necessary order depending on the filter specifications.

The programs also have limitations on resistor accuracy. Many of the packages have just two options for resistor values: 1% or exact. Na-

tional's program for the MF10 allows either 1% or 5% resistors. With Microsim's Filter Designer, resistor tolerances can be 1, 5, or 10%; capacitors can only be 5%. Burr-Brown's programs let you input real capacitance values if you choose to actually measure them.

Despite these various limitations, the packages are easy to use and have convenient user interfaces. For example, Maxim's software works like a spreadsheet, calculating new filter values as you move cursors and change filter specifica-

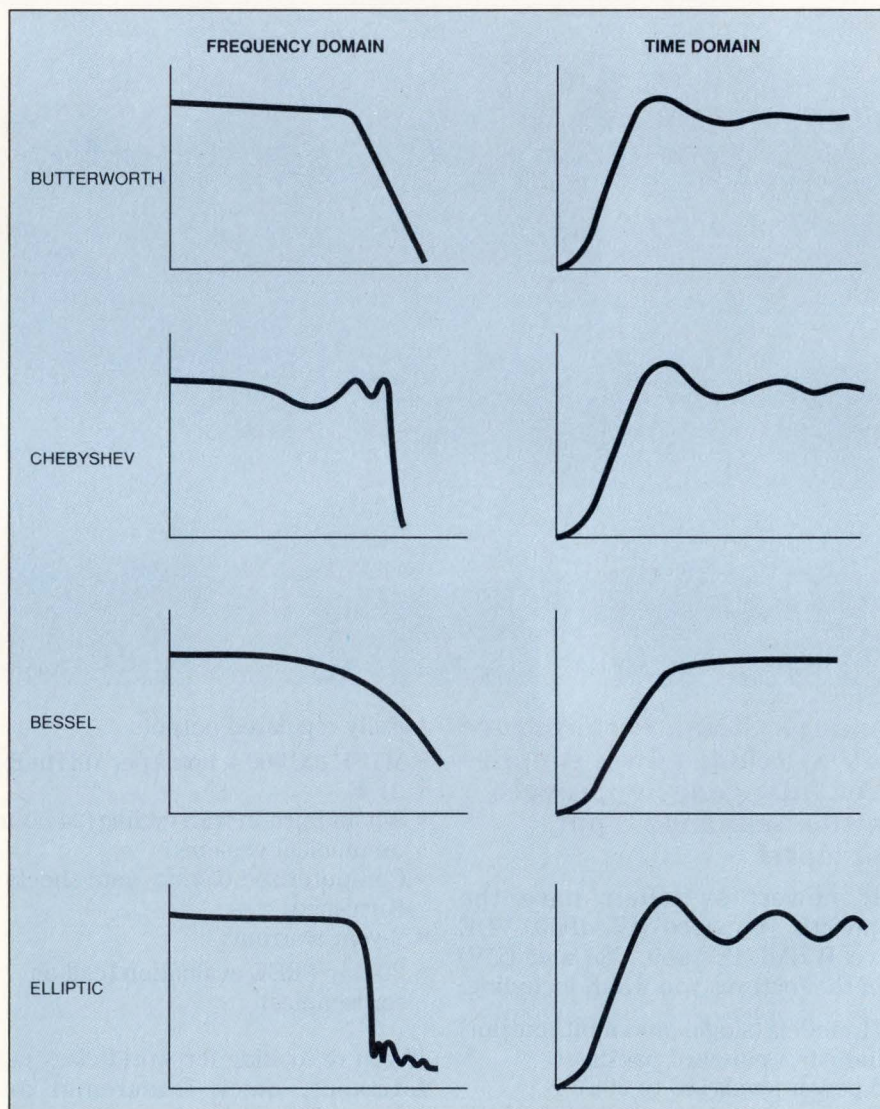
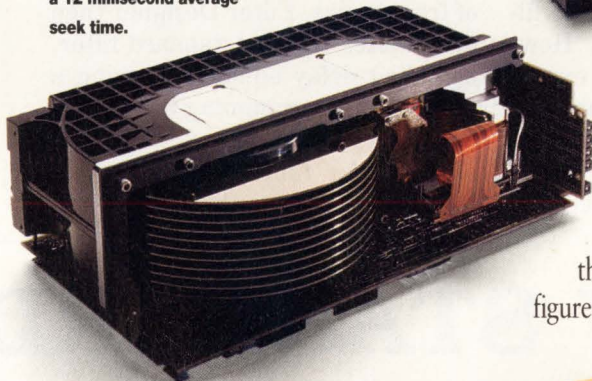

Fig 2—The classic filter-response types have pronounced differences in their frequency and time-domain characteristics.

The first name in disc drives is now the first name in performance, too.

For years, Seagate has set disc drive industry standards for availability, reliability and product range. But you may

This 2 head parallel Sabre-7 (ST83050K) gives you 3 gigabytes of storage in an 8" form factor, with a transfer rate of 9.34 megabytes per second and a 12 millisecond average seek time.



be surprised to learn that we're consistently leading the industry in performance as well.

The drives featured here are available now—setting performance standards in systems like yours all over the world.

The 5.25" Elite 1 offers gigabyte-plus capacity (1352 megabytes) at 5,400 RPM, for an average latency of only 5.56 milliseconds.

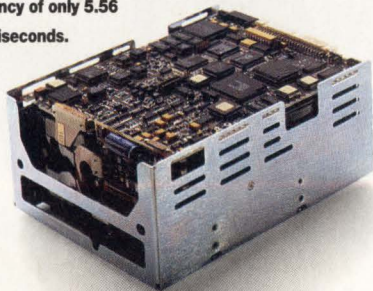

Today, as your competitive environment demands faster, less expensive processing than ever before, you need

At 2.5", the ST9144 offers 127 formatted megabytes with a choice of AT and SCSI-2 interfaces and an average seek time of only 16 milliseconds.



drives like these. Because when you take a few milliseconds' performance advantage and multiply it by thousands of transactions a day... well, the results translate into some figures that might surprise you.

The ST3283 family of 1" high 3.5" drives holds more than 245 formatted megabytes, with a 4,500 RPM spindle which reduces latency to 6.67 milliseconds.

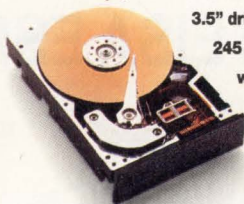

In fact, depending on the amount and nature of processing you do, high-performance drives like these can save you enough to pay back your disc drive investment within weeks — or days. For help in selecting the



The digital servo on this ST3600 family of low-profile 3.5" drives reduces average seek time to 10.5 milliseconds, with capacities up to 525 formatted megabytes.

drive you need, or for more information about any Seagate drive, call Seagate at 408-438-6550 or contact

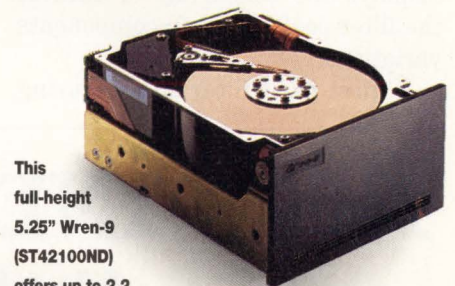

This full-height 5.25" Wren-9 (ST42100ND) offers up to 2.2 gigabytes of storage and a synchronous data transfer rate of up to 20 megabytes per second.

your authorized Seagate distributor.

And get on a first-name basis with performance, Seagate style.



The 3.5", half-height ST11200 family, with up to 1.2 gigabytes of storage, boasts a 256 kilobyte multi-segmented cache buffer and an average seek time of 10.5 milliseconds.

IC FILTER-DESIGN SOFTWARE

tions. Burr-Brown's software screen provides basic but useful tutorial information as you make your filter selections. Calculations are done automatically as you change parameters. The accompanying application notes provide useful information on how to choose op amps based on the designed filter's Qs, center frequencies, and gain settings of each stage. The application notes also instruct users how to account for an op amp's input capacitance.

Many of these packages perform some sort of sensitivity analysis. Burr-Brown's Filter1 and '2 programs display sensitivity of natural frequency and Q to component-value changes in 1% increments. Filter Designer's sensitivity menu displays the sensitivity of each of the filter coefficients to components variations.

A first-pass filter design using

any of these packages takes only minutes. But in many cases, you'll want to optimize your design. Maxim's software and Microsim's Filter Designer both provide for gain optimization of continuous-time filters. They let you reorder stages and adjust gain setting to maximize the filter's dynamic range. Plots of the output of each successive cascaded-filter section can reveal excessive peaking that results in clipping and reduced range. Adjusting stages and gain settings can reduce the unwanted peaking.

Such reordering and gain optimization doesn't change the basic filter coefficients themselves. However, two programs will let expert designers either fine-tune their designs by modifying coefficients or design custom filters from scratch.

Linear Technology's FilterCAD

has a custom feature to help create filters that don't fit any of the classical response types. This custom feature either lets you modify previously designed filters or create filters with custom responses from scratch. By alternately graphing the resulting response and modifying frequency and Q values, you can iteratively arrive at almost any kind of response.

The advanced version of Microsim's Filter Designer also has a non-standard functions menu. You define the nonstandard function by specifying minimum and maximum transfer-function limits at a number of frequencies. Filter Designer then synthesizes this nonstandard filter, including delay equalizers, using a nonlinear programming numerical optimizer. In minutes, you can create transfer functions that might take weeks manually because no

NEW INDUSTRY STANDARD

Met By DTI's EISA ESP2001 & ESP2000A



21 Years Of Manufacturing
Industrial Computer Products

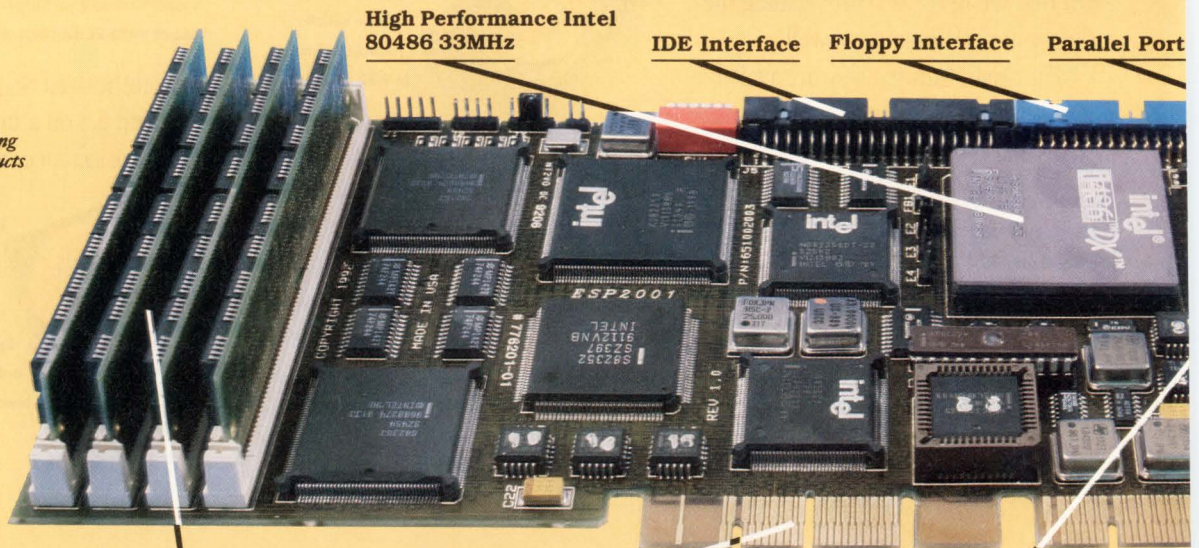

High Performance Intel
80486 33MHz

IDE Interface Floppy Interface Parallel Port

Up to 32Mb of
DRAM Onboard

Industry Standard
PCXI P3/P4 Compatible
Extension Connector

Optional Intel Turbo Cache
(64Kb or 128Kb)

Call us toll free for orders and information.

1-800-443-2667

U.S.A. - (601) 856-4121 Fax (601) 856-2888
Outside U.S.A. - (201) 891-8718/Fax (201) 891-9629

systematic derivation theory exists.

The numerical optimizer sets Filter Designer apart from the IC vendors' software packages. Also, the IC vendors' packages are less com-

prehensive—they include fewer topologies and options. So, if you have a variety of filter-design requirements, spending the money on a comprehensive filter-design pack-

age may be well worth it. If you just need a good tool for designing specific classical active filters—either continuous-time or switched-capacitor—the IC vendors' packages are a tremendous bargain. **EDN**

For more information . . .

For more information on the filter-design software discussed in this article, circle the appropriate numbers on the Information Retrieval Service card or use EDN's Express Request service. When you contact any of the following manufacturers directly, please let them know you read about their products in EDN.

Burr-Brown Corp

Box 11400
Tucson, AZ 85734
(602) 746-1111
FAX (602) 889-1510
Circle No. 700

International Microelectronic Products Inc

2830 N First St
San Jose, CA 95134
(408) 432-9100
FAX (408) 434-0335
Circle No. 701

Linear Technology Corp

1630 McCarthy Blvd
Milpitas, CA 95035
(800) 637-5545
FAX (408) 434-0507
Circle No. 702

Maxim Integrated Products

120 San Gabriel Dr
Sunnyvale, CA 94086
(408) 737-7600
FAX (408) 737-7194
Circle No. 703

Microsim Corp

20 Fairbanks
Irvine, CA 92718
(800) 245-3022
FAX (714) 455-0554
Circle No. 704

National Semiconductor Corp

2900 Semiconductor Dr
Santa Clara, CA 95052
(408) 721-2273
FAX (408) 733-5724
Circle No. 705

References

1. Strassberg, Dan, "Filter-design software: Publishers provide possibilities aplenty," *EDN*, November 8, 1990, pg 107.
2. Quinnell, Richard A, "Switched-capacitor filter ICs," *EDN*, January 4, 1990, pg 86.
3. Williams, Arthur B, *Electronic Filter Design Handbook*, McGraw Hill, New York, NY, 1981.

Article Interest Quotient
(Circle One)

High 470 Medium 471 Low 472

EISA PASSIVE BACKPLANE Single Board Computers

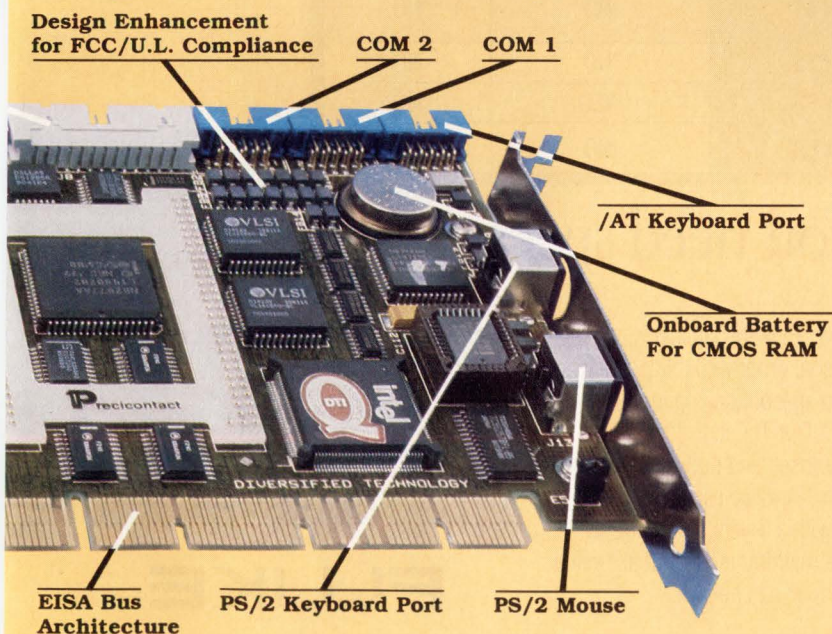

FUNCTION	DTI ESP2001 '486'	DTI ESP2000A '486'
33 MHz - Shipping Now	✓	✓
32Kb EISA CMOS RAM	✓	✓
Up to 64Mb DRAM Onboard		✓
Up to 32Mb DRAM Onboard	✓	
2 Serial Ports w/FIFOs	✓	
1 Parallel Port	✓	
IDE/Floppy Interface	✓	
Noise Reduction Circuitry For FCC Class B	✓	✓
PS/2 Mouse Support	✓	✓
/AT-PS/2 Keyboard Support	✓	✓
Optional Intel Turbo Cache	✓	✓
Onboard Battery for Real-Time Clock	✓	✓
Double-Sided Surface Mount Technology	✓	✓
Manufactured In-House(USA)	✓	✓
PCXI P3/P4 Compatible Extension Connector	✓	✓
Landmark V1.14 Speed at 33MHz	143.7	143.7

Diversified Technology
An Ergon Co.

CIRCLE NO. 33

FLUKE®



PHILIPS

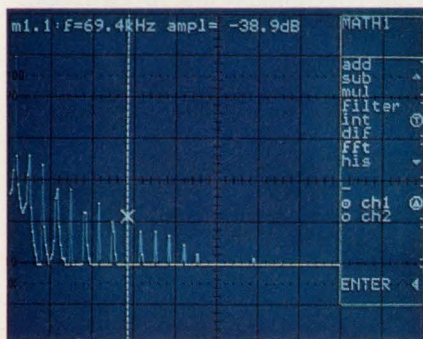

Powerful DSP signal analysis, including almost real-time FFT

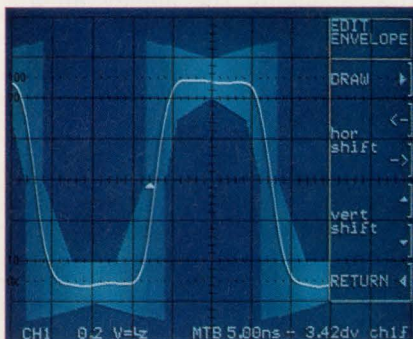

Automatic go/no-go decisions with template and limit tests

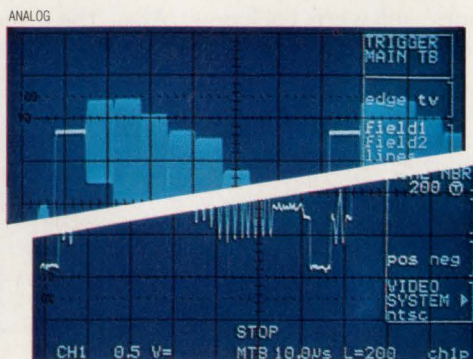

Push a button to better view complex signals in the analog mode

If you can't instantly see why our digital/analog DSOs are better than HP® or Tek...

	Fluke PM 3394	Tek® TDS Series	HP® 545xx
Analog/Digital Combination	YES	NO	NO
Limit Test	YES	YES	YES
Template Test	YES	NO	NO
Analysis Functions Int., Diff., Hist., Filter, FFT	YES	NO	NO
FFT	YES	NO	NO
4 Channels	YES	YES	NO
Analog Display	YES	NO	NO

maybe you need specs.

Believing is seeing. Philips DSOs from Fluke give you the sophisticated measurement and analysis features of an advanced digital scope costing up to five



times as much. Plus the familiarity of analog, for visual proof with infinite display resolution and speed. Looking for an easy-to-use scope? Our Touch Hold and Measure™, Autoset, and pull-down menus define the term. And we back our combination DSOs with a 5-year CRT warranty (3-year on the mainframe). Now that's value you just have to see to believe.

For literature or a demonstration, call **1-800-44-FLUKE.**

John Fluke Mfg. Co., Inc., P.O. Box 9090, M/S 250C, Everett, WA 98206-9090. U.S. (206) 356-5400. Canada (416) 890-7600. Other countries: (206) 356-5500. ©1992. All rights reserved. Tek® and HP® are registered trademarks of Tektronix, Inc., and Hewlett-Packard, Inc. Ad No. 00180.

FAST ANSWERS

FLUKE®

SOME SEE OUR INTEGRATED PROCESSOR AS THE FUTURE OF FULL MOTION VIDEO.

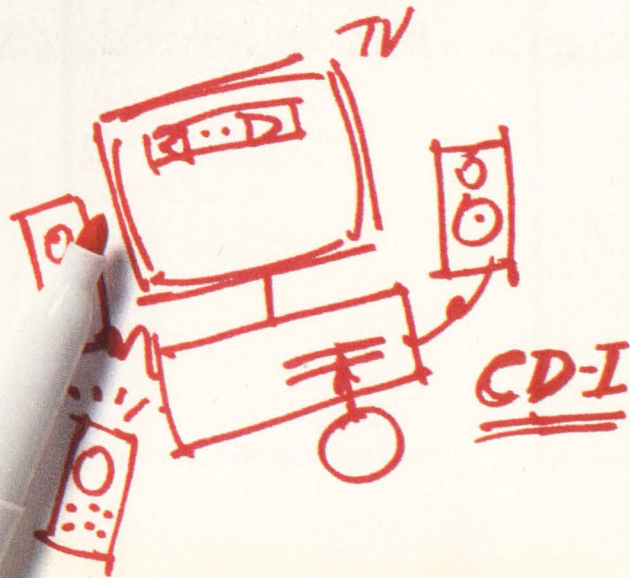

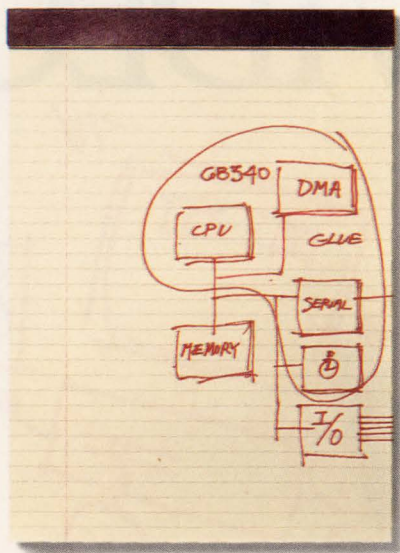
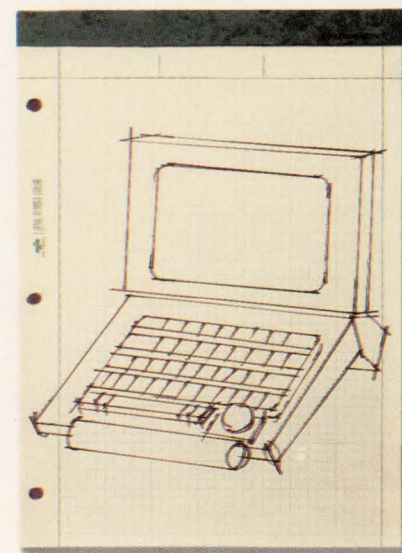
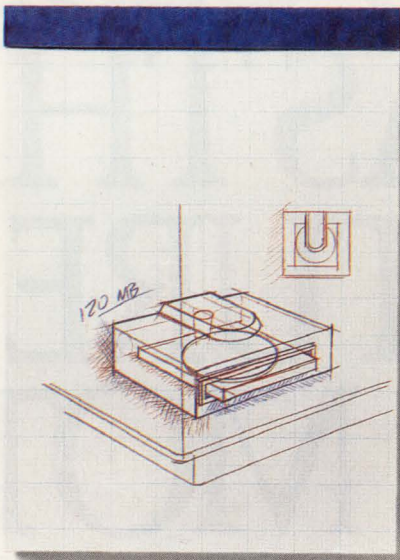
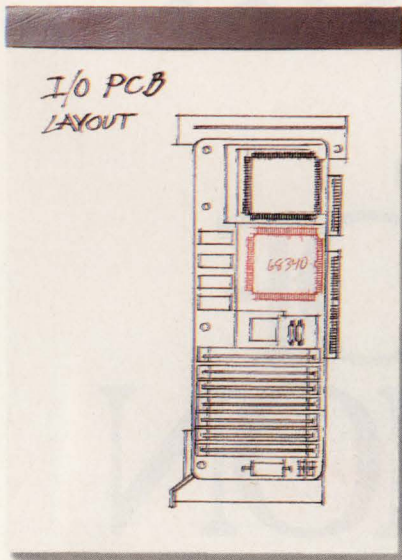
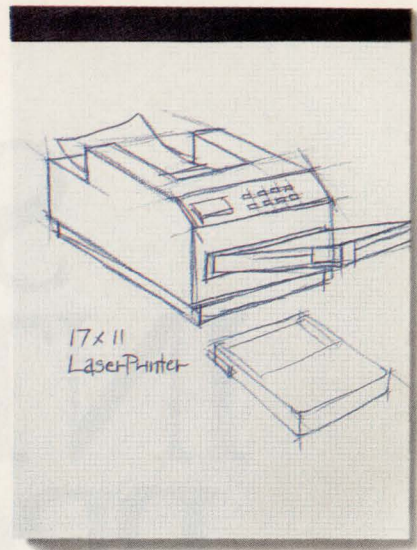
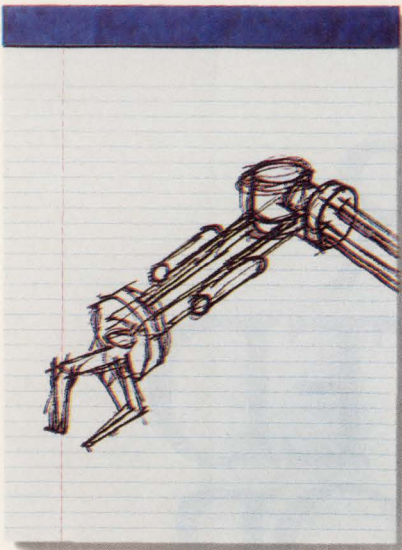

BUT YOU MAY SEE IT DIFFERENTLY.



Look at it this way.

The first thing you'll see is a flat-out screaming data mover. Namely, Motorola's 68340

Integrated Processor with DMA. The first and only processor with the performance to meet the high speed data handling needs of next generation applications.

Applications like future Compact Disc-Interactive multimedia machines. Or applications like yours. Say, for instance, optical drives, laser printers, hand-held computers, telecommunication switches and line cards, workstation I/O processors, servers, terminals, robotics or that hot new project only you know about.

A closer look at the 68340 will reveal a 32-bit integrated processor built on a 68020 foundation with a host of pertinent peripherals on-chip. Foremost among these is a two channel DMA (direct memory access) controller that delivers a sustained data transfer rate of

33 megabytes per second. Imagine for a moment what you could do with that.

Also on the chip are a pair of serial I/O channels, a couple of timers and a whole bunch of glue logic you won't have to add elsewhere. And, of course, you get all that power in one tidy little package.

Speaking of power, the 68340 doesn't use much at all. In fact, its low power consumption and standby mode make it perfect for a wide variety of battery-powered applications.

But then again, as the highest performance data mover you'll see anywhere, the 68340 is perfect for a whole lot of applications.

Including yours. So call Motorola at 1-800-845-MOTO for a free sample.* Or contact your Motorola Semiconductor Sales Office.

You'll like what you see.

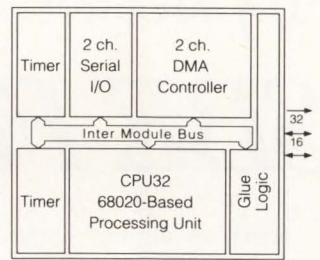

68340 Integrated Processor with DMA



MOTOROLA

*Limited quantities available. All brand and product names appearing in this ad are registered trademarks or trademarks of their respective holders. © 1992 Motorola, Inc.



*No Matter
What the
Application,
SBE Fits.*

Matching your high-speed data communications requirements with a quality supplier has never been easier. Whether you're a manufacturer of mini/superminicomputers, workstations or high-performance data communications products, *only* SBE provides a perfect fit.

Only SBE offers a complete line of intelligent high-performance communications controllers for all major interface technologies: FDDI, Token Ring, Ethernet and High Speed Serial. Only SBE adds premium features, without a premium cost, for the best price/performance in the industry.

Add integrated hardware/software solutions; availability in VMEbus, Multibus and SBUS; plus legendary development assistance and continuing product support.

Discover how SBE's intelligent high-performance controllers can meet your LAN and WAN interface requirements. Turn to SBE today.

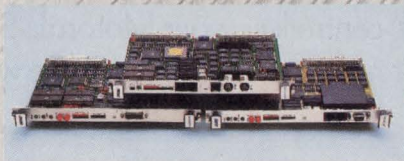

For fast action, call: 1-800-347-COMM

Germany: 0130-810588

United Kingdom: 0800-378-234

SBE, Inc., 2400 Bisso Lane, Concord, CA 94520

CIRCLE NO. 36

SBE
Communications &
Real-time Solutions

CONTENT-ADDRESSABLE MEMORIES

FDDI routers and bridges create niche for memories

JOHN GALLANT, Technical Editor

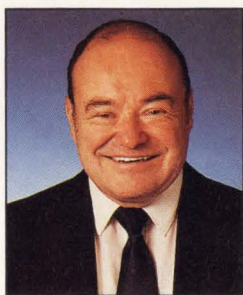

Content-addressable memories (CAMs) quickly compare input data to stored data. FDDI's 100-Mbps speed has created a commercial demand for these memories, whose steep prices had confined them to supercomputers and research projects.

The Von Neumann computer architecture has conditioned most of us to envision a memory device as a collection of data you index via an address. This presumption is natural because most of today's computers access all instruction sequences, constants, and data in exactly this manner. However, high-speed data comparison—such as the address filtering an FDDI bridge or router does—requires a memory device that indicates its contents based on a data set rather than an address. A content-addressable memory (CAM) is best suited for this task.

In fact, almost from the creation of digital computers, designers have needed a device that could quickly determine whether a particular data value matches a stored data value. If a match occurs, the logic needs to know the address where the data is stored and the value of any conditional-branch pointers stored with the data. If the database is large, finding the data using search-and-sort software routines can be like looking for a needle in a haystack.

The generic CAM architecture has a comparator for each array location. When an input data word matches a stored data word, "Bingo," the comparator issues a hit command and reports all the data stored at that location and its address. If multiple matches occur, a priority encoder establishes the output data sequence.

Because they have multi-

ple comparators, CAMs are inherently expensive devices. Thus far, defining a CAM architecture that would suit a range of applications has not produced cost-competitive products. So designers have often compromised speed for cost by instead using a static or dynamic RAM along with search logic and a single comparator for data comparison. In fact, the most cost-effective way to do data comparison is to sort the data in software using hashing algorithms.

In LANs, bridges and routers, which connect multiple networks via the data-link and network layers of the OSI model, must quickly filter many destination addresses before forwarding a

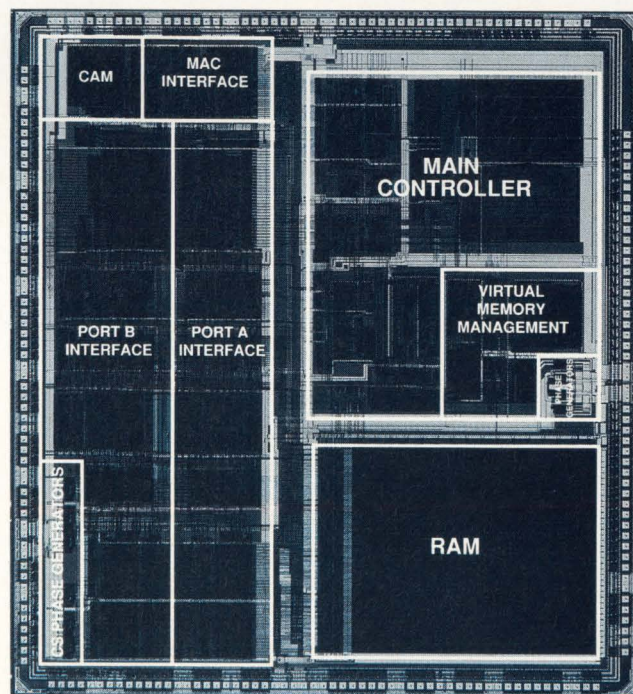

Because LAN address-filtering applications currently provide the widest market opportunity, it seems natural to incorporate a CAM into a LAN chip set. The MC68839 chip in Motorola's FDDI 4-chip set includes a 32 × 48-bit CAM array.

CONTENT-ADDRESSABLE MEMORIES

matched address to another attached network. CPU speeds have been fast enough to do this address filtering via hashing algorithms at 10-Mbps Ethernet and 16-Mbps Token Ring speeds. But FDDI (Fiber Distributed Data Interface) networks chug along at 100 Mbps, and only CAMs can handle address filtering at that speed.

An FDDI bridge must identify a

message's destination or source address in a fraction of the message time interval. The destination or source address field in the FDDI message format is a minimum of 2 bytes (16 bits) or a maximum of 6 bytes (48 bits). A minimum of 4 bytes must be in the message's data field. For a message of minimum length, a bridge must identify a message's source address in less

than 800 nsec before receiving another message (Fig 1). Commercially available CAMs can identify addresses in less than 200 nsec.

Other applications that could benefit from the speed of CAMs include parallel computing architectures, which compare computational results with destination information to determine the data flow to other processing elements. An-

Fully associative memory uses off-the-shelf parts

Designers have searched long and hard for an economical content-addressable or fully associative memory device that would quickly determine whether a piece of data resides in main memory. So far, the high cost associated with such memory devices has limited their use to supercomputers; most other computers employ lower-cost set-associative memory products. Now, a patent-pending fully associative memory that uses off-the-shelf components may make these memories affordable enough for the masses. The device is called the data-addressable memory (DAM).

The DAM employs three standard RAMs for each set of data (Fig A). While the DAM is storing data, a log (for log book) RAM stores the data in the standard fashion by using sequential input addresses to point to successive data locations. In parallel with the log RAM, a twist RAM reverses the roles of the input address and data words. In the data-addressable twist RAM, the

input data stores the log RAM's address word. When identical data occur at different addresses in the storing sequence, the second address overwrites the previous address in the twist RAM.

To recover overwritten addresses, a linked-list RAM stores the sequence of previous addresses stored in the twist RAM. Before identical data stores a new address word into the twist RAM, the DAM stores the previous twist-RAM address into a linked-list RAM. The new address in the twist RAM points to the location in the linked-list RAM where the previous address is stored. Because the DAM uses addresses to find data in the log RAM and addresses in the linked-list RAM, the words in both these RAMs can never be overwritten. Although the linked-list RAM may contain many identical address sequences, all of the sequences have unique locations.

To read the data, the DAM circuitry employs an

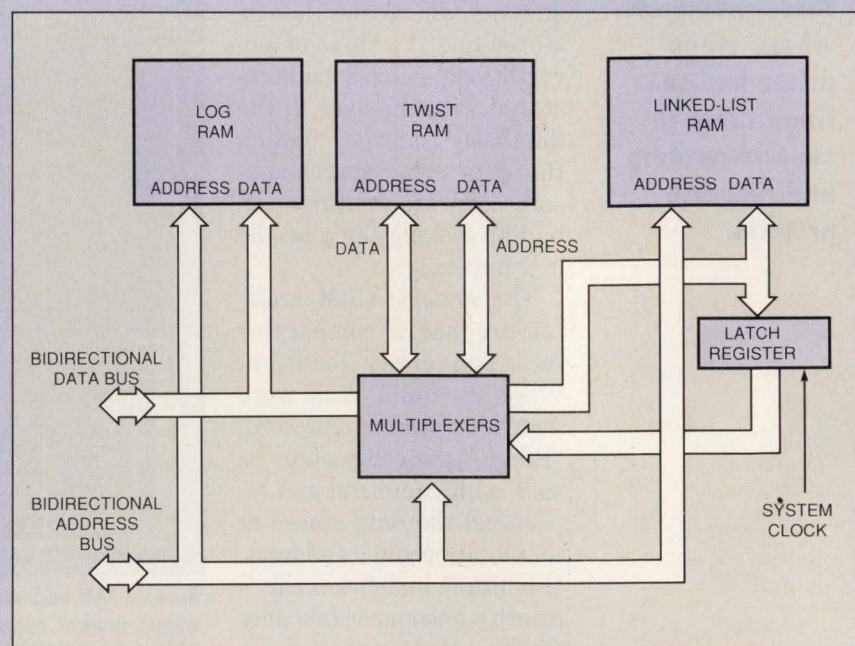

Fig A—The patent-pending DAM employs three standard RAMs—a log RAM, twist RAM, and linked-list RAM. A register reads out the stored address sequence in the linked-list RAM in reverse order. You can increase the DAM array by adding groups of three RAMs.

other application is voice and pattern recognition in which an algorithm compares input data to stored templates in an array.

Speeding up the search for data in a relational database or a fully associative cache is another application that could benefit from CAMs. In fact, translation look-aside buffers (TLBs) are actually special-purpose CAMs for virtual memory

systems. In virtual memory systems, a TLB quickly checks a virtual address issued by a CPU against addresses in a look-up table to see whether a physical address resides in local RAM.

Commercially available CAMs are still few and far between. Most vendors of specialty memories have found the volume demand for CAMs to be so low that it isn't worth the

investment cost, according to Micron Technologies' (Boise, ID) Gene Cloud, vice president of semiconductor marketing. Currently, the only commercial application that has started actively using CAMs is bridges in FDDI LANs. As these high-speed LANs proliferate, they could fuel the demand for CAMs in other applications and possibly drive down prices.

external register that latches the output address words from the linked-list RAM using the system clock. To query the DAM, you direct a specific data word to the twist RAM to see if a stored address matches. If the twist RAM doesn't contain an address word for the specified data, a 0 address word appears on the address bus via the multiplexer. A 0 address on the address bus indicates a miss. If the twist RAM does contain an address word, the address on the address bus points to a location in the log RAM where the data resides and to a location in the linked-list RAM to see if that RAM has a previous address for the data.

If the linked-list RAM doesn't contain a previous address, the next system clock latches a 0 address word from the linked-list RAM into the external register. A latched 0 address word indicates that the log RAM contains no additional copies of the data. If the linked-list RAM does contain a previous address, the next system clock latches the stored address from the linked-list RAM into the register.

The control circuitry multiplexes the stored address onto the address bus, which points to the location in the log RAM where duplicate data resides and also to the location in the linked-list RAM where the next previous address in the sequence resides. Each succeeding clock latches the address word from the linked-list RAM into the register until a 0 address word appears. The 0 address word indicates that all previous locations have been identified.

In the conceptual block diagram in **Fig A**, the DAM reads the sequence of data in reverse order from which the data were stored in the log RAM. In a variation of the DAM, the device reads data in order. You can stack multiple log, twist, and linked-list RAMs in parallel to address multiple sets of data. The bidirectional data and address buses connect to the RAMs for all the other data sets to retrieve associated data from their respective log RAMs. Reading the contents at specific data values in one or more sets will identify all associ-

ated data in the other DAM sets. For example, consider that the DAM contains the following data for three parallel sets P, Q, and R:

Address	Set		
	P	Q	R
1	7	2	1
2	5	3	5
3	8	2	9
4	9	7	4
5	5	2	4
6	2	3	3
7	3	2	7
8	2	7	5

A query for identifying all data values in the other sets that belong to a value of 3 in set P, 2 in set Q, or 5 in set R produces the following output sequences:

Sequence of data belonging to P=3:

Address	Set		
	P	Q	R
7	3	2	7
	0	0	0

Sequence of data belonging to Q=2:

Address	Set		
	P	Q	R
7	3	2	7
5	5	2	4
3	8	2	8
1	7	2	1
	0	0	0

Sequence of data belonging to R=5:

Address	Set		
	P	Q	R
8	2	7	5
2	5	3	5
	0	0	0

For further information contact Larry Dillard, Box 18238, Boulder, CO 80308. Phone (303) 494-8244.

CONTENT-ADDRESSABLE MEMORIES

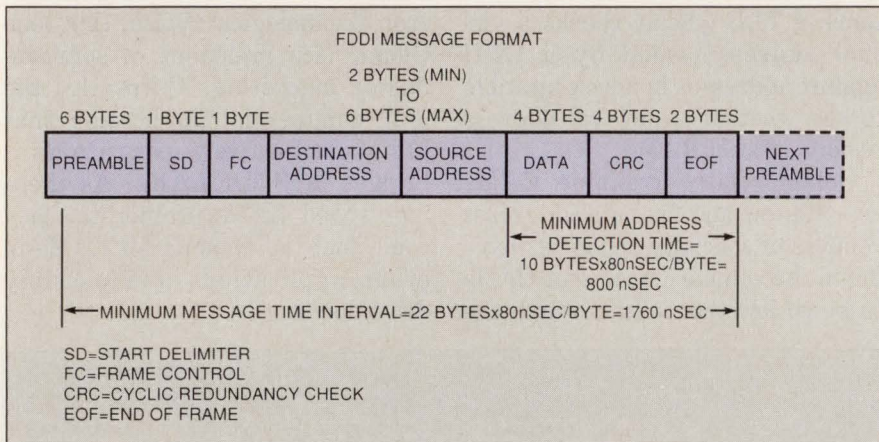

Fig 1—The CAM is the only practical device for filtering destination or source addresses in the FDDI message format. The worst-case minimum address-detection time is 800 nsec. CAMs can do the job in 200 nsec or less.

Testing the waters of the LAN bridge market, Advanced Micro Devices (AMD) introduced the first commercially available, single-chip CAM in late 1988—the 12-kbit CMOS Am99C10. The two chip versions have 100- and 70-nsec read/write cycle times, and each costs \$21 (100). The chip suits LAN bridges and routers that filter addresses as fast as 200 Mbps. The chip's architecture also suits it for LAN group addressing. In group addressing, a sender transmits a message to every member of a group that belongs to associative sets of data in a look-up table.

The Am99C10 CAM holds 256 words, each consisting of a 48-bit register and a 48-bit comparator (Fig 2). You transfer data to and from the CAM via a 16-bit bidirectional bus. An internal 2-bit segment counter loads 48-bit data into an internal comparand register 16 bits at a time.

After the counter loads the 48-bit data into the comparand register, all comparators simultaneously check the comparand data with their associated storage-register data within one clock cycle. If a match occurs, the CAM activates an external $\overline{\text{MTCH}}$ signal, and a priority encoder generates an 8-bit match-word address. This address

appears in a 16-bit status register to identify the location of the data in the CAM.

If multiple matches occur, the CAM activates a bit in the status register, and the priority-encoder generates the lowest match-word

address. A mask register lets you selectively mask any of the bits in the comparand register before data comparison. You can also selectively mask the bits in the storage registers before data comparison.

Each of the 256 words in the CAM has two associated data bits: a skip bit and an empty bit. The actual width of the array locations is therefore 50 bits (48+2). Both the skip and empty bits can keep their words from being compared with the input data. The skip bit lets you detect words other than the highest-priority word. The empty bit indicates an empty slot in the array.

You can program the Am99C10 to read and write to any of its storage registers. Each CAM register can contain data or be empty so that the register doesn't participate in a comparison. You can set all of the array contents to empty in a single

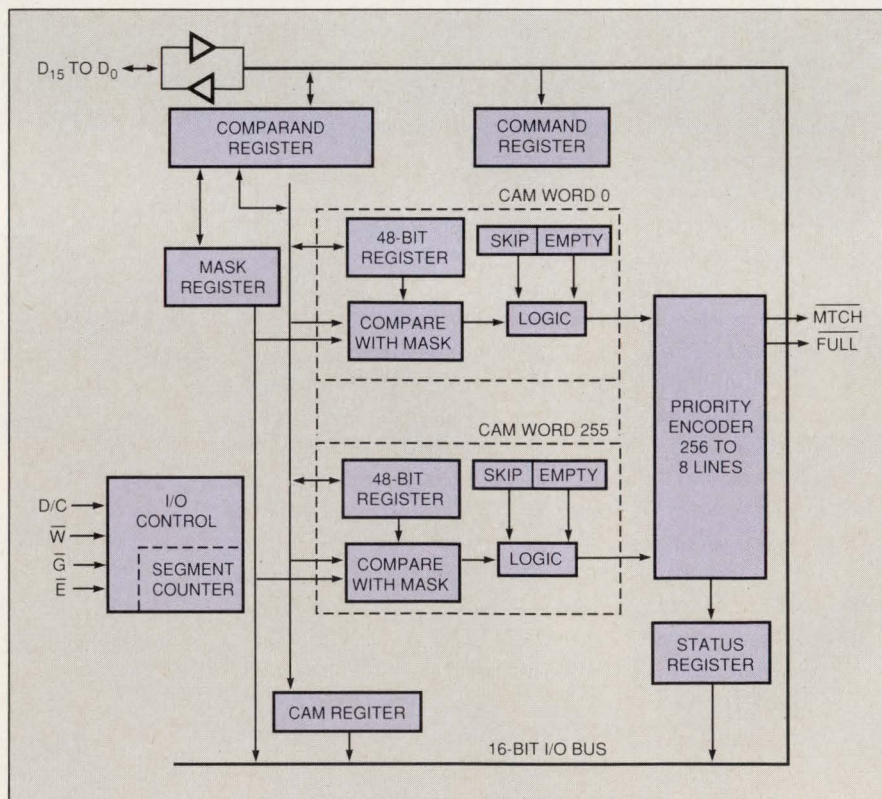

Fig 2—The first commercially available CAM was Advanced Micro Devices' Am99C10. The chip simultaneously matches input data to stored data in a 256 x 48-bit array using separate comparators for each stored word.

All the μ C Peripherals you need.



In one chip.

PSDTM3XX: A family of field-programmable peripherals with logic and memory. For embedded-control designs.

WSI's PSD3XX single-chip μ C peripherals pack all the programmable logic, SRAM, and EPROM needed for your embedded-control design. Plus advanced features like paging, cascading, address/data tracking — and more. PSD3XX devices configure in just minutes to interface with any 8- or 16-bit microcontroller. And they're available with 256Kb, 512Kb, or 1Mb of program store to suit every embedded-control design.

In use the world over, PSD3XX μ C peripherals are the ideal solution wherever higher-level integration is required: from industrial controllers to cellular phones — and thousands of other applications.

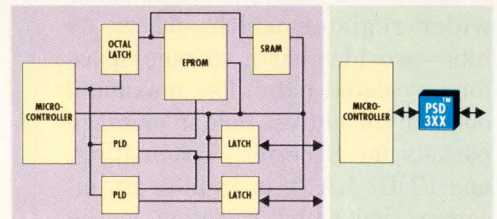

Before PSDTM3XX

After PSDTM3XX

For a *free* design kit, call today:



47280 Kato Road
Fremont, California 94538

800/877-6220

In Canada, call Intelatech, Inc.: 416/629-0082

CONTENT-ADDRESSABLE MEMORIES

clock cycle. The CAM activates an external FULL signal when all locations in the array are full.

You can expand the capacity of a CAM array by connecting multiple Am99C10A chips in parallel. The largest possible CAM array is 64k x 48 bits and consists of 256 chips. To extend the capacity of the CAM array you also need external PALs to decode the MTCH and FULL signals from the multiple Am99C10A chips.

The newcomer on the block

The only other commercially available, single-chip CAM is the MU9C1480 from Music Semiconductors. (The part sells for \$65 in a 28-pin DIP and \$60 (1000) in a 44-pin plastic leaded chip carrier.) After recognizing some limitations to the Am99C10, the company introduced the MU9C1480 in June 1991. The chip essentially is an enhanced version of the Am99C10 architecture and is also aimed at address-filtering applications in LAN bridges and routers. GEC Plessey Semiconductors is a second source for the part.

The MU9C1480's array is 1k x 64 bits, which is four times the density of the Am99C10A. The MU9C1480's wider register width—64 vs 48 bits—provides extra storage space for associated data. The maximum destination address field in message packets for Ethernet, Token Ring, and FDDI LANs is 48 bits. By incorporating 64-bit registers in the array, the MU9C1480 can append 16 bits of associated data to each stored address.

The 16-bit associated-data field can store bits for algorithms that purge node addresses that have not been active within a certain elapsed time interval. The field also lets you append a port address to the node address. And you can perform data comparisons on masked bits in the field.

The MU9C1480 comes in versions

having 120- and 150-nsec read/write cycle times. You transfer data to and from the chip via a 16-bit bidirectional bus. An on-chip 1-to-4-line multiplexer directs the data to an internal 64-bit bus, which feeds the comparand register and the CAM array. The chip has dual 64-bit mask registers, which let you mask bits for both data writes and compares. When multiple matches occur, a priority encoder generates the highest priority 10-bit address. The address appears in a 16-bit status register.

The MU9C1480 has several features that simplify address filtering. These features include programmable translation between Ethernet and Token Ring address formats; an associative writing mode that expedites the storing of data by automatically writing to the next free address; and an up-down address counter that speeds memory writes

and reads using DMA. The chip can also partition the 64-bit words into 16-bit sections, which the chip can allocate as CAM or RAM.

Perhaps the most attractive feature of the MU9C1480 is the straightforward way you can connect multiple chips in parallel to expand a CAM array. The chip doesn't require extensive external logic to decode the match and full lines, as AMD's Am99C10 does. Instead, the MU9C1480 has two input lines, a match input and a full input, that connect to the match-output and full-output signals of its parallel neighbor. This arrangement lets you cascade an unlimited number of MU9C1480s in a daisy-chain manner that is similar to chip expansion for FIFO memories.

The most widespread use of commercial CAM devices is for filtering addresses in high-speed LANs, so some LAN-interface-chip vendors

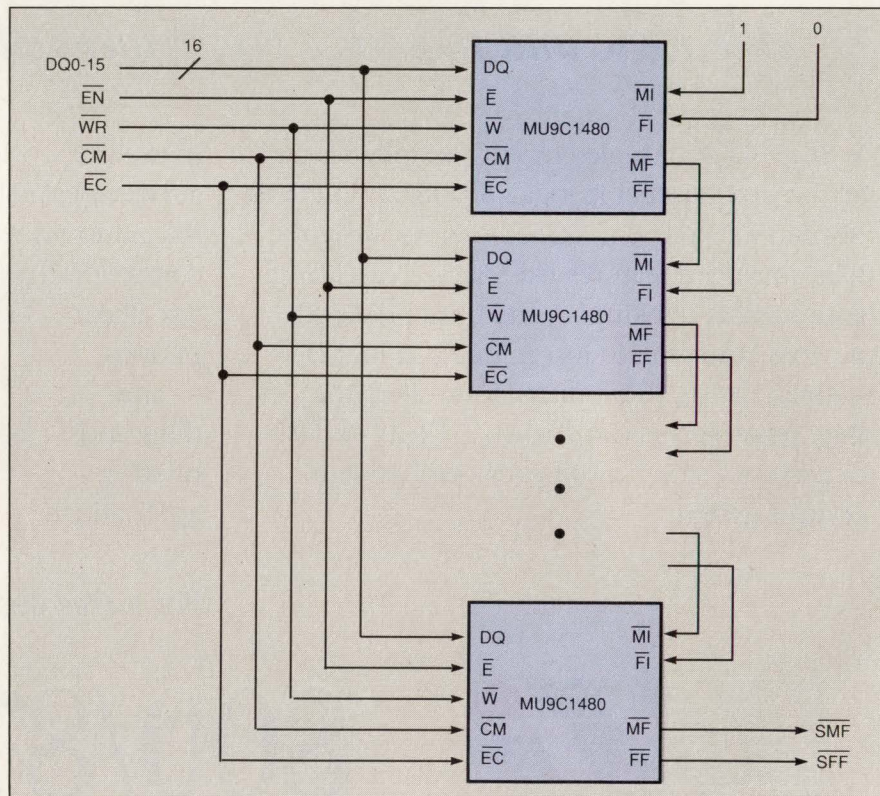

You can cascade an unlimited number of Music Semiconductor's MU9C1480 chips to expand a CAM array. The chip contains a match-input and a match-full line that directly connect to the match-output and full-output lines of its neighbor.

Finally, engineering software that clears the way to problem solving without programming.

```

void serviceid)
int eid;
{ int stat, byte;
/*serial pollinst
byte=hpib_spoll(
if ( (byte<0) !
printf("SRQ Problem
return; }
stat=my_read(eid, DVM_
if (stat>0) {
buffy[stat] = '\0';
printf("Data from instrument:
else printf("I/O read error\n");
return; )
main()
int busid, stat, MTA, MLA;
char command[MAXCHARS];

busid=open("/dev/hpib7", O_RDWR); /* open raw HP-IB
MTA=hpib_bus_status(busid, CURRENT_BUS_ADDRESS) + 64;
MLA=hpib_bus_status(busid, CURRENT_BUS_ADDRESS) + 32;
stat = BUTTON_BIT ;
sprintf(command, "KM%02o", stat); /* 2 octal digits; no
  
```

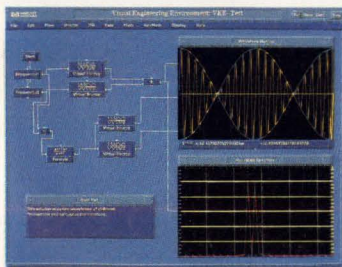
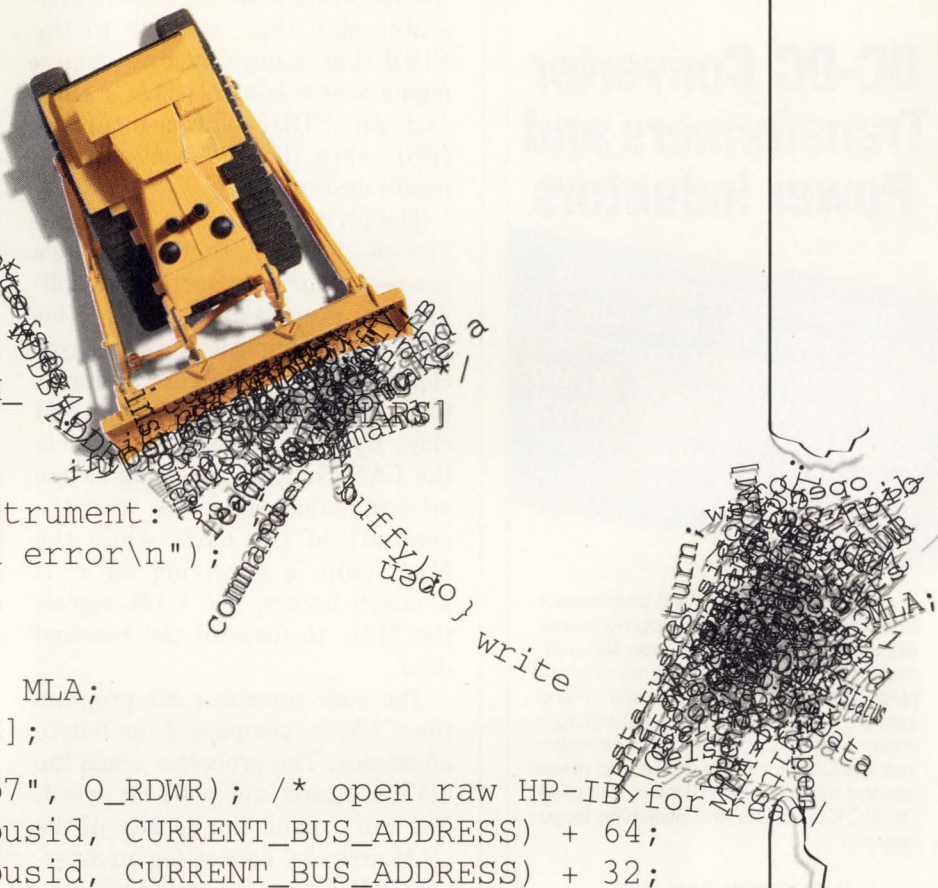

With HP VEE, you simply link the icons.

Computers are great for problem solving, if only programming didn't get in the way and slow you down. And now, it doesn't

have to. Because the HP visual engineering environment (HP VEE) lets you solve problems without programming.

With HP VEE, you explore solutions visually by arranging and linking icons on the CRT. Each icon represents and executes a specific function for data collection, analysis—from simple mathematics to complex algorithms—and presentation. You don't have to write a single line of code.

There are two HP VEE software packages for prototyping, experimentation, and problem modeling. HP VEE-Engine, at \$995*, is a

general-purpose tool for analysis and presentation of existing data. HP VEE-Test includes HP VEE-Engine and adds extensive I/O capability, including soft panels and device I/O objects for \$5,000*.

So, if programming is keeping you from solutions, call **1-800-452-4844**.** Ask for **Ext. 2380**, and we'll send you a brochure on clearing the way with HP VEE.

There is a better way.



* U.S. list prices.
** In Canada call 1-800-387-3867, Dept. 430.

ULTRA-MINIATURE SURFACE MOUNT

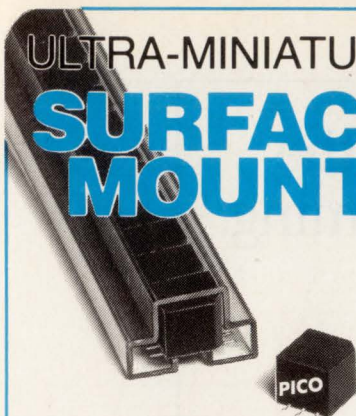

Actual Size

DC-DC Converter Transformers and Power Inductors

All PICO surface mount units utilize materials and methods to withstand extreme temperature (220°C) of vapor phase, IR, and other reflow procedures without degradation of electrical or mechanical characteristics.

These units have gull wing construction and are packaged in shipping tubes, which is compatible with tube fed automatic placement equipment or pick and place manufacturing techniques. Transformers can be used for self-saturating or linear switching applications. The Inductors are ideal for noise, spike and power filtering applications in Power Supplies, DC-DC Converters and Switching Regulators.

- Transformers have input voltages of 5V, 12V, 24V and 48V. Output voltages to 300V.
- Transformers can be used for self-saturating or linear switching applications
- Schematics and parts list provided with transformers
- Inductors to 20mH with DC currents to 23 amps
- Inductors have split windings

Delivery—
stock to one week

See EEM
or send direct for
FREE PICO Catalog

PICO Electronics, Inc.

453 N. MacQuisten Pkwy. Mt. Vernon, N.Y. 10552

Call Toll Free **800-431-1064**

IN NEW YORK CALL **914-699-5514**
FAX **914-699-5565**

CONTENT-ADDRESSABLE MEMORIES

are including a CAM in their chip sets. Motorola has included a CAM—albeit a small one—in its FDDI chip set. The \$186 (1000) set comprises four chips connected in the following manner: a clock-generator chip that connects to the FDDI ring, a physical-layer chip, a media-access-control (MAC) chip, and an FDDI-system-interface (FSI) chip that connects to the node's system bus.

The MC6889 FSI chip contains a 32×48-bit CAM that the node's processor can program to store individual or group addresses. The 8-bit port connecting the physical-layer chip to the MAC chip also connects to a CAM-interface port on the FSI chip. Bypassing the MAC chip lets the CAM compare incoming source or destination addresses with the contents of the CAM while the MAC chip is receiving data. If a match occurs, the CAM signals the MAC to forward the received data.

The node processor can program the CAM to compare 2- or 6-byte addresses. The processor reads the CAM's status via a 64-bit word. You can expand the density of the CAM array by connecting an external CAM device in parallel with the FSI CAM. The external CAM's in-

put port connects directly to the FSI chip's CAM-interface port. The 64-bit word has a user-defined bit you can use to signify whether a match occurs in the FSI CAM or the external CAM.

You ain't seen nothing yet

Time-critical search-and-sort applications will lead to broader use of CAMs in the future. Currently, managing FDDI's high-speed overhead is the driving force behind the fabrication of these devices, but as databases get larger and larger, applications will need a way to do searches faster and faster. Designers will find that sort algorithms and set-associative memories aren't up to the task. A fully associative, content-addressable memory is the fastest search vehicle available. CAMs have existed—at least conceptually—since 1950, and once applications catch up with these speedy memories, CAM vendors will be saying, "I told you so."

EDN

Article Interest Quotient
(Circle One)

High 479 Medium 480 Low 481

For more information . . .

For more information on the content-addressable-memory products discussed in this article, circle the appropriate numbers on the Information Retrieval Service card or use EDN's Express Request service. When you contact any of the following manufacturers directly, please let them know you read about their products in EDN.

Advanced Micro Devices

Box 3453
Sunnyvale, CA 94088
(800) 538-8450
(408) 732-2400
TWX 910-339-9280

Circle No. 706

Motorola Inc

6501 William Cannon Dr W
Austin, TX 78735
(512) 891-2140

Circle No. 708

Music Semiconductors Inc

1150 Academy Park Loop
Suite 202
Colorado Springs, CO
(800) 933-1550
(719) 570-1550
FAX (719) 570-1555

Circle No. 709

GEC Plessey Semiconductors

Cheney Manor
Swindon
Wiltshire SN2QW, England
07-935-18000

Circle No. 707

Presenting Two Plans For IC Development Guaranteed To Reduce Your..



What others promise, we guarantee.

Time-to-Market.



Our prototype services can take your designs from tape to packaged parts in 20 calendar days or less. Guaranteed.

So you get your products to market faster. Or regain time lost to engineering delays.

- Prototypes in 20 days
- Custom processes
- Non-competitive second source
- Fast pre-production quantities

Cut your development cycle with Orbit Semiconductor's prototyping service. Call (800) 331-4617. In California (800) 647-0222 or (408) 744-1800. FAX (408) 747-1263.

NRE.

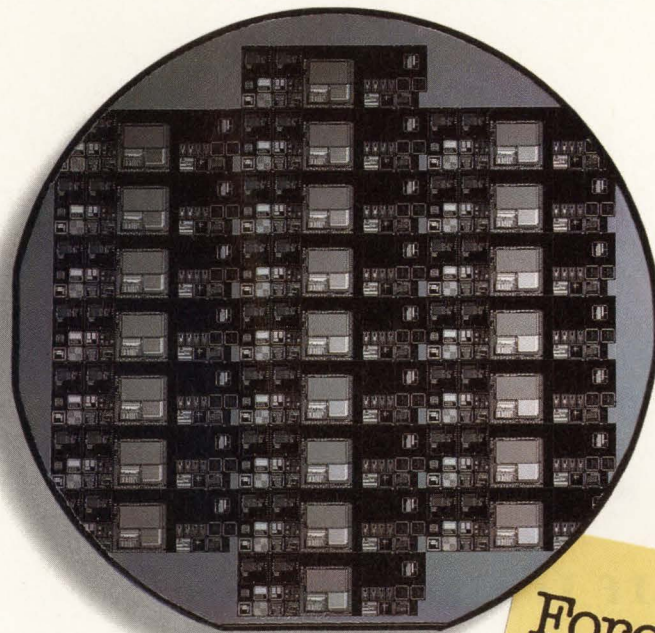

Get twelve packaged parts in five weeks—for as little as \$1500.

Our Foresight multi-project wafer processing program can dramatically cut the cost of IC prototyping while reducing your time to market.

- Foresight runs start every Wednesday
- Five week turnaround
- Dramatic reductions in prototyping costs
- Debug mixed signal ICs while in design

Don't wait to start cutting your NRE.

In fact, call (800) 331-4617, and you can start right away. In California (800) 647-0222 or (408) 744-1800. FAX (408) 747-1263.



What others promise, we guarantee.

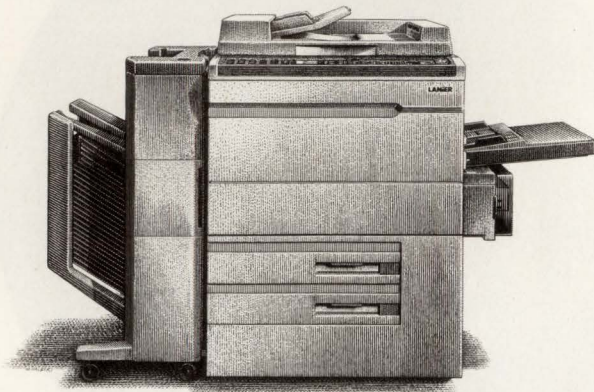

**If It Calls In Sick,
We'll Provide A Temp
At No Charge.**

We guarantee Lanier copiers to be up
and running 98% of the time.
So if yours is out of service
more than 8 hours, we'll
provide you with a free



loaner. That's our Performance Promise.*
For more details and a free copier infor-
mation package, call your local Lanier
rep. Or **1-800-852-2679**. And you'll
see whose temporary service is the best.

High-density PLD offers speed and in-system programmability

The PLSI 1032 and ISPLSI 1032 are the first two members of a high-density programmable-logic-device (PLD) family based on electrically erasable CMOS. The base technology allows the ISPLSI device to be in-system programmable.

The basic logical unit of the devices is a logic block, offering 20 product terms. The terms can use the true and complemented forms of as many as 16 internally generated signals and have access to two additional signals from dedicated I/O pins.

Each logic block has two 4-, one 5-, and one 7-input OR circuits. You can combine the output signals of these OR circuits if you need additional width or bypass the combinatorial circuitry if you need top speed with only a few terms. You can also Exclusive-OR the OR output signal with one of the product terms.

The four output signals from the logic block either pass through or bypass output registers. The registers are configurable as D-, JK-, or T-type registers with a choice of four clocks and two reset signals. Three of the clocks and one reset signal are common to all the logic blocks; the remaining signals are product terms from the block. The devices offer one register for each OR gate, but the registers are not dedicated to the gates.

Although all logic-block output signals are available internally to the product terms, signals destined for the outside world must pass through an output routing pool before reaching I/O cells. The devices group eight logic blocks together on each device edge, with each group having its own output routing pool and 16 I/O cells.

The routing pool gives you flexibility in I/O pin selection. Each of

the 32 logic-block output signals in the group has a choice of four I/O cells. As with the combinatorial circuitry in the logic blocks, you can bypass the routing pool for greater speed but no choice in I/O pin.

You can configure the I/O cells as input ports, output ports, or bidirectional ports, with each port type offering options. Input ports can simply buffer signals, latch them, or register them. Output ports can buffer signals, either with or without inverting them. They can also provide 3-state buffers, with the enable signal coming from a product term. Bidirectional ports can simply buffer, or buffer the output signal while registering the input signal.

If you use all the bypass options, a signal can propagate through either device in 15 nsec. Because of the wide combinatorial terms available, your design may not need to use feedback. If it does, however, the feedback term can add from 9 to 16 nsec, depending on fanout of the term internally.

The device family comes in two nearly identical forms. The ISPLSI device, however, has an additional attribute. Four of the device's I/O pins serve double duty as programming pins, allowing you to clock in

and load a serial programming pattern while the device is in a system. This in-system programmability lets you build your system, even your prototype, without sockets for the PLD, thus decreasing noise and increasing system speed.

The company supports its devices with an array of programming tools. The basic software runs on a DOS-based computer under Windows and allows schematic and Boolean design entry. It comes with a library of 240 macro functions that include most common TTL functions. You can also edit these macros or create your own. If you already have a design entry system, the software can serve as back-end, place-and-route software. The company also offers an engineering kit for the ISPLSI device.

The PLSI 1032 ranges from \$49 to \$81 (1000). The ISPLSI device costs \$142 (100). Software costs \$995, and the engineering kit is \$395. The devices come in 84-pin plastic-leaded-chip-carrier packages.

—Richard A Quinell

*Lattice Semiconductor Corp,
5555 NE Moore Ct, Hillsboro, OR
97124. Phone (503) 681-0118. FAX
(503) 681-0347. TLX 277338.*

Circle No. 732

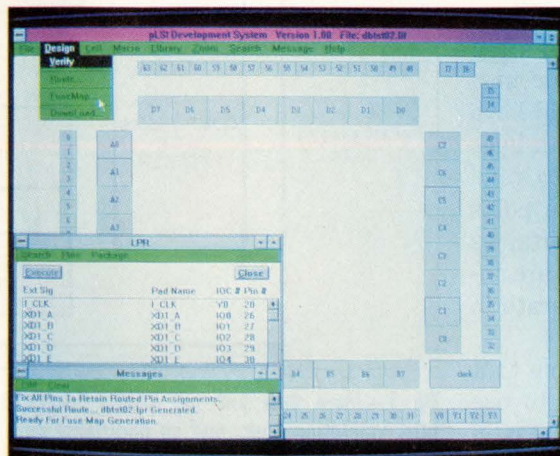

The PLSI and ISPLSI programmable logic devices offer combinatorial logic blocks with flexible I/O pin mapping. They are supported by Windows-based design, place, and routing software.

Cache tag RAMs offer 12-nsec validated match with extras

The CY7B180 and CY7B181 cache tag RAMs not only offer $4k \times 16$ -bit tag memory, they include functions such as chip-select decoding and the logic needed for validating matches. They also include two status bits for each memory location and an additional data port to speed copy-back cache designs.

The devices' base structure is $4k \times 18$ bits. Each word location stores a 16-bit tag and two status bits. You use the devices for storing the lower-order address bits for the memory you have copied into cache. When the processor addresses a memory location, the tag RAMs respond with a match signal within 12 nsec if that address has been cached.

Several built-in functions can simplify your cache design. You can read from and write to the tag data and status bits independently. This operation allows you to update status without having to do a read-modify-write on a combined tag and status word. Another function allows automatic generation of a write output signal to the cache RAM when the tag RAMs detect a valid write hit.

A design-simplifying attribute comprises two separate ports: one for tag data and one for the address-match comparison data. The latter port provides the contents of a tag RAM whenever a match occurs. With a single port, you would have to multiplex address and data lines to the tag RAM in order to read back tag data. The separate ports eliminate that need. All ports, as well as the command lines, are internally latched and can operate in latch or clocked mode.

When replacing a cache line that has "dirty" data, you need to use the tag data to find the address in

main memory that needs changing. Having that data available automatically when the tag RAM is addressed, rather than having to read it back through the match-comparison port, speeds the copy-back process.

The tag-RAM array (Fig 1) includes status bits for each tag location. The CY7B180, intended for use in a multiprocessing application, uses the two bits to code the corresponding tag data's status as modified, exclusive, shared, or invalid. The CY7B181, intended for use in a uniprocessing application, uses one status bit to represent whether or not the tag data is valid. It uses the other status bit to let you know whether the data is "dirty,"—that is, modified but not yet updated in main memory. The device automatically sets the "dirty" bit if it detects a write hit.

The 181's on-chip valid bit allows it to perform validated matches. When you present the address in

question to the RAM, it will respond by indicating whether that location has been tagged and whether the tag is valid. You can clear individual valid bits in a memory cycle or clear all valid bits simultaneously in two memory cycles.

The devices have four chip-select lines—two low-true and two high-true. When the device is not selected, all of its outputs switch to high impedance. This combination of features allows you to cascade as many as four devices, forming a 16k-word RAM array, without suffering a speed penalty. Simply use the two most significant address bits to drive the appropriate chip selects and wire-OR the output signals.

The CY7B180 and CY7B181 come in 68-pin plastic leaded chip carriers and cost \$72.05 (100).

—Richard A Quinnell

Cypress Semiconductor, 3901 N First St, San Jose, CA 95134. Phone (408) 943-2600. FAX (408) 943-2741. **Circle No. 730**

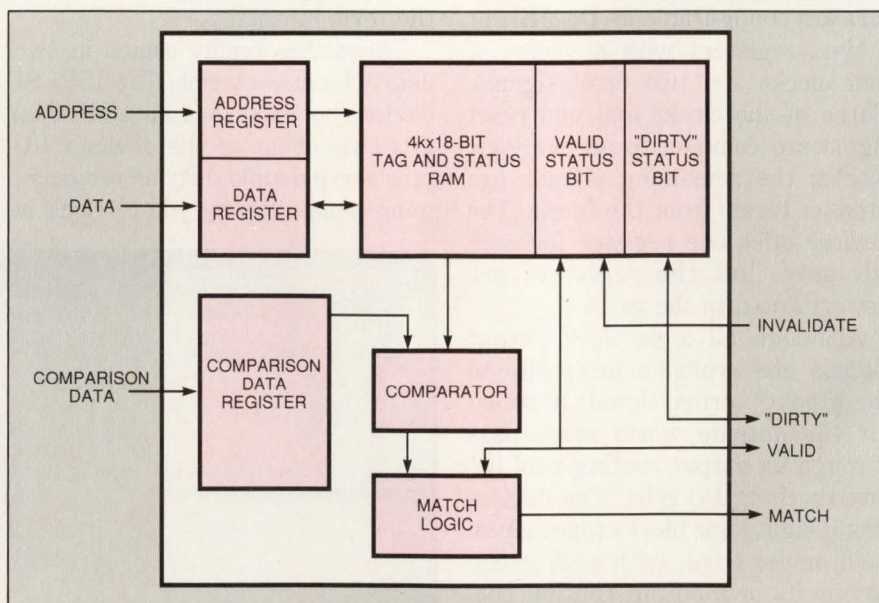

Fig 1—More than just tag RAMs, the CY7B180 and CY7B181 devices incorporate status bits, validation logic, and an additional data port.

Drive your DSP design all the way home.

Why complicate your travel plans? Zip along the entire DSP design route with SPW™ – the Signal Processing WorkSystem® from Comdisco.

SPW is the only DSP and communications design software tool that's complete and integrated. The only one that can take you all the way from idea to implementation. No matter where you're headed. No matter which road you take. And it's fast. It has all the horsepower you need to cut design time by as much as 90 percent.

First, SPW helps you choose your destination. You can quickly draw from its extensive libraries of reusable function blocks. And you can take advantage of SPW's open architecture to incorporate your own models.

After this, SPW automatically transforms your design into an

error-free simulation program. One that lets you perform accurate design, prototyping and analysis. One that confirms that you're headed in the right direction.

And, to assure that your way is free from bumps, potholes, and those awful "dead end" signs, SPW comes with the industry's widest range of implementation options. Options that generate code for floating- and fixed-point DSP chips as well as DSP systems with multiple processors. Options for bit-true fixed-point simulation that automatically generate VHDL and provide seamless links to the leading logic synthesis tools. Options that pave the way to fast FPGA and ASIC production.

So, how about a test drive? Call us at 415-574-5800. And learn how SPW can put you in the fast lane to market.



COMDISCO[®]
SYSTEMS, INC

U.S.: Telephone 1-415-574-5800, Fax 1-415-358-3601 Europe: Telephone 44-454-614256, Fax 44-454-614700

CIRCLE NO. 43

EDN April 9, 1992 • 75

Electrostatic plotter makes E-size drawings at 6 ips

The Colorstation 400X family of electrostatic plotters produces color or monochrome, E-size (36×50-in. cut-sheet) or D-size (24×36-in. cut-sheet), drawings. The series consists of four models: the Colorstation 436CX for E-Size color drawings; the Colorstation 424CX for D-size color drawings; the Colorstation 436MX for E-Size monochrome drawings; and the 424MX for D-size monochrome drawings. The plotters boast a writing speed of 6 ips—considerably faster than competitive models that write between 0.8 and 2 ips.

The plotters achieve their high plot speed by employing a patented Silicon Imaging Bar writing head. Conventional electrostatic plotters employ a multiplexed writing head to transfer electrical charge to the media. A multiplexer transfers charge from a common source to multiple nibs. The Silicon Imaging Bar writing head consists of a dedicated driver for each nib. Because a multiplexed driver necessitates a time delay before applying charge to subsequent nibs, it is slower than these dedicated drivers.

In addition, the Colorstation Series can accurately register the location of dithered color dots. Conventional electrostatic plotters employ a multipass reel-to-reel media-transport system, which rewinds on each pass to deposit the four primary colors. On the first pass, reel-

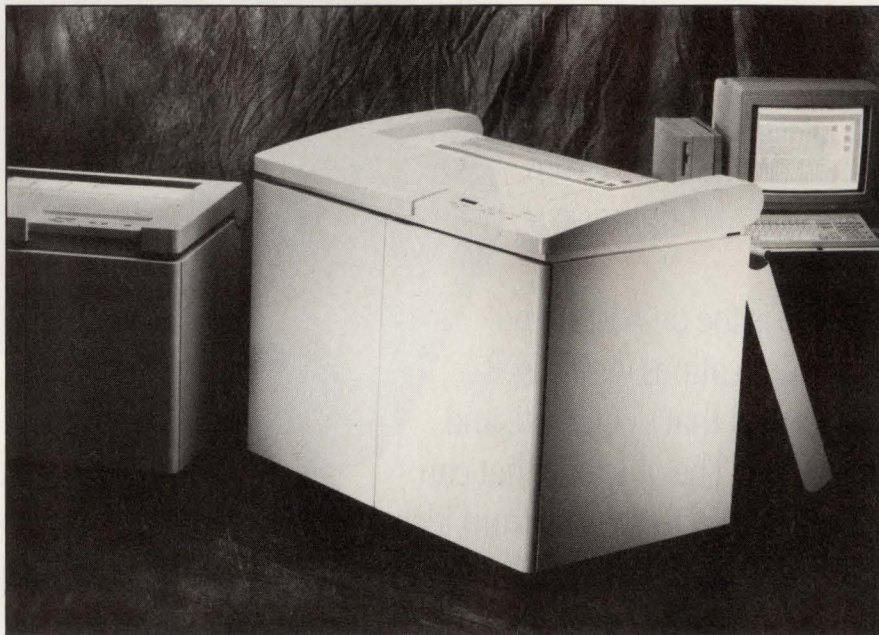

Providing switch-selectable 200- or 400-dpi resolution, the Colorstation 400X Series color and monochrome electrostatic plotters produce plots at 6 ips.

to-reel systems place registration marks on the edge of the media to provide servo information for subsequent passes. However, during the toning process, any paper stretching can distort this registered information.

The Colorstation Series locks the cut-sheet media onto a belt using a vacuum. Registration marks are fixed on the vacuum-locked belt, which rotates past the nibs on each color pass. Because the media cannot shift or stretch while locked to the belt, the vacuum-locked system

ensures registration from one color application to the next. The Colorstation series has an overall plot-accuracy specification of 0.05%.

For a print controller, the Colorstation Series plotters employ an Intel 80960CA RISC μ P that delivers 66 MIPS peak. The plotters also offer 200-dpi plots for quick drafts and 400-dpi plots for fine detail. You switch between modes with the press of a button. Competitive models offer only one of these resolutions. In 200-dpi mode, the 436CX can produce a full-color, E-size plot in less than 3 minutes.

A plot-nesting feature places A- through E-size drawings on a single sheet. For example, an E-size model can plot 16 A-size, 8 B-size, 4 C-size, 2 D-size, or a combination of these sizes on a single E-size sheet. A plot-tiling feature lets you plot large panels by automatically splitting a drawing into several images and plotting the im-

Table 1—Electrostatic plotter prices

Model	Hard-drive capacity		
	42 Mbytes	100 Mbytes	234 Mbytes
424MX	\$22,895	\$23,895	\$24,895
424CX	\$34,895	\$35,895	\$36,895
436MX	NA	\$28,895	\$29,895
436CX	NA	\$44,895	\$45,895

NA = Not available

© 1992 XES, Inc.

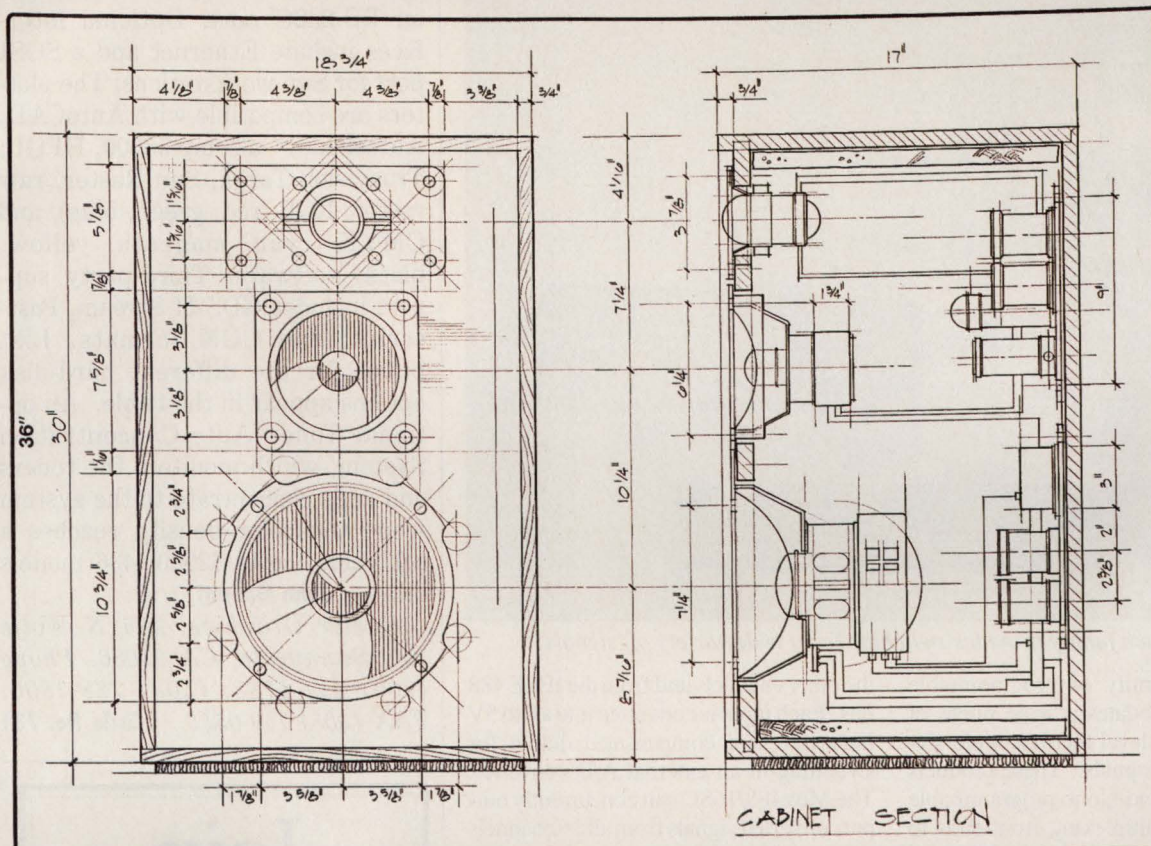

DATE	BY

Rick Guidice
 PROJECT ENGINEER
 XEROX CORPORATION

**HIGH VOLUME
 STEREO SPEAKER**

Our monochromatic plotters perform best at any volume.

Now hear this. Xerox Engineering Systems offers the biggest selection of high performance monochrome electrostatic and laser plotter solutions for today's engineering environments.

These powerful productivity tools are uniquely designed for

optimum volume plotting and unattended operation. At high resolution, they deliver laser-sharp lines, smooth diagonals and superior gray scales.

At Xerox, our goal is to help you get your job done more efficiently. For more information,

call 800-538-6477. In California, 800-341-6060. And find out how to turn up the volume on your plotting.



The engineering document company.

Xerox Engineering Systems

2710 Walsh Avenue, Santa Clara, CA 95051. Xerox and CADmate are trademarks of Xerox Corporation.

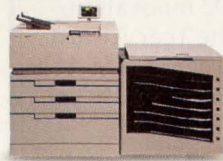

8840

The Electronic Graphics Printing System that sets new standards for convenience and productivity.



8836

Versatec's popular E-size laser plotter, perfect for both presentation-quality and quick check plots.

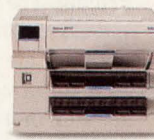

8810

High-speed, desktop laser plotter for low cost A and B size check and final plots.

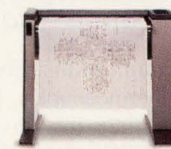

Turbo CADmate™

Versatec's laser-quality, wide-format plotting system that's up to ten times faster than pen plotters.

New Switch Family for IEEE 488, RS-232, and PC-based Systems

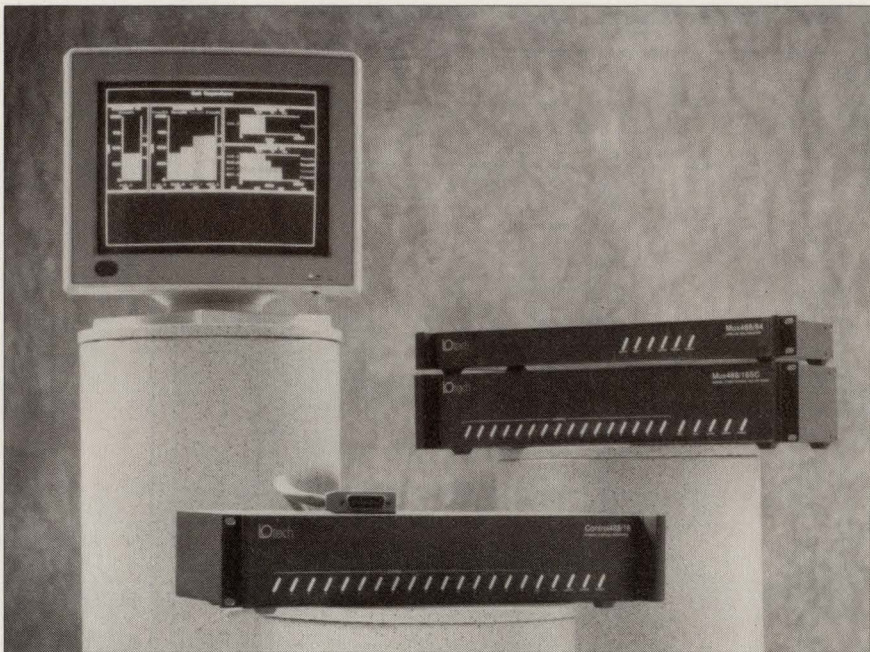

Iotech's new switch family provides switching for a wide variety of signals

Iotech's new family of programmable switches accommodates a wide range of signals, from low-level thermocouple signals to 280 VAC signals. These products can be used as stand-alone programmable switches or as multiplexing front-ends to DVMs, data loggers, PC plug-in A/D converter boards, and Iotech's own ADC488 series of A/D converters.

These new switches offer three means of computer control, making them useful for a variety of applications. They are available with IEEE 488 and RS-232 interfaces, and with a parallel 8-bit digital interface for control directly from a PC's parallel port or from any digital I/O port.

High Channel Capacity. For applications that involve switching signals up to 10V, the Mux488/64 can switch up to 64 inputs for output to an A/D converter. For applications requiring greater switching capacity, multiple units can be connected in a master-slave configuration, providing switching for as many as 1024 channels. The Mux488/64 also features a time-base and trigger source that enables it to automatically scan selected groups of signals at rates up to 4 kHz, and trigger an A/D converter after each signal is switched.

Signal Conditioning. For applications that involve thermocouples, RTDs, strain gages, or other low-level signals, the Mux488/16SC provides up to 16 input channels, each of which is isolated by 500V from

the other channels and from the IEEE 488 bus. Each input is converted into a 0 to 5V linearized and compensated output for switching to an external A/D converter. The Mux488/16SC can concurrently output converted signals from all 16 channels or can multiplex them for output on 1, 2, or 4 channels. Multiple units can be connected in a master-slave configuration to switch as many as 256 channels. The Mux488/16SC offers a quick-disconnect, screw-terminal block that accepts transducer wires and provides cold-junction sensors for thermocouple measurements.

High Voltage Switching. For high-voltage or high-current switching applications, the Control488/16 accommodates a wide range of user-configurable switches. Each of the Control488/16's switches is isolated by 500V from the other switches and from the IEEE 488 bus, and can accommodate DC and AC voltages up to 280V RMS, and DC and AC currents up to 3A. The Control488/16 provides two terminals for each switch and a convenient quick-disconnect, screw-terminal rear panel board with built-in strain relief.

Pricing. The Mux488/64, Mux488/16SC, and Control488/16 are all available from stock and are priced from \$595 to \$1,195. Transducer-conversion modules are extra. **For more information, call Iotech at (216) 439-4091, or fax your request to (216) 439-4093.**

CIRCLE NO. 45

EDN-PRODUCT UPDATE

ages on more than one sheet of paper.

The Colorstation Series plotters have a Centronics parallel port and an RS-232C port. Optional interfaces include Ethernet and a SCSI port for Sun workstations. The plotters are compatible with AutoCAD, Autosshade, Calcomp 58000, HPGL, Truevision Targa, Sun Raster, raw raster, RGB (red, magenta, yellow, black) software. Third-party support includes GDS-II Stream, Postscript, and CGM formats. List prices for the different hard-disk options appear in the table. An optional Toner Auto-Concentration System, which monitors the toners and adds concentrate to the system when the color density reaches a set value, costs \$2000 (436 models only).—**John Gallant**

Raster Graphics, 285 N Wolfe Rd, Sunnyvale, CA 94086. Phone (800) 441-4788; (408) 738-7800. FAX (408) 749-0544. Circle No. 731

Join EDN's Crusade!



Nominate a person or product for EDN's 1992 Innovation/Innovator of the Year Award. Fax Pam Winch at 617/558-4470 for a 1992 Nomination Packet.

ACT FAST...

THE DEADLINE IS MAY 22ND.

High Performance Instrumentation Amps

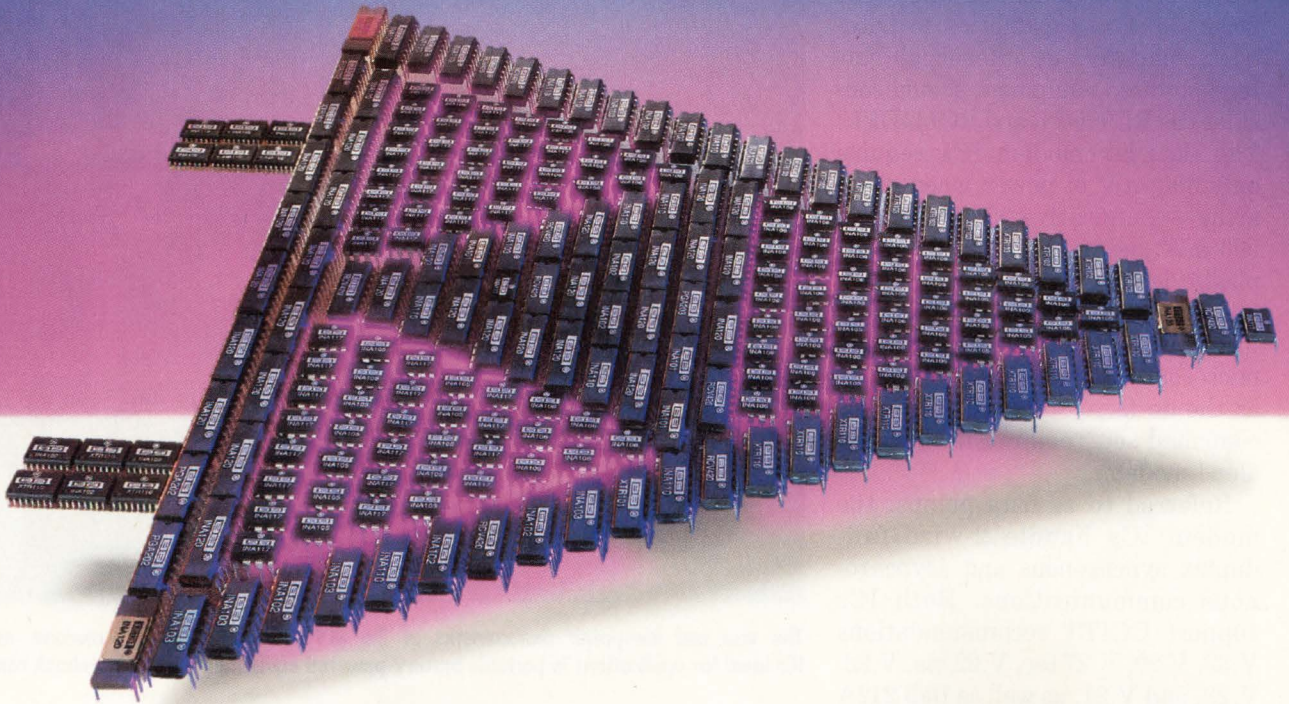

Industry's Widest Selection

Our new *Instrumentation Amplifier* guide can help you find the best IA for your industrial control, audio, medical, and low-level signal conditioning applications. Choose our low cost difference amps, fast FET, precision bipolar, programmable-gain IAs, and many more.

* U.S. OEM prices only, in 1000s.

Low Noise Audio INA103

- $1\text{nV}/\sqrt{\text{Hz}}$ noise
- $<0.002\%$ THD
- $>110\text{dB}$ CMRR
- \$4.85*

Precision INA120

- $25\mu\text{V}$ max offset
- $0.25\mu\text{V}/^\circ\text{C}$ max drift
- Gains of 1, 10, 100, 1000
- \$5.80*

High CMV INA117

- $\pm 200\text{V}$ CMV range
- 0.0002% nonlinearity
- \$4.10*

Digitally Programmable PGA202/203

- Gains of 1, 10, 100, 1000 or 1, 2, 4, 8
- $2\mu\text{s}$ settling time (to 0.01%)
- 0.012% nonlinearity
- 80dB CMRR
- \$6.75*

FREE Instrumentation Amplifier Guide

For samples, data sheets, and your free selection guide, contact your local Burr-Brown sales office or call: **(800) 548-6132 toll-free** for immediate assistance.



Burr-Brown Corp.
P.O. Box 11400
Tucson, AZ 85734

BURR-BROWN®
BB

Modem ICs consume only 390 mW, yet perform fax and data duties

Designers who need to add data or facsimile (fax) capabilities to notebook computers or other small battery-powered equipment should consider the RC96DPL and RC144DPL. The data/fax modem ICs require only 390 mW of power when operating—competitive chips require 500 mW and more. A single 68-pin plastic leaded chip carrier (PLCC) houses the ICs, and they can perform voice processing. A companion microcontroller adds functions, such as the de facto standard Hayes AT command set, required for a stand-alone modem.

Referred to as data pumps, the modem ICs handle 2-wire full-duplex synchronous and asynchronous communications. Both ICs support CCITT recommendations V.32, V.29, V.27 ter, V.22 bis, V.22, V.23, and V.21, as well as Bell 212A and 103 de facto standards. Therefore the chips handle data-modem duties in communications speeds ranging from 300 to 9600 bps, and fax communications at speeds ranging from 2400 to 9600 bps. The RC144DPL also supports 14,400-bps fax and data communications specified by the V.17 and V.32 bis CCITT recommendations.

Other features of the ICs include an in-band 150-bps secondary channel that can operate concurrently with V.32 and V.32 bis communications. The secondary channel allows you to implement functions such as network management. The ICs have digital near- and far-echo cancellation and support bulk delay for satellite transmission. They also have compromise and automatic adaptive equalizers and feature a dynamic range of -43 to 0 dBm.

Because the ICs basically consist of a DSP core with an analog front end, DSP software actually handles support for specific protocols. The

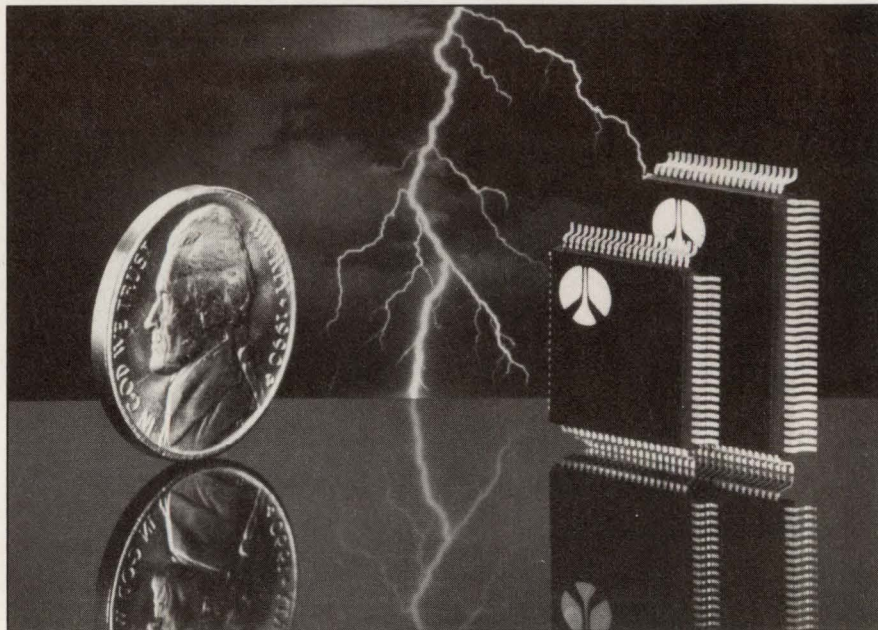

The size and low-power characteristics of the RC96DPL and RC144DPL modems make the ICs ideal for applications in portable battery-powered equipment such as notebook computers.

DSP-core-design approach also allowed the IC designers to include support for voice operations. The modem ICs provide an ADPCM (adaptive differential pulse-code modulation) voice codec (coder and decoder). The ADPCM codec compresses voice signals to minimize the size of digitized voice messages. You can program the codec to operate at 28.8, 21.6, or 14.4 kbps at a 7.2-kHz sample rate. Silence detection and deletion, and decoder silence interpolation further improve compression rates.

The RC96DPL and RC144DPL have functional capabilities that are key for modem applications ranging from stand-alone modems to modem cards for personal computers. The size and power characteristics, however, make the ICs a particularly good choice for portable or battery-powered applications.

The ICs not only require 20% less operating power than other available products, but also require only

10 mW in sleep mode. Competitive products use 50 mW in sleep mode. The sleep-mode capability can prolong battery life in portable applications such as notebook computers. The company offers each modem IC in a 68-pin PLCC or in two (80- and 100-pin) plastic quad flatpacks.

The modem ICs will be available by the end of April. The RC96DPL costs \$83, and the RC144DPL costs \$98 (10,000). By the end of May the company plans to ship chip sets that include a modem chip and a companion microcontroller (μ C). You can use the μ C to implement features such as the Hayes AT command set or V.42/V.42 bis error correction and data compression. The chip sets, designated RC96ACL and RC144ACL, will cost \$98 and \$113 (10,000), respectively.—Maury Wright

Rockwell International, Digital Communications Div, 4311 Jamboree Rd, Newport Beach, CA 92658. Phone (714) 833-6849. FAX (714) 833-6399.

Circle No. 733

Within budget. Without compromise.

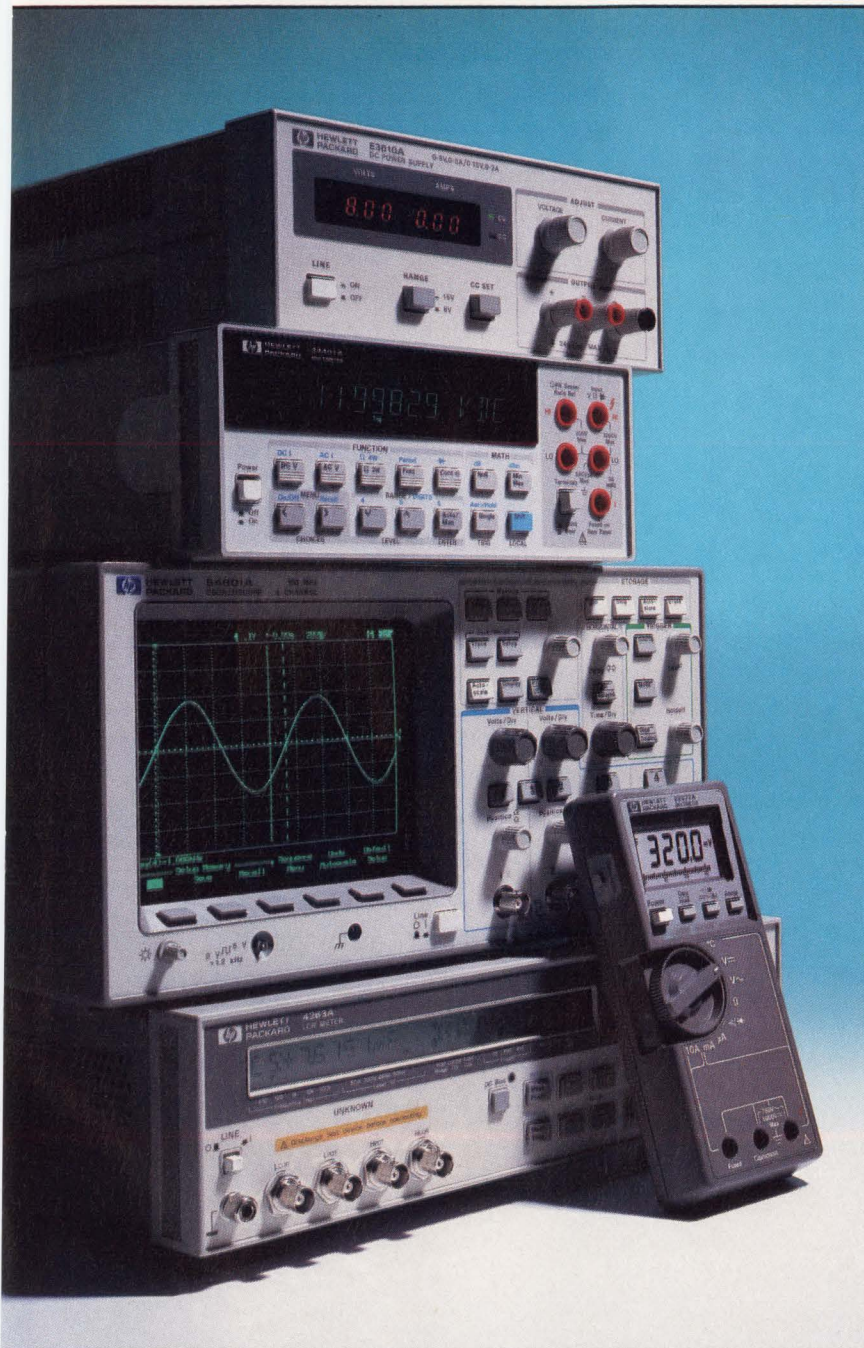

© 1992 Hewlett-Packard Co. TMINI112/B/EDN

With HP basic instruments, performance costs less than you expect.

Now you don't have to accept trade-offs in a basic test instrument. Because HP offers the performance you want at prices you can afford.

Need a dual-range output power supply? The HP E3610 Series makes choosing a 30-watt dc power supply easy—especially when you consider the low noise and **\$300*** price.

What about a digital multimeter for bench or system use? The rugged 6 1/2 digit HP 34401A does both with uncompromised performance for **\$995***.

You won't find a better 100 MHz digitizing scope than the HP 54600 Series. It combines analog look and feel with digital troubleshooting power for only **\$2,395** (2-channel) or **\$2,895** (4-channel)*.

At **\$3,800***, the HP 4263A LCR Meter lowers the cost of high-precision 100 Hz to 100 kHz benchtop and system component measurements.

And the 8-function HP E2377A is just one of the HP E2300 Series 3 1/2 digit handhelds priced from **\$99** to **\$189***.

☎ For more information or same-day shipment from HP DIRECT, call 1-800-452-4844. Ask for Ext. T517 and we'll send you a data sheet that shows how affordable performance can be.**

* U.S. list price

** In Canada call 1-800-387-3867, Dept. 433

There is a better way.



**HEWLETT
PACKARD**

Finally! A true 32V Precision Analog Array —with onboard Digital Logic.



Put all your analog
and digital control
functions on a single
piece of silicon.

32V Bipolar gain blocks with signal bandwidths to 4MHz, thin film resistors, and 74LS speed compatible digital gates—all on a single piece of silicon!

That's the new **RLDA80**.

Think of the possibilities.

Programmable timers. PWM controllers.

Motor speed controllers.
Supervisory circuits.
Phase locked loops. Latched analog multiplexers.

RAYTHEON RLDA80 LINEAR/DIGITAL ARRAY	
8	32V PROGRAMMABLE ANALOG MACROCELLS <i>(Op amps, ground sensing amp, low distortion op amps, TTL output comparator, bandgap reference)</i>
36	5V PROGRAMMABLE DIGITAL MACROCELLS
16	5V DEDICATED DIGITAL MACROCELLS <i>(Up to 200 equivalent gates)</i>
16	DIGITAL I/O CELLS
128	200ppm/°C THIN FILM RESISTORS
36	SMALL SIGNAL PNPs and NPNs
4	100mA NPN DRIVE TRANSISTORS

All on a single die.

How many parts would that eliminate in your design? How much space, weight and power would it save? How much easier would assembly be? And how much more rugged would it make your final product?

There's a quick way to find out.

Show us your design—and we'll show you how easily it can be integrated onto a single RLDA80.

It's fast—typically six to eight weeks from design review to prototype.

And flexible—changes to an RLDA80 prototype can be done within four weeks.

We're committed to analog design. And to developing partnerships with our customers to produce the most efficient and cost-effective solutions possible.

So if you've been waiting for a mixed signal array for the "real world," it's here. For specifications on the RLDA80, give us a call at **1-800-722-7074**.

Raytheon Company, Semiconductor Division.
350 Ellis St. Mountain View, CA 94039.

Raytheon

Where quality starts with fundamentals

CIRCLE NO. 48

Semiconductor Division

Gate array builds on 68000 CPU core and integrates logic onto chip

Many engineers cut their design teeth on the 68000 microprocessor—a clean, elegant processor that dominated 16-bit embedded systems. Today, engineers can get the same 16.67-MHz processor as an ASIC core in Motorola's H4C-CDA gate-array family. An ASIC lets designers create high-density minimal chip designs, integrating glue and control logic onto a chip with the processor.

Other 68000 cores for custom design are available from vendors such as Signetics-Philips and Toshiba. However, this is the first time the 68000 is available as a gate-array core. The gate array uses the same 68000 core that Motorola builds into the 68302 microcontrollers (μ Cs). Standard 68000 timing is guaranteed at the gate array's pins: The part can be used to drive an existing 68000 design (with a different board layout). The 68000 array pins can be redefined for applications. Gate-array control logic has access to the 68000 control signals: DTACK, IPL, and BR.

Initially, the 68000 core is available as a defused block on the H4C057 array. This block has a fixed placement in the array to guarantee fixed CPU timing and pin routing. This array fields 57,000 usable gates, of which roughly 21,000 are replaced by the 68000 core and associated support logic. This move leaves approximately 37,000 available gates for special logic (with a 50 to 70% usage factor). The CPU core can be moved to other arrays, but it requires layout.

The 68000 core has more than 10 years' worth of software applications, software development tools, hardware tools, and a pool of 68000 programmers and designers. The array and 68000 processor are designed to take advantage of this

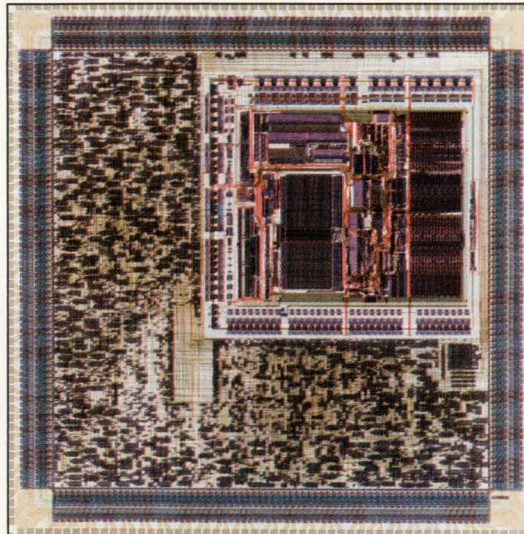

The 68000 core has a fixed position in the gate array, ensuring fixed signal delays and characteristics. The core takes up 20,000 gates.

base. The 68000 core is set up for test. A standard 68000 test program runs the CPU through its paces while the rest of the gate-array circuitry stays isolated. Designers added special circuitry for in-system debugging: The 68000 can be single stepped and halted. In addition, a pinout conversion board suits the 68000 for use with standard ICEs.

Motorola H4C Series— H4C057 gate array

Gate counts	21,000 68000 core 37,000 for logic, 57,368 total
Clock (max)	60 MHz
68000 clock	16.67 MHz
Routing	3-layer metal
68000-core pins	65 total
68000 power	0.3W
Gate power	3 μ W/gate/MHz
Typical gate delay . . .	180 psec (2 NAND)
Test	JTAG, LSSD/ESSD scan supported
I/O	3.3, 5.0V MOS, TTL can drive 48 mA
Pins	160-pin quad flatpack
Cost	>\$30,000 for NRE; \$25 (10,000)

Gate-array designers can simulate the core with a functional C model, which is compatible with the Verilog hardware description language used by many chip and system vendors. They can also run the Logic Automation 68000 functional model. Designs are entered via standard schematic-capture tools. Various timing and ATPG tools are also available. In addition, engineers can work at higher design levels with hardware-description languages and logic-synthesis tools from Synopsys and Cadence.—Ray Weiss

Motorola Inc, Application Specific Integrated Circuits Div, 1300 N Alma School Rd, Chandler, AZ 85224. Phone (602) 821-4426. FAX (602) 821-4850. **Circle No. 734**

Fuzzy logic drives 4-bit microcontroller

Lately, 4-bit microcontrollers get little respect; but, 4-bit microcontrollers (μ Cs) are potent processors that are still evolving. Hitachi's Compact 400 series 4-bit μ Cs bring the high-end HMSC400 architecture—4-bit data and 10-bit instruction—down to smaller 28-pin applications. Hitachi is simultaneously adding sophisticated high-end software capability, which is the first set of fuzzy-logic development tools for 4-bit μ Cs (see box, "Fuzzy logic arrives in the 4-bit world").

Running at 4.5 MHz, the Compact 400 series delivers more than

1 MIPS; an instruction cycle takes 0.89 μ sec. With 28 pins, the μ Cs support 22 I/O lines and are self-contained, with as much as 2k \times 10 bits of program ROM or 4k \times 10 bits of program EPROM.

Contrary to many engineer's expectations, 4-bit architectures have the programmability of a standard 8-bit μ C. They differ, however, by having a smaller, 4-bit-wide data path that limits I/O bandwidth and can complicate dynamic program addressing. However, for many applications such as small appliances or consumer products, 4-bit data paths are more than adequate. Also, the peripheral lineups of these μ Cs suit them for high-current or -voltage drive applications; for example, in LCDs and vacuum fluorescent displays.

Unlike many 4-bit μ Cs, the Com-

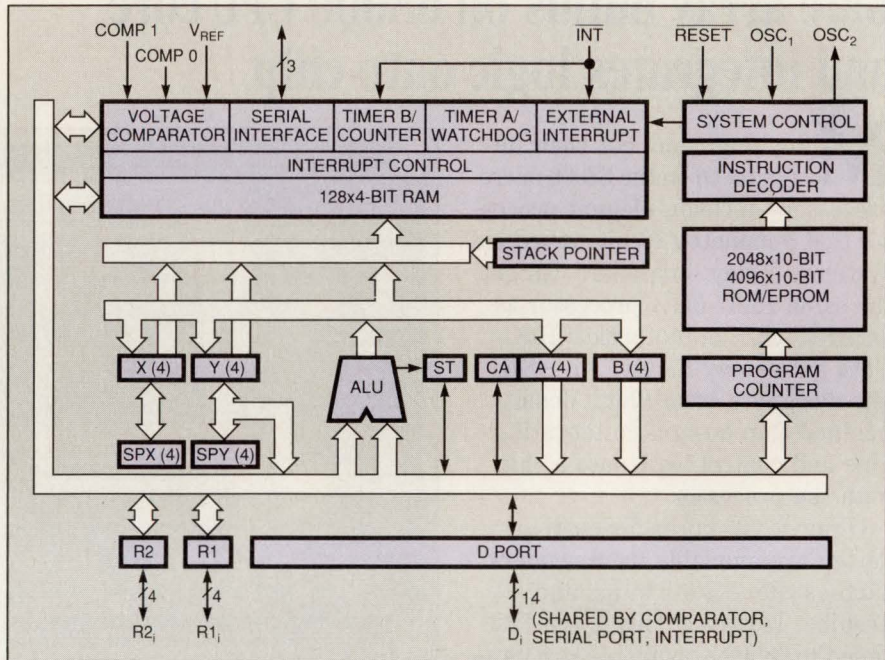

This 4-bit μ C uses 10-bit instruction and 4-bit data paths. The compact chip comes with a voltage comparator, serial lines, and timers.

Fuzzy logic arrives in the 4-bit world

Engineers no longer need 8- or 16-bit microcontrollers as a base for embedded fuzzy-logic applications. Fuzzy logic now runs on 4-bit μ Cs as well. Hitachi Ltd and Togai Infralogic Inc cooperatively developed a fuzzy-logic development tool, which delivers code that runs on 4-bit μ Cs: the Hitachi Compact 400 and the HMSC400 Series.

Fuzzy logic offers a simplified control mechanism, replacing complex control equations. With fuzzy logic, input measurements are converted into fuzzy values of input membership functions and are used to drive a set of logic rules. These rules take the fuzzy input values, evaluate them in parallel, and produce fuzzy outputs. These results are then mathematically squeezed to deliver standard control outputs.

For many applications, fuzzy technology enables engineers to concentrate on the control problem rather than creating the complex mathematical equations needed for control. Building a fuzzy application is a matter of defining input and output membership functions, writing the rules, selecting a "defuzzing" method, and then testing the system.

Fuzzy processing runs on a 4-bit Compact 400 μ C. A typical control problem with 3 inputs, 14 rules, and 2 control outputs takes less than 1.6k \times 10 bits of program ROM, including the fuzzy runtime library. In addition, it uses 104 nibbles of RAM.

Togai Infralogic supplies an interactive, MS-Windows-based fuzzy-logic development system. The H400 μ FPK&C, a runtime fuzzy-processing kernel and compiler for the Hitachi 4-bit μ Cs, supplements this tool kit, which costs \$18,500 (no production code royalties). Togai has similar development tool sets for Hitachi 8- and 16-bit μ Cs.

Togai Infralogic Inc, 5 Vanderbilt, Irvine, CA 92718. Phone (714) 975-8522. FAX (714) 975-8522.

Circle No. 736

compact 400 actually has a 10-bit instruction word (most use 8-bit instructions) with 4-bit data paths. Ten-bit instructions give the processor additional addressing and operand capabilities, thereby simplifying programming. By using a 10-bit-wide instruction, the CPU can support a complex set of instructions. In addition, a single ROM word can serve as an im-

Hitachi HMC400 compact 4-bit μ C

Clock	1.125, 4.5 MHz (internal)
Instruction cycle	0.89 to 4.0 μ sec
Registers	Six 4-bit registers, 12-bit program counter, 8-bit stack pointer
Memory	64 or 128 \times 4-bit RAM 1k or 2k \times 10-bit RAM or 4k \times 10-bit EPROM
Timers	Timer/counter; watchdog
I/O	22 special drive lines
Interrupts	1 external
Miscellaneous	Serial interface, voltage comparator
Power	3.5 to 6.0V: low-power version 2.5 to 6.0V
Package types	28-pin DIP, Small-outline flatpack
Price	\$2 (5000)

1 Meg of SRAM. 20ns access times. Sub-micron CMOS. But wait, there's more.

For fast access to more data than you ever dreamed, now's the time to check out Motorola's new 1 Meg CMOS Fast SRAMs. Because when you do, you'll receive a six-month subscription to Motorola's Update service, absolutely free.

Update gives you indepth data on all the latest Motorola products, with technical data sheets, application notes, data books, and product brochures. Hot off the press, and direct to your door – for six full months.

After all, fast access is what our 1 Megs are all about. With industry-leading 20, 25, and 30ns access times. In any configuration you need, including 128K x 8 bit, 256K x 4 bit, and 1 meg x 1 bit.



Plus a 256K x 32 bit module. All made with the built-in quality and reliability of Motorola's .8 micron CMOS process.

To find out more, send in the card



MCM6226A	MCM6227A	MCM6229A	MCM32257Z
128K x 8 bit	1 meg x 1 bit	256K x 4 bit	256K x 32 bit
20-45ns	20-45ns	20-45ns	20-45ns

with details, today. You'll get all the data on our 1 Meg Fast SRAMs – and on all the newest Motorola products, with Update. Plus a free master product selection guide, and a data disk for cross-referencing Motorola devices with competitive products. But you have to act fast, because this offer is limited. Send in the card today.

If you like what's new, wait 'til you see what's next.



Motorola offers a complete portfolio of CMOS and BiCMOS Fast SRAMs with densities from 16K to 1 meg, plus 2 and 8 meg modules. BiCMOS access times are as fast as 8ns (256K) and 10ns (1 meg).

Ⓜ and Motorola are registered trademarks of Motorola, Inc. © 1992 Motorola, Inc.

mediate RAM address (it addresses 1k nibbles).

A low-power version of the Compact 400 operates at 2.5 to 6.0V. Using a 1.125-MHz clock, this version reduces power consumption by 60% and delivers a 3.55- μ sec instruction cycle.

Two timer combinations are available: one with an 11-bit prescaler and 8-bit timer/counters, and one with an 11-bit prescaler, 8-bit (free running) watchdog timer, and an 8-bit auto-reload timer/event counter. The prescaler counts up the system clock and can provide low sampling frequencies. The prescaler divide ratio (count) is set into a timer mode register.

—Ray Weiss

Hitachi America Ltd, Semiconductor and IC Div, 2000 Sierra Point Pkwy, MS-080, Brisbane, CA 94005. Phone (415) 589-8300. FAX (408) 583-4207.

Circle No. 735

Low-cost 32-bit DSP processor runs floating-point operations

Thirty-two bit DSP is no longer the preserve of expensive applications. Analog Devices' ADSP-21010 is a reduced version of the high-speed, 32-bit floating-point ADSP-21020.

Priced at \$49.90 (100), the ADSP-21010 delivers 32-bit floating-point power, running a complex 1024 FFT in 1.54 msec. To lower the cost, however, the ADSP-21010 is a slower chip, having an 80-nsec instruction cycle—compared with 40 nsec for the ADSP-21020. The processor is also less complicated, supporting only IEEE 32-bit floating-point format.

The ADSP-210x0 series architecture is structured for high-speed DSP, especially algorithm inner loops. The DSP CPUs support a

modified Harvard architecture, with separate external instruction and data buses. The processors have a 48-bit instruction word and a 32-bit data word, with 24- and 32-bit address buses, respectively.

The 48-bit instruction word has extra bits to define multiple operations per cycle. It does, however, require two different memory designs—32 bit (data) and 48 bit (program).

These DSP architectures have a unique instruction caching scheme. Each processor has a small instruc-

tion cache (32-word cache) to hold inner loop instructions. When executing instructions in a programs' repetitive inner loop of the cache, the program address and program data bus are used to access data.

The CPU does two data memory accesses per instruction cycle; it has two built-in address generators for data access.

file is served by an ALU, a multiplier (and fixed-point accumulator), and a 32-barrel shifter.—Ray Weiss
Analog Devices Inc, Box 9016, Norwood, MA 02062. Phone (617) 461-3704.
Circle No. 737

Chip integrates 8051 architecture with EEPROM

Engineers can now use a single microcontroller (μ C) chip for embedded designs; unfortunately, single-chip solutions generally use on-chip ROM. Debugging embedded ROM code isn't easy: you need to change the code as the application code shakes down. Siemens' Macrochip provides a debug solution for 8051-based designs. The 80C51xxx Macrochip is a single-chip hybrid. Packaged in a 64- or 84-pin plastic leaded chip carrier, the chip contains an 8xC51 chip and EEPROM memory in place of on-processor ROM, so users can easily reprogram the code.

With the Macrochip users can debug their programs, modifying program memory as needed. With the 32-kbyte EEPROM version, you

The ADSP-21010 processor

Clock	25 Hz external
Instruction cycle	80 nsec at 25 MHz complex 1024 FFT (1.54 msec)
Registers	10-port register file 2 sets of 16 registers
Memory space	48-bit instruction 32-bit data
Address space	Separate instruction and data: 40-bit instruction, 32-bit data
On-chip memory	Small, effective 32-word (48-bit) instruction cache; 2-way, set associative
Arithmetic	32-bit fixed, IEEE floating point
Interrupt	Five external interrupts
Timer	32 bit
Serial	Asynchronous serial interface synchronous serial interface A/D, D/A, AES/EBU
Miscellaneous	Automatic loop control, on-chip ICE support
Package	223-pin PGA
Price	\$49.90 (100)

The Siemens 80C51xx Macrochip

Clock	12, 18 MHz
Instruction cycle	12 clocks
Memory	256-byte scratch pad 1-, 2-kbyte external RAM (some) 8- or 32-kbyte EEPROM
	64-kbyte instruction address space 64-kbyte data address space
Timers	Three or four 16-bit counters watchdog timer
I/Os	Six or seven ports: 56 pins One input port: 8 pins
Interrupts	2 external
Miscellaneous	8-bit A/D converter, duplex serial I/O
Package	68- or 84-pin PLCC
Price	From \$345

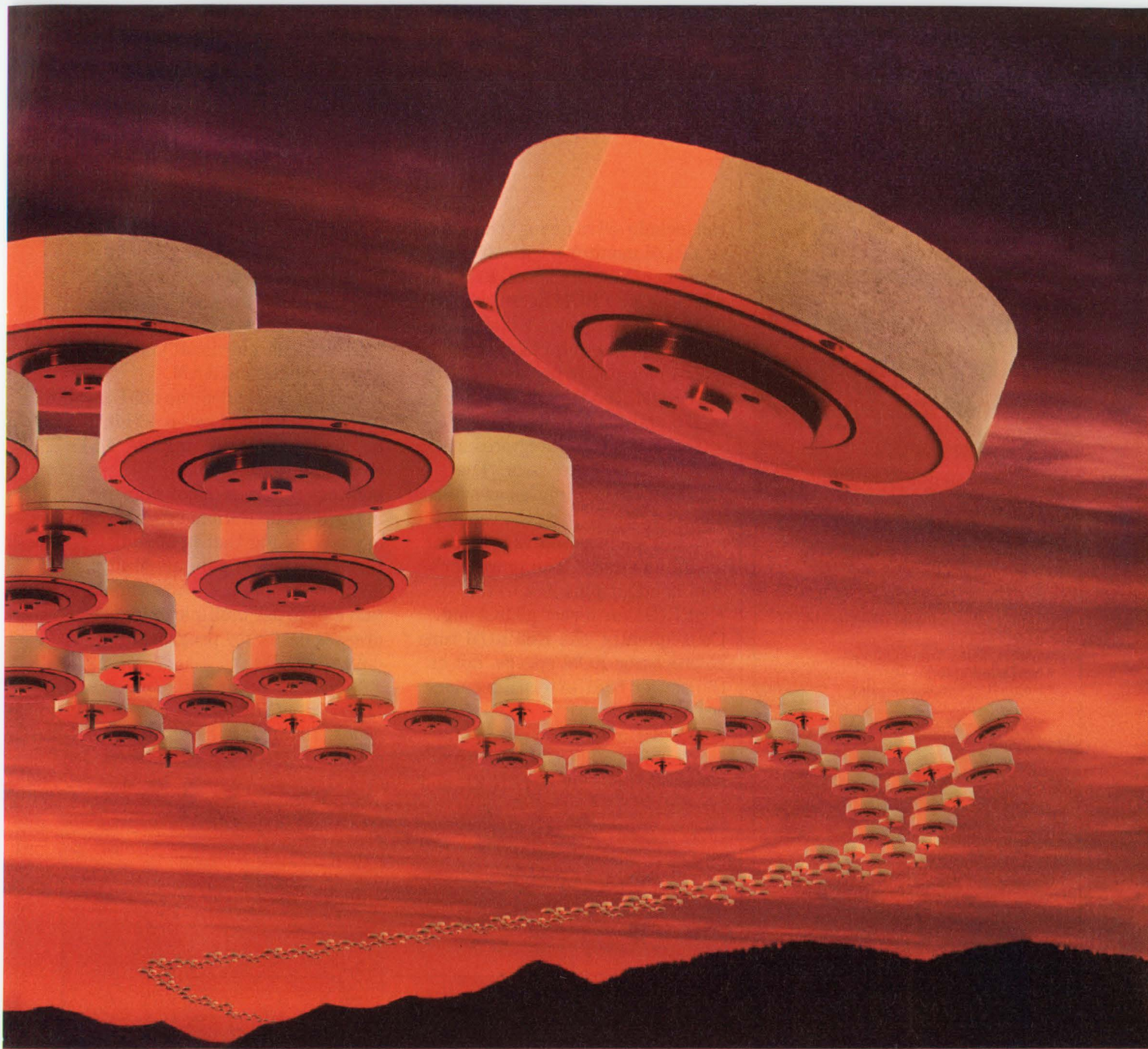

Brushless DC motors from Lamb have arrived

The performance and endurance of Lamb® motors will take you just about anywhere.

Lamb motors utilize electronic commutation to give you a motor that "flies" a lot further in a more compact housing.

These brushless DC motors have a high torque to inertia ratio for the superior stop/start capability required in today's high tech applications. They also minimize the problems of ripple torque, cogging effects, or demagnetization by high currents by utilizing cost-effective rare earth magnets.

Only 2" or 3.2" in diameter, these motors have stall torque ratings up to 84 oz-in for applications including tape cartridge drives, medical instruments, robots, pumps, compressors, or machine tools.

AMETEK, Lamb Electric Division, 627 Lake Street, Kent, OH 44240. Tel: 216-673-3451. Fax: 216-673-8994. In Europe, Friedrichstrasse 24, 6200 Wiesbaden, Germany. Tel: 611-370031. Fax: 611-370033.

AMETEK
LAMB ELECTRIC DIVISION

PICO AC-DC POWER SUPPLIES

meet all your military, computer and industrial requirements

INDUSTRIAL



- Both Linear and Switching Models available New Switching Series .500" Tall
- Linear available with terminal strip or PC mount
- Single, Dual, Triple Outputs
- No Derating to 70°C
- Regulated—Isolated

OPEN-FRAME

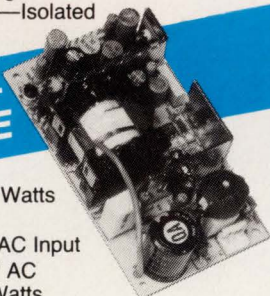

- Up to 200 Watts available
- Universal AC Input 85—264V AC up to 65 Watts
- Jumper Selectable Inputs up to 200 Watts
- Short Circuit Protection
- UL-CSA-TUV Compliant
- Regulated-Isolated
- Multiple Outputs

HI-RELIABILITY and MILITARY Applications



- Low Profile .500" Height
- Meet MIL-STD-704D Input Requirements
- Optional -55°C to +85°C Operating Temperature
- Selected Environmental Screening per MIL-STD-883 available

PICO Electronics, Inc.
453 N. MacQuesten Pkwy. Mt. Vernon, N.Y. 10552

Call Toll Free **800-431-1064**

IN NEW YORK CALL **914-699-5514**
FAX **914-699-5565**

CIRCLE NO. 39

90 • EDN April 9, 1992

can include extra debug code—such as a ROM monitor—without running out of memory space. Programming the EEPROM doesn't require new board voltages; 5V is all that's necessary. The chips have standard 8xC51 pinouts. To program the EEPROM, the rest pin and port-3 pins 6 and 7 are pulled low.

The Macrochip integrates an EEPROM and processor. The EEPROM is not treated as external memory by the processor chip; instead, it's addressed as processor on-chip memory. The processor's chip bondout pins link to the EEPROM for direct addressing. Consequently, the EEPROM runs at processor ROM speeds, not at the slower 8051 external-memory access speeds.

The 8xC51xxx Macrochip has four modules: 80C515AH-3J, 83C515AH-5J, 80C517AH-3J, and

83C517AH-5J. The 80C51xxx is a CMOS 8051 core with a 12- or 18-MHz clock rate, 256 bytes of RAM, and 8 or 32 kbytes of EEPROM. The 83C51xxx is a variant of the 8051, with an additional 1 or 2 kbytes of external RAM.

Siemens extended the 8051 architecture and added seven 16-bit data pointers, supplementing the 8051's single addressing pointer. These pointers relieve a major bottleneck in the 8051 operation: off-chip memory addressing that is forced through a single pointer. Multiple pointers enable programs to maintain and to use multiple external addresses easily for program and data.—Ray Weiss

Siemens Components Inc, 2191 Laurelwood Rd, Santa Clara, CA 95054. Phone (408) 980-4500. FAX (408) 980-4596. **Circle No. 738**

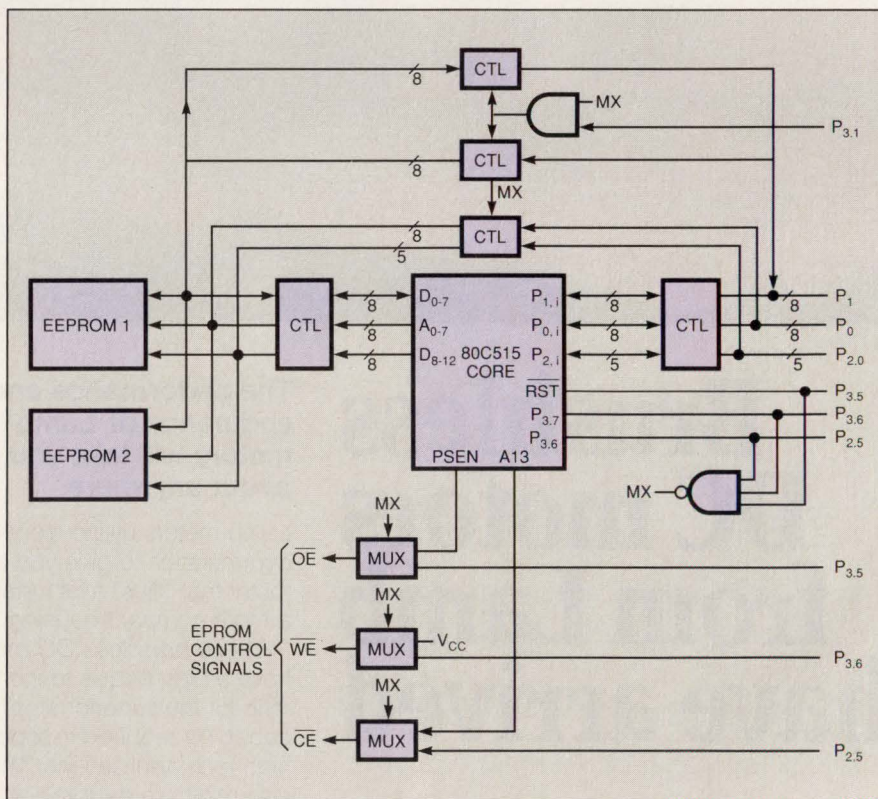

This microcontroller is a microcontroller within a chip: It uses an 80C515 as a core, supplemented with as much as 32 kbytes of EEPROM. You can easily reprogram the part electrically using only 5V.

Can you pick out the right EMI solution for your design?

We can.

It's easy to achieve electromagnetic compatibility when you know what product to use. And where to use it.

But you don't have to know the difference between wire mesh and finger stock to succeed. You just have to know Instrument Specialties.

We start at the drawing board, so you don't have to go back to it.

Our engineers work with yours to develop a total shielding solution right from the design stage. It can save plenty of costly rework—and worry.

Say goodbye to frantic product searches.

Everything you need is already in-house or in stock—whether it's con-

ductive elastomers, wire mesh, or the best beryllium copper fingers (to name just a few)... plus specified platings. With our prompt shipping, off-the-shelf parts can be at your door in no time. And our capabilities like CAD/CAM, photoetching and wire EDM not only make customization fast and easy, but downright economical too—especially with Finite Element Analysis, which tests parts *before* production.

You don't even have to go somewhere else for certified testing.

We can test for all current EMC specs and standards, at your facility or ours. And with our EMC experts helping you from design to production, passing the test will be a lot easier.

So why settle for just shielding, when you can have solutions? Call Instrument Specialties today at 717-424-8510, and find out what it's like to be EMC worry-free.



**Where Shielding
is a Science**

CIRCLE NO. 52

Instrument Specialties

Headquarters: Delaware Water Gap, PA 18327-0136
TEL: 717-424-8510 FAX: 717-424-6213

Western Division: 505 Porter Way, Placentia, CA 92670
TEL: 714-579-7100 FAX: 714-579-7105

European Division: 3 Avenue du Progres, B4432 Alleur, Belgium
TEL: +32-41-63-3021 FAX: +32-41-46-4862



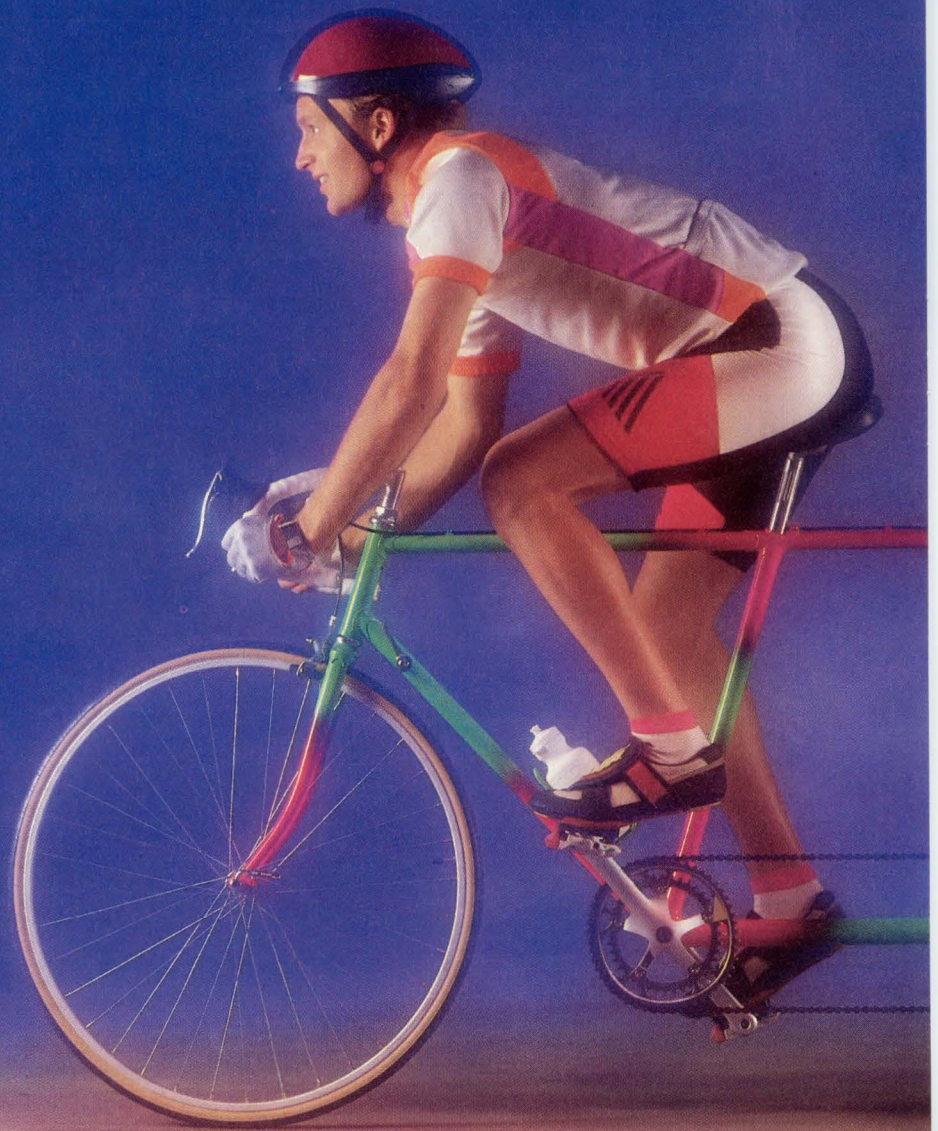

Until now, DOS and couldn't run

Introducing iRMX® for Windows: Real-Time Windows™ for PCs.

Running DOS or Windows* and real-time on a PC used to create some rather formidable challenges. After all, you could only run one at a time.

Fortunately, there's a whole new direction in real-time processing. It's called iRMX® for Windows. And it's a proven environment



that lets DOS and iRMX software work together to generate powerful applications.

This reliable operating system takes full advantage of the protected-mode features of the popular Intel386™ architecture. So it opens new avenues for cost-effective solutions.

Of course, iRMX for Windows also opens some powerful options for software

© 1991 Intel Corporation. iRMX is a registered trademark and Intel386 and Real-Time Windows are trademarks of Intel Corporation. *Windows is a trademark of Microsoft Corporation. iRMX for Windows is an EDN Innovation of the Year Award winner for 1991.

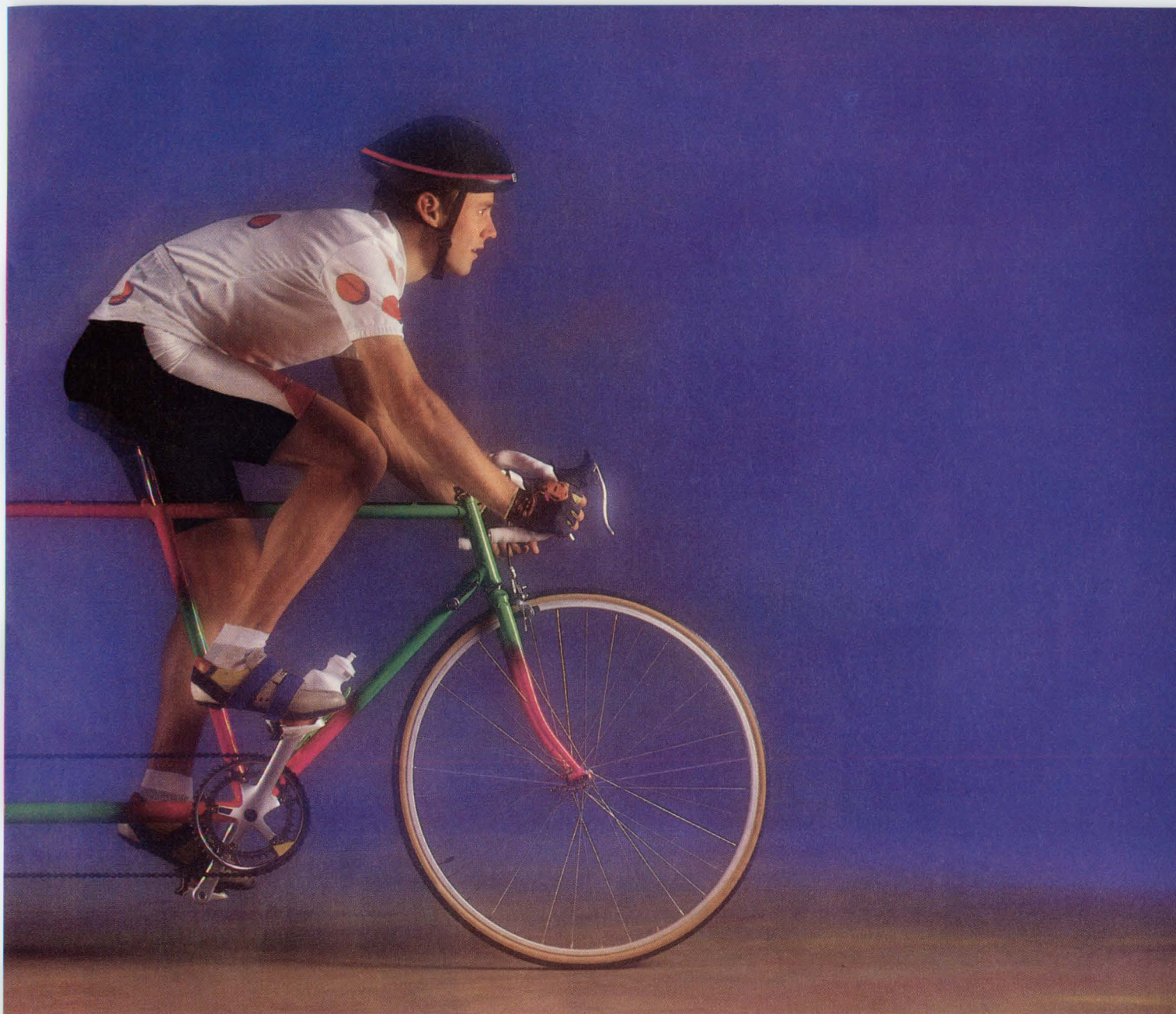

real-time applications concurrently.

engineers. Like bringing the huge installed base of DOS applications, tools, and the popular Windows environment to real-time development. What's more, as a developer, you'll receive professional support from Intel engineers.

All of which is important when you're racing to bring your application to market.

So make the shift to iRMX for Windows.

Call 1-800-GET-iRMX and ask for Lit. Packet #1C. You'll receive our Real-Time Response Kit. And give your next application some serious momentum.

intel®

The Computer Inside.™

The new new at Maxtor

It's a new commitment to leadership shared by every one of us.

You see, at Maxtor we're driven to ensure that our customers are satisfied with every aspect of the way we do business. From innovative technology and designs to outstanding quality, competitive pricing,

on-time delivery and unmatched service and support.

What's more, we're committed to setting product trends. Take our new MXT-1240. It's simply the highest performance, highest capacity 3.5 inch drive in the industry today. Or consider our new 7213, which sets

It's a drive Maxtor.

new value standards in 200MB-class 3.5 inch drives.

And this is just the beginning. In the coming months, you'll see even more remarkable new products.

Leadership products that will extend the limits of your application and push

the limits of technology.

Because at Maxtor, being the best in the business is a goal shared by all.

And that's a point worth driving home.

Maxtor[®]

Maxtor Corporation, 211 River Oaks Parkway, San Jose, CA 95134 1-800-2-MAXTOR.

*.050 centerline stackers.
Close, closer, closest.*



THIS IS AMP TODAY.

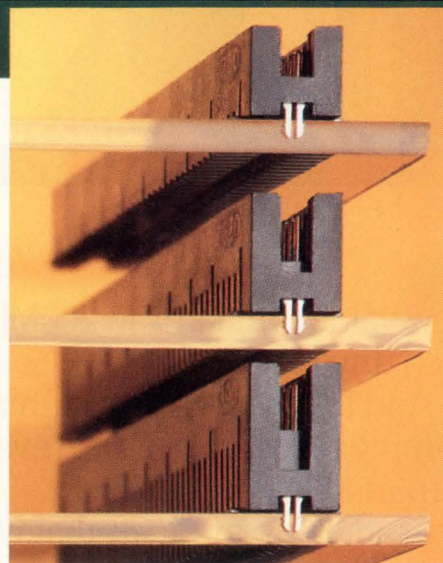

Surface-mount stack heights: .250"/.320"/.390"



AMPMODU 50/50 Grid Connectors give you a choice of parallel pcb stack heights: .390", .320", and a very close .250" (the tightest in the industry). So you can squeeze everything possible out of (or into) your design.

This surface-mount system utilizes a .050" contact grid in double row, polarized shrouded headers and receptacles, and offers our exclusive plated copper alloy holddowns. On standard .062" thick boards, the

barbed holddowns do their job without protruding through, allowing surface mounting on both sides. And holddowns are soldered during reflow, providing long-term strain relief.

Dual-beam receptacle contacts and duplex gold plating provide high reliability, in selected sizes from 10 to 100 positions. Dimensional tolerances, reference datums, holddown characteristics, and packaging support robotic application; materials are fully

compatible with IR and vapor phase reflow processing.

Ask us for more information on the AMPMODU 50/50 Grid Surface-Mount Connector System. Call the AMP Product Information Center at 1-800-522-6752 (fax 717-986-7575). In Canada call 416-475-6222. AMP Incorporated, Harrisburg, PA 17105-3608.

Hands-on FPGA Project

Taking the first steps

If you're considering designing with FPGAs, this 2-part hands-on design project will show you exactly what is involved. Part 1 covers the design and schematic entry, and part 2 covers simulation and the functioning circuit.

DOUG CONNER, Technical Editor

The fear and uncertainty of making a major shift in your design and development methodology is always compounded by tight schedules. As a result, you may be putting off designing with field-programmable gate arrays (FPGAs) because you don't know what to expect from them and you don't have the time to find out.

FPGAs and high-density PLDs provide some very attractive features. They typically give you 1000 to 10,000 logic gates you can design with for a modest cost. They make sense for designs where the product volume is anything from 1 to more than 1000.

Although it is true that in high-volume

production a masked gate array can offer substantial savings, it is also true that they offer a much larger financial commitment up front. Penalties for an inexperienced designer who makes a design mistake or a system-definition mistake is high, both financially and in time lost in making another design turn.

For a designer experienced with gate-array design, the transition to designing an FPGA should be simple. The tools to design and simulate circuits are similar. One large difference is that the penalty for making a mistake is quite low. In fact, you can view a mistake on silicon as just part of the development process, instead of a disaster.

For the large group of designers who haven't designed gate arrays, using an FPGA can be a significant change and can cause anxiety.

These designers are often designing with standard SSI and MSI (medium-scale integration) TTL and

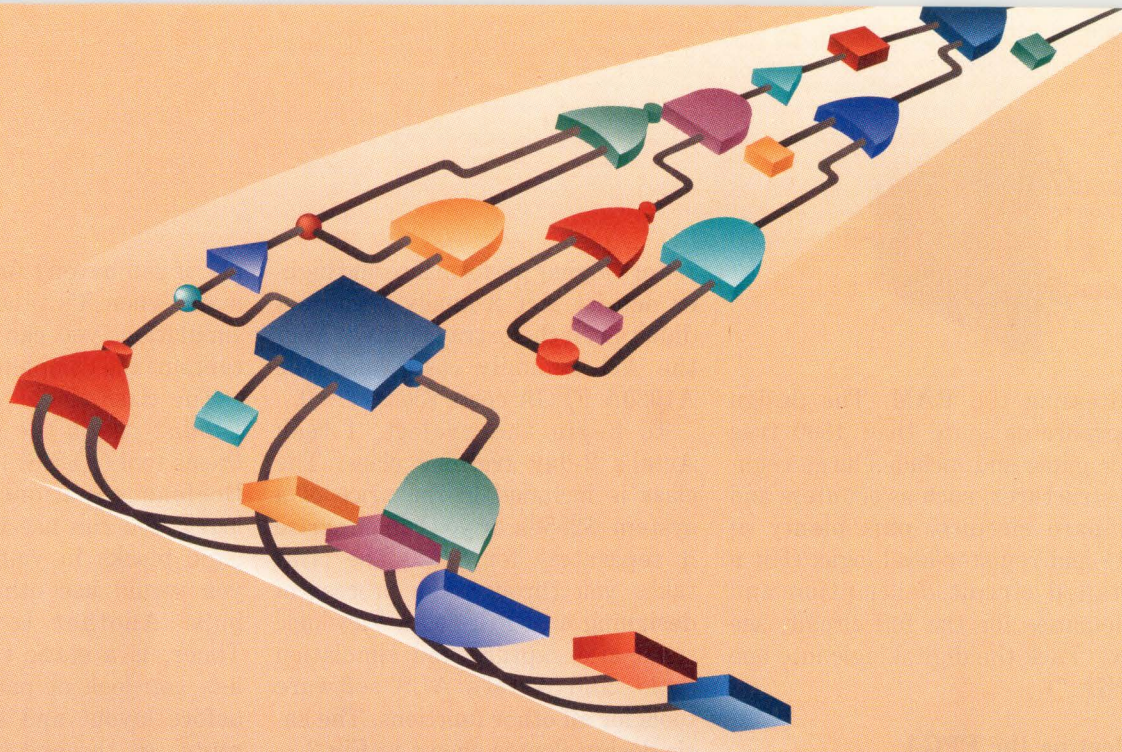

CMOS devices that interface to microprocessors, analog circuits, or both. Many have never used digital simulation. Moving to FPGAs is a step up for them. This project is for those engineers who want to know what it's like when you take this step.

I began the project with zero experience designing FPGAs and zero experience using digital simulation. My background in digital design covers standard TTL, CMOS, and ECL IC families. My experience with CAD and CAE software includes schematic capture, but with different software than I used for this project.

I chose to design a record and playback circuit (Fig 1) to get first-hand experience of designing with an FPGA. The circuit digitizes an analog signal to 12-bit resolution and stores the results in RAM. After filling the RAM with

32k words of data, it plays back the data, reconverting it to analog. The circuit is designed to work with an analog oscilloscope to capture a one-time event and play it back continuously, providing all necessary logic and control signals.

The FPGA performs all of the digital logic functions for the circuit, including successive-approximation conversion, adjustable input trigger level selection, adjustable output trigger-position control, read and write control, and

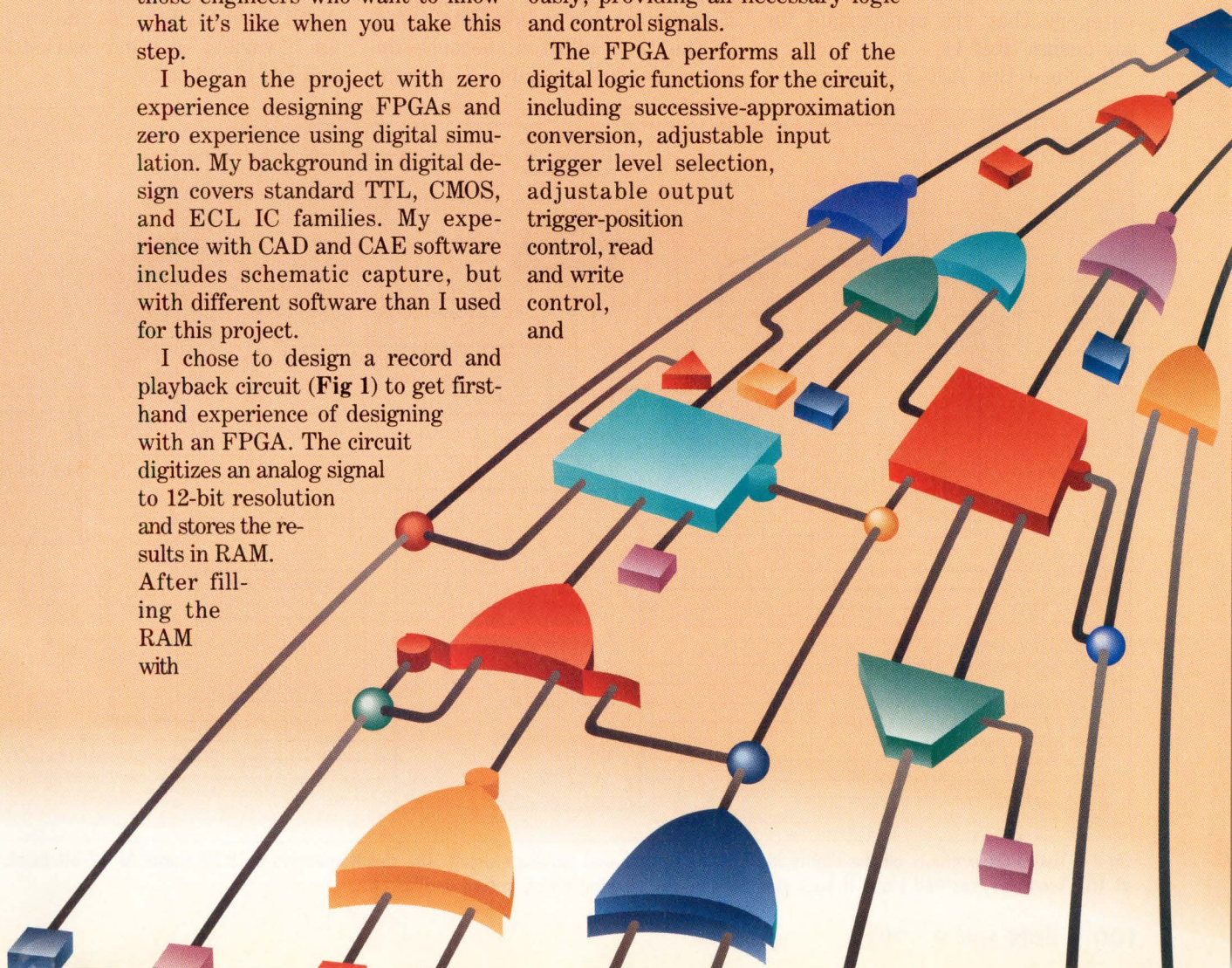

Hands-on FPGA Project

addressing the RAM. The design incorporates more than 1500 true logic gates and includes large regular structures, such as counters and compare circuits, plus plenty of gate-and register-level logic. (For a detailed circuit description and schematics for the full circuit, see **box**, "Pack the digital logic into one FPGA.")

Selecting the FPGA

I decided to use the Actel Act 1 FPGA family for my design. The choice of Actel was an arbitrary one—there are perhaps a dozen companies with products that fall into the FPGA and complex-PLD category that are appropriate for my design (Ref 1).

I chose the Act 1 family over

Actel's higher performance and higher density Act 2 family because I didn't need the extra features. And, the Act 1 family costs less—the A1020A FPGA costs \$36.25 (100).

To begin the project, I took Actel's 2-day training class. The class is included in the price of a system (\$2950), or you can purchase it separately for \$495. The class takes you through the process of designing an FPGA with Viewlogic schematic capture and simulation tools, and Actel's ALS software tools for all other functions. The basic design flow is shown in Fig 2.

The class uses canned files that you modify. For example, you'll add some components to a partially completed schematic to finish it. The class runs at a reasonably fast pace, but you won't fall behind even if you're unable to complete a step in the time allotted, because finished files are available. For exam-

ple, if you haven't finished the schematic when it's time to move on to simulation, you can use a file that contains the completed schematic.

The class also covers some tools I didn't use in the project. A synthesis tool (ALES) lets you convert Boolean equations directly into logic. You can use the synthesized logic blocks in your schematic as you would use other macro symbols. Another tool, called the Timer, is a static timing tool that lets you look at path delays, both before layout and after place and route. At the end of the class you program an FPGA that contains a timing circuit and drives a 7-segment display.

Because Viewlogic CAE tools were used in the class, I elected to use them on the project, although Actel provides libraries and support for a variety of other workstation and PC-based tools.

Illustration by Gregg Dinderman

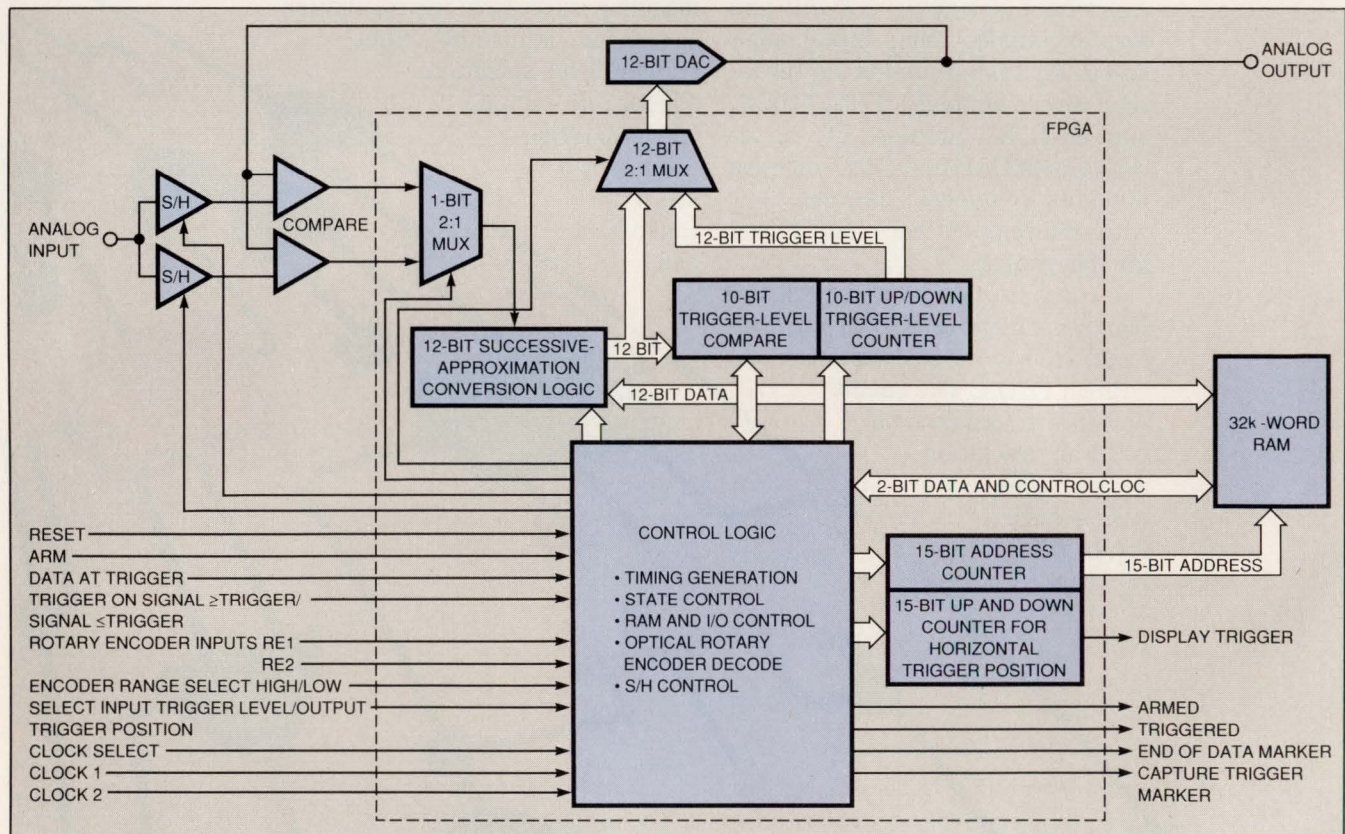

Fig 1—The FPGA contains all the digital logic of this record and playback circuit. The circuit converts a $\pm 5V$ signal to 12-bit resolution at 167 ksamples/sec and plays it back continuously for viewing on an analog oscilloscope.

The building block on an Actel Act 1 FPGA is a logic module. What you actually design with is a logic module or group of logic modules configured as a hard or soft macro. A logic module starts as a flexible uncommitted block of logic; it can perform many different logic functions depending on how its connections are programmed. Actel provides hard macros, which define the logic-module connections to perform specific functions.

The hard-macro building blocks for designing an Actel FPGA are gates, gate combinations, latches, flip-flops, multiplexers, adders, and buffers. You can also configure every I/O pin as an input buffer, an output buffer, a bidirectional buffer, or a 3-state buffer. One input pin is designated as a clock buffer. You can see many of the basic building blocks and variations on pages of the circuit schematic (see Figs 4 to 15, which begin on pg 107).

Designing with the FPGA building blocks is similar to designing with 7400 series SSI devices, except in most cases the FPGAs are more flexible. For example, 2- and 3-input AND gates are available with any or all of their inputs inverted. You can select D flip-flops with positive clear, negative clear, and so on. Every gate macro I used requires a single module. Even a relatively complex gate combination, such as the 4-input AND/OR gate shown in Fig 15, is a single module. Although there are a few combinations that require two modules, I was able to avoid using them.

Latches also require only one module, even with a clear, an enable, or multiplexed inputs. Flip-flops, however, require two modules. In cases where a latch will work as well as a flip-flop, the module savings makes the latch a better choice. For example, the circuit needed to generate the DLY shown at the bottom of Fig 6 uses two latches instead of flip-flops.

Another gate-saving consideration is to use multiplexed data inputs on both latches and flip-flops to bring 2-input gates inside them. The result saves a module. For example, the latch generating DISP_TRIG in Fig 6 effectively ANDs together DISP_TM and PLYBK.

Part way through the design, I learned that the ALS software automatically combines 2-input gates with flip-flops and latches wherever possible. Therefore, you can see cases where I've left the gate separate, such as the latch and AND gate in Fig 15. The schematic is easier to read with the AND gate separate, so I'd recommend letting the software do its job. The

end result on the FPGA is the same.

When your design calls for larger blocks (such as counters, adders, multipliers, decoders, and large registers), you've got several choices. You can use a soft macro if one exists, alter one if it's close but not quite what you need, or build what you want from scratch. The soft-macro library includes a wide selection of functions.

For example, you can select an adder with 8-, 12-, 16-, 24-, or 32-bit capacity. The soft-macro library also includes macros that are equivalent to some MSI TTL circuits. For example, the 8-bit up and down synchronous counter with rip-

Text continued on pg 104

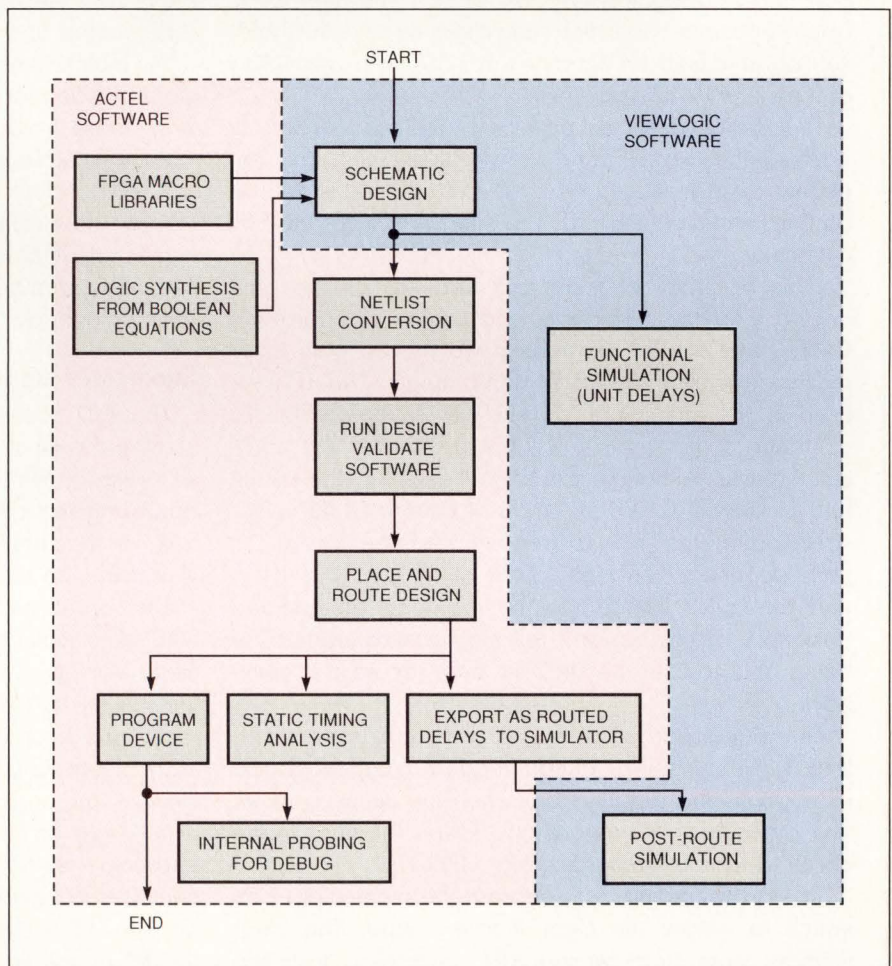

Fig 2—The total time for running netlist conversion, design validation, place and route, and exporting as routed delays took about half an hour for the design. This relatively fast turnaround lets you make quite a few design iterations in one day. The logic synthesis and internal probing for debug were not used on the project.

Pack the digital logic into one FPGA

When I decided to design an FPGA (field-programmable gate array) and write about it, I wanted to use it in a circuit with a minimum of other parts, yet I wanted the circuit to be moderately complex so that it would be a true test of designing with an FPGA. The record and playback circuit I chose packs all the digital logic into the FPGA, and the only other parts it requires are RAM and a few analog ICs (see **Figs 4 to 15** beginning on pg 107).

The top-level schematic for the overall circuit is shown in **Fig A**. The circuit uses the same 12-bit DAC and op amp for successive-approximation conversion during record and for generating the analog output during playback. Because conversion and playback use the same DAC, the gain and offset errors of the DAC and op amp do not add to the system error.

During conversion, the circuit compares the DAC's current output, converted to voltage by a high-speed op amp, with the sampled input voltage. The comparator output drives the successive-approximation logic. Two parallel paths alternately sample and compare the input against the DAC output. The alternating approach saves both the sampling time and the hold-settling time. Each bit decision takes 500 nsec, providing a complete 12-bit conversion every 6 μ sec.

The design depends on closely matched offsets in each of the two S/H and comparator paths. You can expect close matching because both comparators are on the same monolithic IC. The same is true for the S/H channels.

Gain accuracy of the circuit depends on the gain accuracy of the S/H circuit and on the comparator's CMRR. The AD684 provides a worst-case gain error of ± 5 mV over the ± 5 V input range. The LT119A used in the circuit has a minimum CMRR of 90 dB, contributing less than a 0.4-mV error over the ± 5 V input range. Although the LT119A used in the circuit has a minimum CMRR of 90 dB at dc, the CMRR is not specified at the 2-MHz frequency of the design. In fact, depending on high CMRR at frequency is risky, and generally frowned upon by knowledgeable analog designers. In this design I felt the risk was justified by being able to use one DAC for both record and playback.

The digital part of the circuit has four basic states (**Fig 5**): clear memory, armed, triggered, and playback. Playback is the default state when the circuit is reset. The other three states are also ORed together in the circuit to form the recording state (RECD).

To start recording, you depress the momentary arm switch to initiate the clear memory state. The clear memory state starts writing A/D conversions from the successive-approximation conversion into RAM, but disables the trigger until you fill the entire memory with new data, writing zeros to D13 and ones to D14. After

you overwrite the entire memory, the state changes to armed, and the circuit continues to record data until the trigger logic is satisfied. Once triggered, the state changes to triggered (TRIGD) and the circuit converts 24,000 more samples, stores them in memory, and returns to the playback state.

You set the trigger level using a rotary encoder to adjust a 10-bit up-and-down counter (**Fig 14**). The logic performs a 10-bit magnitude compare (**Fig 15**) of the successive-approximation converter output with the trigger level to determine when to trigger the circuit.

The trigger-level compare is a full-magnitude compare that tests whether the digitized input signal is greater than or equal to the trigger-level setting or less than or equal to it, depending on the input (TRIG_GE). The 10-bit range provides a trigger-level resolution of 10 mV and gives time for the magnitude-compare results to become valid while the successive approximation is finishing the last two bits.

Control logic (**Fig 10**) also generates the RAM write enable (N_WE), the RAM output enable (N_OE), and the FPGA's output enable (F_OUT). **Fig B** diagrams the basic record and playback timing.

A 12-bit shift register (**Fig 4**) generates the 12 timing states needed for the successive-approximation conversion. These timing signals are also used to control all timing-related logic in the FPGA.

A clock-select circuit lets you select between two clocks. The circuit can play back the data at a much higher rate than it can during recording, because the DAC only changes state once every 12 clock cycles during playback.

Successive-approximation conversion

The A/D conversion starts with sampling and then holding the input. The timing generator uses a 12-bit shift register to control the 12 states of the successive-approximation conversion. I created a macro, called SAR, for the conversion and used one for each bit (**Figs 7 and 8**). The details of the macro are shown in **Fig 3**.

The conversion starts at the beginning of the T1 cycle, DAC data inputs are reset to a low state, except the MSB, which is set high. The correct analog-comparator input is multiplexed to the successive-approximation logic, and near the end of the T1 cycle, the global clock signal (GCLK) clocks in the comparator's output state. At the beginning of cycle T2, the next bit, DAC2, is set high, and driving the MSB remains in the state latched in at the end of T1. The conversion process continues in a similar manner through T11 and the 11th bit. The LSB is slightly different. Near the end of T12, the FPGA will write all 12 bits to the RAM. For this reason the data for the LSB comes straight from the comparator without being clocked into the flip-flop.

When in the playback state, the DAC receives data

Text continued on pg 104

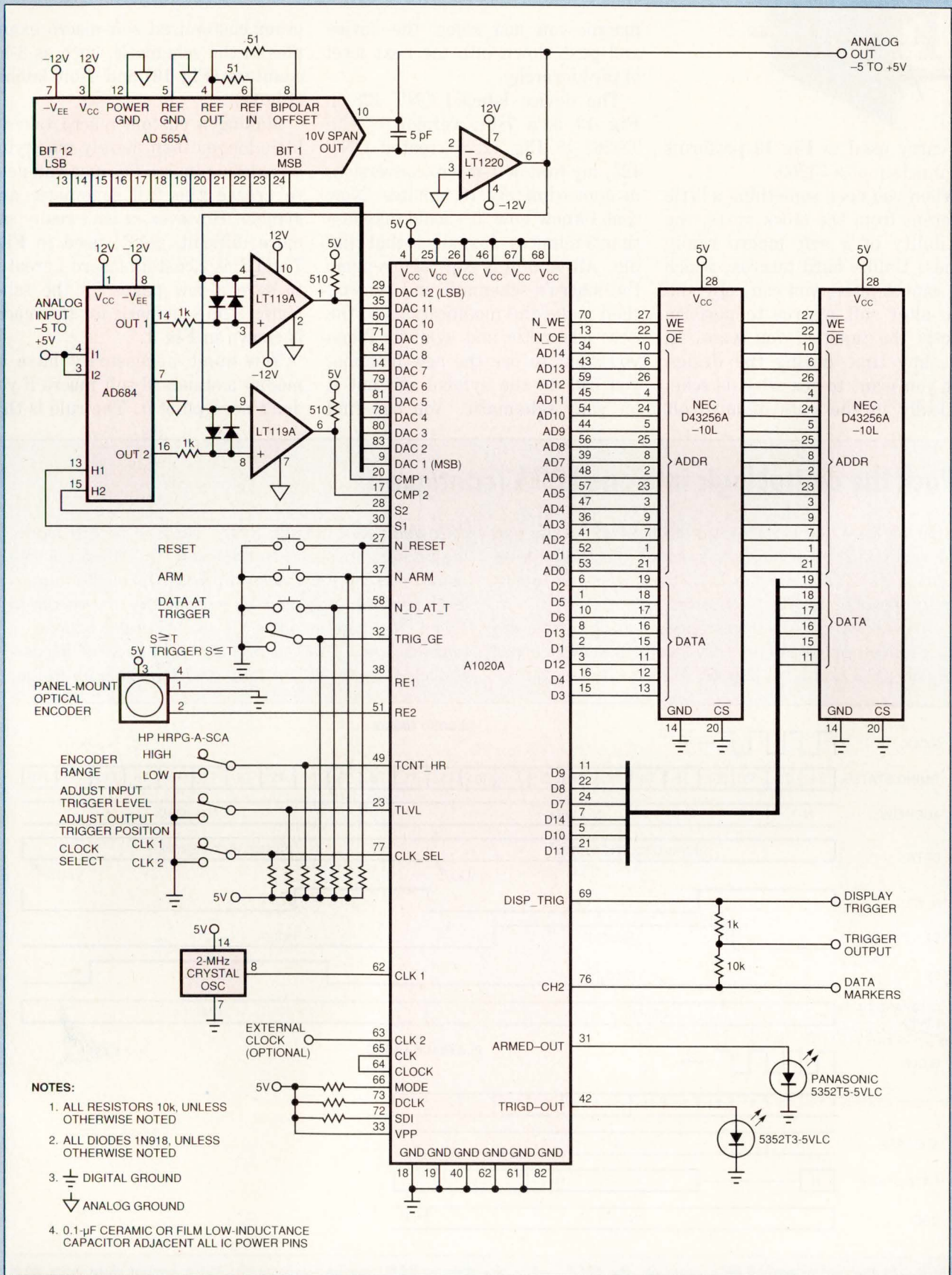

Fig A—The hands-on project was a record playback circuit.



ple carry used in Fig 12 performs the function of a 74269.

When you need something a little different from the stock parts, the flexibility of a soft macro really shines. Unlike hard macros, which you cannot alter, you can copy and then alter soft macros to perform exactly the function you want. In fact, any time during the design that you want to see what is schematically in the guts of any soft

macro, you just select the device and push down into the next level of the hierarchy.

The device labeled CNT 128 in Fig 13 is a 7-bit version of the TA269 in Fig 12. I created CNT 128, my first soft-macro conversion, in approximately 10 minutes. Now that I know how, it should take less than 5 minutes. It really is that simple. All you do is copy and rename the macro's schematic and symbol, then make the modifications to the new schematic and symbol. When you want to use the new function, you call up the symbol and put it on your schematic. You can find

other customized soft-macro examples in the schematic, such as 3-bit counters (Fig 10) and 7-bit latches (Fig 12).

Making a custom macro takes a little longer than merely modifying an existing macro because you need to create the full schematic and symbol. However, it isn't really any more difficult. SAR, used in Figs 7 and 8, is a custom macro I created to save a few pages on the schematic. The schematic for the macro is shown in Fig 3.

You don't necessarily have to modify a standard soft macro if you don't need all of it. The rule is that

Pack the digital logic into one FPGA (continued)

from the RAM and clocks it into the flip-flops at the end of cycle T12. A multiplexer switches the trigger-level setting (TL1-TL10) into the DAC input when the adjust trigger-level signal (TLVL) is asserted.

The 32k-word RAM stores conversion data from the successive-approximation conversion, plus two control signals (D13 and D14) (Fig 6). A 15-bit counter gener-

ates addressing for the RAM. While in record mode, the address counter is free running. The FPGA continuously writes the A/D results into RAM. When the trigger-level compare condition is satisfied by the incoming signal, the current value of the address counter is latched, the 15-bit up-and-down horizontal trigger-position counter is loaded, and the memory-trigger

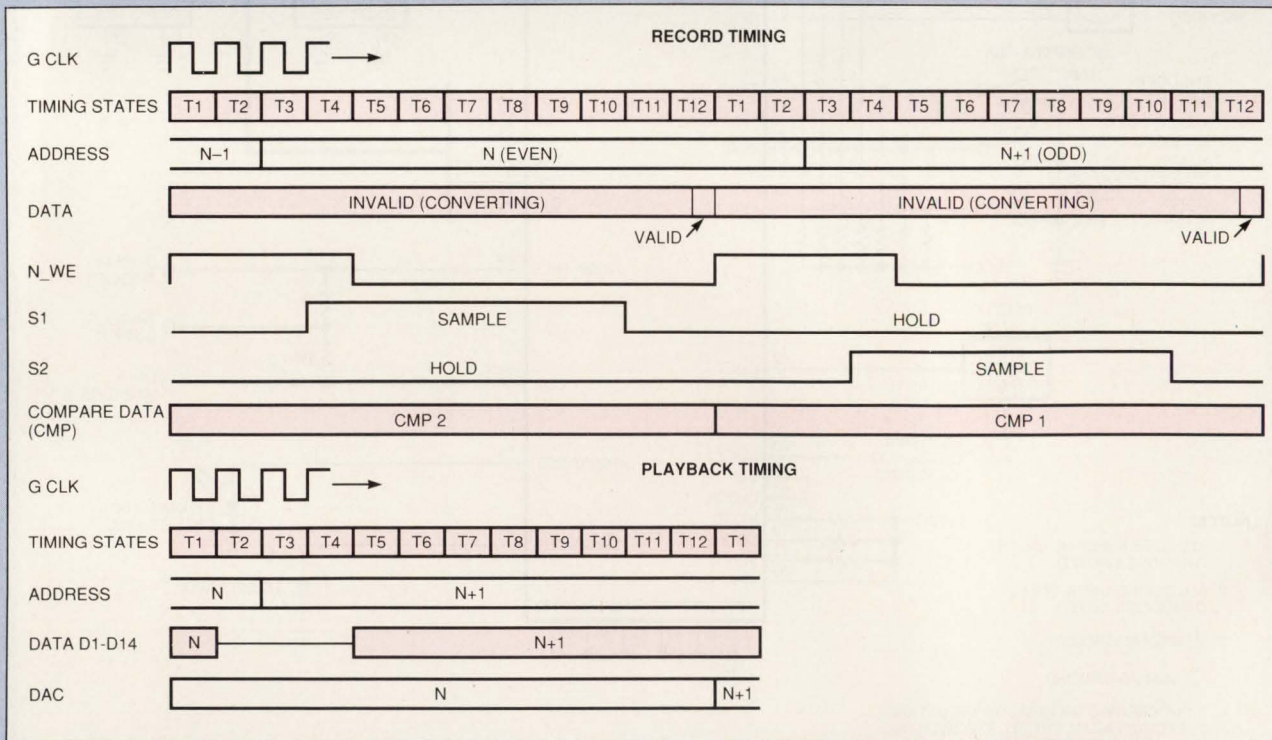

Fig B—At the end of each A/D conversion, the FPGA writes the data to RAM. During playback the FPGA latches data from RAM at the end of T12 to drive the DAC.

you can't leave any unused inputs—all inputs must be tied to a signal, V_{CC} , or ground. You may leave outputs unused; the software should remove any unnecessary logic associated with the unused outputs. The software will issue a warning whenever an output is unused, giving you a chance to verify that the omission is intentional.

You shouldn't tie unused inputs to V_{CC} or ground if it's possible to eliminate them. The flip-flops in **Fig 10** should be changed to macros without the preset. CNT4B on **Fig 6** loads all zeros. A more efficient design would just use a Clear and

eliminate the load function on the counter. Even if the change doesn't result in a module savings, unnecessary inputs tied to power and ground restrict routing flexibility, which might affect the overall performance of the circuit.

Fan-out limits are perhaps the most noticeable change from standard TTL design. The software gives you a warning for more than 10 loads, and an error for more than 24. For the special cases of nets you designate as "fast criticality" (I'll discuss criticality in part 2), the fan-out limit drops to six loads. The only exception is the global clock

signal. There is only one global clock signal on ACT 1 devices, and it can drive any number of loads.

On the surface, these fan-out limits may not seem too stringent, but you have to remember that macros are just a graphic convenience, no signal buffering occurs unless you put it inside the macro.

For example, the latch-control input of the 8-bit latch shown in **Fig 12** is eight loads, not one. You'll note a buffer in front of it. In fact, you'll see quite a few buffers scattered throughout the pages of the schematic.

Buffers are easy to add, and the software errors and warnings tell

match condition (N_MEM_TM) is set up to stop acquisition after recording 24,000 more words of data, providing 8k words of pretrigger data. The FPGA writes the display-trigger match (DISP_TM) bit to RAM (D13) to mark the capture-trigger location during playback. N_MEM_TM is also recorded in RAM (D14) to mark the beginning and end of data.

During playback, the circuit compares the address counter with the 15-bit horizontal-trigger-position, up-and-down counter. When the two 15-bit words match the display, trigger-match condition (DISP_TM) is satisfied, and the display-trigger signal (DISP_TRIG) goes high for 12 clock cycles to drive an oscilloscope trigger. Initially, the circuit sets the horizontal-trigger position counter to the capture-trigger address. Subsequently, you may change it with the rotary encoder to trigger the oscilloscope at any address.

The address counter runs continuously during playback except when interrupted by one of two events:

- When the data at trigger signal (N_D_AT_T) goes low, the address counter is disabled the next time it reaches the display-trigger match and stays disabled until N_D_AT_T goes high. With the address counter disabled, the data going to the DAC is frozen so that the DAC continually outputs the voltage at the display trigger address. You can read the dc voltage on the analog output with a voltmeter.
- When D14 from the RAM goes low, indicating the end of the data, the address counter is disabled for 16 periods of 12 clock cycles each, before repeating the data. A high signal on the CH2 output provides a marker to use on an oscilloscope to indicate the beginning and end of data.

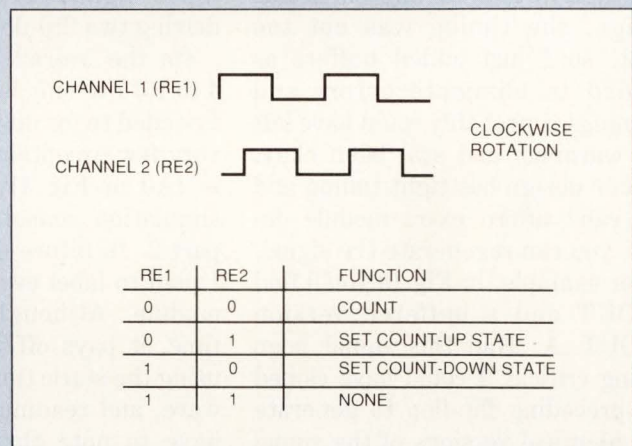

Fig C—The counter either counts up or down one cycle each time both encoder outputs are low. The count direction is determined by the previous state of the encoder.

Logic shown in **Fig 9** decodes the quadrature signals (**Fig C**) from the panel-mount, rotary, optical encoder (RE1 and RE2) into count-up and -down signals and count-enable signals. A panel-mount switch lets you select between adjusting the input-trigger level and adjusting the output horizontal-trigger position.

Because the horizontal-trigger position covers a 15-bit range (32k-word address) a high- and low-range select lets you count in increments of 1 or increments of 256 addresses. The rotary encoder provides 120 quadrature cycles per revolution, so using the low range you'd need to turn the knob 273 revolutions to scroll the full address range. Using the high range, you can scroll the whole range in just over one revolution.

Hands-on FPGA Project

you where they are needed. Nonetheless, they are a minor nuisance and one of the few blemishes to what I consider a nearly ideal design environment. Of course, the addition of buffers should remain under the designer's control and not be made automatic because buffering is more than just a cosmetic change to the schematic.

Buffers require a module and add a module delay to the signal (In part 2, I'll discuss timing in detail). Letting module fan-out increase above the warning limit can cause large time delays too. For my particular design, the timing was not too tight, so I just added buffers as needed to eliminate errors and warnings. I probably could have left the warnings and still been okay. If your design has tight timing and you can't afford extra module delays, you can regenerate the signal.

For example, in Fig 10 you'll find F_OUT and a buffered version F_OUT_A. Had this signal been timing critical, I could have cloned the preceding flip-flop to generate two identical versions of the signal without any additional module delays. The cost in this case would be an extra module because the flip-flop hard macro requires two modules, compared with the single mod-

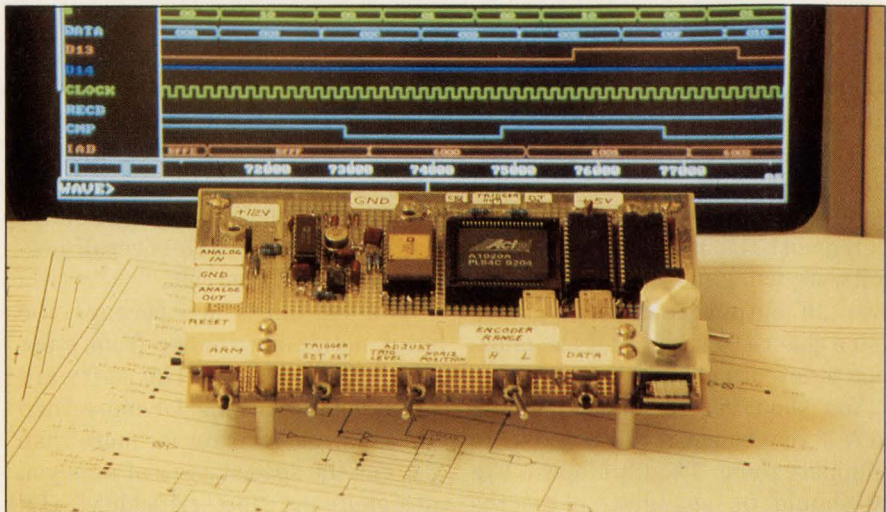

Getting from a concept to a finished circuit using an FPGA requires learning new software. Even though all the software was new to me, I learned to use it effectively for this project in less than a week.

ule for the buffer. Also it means doubling the load on the flip-flop's input signals because they'll be driving two flip-flops instead of one.

On the overall schematics (Figs 4 to 15) I've only labeled nets where I needed to for design reasons, with very few exceptions. One exception is IA0 in Fig 11. It's labeled for simulation reasons I'll discuss in part 2. In future designs, however, I plan to label every net and every module. Although labeling takes time, it pays off when simulating, using the static timing analysis software, and reading error reports. I have to note that several people recommended labeling everything, and I ignored the advice. In the end, I didn't save any time by omitting the labels. You can take my advice or learn the way I did.

After reading this far you may have come to the conclusion that designing an FPGA is not much different from designing with SSI and MSI ICs. That's my conclusion too. I spent my time during schematic design battling with system design issues and how to improve the design, not fighting with tools or wondering if the clever use of a different MSI device would make a cleaner design. In part II, I'll show you some of the bugs I caught in simulation and two that I didn't catch until I tested the circuit. I'll also present you with the chronological account of the project so you can see how much time I spent in each step.

EDN

Reference

1. Conner, Doug, "High-Density PLDs," *EDN*, January 2, 1992, pg 76.

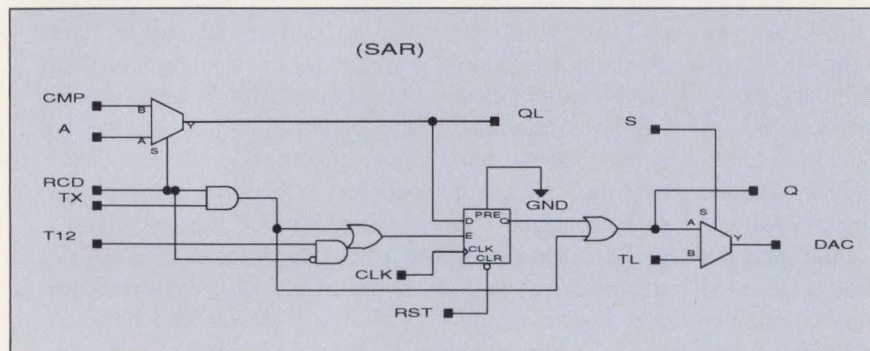
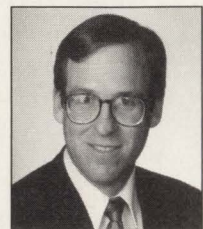

Fig 3—Creating custom macros is very simple and simplifies the schematic of the overall design. SAR is used in Figs 7 and 8 of the FPGA schematic. If you need to make changes to the design later, you need to change only the macro.

Doug Conner is a technical editor for EDN based in California. You can reach him at (805) 461-9669.



Article Interest Quotient
(Circle One)

High 482 Medium 483 Low 484

EDN-SPECIAL PROJECT

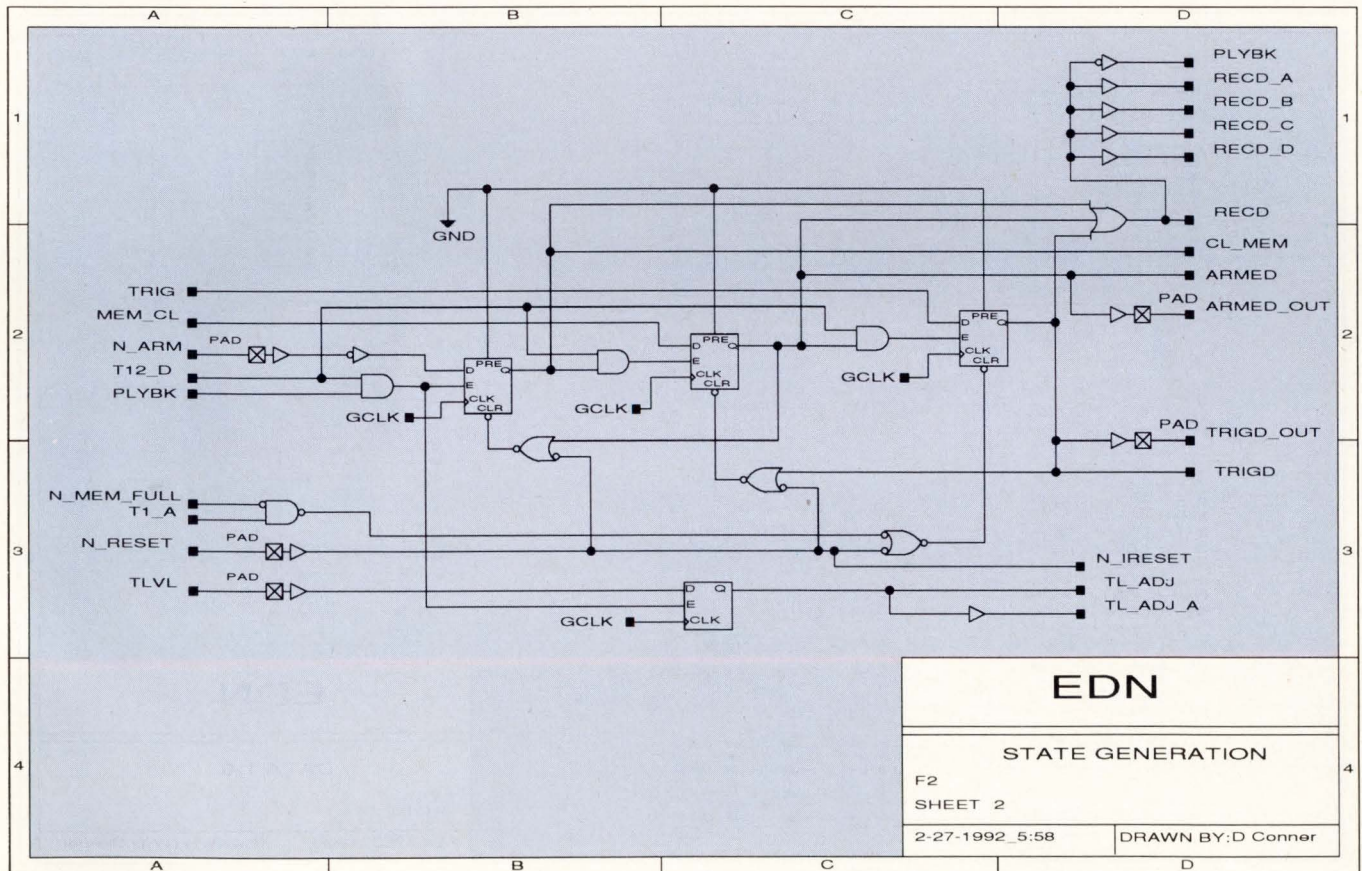
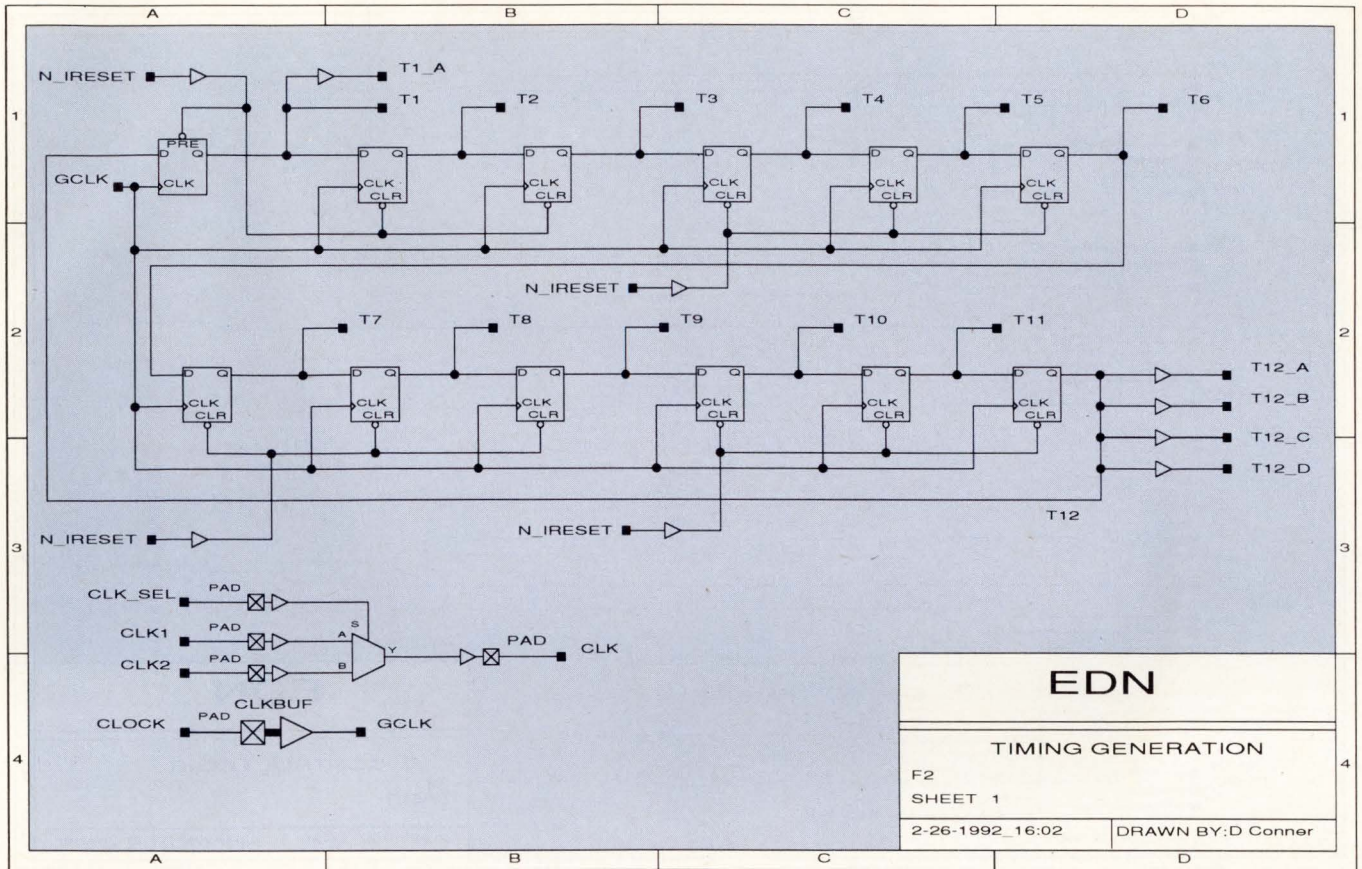

Fig 4 (top)—The schematic shows the logic for generating the 12 timing states used for all record and playback operations; Fig 5 (bottom) shows the logic for generating the playback state and the 3 record states: clear memory, armed, and triggered.

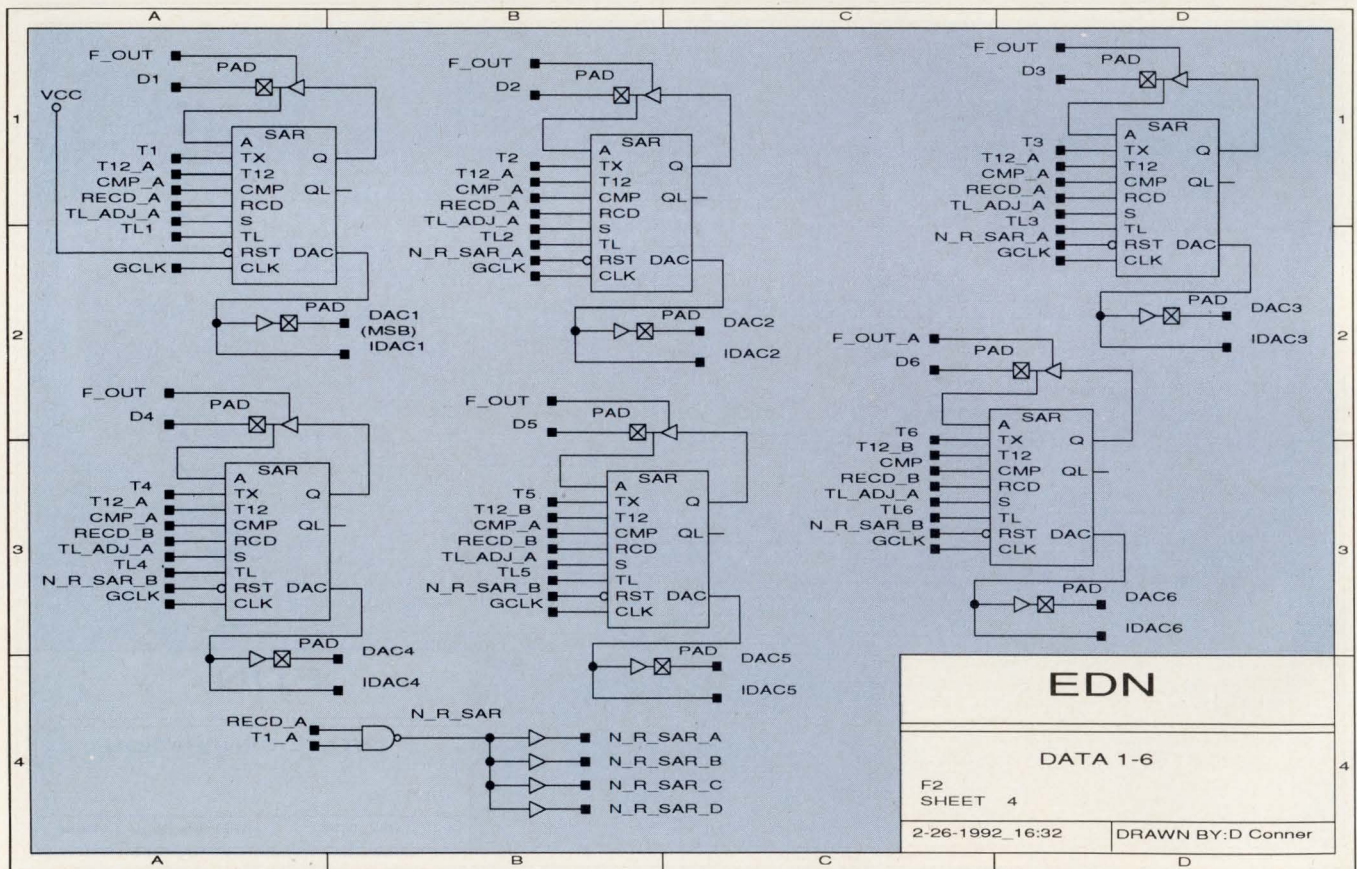
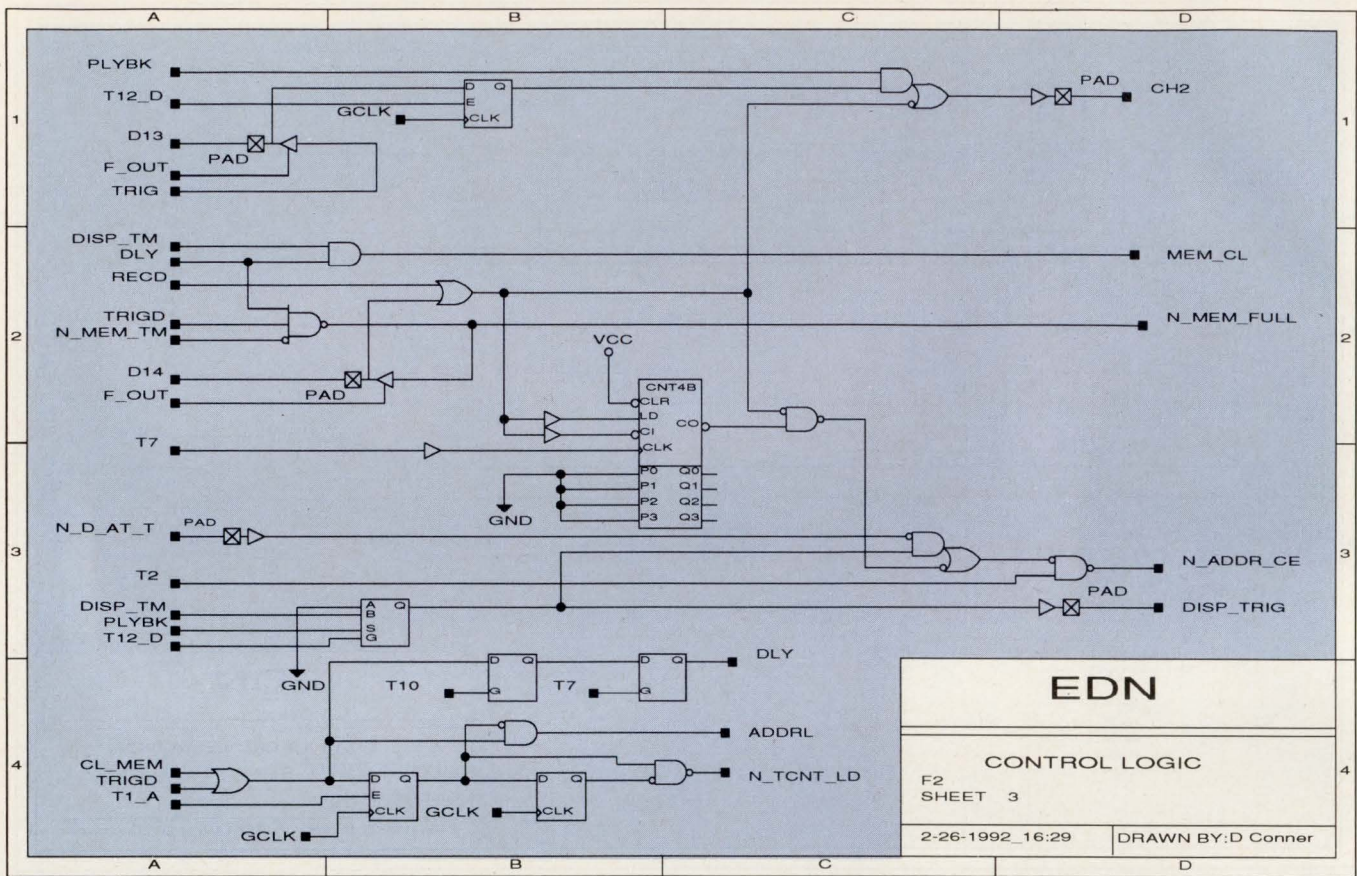

Fig 6 (top)—Logic for miscellaneous control functions is illustrated in this diagram; Fig 7 (bottom) shows the logic for the lower six data bits (see Fig 3 for SAR macro schematic).

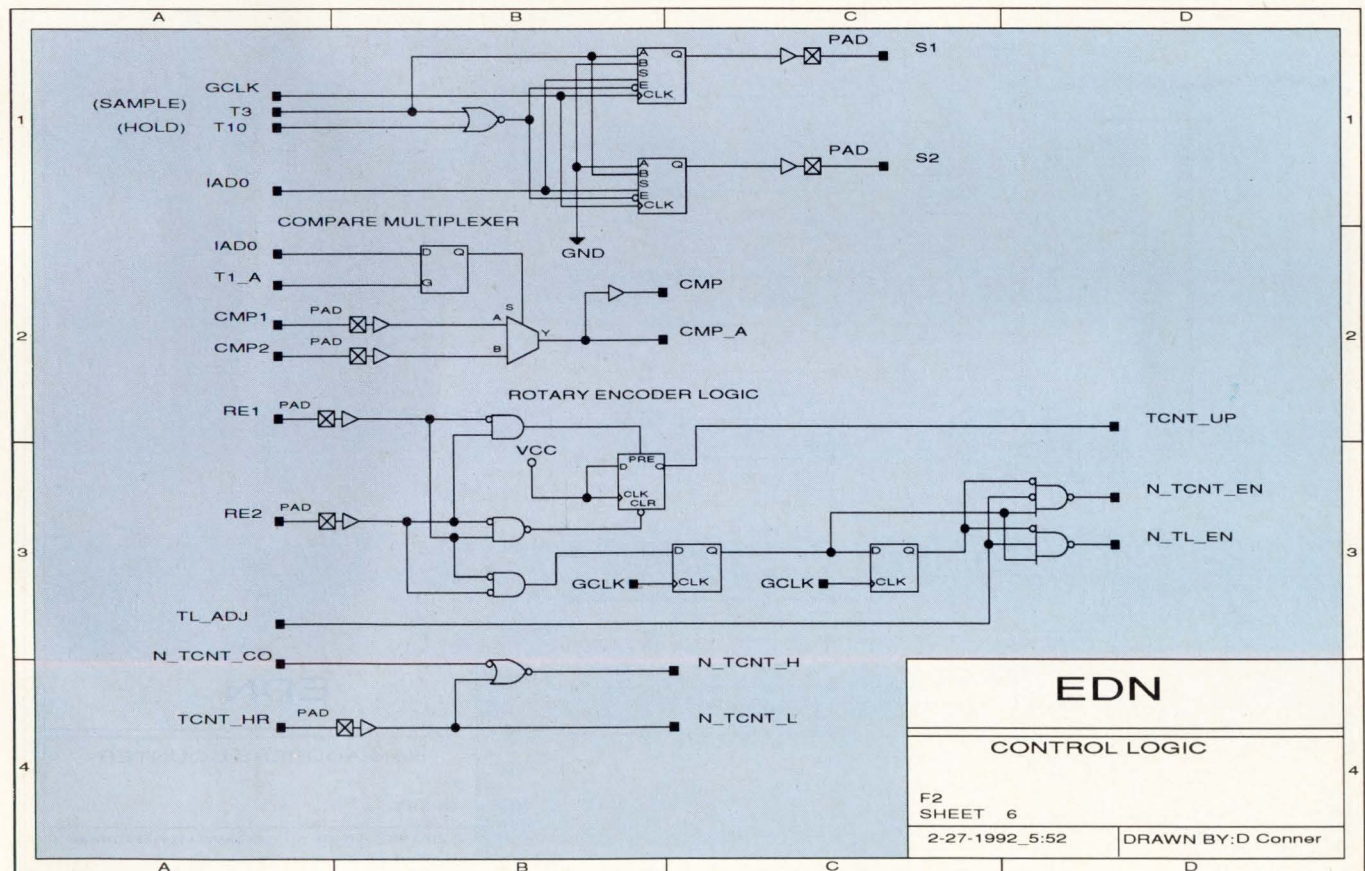
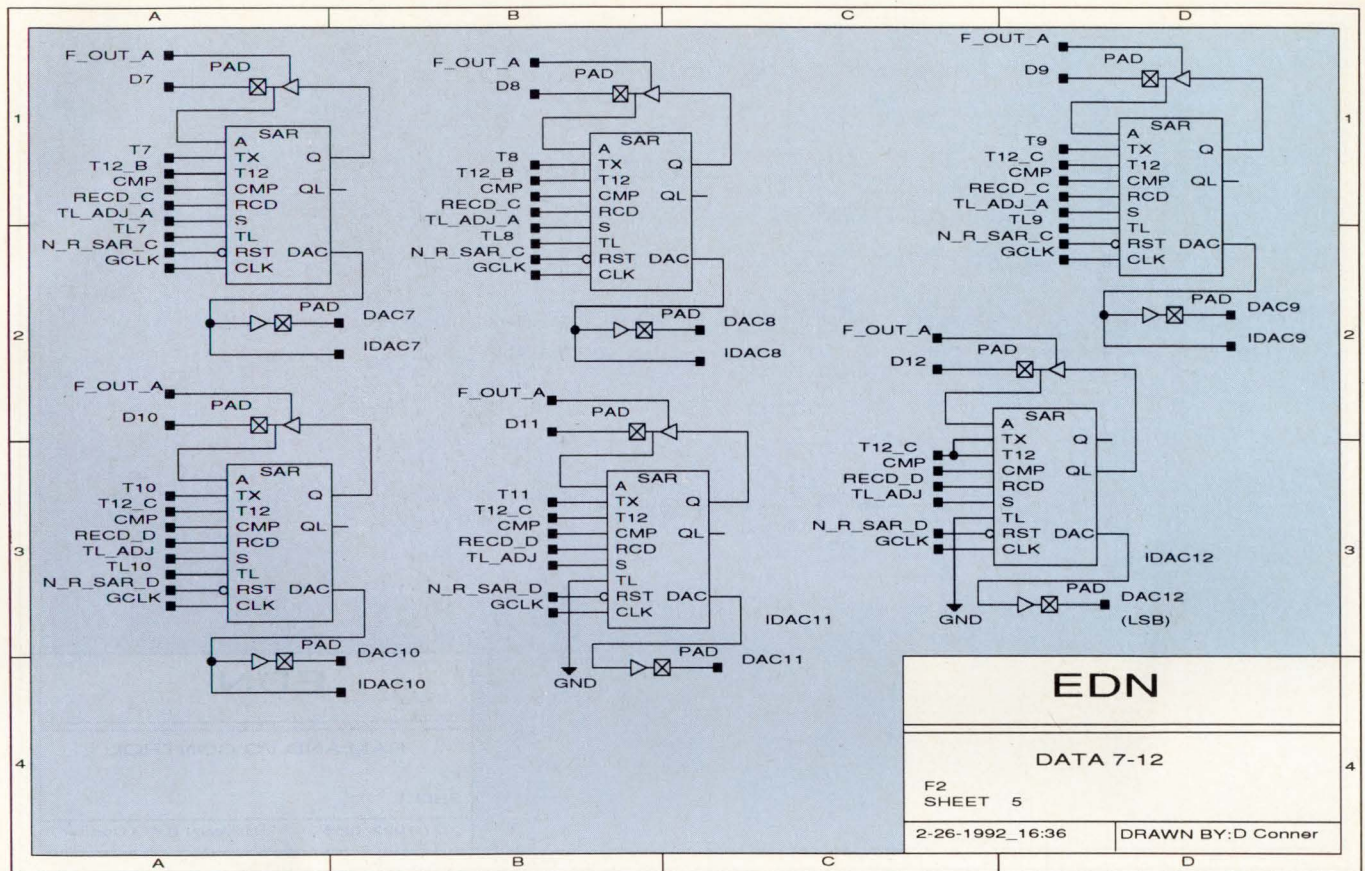

Fig 8 (top)—This schematic details the logic for the upper six data bits (see Fig 3 for SAR macro schematic); in Fig 9 (bottom), you can see the control logic for the S/H circuit, compare multiplexer, and rotary-encoder decode logic.

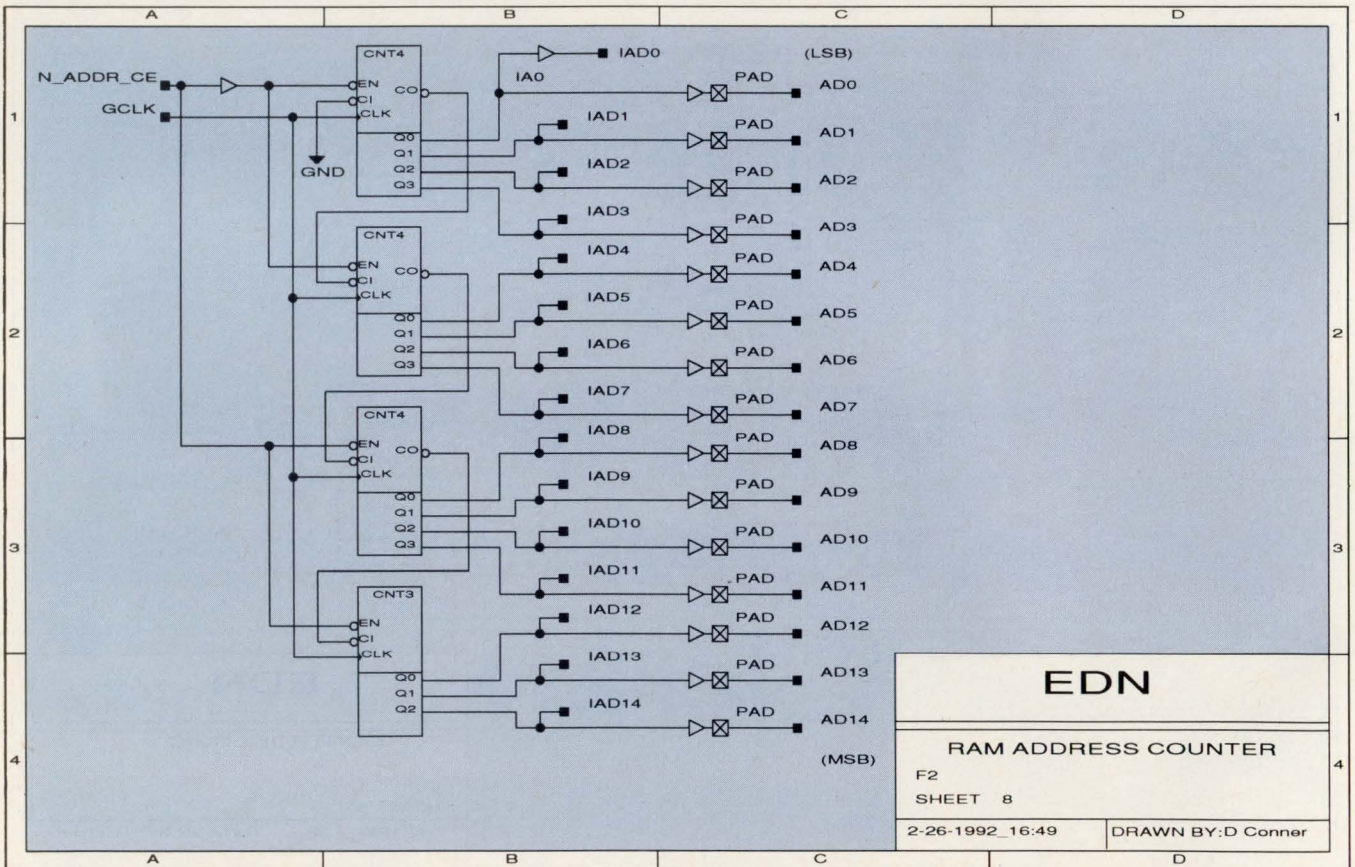
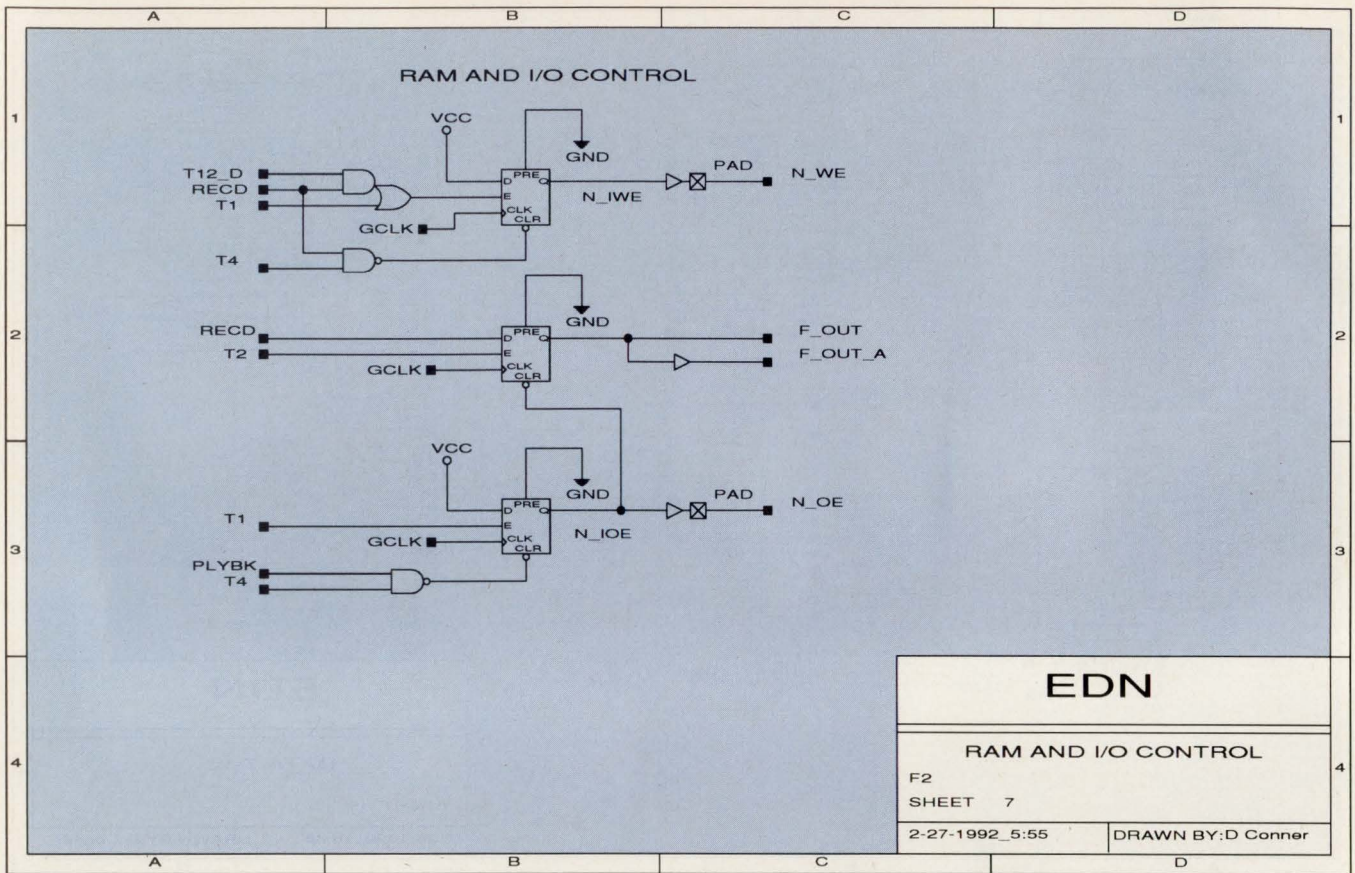
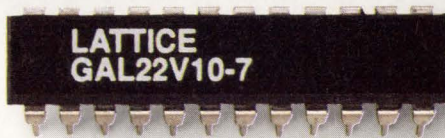
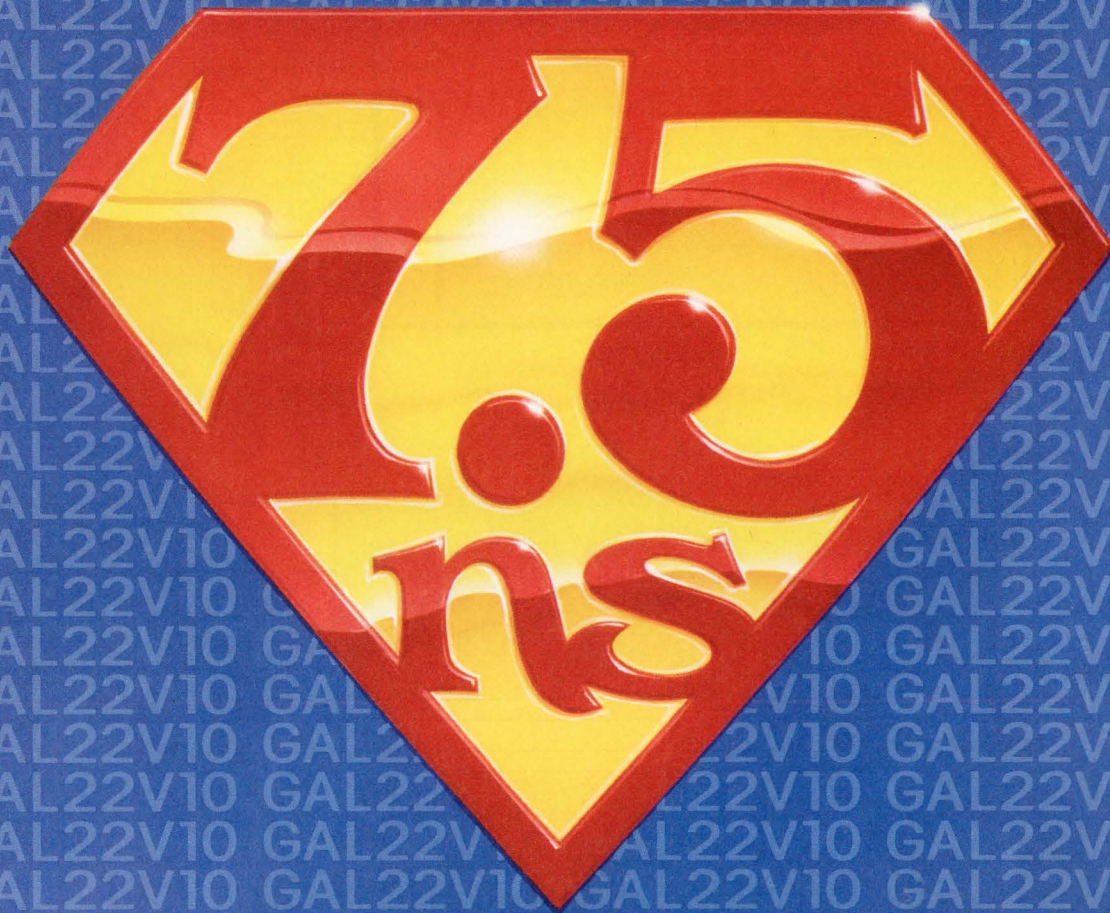

Fig 10 (top)—The schematic illustrates the write-enabled and output-enabled logic for the RAM and the output control for bidirectional data lines; Fig 11 (bottom) highlights the 15-bit counter for RAM address lines.



Our GAL22V10-7 is Super Fast.

At 7.5ns, Lattice provides the world's fastest field-programmable 22V10. Based on our high-performance E²CMOS[®] technology, the **GAL22V10-7** combines 111 MHz F_{max} with extremely low power consumption. It even supports industry standard loads and pinouts. What's more, it's 100% tested to guarantee perfect programming yields, less board rework and fewer system failures.

For free samples and a GAL[®] Data Book, call **1-800-FASTGAL** and ask for information packet 107.



Leader in E²CMOS PLDs[™]

Lattice Semiconductor Corp.
5555 Northeast Moore Court
Hillsboro, Oregon 97124

EDN-SPECIAL PROJECT

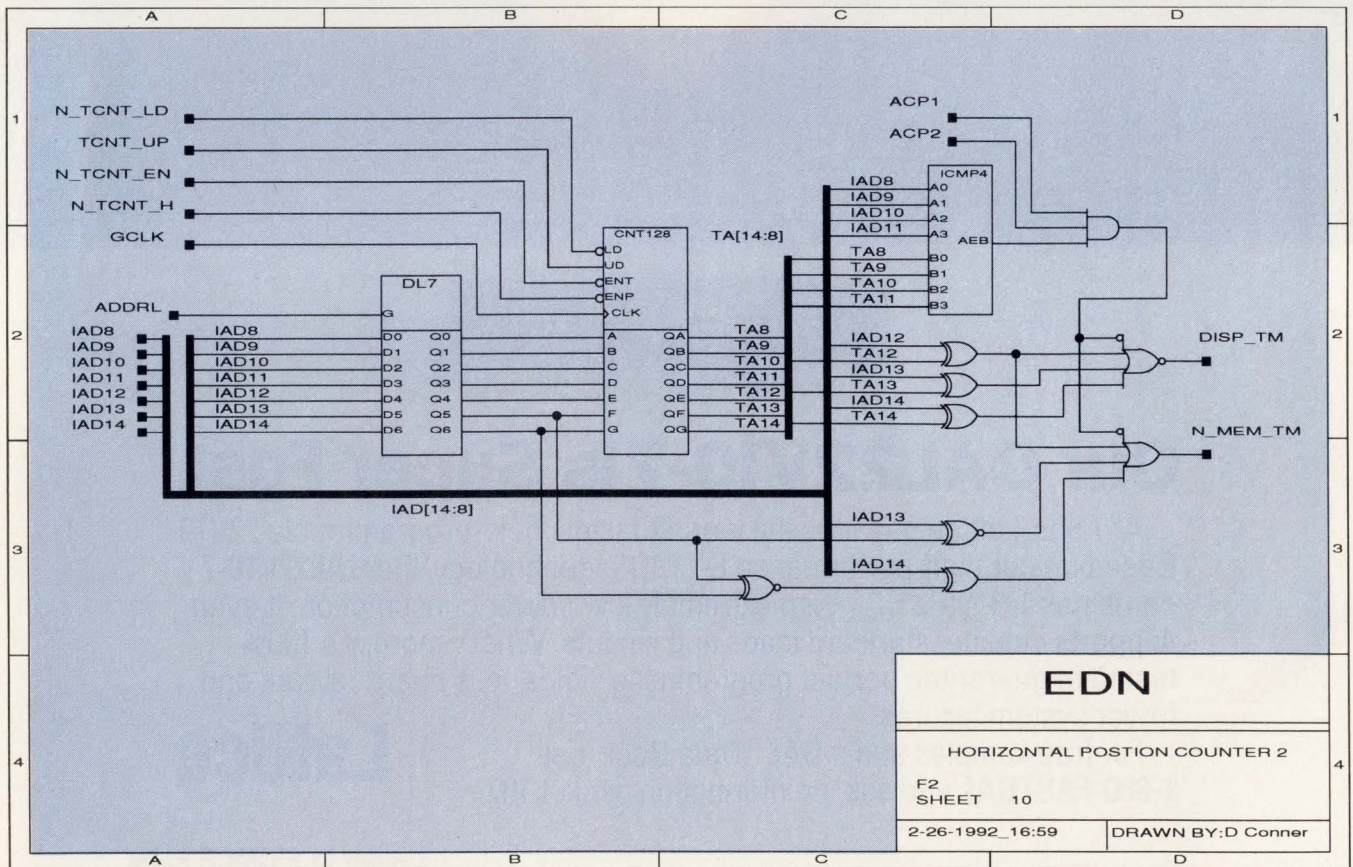
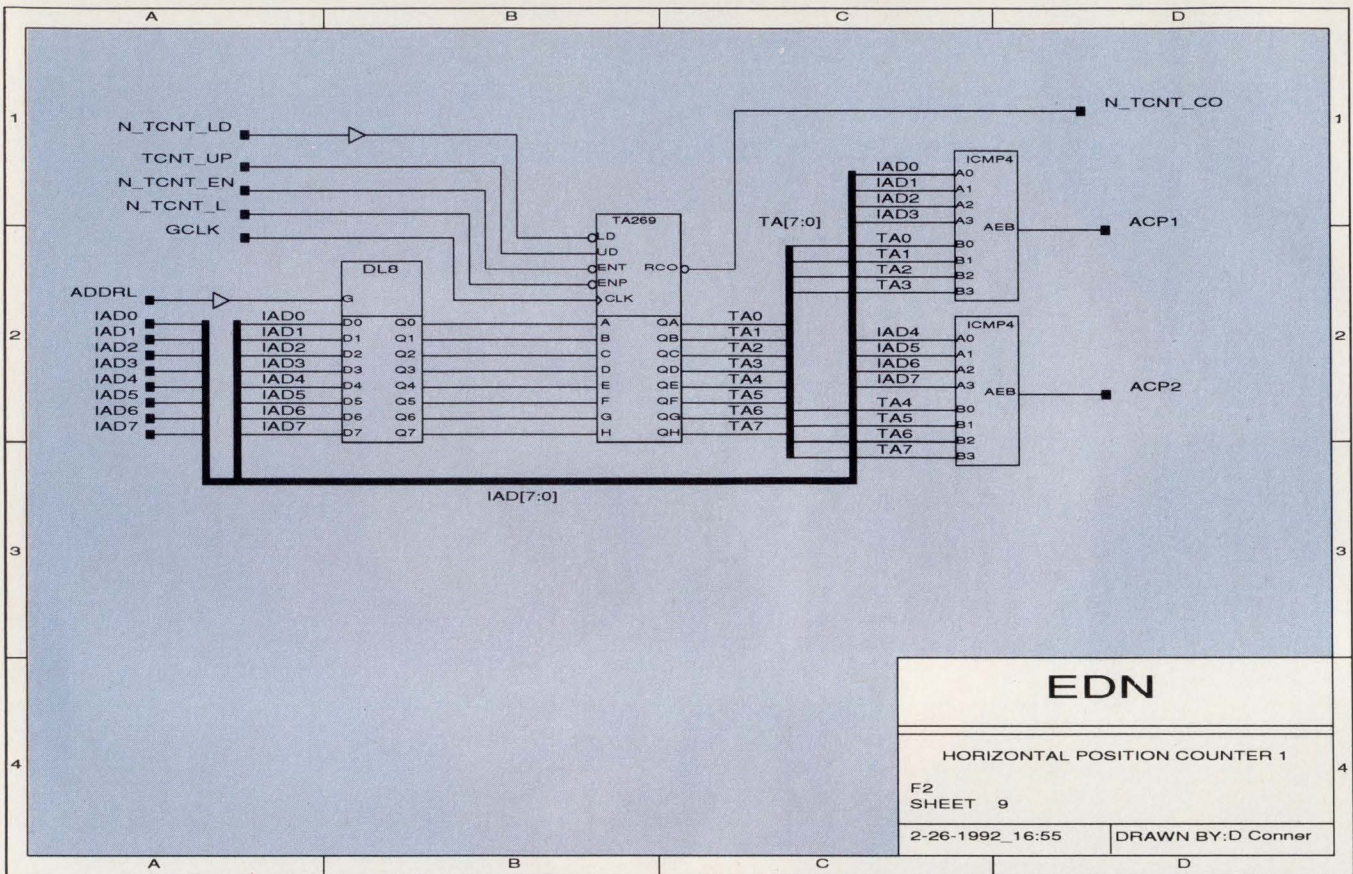

Fig 12 (top)—The lower eight bits for horizontal-output position control are illustrated here; Fig 13 (bottom) shows the upper seven bits for horizontal-output position control.

88 Pin "DAC-Per Pin" Technology



ALLPRO-88™ Universal Software Driven Device Programmer Supports Virtually Every Device On the Market!

Logical Devices offers you a truly pin driven "DAC-Per-Pin" programmer with electronic ground and Vcc, 4MHz clock, current mode source, high-speed programmable slew rate, and up to 10 amps of peak current on each pin.

All of this from a 24 pin version with logic configuration. Easily field upgradable to 88 pins. Supports the latest of low to high-pin count devices such as the AMD Mach and Altera Max devices, National "D" PALS, Signetics PLHS Series and other devices your current programmer cannot program!

Supports programming, verifying, and functional testing for PLDs, EPLDs, GALs, PALs, PROMs, EPROMs, EEPROMs, FPGAs, LCAs, MAX, MACH, ASPL, P-Sequencers, and FPLAs. ALLPRO is certified by key semiconductor manufacturers to provide excellent programming yield and reliable operation.

No copy protection in ALLPRO-88 software and updates. Buy one copy for all your units. Updates are complete and comprehensive, each version includes all supported devices.

ALLPRO-88 is supported by CUPL®, the world's most popular logic design software, with high level behavioral hardware language (CHDL), multiple PLD design, ATVG and simulation capability.

If all of this gives you an upset stomach over your Data I/O* investment, then call us for a FREE DEMO and a generous trade-in offer.

1-800-331-7766

LOGICAL
DEVICES, INC.

1201 NW 65th Place
Fort Lauderdale, FL 33309
Fax: (305) 974-8531 Phone: (305) 974-0967

* Quoted price for US delivery only, F.O.B. Fort Lauderdale, FL.
The brands or product names mentioned are trademarks or registered trademarks of their respective holders.

© 1990, Logical Devices Inc.

CIRCLE NO. 30

EDN-SPECIAL PROJECT

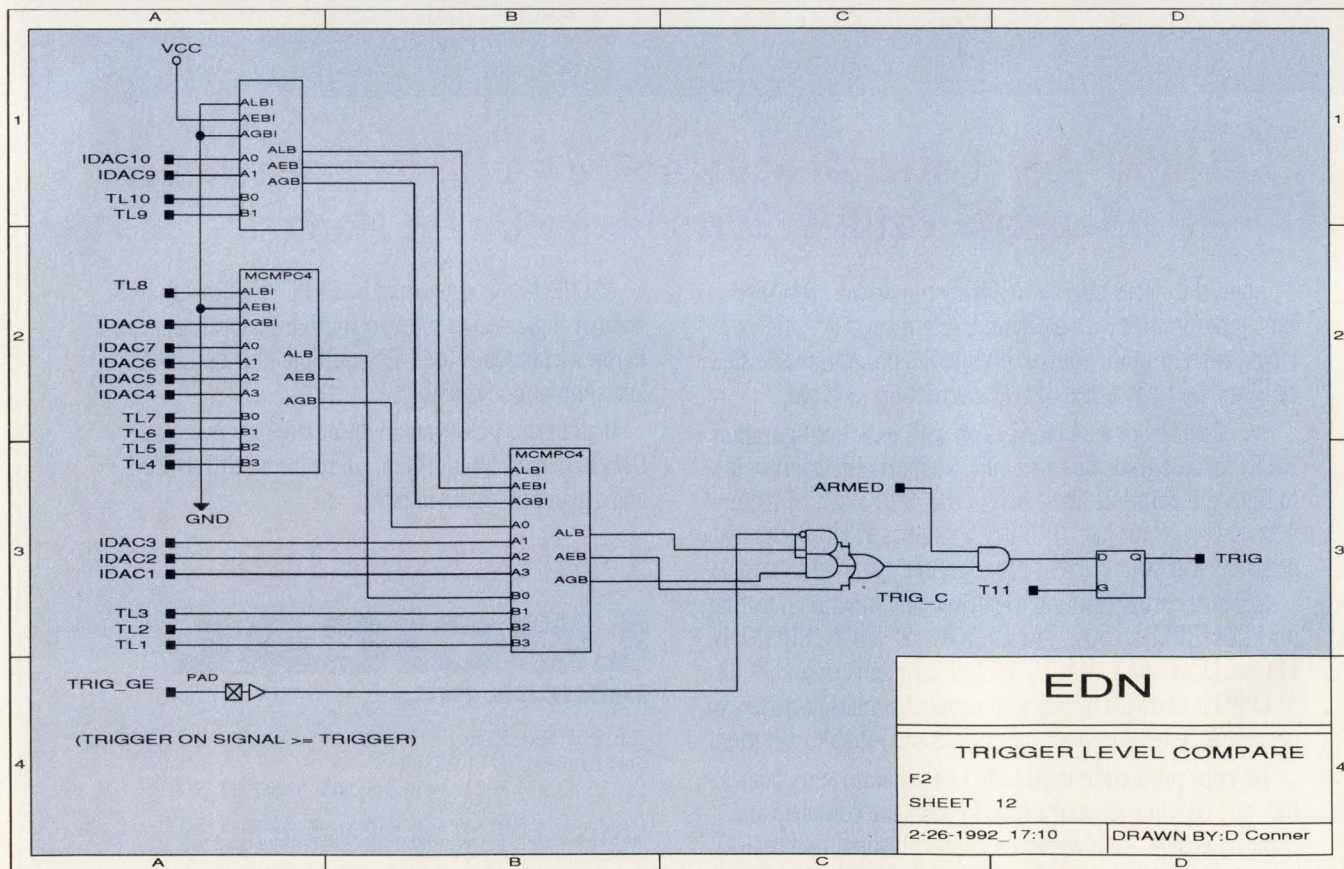
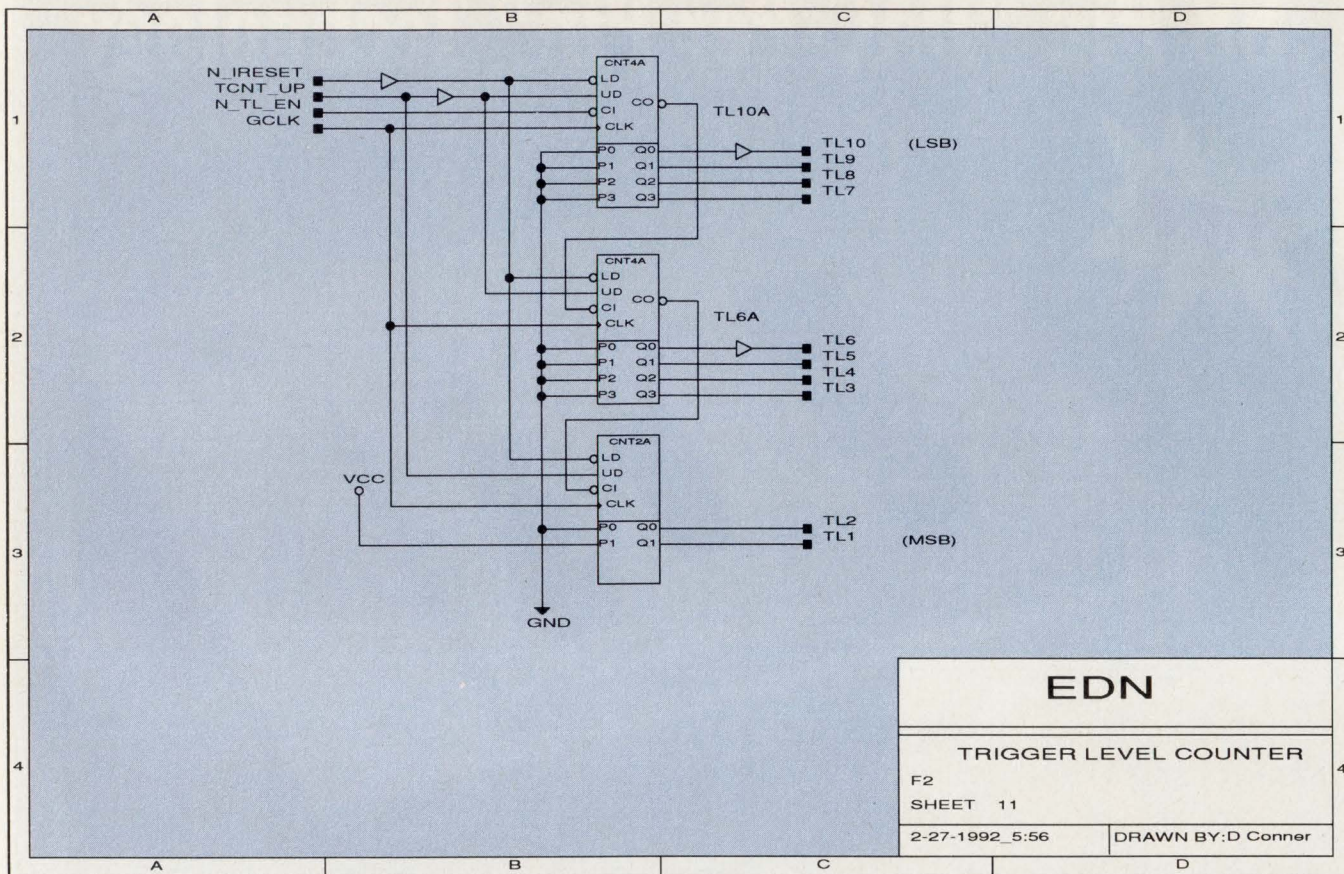

Fig 14 (top)—This schematic shows the 10-bit counter for setting the input trigger level; Fig 15 (bottom) illustrates the 10-bit magnitude-compare circuit for detecting the input-trigger event.

WHO'S
THE LATEST
MOVER
AND SHAKER
IN
4M DRAMs?



GOLDSTAR ELECTRON. A NEW

The biggest thing to shake the DRAM market is Goldstar's latest entry of a mature second-generation 4 megabit product that is faster, smaller, and lower-powered than the early market entries. The new Goldstar 4M DRAMs are designed



and built to meet or exceed the finest Japanese standards while offering all the improvements of a second-generation product. These new products are offered with access times of 60/70/80 nanoseconds in industry-standard 300 mil



NEW FORCE TO RECKON WITH.

26/20-pin SOJ surface-mount packages as well as in 20-pin ZIP, and they are also available with a low standby current rating of 200 μ A for battery-supported applications. The devices are provided in two organizations—4M x 1 and 1M x 4—and can also be ordered in 4M x 9 and 1M x 9

(3-chip) modules.

So, if you are looking for high quality, high performance 4M DRAMs for your desktops, portables, laptops and workstations, look to Goldstar.



GoldStar
ELECTRON AMERICA INC.

THE NEW 4M DRAMs

The GM71C4100A (4M x 1) and the GM71C4400A (1M x 4)

The devices in Goldstar's new generation of dynamic RAMs are provided in two organizations—4,194,304 x 1 and 1,048,576 x 4. These high-performance 4M DRAMs offer Fast Page Mode for high-speed access times as low as 60 nanoseconds. The combination of high performance with the higher density in these new devices has been achieved by the use of submicron design rules and an advanced CMOS process technology.

CMOS DYNAMIC RAMs							
ORG	TYPE NO.	MAX ACCESS TIME (ns)	CURRENT (mA)		FEATURE	PACKAGE (MIL)	
			ACTIVE	S/B			
4M x 1	GM71C4100A - 60	60	110	1	FAST PAGE MODE	20 SOJ (300) 20 ZIP (400)	
		70	100				
		80	90				
	GM71C4100AL - 60	60	110	0.2	FAST PAGE MODE/ L-POWER	20 SOJ (300) 20 ZIP (400)	
		70	100				
		80	90				
1M x 4	GM71C4400A - 60	60	110	1	FAST PAGE MODE	20 SOJ (300) 20 ZIP (400)	
		70	100				
		80	90				
	GM71C4400AL - 60	60	110	0.2	FAST PAGE MODE/ L-POWER	20 SOJ (300) 20 ZIP (400)	
		70	100				
		80	90				
1M x 1	GM71C1000 - 60	60	90	1	FAST PAGE MODE	20 SOJ, 18 DIP (300) (300) 20 ZIP (400)	
		70	80				
		80	70				
	GM71C1000L - 60	60	90	0.2	FAST PAGE MODE/ L-POWER	20 SOJ, 18 DIP (300) (300) 20 ZIP (400)	
		70	80				
		80	70				
256K x 4	GM71C4256A - 60	60	90	1	FAST PAGE MODE	20 SOJ, 20 DIP (300) (300) 20 ZIP (400)	
		70	80				
		80	70				
	GM71C4256AL - 60	60	90	0.2	FAST PAGE MODE/ L-POWER	20 SOJ, 20 DIP (300) (300) 20 ZIP (400)	
		70	80				
		80	70				

With multiplexed address inputs, these new 4 megabit chips fit into the same small packages as the 1 megabit devices, providing the user with four times the DRAM capacity in the same space on a board. The devices are offered in the new industry standard 300 mil SOJ and 400 mil ZIP packages that are compatible with widely available automated testing and insertion equipment.

CHUNG JU—A NEW WORLD-CLASS FACILITY

Goldstar's high-density DRAMs are processed in its two new state-of-the-art Chung Ju wafer fabs. For more than a year this facility has been turning out millions of 1 megabit DRAMs on an advanced CMOS triple-poly double-metal process. And now with its significant capability for processing 6-inch wafers to submicron design rules, Chung Ju has added a mega-volume

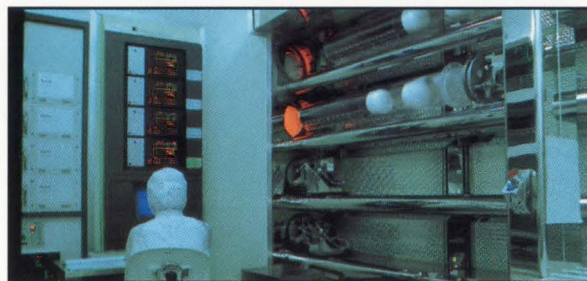

production line of 4M DRAMs to meet the growing demands of the company's worldwide customer base.

A company's investment in product and facility is significant as a measure of its commitment to its customers. And the resolve shown by the \$30 billion Lucky-Goldstar group by building and expanding the Chung Ju facility is a measure of our commitment to you in the markets we serve.



GoldStar
ELECTRON AMERICA INC.

Goldstar Electron America, Inc., 3003 North First Street, San Jose, California 95134-2004.

Phone: (408) 432-1331. FAX: (408) 432-6067

KOREA

GOLDSTAR ELECTRON CO., LTD.
Tel: 02519-2854
Fax: 02-519-2800

HONG KONG

GOLDSTAR (H. K.) LTD.
Tel: 524-2040
Fax: 868-1434, 845-9416

JAPAN

GSEN JAPAN OFFICE
Tel: 03-224-0123
Fax: 03-582-7948

SINGAPORE

GSEN SINGAPORE OFFICE
Tel: 65-226-1191
Fax: 65-221-8575

TAIWAN

GSEN TAIWAN OFFICE
Tel: 02-703-2295
Fax: 02-703-7470

GERMANY

GOLDSTAR Deutschland GmbH
Tel: 49-2154-492172
Fax: 49-2154-4336



Signal creation and analysis enters a new domain: the real world.

WaveForm DSP™ closes the loop from lab to math model to the outside world. It is a data acquisition, signal analysis, and waveform creation tool, all in an easy-to-use Microsoft Windows®-based program.

Waveforms can be acquired or created many different ways. Draw them, build them with the library, input math formulas, share data from programs like Excel®, or even get a real signal from a digitizing storage oscilloscope.

WaveForm DSP also has powerful math functions for combining, concatenating and

manipulating signals, with options for signal filtering and much more. Accuracy is assured because calculations are done in double precision (64 bit) math.

The signals you create can be used to drive an arbitrary function generator capable of reproducing any imaginable waveform. Or they can be output to printers, plotters, or saved as files for other applications.

Multiple windows can be open at once, and they can all be interactive. Imagine being able to change a waveform in the frequency domain and see

the results in a time domain plot on the same screen — with just the click of a mouse. Or change a signal going to a test and see a graphic display of the analyzed results.

If you haven't been comfortable with digital signal processing before, you will be now. And if you never thought of using arbitrary generators before, get ready for a whole new spectrum of possibilities.

To try WaveForm DSP, call 1-800-223-9885.

© Copyright 1992 Wavetek Corporation.
Wavetek and WaveForm DSP are trademarks of Wavetek Corporation.
Microsoft, Microsoft Windows and Microsoft Excel are trademarks of Microsoft Corporation.

For Literature Circle #145

For Demo Circle #146

WAVETEK

You Design Actel FPGAs You Do A PLD. But Th

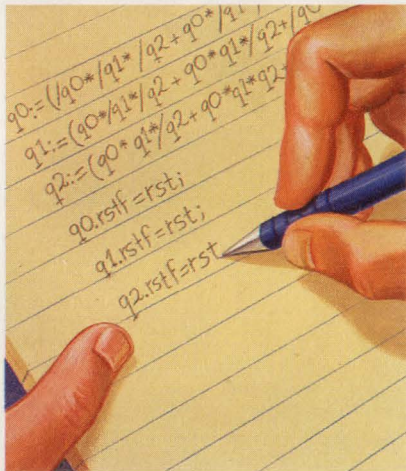

Use PLD Tools.

You design Actel FPGAs using the same tools as you would a PLD: ABEL™, CUPL™, LOG/iC™ and PGADesigner™. But that's where the similarity ends.

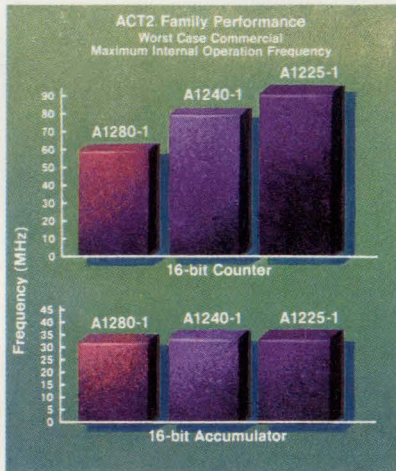

Fast. Fast. Fast.

Our FPGAs are real speed demons. Whatever application you may be working on, our parts will give you the kind of performance you're looking for.

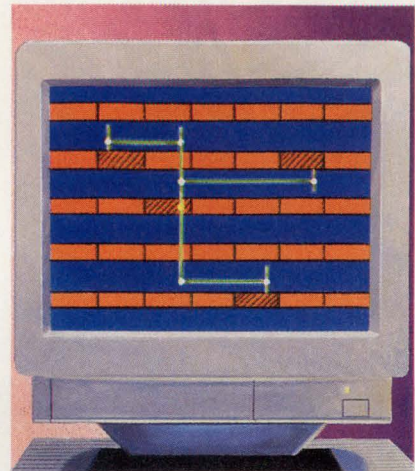

100% Automatic Place And Route.

Coupled with your PLD tools, Actel's Action Logic™ System (ALS) software lets you create your own FPGAs—using a 386 PC or workstation—right at your own desk. With Auto Place and Route that's proven in thousands of applications.

Announcing A Simple Way To Get From PLDs To FPGAs.

If you're a PLD designer with an interest in fast, flexible FPGAs, but you think you don't have time to learn new design techniques, we'd like to change your mind.

First of all, you don't have to give up your existing PLD design tools or Boolean equations. Actel's ALES™ 1 program translates the output of PLD

tools like CUPL™ and LOG/iC™ into logic optimized for our ACT™ devices. ABEL™ 4.0 includes optimization for Actel devices. Entire FPGA designs can be developed with PGADesigner™.

Actel devices offer everything you want in an FPGA. Like high I/O and flip-flop counts. And 100% automatic place

and route gets you to market fast.

Once your FPGA is designed, our Action Logic™ System (ALS) converts the captured design into a completed device in minutes. To give you true, high-density, field-programmable, channeled gate arrays.

Other FPGA manufacturers fall short on design verification. Our exclusive Actionprobe® diagnostic tools, give you 100%

observability of internal logic signals. So you don't have to give up testability for convenience.

It's never been easier to make your innovative designs a reality. We offer you a complete family of powerful FPGAs, like the A1010 and A1020, available in 44, 68 and 84 pin PLCC versions and implementing up to 273 flip-flops or up to 546 latches. And the first member of our ACT 2 family, the power-

FPGAs The Same Way The Similarity Ends There.

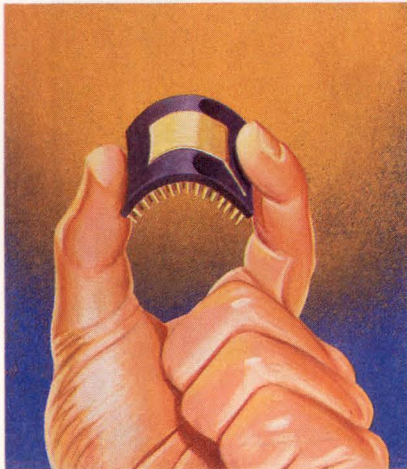

More Flexibility And Capacity.

Designing with Actel FPGAs gives you more freedom than you ever imagined. More gates. More flip-flops. More I/O. In fact, our new A1280 is the largest FPGA in the world.

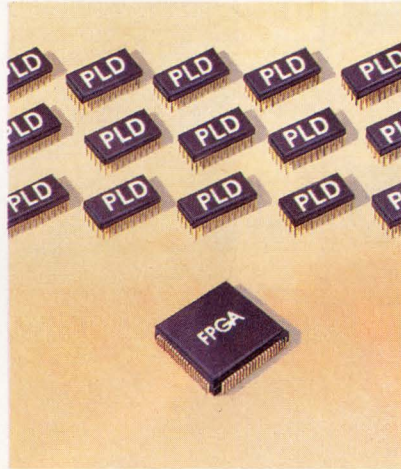

Small Footprint.

Actel FPGAs give you far more gates per square inch. As much as ten times as many as the densest PLDs. That can save a lot of real estate.

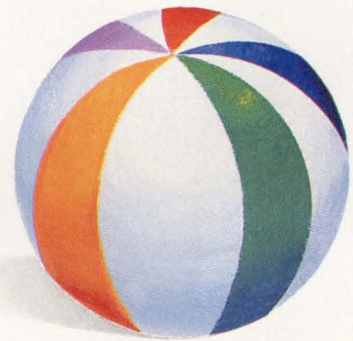

More Fun.

Designing Actel FPGAs is so simple that you'll have more time to do the things that made you want to become an engineer in the first place. Or just relaxing. You've earned it.

ful A1280. With 8,000 gates, up to 998 flip-flops, and 140 I/O pins, it's the highest capacity FPGA today. And our A1240-1 is the fastest. In the A1240-1, 16-bit counters run at 75 MHz, 16-bit accumulators at 33 MHz. Enough capacity and speed to handle almost any application. The superior speed,



The FPGA Design Guide

capacity, and auto place and route capabilities of our FPGAs are made possible by Actel's revolutionary PLICE® antifuse programming element. The advanced technology that makes our family of FPGAs an ideal way to unleash your engineering creativity. Call 1-800-228-3532 for your free FPGA Design Guide.

Broad Family With High Capacity

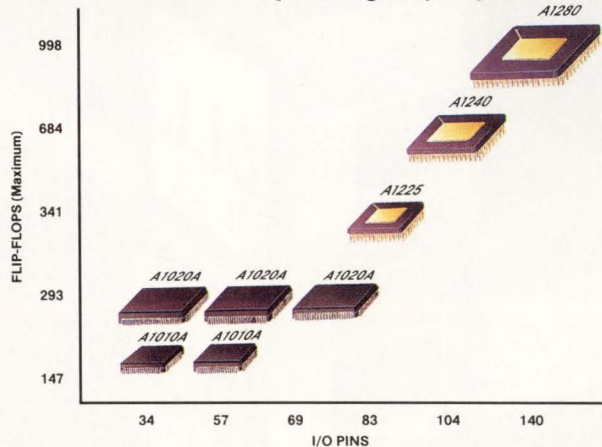

Risk-Free Logic Integration

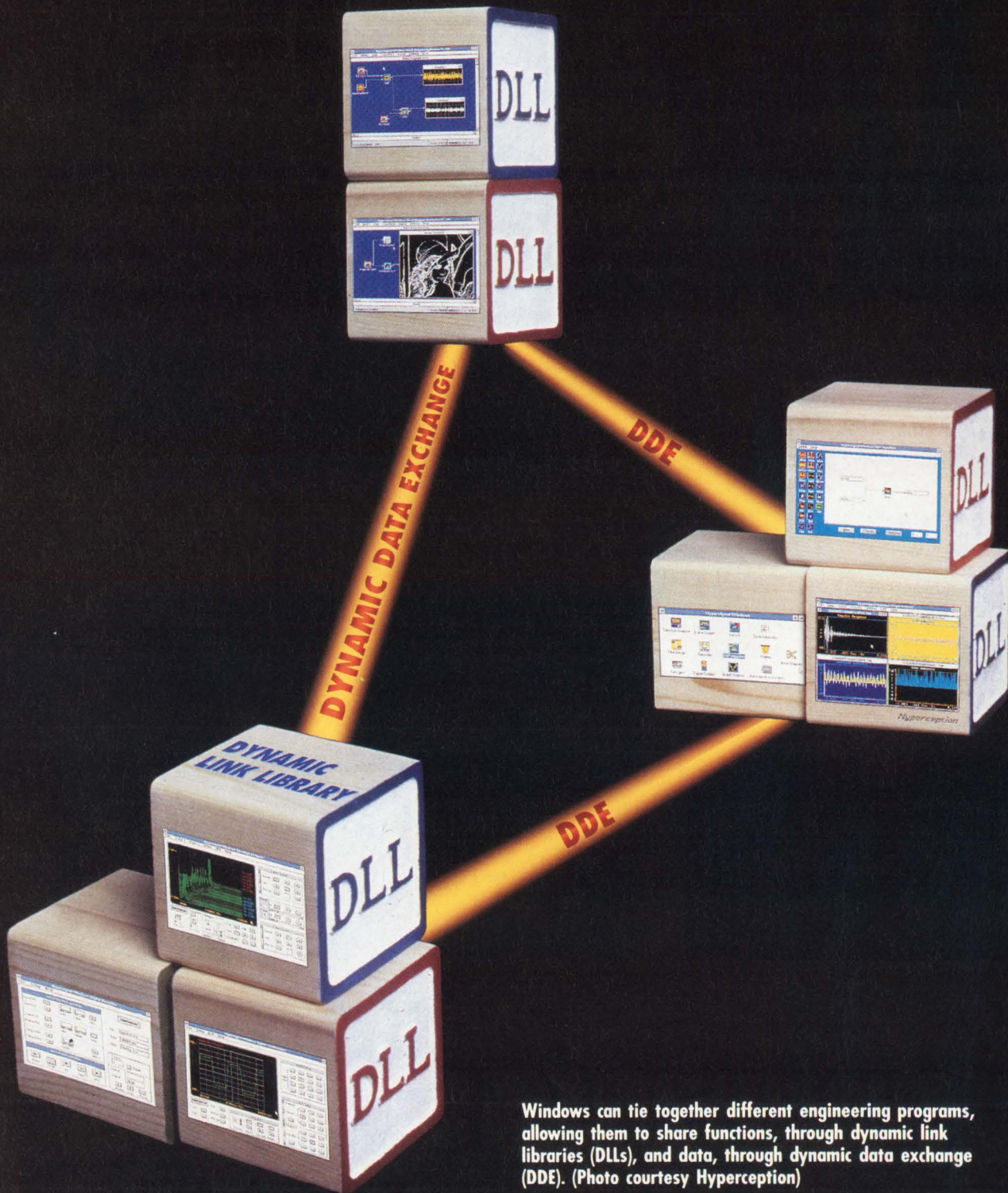

Windows can tie together different engineering programs, allowing them to share functions, through dynamic link libraries (DLLs), and data, through dynamic data exchange (DDE). (Photo courtesy Hyperception)

Windows and engineering software

As Microsoft keeps telling us, millions of PC users have bought copies of Windows 3.X, making it, in terms of units sold, the most popular multitasking operating system in the world. But by the same reckoning, DOS's EDLIN is then the most popular word processor in the world. Whether many people who have bought those copies actually run Windows is open to question.

Certainly, engineers have had little use for Windows until recently because few engineering programs were available in Windows versions.

That lack of Windows engineering software is changing rapidly. So rapidly, in fact, that any list EDN could compile and publish would be obsolete the day it appeared in print (Ref 1). Rather than offering a list, this report will look at Windows' facilities and how those facilities suit—or do not suit—the kinds of programs engineers run. In other words, is Windows really all the multitasking, virtual-memory operating system that engineers require for their new 386/486 PCs?

■

Suddenly, powerful, fast 386/486 PCs tagged with breathtakingly low prices are here. These PCs have more than enough horsepower to run formidable engineering programs under a multitasking, virtual-memory operating system. The question is, does Windows 3.X have what it takes?

■

Charles H Small, Senior Technical Editor

The new inexpensive 386/486 PCs are attractive because engineers want to run software that will share some or all of the following characteristics:

- Large programs
- Large data sets
- Computationally intensive
- Memory intensive
- Graphics intensive
- Multitasking
- Networked
- Real time.

Large, computationally intensive programs that crunch large data sets include circuit simulators, pc-board and FPGA autorouters, math programs, and compilers. Memory- and graphics-intensive programs include drafting programs, which typically have huge databases of devices and must manipulate large files to show detailed graphics displays. Also, engineers increasingly are abandoning textual-programming methods for diagrammatic-programming systems, which rely on graphical user interfaces (Ref 2).

Multitasking is not an obvious aspect of engineering software. Until now, most engineers who have been



WINDOWS AND ENGINEERING SOFTWARE

working on PCs have not been able to do much multitasking because early PCs could barely run one engineering program at a time. Only with the advent of 386/486 PCs and suitable multitasking systems, such as Windows and Desqview, has multitasking become a workable possibility for engineering PC users. When engineers find that they can simultaneously print out a complex drawing, compile a program, and still be able to draw schematics or prepare documentation on their 386/486 PCs, they will wonder how they ever got along without multitasking.

The ability to multitask engineering programs and the low cost of 386/486 PCs could challenge the conventional notion that PCs are good for only simple tasks such as text or schematic entry and that real computation has to be uploaded to a powerful central computer. Note that workstation and mainframe makers are, not surprisingly, the strongest advocates of the uploading strategy. Some engineering shops may find that they can get adequate performance from a network of multitasking 386/486 PCs.

Rating Windows

How does Windows measure up as a multitasking operating system working within a network? For starters, a simple, concrete definition would be useful. Windows is a 16-bit, protected-mode operating system that lacks file I/O. Windows' code runs the user interface and manages memory and most of the computer's interrupts. Windows relies on DOS to manage timer interrupts and passes file-handling commands to DOS for execution. Future versions of Windows will dispense with the remnants of DOS altogether.

Windows has unique mechanisms for managing several large programs at once. These mechanisms are faster and more economical than those of some supposedly sophisticated operating systems such as Unix. Windows is not only a multitasker, but also has several unique mechanisms for exchanging data and control among multitasked programs. Furthermore, Windows has networking and support for printers and plotters built in.

For real-time I/O functions, such as controlling instruments and gathering data, the picture is not especially rosy. Windows has to contend with the PC architecture, which does not have the world's greatest external-interrupt mechanisms and DMA hardware. Furthermore, Windows grabs all the interrupt vectors in a PC, interposing extra processing for interrupts. And because Windows operates as a virtual-memory system, it necessarily fragments a given application's memory map, making DMA an even trickier task.

In relation to memory, Windows is really a kind of "DOS extender;" it gives programs access to a much

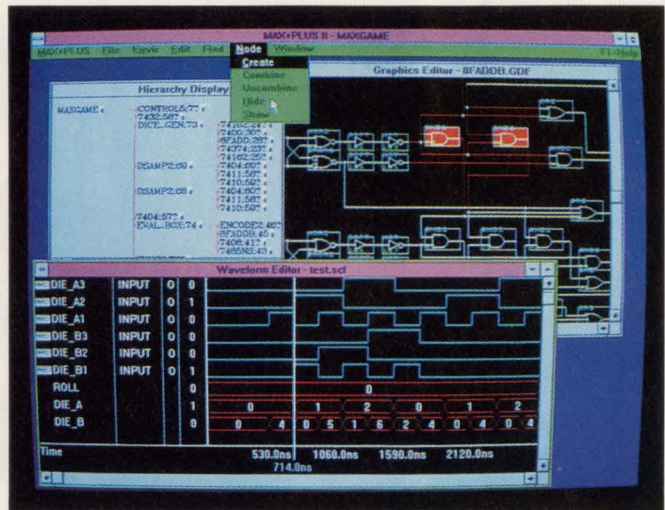

Running under Windows, this PLD design tool from Altera Corp can show multiple design-entry windows and the resulting PLD file simultaneously.

larger address space than the total 1 Mbyte that DOS can get at. (Curiously, even though Windows allows a program to access vast expanses of virtual memory, it does not yet support 32-bit programs.)

But Windows is *not* the only way a PC program can get access to that extra memory. Until the advent of inexpensive 386/486 PCs and Windows 3.X, vendors of engineering software have, quite reasonably, chosen another route to exploit the resources of 386/486 PCs: the so-called DOS extender (Ref 3). A DOS extender shifts the 386/486 μ Ps from real mode to protected mode and, unlike Windows, kicks off a 32-bit, protected-mode program. Then the extender lurks in the background, capturing DOS calls from the program, slipping briefly into real mode so that DOS can perform the requested calls. Even today, some vendors still prefer using DOS extenders.

Much of the new PC's flexibility comes from the chameleon-like 386/486. (As far as Windows is concerned, a 486 is just a faster 386. For compilers, the differences between the two processors are significant because the 386 and 486 execute similar instructions in differing numbers of clock cycles, altering optimization strategies and instruction choices.) To help alleviate confusion that the 386/486 μ P's myriad modes can engender, Table 1 sorts out various common software systems that use different features of 386/486 μ Ps.

What Windows means to programmers

Windows comes with a host of built-in functions for managing a multiwindowed graphics interface. It also comes with an excellent built-in on-line help facility. In fact, Windows provides so many built-in features—device drivers, graphics objects, etc—that program-

mers have to write less code for a Windows program than for a DOS program. Ironically, Windows versions of programs tend to cost substantially more than equivalent DOS versions. Also, built-in functions don't necessarily make programming for Windows a breeze.

Much of what you will hear about Windows, both good and bad, comes from programmers who are learning to write programs under Windows. This task presents a steep and torturous learning curve for both experienced DOS programmers and experienced Unix programmers. Yet managers of both types of programmers are flogging their galley slaves in an effort to get Windows versions out as soon as possible. Do not let the cries of anguish from below decks harden your heart against Windows.

The reason for the wailing and gnashing of teeth from former DOS programmers is not so much that they must learn a mountain of new Windows operating-system calls (Ref 4). DOS programmers' are in distress because they have to forgo years of hard-won DOS lore. This lore consists of innumerable tricks, "undocumented" DOS calls, workarounds, and bug fixes (Ref 5). The saga of the terminate-and-stay-resident (TSR) program illustrates "clever" DOS programming in its most odious form.

DOS is, in essence, a simple program loader. It can stack programs in memory, one atop another, until they bump into the notorious 640-kbyte barrier. DOS can run only the program on the top of the stack. At one point in the distant past of DOS's evolution, Microsoft decided it needed a "print spooler." That is, it needed a little program that would keep feeding bytes to a printer while a word processor went on with other jobs. How to pull off such a feat in a single-tasking computer?

Tales from the undocumented-DOS-calls crypt

Microsoft's answer was to add some "undocumented" (that word should strike terror into the heart of any hapless PC user) DOS calls that a knowledgeable programmer could use to fix a small interrupt-driven routine in the high end of the 640-kbyte DOS program space. Of course, having a routine simply stay in memory accomplishes little more than taking up memory. To actually do useful work, the little program would have to lay some cuckoo's eggs in other routine's nests. The TSR for, say, printing, would vacuum up the contents of the interrupt registers associated with printing and then put its own address into that register. When printing interrupts occurred, the TSR would respond

Table 1—Software usage of 386/486 architecture

Function	Software	386/486 modes used	Comments	Manufacturer	Circle no.
Operating system shells	Windows 3.0 Real	Real mode	Not able to run most Windows applications	Microsoft Box 97017 Redmond, WA 98073 (206) 882-8080	650
	Windows 3.1 Standard	16-bit protected, real mode	Not able to run DOS applications in a window		651
	Windows 3.1 Enhanced	16-bit, 32-bit protected mode, V86 mode, paging	Windowed multitasking of DOS applications, virtual memory support		652
	Desqview 386	32-bit protected mode, V86 mode, paging	Windowed multitasking of both DOS and 32-bit DOS extended applications	Quarterdeck Office Systems 150 Pico Blvd Santa Monica, CA 94045 (213) 392-9851	653
Memory managers	386 Max QEMM 386	32-bit protected mode, V86 mode, paging	Allows device drivers to be relocated to unused memory areas above 640 kbytes	Qualitas Inc 7101 Wisconsin Ave, Suite 1386 Bethesda, MD 20814 (800) 733-1377	654
				Quarterdeck	655
DOS extenders	386/DOS Extender	32-bit protected mode, V86 mode, paging	Allows 32-bit applications to run on top of DOS. 32-bit DOS applications can use virtual-memory support and are significantly faster than 16-bit DOS applications.	Phar Lap Software Inc 60 Aberdeen Ave Cambridge, MA 02138 (617) 661-1510	656
	DOS/4G			Rational Systems Inc. 220 N Main St Natick, MA 01760 (508) 653-6006	657



WINDOWS AND ENGINEERING SOFTWARE

to the interrupt first. The TSR could either perform some action or, because it remembered the original contents of the interrupt register, pass the interrupt on to the interrupt vector's original owner.

Microsoft couldn't keep such a nifty feature secret for long. Removing any doubt that even PC users need multitasking, other programmers soon figured out the undocumented DOS call and adapted TSRs for every task under the sun.

The real fun began when TSRs started "hooking" keyboard interrupts. DOS programmers cheerfully gave the DOS approved mechanisms for dealing with the keyboard the old heave-ho and started handling the keyboard in nonstandard ways. Users would add to the fun by loading multiple keyboard-based TSRs. The first TSR in the chain would get the interrupt, perform whatever action it felt like performing—perhaps changing the state of the PC—and, if the phase of the moon was correct, pass the interrupt to the next TSR in line.

TSRs would also play the same sort of games with the PC's screen. And yes, screen I/O is another area of extremely "creative" DOS programming. The very best DOS programmers will do any kind of screen manipulations except those that involve DOS calls. Taken as a whole, DOS with a bunch of TSRs resembles the Mad Hatter's Tea Party.

Common sense to the rescue

Now, no sane operating-system designer would set up an operating system that allows multiple tasks to steal shared resources as they see fit. In reasonable operating systems, a supervisor task monitors all interrupts, passing the interrupt to the appropriate task in a regular, algorithmic way.

The bad news for DOS programmers is that they not only have to learn how to use 500 to 700 new Windows operating-system calls, but they also have to give up all their cherished tricks. Under Windows, TSRs have no purpose and should be dispensed with. Under Windows, programmers cannot hook user interrupts or write directly to the screen. Windows manages all interrupts from the mouse and keyboard and coordinates all writes to the screen.

Programmers coming from "big" systems also have some shocks in store unless they have been programming for the X-Window System. Conventional Unix programs depend on a crude "standard-I/O" concept (Ref 6). The Unix standard input is a serial stream, usually from a keyboard, whereas Windows programs must be able to handle input from several sources at once: keyboard, mouse, etc. The Unix standard output is another serial stream, usually to the screen. Programmers can redirect these standard paths. For

example they can simply "pipe" the output of one program to the input of another. Windows' I/O and interprocess communications facilities are much more sophisticated and complex than the antique, Tinkertoy mechanisms of Unix.

Furthermore, C programmers are accustomed to using C libraries and functions which, known to the programmers or not, are based on DEC hardware and which sometimes poorly match 386/486 hardware. Although programmers can write Windows programs in C, much of standard C programming practice goes out the window. Windows has its own unique mechanisms for allocating memory and other system facilities as well as passing parameters.

For example, Unix programmers are accustomed to their program's receiving a pointer from the operating system in reply to a request for a system resource. Their program then saves that pointer, using it for the duration of the program's execution. Windows programmers cannot count on a pointer always being valid. Windows returns a "handle" to a system resource. The handle is actually an index into a table of memory locations for requested system resources. As Windows's memory manager moves things around in memory, it updates the appropriate entry in the handle table.

Because C really assumes underlying DEC hardware, C makes no distinction between data pointers and code pointers. But 386/486 μ Ps can have different code and data spaces—a facility that Windows makes use of.

Unix is a preemptive multitasking system. Unix programmers can write as much code as they like without worrying that their program will hog the system it is running on. Unix takes care of periodically interrupting programs to give other tasks time slices. Windows multitasking is self-paced. Each Windows task must give up the system voluntarily.

C programmers are accustomed to conglomerating many standard library programs along with their code, statically linking the whole system before running it. Windows has a powerful, sophisticated mechanism for dynamically linking program modules as needed while the program runs. These dynamically linkable modules must be reentrant because Windows will load only one copy of a module and share it with as many programs as need it. Thus Windows permits an entirely new way to structure large programs. Most C library functions (except for those from real-time Unix vendors) are not reentrant and hence are potentially dangerous under Windows.

Fig 1 shows a diagram of all the significant actors in a Windows system. Getting a general idea of how Windows runs programs and manages system re-

sources is essential to understanding how it suits—or does not suit—engineering software. The hardware/software block diagram in Fig 1 is in sharp contrast to the way programmers conventionally describe complex software systems.

Programmers are fond of expressing the relationships between various software and hardware actors in terms of “levels.” These so-called levels speak more to programmers’ loathing for hardware than they do of any actual structure. Like Dante’s vision of the circles of hell, the inner “layer” (or lowest level—programmers use levels and layers interchangeably) of software hell is reserved for hardware. Radiating out from the innermost circle of software hell, you encounter first “low-level” drivers, usually—but not always—written in assembly language.

At the next layer or level, the software begins to take on a divine aspect because you encounter operating-system code usually written in a high-level language. Unfortunately, because an operating system

has to know something about the system it is running on, this layer still bears the taint of hardware.

Finally, after passing through the operating-system layer, the programmer is in the pristine realms of the application layer and the outermost layer, the user interface. These areas are the most divine because it is in these areas that, free from the hardwired limitations of hardware, the programmer is in total control and becomes part of the software godhead.

In reality, a complex hardware/software system such as a 386/486 PC running Windows does not have a structure that resembles an onion. The application programs, Windows, DOS, and the PC’s hardware each contribute a number of significant actors. These actors form the complex network in Fig 1. This network’s topology permits certain transactions and forbids others. Various hardware and software actors have predefined, or hardwired, mechanisms that govern how the actors interact.

The important point is that some of these mecha-

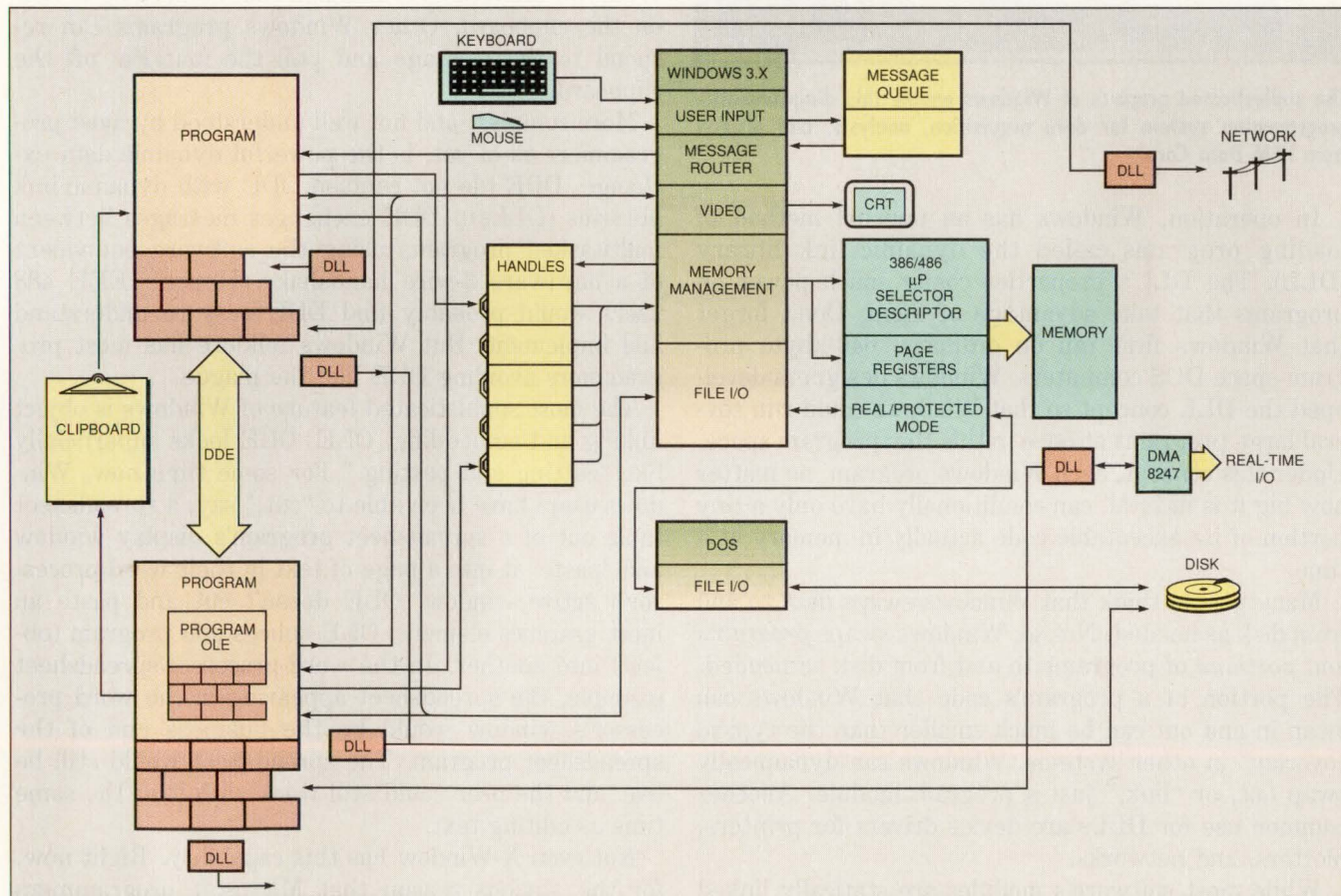

Fig 1—Multitasking programs running under Windows 3.X can add and delete program modules called DLLs (dynamic link libraries) on the fly. Among many functions, DLLs support networks, printers, plotters, and real-time I/O. Programs can communicate via the clipboard or DDE (dynamic data exchange), a defined protocol. Using OLE (object linking and embedding), one Windows program can even encapsulate another Windows program. Windows itself manages all the user interfaces. Windows also uses the 386/486 μ P’s hardware to manage memory, assigning “handles” to programs that want to use system services. Windows still depends on DOS for file I/O.



WINDOWS AND ENGINEERING SOFTWARE

nisms suit Windows and a 386/486 for engineering software; some do not.

Fig 1 shows the user interface and applications programs to the left. Windows and its allies, the 386/486 and a few remnants of DOS, occupy the center position. On the right is the hardware that interfaces to the outside world.

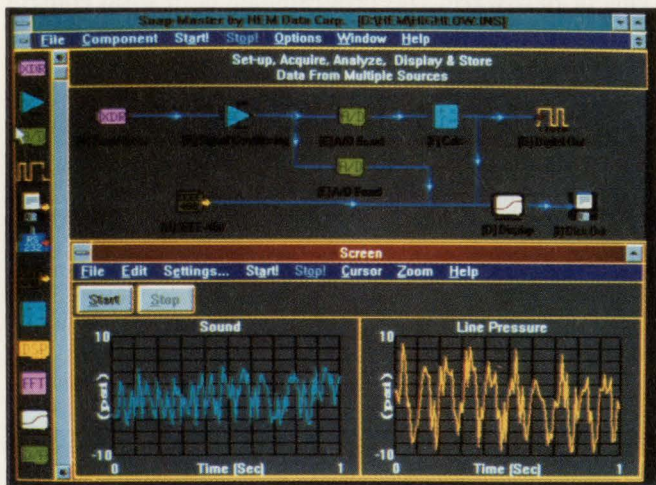

The sophisticated graphics of Windows enable this diagrammatic-programming system for data acquisition, analysis, and display from HEM Data Corp.

In operation, Windows has an unusual method of loading programs called the dynamic link library (DLL). The DLL's properties confer much power on programs that take advantage of them. Don't forget that Windows first ran on ordinary, 640-kbyte program-space DOS computers. Windows designers developed the DLL concept so that Windows could run several large programs at once in this tiny program space. Under this concept, each Windows program, no matter how big it is in total, can conditionally have only a tiny portion of its executable code actually in memory at a time.

Many people think that Windows swaps data to and from disk as needed. Not so. Windows swaps *programs* and *portions* of programs to and from disk as needed. The portion of a program's code that Windows can swap in and out can be much smaller than the typical "overlay" in other systems. Windows can dynamically swap out, or "link," just a program module. Another common use for DLLs are device drivers for printers, plotters, and networks.

While most software's modules are statically linked after compilation, Windows can do this linking on the fly, at run time, as it loads a DLL into memory. The price of this flexibility is, alas, indirect access. Each DLL has a table for external calls. All external calls within the DLL's code actually point to a table entry.

Windows fills in a DLL's table as it loads it. So each external call from one Windows DLL to another DLL involves an indirect call through a table, which adds to the access time. The benefit of the DLL facility is extreme flexibility in structuring programs and providing reusable library facilities.

DLLs are economical. In statically linked programs, each program that uses a given library function has its own private copy of that function linked in. Under Windows, as many programs as want to can use the same copy of a given DLL.

Windows has three ways that programs can communicate with each other. The simplest is the clipboard. The clipboard is not the clipboard icon you see in your Program Manager window. That icon represents a clipboard viewer. Windows does not limit the clipboard to "cutting and pasting" material from one program into another manually. The clipboard is a defined scratchpad that programs can use to exchange data as well. When one program writes to the clipboard, Windows broadcasts a message that something is now on the clipboard. Other Windows programs can respond to the message and pull the material off the clipboard.

More complex, and not well understood by most programmers as of yet, is the powerful dynamic data exchange, DDE (do not confuse DDE with dynamic link libraries (DLLs)). DDE exchanges messages between multitasked programs using the software equivalent of a hardware 3-wire handshake. Hence, IEEE 488 users would probably find DDE easy to understand and implement. But Windows folklore has most programmers avoiding DDE like the plague.

The most sophisticated feature of Windows is object linking and embedding, OLE. OLE looks superficially like "cutting and pasting." For some time now, Windows users have been able to "cut," say, a spreadsheet table out of a spreadsheet program's display window and "paste" it into a page of text in their word processor's active window. OLE doesn't cut and paste an inert graphics element; OLE splices one program (object) into another. In the word-processor/spreadsheet example, the spreadsheet appearing in the word processor's window would be the business end of the spreadsheet program. The spreadsheet would still be live, and the user could still work with it at the same time as editing text.

Not even X-Window has this capability. Right now, for the obvious reason that Microsoft programmers have had the first exposure to OLE, only programs from Microsoft use OLE. But you can expect engineering-software vendors will use this powerful mechanism to link complementary programs.

Because a user can be running several programs at

EPSON[®] IC MEMORY CARDS



JEIDA/PCMCIA

SRAM	64kB to	2M
OTP EPROM	64kB to	2M
Flash EEPROM	64kB to	1M
Mask ROM	256kB to	8M
EEPROM	16kB to	32kB

Storage and Software

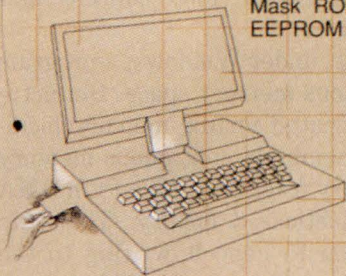

Musical Sound Cards

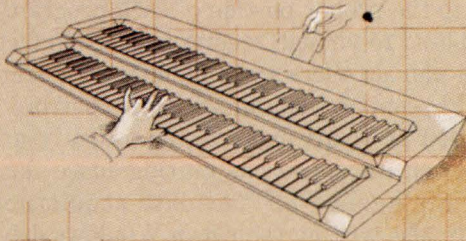

CARD EDGE

SRAM	8kB to	1M
OTP EPROM	32kB to	1M
Flash EEPROM	128kB to	1M
Mask ROM	128kB to	4M
EEPROM	8kB to	32kB

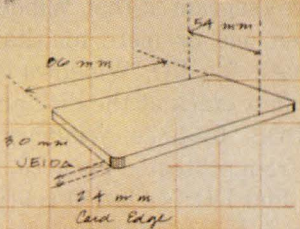

Font Cards

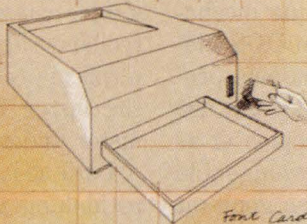

Programs and memory

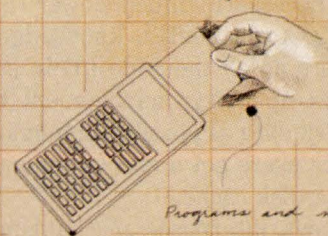

EPSON EPSON AMERICA, INC.

Component Sales Department Telephone: 213/787-6300

EPSON Sales Representatives: AL-GA-TN-NC Concord Components 205/772-8883 AZ-NM Fred Board Assoc. 602/994-9388 CA-No. Costar 408/446-9339 CA-Sa. Bager Electronics 714/957-3367 CO-UT Wn. Region Mktg. 303/428-8088 FL Dyne-A-Mark 305/771-6501 IL-WI LTD Technologies 708/773-2900 IN-KY C C Electro 317/921-5000 KS-MO-IA Microtronics 913/262-1444 MA-NH-CT Rosen Assoc. 617/449-4700 MD-VA Tech Sales Assoc. 301/461-7802 MN Electro Mark 612/944-5850 NJ JMR Sales 201/525-8000 NY Elcom Sales 716/385-1400 METRO-NY Niktronix 516/929-4671 OH-MI J.D. Babo Assoc. 216/934-4454 OR-WA Matrex 503/245-8080 PA Omega Sales 215/244-4000 TX-OK Component Tech. 214/783-8831

Call your sales rep today.



WINDOWS AND ENGINEERING SOFTWARE

once and those programs can all be displaying information in different windows on the screen together, the user interface does not connect directly to a given program. Instead, the keyboard, the mouse, joystick, and other user-input devices go to Windows. Windows puts all these inputs, one after another, into a queue. Windows knows which window on the screen is active. Windows sends messages to the active window's program, notifying it of user input. Now you see just what is meant by a "message-passing system." Most programmers are familiar with the concept of an application program's calling an operating system. Under Windows, not only can an application program call Windows, Windows can make calls to the program.

In response to the user inputs, the application program can make computations or can request system services from Windows. Windows 3.0 has well over 500 calls that a program can make (the new Windows 3.1 has even more). Many of the calls involve the standard Windows graphical user interface (GUI) facilities: windows, scroll bars, buttons, etc. Other calls request various forms of I/O or memory management.

File I/O, a trip down memory lane

The reason that good old DOS is lurking in the Windows diagram is that Windows uses DOS for file I/O. When one or more multitasking Windows programs request file I/O, Windows decides which request will get first crack at the disk and then passes the request to DOS. To do so, Windows has to switch the 386/486 μ P from protected mode to real mode so that Windows can find DOS's file-I/O routines. This baroque mechanism is necessarily much slower than a plain DOS file-I/O call. Consequently, knowledgeable Windows programmers do all their file I/O in large chunks and use Windows' memory management to keep copies of as much disk data as possible in memory. (Knowledgeable Windows users get a lot of memory and use a good bit of it as a disk cache.)

Windows interposes mechanisms that are similar, in principle, for writes to the screen. "Clever" DOS programmers can bypass DOS's operating-system calls altogether and simply write their program's video output directly into the PC's video memory. For a multitasking, multiwindowed operating system, such quick-and-dirty methods are not permissible. Thus, Windows takes longer than an equivalent DOS program to up-

date the screen. However, Windows' performance is comparable to X-Window's.

Under multitasking, more than one program can try to use a shared resource at the same time. One way that Windows handles such contention is to "virtualize" that resource. For example, if a multitasking program tries to write to the screen while it is not the active window, Windows lets the program write to a "virtual window." Similarly, Windows has a Virtual DMA Driver (VDMAD) and a Virtual Programmable Interrupt Controller Driver (VPICD). These facilities fool each program into thinking it is the only one using the PC's hardware DMA controller. Because Windows must constantly intercede in interrupt handling, deciding which program gets to use the real hardware and which ones use the "virtual" hardware, in-

terrupt responses can be much longer under Windows than under DOS.

In addition to relatively long interrupt latencies, Windows programs trying to do real-time I/O face two other tough challenges. First, the IBM PC's 8237A DMA-controller chip is an antique left over from the 64-kbyte segment days. It has far fewer address lines than the 386/486 μ Ps do.

Second, don't forget that, under Windows, a program may think it has a contiguous memory space. But actually, the 386/486's sophisticated virtual memory facilities piece together that seemingly contiguous memory space out of isolated memory fragments. The PC's DMA controller lacks this sophisticated facility. This chip requires constant attention to keep it writing to the proper place in real memory. Thus, doing DMA necessitates considerable overhead to keep the DMA controller writing to the proper portion of each program's physical (as opposed to virtual) memory space. In fact, the faster PCs can do memory-to-memory transfers faster under CPU control than under DMA control.

Data-acquisition pc-board makers consequently are rethinking their entire approach, putting more data memory and intelligence on the data-acquisition boards. They are also writing their own Windows drivers (DLLs).

Windows supposedly relieves program developers of supporting printers, plotters, and other I/O devices. Well . . . maybe yes and maybe no. Microsoft is familiar with office printers. But engineering printers and plotters are another matter. One pc-board CAD company, for example, had to write its own device driver

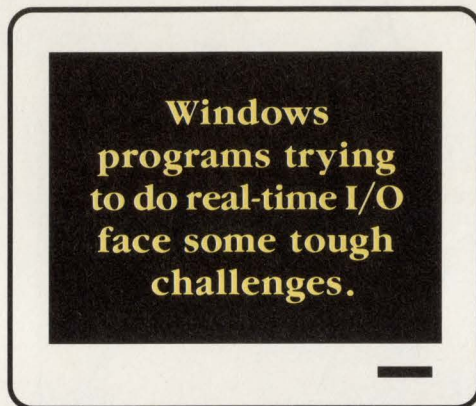

Somewhere in the world a Sanyo battery is being "designed-in" to a high performance application.

Right now.

Industry leaders select industry leaders.

CADNICA. In 1964 Sanyo's proprietary technology led to a breakthrough battery that withstands continuous overcharging and overdischarging...the sealed, rechargeable nickel cadmium Cadnica.

LITHIUM. Sanyo developed the technology for manganese dioxide compounds to be used in Lithium batteries which produced a cell with high voltage and high energy density characteristics.

CADNICA EXTRA. Sanyo's Cadnica E series incorporates high-density electrode plates in a new concept design for 40% greater capacity than conventional batteries and 1-hour charge capability via Sanyo's $-\Delta V$ voltage sensor changing method.

SOLAR. Sanyo leads the development of solar cells with the application of amorphous silicon for physical flexibility and the ability to be fabricated into large-area cells.

NiMH. Sanyo's proprietary electrode manufacturing process and built-in resealable safety vent lead the development of high capacity, high performance rechargeable, Nickel Metal Hydride batteries.

If you're developing an industry leading product right now, perhaps you should contact Sanyo...

right now.



For specification and design assistance please contact your regional Sanyo sales office at the following address:

SANYO Energy (U.S.A.) Corporation
2001 Sanyo Avenue
San Diego, California 92173
(619) 661-6620

In Florida: (904) 376-6711
In Illinois: (312) 595-5600
In New Jersey: (201) 641-2333
In Georgia: (404) 279-7377
In Dallas: (214) 480-8345

SANYO

SANYO Energy (USA) Corporation

CIRCLE NO. 61



WINDOWS AND ENGINEERING SOFTWARE

for the Gerber Photoplot when it debuted its Windows version of its pc-board software. Also, Hewlett-Packard has reportedly written drivers for many of its printers and plotters.

Like many people, I bought a copy of Windows 3.0, tried out the spiffy looking solitaire game that comes as a freebie, and never fired Windows up again. My familiar DOS programs suited me just fine, and none of the Windows software I saw looked worth the money. Another EDN editor, who tried determinedly to use Windows 3.0, got one too many crashes (the dreaded "UAE" message) and began wearing an "I hate Windows!" button.

Since then, though, I have been a beta tester for Windows 3.1 and I have talked to engineers, programmers, and marketing people at numerous engineering-software companies. Some raved about Windows; some slammed it unmercifully.

The arguments and counter-arguments run something like this:

- OS/2 is better than Windows in every way. *But . . . so what?*
- Those engineers who want to multitask programs can run as many plain DOS programs as they want simultaneously under good old Desqview—including 32-bit programs that run under a DOS extender. *But Windows offers facilities for intertask communication and control that multitasked DOS programs can't use.*
- Windows has a nice user interface. *But packages are available to give any program the "look and feel" of Windows.*
- Windows graphics are slower than writing directly to the video hardware. *But throwing about \$200 worth of hardware and software at the problem makes it go away (Ref 7).*
- Windows file I/O is slow. *But eventually Microsoft will stop dipping into real mode to use DOS for I/O and graft protected-mode file I/O onto Windows. In the meantime, when memory costs less than \$50/Mbyte, and DOS 5.0 comes with a disk cache, life is too short to wait for disk access.*
- DMA is slow and painful under Windows. *But the data-acquisition folks are making their boards smarter and their DLLs faster.*
- Windows runs only 16-bit programs. *But programmers have a variety of workarounds at their disposal to run 32-bit programs under Windows, and when Windows NT comes, it will be a 32-bit operating system.*

Me? What do I make of this spaghettied mass of arguments? I think that Windows is a good bet to actually become ubiquitous, not so much for what it is, but for what it will be.

Look at DOS. DOS has survived long after any reasonable estimate based on its technical merits would have predicted. DOS survived not because it was the *best* PC operating system, but because it was *the* PC operating system. People in my home town, Newton, MA, take the Green Line trolley to downtown Boston not because it is the best trolley, but because it is *the* trolley.

Soon Microsoft will perform a hood-ornament overhaul on Windows. In case you are not familiar with the term, a hood-ornament overhaul occurs when you have a car that is in such tough shape that the only way to fix it is to jack up the hood ornament, drive a new car underneath, and let the hood ornament back down. Windows NT is a hood-ornament fix for all that ails Window 3.X. And Windows NT will run Windows 3.X programs.

So, even though I use Desqview to launch and multitask all my comfortable old DOS programs, I think whatever Windows strengths and weaknesses are, or will be, Windows will become *the* operating system. **EDN**

References

1. *The Windows Shopper's Guide*, White Fox Communications Inc, Box 7125, Beaverton, OR 97007, (503) 629-5612.
2. Small, Charles H, "Diagram compilers turn pictures into programs," *EDN Special Software Supplement*, June 20, 1991, pg 17.
3. Duncan, Ray, ed. *Extending DOS*, Second Edition, Addison-Wesley, Reading, MA, 1992, ISBN 0-201-56798-9.
4. Petzold, Charles, *Programming Windows*, Second Edition, Microsoft Press, Redmond, WA, 1990, ISBN 1-55615-264-7.
5. Small, Charles H, "A pictorial guide to embedded DOS," *EDN Software Engineering Special Supplement*, March 28, 1991, pg 6.
6. Small, Charles H, "Real-time Unix & Unix look-alikes," *EDN*, June 7, 1990, pg 88.
7. Harvey, David, "Windows accelerator cards," *Computer Shopper*, February 1992, pg 235.

Acknowledgment

The author would like to thank Jim Adams at Intel Corp for his help in creating Table 1.

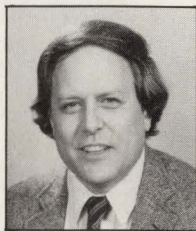

Senior Technical Editor Charles H Small can be reached at (617) 558-4556, FAX (617) 558-4470.

Article Interest Quotient (Circle One)
High 476 Medium 477 Low 478

Their way.



Our way.



Here's how to turn a relay with 2 changeover contacts into one with 4.

The MT4, our new relay with 4 changeover contacts, hardly occupies more board space than the MT2, our relay with 2 changeover contacts.

So if you need 6 twin changeover contacts on your board, simply install an MT2 and an MT4. Two relays of virtually identical size.

And the expensive space you formerly needed for a third MT2 is now free for other important functions.

Plus: less testing, less component cost, less assembly effort, greater reliability.

What more can you want?

(The new MT4: Power consumption at 20°C 300 mW. Temperature range -55°C to 85°C. Space occupied per contact 12 M².)

I'm interested in the new MT4 relay. Please send me your literature.

Company _____

Name _____

Address _____

Telephone _____

EDN 4-9-92

Alcatel STR AG

CH-8055 Zurich/Switzerland, Friesenbergstrasse 75

When the chips are down, the finger pointing starts.

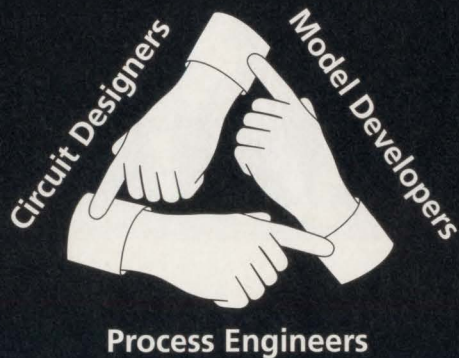

Every company experiences finger pointing when a design doesn't work.

Your circuit designers claim the models are not accurate. The model developers claim the process shifted since the time they began work on the models. The process engineers claim the model developers aren't tracking the process.

Meta eliminates finger pointing and helps you get it *right first time*[™]. Meta-Labs modeling services, combined with the HSPICE circuit simulator, provide the crucial link between your fab and circuit designers. The Meta-Software methodology helps your design, process and modeling groups work together as one team.

Get back in the chips with Meta-Software. For a *right first time* information package, call toll free (800) 442-3200, ext. A2.

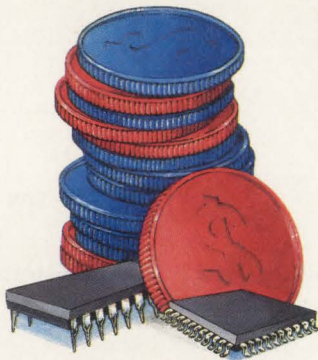

META-SOFTWARE

right first time[™]

CIRCLE NO. 49

Improve reliability by rigging pc boards for in-circuit programming

Barry M Clark, Stag Microsystems Inc

In-circuit programming eliminates many of the hazards associated with plugging memory devices in and out of sockets. By using some practical guidelines, you can rig a pc board's layout to meet commercial in-circuit-programmer specifications.

More and more, reliability demands that EPROMs and EEPROMs be permanently soldered onto printed-circuit boards. Such demanding applications include vibration-proof construction for avionics, military, and aerospace projects. In addition, surface-mount memory devices are proliferating in many new commercial applications. The ability to program memory devices without removing them from the pc board not only simplifies updating software in the field but can also eliminate the inventory cost of storing multiple programmed and labeled devices. Besides memory devices, microcontrollers having on-chip PROMs as well as some PLDs can also benefit from in-circuit programming.

Because in-circuit programming applications are diverse, you have several design options for programming an in-circuit device. For example, you can custom-design a programmer for a specific task, but this approach is usually costly and can be inflexible for simple changes. You can also design an adapter for using a commercial device programmer. However, device programmers generally don't supply enough

power to support a populated pc board, and the drive currents for the address, data, and control lines are often inadequate. The most economical and popular approach is to use a commercially available general-purpose in-circuit programmer.

Using a general-purpose in-circuit programmer minimizes NRE costs in two ways. First, you have to design only basic custom hardware that adapts your pc board to a standard programmer interface (Fig 1). Second, generating an appropriate programming algorithm is straightforward. For most commercial in-circuit programmers, you generate a descriptive text file for the pc board's configuration and device types. The in-circuit programmer uses this text file to compile an algorithm that programs devices for the entire board. These commercial in-circuit programmers are complete systems containing a CPU, RAM and ROM, mass-storage devices, operator and external-equipment interfaces, power supplies capable of supporting a pc board, and electronics capable of generating the appropriate programming waveform.

Electrical features will determine which in-circuit programmer suits your application. The programmer's power supply should be adequate to power your pc board under worst-case programming conditions. The programmer should also have redundant power-supply lines to keep other sections of the pc board active while it is programming devices. The programmer should be able to transfer data to and from a host computer and verify programmed data to ensure integrity

IN-CIRCUIT PROGRAMMING

In addition, drivers for gang-programming multiple boards should be well isolated from each other to ensure that the failure of one board doesn't affect the programming of another. If you're programming a large set of EPROMs, you'll want a programmer having sufficient RAM. And in field-programming applications, the programmer must be able to operate as a stand-alone unit.

When adapting a board design for a general-purpose in-circuit programmer, you can avoid potential pitfalls by adhering to some practical guidelines. To illustrate these guidelines, consider the example of in-circuit programming multiple EPROMs on a pc board that also has other logic devices and a μ P. First of all, you should use EPROMs fabricated in one of the MOS technologies—NMOS, HMOS (high-performance MOS), or CMOS. The programming characteristics of MOS EPROMs are close to the devices' operating characteristics. Therefore, MOS EPROMs are easier to program on a pc board than are bipolar devices, which have programming characteristics vastly different from their operating characteristics.

You shouldn't randomly mix EPROMs from different vendors on the same board, and when gang-programming multiple pc boards, the EPROMs on all the boards should be from the same manufacturer. Although the operational specifications of second-source EPROMs are similar to those of the original device, their programming specifications are often quite different. The differences typically extend to distinctive voltages and timing specifications for the programming pulse. Therefore, the in-circuit programmer would have to compile different programming algorithms to accommodate second-source devices.

To externally program a pc board, you must route the address and data buses and control lines of all the EPROMs to a board connector that is compatible with the programmer's interface connector. In many cases, these lines are already available at the board's target-system connector. If the system connector isn't compatible with the programmer, you must add a suitable connector.

An ID can eliminate Nader raiders

In some applications, you may want to provide boards with an ID that the programmer can read. IDs are useful when you have several different boards or different versions of the same board. The programmer checks the board's unique ID prior to programming to ensure that you've installed the right board. You can implement the ID using board jumpers, switches, or logic.

Alternatively, you could take advantage of the manufacturer's identification codes built into many EPROMs.

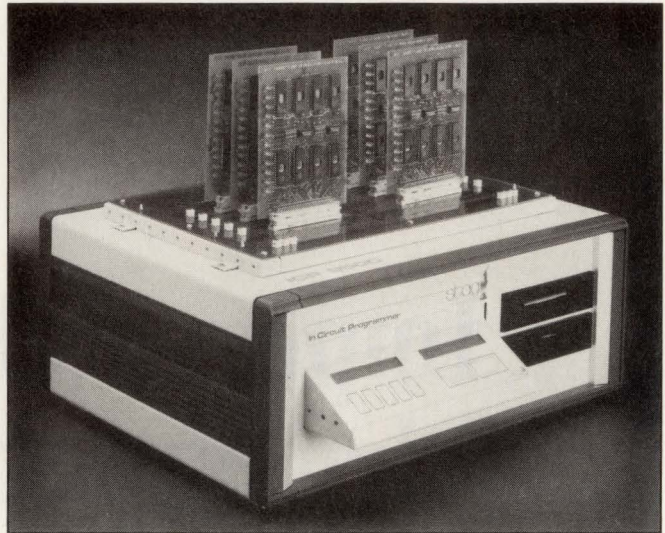

Fig 1—A custom assembly can adapt a pc board's system connector to a commercial in-circuit programmer. This programmer can gang-program multiple boards.

These codes identify the manufacturer and device type, which lets the programmer automatically choose the proper programming algorithm. Because the programmer must apply 12V to address line A9 to read an EPROM's identifier, you must isolate any other pc-board circuitry that connects to this address line.

The in-circuit programmer must take full control of the pc board to program the EPROMs. Ideally, the programmer should have direct access to all bus and control lines to minimize timing errors, shape the programming pulse, and account for transmission-line effects. In practice, however, access to an EPROM is usually through a cascade of logic circuits, and many EPROMs often share the same bus and control lines.

To program a target EPROM, the programmer must place an address on the EPROM's address bus via buffers resident on the board and be able to transfer data to and from the EPROM's data bus. Thus, the pc board must have bidirectional transceivers in the data path between the EPROM and the interface connector even though data flows unidirectionally to achieve the final objective. In addition, the transceivers' direction and enable control lines must be accessible to the interface connector. Other active devices attached to the target EPROM's data bus should have separate 3-state buffers. The programmer places the buffer outputs in a high-impedance state while programming and verifying data in the target EPROM (Fig 2a).

You can often put a μ P's data bus in a high-impedance state by activating the μ P's output-enable, reset, or halt control lines. If the μ P's data bus attaches to the EPROM's data bus, then one of these control

EDN-DESIGN FEATURE

lines should be accessible to the interface connector for program control (Fig 2b). In some instances, the pc board may have a system bus comprising multiplexed address and data lines. In such instances, the control lines for the board's address latch should extend to the interface connector for program control.

To reduce the time needed to program multiple EPROMs, intelligent programming algorithms raise the EPROMs' V_{CC} supply voltage to 6V or higher. Although TTL logic can withstand a V_{CC} voltage as high as 7V, the increased power dissipation can unduly stress these devices. To avoid this stress, provide dual

V_{CC} supply lines to the interface connector. The dual lines let the programmer supply power to the board using isolated power supplies—one for the EPROMs and one for rest of the board's circuitry. You can connect the dual V_{CC} lines off the board at the application's mating-system connector.

An EPROM's V_{PP} line also requires special consideration when you plan to program the device in circuit. Boards not designed for in-circuit programming have their EPROMs' V_{CC} and V_{PP} pins connected so devices can read the data. To program an EPROM in circuit, the board layout must isolate these two pins to let the

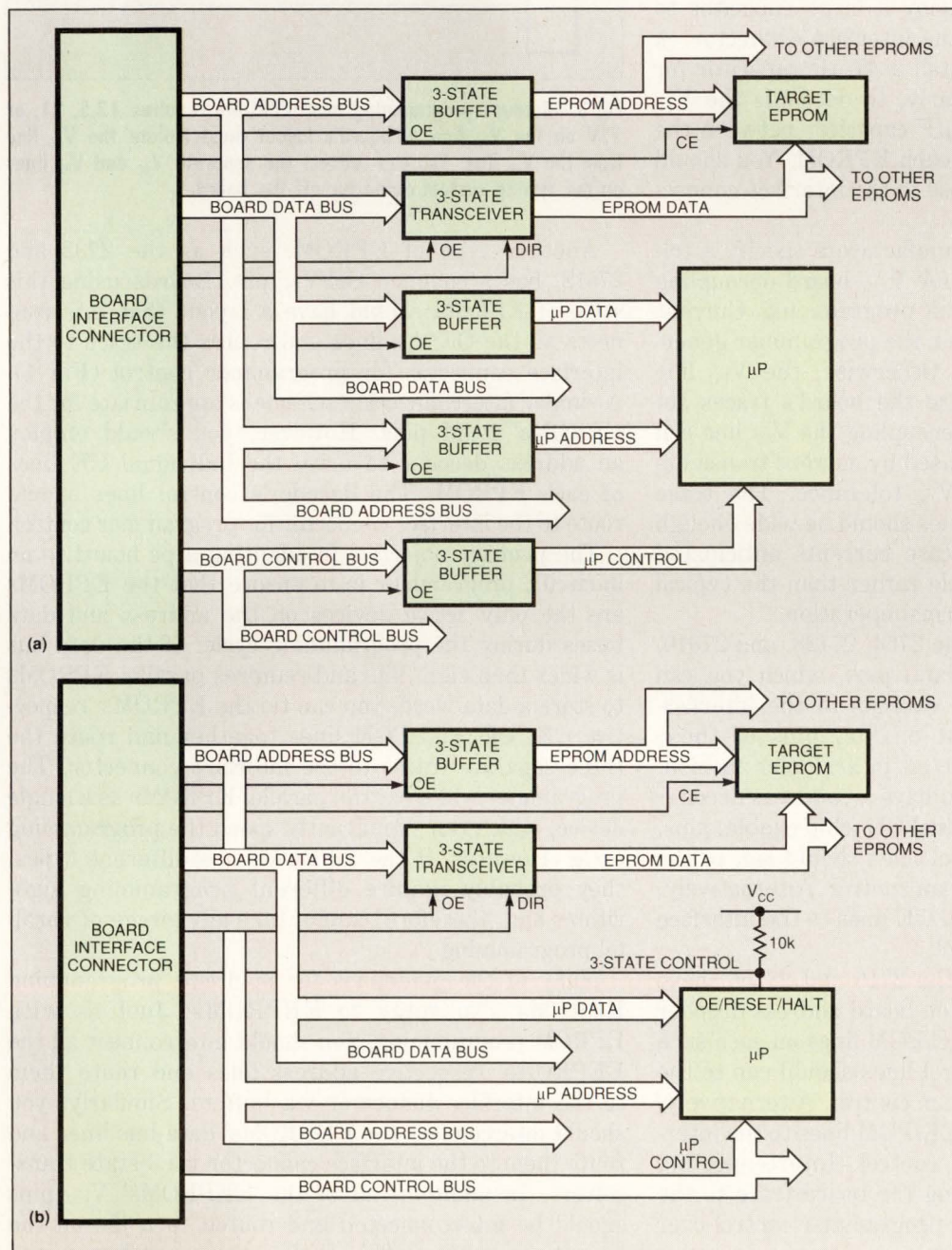

Fig 2—The in-circuit programmer must have control of all devices that share an EPROM's address and data bus. You can isolate a peripheral device such as a μP by using 3-state buffers (a) or by forcing on-chip 3-state drivers into a high-impedance state (b).

IN-CIRCUIT PROGRAMMING

programmer raise the V_{PP} line to a voltage greater than V_{CC} , which is typically 5V (Fig 3). Typical V_{PP} voltages are 12.5, 21, or 25V depending on the programming algorithm. Therefore, the board layout must route the V_{PP} line to a separate pin on the interface connector. You can connect the V_{PP} line to the V_{CC} line off the board at the application's mating-system connector.

The decoupling arrangement for the pc board's V_{CC} and V_{PP} lines is critical. You should follow the EPROM manufacturer's decoupling recommendation, which usually dictates the placement of a 0.1- μ F capacitor between the V_{CC} pin and ground close to each EPROM. In addition, you should employ a large capacitor to decouple the V_{CC} line near the interface connector. A good rule-of-thumb is to install a 47- μ F capacitor for every eight EPROMs. Similarly, to decouple the V_{PP} line, you should place a 0.1- μ F capacitor between the V_{PP} pin and ground close to each EPROM. You should also decouple the V_{PP} line close to the interface connector using a 10- μ F capacitor.

Because most EPROM manufacturers specify a tolerance between 0.5 and 1V for V_{PP} , board decoupling is crucial to successful in-circuit programming. Current flows in the V_{PP} line only when the programmer generates a programming pulse. Otherwise, the V_{PP} line current is negligible. Because the board's traces act as inductors, inadequately decoupling the V_{PP} line can result in induced voltages caused by current transients that exceed the specified V_{PP} tolerance. The trace widths for the V_{CC} and V_{PP} lines should be wide enough to accommodate the worst-case currents anticipated during the programming cycle rather than the typical currents expected during normal operation.

Some EPROMs, such as the 2764, 27128, and 27010, have individual PGM (program) pins, which you can tie to a common trace that extends to the interface connector. The OE (output enable) pins of these EPROMs can be interconnected in a similar fashion. However, the pc board should have an address decoder to drive the EPROMs' individual CE (chip enable) pins. The address decoder's control lines should run to the interface connector for program control. Alternatively, you could route the individual CE lines to the interface connector for program control.

Other EPROMs, such as the 2716 and 27256, have a common CE/PGM pin. An on-board address decoder should drive the individual CE/PGM lines on each such EPROM. The decoder's control lines should run to the interface connector for program control. Alternatively, you can route the individual CE/PGM lines to the interface connector for program control. Interconnecting groups of OE pins and routing the board trace to the interface connector gives the programmer control over groups of EPROMs.

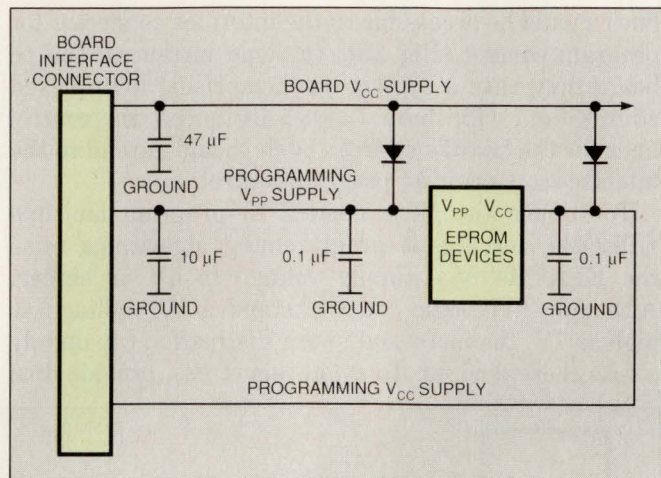

Fig 3—Because programming most EPROMs requires 12.5, 21, or 25V on the V_{PP} line, a board's layout must isolate the V_{CC} line from the V_{PP} line. You can connect the separate V_{CC} and V_{PP} lines on the mating-system connector off the board.

Another type of EPROM, such as the 2732 and 27512, has a common OE/ V_{PP} pin. Boards using this style of EPROM should have a layout that interconnects all the OE/ V_{PP} lines and routes the trace to the interface connector for programmer control (Fig 4). A similar interconnection scheme is appropriate for the EPROMs' PGM pins. However, you should employ an address decoder to drive the individual CE lines of each EPROM. The decoder's control lines should route to the interface connector for programmer control.

The primary objective in adapting a pc board to an in-circuit programmer is to ensure that the EPROMs are the only active devices on the address and data buses during the programming cycle. If the data bus is wider than eight bits and requires parallel EPROMs to store a data word, you can tie the EPROMs' respective CE, OE, and PGM lines together and route the three separate traces to the interface connector. The programmer will treat the parallel EPROMs as a single device, which can significantly speed the programming cycle. However, if the EPROMs are different types, they probably require different programming algorithms and, therefore, cannot take advantage of parallel programming.

Many of the guidelines for in-circuit programming EPROMs also apply to EEPROMs. Just as with EPROM programming, you should interconnect all the EEPROMs' respective address lines and route them to the interface connector via buffers. Similarly, you should interconnect the EEPROMs' data-bus lines and route them to the interface connector via 3-state transceivers. In addition, all of the EEPROMs' V_{CC} pins should be interconnected and routed to a pin on the interface connector. This pin lets the programmer sup-

EDN-DESIGN FEATURE

ply power to the EEPROMs via a supply that is isolated from the rest of the board. When the data bus is wider than eight bits, you can tie the respective CE, OE, and WE (write enable) lines of parallel EEPROMs together to program them as a single device.

The layout differences between EPROM boards and EEPROM boards are due to the electrical-erase characteristics of the EEPROMs. EEPROMs fall into two categories: those that require a high-voltage erase-and-programming pulse and those that use low voltage (5V) for erase and programming. The layout

of a pc board rigged for programming EEPROMs in circuit must reflect these differences. When using low-voltage-erase EEPROMs, you can interconnect their OE and WE lines and route them to the interface connector for programmer control. However, the CE lines should be driven independently—either by an on-board address decoder or directly by the programmer.

High-voltage-erase EEPROMs require more attention. Activating the CE pin disables many of these EEPROMs. Tying all of the V_{PP} pins to a common trace that extends to the interface connector lets the pro-

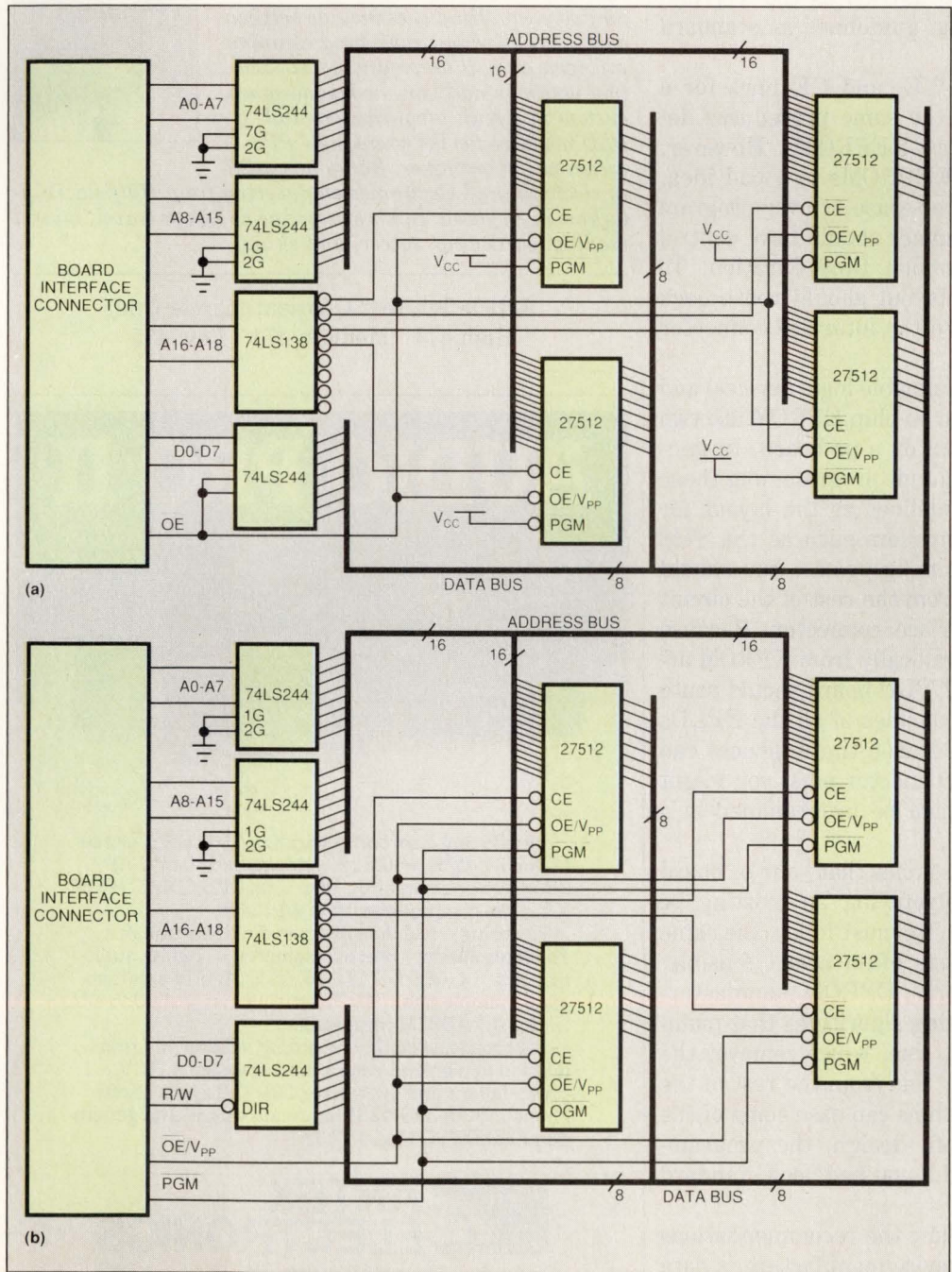

Fig 4—To modify a board containing 27512 EPROMs from a device-programming layout (a) to an in-circuit programming layout (b), you must make sure the programmer has control of the OE and PGM lines.

IN-CIRCUIT PROGRAMMING

grammer or an onboard address decoder control the CE lines independent of each other. For devices whose erasure requires a high-voltage pulse on the CE pin, the board layout must route the individual CE lines to the interface connector for programmer control.

Don't over-program flash EEPROMs

Another candidate for in-circuit programming is the increasingly popular flash EEPROM. Flash EEPROMs require a high voltage on the V_{PP} pin during programming and an exclusive erasure cycle. The board layout for the address and data bus as well as the V_{CC} and V_{PP} lines can follow the same guidelines as standard EPROMs.

You can lay out the OE, WE, and CE lines for a flash-EEPROM board using the same procedures described for low-voltage-erasure EEPROMs. However, programming parallel flash EEPROMs is a bad idea. Because programmers can over-erase or over-program flash EEPROMs, the programmer should have control of the erasure and programming time duration. To implement this control, the layout should route each CE line and RDY/Busy line to the interface connector for programmer control.

EPLDs (electrically programmable logic devices) and microcontrollers containing an on-chip EPROM are two more devices you can program on a pc board. In general, the board layout for in-circuit programming these devices follows the same guidelines as the layout for an EPROM board. Microcontrollers such as the 8748 require high-voltage programming pulses. You should isolate the pins of such μ Cs from the rest of the circuit and route them to the interface connector. Because EPLDs' architectures differ radically from EPROM architectures, the layout of an EPLD board should route the individual input and output lines of all the EPLDs to the interface connector. Because these devices can potentially consume several connector pins, you might consider using EPLDs that can be programmed in a serial bit-by-bit manner.

Of course, this discussion assumes that your pc board is in the design stages. Retrofitting an existing pc board for in-circuit programming must follow the same guidelines, but these practices often aren't feasible. To accommodate retrofit designs, EPROM manufacturers are developing programming algorithms that maintain a constant 5V on the V_{CC} line, which removes the constraint of isolating the V_{CC} line from the rest of the board. Although these algorithms can ease some of the layout constraints in a retrofit design, the programming time will be longer than if you had used standard algorithms.

In any case, you should follow the recommendations found in the programmable-device manufacturer's data

book. In addition, in-circuit-programmer vendors can offer information on board constraints, such as board profiles, mechanical requirements for the interface connector, and supporting slide guides or locks. By paying attention to some practical design and layout rules, in-circuit programming can be trouble free. **EDN**

Author's biography

Barry M Clark is a senior applications engineer with Stag Microsystems Inc (Santa Clara, CA), where he has worked for five years. His duties include helping customers solve in-circuit programming problems as well as producing application notes. In addition, he has designed custom in-circuit programmers and PLD modules for the company's PP2 universal programmer. Barry has a BS in electrical and electronics engineering from Hatfield Polytechnic in England. In his spare time he enjoys travel, music, reading, gardening, soccer, and skiing.

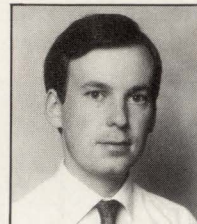

Article Interest Quotient (Circle One)
High 473 Medium 474 Low 475

AUDIO PRO II

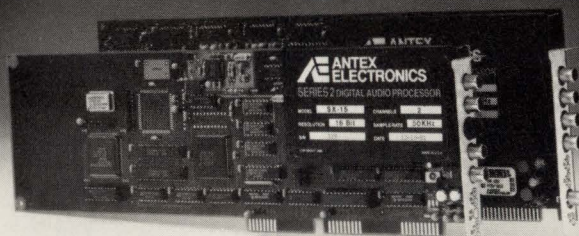

AUDIO PRO II
Model SX-15

AUDIO PRO
Model SX-10

Introducing... second generation CD quality, stereo hi-fidelity digital audio record/playback for PC-AT 386/486 or compatible. Now with DVI/CDI/CD-ROM XA audio compression up to 44.1 kHz.

Featuring... real time direct-to-disk data transfer... 18 bit resolution... 64x oversampling... 22kHz audio response... 0.005% THD... 6.25 to 50 kHz programmable sample rate... 92dB dynamic range... 90db s/n... plus 4:1 ADPCM compression.

For broadcast quality recording, editing and transmission in high-end entertainment systems, A/V presentations and interactive CDI/DVI applications. Phone 1 (800) 338-4231 for details on the 2nd generation AUDIO PRO Model SX-15.

ANTEX ELECTRONICS

16100 S. Figueroa St • Gardena, CA 90248 (USA) • Tel (310) 532-3092 • FAX (310) 532-8509

Our Concept

Commitment to Quality



When it comes to quality, we accept nothing less than perfection: flawless quality. And the only way to achieve that is through constant investment in research, development and production facilities. This commitment to investment has always been our top priority. After all, our customers expect nothing less than perfect quality from us. And we do everything we can to see to it that that's exactly what they get. Every day and anywhere.

Committed to perfect quality:

World headquarters:
HARTING ELEKTRONIK GmbH
P.O.Box 1140 · D-4992 Espelkamp · Germany
Phone (0 57 72) 47-0 · Fax (0 57 72) 47-461
Telex 9 72 310-11 he d

CIRCLE NO. 101

HARTING Subsidiary Companies:

Austria/Vienna

Tel. 02 22/68 68 18

Belgium/Brussels - Zellik

Tel. 02-466.01.90

France/Paris

Tel. (1) 486 323 89

Great Britain/Northampton

Tel. (06 04) 76 66 86

Hongkong

Tel. 08 52-422 18 09

Italy/Milano - Vimodrone

Tel. (2) 27 40 03 00

Japan/Yokohama

Tel. 045-931.57 15

Netherlands/Breda - Etten Leur

Tel. 01 608-3 54 00

Norway/Oslo

Tel. 02-6475 90

Spain/Barcelona

Tel. (3) 323 20 22

Sweden/Stockholm - Spånga

Tel. (08) 7 61 79 80

Switzerland/Zürich -

Schwerzenbach

Tel. 01-8 25 51 51

USA/Chicago - Hoffman Estates

Tel. (708) 519-77 00

Agencies:

Denmark, Finland, South Africa

Representatives:

PRC/Shanghai, ROC/Taipei,

ROK/Seoul, Singapore



NEW RISC/CISC
DEVELOPMENT TOOLS

BEWARE!

Are you buying a Logic Analyzer for RISC or high-speed CISC* Development? Compare...

Features	American Arium	Tektronix'	Hewlett Packard'
100 channels, 100 MHz sync	YES	YES	YES
Dynamic cache control	YES	NO	NO
Data cycles fully labeled in disassembly	YES	NO	NO
Maximum trace depth	128K	128K	4K
Maximum synchronous rate	200 MHz	100 MHz	100 MHz
Maximum asynchronous rate	1GHz	400 MHz	500 MHz
Split timebase on a single card	YES	NO	YES
Setup+Hold time	3.0 nsec	5.0 nsec	3.5 nsec
Price performance value	High	Low	Moderate

(1) 92A96XD (2) 16550A

Introducing Paladin™ —

American Arium's new single card capture system for the ML4400 Logic Analyzer featuring 100 and 200 MHz synchronous and 1 GHz asynchronous data capture. With 100 channels of 100 MHz synchronous capability per capture card, plus the powerful features of the ML4400, Paladin delivers the maximum capability available today for state and timing measurements on high-performance μ P-based designs.

Fully Labeled Disassembly

The ML4400 boasts fully automatic synchronizing disassemblers for all major families of μ Ps, including RISC, CISC, DSP and GSP. These are the *only* disassemblers available that completely identify and label all data cycles including task switches, exception processing, page translation and other complex CISC instructions.

*Such as 80486 or beyond, or 68040 or beyond.



Dynamic Cache Control

The ML4400 provides dynamic control of cache fill on many processors, allowing complete disassembly of some program segments while the majority of the program runs fully cached.

Total Versatility

Paladin cards may be paralleled to form analyzers with up to 200 channels per timebase. You can configure the ML4400 to fit your needs, with the flexibility of 5 different types of capture cards.

Compare First

Paladin delivers the speed and power you'd expect from the leader in Logic Analyzer technology. And you can save thousands of dollars. For a demo, call (714) 731-1661.

American Arium

Formerly American Automation and Arium Corporation
14281 Chambers Road, Tustin, California 92680

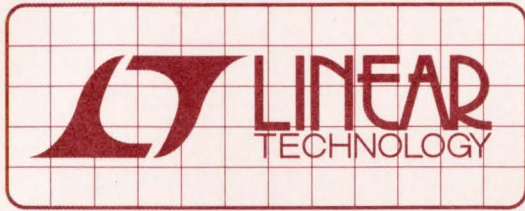

DESIGN NOTES

Video Circuits Collection – Design Note 57

William H. Gross

Introduction

This note shows how to make several different video circuits using high speed op amps. All of these circuits work with composite, RGB and monochrome video. For best results, bypass the power supply pins of these amplifiers with $1\mu\text{F}$ to $10\mu\text{F}$ tantalum capacitors in parallel with $0.01\mu\text{F}$ disc capacitors. It is important to terminate both ends of video cables to preserve frequency response. When properly terminated, the cable looks like a resistive load of 150Ω .

Multiplex Amplifiers

Often it is desirable to select one of several signals to send down a cable. Connecting the outputs of several amplifiers together and using the amplifier's shutdown pin to disable all but one accomplishes this goal. The LT1190, LT1191, LT1192, and LT1193 are shutdown by pulling pin 5 to the negative supply.

The LT1223 and LT1227 current feedback amplifiers are shutdown by pulling pin 8 to ground. During normal operation pin 8 is open and at the positive supply potential. An easy way to interface pin 8 to logic is with a logic level N-Channel FET or a 74C906 (open drain hex buffer).

Lots of Inputs Video MUX Cable Driver (LT1227)

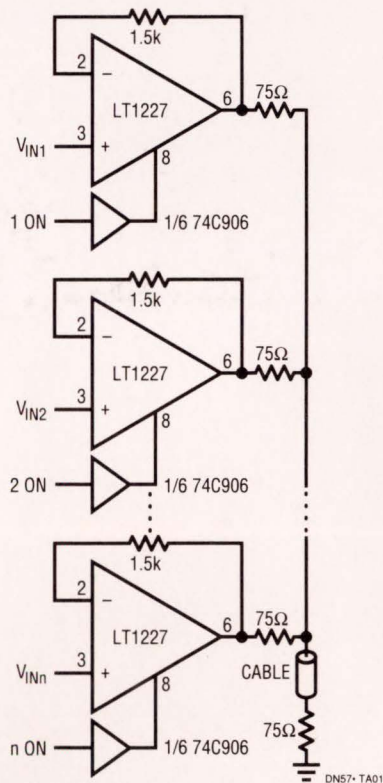

DN57-TA01

Two Input Video MUX Cable Driver (LT1190)

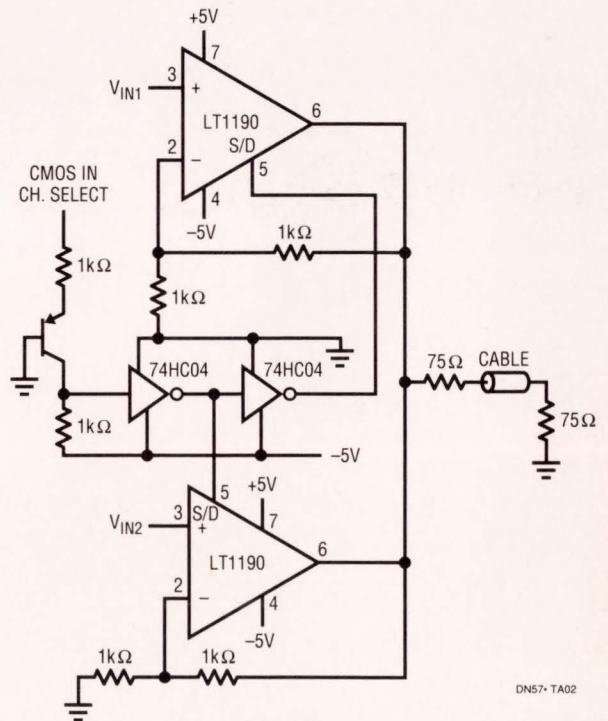

DN57-TA02

Differential Gain and Phase of Several Amplifiers

PART NO.	DIFFERENTIAL			
	LOAD = 1k Ω		LOAD = 150 Ω	
	GAIN	PHASE	GAIN	PHASE
LT1190*	0.05	0.02	0.23	0.16
LT1191*	0.03	0.01	0.09	0.07
LT1192**	0.10	0.01	0.23	0.15
LT1193*	0.20	0.08	0.20	0.08
LT1194**	0.20	0.08	0.20	0.08
LT1223	0.01	0.02	0.12	0.26
LT1227	0.01	0.01	0.01	0.01
LT1228	0.01	0.01	0.04	0.10
LT1229	0.01	0.01	0.04	0.10

$V_S = \pm 15V, A_V = 2$

* $V_S = \pm 8V, A_V = 2$

** $V_S = \pm 8V, A_V = 10$

Loop Through Cable Receivers

Most video instruments require high impedance differential input amplifiers that will not load the cable even when the power is off.

Differential Input Video Loop Through Amplifier Using a Video Difference Amplifier (LT1194)

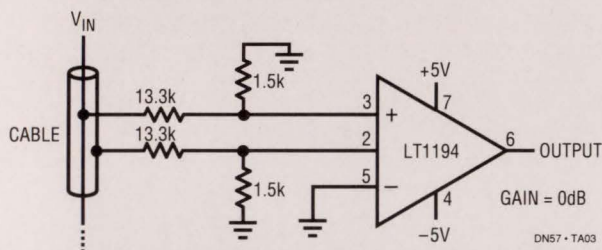

Electronically Controlled Gain, Video Loop Through Amplifier (LT1228)

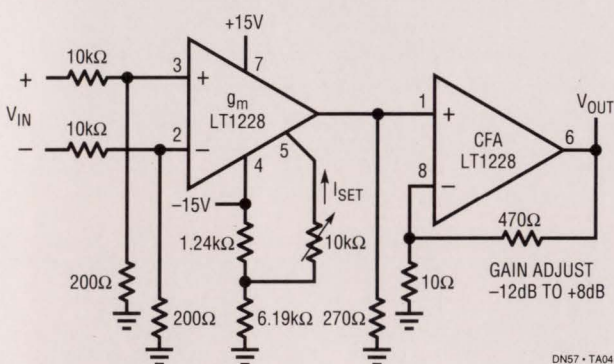

DC Restore Circuits

The following circuit restores the black level of a monochrome composite video signal to 0V at the beginning of every horizontal line. This circuit is also used with CCD scanners to set the black level.

Video DC Restore (Clamp) Circuit (LT1228)

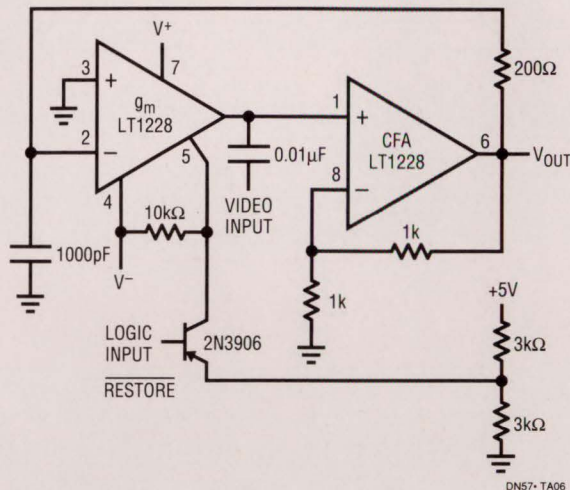

Fader Circuits

Using two LT1228 transconductance amplifiers in front of a current feedback amplifier forms a video fader. The ratio of the set currents into pin 5 determines the ratio of the inputs at the output.

Video Fader (LT1228, LT1223)

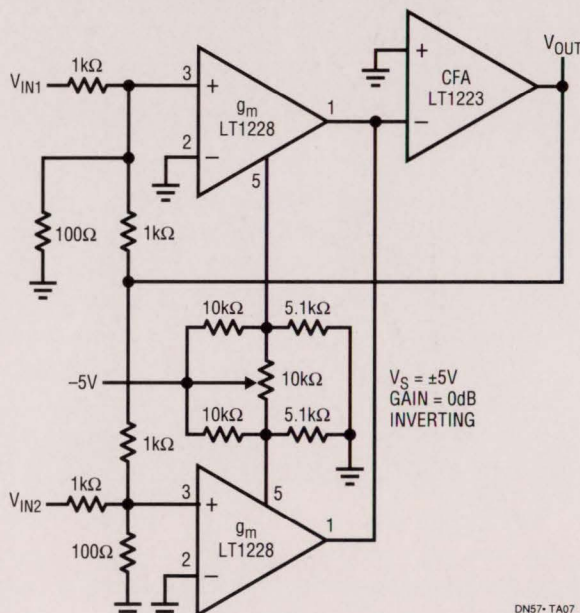

For literature on our High Speed Amplifiers, call (800) 637-5545. For applications help, call (408) 432-1900, Ext. 456

Linear Technology Corporation

1630 McCarthy Blvd., Milpitas, CA 95035-7487

(408) 432-1900 • FAX: (408) 434-0507 • TELEX: 499-3977

BA/GP 0292 190K

LINEAR
TECHNOLOGY

© LINEAR TECHNOLOGY CORPORATION 1992

Transducers form proximity detector

Jay Scolio, Maxim Integrated Products, Sunnyvale, CA

Combining micropower op amps with a pair of matched piezoceramic transducers (one optimized for 40-kHz transmission and the other for 40-kHz reception) yields an ultrasonic proximity detector that operates on a 9V battery (Fig 1). The detector employs the radar principle—nearby people or objects reflect the transmitter's steady tone back to the receiver.

The transmitting transducer (Fig 1a) is a resonant circuit that may draw spikes of current from its signal source, which, in this case, is the low-power CMOS timer, IC₁. To prevent damage from these undesirable spikes, a push-pull driver composed of Q₁ and Q₂ buffers the timer. You should adjust the potentiometer, R₁, for a transmit frequency of 40 kHz.

The receiver in Fig 1b must offer high gain at ultrasonic frequencies while operating from the same 9V battery as the transmitter. Op amps IC₂ and IC₃ provide the necessary bandwidth and supply current (7 MHz min at unity gain and 375 μA max). Op amp IC₄, offering a rail-to-rail output swing and extremely low quiescent current (1.2 μA when low, 30 μA when high),

is also well suited to its role as the output-signal comparator. Supply current for the complete circuit is slightly more than 2 mA. (Note: You can halve this consumption by replacing the transistors with a CMOS inverter.)

The receiver is stable using the component values shown. If you change the gain, however, note that you must also adjust the pole-zero locations associated with op amps IC₂ and IC₃ to maintain stability. In a store-display application, the proximity detector triggers a prerecorded video message on the arrival of an interested customer. A pause to look signifies interest; the detector shouldn't respond to someone just walking by. Therefore, R₂ and C₁ filter the transducer signal after D₁ rectifies it. The filter also prevents false triggering as a response to brief bursts of ambient noise in the ultrasonic range. EDN BBS /DL-SIG #1115

EDN

To Vote For This Design, Circle No. 746

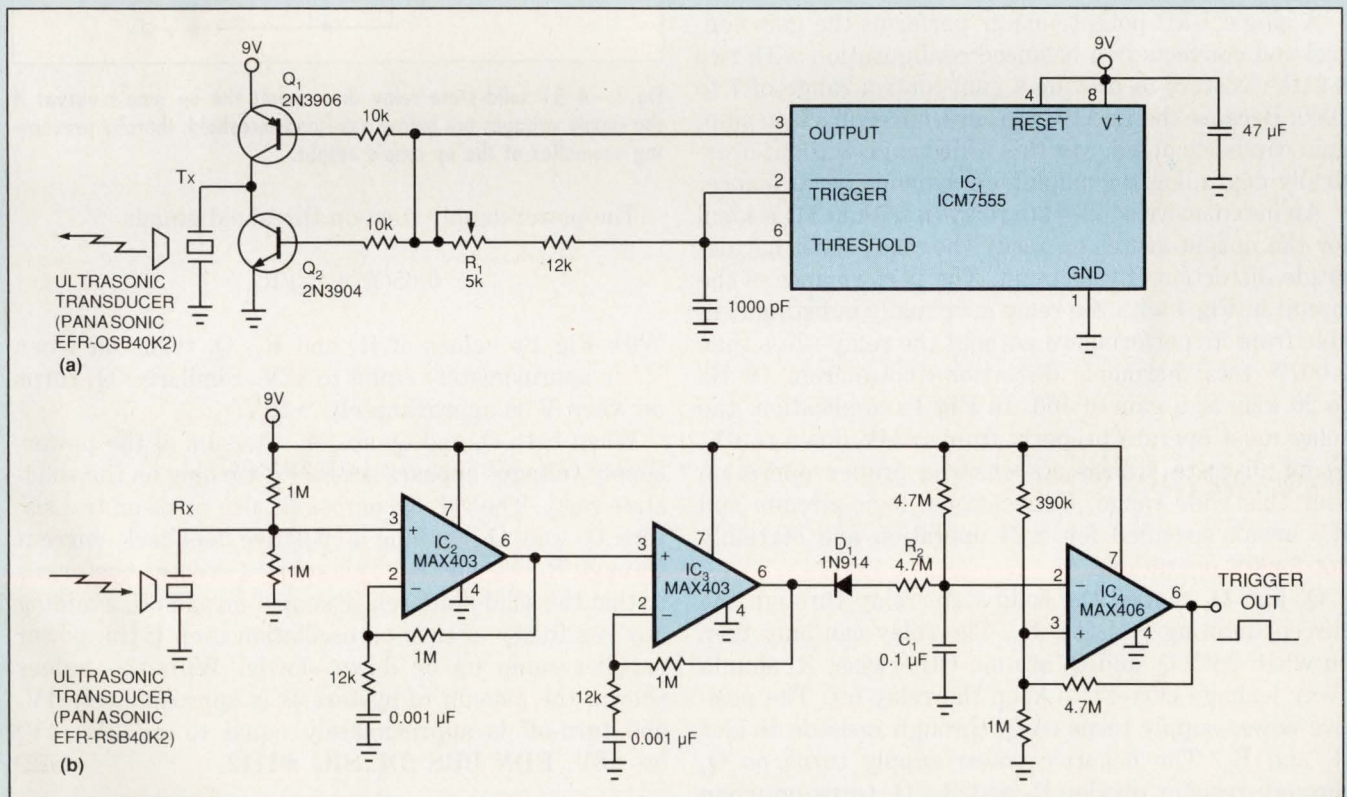

Fig 1—Comprising an independent transmitter (a) and receiver (b), this battery-powered, ultrasonic proximity detector features two 40-kHz piezoceramic transducers.

Solid-state relay prevents turn-on anomalies

R Mark Stitt, Burr-Brown Corp, Tucson, AZ

ICs operate properly only above a specified minimum power-supply voltage. When power-supply voltages drop below this level, operation is unpredictable. Since most analog ICs use dual power supplies, power-supply sequencing variations, which occur when one power supply comes up or goes down before the other, can also cause problems. Momentary lock up or oscillation during power-up or power-down is common. In many instances, these anomalies are inconsequential and go unnoticed, but sometimes these unexpected operating states can be devastating. For example, audio amplifiers that lock up or oscillate during power-up or power-down can damage speakers.

Fig 1's simple control circuit eliminates turn-on problems with analog ICs. The circuit uses a few garden-variety transistors and resistors along with an inexpensive solid-state relay to disconnect the output of an analog IC unless both its positive and negative power supplies are above a specified voltage. Fig 1 demonstrates the control circuit enabling the output of a microphone amplifier.

A single 1-k Ω potentiometer performs the gain control and connects in a balanced configuration with two 3.01 Ω resistors to provide a gain-control range of 7 to 1000. Because the INA103 is a current-feedback op amp, gain can be changed over this wide range without drastically degrading the amplifier's dynamic performance.

An inexpensive solid-state relay (less than \$1) is ideal for the output-switching task. The relay must not degrade distortion of the circuit. The performance of the circuit in Fig 1 with the relay is virtually indistinguishable from its performance without the relay—less than 0.002% total harmonic distortion+noise from 10 Hz to 20 kHz at a gain of 100. In Fig 1's application, the relay must operate properly from ± 24 V down to 0V. Using discrete transistors ensures proper operation over this wide range. Conventional logic circuits and ICs aren't specified for ± 24 operation and certainly not for 0V operation.

Q_1 and Q_4 control the solid-state relay through the current-limiting resistor, R_5 . The relay can only turn on when both Q_1 and Q_4 are on. Otherwise, R_1 shunts away leakage current to keep the relay off. The positive power supply turns on Q_1 through resistor divider R_1 and R_2 . The negative power supply turns on Q_4 through resistor divider R_6 and R_7 . Q_2 turns on when its base-to-emitter voltage (the voltage across R_1) is about 0.65V.

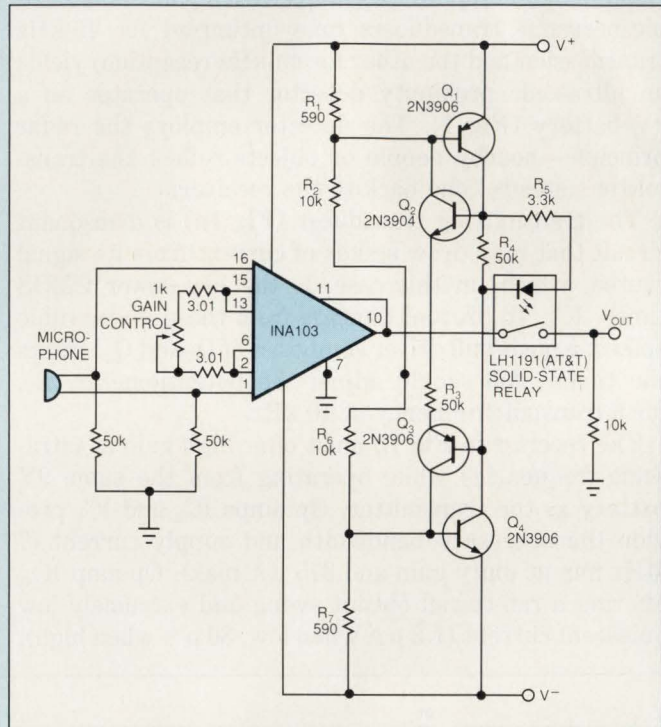

Fig 1—A \$1 solid-state relay disconnects the op amp's output if the supply voltages are below a defined threshold, thereby preventing anomalies at the op amp's output.

The power-supply turn-on threshold equals

$$0.65(R_1 + R_2)/R_1.$$

With Fig 1's values of R_1 and R_2 , Q_1 turns on when V^+ is approximately equal to 12V. Similarly, Q_4 turns on when V^- is approximately -12V.

When both Q_1 and Q_4 are on, the sum of the power-supply voltages appears across R_4 , turning on the solid-state relay. The voltage across R_4 also turns on transistors Q_2 and Q_3 , forcing a positive feedback current through R_1 , R_3 , and R_7 . This current creates hysteresis so that the solid-state relay "snaps" on and off, avoiding any possibility of turn-on oscillation even if the power supplies ramp up or down slowly. With the values shown, the amount of hysteresis is approximately 4V, and turn-off is approximately equal to $\pm(12V - 4V)$ or $\pm 8V$. EDN BBS /DI-SIG #1112

EDN

To Vote For This Design, Circle No. 747

99¢

from

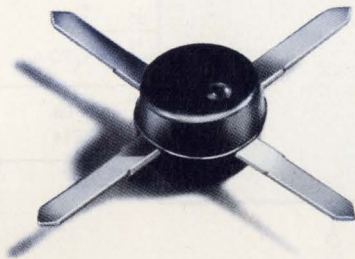

dc to 2000 MHz amplifier series

SPECIFICATIONS

MODEL	FREQ. MHz	GAIN, dB				• MAX. PWR. dBm	NF dB	PRICE \$ Ea.	Qty.
		100 MHz	1000 MHz	2000 MHz	Min. MHz (note)				
MAR-1	DC-1000	18.5	15.5	—	13.0	0	5.0	0.99	(100)
MAR-2	DC-2000	13	12.5	11	8.5	+3	6.5	1.35	(25)
MAR-3	DC-2000	13	12.5	10.5	8.0	+8□	6.0	1.45	(25)
MAR-4	DC-1000	8.2	8.0	—	7.0	+11	7.0	1.55	(25)
MAR-6	DC-2000	20	16	11	9	0	2.8	1.29	(25)
MAR-7	DC-2000	13.5	12.5	10.5	8.5	+3	5.0	1.75	(25)
MAR-8	DC-1000	33	23	—	19	+10	3.5	1.70	(25)

NOTE: Minimum gain at highest frequency point and over full temperature range.

- 1dB Gain Compression
- +4dBm 1 to 2 GHz

designers amplifier kit, DAK-2
5 of each model, total 35 amplifiers
only **\$59.95**

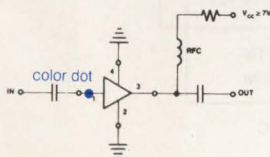

Unbelievable, until now... tiny monolithic wide-band amplifiers for as low as 99 cents. These rugged 0.085 in. diam., plastic-packaged units are 50ohm* input/output impedance, unconditionally stable regardless of load*, and easily cascadable. Models in the MAR-series offer up to 33 dB gain, 0 to +11dBm output, noise figure as low as 2.8dB, and up to DC-2000MHz bandwidth.

*MAR-8, Input/Output Impedance is not 50ohms, see data sheet. Stable for source/load impedance VSWR less than 3:1

Also, for your design convenience, Mini-Circuits offers chip coupling capacitors at 12 cents each.†

Size (mils)	Tolerance	Temperature Characteristic	Value
80 x 50	5%	NPO	10, 22, 47, 68, 100, 220, 470, 680, 1000 pf
80 x 50	10%	X7R	2200, 4700, 6800, 10,000 pf
120 x 60	10%	X7R	.022, .047, .068, .1µf

† Minimum Order 50 per Value

• Designers Kit, kcap-1, 50 pieces of each capacitor value, only \$99.95

finding new ways...
setting higher standards

Mini-Circuits

A Division of Scientific Components Corporation
P.O. Box 350166, Brooklyn, New York 11235-0003 (718) 934-4500
Fax (718) 332-4661 Domestic and International Telexes: 6852844 or 620156

C113-Rev. D

Dual-port RAM connects microprocessors

Adrian B Cosoroaba, Fujitsu Microelectronics Inc, San Jose, CA

The dual-port RAMs in Fig 1 connect a 32-bit 80486 to a 16-bit 68000. The RAMs mediate the difference in bus width as well as the reversed byte order of the two processors. The circuit uses four dual-port RAMs with one configured as a master device. The 80486 interfaces directly to the RAMs; the 68000 requires a

74LS139 decoder to select the proper memory devices. If both μ Ps try to write to the same location simultaneously, the RAMs' BUSY R lines signal the 80486 to wait. EDN BBS /DL_SIG #1079 EDN

To Vote For This Design, Circle No. 748

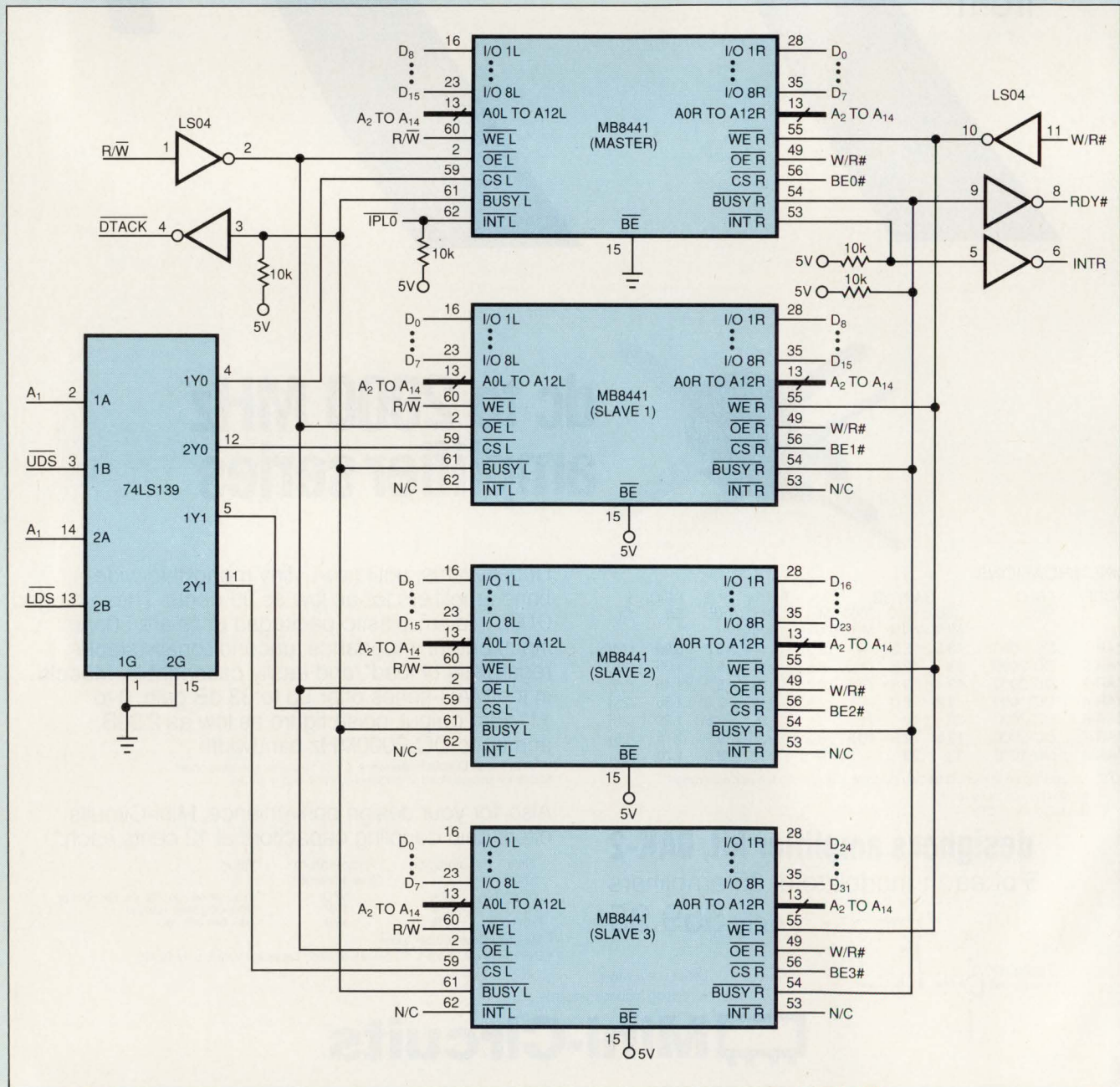

Fig 1—A bank of dual-port RAMs mediates the difference in bus width as well as the reversed byte order of the two interconnected μ Ps.

WHEN IT COMES TO SURFACE MOUNT CRYSTAL UNITS, ONLY RALTRON HAS IT ALL.

RALTRON manufactures one of the industry's most complete lines of high quality crystal units. Call us for all your crystal needs from micro-processor to AT strip to tuning fork to high accuracy. Or call us for our 28 page catalogue.

NEW! SURFACE MOUNT CRYSTAL UNIT- 2.5 MM HEIGHT - T25 SMD

- Frequency Range: 3.5 MHz-50 MHz
- Oscillation Mode: Fundamental to 3rd O.T.
- Frequency Tolerance: ± 50 ppm @ 25°C
- Frequency Stability: ± 50 ppm (-10°C to +60°C)

NEW! SURFACE MOUNT CRYSTAL UNIT- 3.0 MM HEIGHT- HC-49 SHORT SMD

- Frequency Range: 8 MHz-50 MHz
- Oscillation Mode: Fundamental to 3rd O.T.
- Frequency Tolerance: ± 50 ppm @ 25°C
- Frequency Stability: ± 100 ppm max (-10°C to +60°C)

• Crystals • Crystal Oscillators • Crystal Filters • Ceramic Resonators

RALTRON

ELECTRONICS CORP.

2315 NW 107th Avenue, Miami, Florida 33172 U.S.A.
FAX (305) 594-3973 TELEX 441588 RALSEN
(305) 593-6033

CIRCLE NO. 105

LOOKING FOR A QUALITY BOARDHOUSE?

ALL YOUR CIRCUIT BOARD NEEDS UNDER ONE ROOF

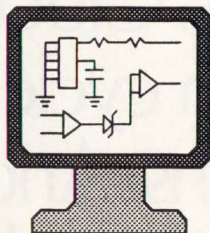

PCB MANUFACTURING

- 2 Day turn on multi-layers
- Prototype and production
- Gerber Data Review
- Database/Netlist test

PCB LAYOUTS

- Backplanes
- Impedance control
- Analog and ECL
- SMT both sides

TECHNICAL ASSISTANCE

- PCB layout tips
- Mfg cost cutting tips
- Artwork standards
- Gerber Data via modem, 24 hours (714) 970-5015

CALL FOR A QUOTE!

A MANUFACTURING, LAYOUT AND SUPPORT CENTER

MCD

MURRIETTA
CIRCUITS

4761 E. HUNTER AVE. ANAHEIM, CA. 92807
TEL: (714) 970-2430 FAX: (714) 970-2406

CIRCLE NO. 106

WE FIND THAT QUALITY IS THE BEST DEFENSE



Defense is the most critical environment for electronic components, posing unique problems and demanding unflinching high performance.

With a tradition dating back fifty years, Oxley Developments have become the cutting edge of technology in this stringent environment. Founded in the heat of the Second World War, we boast a proud history in the development and supply of high performance defense components.

Today's panel mounting indicator lamps and assemblies continue that tradition of quality. Solid state LEDs provide ultimate reliability, with the options of sunlight viewability, electromagnetic and night vision goggle compatibility. IR-free secure lamps are also available for covert applications. All lamps feature a rugged metal and glass construction offering full environmental performance.

Naturally, this extensive range of indicator lamps is qualified to MIL and DESC standards. The range being manufactured and quality assured within our ISO 9001, CECC and NATO-AQAP-1 (MIL-Q-9858A) approved system.

Today's quality is forged from a history of excellence: a tradition of expertise to help you build a confident future.

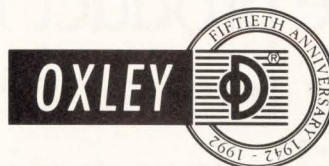

OXLEY INC

25 Business Park Drive, PO Box 814, Branford CT 06405
Tel: (203) 488 1033 Tlx: 910-350 6660 Fax: (203) 481 6971

TECHNOLOGY WORTH WATCHING

CIRCLE NO. 107

"Some products shouldn't be rushed to market. Like fine wine. Hard to beat a '66 Mouton Rothschild. On the other hand, certain products must get to market fast. Remember the Manhattan project? Or Apollo 11, that giant leap for mankind? Here's a classic. The speedy return of original formula Coca-Cola. One of the few times when new wasn't necessarily better. And then there's the time crunch facing design engineers in the 90s. Late to market means lost revenue. And the competition rolls over you. Smiling. That's where Altera's MAX7000 comes in. A family of programmable logic with predictable speed and density. 1000 to 20,000 usable gates. Clock rates over 80 MHz. Vrooom! Design cycles measured in hours, not days or months. And the easiest-to-use design software. Oh yeah, there's one product MAX 7000 can't bring to market any faster. Babies. Still about nine months from concept to delivery."



They're big. They're fast. They're everything you've asked for. To be first to market, be first to the phone. Call 800-800-7256.

©1992, Altera Corporation. MAX is a registered trademark of Altera Corporation. Coca-Cola is a registered trademark of the Coca-Cola Company.

MAX7000

USER-FRIENDLY ASIC SUPPORT AT YOUR FINGERTIPS

Local Resources Speed ASIC Design Cycle

Easy access to ASIC support means fast design cycles—and fast time to market. Oki's East and West Coast design centers offer the local, comprehensive ASIC resources you need for quick turnaround times.

With Oki, you work in a user-friendly environment equipped with state-of-the-art workstations, industry-standard CAD tools, advanced software support, and an experienced staff. We provide leading-edge 0.8 μ m sea-of-gate, standard cell, and 3-volt technology. Plus we assign a task team to your project, ensuring a steady communications link and a speedy, successful design flow.

For easy access to complete, local ASIC design support, call 1-800-OKI-6388 today. To receive Oki's ASIC Capabilities Brochure, ask for Package 057.



Oki ASIC Design Tool Support for 0.8 μ m, 1.0 μ m, & 1.2 μ m

Vendor	Platform	Operating System/Application
Cadence	Sun/Solbourne	Verilog: Simulation, fault grading, design verification
DAZIX	Sun	Design capture, simulation
IKOS	IKOS	Simulation, fault grading
Mentor Graphics	HP/Apollo Sun/Solbourne	Design capture, simulation Parade: Layout, clock and timing structures
Synopsys	Sun-4 Interface to Mentor, Valid, Viewlogic	Design synthesis, test synthesis
Valid	Sun/Solbourne DECstation 3100 IBM RS6000	Design capture, simulation Design check GED, ValidSIM, RapidSIM
VIEWlogic	Sun-4 PC386	Design capture, simulation Design check

All brands, product names, and company names are trademarks or registered trademarks of their respective owners.

TRANSFORMING TECHNOLOGY INTO CUSTOMER SOLUTIONS



OKI
Semiconductor

785 North Mary Avenue
Sunnyvale, CA 94086-2909
800-OKI-6388

EDN April 9, 1992 • 151

The new Tektronix 224 is as powerful as they come. And goes!



With this new 60 MHz digital oscilloscope, Tektronix takes handheld performance to an even higher plane! The 224 packs more power per pound than any other product and — with its on-board rechargeable batteries — goes wherever duty calls.

With its exclusive IsolatedChannel™ architecture, you can make two-channel floating measurements without the risk of shock or damage to delicate electronics. Such standards as Tek's sharp, bright CRT, rapid update rate and wide viewing angle make measuring fast and efficient. And the 224's familiar front panel and fully automated features keep it simple.

You get advanced capabilities like video line triggering and 10 MS/s digitizing per channel for excellent single-shot performance, plus time-correlated single-shot waveforms for easy comparison. With CAT200 software you can even control the 224 over phone lines from halfway round the world.

Call 1-800-426-2200 Ext. 83 to get the full story. We'll show you more of the 224 — and ways it's giving bench performance wings!

Tektronix
Test and Measurement

Integrated Circuits

TEKTRONIX DISTRIBUTORS TEST AND MEASUREMENT PRODUCTS Stocking Distributors

Alaska

Frigid North
Anchorage, AK
(907) 561-4633

Arizona

CMI-Metermaster
Tempe, AZ
(602) 431-0880

Jensen Tools Inc.

Phoenix, AZ
(602) 968-6241

Arkansas

Carlton Bates
Little Rock, AR
(501) 562-9100

California

Instrument Engineers
San Diego, CA
(619) 268-8344

ITC Electronics

Los Angeles, CA
(213) 388-0621

Marshall Industries

El Monte, CA
(800) 522-0084

RAG

Canoga Park, CA
(818) 998-6500

Zack Electronics

Milipitas, CA
(408) 942-5432

Florida

EMSCO
Orlando, FL
(407) 849-6060

Georgia

Dow Electronics, Inc.

Norcross, GA
(404) 446-2620

Illinois

Joseph Electronics
Niles, IL
(312) 297-4200

Klaus Radio, Inc.

Peoria, IL
(309) 691-4840

W.W. Grainger

North Suburban, IL
(708) 913-7459
(800) 521-5585

Maryland

HARCO
Aberdeen, MD
(301) 838-7990

TESSCO

Hunt Valley, MD
(301) 785-5300

Massachusetts

Contact East
North Adover, MA
(508) 682-2000

Michigan

Great Lakes
Battle Creek, MI
(616) 963-6282

R.S. Electronics

Livonia, MI
(313) 525-1155
(800) 366-7750

Minnesota

Stark Electronics Supply
Minneapolis, MN
(612) 332-1325

Missouri

Olive Electronics
Maryland Heights, MO
(314) 997-7709

Electronic Supply Co.

Kansas City, MO
(314) 931-0250

ISL Corporation

St. Louis, MO
(314) 423-3141

New Mexico

Electronic Parts Co.
Albuquerque, NM
(505) 293-6161

New York

Instrument Mart, Inc.
Great Neck, NY
(516) 487-7430

Transcat

Rochester, NY
(716) 458-4801
(800) 828-1470
(outside New York)

Pennsylvania

Leff Electronics
Braddock, PA
(412) 351-5000

Sunshine Scientific

Instruments, Inc.
Philadelphia, PA
(215) 673-5600

South Carolina

Dixie Electronics
Columbia, SC
(803) 779-5332

Texas

INOTEK
Dallas, TX
(214) 243-7000

ENTEST

Dallas, TX
(214) 980-9876

Utah

Standard Supply Company
Salt Lake City, UT
(801) 486-3371

Washington

Radar Electric
Seattle, WA
(206) 282-2511

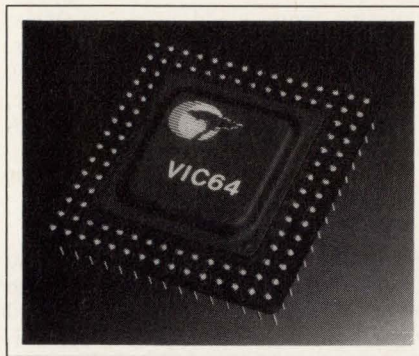

VMEbus controller. The VME64-compatible VIC64 VMEbus interface controller provides a seamless 64-bit upgrade from the company's VIC068. The VIC64 is pin compatible with the existing VIC068, incorporates the same industry-standard feature set, and uses the same software. By using the VMEbus's 32-bit address bus for data during its frequent idle periods, the VIC64 allows designers to implement 64-bit data transfers at 70 Mbytes/sec, doubling the performance of existing VMEbus backplanes. In 144-pin pin grid arrays and 160-pin quad flatpacks, from \$140 (100). **Cypress Semiconductor**, 3901 N First St, San Jose, CA 95134. Phone (408) 943-2600.

Circle No. 351

Static RAMs. Available in three versions, these 4-Mbit static RAMs (SRAMs) feature access times of 20 and 25 nsec. The μ PD434001LE has an organization of $4M \times 1$ bit, the μ PD434004LE $1M \times 4$ bits, and the μ PD434008LE $512k \times 8$ bits. Standby current drain is 10 mA for all versions, and active current ranges from 130 to 190 mA. In 32- and 36-pin SOJ packages, from \$600 (10). **NEC Electronics Inc.**, 401 Ellis St, Mountain View, CA 94039. Phone (415) 960-6000. FAX (415) 965-6130.

Circle No. 352

Laser-diode driver. Fabricated in GaAs, the ALD30011 laser-diode driver has a frequency range of 10 kHz to 3 GHz. Using a single $-5.2V$ supply, the driver can modulate a laser diode at bit rates to 2.5 Gbps and provide 80 mA of modulation current with 100-psec rise and fall times. A dual differential gain stage reduces pulse asymmetry. An on-chip 180° phase splitter enables single-ended input drive. \$97 (100). **Anadigics Inc.**, 35 Technology Dr, Warren, NJ 07060. Phone (201) 668-5000. FAX (201) 668-5068. TWX 510-600-5741.

Circle No. 353

386SX/DX microprocessors. High-performance versions of its Am386 microprocessor (μ P) family, the Am386SX and Am386SXL (low power) devices are available in a 33-MHz rating, and the Am386DX/DXL are available in a 40-MHz rating. All devices come in low-cost plastic packages. The Am386SX/SXL-33, in a 100-pin plastic quad flatpack, \$76; Am386DX/DXL-40, in a 132-pin plastic quad flatpack, \$114 (1000). **Advanced Micro Devices Inc.**, 901 Thompson Pl, Sunnyvale, CA 94088. Phone (408) 732-2400.

Circle No. 354

Math coprocessor. Targeted for high-performance portable computers, the IIT-3C87SX math coprocessor runs at 33 MHz and is compatible with existing 386SX μ Ps. Packaged in a plastic quad flatpack, approximately \$100 (OEM). **Integrated Information Technology Inc.**, 2445 Mission College Blvd, Santa Clara, CA 95054. Phone (408) 727-1885. FAX (408) 980-0432. Circle No. 355

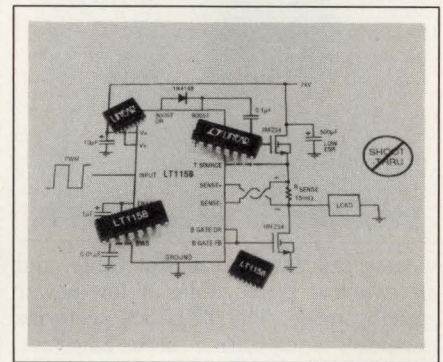

High-speed, 10-bit A/D converter.

The TLC1550 successive-approximation register (SAR) ADC supports high-performance systems. Unlike 10-bit ADCs with an 8-bit bus, which require two read instructions, the TLC1550's 10-bit bus requires only a single instruction. A 3-state parallel port interfaces directly with most DSP and μ P system data buses. Data-access time is 35 nsec, and maximum unadjusted error is ± 1 LSB. In 28-pin plastic leaded chip carriers or 24-pin DIPs, from \$4.87 to \$6.27 (1000). **Texas Instruments**, Semiconductor Group (SC-92010), Box 809066, Dallas, TX 75380. Phone (800) 336-5236, ext 3990; outside US, (214) 995-6611, ext 3990.

Circle No. 356

Am386SX-compatible chip sets. Designed to work with the 33-MHz Am386SX microprocessor, these chip

Tektronix

Test and Measurement

EDN-NEW PRODUCTS

Integrated Circuits

sets support desktop and notebook computers. The OTI-020 provides 70% of the additional circuitry needed in a 386-based desktop computer. The OTI-040, which contains power-management functions that extend battery life, provides 80% of the circuitry needed in a 386-based notebook computer. OTI-020 and OTI-040, \$21 and \$40, respectively, (1000). **Oak Technology Inc.**, 139 Kifer Ct, Sunnyvale, CA 94086. Phone (408) 737-0888. FAX (408) 737-3838.

Circle No. 357

Programmable telecomm ICs. The TEL5100 programmable gain/attenuator chip and the TEL5500 programmable equalizer chip suit PBX, central-office-equipment, and telephone-switch applications. The TEL5100 provides low-noise logarithmic gain or attenuation from -16.5 dB to +16 dB, in steps of 0.1 dB. A diagnostic capability allows external examination of the pre-

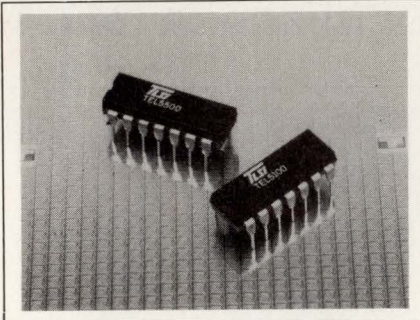

viously programmed digital value, and an external pin enables a low-power standby mode. The TEL5500 performs low-noise equalization according to a transfer function defined by slope, bandwidth, and height values input by the user. TEL5100 and TEL5500, from \$8.15 and \$5.65, respectively, (2500). Delivery, six to eight weeks ARO. **Telephonics Corp.**, 815 Broad Hollow Rd, Farmingdale, NY 11735. Phone (516) 755-7000. FAX (516) 755-7046.

Circle No. 358

Clock-rate adapters. Three clock-rate adapters work in North American T1 and European E1 applications. The LXP602 generates a 1.544-MHz clock locked to a 2.048-MHz master clock, or vice-versa, and also provides an 8.192-MHz high-frequency output (HFO) clock. The LXP604 generates a 1.544-MHz clock locked to 4.096-MHz master clock, or vice-versa, and also provides an HFO of 8.192 or 6.176 MHz. The LXP610 is a universal device that provides any of 17 frequency combinations

ranging from 1.544 to 8.192 MHz. LXP602 and LXP604, in 8-pin DIPs, \$12.75; LXP610, in a 14-pin DIP, \$14.50 (100). **Level One Communications Inc.**, 105 Lake Forest Way, Folsom, CA 95630. Phone (916) 985-3670.

Circle No. 359

Programmable FIR filter. Operating at speeds to 40 MHz, the MC27HC68 programmable filter suits HDTV and video-conferencing applications. Addressing static-programming applications, the device does not reprogram filter coefficients during operation. As a result, there is no need to continually recalculate the products of the input samples and filter coefficients. A single device can implement filters with 16 to 24 taps, and a 16-bit carry input allows cascading of devices. MC27HC68, in a 68-pin ceramic LCC with quartz lid, from \$59 (1000). **SGS-Thomson Microelectronics**, 1000 E Bell Rd, Phoenix, AZ 85022. Phone (602) 867-6100. FAX (602) 867-6290.

Circle No. 360

Clock generator. Operating at speeds to 275 MHz, the Bt440 programmable clock generator provides timing for high-speed RAMDACs used in high-resolution graphics applications. Interfacing to a low-frequency quartz crystal, the IC multiplies the clock oscillator by 8, 16, 20, or 32 times the base frequency to generate the pixel clock signals that drive the RAMDACs. A single crystal can provide resolutions of 1152 x 900, 1280 x 1024, and 1600 x 1280 pixels. In a 28-pin plastic leaded chip carrier, \$25 (100). **Brooktree Corp.**, 9950 Barnes Canyon Rd, San Diego, CA 92121. Phone (619) 452-7580. FAX (619) 452-1249. TLX 383596.

Circle No. 361

Half-bridge n-channel power MOSFET driver. Featuring synchronously controlled high- and low-side drivers that can operate from dc to 100 kHz, the LT1158 eases the design of low-voltage switch-mode controllers that use n-channel power MOSFETs. The driver can switch a 3000-pF capacitive load in 150 nsec and a 10,000-pF load in 250 nsec. Adaptive nonoverlap gate drives eliminate size and matching requirements for the power MOSFETs. The LT1158, in 16-pin DIP and SO packages, from \$3.15 (100). **Linear Technology Corp.**, 1630 McCarthy Blvd, Milpitas, CA 95035. Phone (800) 637-5545; (408) 432-1900. FAX (408) 434-0507.

Circle No. 362

Where you can learn a little black magic.

If you'd like to learn a few new tricks in analog design, check the schedule of the Analog Devices Advanced Linear Design Seminar below and then reserve your space by calling 1-800-ANALOGD (in Canada, call 617-937-1430) today.

NORTH AMERICA

City	Date
Cleveland, OH	May 5
Detroit, MI	May 6
Santa Clara, CA	May 7
Burlington, MA	May 7
Pleasanton, CA	May 8
Milwaukee, WI	May 11
San Diego, CA	May 11
Chicago, IL	May 12
Irvine, CA	May 12
Houston, TX	May 13
Woodland Hills, CA	May 13
Dallas, TX	May 14
Phoenix, AZ	May 14
Dayton, OH	May 15
Denver, CO	May 15
Minneapolis, MN	May 18
Huntsville, AL	May 18
Waterbury, CT	May 19
Atlanta, GA	May 19
Whippany, NJ	May 20
Tampa, FL	May 20
Smithtown, NY	May 21
Orlando, FL	May 21
Santa Clara, CA	May 27
Rochester, NY	May 27
Beaverton, OR	May 28
Toronto, Can	May 28
Bellevue, WA	May 29
Montreal, Can	May 29
Waltham, MA	June 1
Raleigh, NC	June 2
Ft. Washington, PA	June 3
Baltimore, MD	June 4
McLean, VA	June 5

EUROPE

City	Date
Copenhagen, Denmark	May 4
Berlin, Germany	May 5
Wiesbaden, Germany	May 6
Hamburg, Germany	May 7
München, Germany	May 8
Vienna, Austria	May 11
Zürich, Switzerland	May 12
Lyon, France	May 13
Paris, France	May 14
London, England	May 15
Edinburgh, Scotland	May 18
Eindhoven, Netherlands	May 19
Stockholm, Sweden	May 20
Rome, Italy	May 21
Milan, Italy	May 22

Far East and Japan seminars to be held in June. Please call 1-617-937-1430 for schedule.



If you've always thought linear design involved a little black magic, here's where you can learn a few of the tricks.

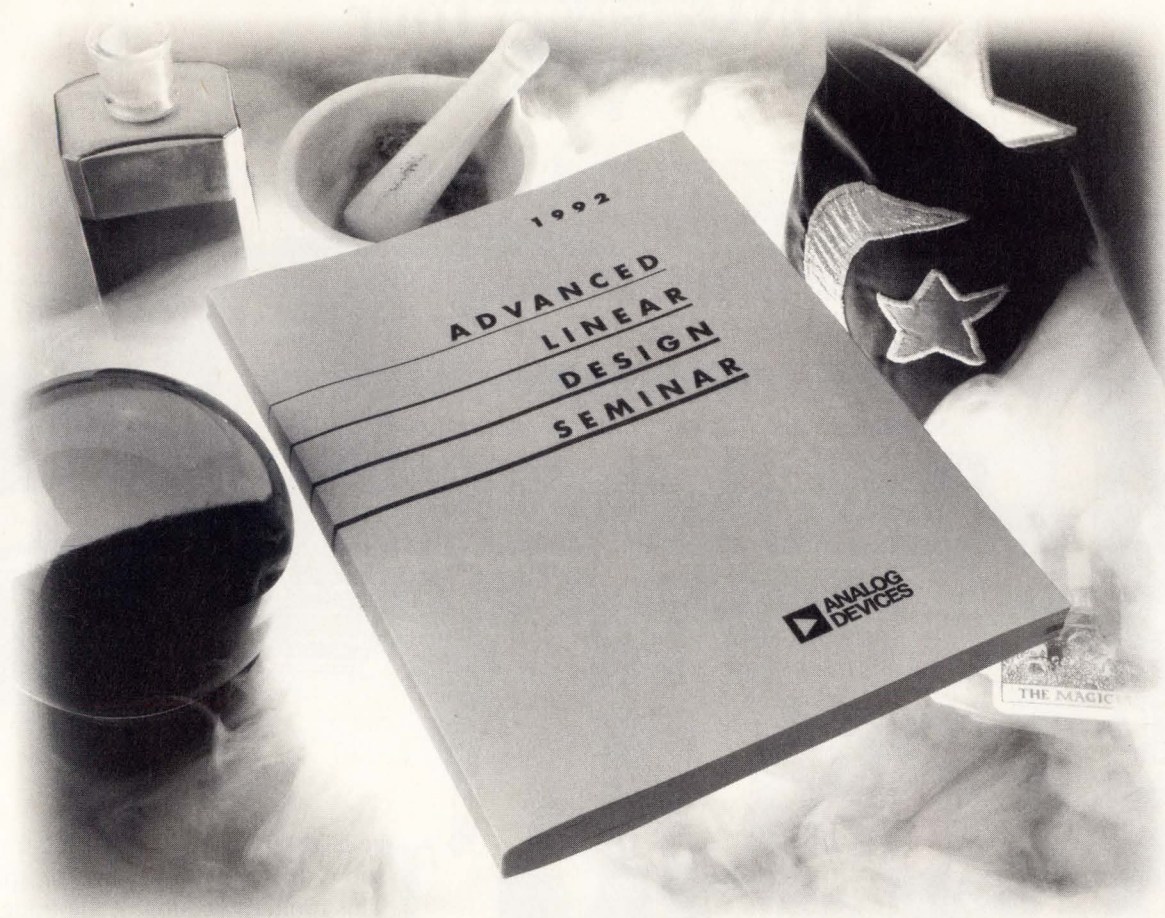

If you're one of the few engineers who realizes the world of analog design isn't all that mysterious, you'll appreciate our Advanced Linear Design Seminar. Because it's the perfect opportunity to pick up a few new tricks.

Hosted by Analog Devices, one of the leading suppliers of analog and mixed-signal ICs, and its distributors, the seminar series will include talks by prominent design wizards such as Derek Bowers, Paul Brokaw, Lou Counts, Barrie Gilbert, Walt Jung, and others.

The full-day tutorials also include solutions-oriented discussions that are geared towards showing you how to increase system performance while actually lowering overall cost. Plus you'll get free product samples, our 700-page *Amplifier Applications Guide*, other technical reference materials, and more.

Admission to the seminar is just \$20, and it includes everything above, lunch, and refreshments.

So if you're a design wizard who wants to add to your repertoire of linear design tricks, it's no secret what you should do — call 1-800-ANALOGD (in Canada, call 617-937-1430) and reserve a seat today. Before they all disappear.



The Analog Devices Advanced Linear Design Seminar.

Analog Devices, Inc., One Technology Way, P.O. Box 9106, Norwood, MA 02062-9106. Headquarters: (617) 329-4700. Offices, applications support and distribution available worldwide.

EDN CARAVAN ELECTRONIC SHOW TOURS

The Electronic Trade Show on Wheels

The 1992 EDN Caravan Tour



The EDN sponsored "traveling trade show" hits the road again this spring. This modern version of the trade show delivers "hands on" working exhibits directly to the engineers' business doorstep. Over 100 leading electronic equipment manufacturers across the country will host the EDN Caravan Show on-site. Factory and local experts will staff exhibits on-board the customized mobile showroom. In a matter of minutes, engineers can watch or operate demos, ask questions and learn about up-to-the-minute product developments.



Nicolet
INSTRUMENTS OF DISCOVERY



Check EDN Caravan Show schedule and mark your calendars now for the date we visit your company. Make it a point to attend this unique electronics exhibit and look for the suppliers listed here. (schedule subject to change.)

EDN CARAVAN ELECTRONIC SHOW TOURS

The Electronic Trade Show on Wheels

DATE	TIME	LOCATION	DATE	TIME	LOCATION
3/16	9:00-11:00	BOEING HUNTSVILLE	Wednesday	AM-PM	Palm Bay Road, Palm Bay, FL
Monday	AM	499 Boeing Blvd., Huntsville, AL	4/1	2:30-4:00	GRUMMAN MELBOURNE SYSTEMS
3/16	12:30-2:30	INTERGRAPH CORPORATION	Wednesday	PM	2000 NASA Blvd., Melbourne, FL
Monday	PM	Intergraph Way, Huntsville, AL	4/2	9:00-12:00	MARTIN MARIETTA CORP., ESD
3/17	8:30-10:00	ACUSTAR INC.	Thursday	AM	12506 Lake Underhill Road, Orlando, FL
Tuesday	AM	100 Electronics Blvd., Huntsville, AL	4/2	1:30-3:30	MARTIN MARIETTA CORP., MSD
3/17	11:00-12:30	AVEX ELECTRONICS	Thursday	PM	5600 Sand Lake Road, Orlando, FL
Tuesday	AM-PM	4807 Bradford Drive, Huntsville, AL	4/3	9:00-11:00	SIEMENS STROMBERG-CARLSON
3/17	1:30-3:30	TELEDYNE BROWN ENGINEERING	Friday	AM	400 Rinehart Road, Lake Mary, FL
Tuesday	PM	5021 Bradford Blvd., Huntsville, AL	4/3	1:00-3:00	GENERAL ELECTRIC, Simulation & Control
3/18	9:00-11:00	SCI TECHNOLOGY (Plant 3 & 13)	Friday	PM	1800 Volusia Avenue, Daytona Beach, FL
Wednesday	AM	13000 So. Memorial Parkway, Huntsville, AL	4/6	9:00-11:30	IBM CORPORATION
3/18	12:30-2:30	SCI TECHNOLOGY (Plant 1)	Monday	AM	Research Triangle Park, RTP, NC
Wednesday	PM	8600 S. Memorial Parkway, Huntsville, AL	4/6	12:30-2:00	NORTHERN TELECOM, INC./BNR
3/19	1:00-3:00	BNR/NORTHERN TELECOM	Monday	PM	4001 E. Chapel Nelson Hwy., RTP, NC
Thursday	PM	705 Westech Drive, Norcross, GA	4/6	2:45-4:15	NORTHERN TELECOM, INC.
3/20	9:00-10:00	OKI TELECOM GROUP	Monday	PM	400 Perimeter Park Dr., Morrisville, NC
Friday	AM	437 Old Peachtree Road, Suwanee, GA	4/7	9:00-11:00	ALCATEL NETWORK SYSTEMS
3/20	12:30-2:00	RELIANCE ELECTRIC	Tuesday	AM	2912 Wake Forest Road, Raleigh, NC
Friday	PM	Collins Industrial Blvd., Athens, GA	4/7	1:30-4:00	AT&T TECHNOLOGIES, Guilford Center
3/23	9:00-10:30	NCR CORPORATION	Tuesday	PM	Mount Hope Church Rd., McLeansville, NC
Monday	AM	7240 Moorefield Highway, Liberty, SC	4/8	9:00-11:00	GENERAL ELECTRIC COMPANY
3/23	1:00-3:30	NCR CORPORATION	Wednesday	AM	1501 Roanoke Blvd., Salem, VA
Monday	PM	3325 W. Platt Springs Rd., W. Columbia, SC	4/8	1:30-3:30	ERICSSON/GE Mobile Communications
3/25	8:30-11:00	AT&T PARADYNE CORPORATION	Wednesday	PM	Mountain View Road, Lynchburg, VA
Wednesday	AM	8545 126th Avenue N., Largo, FL	4/9	9:00-11:00	SPERRY MARINE, INC.
3/25	1:00-3:00	GROUP TECHNOLOGIES CORP.	Thursday	AM	Route 29 North, Charlottesville, VA
Wednesday	PM	10901 Malcolm McKinley Dr., Tampa, FL	4/9	12:30-2:30	GE FANUC AUTOMATION NA, INC.
3/26	9:30-12:00	HONEYWELL, INC., Avionics	Thursday	PM	US 29 & Rt 606, Charlottesville, VA
Thursday	AM	13350 US Highway 19 So., Clearwater, FL	4/10	8:30-11:00	E-SYSTEMS, INC., Melpar Div.
3/26	1:00-3:00	SMITHS INDUSTRIES, Aero. & Defense	Friday	AM	7700 Arlington Blvd., Falls Church, VA
Thursday	PM	14180 Roosevelt Blvd., Clearwater, FL	4/10	12:30-2:30	E-SYSTEMS, INC., Melpar Div.
3/27	8:30-11:00	E-SYSTEMS, INC., ECI Div.	Friday	PM	11225 Waples Mill Road, Fairfax, VA
Friday	AM	1501 72nd Street N., St. Petersburg, FL	4/13	9:00-10:30	PULSECOM INC.
3/27	1:00-2:30	LORAL DATA SYSTEMS	Monday	AM	2900 Towerview Road, Herndon, VA
Friday	PM	6000 Fruitville Road, Sarasota, FL	4/13	1:30-3:30	LITTON SYSTEMS, Amecom Div.
3/30	9:00-11:00	RACAL-DATACOM, INC.	Monday	PM	5115 Calvert Road, College Park, MD
Monday	AM	1601 N. Harrison Parkway, Sunrise, FL	4/14	9:00-10:30	FAIRCHILD COMM. & ELECTRONICS
3/30	12:30-3:00	MOTOROLA INC.	Tuesday	AM	20301 Century Blvd., Germantown, MD
Monday	PM	8000 W. Sunrise Blvd., Plantation, FL	4/14	11:30-2:00	HUGHES NETWORK SYSTEMS, INC.
3/31	8:30-10:30	BENDIX/KING, Air Transport Avionics	Tuesday	AM-PM	11717 Exploration Lane, Germantown, MD
Tuesday	AM	2100 N.W. 62nd Street, Fort Lauderdale, FL	4/15	9:00-12:00	WESTINGHOUSE CORPORATION (BWI)
3/31	12:30-3:00	IBM CORPORATION	Wednesday	AM	Route 170, Linthicum, MD
Tuesday	PM	1000 N.W. 51st Street, Boca Raton, FL	4/16	9:00-11:00	ALLIED SIGNAL AEROSPACE
4/1	8:30-10:00	ROCKWELL INTL., Collins Aviation	Thursday	AM	1300 E. Joppa Road, Baltimore, MD
Wednesday	AM	600 John Rodes Blvd., Melbourne, FL	4/16	12:30-2:30	AAI CORPORATION
4/1	11:00-1:00	HARRIS CORPORATION, ESD	Thursday	PM	110 Industry Lane, Cockysville, MD

 **POWERCUBE**

C A H N N E R S

 **CAPS**

Computer Aided
Product Selection

EAGLE EP PICHER

 **PTS**

FREQUENCY SYNTHESIZERS

 **VIEWlogic**

 **IEE** DISPLAYS
KEYBOARDS
CONTROL PANELS

 **ZYCAD**

 **Elco Corporation**
A Kyocera Group Company

A COMPANY OF
VISHAY
RESISTIVE SYSTEMS

 **MCKENZIE TECHNOLOGY**

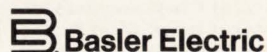
 **Basler Electric**

World Class Connections

A Subsidiary of Elco Corporation
A Kyocera Group Company

 **LeCroy**
Innovators in Instrumentation

 **WAVETEK**

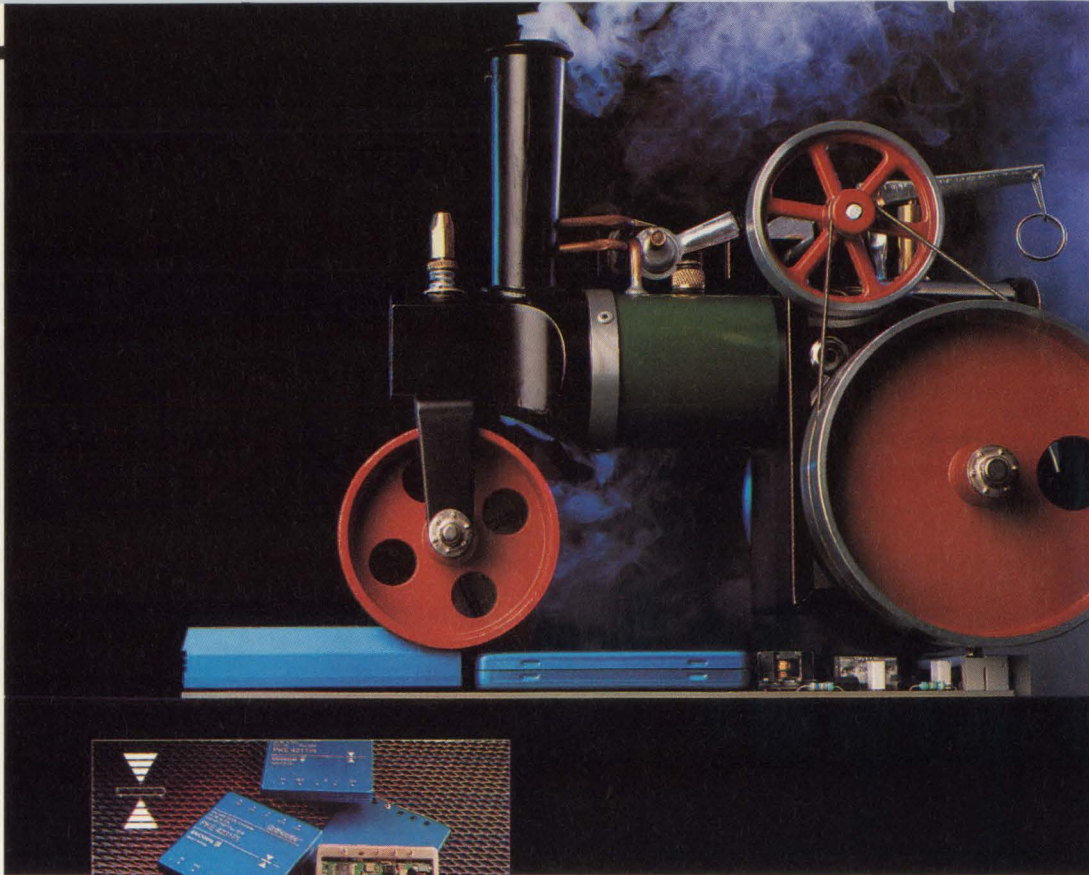

The Power in Telecommunications

The squeeze is on

Slimming is an obsession in the electronics industry as engineers face the task of making thinner cards to fit even more functions into standard racks. Once again Ericsson can help.

The new PKE is a 25-30 W DC/DC converter squeezed into a slim package little more than half the height of its predecessor, the internationally acclaimed PKA converter. The PKE is only 10.7 mm (0.42") high and has the same 3"x3" industry-standard footprint and pin out.

Having set the standard for DC/DC converters in 1983, Ericsson's new series represents a remarkable leap forward in power supply technology. The PKE needs no power derating over its entire ambient temperature range of -45 to +85 °C. Quite simply, no one else achieves this in so little space. And you can choose from versions with one, two or three regulated outputs.

Perhaps most surprisingly, performance is in no way compromised by the size reduction. In fact, the PKE is even better than the PKA. A wide input voltage of 38 to 72 VDC is complemented by 1500 VDC isolation, 80-85% typical efficiency and two million hours MTBF at +45 °C ambient.

The PKE converter from Ericsson - slim, compact and beautifully formed. Squeeze in the time to call us for more information.

Please send me your latest information

EDN 4-9-92

Name _____

Company _____

Job Title _____

Address _____

Telephone _____

Fax _____

France: Ericsson Components Europe, Guyancourt, Tel: +33-1-30 64 85 00 Fax: +33-1-30 64 11 46
Germany: Ericsson Components Europe, Neu-Isenburg, Tel: +49-6102-200 50 Fax: +33-6102-20 05 33
Great Britain: Ericsson Components Europe, Coventry, Tel: +44-203-55 36 47 Fax: +44-203-22 58 30
Hong Kong: Ericsson Components, East Asia, Wanchai, Tel: +852-5-75 66 40 Fax: +852-834 53 69
Italy: Ericsson Components Europe, Milano, Tel: +39-2-33 20 06 35 Fax: +39-2-33 20 06 41
Norway: Ericsson Components A/S, Oslo, Tel: +47-2-65 01 90 Fax: +47-2-64 41 38
Sweden: Ericsson Components AB, Stockholm, Tel: +46-8-757 43 84 Fax: +46-8-757 44 21
United States: Ericsson Components Inc, Richardson, TX, Tel: +1-214-997-6561 Fax: +1-214-680-1059

ERICSSON 

IN THE TIME IT TAKES TO READ THIS AD, YOU COULD ROUTE THE WORLD'S FASTEST FPGA.

Believe it or not, it only takes about 150 seconds to place and route a Xilinx FPGA.

It will probably take you longer to read this ad.

THE FIRST AND STILL THE FASTEST.

At Xilinx we invented the FPGA. And we've led the industry ever since.

With the fastest, highest performance FPGAs available anywhere.

Today, we offer system clock speeds of 60 MHz. With on-board RAM. And on-chip wide decode.

Making our newest FPGAs ideal for everything from FIFOs to address decoding.

NEW ENHANCED SOFTWARE PROVIDES PUSH BUTTON SOLUTION.

To make Xilinx FPGAs even faster and easier to program, we've redesigned our software.

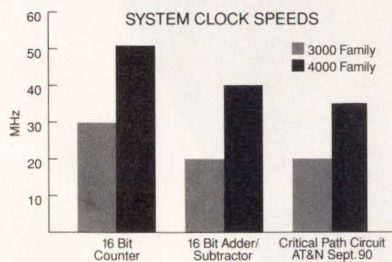

As measured by typical design benchmarks, the XC3000 family is the industry's fastest FPGA. Or at least it was until we introduced the 4000 family.

Our new version of XACT™ now comes with 200 soft macros. And fifty hard macros.

Providing automatic placing and routing for virtually all designs. With greater than 90% gate utilization.

If you've worked with Xilinx FPGAs before, you'll see improve-

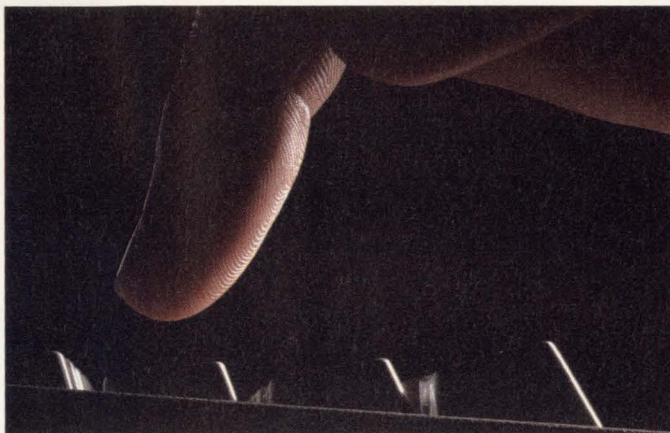

Our new push-button software makes programming other logic devices seem positively tedious.

ments even before you start to place and route your design.

If you've never worked with Xilinx FPGAs before, you'll find every other logic device to be positively tedious by comparison.

WHEN IT COMES TO SYSTEM TESTING, WE PASS WITH FLYING COLORS.

Our newest FPGAs offer you the industry's first on-chip JTAG boundary scan for easy testing of PC boards and device I/Os.

This unique Xilinx offering improves overall system testability and dramatically reduces board test costs. A major boost for those designing high-density, surface mount systems or complex, multi-layer PC boards.

IF AT FIRST YOU DON'T SUCCEED, IT'S EASY TO TRY AGAIN.

Xilinx FPGAs can be quickly

reprogrammed an unlimited number of times.

Our FPGAs save you an enormous amount of time right up front. And they also save you time later when you need to make those "last minute" enhancements.

It's one more way we make it easier for you to get your product to market as fast as possible.

GETTING AN EDGE OVER YOUR COMPETITORS IS JUST A PHONE CALL AWAY.

If you've read this far, you could have already placed and routed one of our FPGAs.

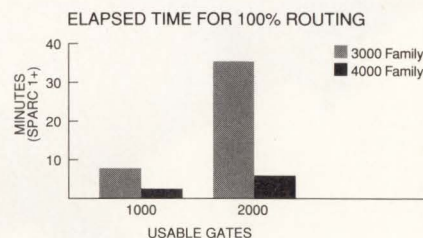

New algorithms have reduced place and route times by a factor of four.

So don't delay. No other programmable logic company offers you the many exclusive features of Xilinx FPGAs.

Call 1-800-255-7778. Or in California, 408-559-7778. And we'll send you more information on how our FPGAs can give you the competitive edge.

But you better hurry.

Some of your competitors have already finished reading this ad.



The Programmable Gate Array Company.™

So many
interconnection
choices.

One
solution.

**Augat offers you a choice in
SIMM Metal Latch Sockets.**

Augat's 3950 Series Metal Latch SIMM Sockets provide a more reliable, user friendly interconnect for memory modules. Memory upgrades are easy with Augat's patent pending latch design. Our unique design offers you the choice of readily accessing the latch from the front sides of the socket. A great advantage when modules are closely stacked or difficult to reach.

Rugged, stainless steel latches provide positive retention with an audible "click" indicating memory module is fully engaged. High performance LCP molded

insulators proven to be dimensionally stable through IR processing combine with an anti-overstress contacts designed to accommodate the full range of JEDEC dimensioned modules.

Augat, "the first name in sockets", continues to provide the quality and innovation you expect.

Available from stock in popular sizes on .050" and .100" centerlines or through your local distributor.

AUGAT[®] *Quality
and Innovation*
INTERCONNECTION PRODUCTS DIVISION

We encourage you to get complete technical and delivery information on these or any other interconnection components you require.

452 John Dietsch Boulevard
Attleboro Falls, MA 02763 USA
Tel: (508) 699-9800 FAX: (508) 699-6717
CIRCLE NO. 133

EDN-NEW PRODUCTS

Computers & Peripherals

Ethernet Cards. The Interlan AT and Interlan AT TP are 8- or 16-bit ISA bus Ethernet cards. The AT board has an attached-unit interface (AUI) and a BNC connector for thick and thin Ethernet networks. The AT TP board has an AUI and an RJ-45 connector for thick and 10Base-T networks. The boards have 16 kbytes of memory-mapped RAM. A LAN Talk disk contains Novell Netware 286/386, NDIS for DOS and OS/2, and Unix Streams software drivers. \$229. **Racal-Datacom Inc.**, 155 Swanson Rd, Boxborough, MA 01719. Phone (800) 526-8255; (508) 263-9929. FAX (508) 263-8655. **Circle No. 363**

Sbus synchronous-communication board. The Model PT-SBS332 synchronous-communications board for the SBus employs Zilog's 16C35 Integrated Serial Communications Controller (ISCC) chip and Motorola's MC68340 Integrated Processor. It provides two serial ports that communicate at T1 (1.544 Mbps) and E1 (2.048 Mbps) rates on both ports. The board employs the company's Line Adapter Board (LABs), which are small plug-on boards that de-

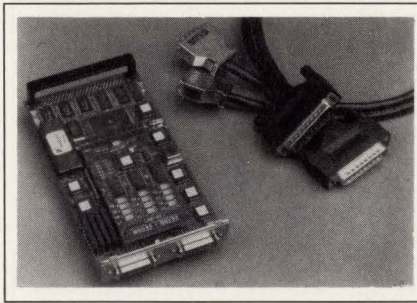

termine the specific line interfaces and can be upgraded in the field. Board with 2 Mbytes of RAM and an EIA-232C interface, \$1175. **Performance Technologies Inc.**, 315 Science Pkwy, Rochester, NY 14620. Phone (716) 256-0200. FAX (716) 256-0791. **Circle No. 364**

Parallel COM Board. The DB-PCOMM is a parallel communication board for the VMEbus. A high-speed 32-bit I/O port transfers synchronous data at 33 Mbytes/sec and asynchronous data at 22 Mbytes/sec. The board also has a general-purpose 8-bit port. It connects to the host via a VME subsystem bus interface and a Dbus-68 interface,

which permits 32-bit DMA transfers to the host. \$2995. **Matrix Corp.**, 1203 New Hope Rd, Raleigh, NC 27610. Phone (800) 848-2330; (919) 231-8000. FAX (919) 231-8001. **Circle No. 365**

ISA bus EEPROM boards. The PCE910 family EEPROM boards for the ISA bus use nonvolatile memory that can replace hard-disk storage. You can populate the boards with as much as 1 or 2 Mbytes of flash EEPROM. You can boot the board using an onboard BIOS, which simplifies installation and provides power-up diagnostics. \$1044 (100). **Memtech Technology**, 3000 Oakmead Village Ct, Santa Clara, CA 95051. Phone (408) 970-8900. FAX (408) 986-0656. TWX 910-250-1368. **Circle No. 366**

VMEbus dynamic-RAM card. The VRAM-10 all-CMOS memory board for the VMEbus comes in five versions that have 1, 2, 4, 8, or 16 Mbytes of dynamic RAM. The maximum access time is approximately 150 nsec. The board operates from 0 to 70°C, and it draws 100

Looking to Add TCP/IP Network Access to Your System Designs?

Introducing . . .

FUSION[®] Developer's Kit

Now you can incorporate the industry standard TCP/IP protocol suite in your system designs with FUSION Developer's Kit.

Designed for the OEM and systems integrator, FUSION Developer's Kit provides the full TCP/IP protocol suite including TELNET virtual terminal, file transfer protocol (FTP), and R-Commands to name a few.

FUSION Developer's Kit also has a flexible C-source code architecture, making it processor- and operating system-independent.

Currently used in hundreds of process control, embedded systems, and end user designs, FUSION Developer's Kit from Network Research comes with full support and porting services.

To receive a FUSION Developer's Kit information package, including data sheet, technical specifications and licensing plans call (800) 541-9508 or write to Network Research, 2380 N. Rose Ave., Oxnard, California 93030, FAX (805) 485-8204.

 **Network Research**

FUSION is a licensed trademark.

CIRCLE NO. 117

EDN-NEW PRODUCTS

Computers & Peripherals

mA of standby current. A front-panel LED indicates 9-bit parity errors. \$611. **Dynatem**, 15795 Rockfield Blvd, Suite G, Irvine, CA 92718. Phone (714) 855-3235. FAX (714) 770-3481. **Circle No. 367**

Serial I/O subsystems. The Megaplex/2 and Megaplex/RS are serial I/O subsystems for IBM PS/2 and RISC System/6000 Micro Channel Architecture computers. The systems directly con-

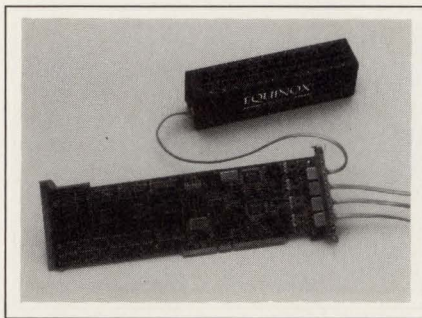

nect as many as 96 serial ports to the host using a single-slot controller board. Four 24-port multiplexers connect to the controller board via 4-wire links. As many as eight host controllers can be installed in a single computer, and you can locate the multiplexers as far as 2500 ft from the controller. The 24-port Megaplex/2 and Megaplex/RS configuration, consisting of a host controller, a multiplexer, manual, and software driver, \$2595 and \$2695, respectively. **Equinox Systems Inc**, 14260 SW 119 Ave, Miami, FL 33186. Phone (800) 275-3500. FAX (305) 253-0003.

Circle No. 368

Accurate to a T ... as well as B, E, J, K, R, and S type.

For your difficult temperature monitoring problems, the SR630 Thermocouple Monitor provides the power and flexibility you need. The SR630 interfaces 7 types of thermocouples, 16 independent channels of data and easily handles monitoring and logging functions as well as computer interfacing. And the easy to use front panel makes setup a snap.

And the price? At \$1495, the SR630 is the complete, low cost solution you're looking for.

The SR630 Thermocouple Monitor \$1495

- 16 channels
- 0.1 degree resolution
- B, E, J, K, R, S, and T type thermocouples
- °C, °K, °F, and mV dc readings
- 2000 point non-volatile memory
- 4 proportional analog outputs
- Audible alarm
- GPIB, RS232 and Printer interfaces



SRS STANFORD RESEARCH SYSTEMS

1290 D Reamwood Avenue, Sunnyvale, CA 94089
TEL (408)744-9040 FAX 4087449049 TLX 706891 SRS UD

CIRCLE NO. 118

Plotter sharing card. The Jetcard/DJ is a plug-in card for Hewlett-Packard's Designjet inkjet plotter. The card provides six serial RJ-11 ports to support multiple users; it plugs into a modular I/O slot of the plotter. Four of the ports can handle data-transfer rates as fast as 115,200 baud. A DOS-compatible utility programs a computer's COM1 through COM4 ports to attain the high baud rates. A 2-Mbyte buffer version, \$995. **Excellink Inc**, 1430 Tully Rd, Suite 415, San Jose, CA 95122. Phone (408) 295-9000. FAX (408) 295-9011.

Circle No. 369

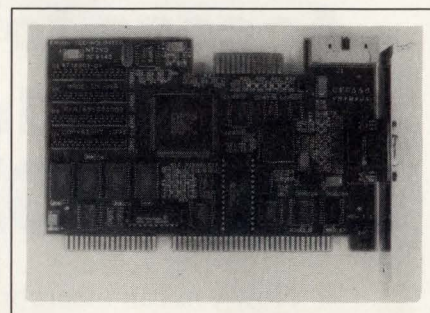

Super VGA card. The CVC550 super VGA card employs dual-port video RAM (VRAM) that's accessible to the host CPU and the board's 82C453 VGA controller IC from Chips and Technologies. The board comes with 512 kbytes or 1 Mbyte of VRAM and supports both noninterlaced and interlaced monitors that have resolutions as high as 1024 x 768 pixels and 256 colors. A 512-kbyte version, \$255. **Ergon Technologies Inc**, Box 748, Ridgeland, MS 39158. Phone (601) 856-4121. TLX 585326

Circle No. 370

Brushless dc amplifier. The ALC-CM is a transconductance amplifier for driving brushless dc motors. It accepts

EDN-NEW PRODUCTS

Computers & Peripherals

$\pm 10V$ dc inputs or accepts optionally a pulse-width-modulation input and a direction command. Units can deliver 15A continuous and 25A pk from a 180V dc power supply or 10A continuous and 15A pk from a 360V dc power supply. The amplifier can also accommodate a 50- to 400-Hz, single-phase, 8 to 264V ac power supply. \$750. Delivery, 8 to 10 weeks ARO. **Automation Inc**, Box 7746, Ann Arbor, MI 48107. Phone (313) 662-3707. FAX (313) 662-3707.

Circle No. 371

Motion-controller boards. The DMC-611, -621, and -631 are 1-, 2-, and 3-axis, respectively, ISA bus motion-controller boards. They provide $\pm 10V$ dc outputs having 12-bit resolution. The boards have latches that can capture real-time position signals within 200 nsec. Other features include linear and circular interpolation along a 2-D path; electronic gearing to synchronize multiple axes to a master axis; and gear ratio changes during motion. You can specify 255 linear or arc segments of motion using encoders operating at 2M counts/sec. DMC-611, \$995; DMC-621, \$1495;

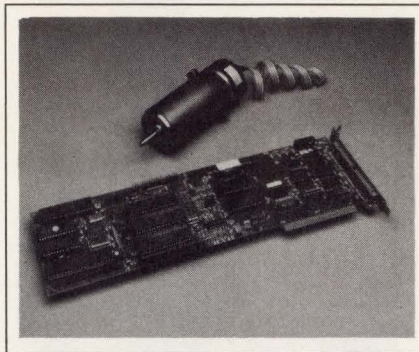

DMC-631, \$1995. **Galil Motion Control Inc**, 575 Maude Ct, Sunnyvale, CA 94086. Phone (408) 746-2300. FAX (408) 746-2315.

Circle No. 372

Fast SCSI-2 coprocessor card. The Silicon Express II is a Busmaster Card for the Macintosh computer Nubus. The board features a 10-Mbyte/sec data-transfer rate on a Fast SCSI-2 port. The board supports the fast Nubus Block Mode data transfers of Quadra-series computers. The board has removable SCSI and power terminations. \$1295. **Atto Technology Inc**, Baird Re-

search Park, 1576 Sweet Home Rd, Amherst, NY 14228. Phone (716) 688-4259. FAX (716) 636-3630. Circle No. 373

Flat-panel display. A flat-panel display subsystem is available for Sun SPARCstations. The subsystem consists of a single-slot SBus graphics-controller card and a 16-in. AC plasma display. The display has a screen resolution of 1280×1024 pixels and measures $3\frac{1}{2}$ -in. in depth. \$5500. **Integrrix Inc**, 1200 Lawrence Dr, #150, Newbury Park, CA 91320. Phone (805) 375-1055. FAX (805) 375-2799. Circle No. 374

Voice-processing board. The Dialog/41D combines an Intel 80188 μP and Motorola's 56001 DSP chip on an ISA bus board. The board features selectable voice-coding algorithms, DTMF detection, and a telephony interface. DTMF cut-through capability lets you access voice mail when calling from a mobile phone or poor-quality line. \$1150. **Dialogic Corp**, 300 Littleton Rd, Parsippany, NJ 07054. Phone (201) 334-8450. Circle No. 375

A Totally Integrated Solution with Powerful Features at an Attractive Price!

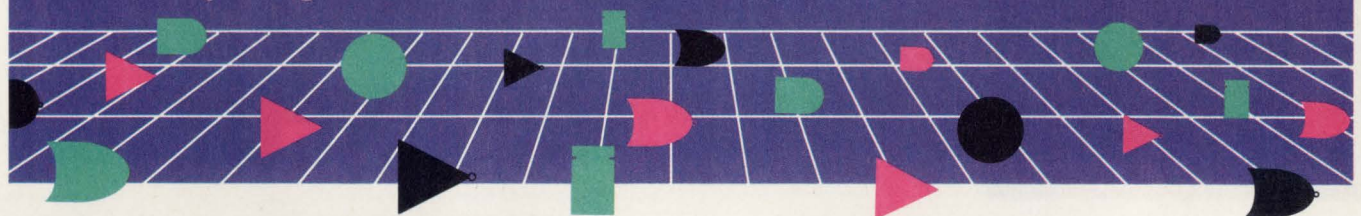

PADS-Logic Schematic Capture System

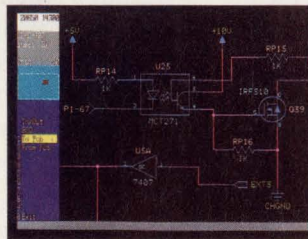

- Multi-sheet, design oriented database
- Fast, graphical library browsing
- Top-down hierarchy with back-annotation
- Automatic gate and pin assignment
- Automatic ref. designator assignment
- Search and query functions across all sheets
- Context sensitive cursor for copy, move, delete
- On-line Logic checking across entire database
- User definable Bill of Materials

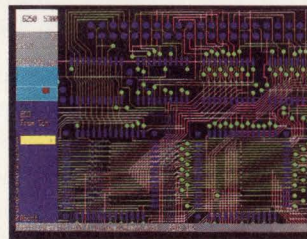

PADS-PCB PCB Design & Layout System

- ▲ Simple, easy-to-use graphical user interface
- ▲ Fast, graphical library browsing
- ▲ 16 bit database, 1 mil database resolution
- ▲ 400 IC design capability
- ▲ Blind and buried via support
- ▲ Automatic gate and pin swapping
- ▲ Autoplace and route
- ▲ Design ruleschecking to 1 mil accuracy
- ▲ Fully integrated to schematic capture

PADS PADS PADS PADS PADS PADS PADS Software, Inc.

119 Russell Street, Littleton, MA 01460 Tel: (508) 486-9521 Fax: (508) 486-8217 Toll Free: 1-800-255-7814

CIRCLE NO. 121



Low cost current sensors for 60 Hz applications

Coilcraft's low-cost current sensor is intended for 60 Hz applications. This compact part (roughly 3/4" square by 1/2" thick) is encapsulated in a protective epoxy coating with a 1/8" diameter through-hole. The sensor functions as the secondary of a current transformer while the conductor carrying the current to be measured serves as the "one turn primary."

Min. wall thickness of the hole is 0.5 mm which meets IEC 380, VDE 0730, and other requirements when used with an insulated conductor. Typical output voltages range from 12 mV at 1 Amp to 90 mV at 10 Amps.

For more information, contact **Coilcraft**, 1102 Silver Lake Road, Cary IL 60013. 708/639-6400.

CIRCLE NO. 122

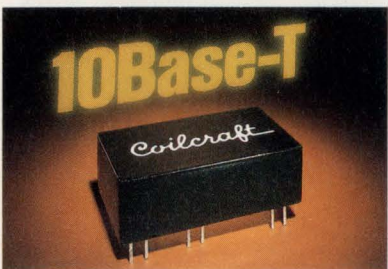

Module integrates all 10Base-T magnetics

This module provides all the low-pass filters, transformers and common mode filters needed to implement a 10Base-T (IEEE 802.3i) interface.

The M2021-A is an encapsulated, package measuring 1.375" x .725" x .500" high. In addition to a pair of isolation transformers and low-pass filters, the module includes single-ended filters to provide balance and reduce common mode noise. (A module without common mode filtering is also available.) The unit's 2000 Vrms isolation meets IEEE 802.3 and IEC safety standards and the common mode filter chokes reduce emissions for FCC and VDE compatibility.

For more information, contact **Coilcraft**, 1102 Silver Lake Road, Cary IL 60013. 708/639-6400.

CIRCLE NO. 123

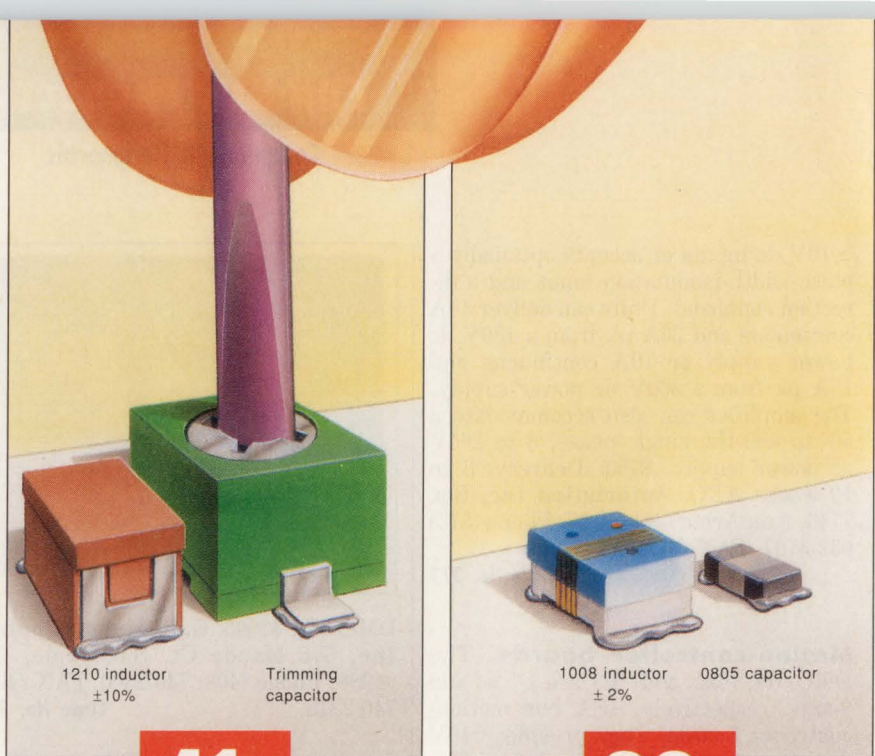

1210 inductor
±10%

Trimming
capacitor

1008 inductor
±2%

0805 capacitor

41¢

PLUS TUNING

22¢

Why your tuned circuits ought to be fixed.

Maybe it's time to rethink the way you design high frequency RF circuits.

Instead of costly tuneable components, why not switch to a fixed LC approach using Coilcraft's tight tolerance chip inductors.

You'll save up to 50% on component costs. Eliminate the time and expense of tuning. Cut board space from 60 to 70%.

And you'll end up with a circuit that's more precise and stable.

We've broken the high price barrier on tight tolerance chip inductors by

using a ceramic instead of a ferrite core. Besides having a much higher SRF, ceramic is electrically neutral. So we can turn out a steady supply of 2% parts and sell them at an amazingly low price.

Our 2% inductors come in 1008 (56 nH - 1 µH) and 0805 (56 - 220 nH) sizes. For non-critical applications, our 5 and 10% parts offer maximum savings.

For data sheets or to order one of our Designer's Kits with prototyping samples, call 800/322-2645.

Coilcraft

CIRCLE NO. 124

CEM/electronic engineers master
See our catalog in Vol. A, Section 1800

1102 Silver Lake Road, Cary IL 60013
800/322-2645 Fax 708/639-1469

EDN-NEW PRODUCTS

Components & Power Supplies

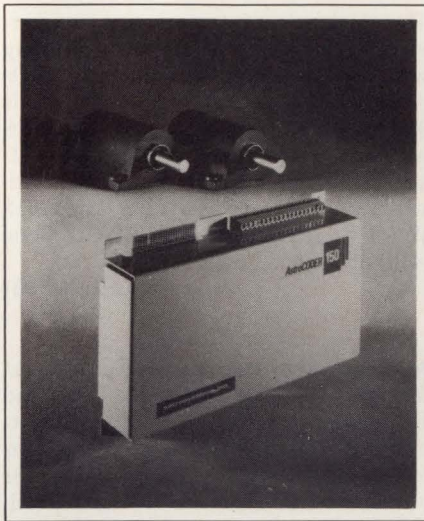

Position encoder. The AstroCoder/150 uses resolver-based position transducers to measure absolute shaft position on either one or two shafts. Unit capabilities include built-in tachometer, offset, reset, power supply, and speed alarm. When operating with two shafts, the unit can provide a control signal to keep the shaft positions synchronized. The encoder provides four simultaneous

outputs per shaft—digital parallel position data; RS-422 or RS-485 serial position, speed, and status; dc voltage level; and high- or low-speed alarms. \$500 (OEM qty). **Astrosystems Inc**, 6 Nevada Dr, Lake Success, NY 11042. Phone (516) 328-1600. FAX (516) 328-1658. TWX 510-223-0411. **Circle No. 376**

Surface-mount fuses. Accu-Guard devices are thin-film, surface-mount fuses. Available in EIA standard 1206 packages, the units have ten ratings ranging from 200 mA to 2A at 32V. Open-circuit resistance is 20 MΩ min, and operating range spans -55 to +125°C. \$0.25 (10,000). Delivery, stock to six weeks ARO. **AVX Corp**, 801 17th Ave S, Myrtle Beach, SC 29577. Phone (803) 946-0562. **Circle No. 377**

Switches. The pc-board-mountable Series 92 switches are oil- and watertight to IP 67 specifications. They feature a membrane cap for a complete front-panel seal. The actuator is available as an indicator, pushbutton, or illuminated pushbutton and comes in a va-

riety of lens colors. From \$2.50 (1000). **EAO Switch Corp**, 198 Pepe's Farm Rd, Milford, CT 06460. Phone (203) 877-4577. FAX (203) 877-3694. Delivery, stock to six weeks ARO. **Circle No. 378**

Laser diodes. These InGaAsP/InP laser diodes operate at rates ranging to 622 Mbps. They are available in 14-pin PGT2030 and 4-pin PGT2110 packages that feature an optional cooler. Output power equals 2 mW, and operating range spans -40 to +85°C. PGT2030 device, \$695. **Ericsson Components Inc**, 403 International Pkwy, Richardson, TX 75081. Phone (214) 669-9900. FAX (214) 680-1059. **Circle No. 379**

Solid-state relay. The QB00FM solid-state relay is designed for ac, bidirectional, and high-voltage dc switching in military applications. The unit features 500V rms I/O isolation; switching capability is 10A at 150V for ac application. The current rating is 15A in dc service. The relay employs power FETs for the output and has an on-resistance of 0.1Ω. It's available

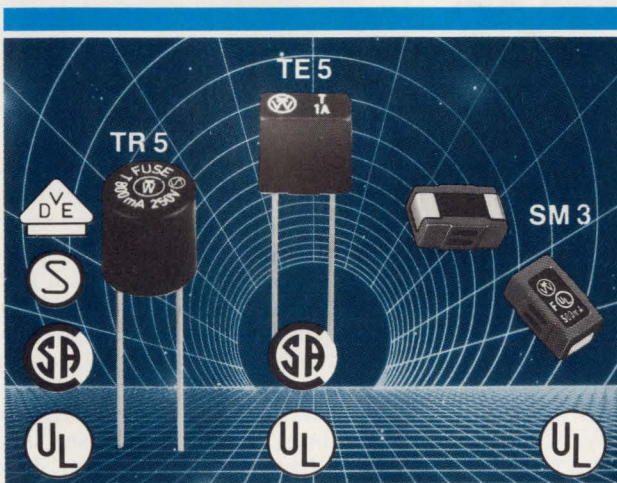

Leading in Sub-Miniature Fuses Technology

Advantages of Wickmann Sub-Miniature Fuses:

- taped on reels for automatic insertion
- space saving types
- with international approvals
- universally acceptable
- shock- and vibration proof
- low voltage drop

Please send information about:

TR5 TE5 SM3

Name: _____

Company: _____

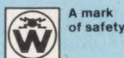

Wickmann-Werke GmbH

Postbox 2520 · D-5810 Witten 6 · Tel. 02302/6620 · Fax 02302/6622 19

CIRCLE NO. 125

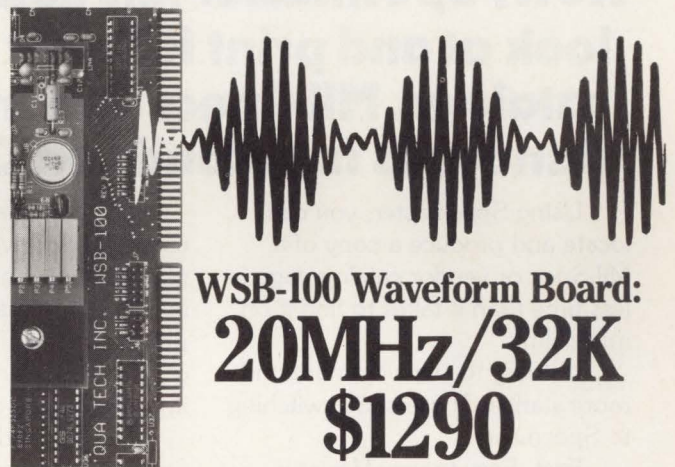

WSB-100 Waveform Board:
20MHz/32K
\$1290

The WSB-100 waveform synthesizer offers speed and memory at a price that's half what you'd expect to pay.

With its analog module, the WSB-100 becomes a 12-bit waveform board for the PC-AT and compatibles that can be used in a wide range of testing and control applications. Multiple boards can be connected to store longer waveforms or to run several waveforms simultaneously.

Optional modules enable the WSB-100 to act as a digital pulse generator or 16-bit word generator.

A 10 MHz/32K configuration is available at an even lower price.

Call for our free
 Interface Handbook:
1-800-553-1170



662 Wolf Ledges Parkway
 Akron, OH 44311

PC-AT is a registered trademark of IBM Corp.

CIRCLE NO. 126

EDN April 9, 1992 • 173

EDN-NEW PRODUCTS

Components & Power Supplies

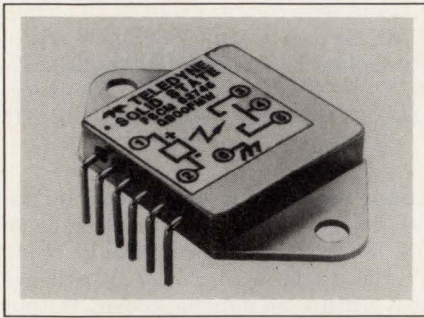

screened to W and Y levels of MIL-R-28750. \$120 (OEM qty). Delivery, stock to eight weeks ARO. **Teledyne Solid State**, 12525 Daphne Ave, Hawthorne, CA 90250. Phone (213) 777-0077.

Circle No. 380

Servo controller/driver. The AMC2200 provides servo control for both brush dc motors and brushless ac/dc motors; it's available in 500 and 1000W versions.

The device is protected against over-voltage caused by regenerative braking with high inertia loads. Onboard LEDs display status. Unit efficiency equals 95% min. The controller/driver operates with a single 12V supply plus bus voltage. \$295 (10) for a 500W version. **Advanced Motion Controls Inc**, 518 Water St, Princeton, WI 54968. Phone (414) 295-3500. FAX (414) 295-3504.

Circle No. 381

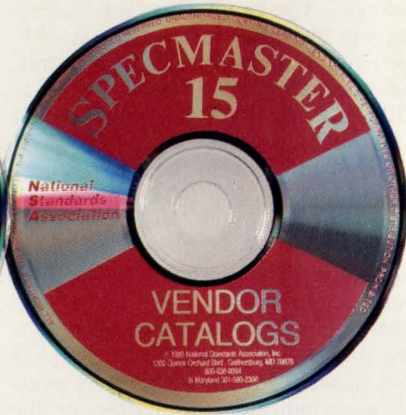

Wow! Specmaster lets you look up, look at and print full-text vendor catalogs, Mil-Specs and industry standards in seconds on CD-ROM.

Using Specmaster, you can locate and produce a copy of a Mil-Spec or vendor catalog page in less time than it takes to find it on microfilm.

It's easy to see why more and more standards users are switching to Specmaster.

Fast. Easy to use. Versatile (you can quickly do complex searches that take hours on microfilm with paper indexes). And larger subscribers are using Specmaster with money-saving networks.

Specmaster files include the 50,000 DOD-listed Mil-Specs, Mil-Stds, QPLs, handbooks, etc. (updated weekly) and industry standards: AIA/NAS, ASTM, SAE, ASME (codes and standards) and AWS.

The Specmaster vendor catalog file of over 10,000 supplier catalogs on 47 discs is indexed by a quarter-of-a-million product terms. This allows you to go directly to the page for an item in an 800-page catalog.

All you need to use Specmaster is an IBM AT or compatible 286 PC with 640K RAM and DOS 3.1 or later. You can network Specmaster on a PC-LAN including DecNet/PCSA.

Call 800-638-8094

for more information or a free live demonstration of Specmaster. Outside USA call 301-590-2300.

National Standards Association

1200 Quince Orchard Blvd., Gaithersburg, MD 20878

CIRCLE NO. 127

Miniature transformers. These transformers are designed for use in T3 and E3 interface circuits. They are also suitable for use in the STS-1 applications operating at 51.84 Mbps—the lower echelon of SONET. The units are available in through-hole and surface-mount versions. They operate over a -40 to +65°C range and feature 1500V rms isolation. \$2.25 (1000). **Pulse Engineering Inc**, 7250 Convoy Ct, San Diego, CA 92111. Phone (619) 268-2400. FAX (619) 268-2515.

Circle No. 382



VME backplanes. These backplanes are available in versions with 3 to 21 slots. Each slot features inboard termination. The units employ an 8-layer construction. Three signal layers are spaced so as to minimize crosstalk problems. The planes feature distributed power bugs. \$935 for a 21-slot J1-J2 unit. **Elma Electronic Inc**, 41440 Christy St, Fremont, CA 94538. Phone (510) 656-3400. FAX (510) 656-3783.

Circle No. 383

PGA sockets. Series MD PGA sockets are available in five grid sizes ranging from 11x11 to 17x17. Molded stand-offs improve soldering. The insulators are compatible with vapor-phase and IR reflow soldering operations. All contacts are rated for 3A. Operating range spans -55 to +125°C. \$0.01 to \$0.018/line (OEM qty). **Mark Eyelet Inc**, 63 Wakelee Rd, Wolcott, CT 06716. Phone (203) 756-8847. FAX (203) 755-9410.

Circle No. 384

EDN-NEW PRODUCTS

Components & Power Supplies

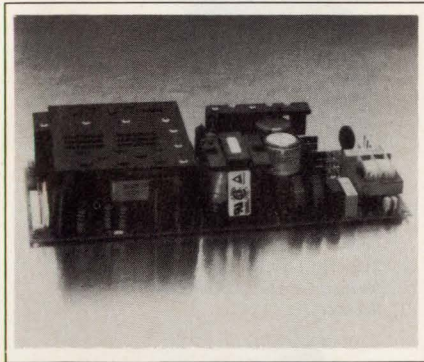

Power supplies. Series FLU4-150 units are 150W, quad-output, open-frame switching power supplies. Five models provide primary outputs of 5V and secondary output combinations of 5, 12, 15, and 24V. All outputs are fully isolated; primary outputs are $\pm 5\%$ adjustable. The supplies have an autoranging input range of 90 to 265V. The series offers indefinite short-circuit protection, soft start, overvoltage protection, and a 32-msec holdup time with a 115V input. \$189. **Power General**, 152 Will Dr, Canton, MA 02021. Phone (617) 868-6216. FAX (617) 868-3215.

Circle No. 385

Tubular solenoids. L-10 Series tubular solenoids produce as much as 208 ounces of force. The units are available in two lengths—1.125 and 2 in.—and push and pull operating types. Both types are available with 6, 12, 24, or 110V dc coils. Power ratings range from 5W continuous to 100W pulse duty. \$8 (OEM qty). Delivery, six to eight weeks ARO. **Liberty Controls Inc**, 500 Brookforest Ave, Shorewood, IL 60435. Phone (815) 725-2241. FAX (815) 725-6571.

Circle No. 386

Switch with TTL-compatible driver. The VSW-2-50DR device is a 3-nsec, GaAs, spdt reflective switch with a built-in TTL-compatible driver housed in a hermetic ceramic-metal package. The unit operates over a dc to 5-GHz range with a 1.3-dB insertion loss. Isolation at 5 MHz is 80 dB. The 50 Ω unit operates over a -55 to +85°C range and consumes 120 mW. \$42.95. **Mini-Circuits**, Box 350166, Brooklyn, NY 11235. Phone (718) 934-4500. FAX (718) 332-4661. TLX 6852844. Circle No. 387

LED arrays. Series 5682F and 5684F arrays feature two and four T-1 LEDs, respectively. The units are available in a variety of models—low-current (2

Clear Out Excess Inventory!

Earn Tax Benefits Up To 200% Of Cost.

Q: What do over a thousand companies like General Electric, Verbatim and Forney know about donating excess materials and equipment that I should know?

A: Your donations could qualify as a tax benefit up to 200% of cost under IRS 170(e) (3).

Q: Who could possibly need my excess parts, assemblies, complete products and office supplies?

A: Thousands of students and teachers in **local school systems**, as well as community, technical and four-year colleges need metal, electric, electronic parts and supplies for **training**.

Q: Where do non-profits get them? And how?

A: We have six warehouses around the country where school systems, colleges and **social service non-profits** come in and select what they need.

Q: Can my company get the tax benefit this quarter?

A: Absolutely. We can clear out your excess inventory quickly because of our warehouses. So why wait till year end to think about your bottom line.

Call or write today and we'll reply within 48 hours.

Company/College

Gift-In-Kind Clearing House

P. O. Box 850 Davidson, NC 28036 704/892-7228 Fax 704/892-3825

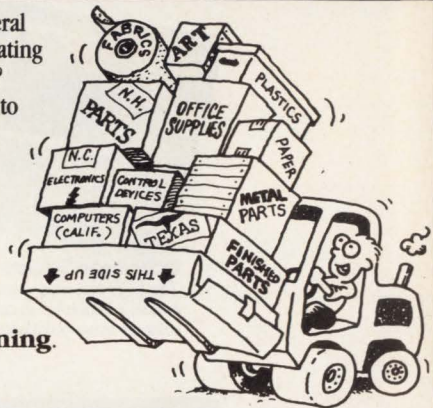

Get Tax Benefits This Quarter!

CIRCLE NO. 128

The High-Tech Weight Loss System.

There are weight loss programs for the average individual. And then there's NordicSport™ Ski, from NordicTrack. The high-tech, world-class way to **lose weight and keep it off. For good.**

Weight loss never felt so good. **Our state-of-the-art graphite construction** allows the NordicSport™ Ski to move and react to your body's motions, to provide the most authentic sport simulation for the most vigorous **total-body workout**. It's a ski motion so smooth, so real, so challenging—you'll hardly notice the snow is missing.

And you'll **burn up to 1,100 calories per hour** according to fitness experts. That's more than you would on exercise bikes, stairclimbers or treadmills. You'll burn fat and increase lean muscle tissue, **raise your metabolism and tone your entire body in as little as 20 minutes, three times a week.**

Experience NordicSport™ Ski. The one weight loss program you can stick to, succeed at, and enjoy.

Call today for a 30 day in-home trial!

nordic sport™
by NordicTrack

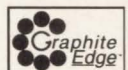

For a **FREE VIDEO** and brochure call, **1-800-445-2231** ext. 83TD2

NordicTrack, Dept. #83TD2, 141 Jonathan Blvd. N., Chaska, MN 55318
© 1992 NordicTrack, Inc., A CML Company • All rights reserved.

CIRCLE NO. 129

EDN April 9, 1992 • 175

No guts.

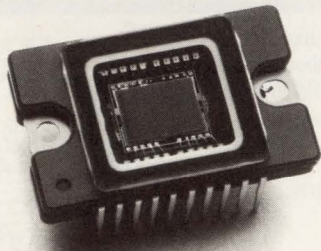

CCD Image Sensors

The CCD technology that led to Sony's leadership in color video cameras is now available to you.

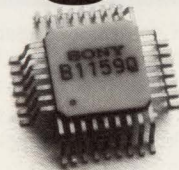

ECL Standard Logic

Wide range of high-speed, high-performance ECL logic devices. Low cost and design simplicity.

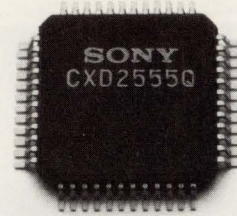

Digital Audio

Consumer-based leading-edge technology. Compact design. Small package. Capable of CD-ROM interface.



High Speed SRAMs

Broad family covers all your fast-processor, cache-memory requirements.



ECL Gate Arrays

Super high-speed operation combined with low power consumption and extensive I/O interfaces.



Interactive Video

Sony's A/V IC leadership applies directly to new multimedia systems. Superior bipolar linear technology in encoder/decoder.



1-Meg SRAMs

Largest, most diverse family in the industry. The first products scheduled to come from our new San Antonio fab.



STRAM

High speed performance, self-timed RAM with register, synchronous SRAM.



GaAs FETs

State-of-the-art performance, reliability and uniformity. Ideal when low noise is critical.



D/A Converters

High speeds to 500 MHz, low glitch energy, and low power consumption in very small packages.

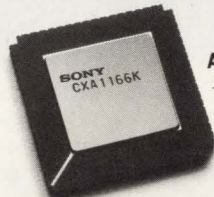

A/D Converters

18 models including the world's fastest. Fewer pins, smaller packages, low power consumption, and guaranteed low error rates.

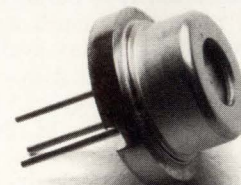

Laser Diodes

Wide power range, high reliability, huge selection. Ideal for optical disk, laser printer and microsurgery designs.

No glory.

If you can't get the parts you need, you can't get your best designs out the door.

And that's where we can help. With complete families of semiconductors like these. The same components that have made Sony's consumer electronics so successful.

Perhaps more important, we're always here to help. With a design center to help develop your applications through production.

With a service department to answer your questions and expedite your orders.

And with world-class manufacturing, including new facilities in San Antonio, Texas, to produce the technology you'll need in 1992 and beyond.

Let Sony semiconductors bring glory to your products. Call us today at (714) 229-4331, FAX (714) 229-4285. In Canada (416) 499-1414, FAX (416) 499-8290.

SONY®

Sony Corporation of America, Component Products Company, 10833 Valley View Street, Cypress, CA 90630.
Sony Canada, 411 Gordon Baker Road, Willowdale, Ontario M2H 2S6.

Sony is a registered trademark of Sony Corporation. Prices and specifications are subject to change without notice. The purchase of products is subject to availability and Sony's standard terms and conditions of sales.

EDN-NEW PRODUCTS

Components & Power Supplies

mA) versions with built-in resistors for 5 and 12V operation, red-green bicolor models, or with high-brightness red, green, yellow, amber, and blue LEDs. The black thermoplastic housings carry a UL 94V-0 rating. From \$0.96 and \$1.80 for dual and quad arrays, respectively. Delivery, stock to six weeks ARO. **Industrial Devices Inc.**, 260 Railroad Ave, Hackensack, NJ 07601. Phone (201) 489-8989. FAX (201) 489-6911. **Circle No. 388**

Inductors. These conformally coated inductors are available in four package sizes—4.5-mm EC22, 10-mm EC24, and 14-mm EC36 and EC46. Inductance values range from 0.1 μ H to 82 mH. Values down to 0.022 μ H are available on special order. Standard tolerance equals either 10 or 20%. \$0.042 (25,000). **3L Global Electronics**, 2915 Anvil St N, Saint Petersburg, FL 33710. Phone (813) 343-2679. FAX (813) 343-4410. **Circle No. 389**

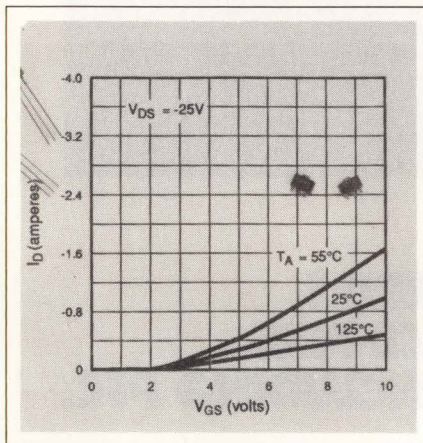

P-channel MOSFETs. TP25D family P-channel MOSFETs are available in SOT-89 and SOT-92 packages as well as die form. They have a 2.4V max gate threshold voltage and drain-to-source breakdown levels of 350 and 400V. Drain-to-source on-resistance equals 25 Ω max. TN2540N8 SOT-89 unit, \$0.69 (1000). Delivery, stock to six weeks ARO. **Supertex Inc.**, 1350 Bordeaux Dr, Sunnyvale, CA 94089. Phone (408) 744-0100. FAX (408) 734-5247. **Circle No. 390**

Digital panel meters. The A-3000 Series digital panel meters (DPMs) consist of a basic chassis that incorporates the digital display, operational circuitry, and power supply. Users can plug input-circuit modules into this basic chassis to measure dc current or

BEYOND EXPECTATION

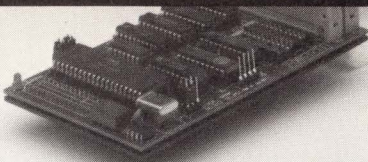

8051/52 • 8096/196

No two emulators run the same. The trick is to get the best functionality you can for your investment. With the SIGNUM 8051 family in-circuit emulator you get even more... you get:

- Outstanding price/performance
- Easy window interface & flash download
- Free user support
- C and PL/M debuggers
- Local variable support
- 512K Mappable emulation RAM with 256K H/W breakpoints
- Break on register ranges
- Program & external data access on the fly
- Bank switching

SIGNUM also has the Intel 8048, Zilog Z8 and Super-8, Texas Instruments DSP, the 8051/52 (from AMD, Siemens and Signetics), and more chips covered.

So, don't just look at in-circuit emulators. The only way to truly test an emulator is to use it. Call for your own free trial and demo disk.

You owe it to yourself to find how much emulator you can really get for your money.

10 DAY FREE TRIAL

SIGNUM SYSTEMS

171 East Thousand Oaks Blvd.
Thousand Oaks, CA 91360

Info. Tel: (415) 903-2220 FAX: (415) 903-2221

Distributors Wanted
CIRCLE NO. 132

262,144 Colors Perform Here

- Pixel Replicate™
- Nibble Mode
- VGA/SVGA
- 8514/A
- XGA™



MUSIC's graphics color palettes are fine-tuned for your graphics subsystem applications. MUSIC gives you the sharpest graphics and truest colors available at the lowest cost. So whether you're designing desk-top computers, graphics add-in cards, low-power laptops or multi-media systems, contact MUSIC Semiconductors, The Specialty Memory Company. For your Free design kit call: USA 1-800-788-MUSIC (6874), Europe +31-45-467878, Asia 63-2-816-2477

MUSIC
SEMICONDUCTORS

CIRCLE NO. 131

THIS YEAR'S HARVEST HAS YIELDED SOME COLORFUL RESULTS

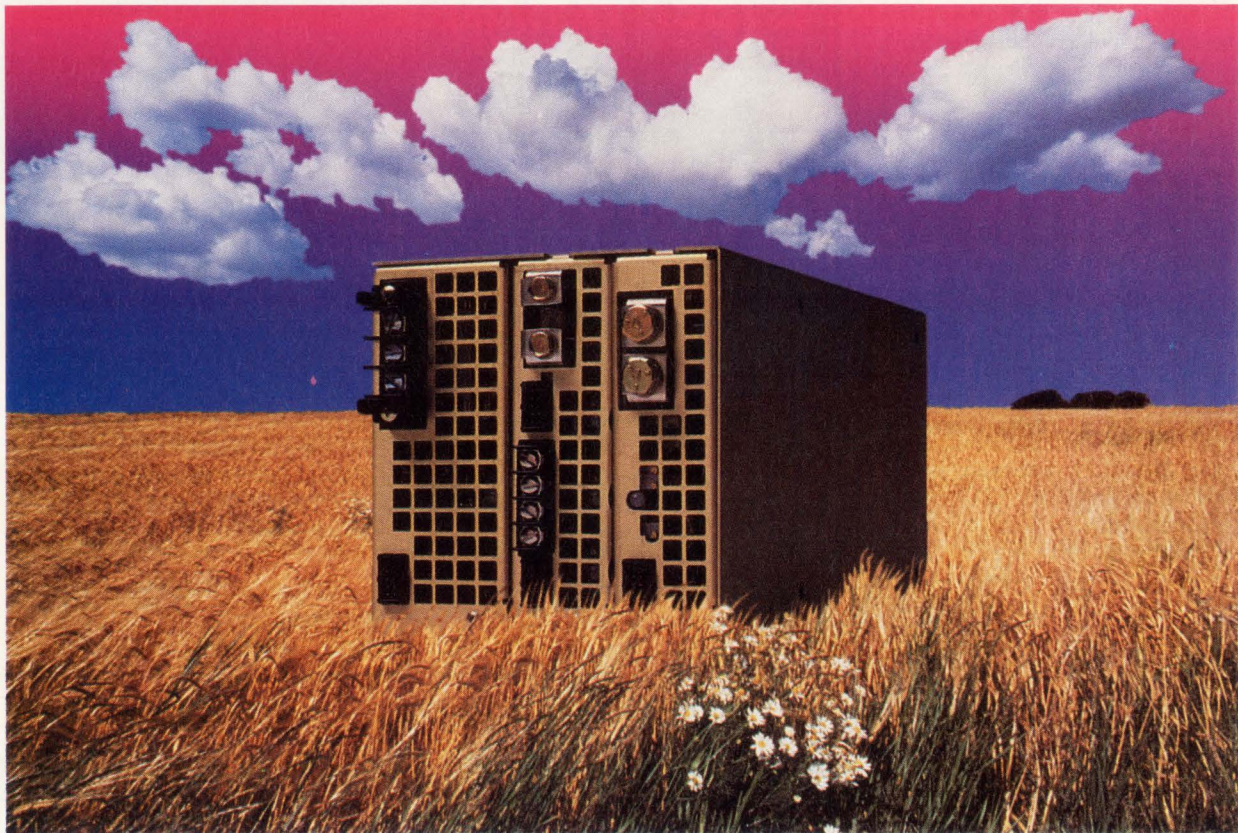

LIKE THE NEW SPECTRUM SERIES, THE MODULAR DESIGN THAT OFFERS AN ARRAY OF STANDARD FEATURES INCLUDING PFC.

Astec introduces a new high power product of unmatched versatility and value. Its compact footprint and standard PFC front-end make the Spectrum Series compliant with IEC 555-2 while bringing significant space savings to countless designs. With up to 12 outputs plus a full range of output currents and voltages, Spectrum will accommodate any configuration of power between 500 and 2000 watts.

Many features, considered options in the industry, are standard in the Spectrum Series, including current share, remote sense, voltage adjustment, margining, power fail and level A EMI filtering - all at no additional cost.

Standard modules are stocked for fast delivery. To reap the many benefits from Astec's new Spectrum Series, call the toll free number below.



ASTEC STANDARD POWER
Division of Astec America, Inc.
401 Jones Rd.
Oceanside, CA 92054-1216
Telephone: 619-757-1880
Facsimile: 619-439-4243

1-800-233-9973

For Literature or Information

EDN-NEW PRODUCTS

Test & Measurement Instruments

voltage, ac average voltage or current, ac true rms voltage or current, frequency, and ohms. Users can also configure the unit to serve as a thermocouple monitor, temperature detector, process monitor, or strain gauge. Basic chassis, \$141; input modules, \$32 to \$154. **Selco Products Co.**, 7580 Stage Rd, Buena Park, CA 90621. Phone (800) 257-3526; (714) 521-8673. FAX (714) 739-1507. **Circle No. 391**

Transistors. The LS-311 npn and LS-351 pnp dual transistors are surface-mount devices characterized for low noise and matched for current gain and V_{BE} . Current gain ranges from 150 to 2000 for LS-311 versions and from 150 to 500 for LS-351 models. \$1.87 (1000). **Linear Integrated Systems Inc.**, 310 S Milpitas Blvd, Milpitas, CA 95035. Phone (408) 263-8401. **Circle No. 392**

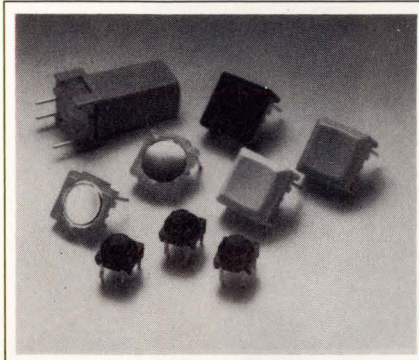

Switches. These key switches are available in two families—700 Series and 720 Series. The 700 Series has contact ratings of 30V ac at 10 mA. Operating range spans 20 to 85°C. Series 720 switches are rated for 20V at 50 mA and operate over a -10 to +85°C range. Maximum life times are 3×10^6 and 10^6 operations for 700 and 720 units, respectively. Series 700, \$0.38; Series 720, \$0.22 (1000). Delivery, stock to eight weeks ARO. **Mecpocal**, 11468 Sorrento Valley Rd, San Diego, CA 92121. Phone (619) 453-0332. FAX (619) 481-1123. **Circle No. 393**

DC/DC converters. The PKA 2323PI and 2325PI converters offer dual floating outputs of 12 or 15V. Power output is limited to 30W. The converters provide a full power output over a -45 to +85°C range. Input-output isolation equals 500V dc. \$98 (250). **Ericsson Components Inc.**, 403 International Pkwy, Richardson, TX 75085. Phone (214) 669-9900. **Circle No. 394**

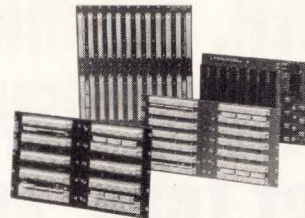

High-speed Backplanes

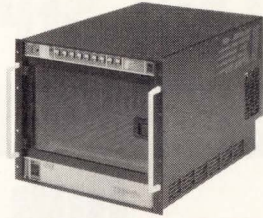

VXI Intelligent Mainframe®



Monitoring Modules
(2" x 2" x 0.8")

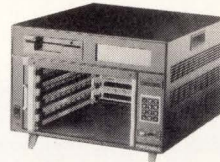

Development Systems

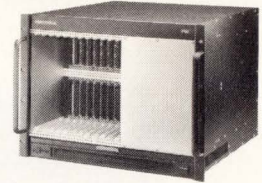

System Packaging

Get expert help in system packaging.

- VMEbus
- VXIbus
- Multibus II
- PC/AT
- Futurebus +
- Good ideas that add efficiency and value to your design.
- Fast response - quotes and CAD drawings in days, not weeks.
- Intimate knowledge of international standards and safety regulations.
- Superb craftsmanship at fair prices.
- 20 years of experience in electronic packaging.

Call **1-800-848-4525**.

Tracewell Enclosures, Inc.,
567 Enterprise Drive, Westerville,
Ohio 43081. Fax: 614-846-4450

TRACEWELL

CIRCLE NO. 134

FIFO, the trick chip, performs here

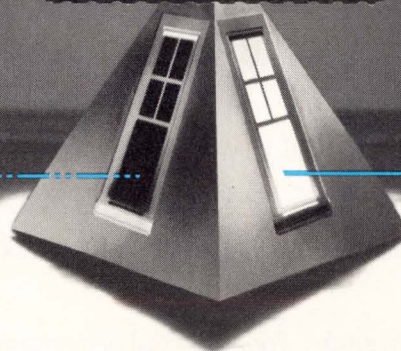

MUSIC's FIFOs offer from 512 through 4096 nine-bit words in pin-compatible packages and easily expand using minimal external logic with no degradation in performance. So whether your application is high-performance data buffers, LANs/WANs, data compression/decompression, or DSP, contact MUSIC Semiconductors, The Specialty Memory Company. For your FREE design kit call: USA 1-800-788-MUSIC (6874), Europe +31-45-467878, Asia 63-2-816-2477



CIRCLE NO. 63

LAST SEPTEMBER, 85 MILLION PEOPLE DESPERATELY WANTED A DEMONSTRATION OF OUR FINEST LOGIC ANALYZER.



Only one logic analyzer could have brought the most crippling communications failure in U.S. history to a swift conclusion.

The new DAS/SE from Tektronix. With 200 MHz synchronous clocking, thousands of cycles of memory depth, and literally hundreds of channels, the DAS/SE is without question the fastest and most powerful logic analyzer around. And with 11

different stimulus & acquisition modules, it can be configured to solve any of your digital debug problems. For a personal demonstration, call Tektronix today and ask about the DAS/SE. The logic

analyzer that could very well prevent another banner year. **TALK TO TEK/1-800-426-2200 EXT. 73**



Tektronix
Test and Measurement

EDN-NEW PRODUCTS

Test & Measurement Instruments

IEEE-488.2 interface. The Personal 488/MM is an IEEE-488.2 interface board for Ampro's miniature IBM PC-compatible computers. The board, a so-called **Minimodule**, plugs into the PC and matches its 3.6 x 3.8-in. form factor. Versions of the PCs, which are intended for embedded-control applications, run several operating systems, including MS-DOS, PC-DOS, DR-DOS, MS-Windows, Interactive Systems Unix, and SCO Unix. To support the varied needs of embedded-system developers, the interface vendor offers a variety of software drivers. \$395. **Iotech Inc.**, 25971 Cannon Rd, Cleveland, OH 44146. Phone (216) 439-4091. FAX (216) 439-4093. **Circle No. 405**

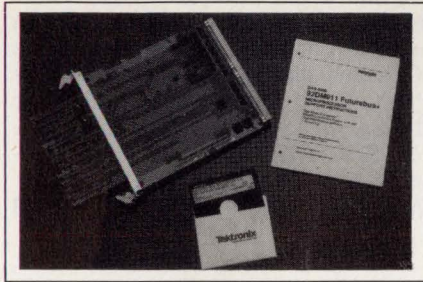

Futurebus+ interface for logic analyzers. The 92DM911 is a Futurebus+ interface package for the vendor's DAS 9200 logic-analysis systems. The package, which interfaces with the bus via a single-slot 12-system-unit card, requires that you equip the analyzer with two of the firm's Centurion cards. The system performs bus-based timing analysis at 100 MHz and, even with 128-bit data paths, acquires state information on all three phases of every bus transaction in real time. The data display uses Futurebus+ mnemonics. \$9950; analyzer equipped to work with the package, less than \$58,000. Delivery, eight weeks ARO. **Tektronix Inc.**, Test & Measurement Group, Box 1520, Pittsfield, MA 01202. Phone (800) 426-2200. **Circle No. 406**

Safety-test unit. The STU 120/240 performs electrical-safety tests on 50- or 60-Hz ac-line-operated equipment that draws as much as 24A at 120V or 16A at 240V. The unit, which requires no calibration, measures leakage current and 25A ground continuity; it also measures rise of resistance. Interlocks prevent improper operation, and circuit breakers safeguard the unit. \$24,995. **Compliance Plus**, 325 Ayer Rd, Harvard, MA 01451. Phone (508) 772-2278. **Circle No. 407**

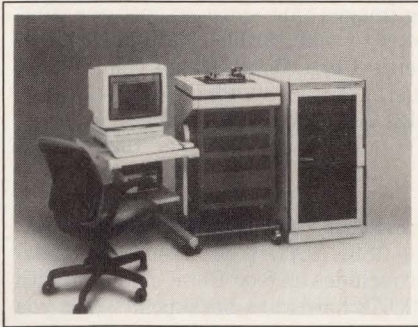

Mixed-signal system. The mixed-signal ATS system characterizes, analyzes, and debugs mixed-signal ICs and multichip modules—especially digital-intensive modules; modules that have clock speeds in hundreds of MHz; and modules that must be tested using DSP techniques. The system, which handles data rates as high as 400 Mbps/channel and provides 100-psec timing accuracy, can contain analog instrumentation that operates to 1 GHz. A 224-pin configuration with 400-MHz digital and 600-MHz analog capability, \$630,000. **Integrated Measurement Systems Inc.**, 9525 SW Gemini Dr, Beaverton, OR 97005. Phone (503) 626-7117. FAX (503) 644-6969. **Circle No. 408**

Keypad-programmable dc power supplies. The DPS series includes four members having maximum outputs of 12.5, 25, 40, and 125V. Output power is approximately 80W at full voltage. All outputs are adjustable to zero. To improve resolution and increase output current, the first three units have a low range in which the maximum voltage is about 40% of that on the high range. The 3-digit displays indicate the voltage and current. \$429. **Kepeco Inc.**, 131-38 Sanford Ave, Flushing, NY 11352. Phone (718) 461-7000. FAX (718) 767-1102. TWX 710-582-2631. **Circle No. 409**

14-bit PC or Macintosh-compatible spectrum analyzer. The R380 acquires as many as 100 ksamples/sec. It has two channels, a dynamic range of 85 dB, and a 16k-word buffer for each channel. It performs FFTs to 8k points. \$1995. **Rapid Systems Inc.**, 403 N 34th St, Seattle, WA 98103. Phone (206) 547-8311. FAX (206) 548-0322. TLX 265017. **Circle No. 410**

12-bit waveform-acquisition board for ISA bus. The 4-channel R1222 system has differential inputs, five programmable gain ranges, 1M word of

memory, and a single ADC with a maximum acquisition rate of 2 Msamples/sec. A PC can host eight of the units. \$4995. **Rapid Systems Inc.**, 403 N 34th St, Seattle, WA 98103. Phone (206) 547-8311. FAX (206) 548-0322. TLX 265017.

Circle No. 411

High-speed download option for ICs. The UEM series parallel option (\$500) allows downloading programs to the vendor's in-circuit emulators (ICEs) at 25,000 bytes/sec—more than twice the speed of the fastest serial connections and more than 10 x as fast as the serial connections used by most emulators. Downloading a 1-Mbyte program takes 40 sec. The emulators support the 68000, 68302, 80186/188, and Z180 families. **Softaid Inc.**, 8300 Guilford Rd, Columbia, MD 21046. Phone (800) 433-8812; (410) 290-7760. FAX (410) 381-3253. **Circle No. 412**

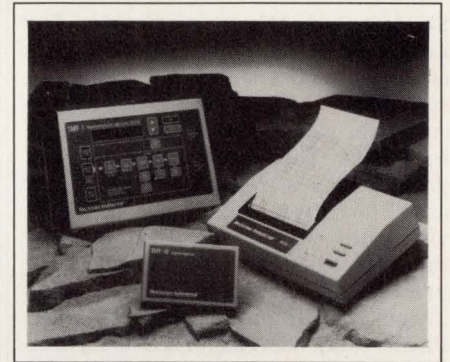

Signal injector for LAN and telecom wiring. The \$195 TMT-10 signal injector works with the vendor's TMT-1 LAN system tester. Together, the instruments let you test and certify LANs that use unshielded twisted-pair wiring. The instruments first test the network wire on its spool. Then they perform a 6-function test on the installed wiring. An optional printer provides a certification printout. \$2745 for both units. **Beckman Industrial Corp.**, 3883 Ruffin Rd, San Diego, CA 92123. Phone (619) 495-3200. FAX (619) 268-0172. TLX 249031. **Circle No. 413**

Deep-memory plug-ins for fast-sampling DSO. The 7234 unit is a 4-channel plug-in for the vendor's 7200 modular DSO (mainframe, \$17,000). The plug-in unit (\$19,500 with its long-memory option) can store 1 million points on one channel, 500,000 points on each of two channels, or 200,000 points on all four channels. The unit

EDN-NEW PRODUCTS

Test & Measurement Instruments

takes 200 Msamples/sec on each channel. The 7242B 2-channel plug-in (\$22,900 with long memory) lets you configure the DSO with four simultaneous-sampling 1-Gsample/sec channels, each having 1M word of memory. **LeCroy Corp**, 700 Chestnut Ridge Rd, Chestnut Ridge, NY 10977. Phone (800) 553-2769; (914) 425-2000. FAX (914) 425-8967. TWX 710-577-2832.

Circle No. 414

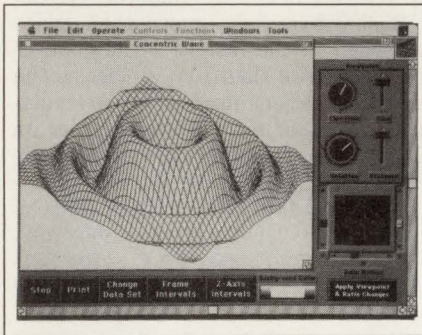

Surface-plotting package for Labview. Surfaceview comprises a set of virtual instruments for National Instruments' Labview data-acquisition software, which runs on Apple Macintosh PCs. The package, which plots gridded data at regular or irregular X and Y intervals, lets you control the viewpoint, color, grids, and other parameters from the Labview block diagram. \$250. **Metric Systems**, 1506 Taron Dr, Round Rock, TX 78681. Phone (512) 388-4458. FAX (512) 244-7203.

Circle No. 415

Variable-resolution ADC board for ISA bus. The VF900 board uses a V/F converter and can digitize an analog signal with a resolution of 10 to 18 bits. It has four differential inputs and provides programmable gain. The board also has 16 digital I/O lines and a 12-bit DAC. It makes 1000 conversions/sec at 10 bits, 30 conversions/sec at 15 bits, and 4 conversions/sec at 18 bits. \$495. **Real-Time Devices Inc**, 820 N University Dr, State College, PA 16803. Phone (814) 234-8087. FAX (814) 234-5218.

Circle No. 416

Data-acquisition software with movie display. Labview 2 data-acquisition software—a graphical-language compiler that lets you automate experiments without conventional programming—can now display Quicktime "movies." For example, if a test fails, you can have the software display mov-

ing images that show an operator what steps to take. \$1995. **National Instruments Corp**, 6504 Bridge Point Pkwy, Austin, TX 78730. Phone (800) 433-3488; (512) 794-0100. FAX (512) 794-8411.

Circle No. 417

Emulator for 80186/88EA and XL. The 186EA/XL UEM in-circuit emulator includes an 8 or 16-bit emulator with 131,072 hardware breakpoints that you can nest to a depth of five levels. Also included is a source-level debugger that couples real-time-performance analysis results to your C source code. You can specify areas of memory as read-, write-, and fetch-protected. \$7500. **Softaid Inc**, 8300 Guilford Rd, Columbia, MD 21046. Phone (800) 433-8812; (410) 290-7760. FAX (410) 381-3253.

Circle No. 418

Receiver for GPS frequency and time data. The GPStar 5-channel multiplexed receiver simultaneously receives time and frequency information transmitted by five Global Positioning Satellites. According to the vendor, the unit, which produces universal time codes with 100-nsec accuracy, provides atomic-clock accuracy at a price that is 40% below that of competing products. \$3995. **Odetics**, 1515 S Manchester Ave, Anaheim, CA 92802. Phone (714) 774-5000. FAX (714) 774-9432.

Circle No. 419

4000-count bar-graph DMMs. The D981, a handheld unit with 1/2-in. LCD numerals, has five dc voltage ranges from 400 mV to 1 kV, four ac voltage ranges, and five frequency ranges to 1 MHz. It also measures temperature, resistance to 40 M Ω , ac and dc current to 10A, and capacitance to 40 μ F. The D927 has fewer ranges but has an unfused 20A current range. D981, \$130; D927, \$69. **Protek**, Box 59, Norwood, NJ 07648. Phone (201) 767-7242. FAX (201) 767-7343.

Circle No. 420

DC-to-26.5-GHz power and voltage meter. The URV 35 level meter operates from ac or batteries. By combining it with any of a range of probes and sensors, you can adapt it to signals of varying levels and frequencies. The instrument provides both analog and digital displays. \$2310 plus RF head, Delivery, eight weeks ARO. **Rohde & Schwarz Inc**, 4425 Nicole Dr, Lanham, MD 20706. Phone (301) 459-2810. FAX (301) 459-2810. TWX 510-223-0414.

Circle No. 421

Pattern-matching software. MS-DOS-based Genmatch software applies pattern-recognition techniques to complex frequency and time measurements. The vendor provides both a stand-alone version and a set of libraries that you can link into C programs. You define a nominal signal and provide tolerances for features or segments. \$3500. **Genias Corp**, 2006 Woodrun SE, Lowell, MI 49331. Phone (800) 443-6427; (616) 897-5252. FAX (616) 897-0306.

Circle No. 422

84-pin PLCC to 28-pin DIP adapters for Mach 130 and 230. The 2-in.-square 84PL/28D6-ZL and ZAL-MACH130 let IC programmers designed to accommodate DIP devices program these AMD μ P chips. There are two types of replaceable sockets—a clamshell type that accommodates LCCs and plastic leaded chip carriers (PLCCs) and an auto-eject socket for PLCCs. ZL version, \$200; ZAL version, \$155. **EDI Corp**, Box 366, Patterson, CA 95363. Phone (209) 892-3270. FAX (209) 892-3610.

Circle No. 423

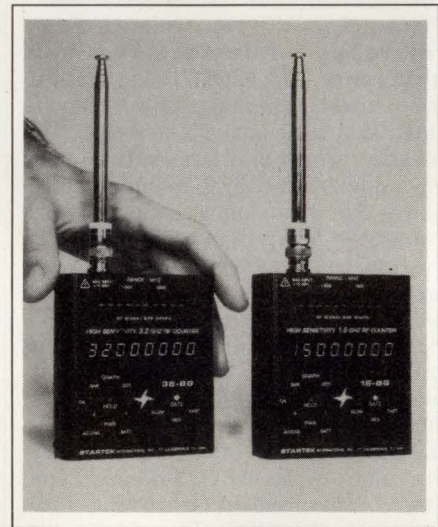

RF bar-graph frequency counters. The pocket-size 15-BG and 35-BG are sensitive RF detectors as well as counters with 8-digit LED displays. The first unit operates from 1 MHz to 1.5 GHz; the second, from 1 MHz to 3.5 GHz. You can choose among three gate times. With the longest gate (25 sec), the units' resolution is 10 Hz. The 3.4 x 3.8 x 1-in. units operate from three to five hours from rechargeable NiCd battery packs. 15-BG, 1.5-GHz unit, \$220; 35-BG 3.5-GHz unit, \$265. **Startek International Inc**, 398 NE 38th St, Fort Lauderdale, FL 33334. Phone (305) 561-2211. FAX (305) 561-9133.

Circle No. 424

EDN-NEW PRODUCTS

CAE & Software Development Tools

Handwriting recognition. Coup-de-Plume (stroke of the pen) is software that recognizes handwritten characters. It is part of a family of products for implementing pen-based applications. The supplier claims that the software recognizes discrete characters and cursive script words, independent of the style of the writer. \$189. **J H Shannon Associates Inc**, Box 597, Chapel Hill, NC 27514. Phone (919) 929-6863.

Circle No. 395

Speaker-design software. CAL-SOD 2.50 helps design and optimize loudspeaker systems. It simulates the sound pressure and impedance response of individual loudspeaker drivers. It works with multiple drivers and includes a circuit optimizer for crossover networks. AU\$449. **AudioSoft**, 128 Oriol Rd, West Heidelberg 3081, Melbourne, Australia. Phone/FAX (3) 497-4441.

Circle No. 396

Filter-design software. Filter Pro is a software package for active-filter design. It comes on a 5¼-in. floppy disk

and includes programs that help design filters using the supplier's UAF42 universal active-filter IC. Separate programs help with Sallen-Key lowpass filters; multiple-feedback, lowpass filters;

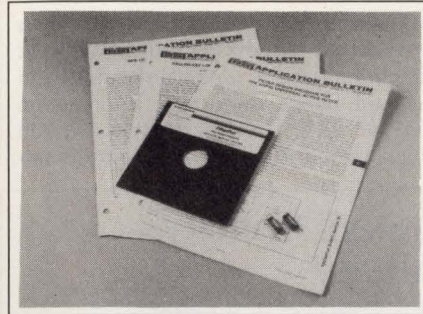

and state-variable lowpass, highpass, bandpass, and band-reject (notch) filters. Free of charge. **Burr-Brown Corp**, Box 11400, Tucson, AZ 85734. Phone (602) 746-1111.

Circle No. 397

PLD/FPGA design converter. The Minc/Viewdraw interface links Viewlogic's Viewdraw schematic-capture system with Minc's PLD and FPGA design-synthesis tools. You create a

schematic with Viewdraw using a special library provided with Minc's PLDesigner and PGADesigner tools; Viewdraw then creates an EDIF 2 0 0 netlist to be read by PLDesigner or PGADesigner. The interface is a standard feature in PLDesigner Systems 500, 5000, 400, 700, and 7000; it's an option in Systems 200 and 300. \$450. **Minc Inc**, 6755 Earl Dr, Colorado Springs, CO 80918. Phone (719) 590-1155.

Circle No. 398

Mathematical-analysis software for Windows. Mathematica 2.0 software for technical computing is now available for Windows. It contains two parts: a kernel, which performs computations, and a front end, which handles interactions with the user. The front end takes advantage of Windows capabilities; it provides interactive documents, known as notebooks, in which text, graphics, annotations, and sound can be mixed with mathematical input. \$995; upgrades from DOS versions, \$125. **Wolfram Research Inc**, 100 Trade Center Dr, Champaign, IL 61820. Phone (217) 398-0700.

Circle No. 399



LEMO

COAXIAL CONNECTORS FOR VIDEO APPLICATIONS

1S Series



- Impedance: 75 Ohms
- Frequency: up to 2 GHz
- Self-latching system Push-pull LEMO®
- Connectors for crimping assembly for cables RG-59B/U, RG-179B/U, RG-6A/U and equivalent
- Range of products comprising:
 - Adapter BNC with microswitch guaranteeing allowing the termination of the unused line at its characteristic impedance
 - Fixed socket with microswitch
 - Bridge plug with or without monitoring socket
 - Custom specified patch panels

CIRCLE NO. 136

LEMO P.O. Box 194 CH-1024 Ecublens Tel: +41/21/691.16.16 Fax: +41/21/691.16.26

EDN-NEW PRODUCTS

CAE & Software Development Tools

Software for testing X-Window-based software. XRunner generates programmable test scripts, automates test execution, and records test results for quality-assurance testing of X-Window-based software. It runs on SPARCstations under Unix or X Windows and supports both Motif and Open Look. Configuration D provides full development and automated execution; configuration E supports test execution only. Basic configuration

(two D and three E licenses), \$35,000. **Mercury Interactive Corp.**, 3333 Octavius Dr, Santa Clara, CA 95054. Phone (408) 987-0100. **Circle No. 400**

Software for viewing engineering drawings. Hyperview 3.0 allows rapid viewing of both CAD-generated and scanned paper drawings. Running on DOS or VAX VMS X Windows, it can quickly zoom to any part of large engi-

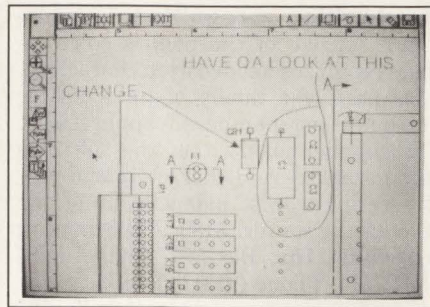

neering drawings. A red-lining utility lets you mark up drawings in a separate "layer" with lines, arrows, boxes, free-hand, whiteout, and color. \$695 per user. **Techview Corp.**, 2500 W Higgins Rd, Suite 1271, Hoffman Estates, IL 60195. Phone (708) 490-0066. FAX (708) 490-0199. **Circle No. 401**

Why Do So Many Engineers Specify Keeper II® Lithium Batteries?

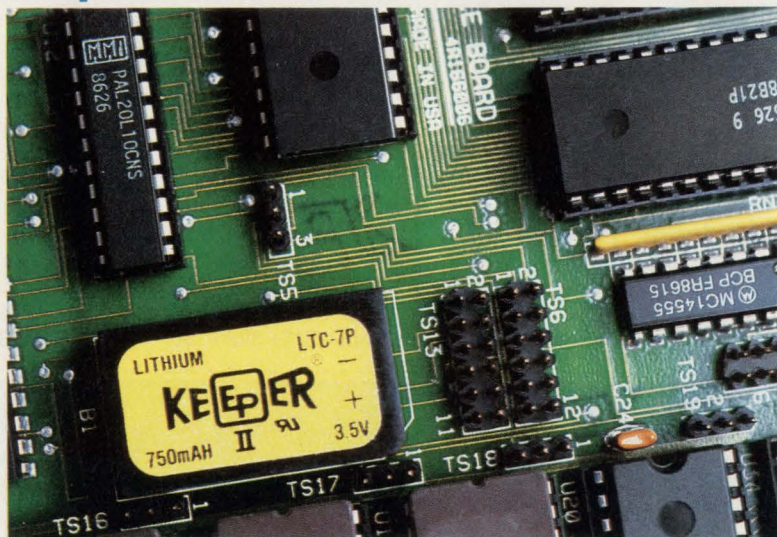

Because Board Space Is Too Valuable To Waste



At Eagle-Picher, we don't think you should have to compromise valuable circuit board space simply because some battery manufacturer elected to make round batteries.

Electronic circuit board "real estate" is becoming increasingly valuable. Consequently, engineers are faced with more complex decisions regarding their back-up power source. Keeper II's unique prismatic configuration provides effective utilization of board space with maximum energy density characteristics.

Packaged the way circuit board components were meant to be, the Keeper II has been proven highly dependable in stand-by power applications where years of reliable memory back-up is required. Eagle-Picher manufactures 100% of the Keeper products in the USA.

So, no matter what your power requirements are, count on Eagle-Picher. Because Board Space Is Too Valuable To Waste.

EAGLE EP PICHER

ELECTRONICS DIVISION

Box 130 • Bethel Road • Seneca, MO 64865
Phone: 417-776-2256 • TWX: 62864271 • FAX: 417-776-2257

CIRCLE NO. 137

Real-time Unix system. Aria is a Unix system designed for distributed computer systems in the real-time market. The initial product runs on 68030-based Motorola MVME147S series single-board computers. Versions for other single-board computers will be available later in the year. Single-copy development kit, \$9000. **Integrated Systems Inc.**, 3260 Jay St, Santa Clara, CA 95054. Phone (408) 980-1500. FAX (408) 980-0400. **Circle No. 402**

C++ on IBM framework. AIX SDE Integrator/6000 integrates Green Hills C++ with IBM's AIX software-development environment Workbench/6000 (a framework based on Hewlett-Packard's Softbench technology). It provides C++ compiling and debugging on IBM RISC System/6000 workstations, allowing users to take advantage of the supplier's editor, program builder, static analyzer, and debugger. From \$1400. **Oasys**, 1 Cranberry Hill, Lexington, MA 02173. Phone (617) 862-2002. **Circle No. 403**

Software for estimating software costs. Costar, a software cost-estimating tool, is for managers who need estimates of a software project's duration, staffing, and cost. It allows managers to make preliminary estimates during a project's initial definition, and then produce more and more accurate forecasts as the project's definition is refined. The package runs on any VAX system with VMS or on IBM PCs and compatibles. \$800. **Softstar Systems**, 28 Ponemah Rd, Amherst, NH 03031. Phone (603) 672-0987. **Circle No. 404**

EDN PRODUCT MART

This advertising is for new and current products.

Please circle Reader Service number for additional information from manufacturers.

THE EASY CHOICE

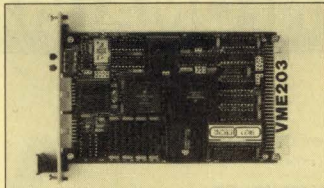

Micro-Link's VME203 SBC makes your design choice easy. Available in several configurations, VME203 prices start at less than \$1,025 in 100 piece quantities. Options include 68EC030 or 68030, FPU, 1 or 4 MB of DRAM with transparent refresh, burst mode Cache, up to 1 MB of EPROM, two RS-232 serial ports, and clock speeds of 16, 32 and 40 MHz. VME203 software support includes Microware OS-9®, CrossCode® C FreeForm™ and Microbug II.

Micro-Link

Call For Your Free Configuration Guide:

1-800-428-6155 US & Canada
1-317-846-1721 International

CIRCLE NO. 325

☆☆☆☆
"The Best 8051 Emulator"

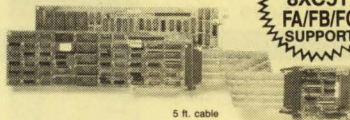

5 ft. cable

**FULL
8XC51
FA/FB/FC
SUPPORT**

8051

SEE EEM 91/92
Pages D 1300-1303

PC based emulators for the 8051 family

8031, 8032, 8051, 8052, 80C152/154/32/45/145/2/51FA/51GB/515/517/535/537/553/662/652/851, 80532, 83C451/52/652/751/752/851, 8344, 87C451/552/751/752, 8751, 8752, DS5000 + CMOS ... more.

- PC plug-in boards or RS-232 box.
- Up to 33 MHz real-time emulation.
- Full Source-level Debugger w/complete C-variable support.
- 64 bit wide, 256k deep trace, with time stamp.
- Bond-out/hooks pods for 8051, 83C552, 83C451, 83C652, 83C751, 80C515/80C517, 83C752, 83C51FA/FB/FC, and more.

CALL OR WRITE FOR FREE DEMO DISK!

Ask about our demo VIDEO

NOHAU
CORPORATION

51 E. Campbell Avenue
Campbell, CA 95008
FAX (408) 378-7869
(408) 866-1820

Call 408-378-2912
Nohau's 24-hour
information center to
receive info via your FAX

CIRCLE NO. 326

Instant Microcontroller

+
Instant C
=
Instant New Product

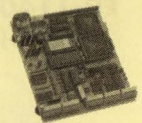

Instant New Product

Use our Little Giant™ and Tiny Giant™ miniature microprocessor-based computers to instantly computerize your product. Our miniature controllers feature built-in power supplies, digital I/O, serial I/O (RS232 / RS485), A/D converters (to 20 bits), solenoid drivers, time of day clock, battery backed memory, watchdog, field wiring connectors, and more! Designed to be easily integrated with your hardware and software. Priced from \$159. Core modules as low as \$59. Low cost, interactive Dynamic C™ makes serious software development easy.

Z-World Engineering

1724 Picasso Ave., Davis, CA 95616 USA
Tel: (916) 757-3737 Fax: (916) 753-5141
Automatic Fax: (916) 753-0618
(Call from your fax, request catalog #18)

CIRCLE NO. 327

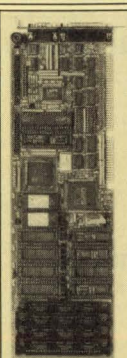

IND-286 SBC

AT Compatible DISKLESS
SBC Includes DOS in ROM

Complete 16MHz 80C286 Single Board Computer for embedded PC applications features a 4M-byte PROMDISK disk emulator with battery back-up and an MS-DOS 3.3 compatible disk operating system in ROM.

Features Include:

- 4M-byte DRAM
- Keyboard Port
- 2 COM, 1 LPT
- IDE Disk Port
- 4M PROMDISK
- 100% PC/AT Compatible
- XT Size Board
- 80287 Socket
- WatchDog Timer
- Floppy Port
- Optional Video Daughter Bd.

Other Products:

- IND-88 PC/XT Single Board Computers
- PROMDISK III & IV Disk Emulators
- FlexScan I & II Bar Code Decoders

MSI micro computer specialists, inc.
2598-g fortune way vista, ca 92083
phone: 619/598-2177 fax: 619/598-2450

CIRCLE NO. 328

UNIVERSAL PROGRAMMER, EMULATOR & TESTER

TUP-400 \$745.00
TUP-300 \$645.00

- New improved hardware and software.
- The most complete PC-based Universal Programmer. Programs PLD (PAL, GAL, FPL, EPLD, PEEL, MAX, MACH...), EPE PROM (up to 16 Mbit), Flash EPROM, BPROM, Special PROM, MPU (87XX, 68XX, Z8, PS3301, PIC16XX, TMS320CXX, UPD75PXXX, HD6370XX...).
- Covers DIP, PLCC, QFP, SOP, and PGA with 8 to 84 pins. Gang Programming adapters available also.
- EPROM EMULATION capability.
- Tests digital ICs and DRAMs (SIMM/SIP adapter available).
- Free software updates and new devices added upon request.
- IC Manufacturers' approval.
- 1 year warranty, 30 day money back guarantee.



CALL TODAY
FOR MORE INFORMATION.
Distributors are welcome!



Tribal Microsystems Inc.
44388 S. GRIMMER BLVD. FREMONT, CA 94538
TEL: (510)623-8859
FAX: (510)623-9925

CIRCLE NO. 329

EXPRESS

Best Value in the World

for

**5
DAY TURN**

PRINTED CIRCUIT PROTOTYPES

LAYERS	2 PIECE PRICES			
	1	2	3&4	5&6 7&8
15	\$212	\$265	\$581	\$715 \$850
30	240	300	658	815 983
60	283	354	775	954 1034
90	325	407	891	1097 1304
120	350	442	949	1092 1417

- 5 PIECES x 1.34
- 10 PIECES x 1.67

EXTRAS

- Photo Plotting
- Testing
- Gold Contacts - \$50
- 25% - Below 8 Mil

DISCOUNTS

10% **5%**
■ COD ■ NET 10
■ CREDIT CARD SALES

FOR MORE INFORMATION CALL OR FAX

Ken Bahl
Sierra Circuits, Inc.
Phone (408)735-7137 FAX (408)735-1408 Modem (408)735-9842

CIRCLE NO. 330

To advertise in Product Mart, call Joanne Dorian, 212/463-6415

EDN April 9, 1992 • 187

FINALLY

One tool to satisfy all your firmware development needs

PROMICE is a universal system.

- Develops code for any microprocessor
- Complete, real time, source level debugging
- Host software for DOS, Unix, Mac, VMS
- Non intrusive on your target system
- Simply plugs into any ROM socket

PROMICE also supports Turbo Debugger, C_thru_ROM, FreeForm, GDB, and more.

PROMICE
...the affordable solution.



TEL: (614)471-1113
West: (415)750-0219
FAX: (614)475-6871

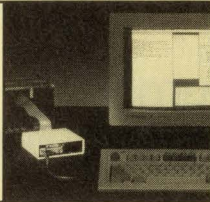

CIRCLE NO. 331

programmable
PC-based US\$ 895.00

PATTERN GENERATOR

40 MHz, 9 channels at 8KB. Connected to the parallel printer port of any PC.

FREE Demo Software available.

For more information call or fax us, today

WITIG TEST TECHNOLOGY Inc.
P.O. Box 8162 WHITE PLAINS, N Y 10602-8162
☎ (914)-948 2606 fax: (914)-948 2641

CIRCLE NO. 332

DR-11W USERS:

New Fiber Optic Link

Our new Fiber Optic Link removes the DR-11W's 50 foot cable limit. We use advanced fiber optic technology so you can separate DR11-W compatible devices up to 2 kilometers—with no loss in system throughput. Our Links connect to your existing DR11-W interfaces with standard 40-conductor flat cables. Join the two Link modules with duplex fiber optic cable, and your system is ready *without software changes.*

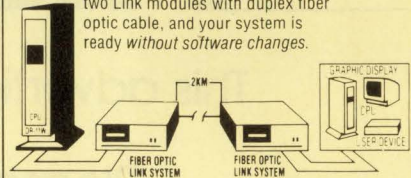

macrolink inc.

1500 North Kellogg Drive ■ Anaheim, California 92807
Phone (714) 777-8800 ■ FAX (714) 777-8807

CIRCLE NO. 333

EP-1140 E/EPROM PROGRAMMER

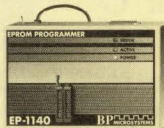

\$895.00

- ✓ Programs NEC's **27C8001, 8-Mbit EPROM** and all **1, 2, & 4-Mbit, 16 bit EPROMs**
- ✓ Supports all 87C51 derivative Microcontrollers, including Intel's **87C51GB**
- ✓ **Qualified and recommended** by Intel, National Semi and Signetics.
- ✓ Supports encryption array programming for microcontrollers
- ✓ Call for a DEMO disk and literature packet
- ✓ Risk-free 30-day money-back guarantee
- ✓ Lifetime **FREE** software updates via BBS and US Mail

BP MICROSYSTEMS

10681 Haddington • Houston, TX 77043-3239
800/225-2102 • FAX 713/461-7413

CIRCLE NO. 334

SUPERPRO® now \$699 (US only)

Super Value Universal Programmer

Include Free !!!
4 SOCKET ADAPTER (\$125),
or PAL COMPILER (\$95),
or EPROM ERASER (\$95)

- Easy to use menu driven S/W
- Universal programming for Flash E(EP)ROM, Bipolar PROM, PAL, GAL, EPLD, & microcontroller, etc.
- Test ICs (TTL, RAM)
- Life time free S/W updates on BBS & 1 year H/W warranty
- Developed & made in U.S.A.

EPROM programmer
ROM MASTER : \$149
Low cost
universal programmer
UNIPRO : \$399
764 San Aleso Avenue
Sunnyvale, CA 94086
(408)745-7974
FAX 745-1401
BBS 745-7256

XELTEK

CIRCLE NO. 335

INFOMATRIX

PC-Based
Universal
Device Programmer
Certified by IC Manufacturers

INFINITI-PC

- Programs most PLDs and memories up to 40pins
- Menu driven device selection by P/N and manufacturer
- Full screen editor for fuse maps and memory buffers
- JEDEC standard vector test functions
- New devices can be easily added by yourself
- Self test and diagnosis for high programming yield
- One year warranty and free device update

408 / 371-4642

2265 Bascom Ave. #20, Campbell, Ca 95008

CIRCLE NO. 336

DC/CAD

introducing...

THE TERMINATOR

Super High Density Router
(Complete with Schematic & PCB EDITOR)

Features the following powerful algorithm & capability:

- Rip-up and Retry
- Pre-routing of SMT components
- Real-Time via minimization
- Real-Time clean up passes
- User defined strategies
- Window 3.0 capability as DOS Task
- 1-mil Autoplacer and Autoplanning
- Two-way Gerber and DXF
- Automatic Ground Plane w/ Cross Hatching
- Complete w/ Schematic & Dolly Libraries
- Optional simulation capability & protected mode for 386 users

Call for
FREE DEMO DISK
price range:
\$295 - \$1495

* PCB LAYOUT SERVICE AT LOW COST *
LEASE PROGRAM & SITE LICENSE AVAILABLE

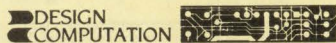

1771 State Highway 34, Farmingdale, NJ 07727
(908) 681-7700 • (908) 681-8733 (FAX)

"DC/CAD...The focal point of future CAD market"

CIRCLE NO. 337

R&M PREDICTION AND FMECA SOFTWARE

Powertronic Systems offers software to predict reliability, maintainability and FMECA. Since 1982, hundreds of users have selected from our large, versatile, integrated software family for military and industrial equipment, electrical or mechanical. Program highlights include: visible assembly hierarchy, defaults and library data, extensive report sorting, user defined reports, what-if and derating analysis, and concurrent engineering data links.

- ◆ MIL-HDBK-217
- ◆ MIL-HDBK-472
- ◆ MIL-HDBK-338
- ◆ Bellcore
- ◆ DTRC-90/010
- ◆ MIL-STD-1629
- ◆ MIL-STD-756B
- ◆ NPRD-91

PSI POWERTRONIC SYSTEMS, INC.

13700 Chef Menteur Hwy.
New Orleans, LA 70129
504-254-0383 ◆ FAX: 504-254-0393

CIRCLE NO. 338

Interactive/Real-Time

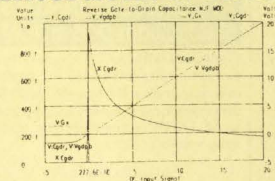

ECA-2
Engineering a Better Way

Analog Circuit Simulation

- AC, DC, Transient, Fourier, Temperature, MonteCarlo and/or Worst-Case Analysis
- Interactive or batch modes
- Full nonlinear simulation
- On-line real time graphics
- Multiple plots
- 2 to 50 times faster than SPICE
- Component optimization sweeping
- New 424 pg. manual

**All the Features, Twice the Speed
at Half the Cost**
Call for **FREE DEMO!**
313-663-8810



Tatum Labs, Inc.
1287 N. Silo Ridge Drive
Ann Arbor MI 48108

CIRCLE NO. 339

Advin

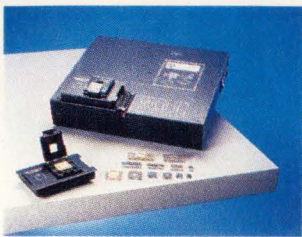

ADVIN versus DATA I/O

- **Data I/O and Model 2900:** reputable company, dependable equipment, supports 40-pins. Software updates: fair amount.
- **Advin and PILOT-U40:** reputable company, dependable equipment, supports 40-pins. Software updates: free via electronic BBS.

ADVIN SYSTEMS INC.
Smaller Company, Better Service.

800-627-2456, 408-243-7000, Fax 408-736-2503

CIRCLE NO. 340

1992 SIGNAL SELECTION GUIDE SOURCE

Send for this free guide featuring a range of Synthesized RF Signal Generators+ RC and Function Generators. You'll find more capability packed in Fluke's generators than anybody on the market today.

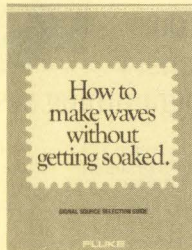

Call: 800-44-FLUKE
FLUKE

CIRCLE NO. 341

PLCC PROBING

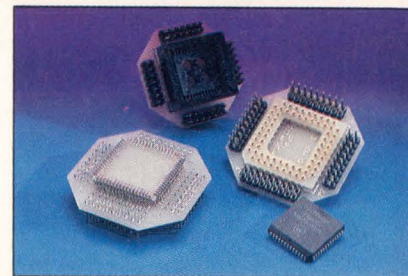

IN SOCKET

- Probe socketed PLCC chips
- Lowest profile socketed PLCC PROBE
- Mechanically and electrically reliable connection
- Choice of PLCC, PGA, LCC, cable (top socket)
- Sizes from 20 to 84 pins
- Optional height extender
- Custom design services



IRONWOOD ELECTRONICS
P.O. BOX 21151, ST. PAUL, MN 55121
(612) 431-7025; FAX (612) 432-8616

CIRCLE NO. 342

WRITE OR CALL FOR SAMPLE
Low Cost Tempilabel[®] Temperature Monitor.

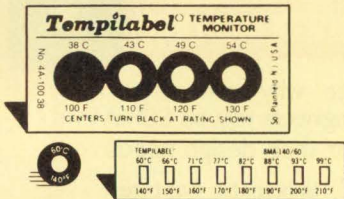

How to put a low cost temperature gauge on everything.

Label's center spot turns black when surface to which it is affixed reaches specified temperature. Single- or multi-spot labels with pre-determined increment of ratings: 100°F (38°C) to 600°F (316°C). 1% accuracy guaranteed. 1 thru 8 ratings on each monitor with various increments. Self-adhesive, removable.

TEMPIL, Big Three Industries, Inc.
2901 Hamilton Blvd., South Plainfield, NJ 07080
Phone: (908) 757-8300 Telex: 138662

CIRCLE NO. 343

DAR is the only EDA Directory Source you will ever need.

DAR (Design Automation Research) is an electronic directory. DAR can save hours in searching for ASIC and CAD/CAE vendors. DAR supports the entire top-down design process from CONCEPT to REALITY. DAR requires a PC with a hard disk.

- Select vendors' suite of design tools from a search form.
- Pull-down menus.
- Performs powerful search statements.
- Works with Microsoft-compatible mouse drivers.
- Each field contains a search word list.
- Updates occur on a quarterly basis.
- \$395 annual subscription fee.

Call for a FREE evaluation disk.



16321 Gothard Street, #F, Huntington Beach, CA 92647
714/848-3477

CIRCLE NO. 344

8051 68HC11 COP8

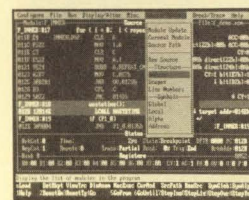

iceMASTER Your Window To Emulation Productivity

- Easy to learn & use
- Windowed interface -- user configurable
- FAST! Download -- < 3 sec. typ. at 115KB
- Source Level debug

- A 4K frame trace buffer with advanced searching capabilities.
- iceMASTER connects easily to your PC, requires no disassembly, or expansion slots. Works on any PC (DOS or OS/2), MicroChannel or EISA. Even laptops!
- iceMASTER is versatile: iceMASTER-8051, iceMASTER-68HC11 and iceMASTER-COP8 support most family derivatives.
- Rental and 10-day trials available.
- 68HC11 A,D,E,F; 8XC528; 8XC552; 8XC515A and 8XC517A support.
- Call today for free demo disk and ask about a free 8051 Macro Assembler! (800) 638-2423



MetaLink Corporation P.O. Box 1329 Chandler, AZ 85244-1329
Phone: (602) 924-9797 FAX: (602) 924-1198 TELE: 499050MILX



CIRCLE NO. 345

VGA EXTENDED 700 FEET!

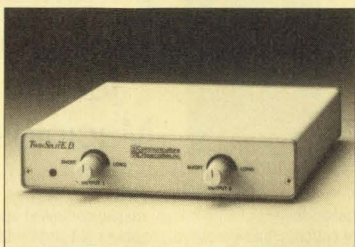

TwinSplit™ E.D.

- Locate VGA monitors up to 700 feet from computer
- 2 outputs available, both up to 700 feet
- Supports all VGA/SVGA cards and monitors
- Low-loss extension cable available
- Only \$549, 1 year warranty

Communications
Specialties, Inc.

TEL: 516-273-0404 FAX: 516-273-1638

CIRCLE NO. 346

CMOS SRAMs

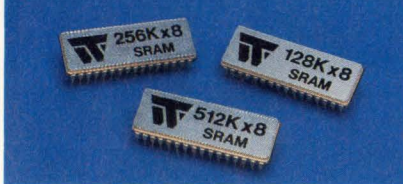

Something for Everyone.

- 25ns to 120ns
- 512Kx8, 256Kx8, 128Kx8
- Low Power
- 32-pin DIP
- JEDEC Pinouts
- Commercial, Industrial and Military Temperatures
- Military Screening Available
- Certified to MIL-STD-1772

White Technology, Inc.

A wholly owned subsidiary of Bommar Instrument Corporation
4246 E. Wood Street • Phoenix, Arizona 85040
Tel: (602) 437-1520 • FAX (602) 437-9120

CIRCLE NO. 347

Analog Circuit Simulation

- Schematic Entry
 - SPICE Simulation
 - Model Libraries
 - Waveform Processing
- only \$990

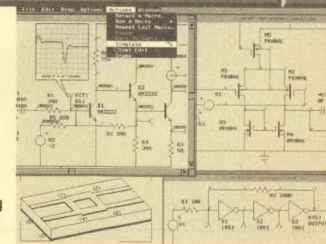

Powerful - Affordable

FULLY INTEGRATED, EASY TO USE, ANALOG CIRCUIT SIMULATION ENVIRONMENT, FROM ONE VENDOR, FEATURING: A powerful SPICE simulator performing AC, DC, and Transient, analyses, extensive model libraries, schematic entry, graphical waveform processing, and report quality printouts.

Call Or Write For Your Free Demo and Information Kit!
Tel. 310-833-0710



P.O. Box 710 San Pedro, CA 90738-0710
Fax 310-833-9658

CIRCLE NO. 348

FREE CATALOG



Affordable tools for programmable devices are just a phone call away.

- Unbeatable values on Data I/O® device programmers, software, updates, and accessories
- 30-day, money-back guarantee

- Access to Data I/O's toll-free technical hotline and on-line bulletin board

To order your FREE catalog, call Data I/O Direct today.

1-800-3-DataIO
(1-800-332-8246)

DATA I/O

CIRCLE NO. 349

Save 50% on our memory programming system.



Now \$995!*

- Includes the 212 Multi Programmer with EPROM module, and PROMlink™ Ltd. PC Interface Software
- Supports more than 400 EPROMs up to 40 pins

- Full-hex keypad for extensive editing
- Optional logic and microcontroller modules
- Manufacturer-specified algorithms ensure accuracy

1-800-3-DataIO
(1-800-332-8246)

*U.S. list price only.



Call Data I/O® Direct today to order the 212 Memory System.

DATA I/O

CIRCLE NO. 350

PC POWER SUPPLY MONITOR

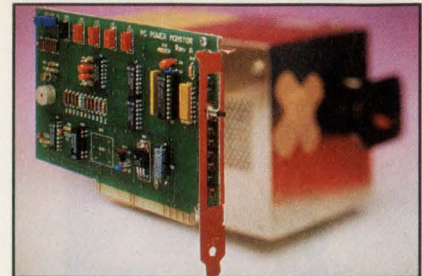

Designed as a diagnostic aid for PC/XT/EISA systems, the Wintek PC Bus Power Monitor Card (\$195) provides a quick way of checking the power supply in a personal computer. LEDs provide a real-time indication of power quality, as well as remembering momentary out-of-tolerance operation. A deluxe model (\$249) has an audible alarm, a system clock monitor, and a refresh signal monitor.



Wintek Corporation
1801 South Street
Lafayette, IN 47904

Phone: (800) 742-6809 or (317) 448-1903

CIRCLE NO. 751

State Machine Design

For Complex & High Density PLDs



The most powerful PLD/FPGA CAE design software from \$495.00

CUPL™ 4.2

1-800-331-7766 LOGICAL DEVICES, INC.

CIRCLE NO. 752

Device Programming

Certified by the Semiconductor Industry

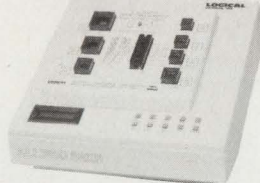

World's largest selection of PC based and stand-alone programmers from \$395.00 to \$10,000.

ALLPRO™ 88

1-800-331-7766 LOGICAL DEVICES, INC.

CIRCLE NO. 753

FREE DEMO DISKS



See why over 20,000 engineers rely on SCHEMA for their design needs.

- ✓ Schematic Capture
- ✓ PCB layout & routing
- ✓ Simulation
- ✓ PLD design

Call 800-553-9119



801 Presidential * Richardson, TX 75081
(214) 231-5167 * FAX (214) 783-9072

CIRCLE NO. 754

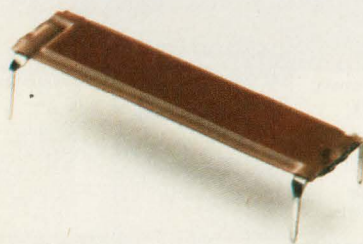

SIMPLIFY BOARD LAYOUT

MICRO/Q 1000 ceramic decoupling capacitors share board mounting holes with IC pins to simplify board design. Now add more active devices with increased density in the same space, or design the same package on a smaller board. Rogers Corp. 2400 S. Roosevelt St., Tempe, AZ 85282. 602/967-0624

CIRCLE NO. 755

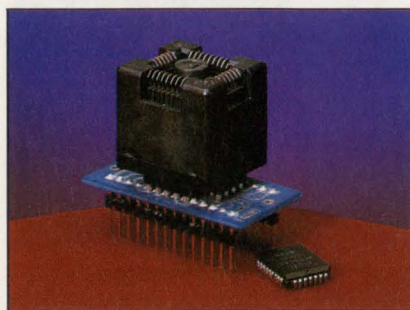

PAL/PROM Programmer Adapters

- Any EPROM programmer designed for DIPs can be converted to accept LCC, PLCC, and SOIC sockets in seconds!
- To program, just insert an Adapt-A-Socket™ between the programmer's DIP socket and the circuit to be programmed.
- Designed to fit all types of EPROM programmers, including Data I/O 120/121A, Stag, Logical Devices, etc.
- Quick turnaround on custom engineering services, if needed. For a free catalog, contact:

Emulation Technology, Inc.
2344 Walsh Ave. Santa Clara, CA 95051
Phone: 408-982-0660 FAX: 408-982-0664



CIRCLE NO. 756



Schematic Capture for the Macintosh

DESIGNWORKS

Schematic features Menu-driven, mouse-controlled operations • cut/copy/paste between circuits • right-angle rubber-banding. **Digital simulation** 13-state, event-driven simulation • logic analyzer-style timing window • PLD support. **Libraries** Fully-simulated 7400, 4000, 10K series, PLDs, PROMs and RAMs, non-simulated analog and discrete components • User-definable, simulated custom symbols. **Interfaces** Formats for Douglas CAD/CAM, Cadnetix, Calay, Orcad, Tango, Racal Redac, Spice. • user-definable printers, dot-matrix printers, HP, Houston, Roland pen plotters.

CALL (800) 444-9064 TODAY FOR YOUR FREE DEMONSTRATION KIT!

CAPILANO COMPUTING
(604) 522-6200 Fax (604) 522-3972

CIRCLE NO. 757

To advertise in Product Mart, call Joanne Dorian, 212/463-6415

smx simple multitasking executive v2.1

FULL FEATURED KERNEL

- task manager
- memory manager
- intertask comm.
- error manager
- i/o, events, & timing
- resource manager
- preemptive
- ROM'able

EASY TO USE

- libraries for Microsoft C, Borland C/C++, Zortech C/C++ and assembler
- Quick Start, User's Guide, and Reference manuals
- standalone, PC, and DOS platforms
- smxProbe task debugger
- 6 months free support and updates

FAST & SMALL

- 15 usec max. interrupt latency
- 150 usec typical task switch
- 8 to 25 KB code size

Ask about our \$95 evaluation kit.

MICRO pd DIGITAL Call for information:
6402 Tulagi St. **1-800-366-2491**
Cypress CA 90630-5630 FAX 714-891-2363

CIRCLE NO. 758

Imagine if
YOUR
product
could
talk!

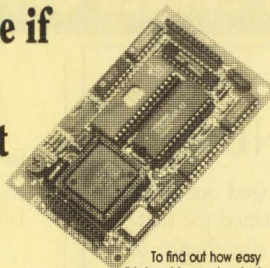

To find out how easy it is to add speech output to your own products, call for your free V8600 data book today!

- Converts plain ASCII text into high quality speech
- Built in μ P, serial and printer interfaces
- Use in computers, voice-mail, warning systems, etc.
- Less than \$100 in OEM quantities
- Requires only a single 5V supply and speaker
- Technology licensing available

RC SYSTEMS USA/Canada Phone/Fax: (206) 672-6909
121 W Winesap Rd - Bothell, WA 98012 UK/Europe 81 539 0285 Fax: 81 558 8110

CIRCLE NO. 759

AVAL

An Established Foothold In
The Device Programming Arena



The Traditional
Market Leader In Japan

U.S. Tel./Fax 1-619-727-4683 / 5232
Europe Tel./Fax 353-1-2892136 / 2892070
Japan Tel./Fax 81-3-3344-2001 / 2007
Daisan Maruzen Bldg., 6-16-6 Nishi Shinjuku,
Shinjuku-Ku, Tokyo 160, Japan.

AVAL CORPORATION

CIRCLE NO. 760

CMOS 186

Single Board Computer

Runs C or QuickBASIC™ Programs

Powerful 16-bit computer directly executes EPROM's containing any C or BASIC .EXE file. NO LOCATORS! Software includes multi-tasking, multi-drop comm, PID control, OPTOMUX™.

- 10, 12, 16 MHz 80C186
- CMOS design
- 512K RAM
- 384K EPROM
- STD BUS Expansion
- COM1 RS232/485
- COM2, LPT1
- RTC Avail
- 80C187 Avail
- OEM discounts

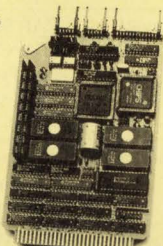

MICRO/SYS

1011 Grand Central Ave., Glendale, CA 91201
(818) 244-4600 FAX (818) 244-4246

CIRCLE NO. 761

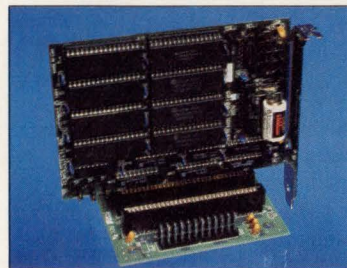

VMAX® DE2 SOLID STATE DISK DRIVE

- FAST, faster than hard drive disk access
- One year warranty / Made in the U.S.A.
- 100% DOS compatible, bootable
- DURABLE, withstands harsh environments
- PC/AT Bus, fits standard expansion slot
- Software Included — program SRAM & FLASH on-board
- SMALL size / LOW price
- \$135 qty. 1; Quantity Pricing Available

VMAX®
TEMPUSTECH, INC.
295 Airport Road
Naples, FL 33942

CIRCLE NO. 762

Tango®
The Complete
Electronic Design Solution.

For FREE evaluation software
and product specs,
call 800 488-0680

Tango, the leader in
PC-based tools for:

- Schematic entry
- PCB layout and autorouting
- PLD design
- Simulation, timing verification and thermal reliability

ACCEL Technologies, Inc.
6825 Flanders Drive
San Diego, CA 92121-2986
Service 619 554-1000
Fax 619 554-1019

CIRCLE NO. 763

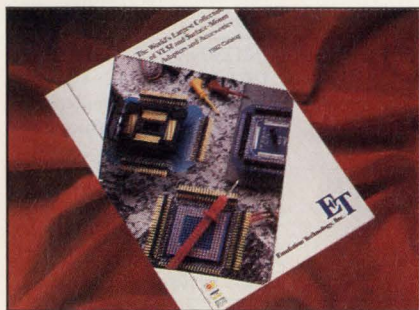

Free Catalog

The World's Largest Collection of Adapters & Accessories for VLSI/Surface Mount Devices

- Emulator Pods & Adapters
- Debugging Accessories
- Debug Tools
- Prototyping Adapters
- Programming Adapters
- Custom Engineering
- Socket Converters

Emulation Technology, Inc.
2344 Walsh Ave. Santa Clara, CA 95051
Phone: 408-982-0660 FAX: 408-982-0664



CIRCLE NO. 764

**MICROPROCESSOR
EMULATORS**

Zax provides a comprehensive series of real-time emulation support for Motorola, Intel, NEC, Zilog, and Hitachi microprocessors. Some of the highlighted features include source-level debug, real-time trace, and performance analysis.

Call now for more information:

(800) 421-0982
(714) 474-1170 (Inside CA)
(714) 474-0159 (Fax)

ZAXTEK

42 Corporate Park Irvine, CA 92714

CIRCLE NO. 765

Telecom Solutions from Teltone

**R1 and R2 MF
Transceivers**

M-986 transmits and receives CCITT R1 or R2 forward and backward multifrequency signals. For trunk adapters, test equipment, etc.

- Single or dual channel versions available
- For N. Am. (R1) or Int'l. (R2) toll signals
- Binary or 2 of 6 input/output format
- Complete microprocessor interface
- 40-pin IC, 5-volt power, crystal time base

1-800-426-3926

Or: 206-487-1515 Fax: 206-487-2288

TEL TONE®

INNOVATING SOLUTIONS
In Telecom Interface Components

Teltone Corporation, 22121-20th Avenue SE, Bothell, WA 98021

CIRCLE NO. 766

To advertise in Product Mart, call Joanne Dorian, 212/463-6415

EDN April 9, 1992 • 191

VLSI IS HAPPENING.

History is just that. Some great events changed our lives, captured our imaginations. Now they're destined for textbooks and campfire memories. But you have the chance to take part in history that won't fade away. Because right now, VLSI is happening. Our Tempe headquarters for our Personal Computer Products and Government Divisions currently has the following opportunities.

SENIOR SOFTWARE ENGINEERS

The first position entails developing and validating design flows between multiple CAE vendors. Additionally, you will develop software to support RAM, ROM and Datapath compilers on CAE systems and test vector translators. To qualify, you need a BSEE coupled with 4+ years' related experience, as well as demonstrated software abilities and strong IC design skills. Knowledge of simulation modeling techniques, delay calculations and back annotation is also necessary. Job #6532-CTM

The second opportunity involves specifying and implementing test generation software. The ideal candidate will possess a BSEE/CS and 4+ years' related experience including ASIX, TEKLT1101, and a variety of test methodologies. Strong knowledge of test conversion programming software and demonstrated programming skills are also important. Job #6532-CTM

SENIOR DESIGN ENGINEER

Working as part of a team to implement functional system blocks in chip-level designs, you will help design, develop and productize megacells, megafunctions and functional system blocks for use in ASIC and standard product designs. A BSEE coupled with 3+ years' digital logic design experience with PC logic functions is necessary to qualify. Knowledge of VHDL modeling is desirable. Job #6532-CTM

PC SYSTEMS ENGINEERS

You will take responsibility for program management, definition, specification and system design of customer specific PC ICs which are derivatives of our new and exciting PC products. A BSEE (MS preferred) coupled with 5+ years' experience with hardware motherboard design for PC/AT or compatible PCs is necessary to qualify. Familiarity with DRAM, CPU and peripheral subsystem design for PCs is essential, as is experience as a project team manager. A background managing IC design/development is preferred. Job #6250-MU

We offer a competitive salary and an outstanding benefits package. Please send your resume, indicating position desired and including appropriate Job # to: VLSI Technology, Inc., Professional Staffing, Personal Computer Products and Government Divisions, 8375 South River Parkway, Tempe, AZ 85284. Pre-employment drug screen required. EOE



VLSI TECHNOLOGY, INC.
IT'S HAPPENING HERE

1992 Recruitment Editorial Calendar

Issue	Issue Date	Ad Deadline	Editorial Emphasis
News Edition	Apr. 30	Apr. 16	ASICs SPECIAL ISSUE FPGAs and EPLDs • CICC Hot Products • ASICs Regional Profile: Northern California
Magazine Edition	May 7	Apr. 16	Communications/Networks Test & Measurement • Surface-Mount Components • Power Sources • Electro Show & Products Issue
ELECTRO SHOWGUIDE & PRODUCT SPOTLIGHT		Apr. 3	A free page available to all advertisers running a full page in 2 out of 3 Electro issues
News Edition	May 14	Apr. 30	Graphics Technology Computers & Peripherals
Magazine Edition	May 21	Apr. 30	Analog ICs • Analog CAE • PC Board CAE Tools • Programmable-Logic Devices
News Edition	May 28	May 14	Communication ICs • CAE Software • Regional Profile: Texas, Oklahoma, Kansas
Magazine Edition	June 4	May 14	ASICs/PLDs • DSP Software CAE/Software/Interoperability Digital ICs & Semiconductors
News Edition	June 8	May 21	CAE SPECIAL ISSUE EDA/CASE Supplement • DAC Hot Products • Software Engineering • Diversity Special Series
Magazine Edition	June 18	May 28	Microprocessors • Electro-mechanical Devices • ICs & Semiconductors
SOFTWARE ISSUE	June 18	May 28	SOFTWARE ENGINEERING SPECIAL ISSUE (To be polybagged with the June 18th Magazine Edition issue)
News Edition	June 25	June 11	MILITARY ELECTRONICS SPECIAL ISSUE • DSP Hardware • Military Electronics Regional Profile: Florida, Alabama
Magazine Edition	July 6	June 11	INTERNATIONAL PRODUCT SHOWCASE—Vol. I Hardware & Interconnect Software • ICs & Semiconductors • Power Sources
Magazine Edition	July 20	June 25	INTERNATIONAL PRODUCT SHOWCASE—Vol. II Computers & Peripherals Components • CAE • Test & Measurement
News Edition	July 23	July 9	Engineering PCs & Workstations • CAE Software SIGGRAPH Hot Products Graphics Technology • Engineering Management Special Series • Regional Profile: Arizona, New Mexico

Call today for information on

Recruitment Advertising:

East Coast: Janet O. Penn (201) 228-8610

West Coast: Nancy Olbers (603) 436-7565

National: Roberta Renard (201) 228-8602

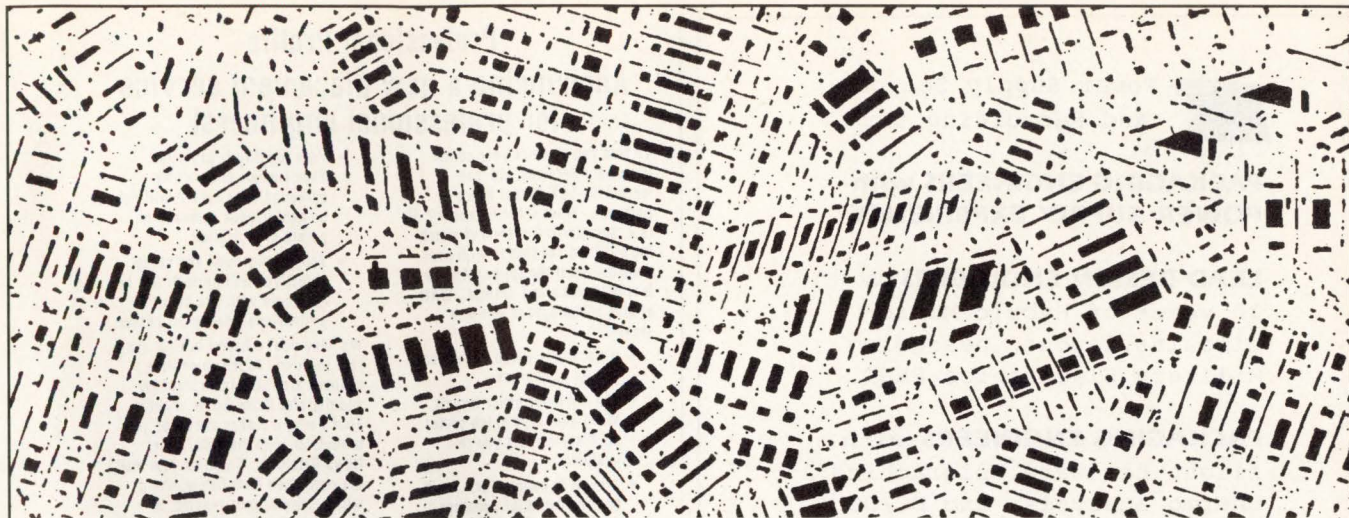

YOU SUPPLY THE ENERGY. WE'LL SUPPLY THE POWER.

It's no accident that companies worldwide turn to us for electrical power protection. After all, our line of Uninterruptible Power Systems is an uninterrupted success story--one that's meant exceptional growth for us. The idea now is to maintain this growth, and the way to do that is to continue to do what we've done, namely, offer the highest quality, most reliable systems. Equally important, we'll continue to hire those with talent, skill and unlimited energy. If that's you, we invite you to join Exide Electronics.

Electrical Engineers (5) Raleigh, NC

Immediate openings exist for individuals with a minimum of 5 years' experience in Electrical Engineering and experience in the design of low voltage systems. These positions will provide system-level design; will coordinate UPS systems and will specify details of low voltage switchgear, transformers, and relay circuits. Detailed working knowledge of appropriate UL, NEMA, and NEC standards needed. BSEE required, PE desired. Experience in communicating designs using CAD/CAM systems preferred.

Construction Supervisors (7) Dallas, TX

The qualified applicants will be responsible for managing turnkey installation of UPS, Generator, and other electrical systems. Individuals will make site visits nationally and internationally to assess conditions; prepare CAD-generated drawings, write specifications, request bids and make awards to contractors, manage and oversee installations, estimate costs, and prepare cost accounting analysis and profit reports. Successful candidates must have a BSEE or equivalent com-

bination of an advanced or specialized management position with an overall minimum of six years' experience in electrical installations and design. Requires a thorough knowledge of the National Electrical Code. Prefer knowledge of computer (PC) operation and training in CAD-generated drawings. Must possess a valid and current Master Electrician's License.

Sr. Technical Training Instructors (2) Raleigh, NC

The successful candidates will instruct UPS maintenance schools, including lecturing, demonstrating product performance, guiding workshops and hands-on sessions; conducting problem-solving labs, testing student performance, providing oral and written evaluations; developing and maintaining course materials, which includes: writing course outlines and writing or modifying technical descriptions; producing video tapes to include: writing scripts, designing sets, and directing and editing tapes. Must possess a 2-year degree in electronics or equivalent specialized training and have a minimum four years of test/repair experience and two years' training experience.

Customer Support Engineers (2) Raleigh, NC

The qualified candidates will evaluate performance and adequacy of preventative maintenance performed; inspecting clean power, adequate environmental characteristics and adherence to critical adjustments; verifying engineering change notices; inspecting and certifying local maintenance capabilities. Incumbents will take part in or conduct technical programs initiated by the home office;

receive necessary training and take part in the initial installation of new equipment with product line; assessing the needs of service personnel in specialized areas; formulating plans of attack on problems and presenting them to the customer and/or District Manager; scheduling and evaluating personnel and equipment in assigned technical areas; maintaining all technical documents at the District Office; maintaining evaluation checklist package and appropriate forms. Requires a two-year degree or equivalent specialized training and a minimum three years' experience as a CSE and one year as a Systems Field Engineer; requires the ability to understand moderately complex mathematical formulas, charts and engineering drawings.

Schedulers (2) Raleigh, NC and Dallas, TX

Immediate openings exist for individuals with a minimum of 5 years' experience in CPM scheduling. The individuals will be responsible for the input and output of program scheduling information in a timely manner. Scheduling, maintenance and report generation are just a few of the individuals' responsibilities. The position requires hands-on scheduling software training, college degree and an ability to work under minimum supervision.

At Exide Electronics, you'll enjoy the salary and benefits you'd expect from an industry leader. For prompt consideration, please send your resume to: **Paul Rousseau, Manager of Employment, Exide Electronics, P.O. Box 58189, Raleigh, NC 27658.** Exide Electronics is an Equal Opportunity Employer. No agency referrals, please.

EXIDE ELECTRONICS

Helping You Stay In Power™



Power Supply Search
and Recruiting firm

**PACKAGING ENGINEERS with
POWER SUPPLY EXPERIENCE**

LEAD DESIGN ENGINEERS w
10 years of Hybrid Micro-
circuits, layout, designing
Military Electronics PKGE.

PACKAGING ENGINEERS with
flight hardware, Unigraphics,
thermo analysis, and DC/DC
spacestation applications.

MECHANICAL DESIGNERS will
provide original packaging
concepts, layouts, prototype
production for power supplies
and amplifiers.

Fax's or send your resume to:

POWER SUPPLY RECRUITER
P.O. BOX 420209
HOUSTON, TEXAS 77242-0209
FAX'S: 713-977-4121

If you're looking
for work,
just look here.

EDN Magazine
Edition
News
Edition

Professional Profile

**Announcing a new placement service
for professional engineers!**

To help you advance your career, Placement Services, Ltd. has formed the EDN Career News Databank. What is the Databank? It is a computerized system of matching qualified candidates with positions that meet the applicant's professional needs and desires. What are the advantages of this new service?

- It's absolutely free. There are no fees or charges.
- The computer never forgets. When your type of job comes up, it remembers you're qualified.
- Service is nationwide. You'll be considered for openings across the U.S. by PSL and its affiliated offices.

- Your identity is protected. Your resume is carefully screened to be sure it will not be sent to your company or parent organization.
- Your background and career objectives will periodically be reviewed with you by a PSL professional placement person.

We hope you're happy in your current position. At the same time, chances are there is an ideal job you'd prefer if you knew about it. That's why it makes sense for you to register with the EDN Career News Databank. To do so, just mail the completed form below, along with a copy of your resume, to: Placement Services, Ltd., Inc.

IDENTITY

Name _____
Home Address _____
City _____ State _____ Zip _____
Home Phone (include area code) _____

**PRESENT OR MOST RECENT
EMPLOYER**

Parent Company _____
Your division or subsidiary _____
Location (City, State) _____
Business Phone if O.K. to use _____

EDUCATION

Degrees (List)	Major Field	GPA	Year Degree Earned	College or University

**POSITION DESIRED
EXPERIENCE**

Present or Most Recent Position _____ From _____ To _____ Title _____
Duties and Accomplishments _____ Industry of Current Employer _____
Reason for Change _____

PREVIOUS POSITION

Job Title _____
Employer _____ From _____ To _____ City _____
State _____ Division _____ Type of Industry _____
Salary _____ Duties and Accomplishments: _____

**COMPENSATION / PERSONAL
INFORMATION * (optional)**

Years Experience _____ Base Salary _____ Commission _____
Bonus _____ Total Compensation _____ Asking Compensation _____
Min. Compensation _____ Date Available _____
 I own my home. How long? _____ I rent my home/ apt.
 Employed Self-Employed Unemployed
 Married Single Height _____ Weight _____
Level of Security Clearance _____ I Will Travel _____
 U.S. Citizen Non-U.S. Citizen Light Moderate Heavy
 WILL RELOCATE WILL NOT RELOCATE OTHER _____
My identity may be released to: Any employer All but present employer

EDN Databank A DIVISION OF
PLACEMENT SERVICES
LTD., INC.
265 S. Main Street, Akron, OH 44308 216/762-0279

Knock, Knock.

In EDN's
Magazine
and News
Editions,
opportunity
knocks all
the time.

EDN Magazine
Edition
News
Edition

Great Work. Great Living. IBM Burlington, Vermont.

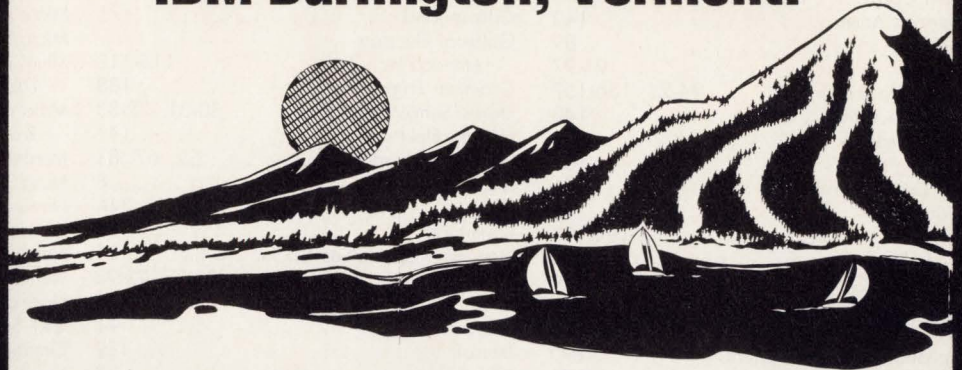

One of the world's most advanced semiconductor operations is what you'll find at IBM's major development and manufacturing facility in Burlington, where continued business growth is matched by a superb living environment. We now have outstanding career opportunities for engineers with the specialized computer skills to make significant impact on RISC microprocessor development.

Logic Design

Responsible for definition, logic design and verification of high performance RISC microprocessors. To qualify, you must possess a BSEE or higher, with an emphasis on Computer Engineering, and be capable of carrying logic design through to physical chip design stage. Minimum of 3 years in logic/chip, CMOS and VLSI design required. RISC experience is key. Background in microprocessor and multiprocessor design desirable.

Circuit Design

Will design CMOS circuitry for RISC-based microprocessor functions. Includes custom SRAM cache design, complex logic dataflow circuitry, random logic, IO, clocking and other circuitry in custom microprocessor layouts. Requires BSEE or higher with emphasis on Computer Engineering or Circuit Design. Ability to design complex CMOS or Bi CMOS circuits and perform circuit analysis and verification is essential, along with minimum of 3 years circuit design experience in industry. CMOS, VLSI, digital circuit design is a prerequisite.

Physical Design

Responsible for CMOS VLSI chip physical design of RISC microprocessor in advanced CMOS technology. Includes using state-of-the-art CAD tools to perform chip layout, wiring and chip timing analysis. A BSEE or higher, with emphasis on Computer Engineering or Circuit Design, is essential, along with at least 3 years of physical design experience in industry. RISC and CMOS, VLSI design experience (chip layout/wiring) necessary. Background in microprocessor design desirable.

Located between Lake Champlain and Vermont's Green Mountains, Burlington offers year round recreation and open space. Unspoiled beauty, affordable housing and a sense of community come together here. This is life at its most enjoyable; technology at its best.

IBM offers salaries commensurate with qualifications and a comprehensive benefit package. For confidential consideration, please send your resume, indicating area of interest, to: **IBM Corporation, Professional Recruiting, 1000 River Street, Essex Junction, VT 05452.**

An equal opportunity employer.

EDN-INTERNATIONAL ADVERTISERS INDEX

ACCEL Technologies Inc	191
Actel	120-121
Advanced Micro Devices	10-11, 42-43
Advin Systems	189
Alcatel	133
Altera Corp	150
American Arrium	142
Ametek	89
AMP	96-97
Analog Devices Inc	24-25, 156-157
Antex Electronics	140
Astec America	178
Augat	162
Aval Corp of Ireland	191
Axion	189
BASF*	194-195
BP Microsystems	188
Burr-Brown Corp	79
Butterworth Heineman	348
Capital Equipment Corp	196
Capilano Computer Systems Inc	190
Coilcraft	172
Comdisco	75
Communications Specialties Inc	189
Condor	49
Cybernetic Micro Systems	23
Cypress Semiconductor	4
Dale Electronics Inc	34
Data I/O Corp	C4, 190
Datron Wavetek	119
Design Computation Inc	188
Diversified Technology	52-53
Eagle Picher	186
EDN Caravan	158-159

EEsof	1
Emulation Technology Inc	190, 191
Epson America Inc	129
Ericsson Components	160
Euro ASIC*	16
Force Computers Inc	14-15
Gifts-In-Kind	175
Goldstar Electron America Inc	115-118
Grammar Engine Inc	188
Harris Semiconductor	30-31, 32-33
Harting Elektronik	141
Hewlett-Packard Co	C2, 67, 81
IDT	8
IMD*	34A
Infomatrix	188
Instrument Specialties Co Inc	91
Intel	26-27, 92-93
International Rectifier	C3
Interpoint	44
Intusoft	189
IOtech Inc	78
Ironwood	189
ITT Cannon	3
John Fluke Manufacturing Co Inc	6, 54-56, 189
Lambda Electronics Inc	163-168
Lanier/Copier	72
Lattice Semiconductor Corp	111
Lemo USA Inc	185
Linear Technology Corp	143-144
Logical Devices Inc	113, 190
Macrolink Inc	188
MathSoft Inc	9

Maxtor	94-95
MCSI	187
MetaLink Corp	189
Meta Software Inc	134
Micro Digital	191
Micro Link	187
MicroSim Corp	19
Micro/Sys	191
Mini-Circuits Laboratories	20-21, 28-29, 147, 198
Motorola Semiconductor Products Inc	57-59, 85-87
Murrietta Circuits	149
Music Semiconductor	177, 179
National Instruments	2
National Standards Association	174
Network Research	169
Nohau Corp	187
NordicTrack	175
OKI Semiconductor	151
Omaton Inc	190
Orbit Semiconductor	69-71
Oxley	149
PADS Software Inc	171
P-Cad	68A-68B
Philips*	150-151
Pico	68, 90
Powertronic	188
Qua Tech Inc	173
Raltron	149
Raytheon Semiconductor Div	82
RC Systems	191
Rogers Corp	190
Samsung Semiconductor	35-38
Sanyo	131
SBE	60
Seagate Technology	51
Siemens Components	16
Sierra Circuits	187
Signum Systems	177
Siliconix Inc	12-13
Stanford Research Systems Inc	170
Tasco Electronic Services Inc	197
Tatum Labs	188
Tektronix	40-41, 152-155, 180-182
Teltone Corp	191
Tempil Div	189
Tempustech Inc	191
Tracewell Enclosures	179
Tribal Microsystems	187
Versatec	77
Westcor	46
White Technology	189
Wickmann Werke	173
Wind River Systems	22
Wintek Corp	190
Wittig	188
WSI	65
Xeltek	188
Xerox Engineering Systems/ Versatec Products	77
Xilinx	161
Zaxtek	191
Z-World	187

Recruitment Advertising 192-195

Power Supply Recruiters
IBM Corp
Exide Electronics
VLSI Technology

*Advertiser in European edition

This index is provided as an additional service. The publisher does not assume any liability for errors or omissions.



You can control any IEEE-488 (HP-IB, GP-IB, 488.2) device with our cards, cables and software for the PC/AT/386, EISA, Micro Channel and Macintosh II. You get fast hardware and software support for all the popular languages, plus a software library of time saving utilities. Instrument control has never been easier.

FREE
Informative Catalog **800-234-4CEC**
Applications help **617-273-1818**

cec Capital Equipment Corp.
Burlington, MA. 01803

Micro Channel is a trademark of IBM

CIRCLE NO. 138

THE SILENT CHALLENGER

TASCO Electronics, a recognized leader of digital technology in Japan, is introducing a new and exceptionally silent integrated thermal driver, for installation in many OEM products. The amazingly quiet (70dB) and unparalleled high speed (maximum 300 LPM), reproduces the finest graphic details. Its compact and maintenance free carriage is a gift any design engineer will be thrilled receiving and put to good use in a hurry.

The PE-525 being introduced to the world market is worthy of your most critical acclaim. Call now for more information about the SILENT CHALLENGER.

TASCO PE-525
High speed,
high resolution
thermal driver

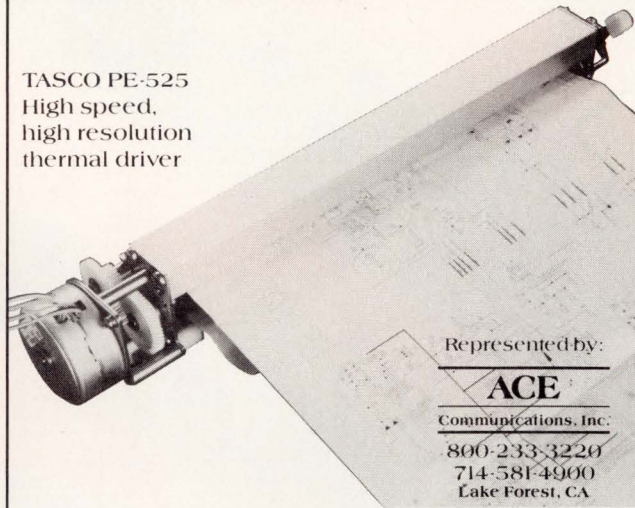

Represented by:

ACE

Communications, Inc.

800-233-3220

714-581-4900

Lake Forest, CA

TASCO Electronics Co., Ltd.
22511 Aspan St. Lake Forest, CA 92630
Tel (714) 581-5197 Fax (714) 581-4941

CIRCLE NO. 139

Continuing the Same Standards of Editorial Excellence

EDN ASIA

Launching in May 1992

EDN Asia will be circulated to 28,000 engineering professionals in Asia and will be published in three languages: English, Chinese and Korean.

EDN-ACRONYMS & ABBREVIATIONS

- A/D—**analog-to-digital**
- BBS—**bulletin-board system**; an electronic bulletin board accessed via personal computers using modems
- CAD—**computer-aided design**
- CAE—**computer-aided engineering**
- CAM—**content-addressable memory**
- CMOS—**complementary metal-oxide semiconductor**
- CMRR—**common-mode rejection ratio**
- CPU—**central processing unit**
- DAC—**digital-to-analog converter**
- DAM—**data-addressable memory**
- DDE—**Dynamic Data Exchange**; a formal protocol that Windows programs can use to exchange data while running
- DIP—**dual in-line package**
- DLL—**Dynamic Link Library**; a program fragment or module loaded and unloaded as needed while a program runs
- DMA—**direct memory access**; generally a faster data-transfer method than processor-managed data transfers
- DOS—**the disk operating system IBM PC-compatibles use**
- ECL—**emitter-coupled logic**
- EEPROM—**electrically erasable programmable read-only memory**
- EPLD—**erasable programmable logic device**
- EPROM—**erasable programmable read-only memory**
- FDDI—**fiber distributed data interface**
- FIFO—**first in, first out**
- FPGA—**field-programmable gate array**
- GUI—**graphical user interface**
- HMOS—**high-performance metal-oxide semiconductor**
- IC—**integrated circuit**
- I/O—**input-output**
- LAN—**local-area network**
- LSB—**least significant bit**
- MOS—**metal-oxide semiconductor**
- MSB—**most significant bit**
- MSI—**medium-scale integration**
- NMOS—**N-type metal-oxide semiconductor**
- NRE—**nonrecurring engineering**
- OLE—**Object Linking and Embedding**; a mechanism for embedding one Windows program in another Windows program
- PAL—**programmable array logic**
- PC—**IBM-compatible personal computer**
- pc—**printed circuit**
- PLD—**programmable logic device**
- PROM—**programmable read-only memory**
- RAM—**random-access memory**
- RC—**resistance-capacitance**
- ROM—**read-only memory**
- S/H—**sample and hold**
- SPICE—**a public-domain analog-circuit simulation program from UC Berkeley**
- SSI—**small-scale integration**
- TLB—**translation look-aside buffer**
- TSR—**terminate-and-stay-resident program**; a kluge that, to a slight degree, makes up for the lack of multitasking in DOS
- TTL—**transistor-transistor logic**
- VDMAD—**Virtual DMA Driver**; a Windows multitasking mechanism
- VPICD—**Virtual Programmable Interrupt Controller Driver**; a Windows multitasking mechanism

This list includes acronyms and abbreviations found in EDN's Special Report, Technology Updates, and feature articles.

incredible!

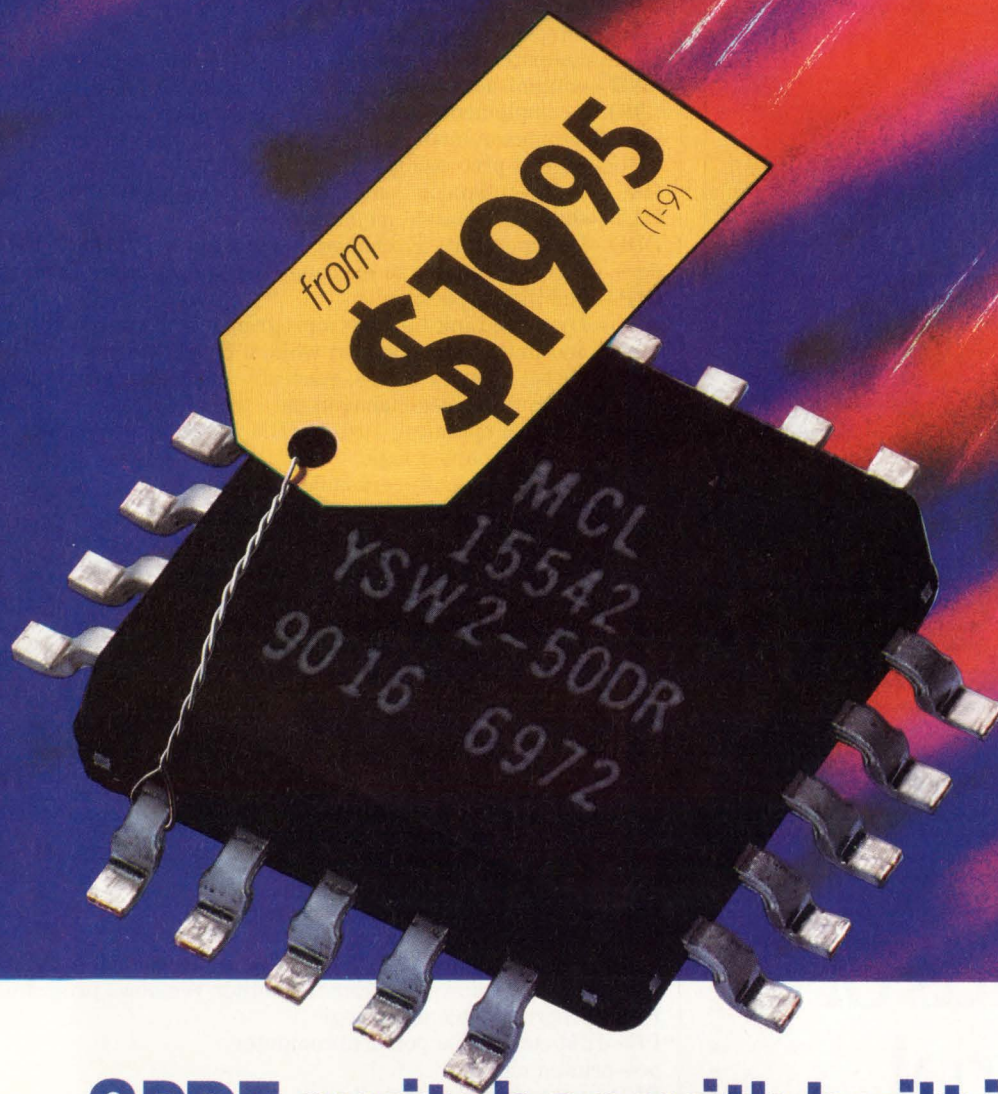

SPDT switches with built-in driver

ABSORPTIVE or REFLECTIVE dc to 5GHz

Truly incredible...superfast 3nsec GaAs SPDT reflective or absorptive switches with built-in driver, available in pc plug-in or SMA connector models, from only \$19.95. So why bother designing and building a driver interface to further complicate your subsystem and take added space when you can specify Mini-Circuits' latest innovative integrated components?

Check the outstanding performance of these units...high isolation, excellent return loss (even in the "off" state for absorptive models) and 3-sigma guaranteed unit-to-unit repeatability for insertion loss. These rugged devices operate over a -55° to +100°C span. Plug-in models are housed in a tiny plastic case and are available in tape-and-reel format (1500 units max, 24mm). All models are available for immediate delivery with a one-year guarantee.

finding new ways...
setting higher standards



Mini-Circuits

P.O. Box 350166, Brooklyn, New York 11235-0003 (718) 934-4500 Fax (718) 332-4661 Telexes: 6852844 or 620156

SPECIFICATIONS (typ)

	Absorptive SPDT			Reflective SPDT		
	YSWA-2-50DR	ZYSWA-2-50DR		YSW-2-50DR	ZYSW-2-50DR	
Frequency (MHz)	dc-500	500-2000	2000-5000	dc-500	500-2000	2000-5000
Ins. Loss (dB)	1.1	1.4	1.9	0.9	1.3	1.4
Isolation (dB)	42	31	20	50	40	28
1dB Comp. (dBm)	18	20	22.5	20	20	24
RF Input (max dBm)		20		22	22	26
VSWR "on"	1.25	1.35	1.5	1.4	1.4	1.4
Video Bkthru (mV,p/p)	30	30	30	30	30	30
Sw. Spd. (nsec)	3	3	3	3	3	3
Price, \$ (1-9 qty)	YSWA-2-50DR (pin) 23.95 ZYSWA-2-50DR (SMA) 69.95			YSW-2-50DR (pin) 19.95 ZYSW-2-50DR (SMA) 59.95		

CIRCLE NO. 140

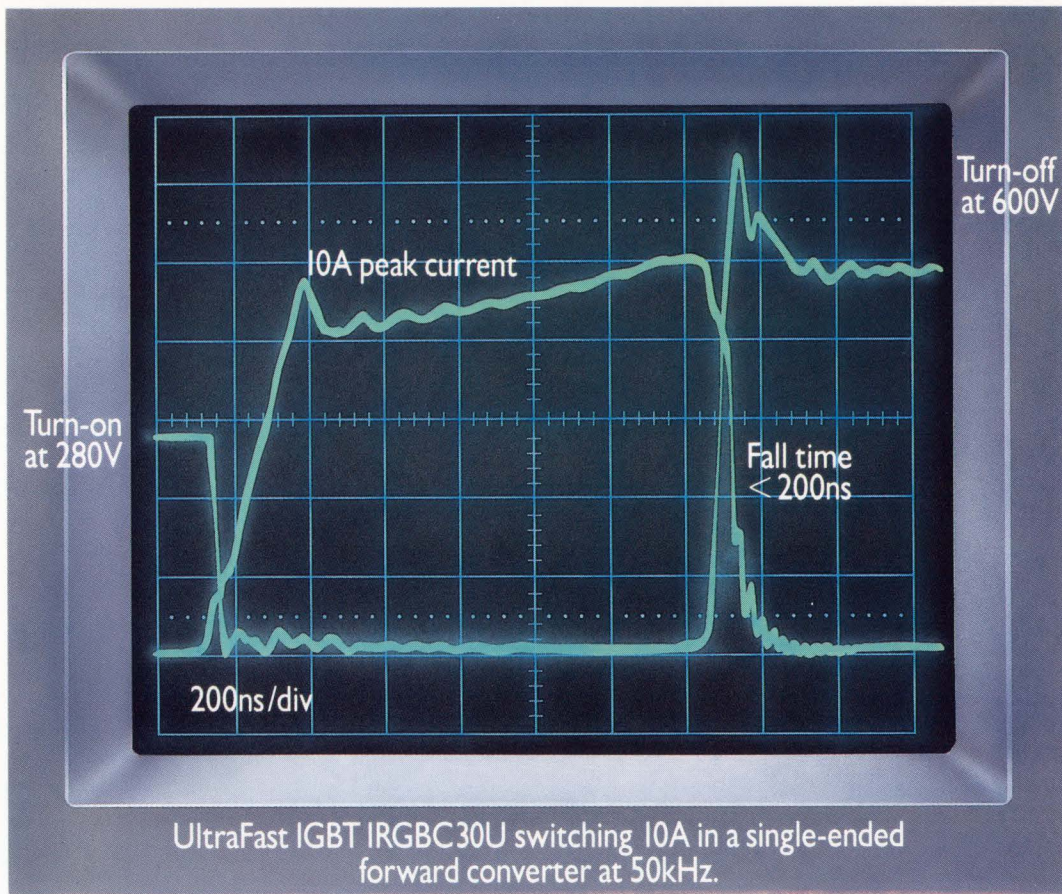

IGBTs Without A Trace of Competition.

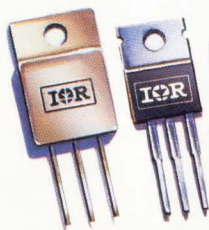

IR announces Ultra Fast IGBTs: our 600V power transistors that switch faster and run cooler than any you've ever used. Forget about bipolar. Put these

breakthrough devices in your high-voltage, high-current, medium-frequency applications and get performance unparalleled for the price.

Which should come as no surprise. IR IGBTs build on the same proprietary technology that made IR's HEXFETs® world leaders.

Call 1 (213) 640-6534 and ask about Standard, Fast or Ultra-Fast IGBTs, optimized for your operating frequency. And available from 10A to 70A, in commercial or hi-rel packages.

We'll be happy to arrange a screening.

IR International Rectifier

WORLD HEADQUARTERS: 233 KANSAS ST., EL SEGUNDO, CA 90245, U.S.A. (213) 772-2000. TWX 910 348-6291, TELEX 472-0403. EUROPEAN HEADQUARTERS: HURST GREEN, OXTED, SURREY RH8 9BB, ENGLAND TELEPHONE (0883) 713215, TELEX 95219

CIRCLE NO. 147

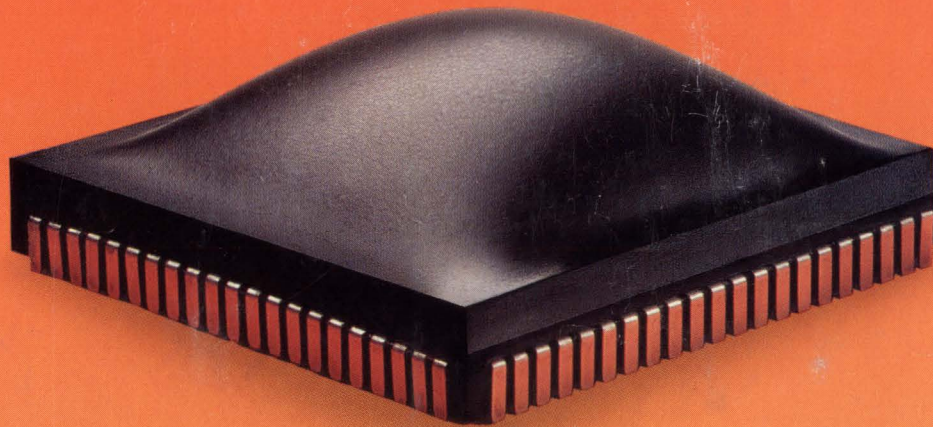

Pack more logic into every FPGA.

NEW ABEL-FPGA helps you get the most out of the latest FPGAs. If you want to take advantage of the sophisticated capabilities of today's FPGAs, only Data I/O®'s new ABEL-FPGA™ Design Software has the power to pack in maximum logic. It combines the industry-standard ABEL Hardware Description Language (ABEL-HDL™) with our new intelligent FPGA Device Fitter™

technology. So, you can create more complex designs with less effort — ABEL-FPGA does the hard work for you!

ABEL-FPGA's powerful Device Fitters automatically optimize your circuits for minimum area or maximum speed. Fitters are available for all the leading architectures, including Actel, Altera, AMD, Atmel, Cypress, ICT, National, Plus Logic, Texas Instruments, and Xilinx. And with built-in knowledge of its target architecture, each fitter masters the

complex features of its device automatically, intelligently.

Practical, detailed documentation, complete with FPGA design examples, also helps to ensure that you get the most from each architecture. And for added design power and flexibility, ABEL-FPGA lets you specify place-and-route constraints directly in your circuit description, so you can easily migrate the same design between multiple FPGA vendors.

Pack more logic into your next FPGA design, with the single solution to all your FPGA behavioral entry needs: ABEL-FPGA.

Call us today to find out more about NEW ABEL-FPGA.



1-800-3-DataIO
(1-800-332-8246)

DATA I/O

CIRCLE NO. 142

ABEL-FPGA

Design Software

Data I/O Corporation 10525 Willows Road N.E., P.O. Box 97046, Redmond, WA 98073-9746, U.S.A. (206) 881-6444
Data I/O Canada 6725 Airport Road, Suite 302, Mississauga, Ontario L4V 1V2 (416) 678-0761
Data I/O Europe 660 Eskdale Road, Winnersh, Wokingham, Berkshire, United Kingdom RG11 5TS, 0734 448899
Data I/O GmbH Lochhamer Schlag SA, 8032 Graefelfing, Germany, +49 (0)89-868580
Data I/O Japan Summitomoseimeji Higashishinbashi Bldg., 8F, 2-1-7, Higashi-Shinbashi, Minato-Ku, Tokyo 105, Japan
©1992 Data I/O Corporation

NEW
ABEL-FPGA
with FPGA
Device Fitters!