

EDNI[®]

Designing semicustom analog ASICs	pg 35
PC-based logic simulators	pg 47
Real-time programming series—Part 9	pg 85
State-machine design	pg 95

ELECTRONIC TECHNOLOGY FOR ENGINEERS AND ENGINEERING MANAGERS



Special Report:
Competitive 3½-in. hard-disk drives erode demand for larger units pg 72

Complete Family Of High Performance D/A Converters

Burr-Brown offers one of the industry's most complete line of high performance digital-to-analog converters. High quality and reliability are assured by our 35+ years of microcircuit design and manufacturing experience. Key features include:

- wide selection of 12-bit, 16-bit, and 18-bit resolution DACs with many performance options
- μ processor-compatible DACs with double-buffered latches
- zero-chip interface DACs for digital signal processing and digital audio applications
- low cost, low power, CMOS DACs
- variety of package options

New Family Members

Complete 12-Bit DAC813

- $\pm 1/2$ LSB linearity error
- μ processor interface
- 270mW max power dissipation
- compact 0.3" wide DIP, SOIC
- from \$11.90*

Dual 12-Bit CMOS DAC7800/04/02

- 8-bit, 12-bit, serial port interface
- single +5V supply
- 4 quadrant multiplying
- 0.3" wide DIP, SOIC
- From \$12.35*

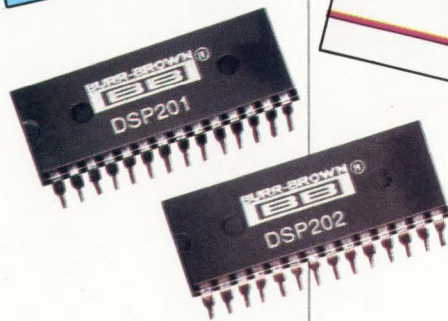
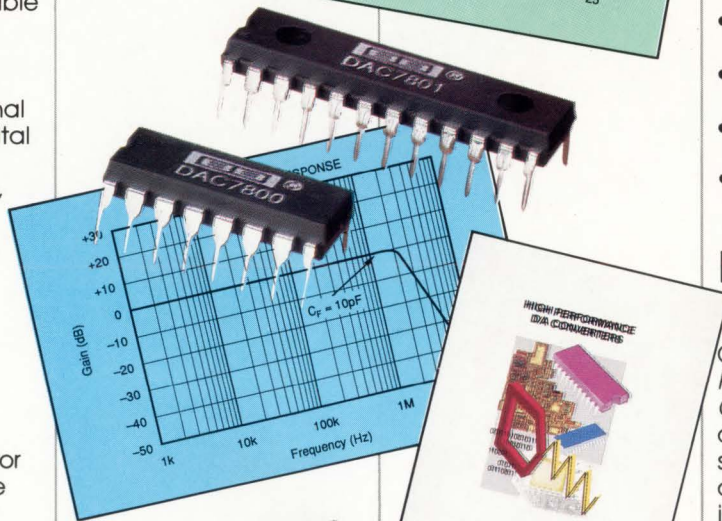
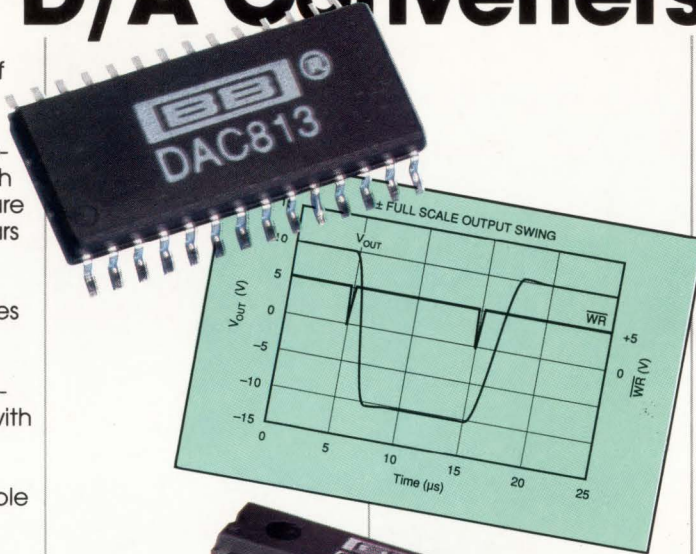

Single/Dual 18-bit DSP201/202

- zero-chip interface to most popular DSP ICs
- 500kHz update rate
- 90dB Signal-to-Noise +Distortion
- -92dB THD
- from \$24.95*

Low Power, 12-Bit DAC667

- drop-in AD667 replacement
- 390mW max power dissipation
- fast 60ns digital interface
- $\pm 10V$ out on $\pm 12V$ to $\pm 15V$ supplies
- From \$11.90*

Free Selection Guide

Our new *High Performance D/A Converters* guide contains key product specs, performance diagrams, applications information and examples of our newest D/A converters. Ask your Burr-Brown sales representative for a copy, or call **1-800-548-6132** for immediate assistance.

Burr-Brown Corp.
P.O. Box 11400
Tucson, Az 85734

*U.S. OEM prices, in 100s.

BURR-BROWN®

BB

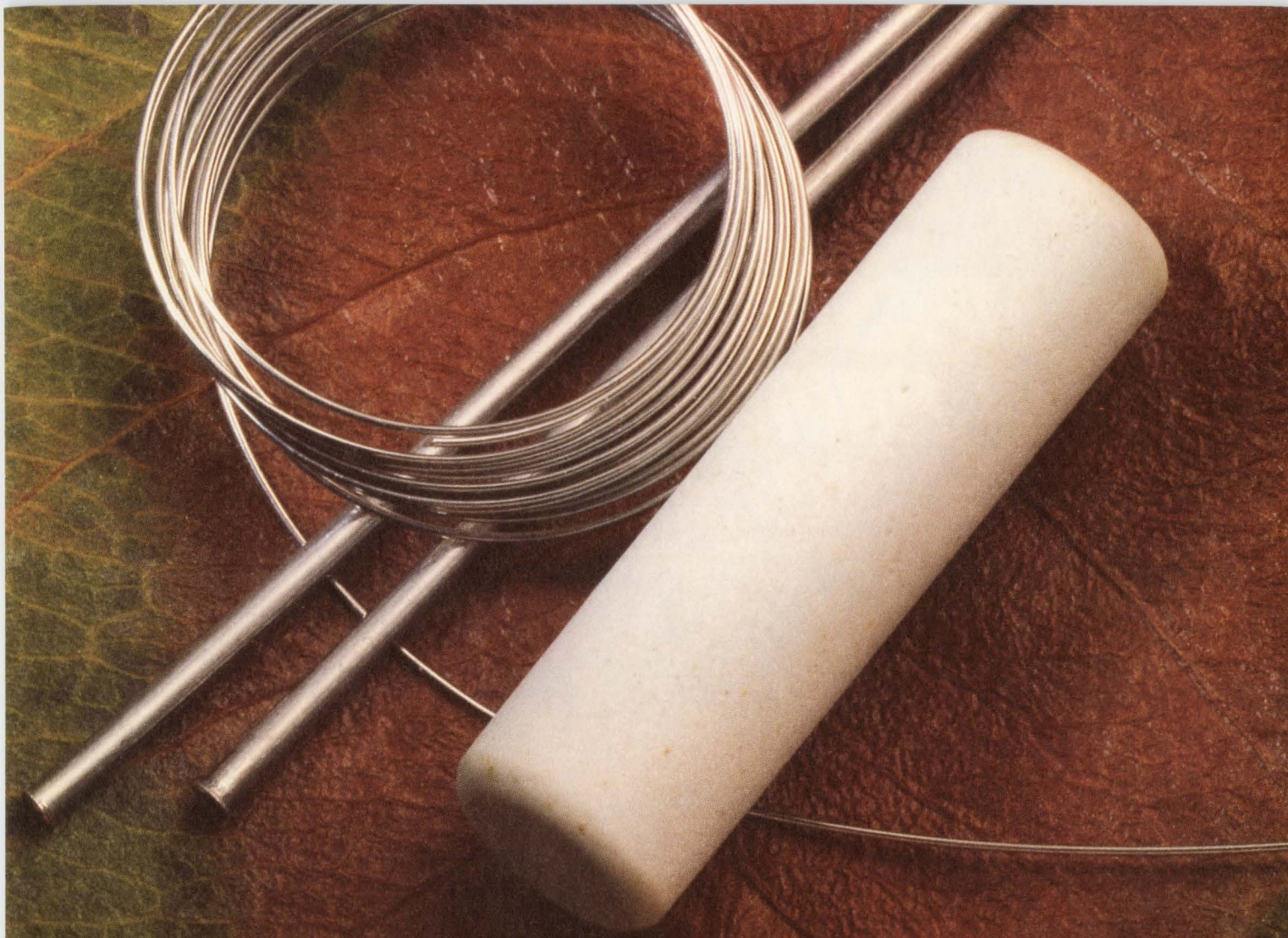

2 grams of ceramic and 18 inches of wire can't make you more competitive.

There's only one real reason to specify Dale® wirewound resistors: We'll work harder turning something common into something uncommonly valuable. Up front, that means saving you selection time by producing every standard shape and size in the book. Plus, we give you immediate access to design assistance and a wide range of proven special products.

It means factory and distributor stocking programs that can be quickly fine-tuned to your Just-In-Time delivery programs.

And, it means making reliability

Dale® Can.



the least of your worries with well-established Statistical Process Control and Quality Assurance systems to give you ship-to-stock capability.

Dale wirewound resistors.

Circle No. 1

They're not commodities — they're the power you need to help make your products more competitive. Contact your Dale Representative or Distributor, or phone: 402-563-6506. Dale Electronics, Inc., 1122 23rd Street, Columbus, NE 68601-3647.



MEASURE LEADTIMES IN HOURS, NOT DAYS!

***At Digi-Key, more than 99 percent of
all orders are shipped within 24 hours!***

***For all your electronic component needs and
free catalog, call toll free: 1-800-344-4539***



Digi-Key
CORPORATION

701 Brooks Avenue South
Thief River Falls, MN 56701

Toll-Free: 800-344-4539, FAX: 218-681-3380

Circle No. 2

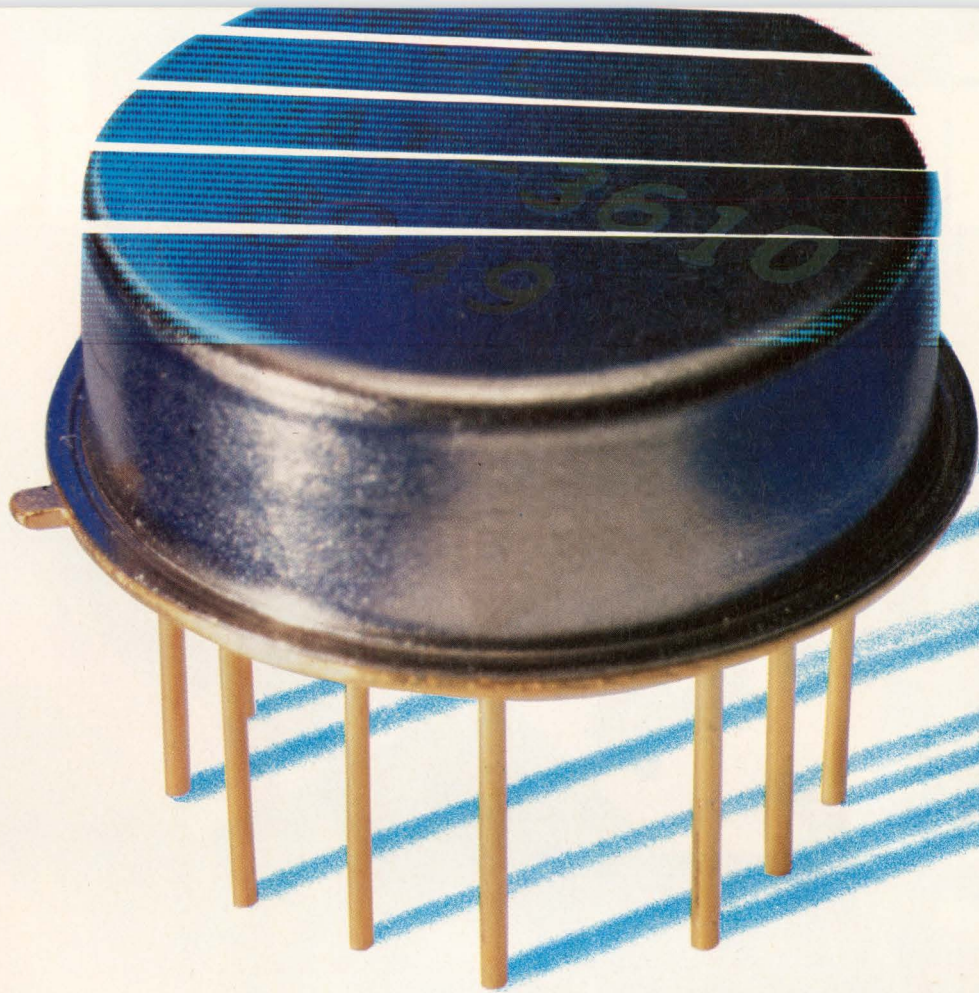

PRECISION TTL-CONTROLLED ATTENUATORS

up to 35dB
10 to 1000MHz
only **\$5995**

TOAT-R512 Accuracy (dB) (+/-dB)		TOAT-124 Accuracy (dB) (+/-dB)		TOAT-3610 Accuracy (dB) (+/-dB)		TOAT-51020 Accuracy (dB) (+/-dB)	
0.5	0.12	1.0	0.2	3.0	0.3	5.0	0.3
1.0	0.2	2.0	0.2	6.0	0.3	10.0	0.3
1.5	0.32	3.0	0.4	9.0	0.6	15.0	0.6
2.0	0.2	4.0	0.3	10.0	0.3	20.0	0.4
2.5	0.32	5.0	0.5	13.0	0.6	25.0	0.7
3.0	0.4	6.0	0.5	16.0	0.6	30.0	0.7
3.5	0.52	7.0	0.7	19.0	0.9	35.0	1.0

bold faced values are individual elements in the units

Now...precision TTL-controlled attenuators accurate over 10 to 1000MHz and -55 to +100°C. Four models are available in the new TOAT-series, each with 3 discrete attenuators switchable to provide 7 discrete and accurate attenuation levels (see chart). Cascade all four models for up to 64.5dB control in 0.5dB steps. Custom values available on request.

The 50-ohm TOAT-series performs with 6µsec switching speed and can handle power levels up to 0dBm. Units are housed in a rugged hermetically-sealed TO-8 package to withstand the shock, vibration, and temperature stresses of MIL-STD-883. Connector versions are available. Take advantage of the \$59.95 (1-9 qty) price breakthrough to stimulate new applications as you implement present designs and plan future systems.



finding new ways...
setting higher standards

Mini-Circuits

WE ACCEPT AMERICAN EXPRESS

CIRCLE NO. 110

P.O. Box 350166, Brooklyn, New York 11235-0003 (718) 934-4500 Fax (718) 332-4661 Domestic and International Telexes: 6852844 or 620156

F 140 REV. ORIG.

incredible!

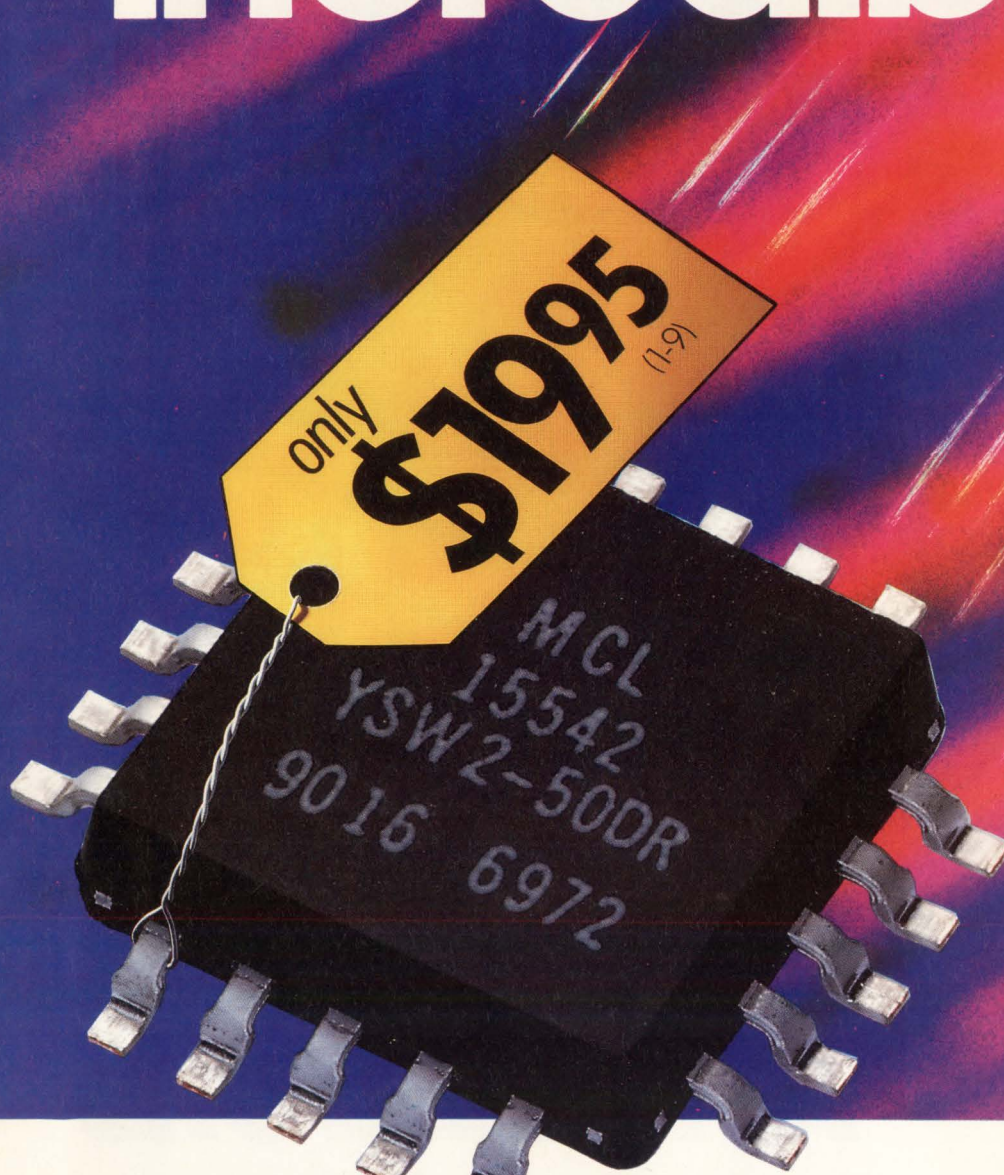

SPDT switch dc to 5GHz with built-in driver

Truly incredible... a superfast 3nsec GaAs SPDT reflective switch with a built-in driver for only \$19.95. So why bother designing and building a driver interface to further complicate your subsystem and take added space when you can specify Mini-Circuits' YSW-2-50DR?

Check the outstanding performance specs of the rugged device, housed in a tiny plastic case, over a -55° to $+85^{\circ}$ C span. Unit-to-unit repeatability for insertion loss is 3-sigma guaranteed, which means less than 15 of a 10,000-unit production run will come close to the spec limit. Available for immediate delivery in tape-and-reel format for automatic placement equipment.

SPECIFICATIONS YSW-2-50DR

	dc- 500MHz	500- 2000MHz	2000- 5000MHz
Insertion loss, typ (dB)	0.9	1.3	1.4
Isolation, typ(dB)*	50	40	28
1dB compression, typ (dBm @ in port)	20	20	24
RF input, max dBm (no damage)	22	22	26
VSWR (on), typ	_____	1.4	_____
Video breakthrough to RF, typ (mV p-p)	_____	30	_____
Rise/Fall time, typ (nsec)	_____	3.0	_____

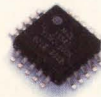

*typ isolation at 5MHz is 80dB and decreases 5dB/octave from 5-1000 MHz

finding new ways ...
setting higher standards



Mini-Circuits

WE ACCEPT AMERICAN EXPRESS

P.O. Box 350166, Brooklyn, New York 11235-0003 (718) 934-4500 Fax (718) 332-4661 Telexes: 6852844 or 620156

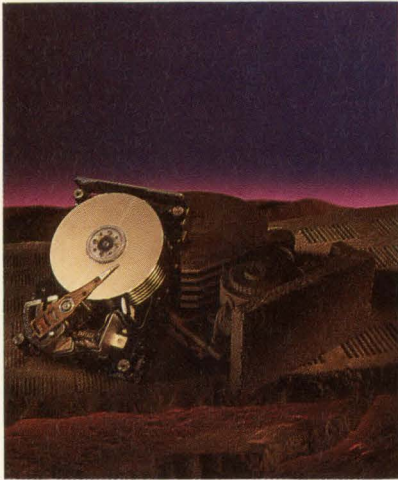

On the cover: The trends that are sculpting the hard-disk-drive market—higher capacities, faster operation, lower prices—are embodied in the latest round of 3 1/2-in. devices. See our Special Report beginning on pg 72. (Photo courtesy Conner Peripherals Inc; design by Greg Meadows and Ken Camozzi, Meadows Graphic Arts Inc; models by Steve Pombo, Pombo Enterprises; photography by Tim Tabke, Phoenix Productions)

SPECIAL REPORT

High-capacity 3 1/2-in. hard-disk drives 72

New 3 1/2-in. hard-disk drives have capacities exceeding 500M bytes and perform as well as high-end 5 1/4-in. units. The small drives are as reliable as 5 1/4- and even 8-in. drives and can be found in workstations, file servers, and drive arrays.—*Maury Wright, Regional Editor*

DESIGN FEATURES

Real-time programming—Part 9 85

The discussion of task coordination methods continues in Part 9 of this series with an overview of how semaphores and controlled shared variables coordinate tasks in real-time applications. Part 10 will discuss task coordination and communication via signals.—*David L Ripps, Industrial Programming Inc*

State-machine design curbs illegal states and transitions 95

You can learn theoretical state-machine design from myriad sources, but most neglect to tell you how to design state machines that work reliably. Such neglect is unfortunate—and unnecessary—because reliability is fairly easy to come by.—*Ricardo Rabinovich, Librascope Corp*

TECHNOLOGY UPDATES

Semicustom analog ASICs: Design methods resist generalization 35

Designing an analog ASIC requires a tremendous amount of communication between system and IC designers.—*Anne Watson Swager, Regional Editor*

PC-based logic simulators: Device capabilities are growing 47

Improvements in hardware and software are making PC-based logic simulation an alternative to workstations and mainframes for small- and medium-sized designs.—*Doug Conner, Regional Editor*

Continued on page 7

EDN[®](ISSN 0012-7515) is published 48 times a year (biweekly with 2 additional issues a month, except for February, which has 3 additional issues and July and December which have 1 additional issue) by Cahners Publishing Company, A Division of Reed Publishing USA, 275 Washington Street, Newton, MA 02158-1630. Terrence M McDermott, President; Frank Sibley, Senior Vice President/General Manager, Boston Division; Jerry D Neth, Senior Vice President/Publishing Operations; J J Walsh, Senior Vice President/Finance; Thomas J Dellamaria, Senior Vice President/Production and Manufacturing; Ralph Knupp, Vice President/Human Resources. Circulation records are maintained at Cahners Publishing Company, 44 Cook Street, Denver, CO 80206-5800. Telephone: (303) 388-4511. Second-class postage paid at Denver, CO 80206-5800 and additional mailing offices. **POSTMASTER:** Send address corrections to EDN[®], PO Box 173377, Denver, CO 80217-3377. EDN[®] copyright 1991 by Reed Publishing USA; Ronald G Segel, Chairman and Chief Executive Officer; Robert L Krakoff, President and Chief Operating Officer; William M Platt, Senior Vice President. Annual subscription rates for nonqualified people: USA, \$109.95/year; Canada/Mexico, \$135/year; Europe air mail, \$165/year; all other nations, \$165/year for surface mail and \$250/year for air mail. Single copies are available for \$10. Please address all subscription mail to Ellen Porter, 44 Cook Street, Denver, CO 80206-5800.

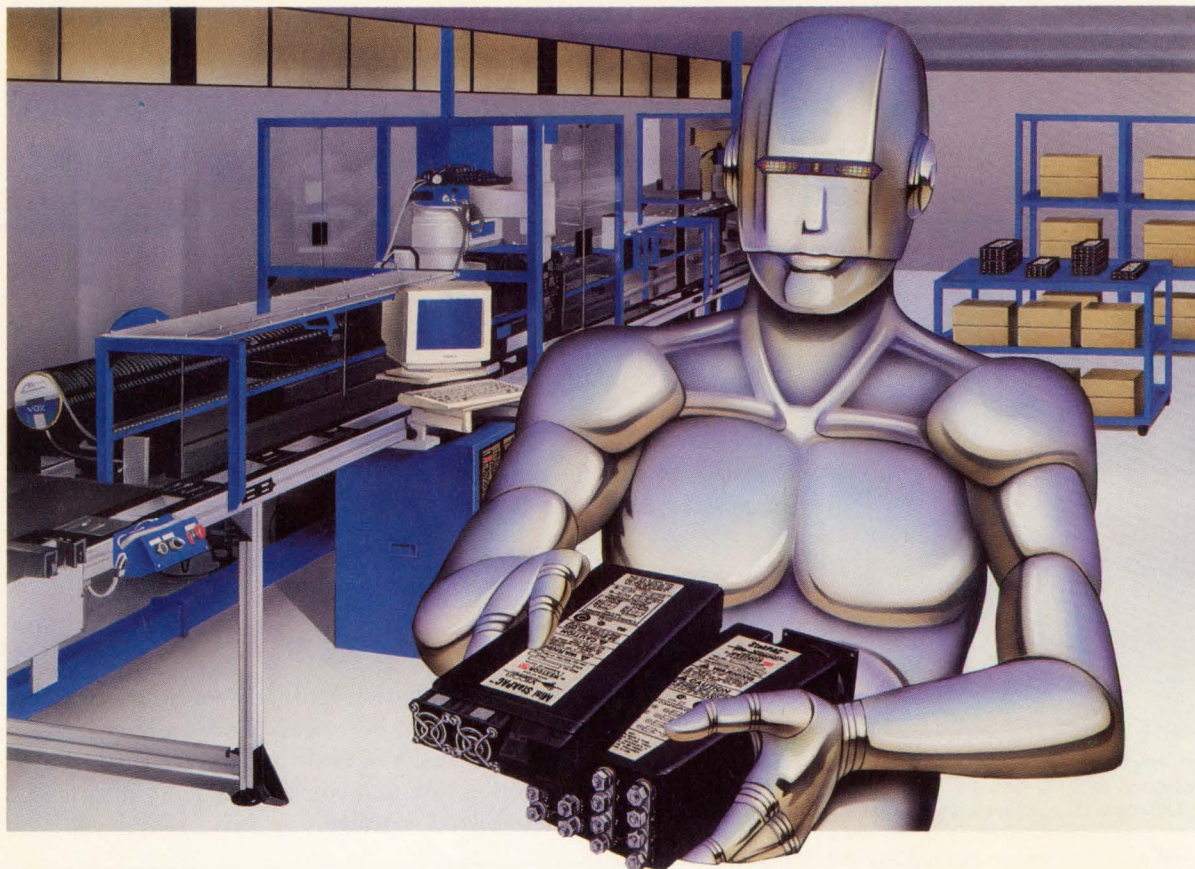

ROBOPOWER

STAKPAC™		MINI STAKPAC™
1200 Watts	Power	600 Watts
110/220 VAC	Input	110/220 VAC
Up to 8	Outputs	Up to 5
3.2"x5.5"x11.5	Dimensions	1.9"x5.5"x12"
Fan-Cooled	Cooling	Twin Fans

Each StakPAC output is factory configured utilizing Vicor's robotically manufactured power converters...VI-200 series modules. Consider the advantages of a StakPAC customized for your system needs with automatized power modules:

USER DEFINABLE OUTPUTS—The use of proven standard catalog modules offers the features of a custom without the associated risk or investment.

STANDARD MODELS—Many preconfigured standards available.

QUICK DELIVERY—Typical delivery 1 week or less for custom or standard evaluation units.

COMPACTNESS—Low profile packages provide up to 6 watts/cubic inch, twice the industry norm.

UL, CSA, TUV SAFETY AGENCY APPROVAL—All StakPAC configurations are approved, standard or custom.

EMI—FCC/VDE Level A, conducted.

StakPACs are designed and built by Westcor Corporation, Los Gatos, CA, a Vicor subsidiary. StakPACs are sold world-wide through Vicor Corporation, Andover, MA.

STAKPAC STANDARDS 1200 WATT MODELS

Model	Output Voltage (VDC) and Maximum Current (amperes) per Channel				
	#1	#2	#3	#4	#5
Single Output					
SP1-1801	2 @ 240	Total output power may not exceed 1200* watts for any model, single or multiple output. Lower power StakPAC models and many other configurations are available.			
SP1-1802	5 @ 240	*Standard models supply 1100 watts; high-powered version 1200 watts. Please contact the factory.			
SP1-1603	12 @ 100				
SP1-1604	15 @ 80				
SP1-1605	24 @ 50				
SP1-1606	28 @ 42				
SP1-1607	48 @ 25				
Dual Output					
SP2-1801	2 @ 120	5 @ 120			
SP2-1802	5 @ 120	5 @ 120			
SP2-1803	5 @ 120	12 @ 66			
SP2-1804	12 @ 66	12 @ 66			
SP2-1805	15 @ 53	15 @ 53			
Triple Output					
SP3-1801	5 @ 180	12 @ 16	12 @ 16		
SP3-1802	5 @ 150	12 @ 33	12 @ 16		
SP3-1803	5 @ 180	15 @ 13	15 @ 13		
SP3-1804	5 @ 150	15 @ 26	15 @ 13		
Quad Output					
SP4-1801	5 @ 150	12 @ 16	12 @ 16	5 @ 30	
SP4-1802	5 @ 150	15 @ 13	15 @ 13	5 @ 30	
SP4-1803	5 @ 150	12 @ 16	12 @ 16	24 @ 8	
SP4-1804	5 @ 150	15 @ 13	15 @ 13	24 @ 8	
Five Output					
SP5-1801	5 @ 120	12 @ 16	12 @ 16	5 @ 30	24 @ 8
SP5-1802	5 @ 120	15 @ 13	15 @ 13	5 @ 30	24 @ 8
Seven Output					
SP7-1801	5 @ 60	12 @ 16	12 @ 16	24 @ 8	24 @ 8
	#6	#7			
	5.2 @ 28	2 @ 30			

MINI STAKPAC STANDARDS 600 WATT MODELS

Model	Output Voltage (VDC) and Maximum Current (amperes) per Channel				
	#1	#2	#3	#4	#5
Single Output					
ST1-1401	2 @ 120	Total output power may not exceed 600 watts for any model, single or multiple output. Lower power Mini StakPAC models and many other configurations are available. Please contact the factory.			
ST1-1402	5 @ 120				
ST1-1301	12 @ 50				
ST1-1302	15 @ 40				
ST1-1303	24 @ 25				
ST1-1304	28 @ 21				
ST1-1305	48 @ 13				
Dual Output					
ST2-1401	2 @ 60	5 @ 60			
ST2-1402	5 @ 60	5 @ 60			
ST2-1403	5 @ 60	12 @ 33			
ST2-1404	12 @ 33	12 @ 33			
ST2-1405	15 @ 26	15 @ 26			
Triple Output					
ST3-1401	5 @ 60	12 @ 16	12 @ 16		
ST3-1402	5 @ 60	15 @ 13	15 @ 13		
ST3-1501	5 @ 90	12 @ 8	12 @ 8		
Quad Output					
ST4-1401	5 @ 30	12 @ 16	12 @ 16	5 @ 30	
ST4-1402	5 @ 30	15 @ 13	15 @ 13	5 @ 30	
ST4-1403	5 @ 30	12 @ 16	12 @ 16	24 @ 8	
ST4-1501	5 @ 30	15 @ 13	15 @ 13	24 @ 8	
ST4-1502	5 @ 60	12 @ 16	12 @ 8	5 @ 15	
ST4-1503	5 @ 60	15 @ 13	15 @ 7	5 @ 15	
ST4-1504	5 @ 60	12 @ 16	12 @ 8	24 @ 4	
ST4-1505	5 @ 60	15 @ 13	15 @ 7	24 @ 4	
Five Output					
ST5-1501	5 @ 30	12 @ 16	12 @ 16	5 @ 15	24 @ 4
ST5-1502	5 @ 30	15 @ 13	15 @ 13	5 @ 15	24 @ 4

For ordering information call Vicor Express at 1-800-735-6200 or (508) 470-2900 at ext. 265.

For technical information contact Westcor at (408) 395-7050 or FAX (408) 395-1518 or call Vicor.



WESTCOR CORPORATION
485-100 Alberto Way
Los Gatos, CA 95032

VICOR CORPORATION
23 Frontage Road
Andover, MA 01810

Common Stock Traded on
NASDAQ under "VICR"

VP/Publisher
Peter D Coley

Associate Publisher
Mark Holdreith

VP/Editor/Editorial Director
Jonathan Titus

Managing Editor
Joan Morrow Lynch

Special Projects
Gary Legg

Home Office Editorial Staff
275 Washington St, Newton, MA 02158
(617) 964-3030

Tom Ormond, *Senior Editor*
Charles Small, *Senior Editor*
Jay Fraser, *Associate Editor*
John A Gallant, *Associate Editor*
Michael C Markowitz, *Associate Editor*
Dave Pryce, *Associate Editor*
Carl Quesnel, *Associate Editor*
Susan Rose, *Associate Editor*
Julie Anne Schofield, *Associate Editor*
Dan Strassberg, *Associate Editor*
Chris Terry, *Associate Editor*
Helen McElwee, *Senior Copy Editor*
James P Leonard, *Copy Editor*
Christine McElvenny, *Senior Production Editor*
Gabriella A Fodor, *Production Editor*
Brian J Tobey, *Production Editor*

Editorial Field Offices

Steven H Leibson, *Senior Regional Editor*
Boulder, CO: (303) 494-2233

Doug Conner, *Regional Editor*
Atascadero, CA: (805) 461-9669

J D Mosley, *Regional Editor*
Arlington, TX: (817) 465-4961

Richard A Quinell, *Regional Editor*
Aptos, CA: (408) 685-8028

Anne Watson Swager, *Regional Editor*
Wynnewood, PA: (215) 645-0544

Maury Wright, *Regional Editor*
San Diego, CA: (619) 748-6785

Brian Kerridge, *European Editor*
(508) 28435
22 Mill Rd, Loddon
Norwich, NR14 6DR, UK

Contributing Editors
Robert Pease, Don Powers,
David Shear, Bill Travis

Editorial Coordinator
Kathy Leonard

Editorial Services
Helen Benedict

Art Staff
Ken Racicot, *Senior Art Director*
Chinsoo Chung, *Associate Art Director*
Cathy Madigan, *Staff Artist*
Sharon O'Brien, *Staff Artist*

Production/Manufacturing Staff
Andrew A Jantz, *Production Supervisor*
Sandy Wucinich, *Production Manager*
Kelly Brashears, *Production Assistant*
Melissa Carman, *Production Assistant*
Diane Malone, *Composition*

Director of Art Department
Robert L Fernandez
Norman Graf, *Associate*

VP/Production/Manufacturing
Wayne Hulitzky

Director of Production/Manufacturing
John R Sanders

Business Director
Deborah Virtue

Marketing Communications
Anne Foley, *Promotion Manager*
Pam Winch, *Promotion Assistant*

Timing-diagram design tools: Front-end tools reduce schematic drudgery 59

You can't draw a schematic until you find which timing requirements are critical. A new breed of computer tools takes the pain (and the pencil) out of this task.—Chris Terry, Associate Editor

EDITORS' CHOICE

32-bit μ P chip for embedded computers 67

PRODUCT UPDATE

BiCMOS 20-copy clock-driver IC 68

DESIGN IDEAS

Buffers stabilize oscillator 105
Current loop controls SCRs 106
Regulator measures battery voltage 108
Programmable source operates precisely 108
Clamps provide self-test 112
Feedback and amplification 112

NEW PRODUCTS

Integrated Circuits 115
Test & Measurement Instruments 119
CAE & Software Development Tools 125
Components & Power Supplies 127
Computers & Peripherals 133

DEPARTMENTS

News Breaks 15
Signals & Noise 23
Editorial 29
Literature 139
Career Opportunities 148
Business/Corporate Staff 155
EDN's International Advertisers Index 157

Cahners Publishing Company, A Division of Reed Publishing USA Specialized Business Magazines for Building & Construction Research Technology Electronics Computing Printing Publishing Health Care Foodservice Packaging Environmental Engineering Manufacturing Entertainment Home Furnishings and Interior Design. Specialized Consumer Magazines for Child Care Boating and Wedding Planning.

A chip carrier socket that won't play "pop goes the circuit."

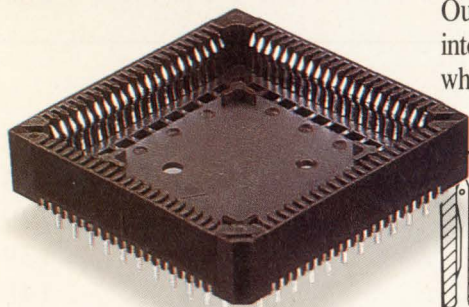

Our sockets are designed to get solidly into contact and stay in contact. No matter what the outside influences. Pop-out is simply not a problem.

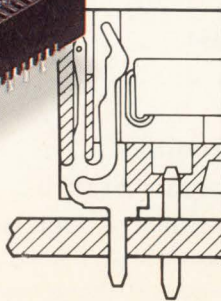

Controlled contact interface angle in AMP HPT sockets ensures positive chip carrier retention. Our exclusive removable housing allows direct inspection of solder joints, and fast repair/replacement of contacts.

The contacts are High Pressure Tin, an AMP proprietary design which creates very high normal forces—a minimum of 200 grams per contact—for maximum retention and reliable interconnection. Short-signal-path contacts float in the housing to accommodate thermal expansion.

Two basic styles of sockets are available: square or 32-position rectangular EPROM and SO-J. Both come in solder

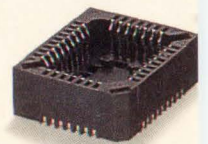



tail or surface mount versions and feature all the important details. Tin-over-nickel plating is applied after the contacts are formed, to assure full plating. We've built in visual indicators for locating pin 1, and polarizing to aid correct insertion.

Orientation holes in the 94V-0 housing floor make registration to the

pc board both fast and simple, ideal for hand or tube-loaded robotic insertion. And the high pin counts make very effective use of real estate.

Call the AMP Information Center at 1-800-522-6752 for literature on HPT PLCC Sockets. AMP Incorporated, Harrisburg, PA 17105-3608.

AMP Interconnecting ideas



Seven socket sizes are available, with carrier extraction tools provided for each size.

**Power
tool**



Power tools

KEPCO TEST/BENCHTOP POWER SUPPLIES

The correct tool makes any job easier. Kepco's Power Supplies for workbench, for burn-in, and float-charging batteries are just some of the tools at your disposal.

For your workbench choose a multi-out array that you configure for the application by plugging-in modules with adjustable outputs. You can combine one, two or three modules in convenient bench-top housings or put six of them together in a rack. Other experimentalist power includes a nice selection of 100W single output instruments (MSK), a triple output logic-analog model (MPS), and burn-in/float chargers (TBC) that range from 300 to 3000 Watts in all the popular voltages.

Custom power assemblies allow you to create your own toolkit with just the selection of voltage and power to fit your need.

Other power tools from Kepco include: *ac power* to 18KVA, precision *programmable dc* for test applications, *high voltage* models and four-quadrant *bipolar power*. For these, and our broad selection of *switching power* models, including *d-c to d-c converters*, please ask for one of the three catalogs illustrated below.

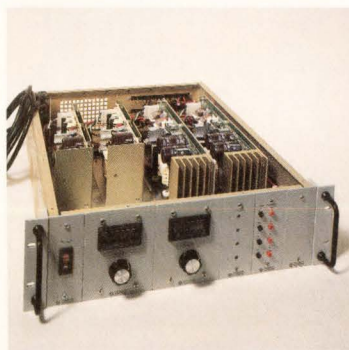
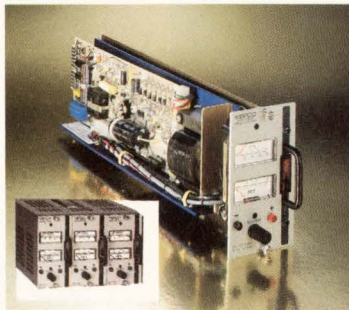
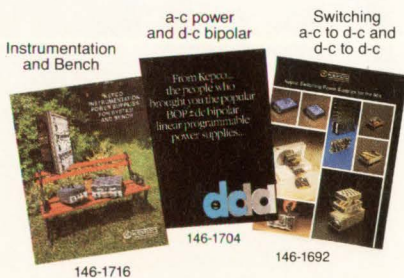

Plug-in power

- 20 Watt modules, either voltage stabilizers (series PCX-MAT) or current stabilizers (series CC).
- Sized to plug-in six abreast in a 19" rack or in bench-top housings for 1, 2 or 3 units.
- Mix or match.
- Select from six voltage ranges up to 100V.

Kepco Group PCX-MAT and CC Power Supplies

100 Watts of precision benchtop power.

- LCD meters to set the level accurately, a preview feature to check your setting before applying power to your load.
- Linear design for low-noise high stability.
- Ten-turn controls for good resolution.
- Five models offer outputs up to 125 Volts.

Kepco Group MSK Power Supplies

A triple output design for maximum convenience.

- 0-6V at 5A for logic and a tracked \pm 0-20V, 1A for analog.
- Each output current limited, the 0-6V output has an overvoltage protector.

Kepco Group MPS Power Supply

Battery/float-chargers.

- For telecommunications: maintain 12V, 24V and 48V batteries, built-in equalize timer.
- For burn-in: power up to 3000 Watts, current limited, over-voltage protected. Two output settings, remotely selectable for margining.

Kepco Group TBC Float Chargers/Power Supplies

Kepco Custom System Power Assemblies

We will stuff a 19" rack (5 1/4 or 7") full of switchers to your requirement. With modules from 3 Watts to 3000 Watts, in a wide selection of voltage ranges, we can accommodate most needs.

- LCD output meters.
 - Test points.
 - Pilots, trimmers, circuit breakers.
- Convenient 1/8 rack panel format allows multiple control and monitoring.

Kepco Power Assemblies.

SEE OUR PAGES IN VOLUME D

eem⁹¹

Call/fax/write Dept. LXT-12, Kepco, Inc., 131-38 Sanford Avenue, Flushing, NY 11352 USA
(718) 461-7000 • Fax (718) 767-1102 • Easylink (TWX) • 710-582-2631

KEPCO[®]
THE POWER SUPPLIER™

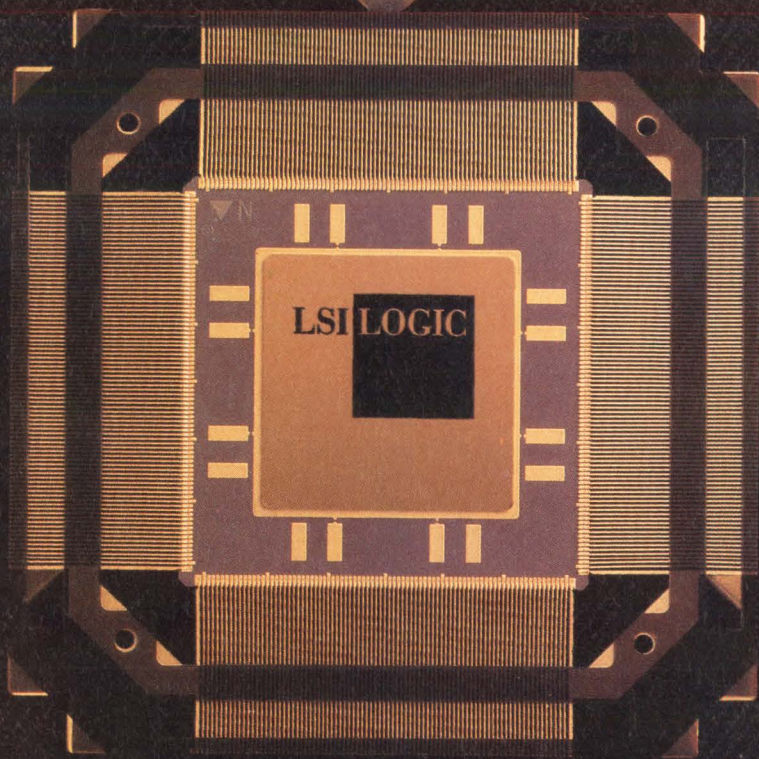

WE'RE STILL ON ACTIVE DUTY.

While many companies have deserted the military ASIC business, our commitment hasn't changed.

So if you're looking for a long term strategic partner, stand at ease.

LSI Logic has earned its stripes by successfully completing more military gate array designs than all other ASIC manufacturers combined. Led by a dedicated Military Aerospace group, we're ready when you are to make those designs a production reality.

At your command are submicron HCMOS ASICs, RISC microprocessors and DSP products which allow system-scale integration second to none.

Our commitment continues as we ready the Silicon 1076, a VHDL system development environment capable of

taking you from the highest levels of abstraction right through to actual silicon. Our military arsenal already consists of design software which ensures a first-time hit rate, dedicated manufacturing, radiation hardened processes and package development. Whether your program need is for one design or 30, we've got the capability to hit your milestone targets.

Next time you're looking for a technology upgrade, or need fast time-to-market, enlist the world's leader in military ASICs and RISC microprocessors. LSI Logic.

Call us at 1-800-451-2742, or write LSI Logic, 1551 McCarthy Blvd., MS D102, Milpitas, CA 95035.

We'll be there. Because we're always on active duty.



ACROSS THE BOARD

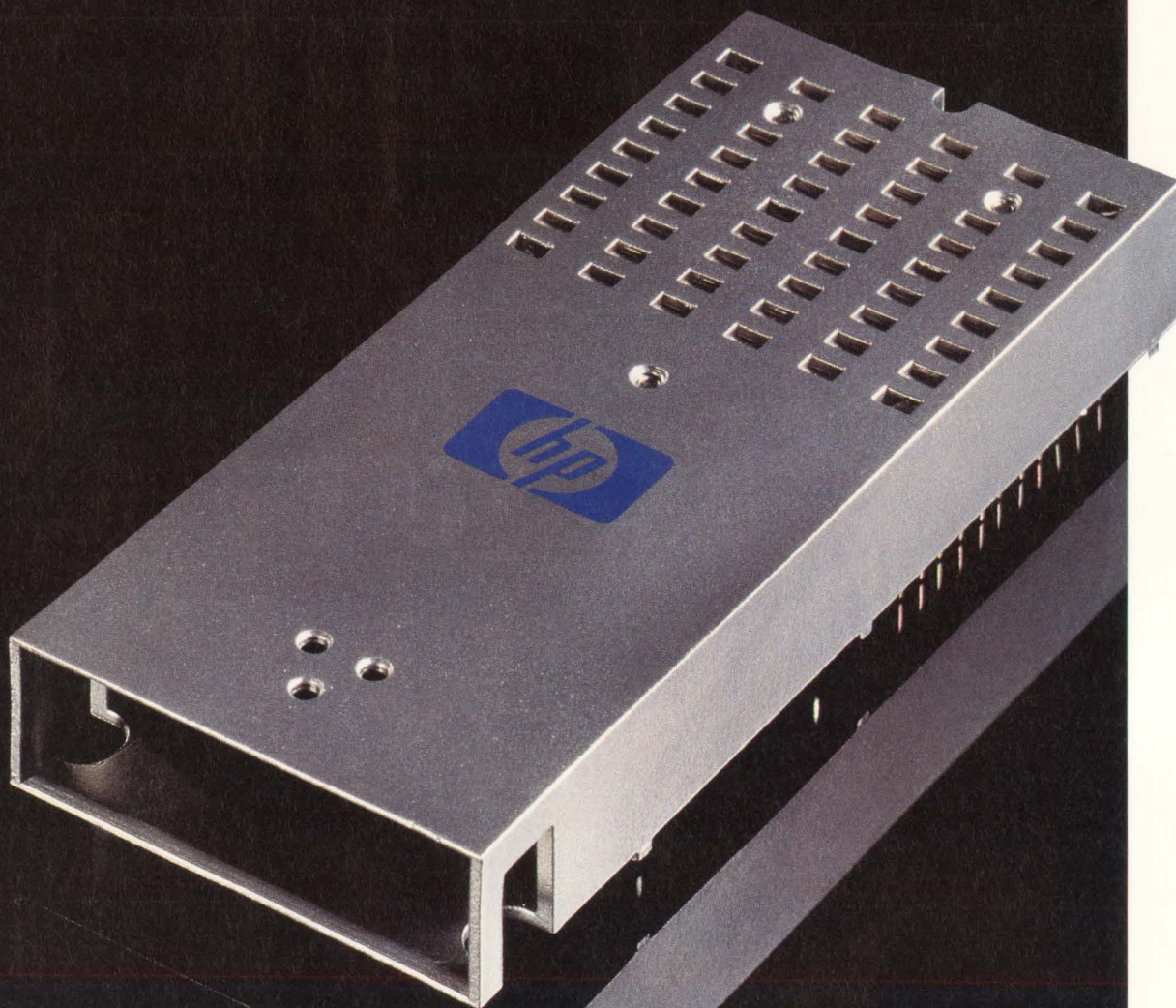

Finally, FDDI worthy of the name.

It's one thing to set the standard for an entire industry, as HP helped to do with FDDI. But it's quite another to follow it up with products that set the standard for performance and quality. Of course, that's just the HP way.

Case in point, our new integrated FDDI transceiver with integral MIC receptacle makes the most of its HP heritage. Engineered to meet and beat FDDI standards, this single-piece solution provides consistent performance over a wide range of operating temperatures and voltages. The bottom line is a 14.5dB power budget that exceeds the 11dB

FDDI PMD standard, resulting in a comfortable 3.5dB design margin.

Attributes that stem directly from HP's role as a vertically integrated supplier. Which means we have direct control over all the active elements of our FDDI designs, ensuring you a consistently high quality product – and a constant high volume supply.

What's more, our new FDDI transceiver is just one part of a growing family of 1300nm products. Like our individual transmitter/receiver pair – for FDDI and general-purpose applications – that offer data

speeds up to 200MBd. With more new and innovative products on the way.

So, if you're in the process of building a name in fiber optic networks, remember this – there's only one supplier of FDDI products worthy of the HP name. For more information, call HP today at **1-800-752-0900, ext. 1960**. We'll make it worthy of your time.

There is a better way.

 **HEWLETT
PACKARD**

NEWS BREAKS

EDITED BY SUSAN ROSE

COMPANY BREATHES NEW LIFE INTO SILICON CARBIDE

Cree Research has developed proprietary processes for large-diameter, low-defect-density silicon carbide (SiC) wafers. SiC has four basic material properties: wide energy bandgap, high-breakdown electric field, high thermal conductivity, and high saturated-electron-drift velocity. The wide bandgap lets the material emit high-energy wavelength light—blue light—when fabricated into a light-emitting-diode. LED dice cost \$0.96 (quantity) and final-packaged blue LEDs cost \$1 to \$2.

The company will also use the SiC wafers to make high-power, high-temperature, radiation-resistant microwave devices, such as its already tested SiC MOSFET that can withstand temperatures of 650°C, and devices with more complex circuitry than LEDs. Cree Research Inc, Durham, NC, (919) 361-5709, FAX (919) 361-4630.

—Anne Watson Swager

CAHNERS 1991 ECONOMIC FORECAST AVAILABLE TO READERS

Every year, Cahners Economics, the research and forecasting group at Cahners Publishing, compiles a list of trends and predictions for the coming year. The *Cahners 1991 Economic Outlook* reviews the economy in general, demographics, financial markets, and international markets. In addition, it has analyses of industries covered by Cahners publications, including electronics (semiconductors and components, computers and telecommunications, instruments and controls, military, and consumer). For EDN readers, the 57-pg book costs \$11 (list price is \$75). Cahners Economics, attn: Wendy Chambers, 275 Washington St, Newton, MA, (617) 630-2124, FAX (617) 630-2100.—Susan Rose

CMOS μ P INCREASES SPEED

Zilog's Z280 16-bit μ P now comes in a 12.5-MHz version that is 25% faster than the company's 10-MHz version. The μ P has a 3-stage pipelined architecture, and an optional 8- or 16-bit data bus; it is code compatible with the company's 8-bit Z80 CPU. The μ P's on-chip memory-management unit can address 16M bytes of memory and a 256-byte instruction and data cache. Other on-chip functions include three 16-bit counter/timers and a full-duplex UART. The \$28 (1000) μ P comes in a 68-pin plastic leaded chip carrier. Zilog, Campbell, CA, (408) 370-8000, FAX (408) 370-8056.—Dave Pryce

FUTUREBUS + CHIPSET COMPLIES WITH IEEE STANDARDS

National Semiconductor Corp recently announced a Futurebus+ chip set that complies with the IEEE P896.1 and P896.2 specifications. The set consists of five ICs that use the company's backplane transceiver logic (BTL). The devices come in either plastic quad flatpacks or plastic leaded chip carriers. (Prices listed are for the flatpacks.)

The \$7.70 (100) bipolar DS3883 is a 9-bit data transceiver that transmits and receives address, data, parity, command, and status signals. A 64-bit system requires 10 of these ICs. The IC has filters that eliminate glitches due to wire-ORed connections. The \$28.75 (100) CMOS DS3875 arbitration controller supports the Futurebus+ distributed protocol and message passing in the central arbitration scheme. The

NEWS BREAKS

\$13.90 (100) BiCMOS DS3885 is a 9-bit arbitration transceiver that communicates with the bus and the arbitration controller. The transceiver implements the arbitration-competition logic and performs parity checks. The \$9.90 (100) BiCMOS DS3886 is a 9-bit latched-data transceiver, and the \$13.90 (100) BiCMOS DS3884 is a handshake transceiver. National Semiconductor Corp, Santa Clara, CA, (408) 721-5000, FAX (408) 749-9071.—John Gallant

QUADRUPLE CMOS COMM DEVICE SAVES BOARD SPACE

VLSI Technology Inc's VL16C554 combines the abilities of four ICs in a single chip. The chip has four VL16C550 UARTs, each with its own 16-byte data FIFO circuit, and suits applications that involve intensive data communication in PCs, terminal cluster controllers, or statistical multiplexers. The chip's four CMOS asynchronous communications elements act as serial data I/O interfaces that perform serial-to-parallel conversion on data characters received from peripheral devices, such as modems. The VL16C554 comes in an 84-lead plastic leaded chip carrier and costs \$63 (1) or \$32 (1000). VLSI Technology Inc, Tempe, AZ, (602) 752-8574, FAX (602) 752-6000.—J D Mosley

WINDOWS-BASED DSP DEVELOPMENT SOFTWARE SUPPORTS OOP

Signal Technology Inc's N!Power 1.0 is an object-oriented Windows-based development framework for digital-signal-processing applications. It lets you prototype your application rapidly because it treats individual data files and software modules as objects. You string together the data, algorithms, and hardware control functions drawn from both the framework library and third-party software using a Lisp-based symbolic language to define the procedures. The framework runs on a Sun SPARC or VAX workstation and costs \$6000. The framework package supplies the X-Window interface, an object-oriented high-level application language, 2- and 3-D graphics capability, and a library of signal- and data-analysis functions. You can add modules to the framework, including a library of DSP algorithms, DSP-chip code generators, and control for selected A/D and D/A devices. You can also acquire a module that lets you add third-party software to the framework. Modules cost from \$250 to \$3750. Signal Technology Inc, Goleta, CA, (805) 968-3000, FAX (805) 968-2620.

—Richard A Quinnell

MEMORY-CELL STRUCTURE LIMITS LEAKAGE IN DRAMs

Toshiba America Electronic Components is researching a memory cell that provides 0.6 μm of separation between the crucial regions of trench cells in dynamic RAMs (DRAMs), even with 0.4- μm design rules. The company is developing the cell because conventional methods of building trench cells for DRAMs won't scale to 64M-bit densities. Because of their proximity to each other, leakage between adjacent trench cells, and from active areas to the storage capacitors within cells, results when IC geometries shrink. The memory cell uses a thin insulating layer of oxide on the surface of each trench capacitor to prevent leakage. In addition, the memory cell uses an asymmetric and offset trench, rather than the parallel alignment of conventional trenches. Toshiba America Electronic Components, Irvine, CA, (714) 455-2000, FAX (714) 859-3963.—Michael C Markowitz

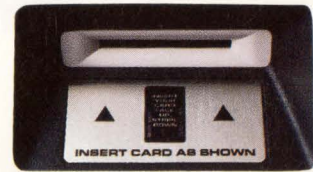
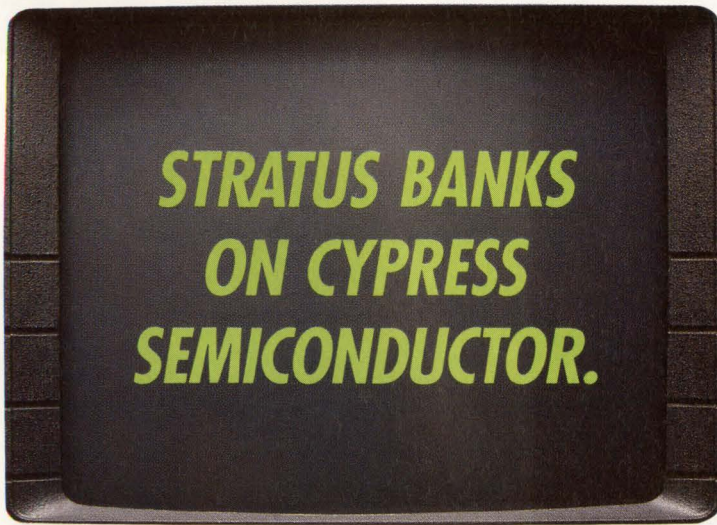

Customers don't tolerate ATMs that are down, which is why many ATM networks rely on fault-tolerant computers. Stratus Computer's systems deliver the utmost reliability in a wide range of critical, on line applications. Since their success is based on quality, Stratus demands the highest quality from its vendors. In their words, they look for the "best in the business." Their vendor relationships are so strong that often Stratus can eliminate incoming component inspection. We are proud to have earned a Vendor Excellence Award from this excellent manufacturer.

Thanks, Stratus.



CYPRESS
SEMICONDUCTOR

For a free Cypress Corporate Profile call 1-800-952-6300 and ask for Dept.C4I

©1990 Cypress Semiconductor, 3901 North First Street, San Jose, CA 95134 Phone: (408) 943-2600, Telex: 821032 CYPRESS SNJ UD, TWX: 910-997-0753.

FILTERS



dc to 3GHz from \$11.45

lowpass, highpass, bandpass, narrowband IF

- less than 1dB insertion loss • greater than 40dB stopband rejection
- 5-section, 30dB/octave rolloff • VSWR less than 1.7 (typ) • meets MIL-STD-202 tests
- rugged hermetically-sealed pin models • BNC, Type N; SMA available
- surface-mount • over 100 off-the-shelf models • immediate delivery

low pass dc to 1200MHz

MODEL NO.	PASSBAND, MHz (loss <1dB)		fco, MHz (loss 3db)	STOP BAND, MHz (loss >20dB) (loss >40dB)		VSWR pass-band typ.	stop-band typ.	PRICE \$ Qty. (1-9)	
	Min.	Max.		Min.	Max.				
PLP-10.7	DC-11		14	19	24	200	1.7	18	11.45
PLP-21.4	DC-22		24.5	32	41	200	1.7	18	11.45
PLP-30	DC-32		35	47	61	200	1.7	18	11.45
PLP-50	DC-48		55	70	90	200	1.7	18	11.45
PLP-70	DC-60		67	90	117	300	1.7	18	11.45
PLP-100	DC-98		108	146	189	400	1.7	18	11.45
PLP-150	DC-140		155	210	300	600	1.7	18	11.45
PLP-200	DC-190		210	290	390	800	1.7	18	11.45
PLP-250	DC-225		250	320	400	1200	1.7	18	11.45
PLP-300	DC-270		297	410	550	1200	1.7	18	11.45
PLP-450	DC-400		440	580	750	1800	1.7	18	11.45
PLP-550	DC-520		570	750	920	2000	1.7	18	11.45
PLP-600	DC-580		640	840	1120	2000	1.7	18	11.45
PLP-750	DC-700		770	1000	1300	2000	1.7	18	11.45
PLP-800	DC-720		800	1080	1400	2000	1.7	18	11.45
PLP-850	DC-780		850	1100	1400	2000	1.7	18	11.45
PLP-1000	DC-900		990	1340	1750	2000	1.7	18	11.45
PLP-1200	DC-1000		1200	1620	2100	2500	1.7	18	11.45

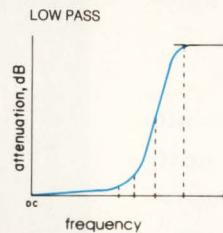

high pass dc to 2500MHz

MODEL NO.	PASSBAND, MHz (loss <1dB)		fco, MHz (loss 3db)	STOP BAND, MHz (loss >20dB) (loss >40dB)		VSWR pass-band typ.	stop-band typ.	PRICE \$ Qty. (1-9)
	Min.	Max.		Min.	Max.			
PHP-50	41	200	37	26	20	1.5	17	14.95
PHP-100	90	400	82	55	40	1.5	17	14.95
PHP-150	133	600	120	95	70	1.8	17	14.95
PHP-175	160	800	140	105	70	1.5	17	14.95
PHP-200	185	800	164	116	90	1.6	17	14.95
PHP-250	225	1200	205	150	100	1.3	17	14.95
PHP-300	290	1200	245	190	145	1.7	17	14.95
PHP-400	395	1600	360	290	210	1.7	17	14.95
PHP-500	500	1600	454	365	280	1.9	17	14.95
PHP-600	600	1600	545	440	350	2.0	17	14.95
PHP-700	700	1800	640	520	400	1.6	17	14.95
PHP-800	780	2000	710	570	445	2.1	17	14.95
PHP-900	910	2100	820	660	520	1.8	17	14.95
PHP-1000	1000	2200	900	720	550	1.9	17	14.95

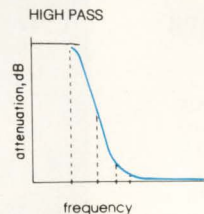

bandpass 20 to 70MHz

MODEL NO.	CENTER FREQ. MHz F0	PASS BAND, MHz (loss <1dB)		STOP BAND, MHz (loss > 10 dB)		STOP BAND, MHz (loss > 20 dB)		VSWR 1.3:1 typ. total band MHz	PRICE \$ Qty. (1-9)
		Max. F1	Min. F2	Min. F3	Max. F4	Min. F5	Max. F6		
PIF-21.4	21.4	18	25	4.9	85	1.3	150	DC-220	14.95
PIF-30	30	25	35	7	120	1.9	210	DC-330	14.95
PIF-40	42	35	49	10	168	2.6	300	DC-400	14.95
PIF-50	50	41	58	11.5	200	3.1	350	DC-440	14.95
PIF-60	60	50	70	14	240	3.8	400	DC-500	14.95
PIF-70	70	58	82	16	280	4.4	490	DC-550	14.95

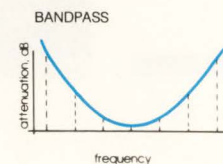

narrowband IF

MODEL NO.	CENTER FREQ. MHz F0	PASS BAND, MHz I.L. 1.5dB max. F1-F2	STOP BAND, MHz I.L. > 20dB		STOP BAND, MHz I.L. > 35dB		PASS-BAND VSWR Max.	PRICE \$ Qty. (1-9)
			F5	F6	F7	F8-F9		
PBP-10.7	10.7	9.5-11.5	7.5	15	0.6	50-1000	1.7	18.95
PBP-21.4	21.4	19.2-23.6	15.5	29	3.0	80-1000	1.7	18.95
PBP-30	30.0	27.0-33.0	22	40	3.2	99-1000	1.7	18.95
PBP-60	60.0	55.0-67.0	44	79	4.6	190-1000	1.7	18.95
PBP-70	70.0	63.0-77.0	51	94	6	193-1000	1.7	18.95

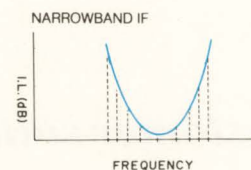

CIRCLE NO. 108

Mini-Circuits

P.O. BOX 350166, Brooklyn, New York 11235-0003 (718) 934-4500 FAX (718) 332-4661 TELEX 6852844 or 620156 WE ACCEPT AMERICAN EXPRESS

F132-2 REV. ORIG.

Boxed In by Proprietary

Break Out with Oki

If you're trapped trying to design ASICs with vendor-specific tools, it's time to make a break — for Oki.

Because at Oki, we take a "customer-friendly" approach to ASIC design by supporting the range of industry-standard tools you're used to working with.

Verilog, for example, is our in-house simulator, providing high-quality customer-to-Oki and Oki-to-customer design interface. So you enjoy shorter design and verification cycles and the assurance that your design will work.

Is your ASIC design platform workstation- or PC-based? No matter. With Oki, you get across-the-board hardware, software, and operating system support for DAZIX, Mentor, Valid, Viewlogic, and others.

Just choose the environment you're familiar with, and start designing. There's no relearning effort required.

If you're ready to escape the limitations of vendor-favored tools, Oki is ready to set you free — with complete design support: 24-hour, fully-equipped, state-of-the-art design centers. Customer-compatible tools. A true 0.8 μ m drawn family of SOGs for next-generation products. Industry-standard JEDEC metric packages. Data books, design guides, and more.

Make a break for the design freedom you've been longing for. Call **1-800-OKI-6994**.

Apollo, Cadence, DAZIX, DEC, Digital, DNIX, DOMAIN, GED, HP, IDEA, LOGICIAN, Mentor Graphics, PC-DOS, RapidSIM, Sun, Sun OS, Synopsys, ULTRIX, Valid, ValidSIM, Verilog, Viewlogic, and Workview are trademarks of others.



Transforming technology into customer solutions.

ASIC Tools?



Oki ASIC Design Tool Support

Vendor	Platform	O.S. & Application	Design Kits
Cadence	Sun-4	Sun OS 4.0.1 Verilog 1.5C	SOG: 0.8 μ m
DAZIX	LOGICIAN Sun 386i Sun-4	DNIX 5.03, Sun OS 4.0.1 Digital Application 6.1 Digital Application 6.3	GA: 1.2 μ m SOG: 1.0 μ m, 0.8 μ m SC: 1.5 μ m, 1.2 μ m
Mentor Graphics	HP/Apollo DN3XXX DN4XXX	DOMAIN/OS 10.1 IDEA Series 7.0	GA: 1.2 μ m SOG: 1.0 μ m, 0.8 μ m SC: 1.5 μ m, 1.2 μ m
Synopsys	Sun-4	Sun OS 4.03 *Interface to Mentor, Valid, Viewlogic	SOG: 1.0 μ m, 0.8 μ m
Valid	Sun-4 Sun-3	Sun OS 4.0.1 GED, ValidSIM, RapidSIM	GA: 1.2 μ m SOG: 1.0 μ m, 0.8 μ m SC: 1.5 μ m, 1.2 μ m
	DEC Station 3100	ULTRIX ValidSIM GED	GA: 1.2 μ m SOG: 1.0 μ m, 0.8 μ m SC: 1.5 μ m, 1.2 μ m
Viewlogic	Sun-4	Sun OS 4.0.3 Workview 4.0	GA: 1.2 μ m SOG: 1.0 μ m, 0.8 μ m SC: 1.2 μ m
	PC386	DOS 3.3 Workview 4.0	GA: 1.2 μ m SOG: 1.0 μ m, 0.8 μ m SC: 1.2 μ m



OKI
Semiconductor

785 North Mary Avenue
Sunnyvale, CA 94086-2909

OrCAD presents Release IV

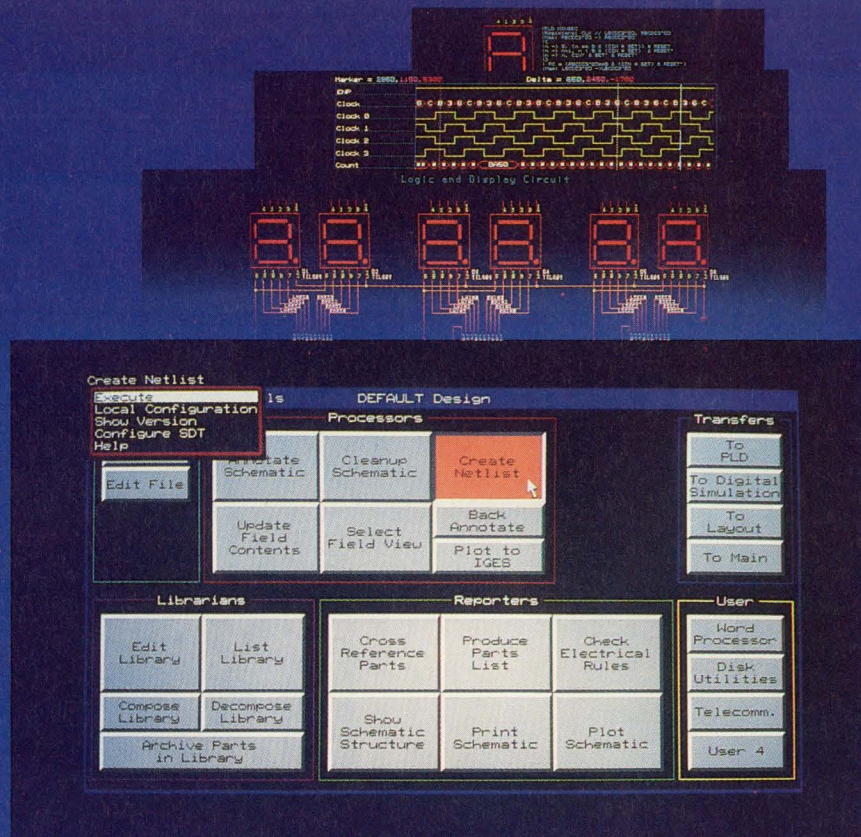

The limits are gone

OrCAD has introduced the greatest product upgrade in its history. Memory limits, design restrictions, even boundaries between products are all disappearing.

For years, OrCAD's competitors have been playing a game of catch-up. With the introduction of Release IV, the race is over. No one will match our price/performance ratio on these features:

- Schematic Parts Library has been increased to over 20,000 unique library parts
- Digital Simulation process has been speeded up by an order of magnitude
- Printed Circuit Board Layout package offers autoplacement and autorouting at no extra charge
- Expanded memory capabilities

Best of all, OrCAD introduces ESP

ESP is a graphical environment designed specifically for the electronic designer. Software tools appropriate for different stages in the design process are now linked together to form a seamless flow of information. This easy-to-use framework relieves the designer of time consuming tasks and the inconvenience of moving from one tool set to another. You can now spend more time productively designing.

For more information . . .

You need to know more about Release IV and all of the benefits OrCAD has to offer. Call the telephone number below and we'll send you a free demonstration disk.

OrCAD 

More designs from more designers

For more information, call (503) 690-9881

or write to OrCAD Sales Department, 3175 N.W. Alcock Drive, Hillsboro, Oregon, 97124

SIGNALS & NOISE

Reader notes competent reporting on neural networks

Maury Wright's article, "Neural networks tackle real-world problems" (EDN, November 8, 1990, pg 79), is the sort of in-depth reporting that should stimulate more designers to investigate the benefits of neural networks. Many companies are using this technology to reduce costs and improve quality.

Maury referred to our C25 accelerator board as having a price range of \$2500 to \$4150. The company now offers only the high-end zero-wait-state board at \$1995.

Mark Lawrence

President

*California Scientific Software
Grass Valley, CA*

Price of optical-disk drive

The price of the RMD-5100-S 3½-in. rewritable optical-disk drive from

Most Inc did not appear in the New Product write-up (EDN, December 20, 1990, pg 118) because it was not available when this issue went to press. The RMD-5100-S drive costs \$2450; the price of \$120 is for the cartridges only.

Phone-number correction

Two digits in the phone number for Xitron Technologies Corp (EDN, December 20, 1990, pg 149) were inadvertently transposed. The correct number is (619) 458-9852.

Software correction file available on EDN BBS

The correction file for the software in Fred Salvatti's article, MS152 (EDN, August 20, 1990, pg 141) is available on EDN's Bulletin Board Service (BBS), /freeware SIG, (617) 558-4241 (2400,8,N,1).

IT'S EASY TO HAVE YOUR SAY

EDN's Signals & Noise column provides a forum for readers to express their opinions on issues raised in the magazine's articles or on any topic that affects the engineering industry. You can use one of several easy ways to reach us. First, there's always the mail. Send your letters to Signals & Noise Editor, EDN Magazine, 275 Washington St, Newton, MA 02158. Or, send us a message via MCI mail at EDNBOS. Finally, EDN's bulletin-board system is ready for use—and it's free (except for the phone call). You can reach us at (617) 558-4241 and leave a letter in the EDITORS Special Interest Group. You'll need a 2400-bps or less modem and a communications program that is set for eight data bits, no parity, and one stop bit, or 2400, 8N1 in shorthand.

EDN

KRISTEL - CRT DISPLAY MONITORS

- Quality, High Resolution Data Displays
- Versatile, Custom Designs To Meet O.E.M. Specifications
- Horizontal Scanning Frequencies to 90 KHz
- Screen Sizes from 3 to 25 Inches
- U.S.A. Manufacturing Assures Responsive Service, Competitive Pricing

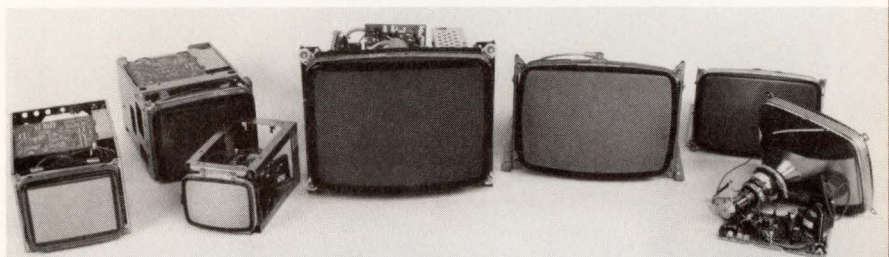

MONOCHROME AND COLOR

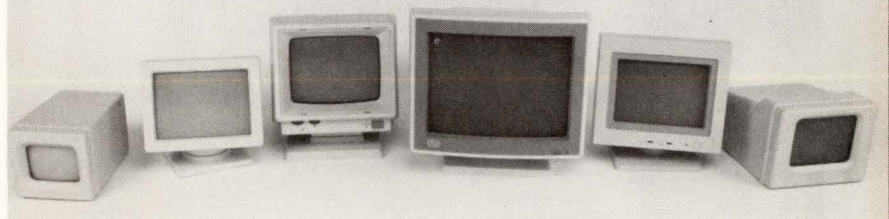

 **Kristel**[®] corporation

Call for complete information.

833 Industrial Drive, West Chicago, IL 60185
(708) 293-0850 • FAX (708) 293-1255

Outside, all disc drives look the same. It's really what's inside that counts.



Zone Bit Recording, ZBR, Seagate and the Seagate logo are registered trademarks of Seagate Technology, Inc.
© 1990 Seagate Technology, Inc.

he same. units.

Apart from our nameplate, a Seagate disc drive looks much like any other when viewed from the outside. But it's the tangible and intangible elements we put inside that make a Seagate drive really shine.

If you could see inside you'd find the best components available. Many of them—such

as discs, motors, semiconductors and thin-film heads—we design and build ourselves, allowing us to control their quality, cost and availability. Most of what we don't manufacture is obtained from a select group of vendors who must meet our strict Supplier Certification Program criteria. This guarantees consistently high quality and continual conformance to our customers' requirements.

Technology is another key Seagate ingredient. As the holder of over 200 disc drive patents, we constantly develop state-of-the-art technologies to enhance the value of our products to our customers. For example, Zone Bit Recording™ increases the amount of information that can be stored on a disc. But besides increasing the drive's capacity and throughput, ZBR™ technology can reduce the required number of heads and discs, thereby reducing costs, increasing performance and making the drive significantly more reliable.

The third major factor that sets Seagate drives apart is our commitment. You see it in the inspired dedication of our employees: like our engineers, who apply the latest technology advances to our current models. In our assemblers and technicians, who are committed to producing defect-free products. And in our sales, customer service and technical support groups, who continually go the extra mile to ensure complete customer satisfaction.

But most of all, Seagate drives are built upon experience: the market insight and technical knowhow that can only come from selling more than 25 million drives since the industry's inception. It's the kind of experience you won't find at any other disc drive company.

To be sure you're getting Seagate quality and technology inside where it counts, make sure there's a Seagate nameplate on the outside. For more information, contact Seagate at 800-468-DISC, or 408-438-6550.

H N O L O G Y



 **Seagate**

The first name in disc drives

THE WORLD'S LARGEST SELECTION OF **POWER SPLITTERS/ COMBINERS**

2 KHz to 8 GHz from **\$10⁴⁵**

With over 300 models, from 2-way to 48-way, 0°, 90° and 180°, a variety of pin and connector packages, 50 and 75 ohm, covering 2KHz to 8000MHz, Mini-Circuits offers the world's largest selection of off-the-shelf power splitter/combiners. So why compromise your systems design when you can select the power splitter/combiner that closely matches your specific package and frequency band requirements at lowest cost and with immediate delivery.

And we will handle your "special" needs, such as wider bandwidth, higher isolation, intermixed connectors, etc. courteously with rapid turnaround time.

Of course, all units come with our one-year guarantee.

For detailed specs and performance data, refer to the *MicroWaves Product Directory, EEM or Mini-Circuits RF/IF Signal Processing Handbook, Vol. II*. Or contact us for our free 68-page RF/IF Signal Processing Guide.

finding new ways ...
setting higher standards

Mini-Circuits

A Division of Scientific Components Corporation
P.O. Box 350166, Brooklyn, New York 11235-0003 (718) 934-4500
Fax (718) 332-4661 Domestic and International Telexes: 6852844 or 620156
WE ACCEPT AMERICAN EXPRESS

CIRCLE NO. 109

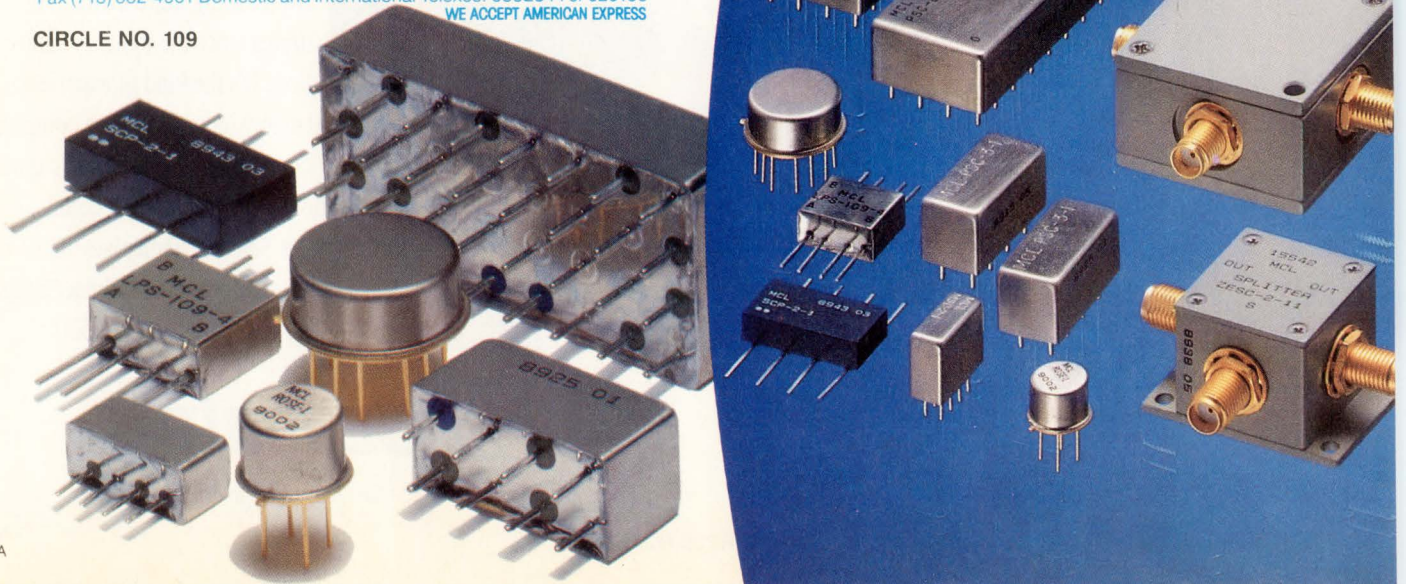

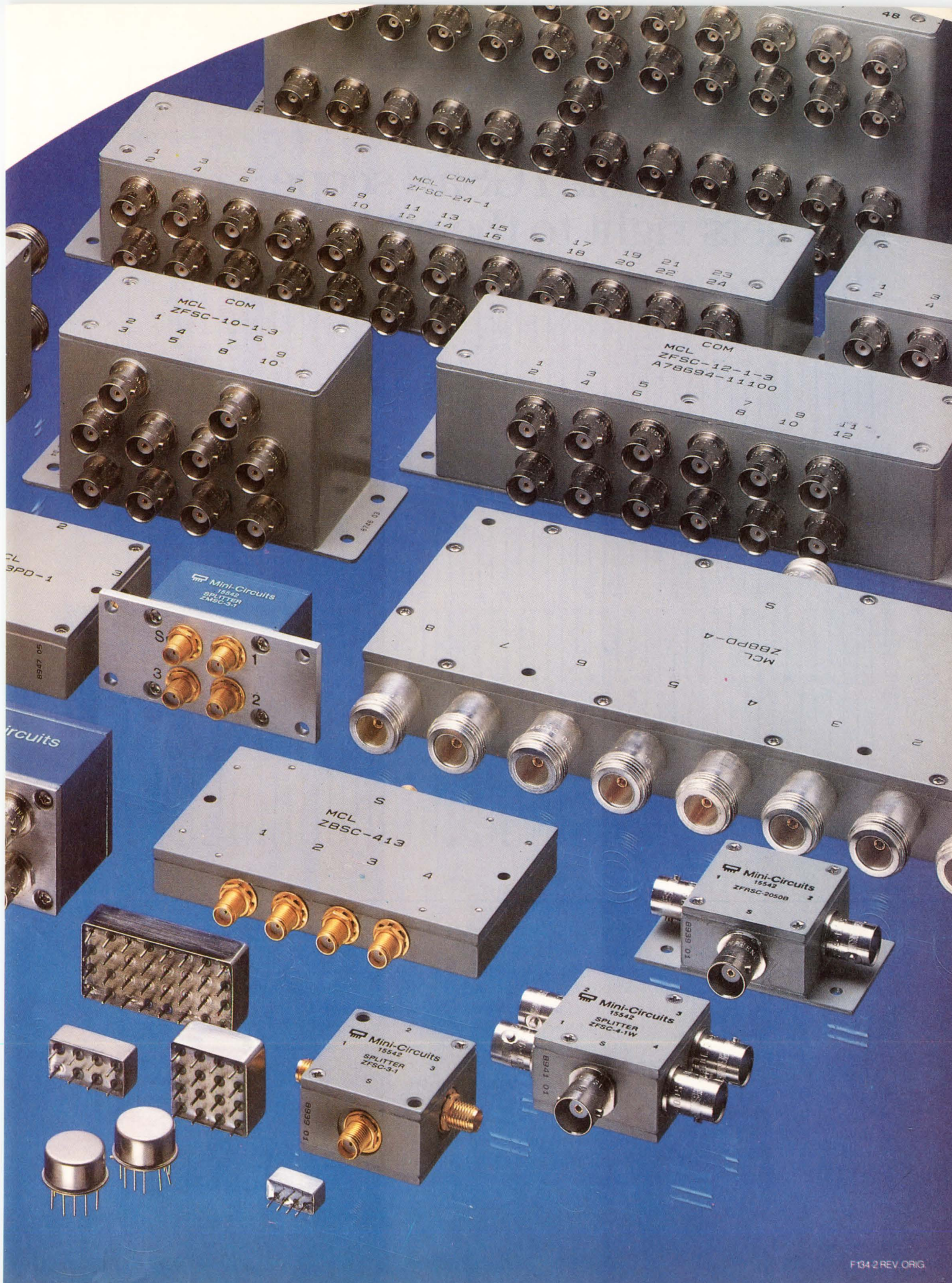

MCL COM
ZFSC-24-1

1 2 3 4 5 6 7 8 9 10 11 12 13 14 15 16 17 18 19 20 21 22 23 24

MCL COM
ZFSC-10-1-3

1 2 3 4 5 6 7 8 9 10

MCL COM
ZFSC-12-1-3
A78694-11100

1 2 3 4 5 6 7 8 9 10 11 12

MCL
ZB8PD-4

1 2 3 4 5 6 7 8

MCL
ZBSC-413

1 2 3 4

Mini-Circuits
15542
ZFSC-20500

1 2 3

Mini-Circuits
15542
SPLITTER
ZFSC-3-1

1 2 3

TO 6669

Mini-Circuits
15542
SPLITTER
ZFSC-4-1W

1 2 3 4

TO 1F6B

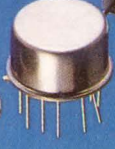
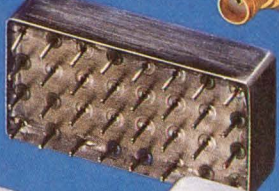

Now, find errors fast, with a portable 1 GSa/s scope that gets right to the problem.

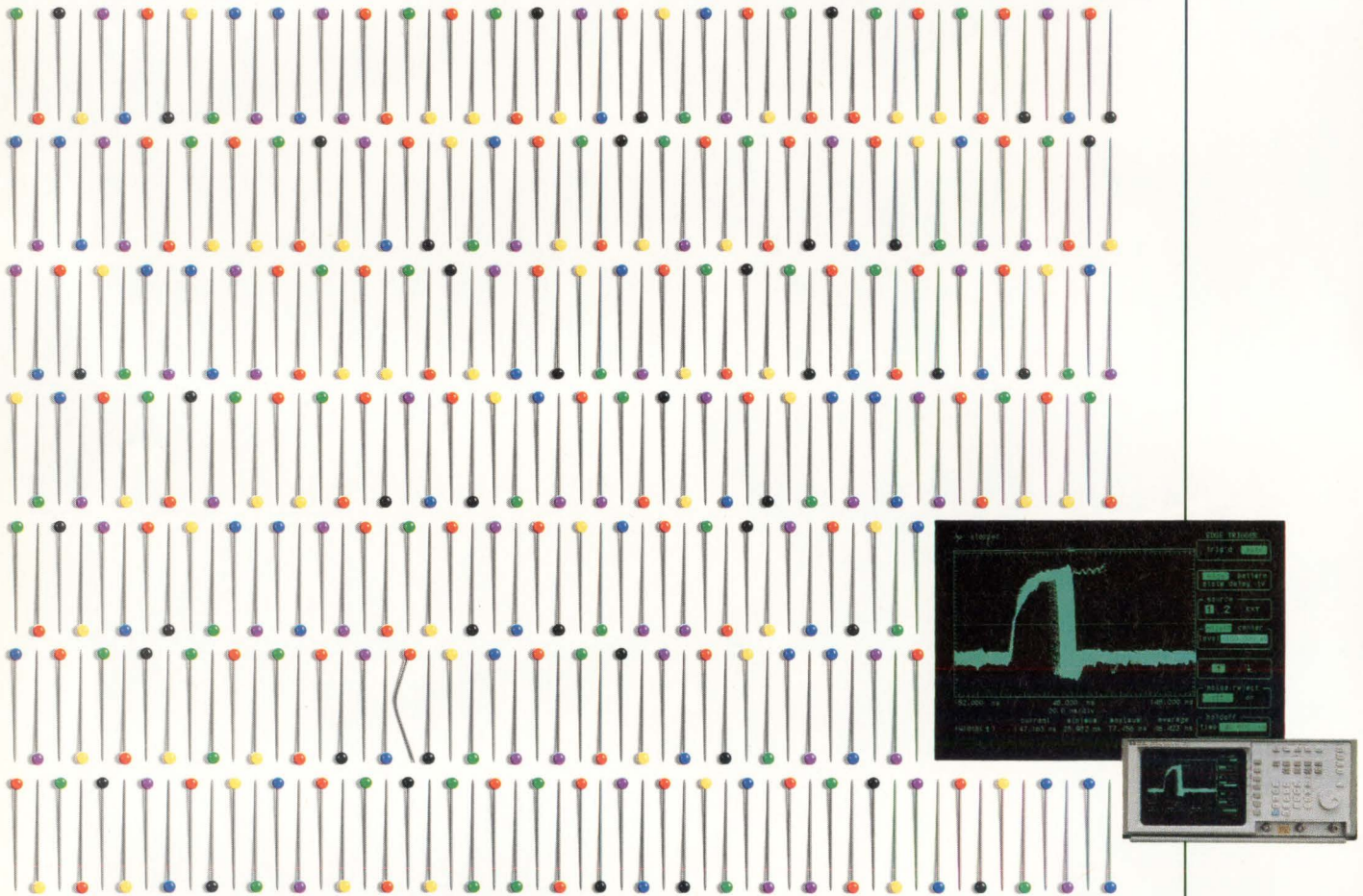

At \$10,950*, you won't find a better value in a digitizing scope.

When you need to troubleshoot and debug digital designs fast, you can't afford to miss a thing. And now, you don't have to. The HP 54510A looks at a billion samples a second with a time-qualified pattern triggering and an infinite persistence display to pinpoint rare events and elusive glitches the instant they happen.

You don't have to stick around to watch, either. The HP 54510A has 8k of memory per channel to capture and store single events. So, you can go back and get all the details you need—with razor-sharp, 8-bit resolution—and track the problem to its source. And to point you to the right solution, the HP 54510A gives you 17 pulse-parameter measurements, with better horizontal and vertical accuracy than the Tek DSA 602, at one-third of the cost.

So, if you're looking for a solution to high-speed troubleshooting, call **1-800-752-0900****. Ask for **Ext. 1902**, and we'll send you an application note on the HP 54510A that shows you how to find faults fast.

*U.S. price only.

**In Canada call 1-800-387-3867, Dept. 423.

There is a better way.



EDITORIAL

Where are the experimenters?

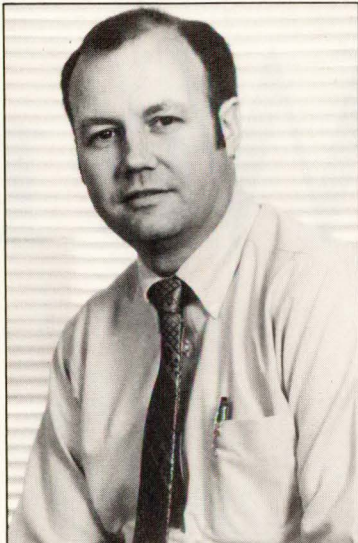

Electronics used to be a fun hobby. I remember my first experiments with electricity. My grandfather, an electrician, wired up a selection of switches, bulbs, buzzers, and bells on small wooden blocks so I could connect them and try out various circuits. Those first circuits led me to explore crystal radios, a 1-tube receiver, plug-board experimenter kits, and, later, kits from Heathkit, Lafayette Radio, and Allied Radio. I tried out a lot of ideas and circuits—even though I didn't always know what I was doing. I recall a particularly neat breadboard that supplied components on yellow plastic mounts that fit into a large sheet of perforated wooden board. Special jumper clips connected the components. The explanations in the accompanying manual told me how the circuit worked and what each component did.

New York City held a special lure for teenagers like me growing up on Long Island. Many of us wanted to “go to the city” to sample night life, see a play, or visit a museum or library. Instead, at 15, my first solo trip to New York took me to Canal Street, an experimenter's paradise where electronic-surplus stores lined a quarter-mile stretch of this downtown street. The stores offered relays, switches, surplus computer boards, military radios, and even old teletypewriters. When you needed a part, you found it on Canal Street.

Much of Canal Street is now history, and I'm afraid that much of the hobby of electronics is, too. I'm always surprised at this time of year by the lack of “101-electronic experiment” kits, chemistry sets, and microscopes in the toy stores. It seemed not long ago that kids enjoyed technical toys. These days, many toys and games use electronic components, but the kids don't know it and don't appreciate what electronics does for them. (Maybe they just haven't had the chance—safety concerns with some of these sets seem to have cleared the shelves of nearly all experimenting toys.)

Most of the hard-core electronics hobbyists and experimenters I knew in high school went on to become talented engineers or scientists. I'm convinced that their early hands-on experience with electronics further advanced their learning and their careers. Perhaps they succeeded because they had developed a feel for things electronic, a love for the technology, and a deep enthusiasm for new possibilities.

The engineering profession is poorer for not giving youngsters the opportunities to experience electronics firsthand, particularly when they're open-minded and awed by technical things. Yet, it's difficult to give them that opportunity. For example, few of the young people I know are interested in amateur radio. With cellular phones, fax machines, and computers and modems, who's thrilled by 2-way Morse-code communication with a person in New Zealand? Likewise, small, inexpensive radios and stereos are easy to buy on most kids' allowances. That makes it completely unattractive to build a short-wave receiver. Why bother?

On the other hand, we don't have legal or medical hobbyists, yet our colleges and universities turn out many fine lawyers and physicians who get almost all of their experience in formal surroundings. Maybe the lack of electronics as a hobby or avocation doesn't harm the engineering profession after all. It's possible, though, that we might have *even better* doctors, lawyers, and engineers if they got some realistic exposure to medicine, legal matters, and electronics before they chose a profession.



Jesse H Neal
Editorial Achievement Awards
1987, 1981 (2), 1978 (2),
1977, 1976, 1975
American Society of
Business Press Editors Award
1988, 1983, 1981

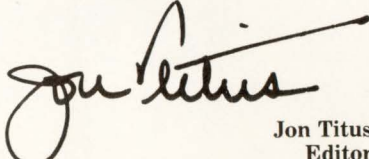

Jon Titus
Editor

Looking We m

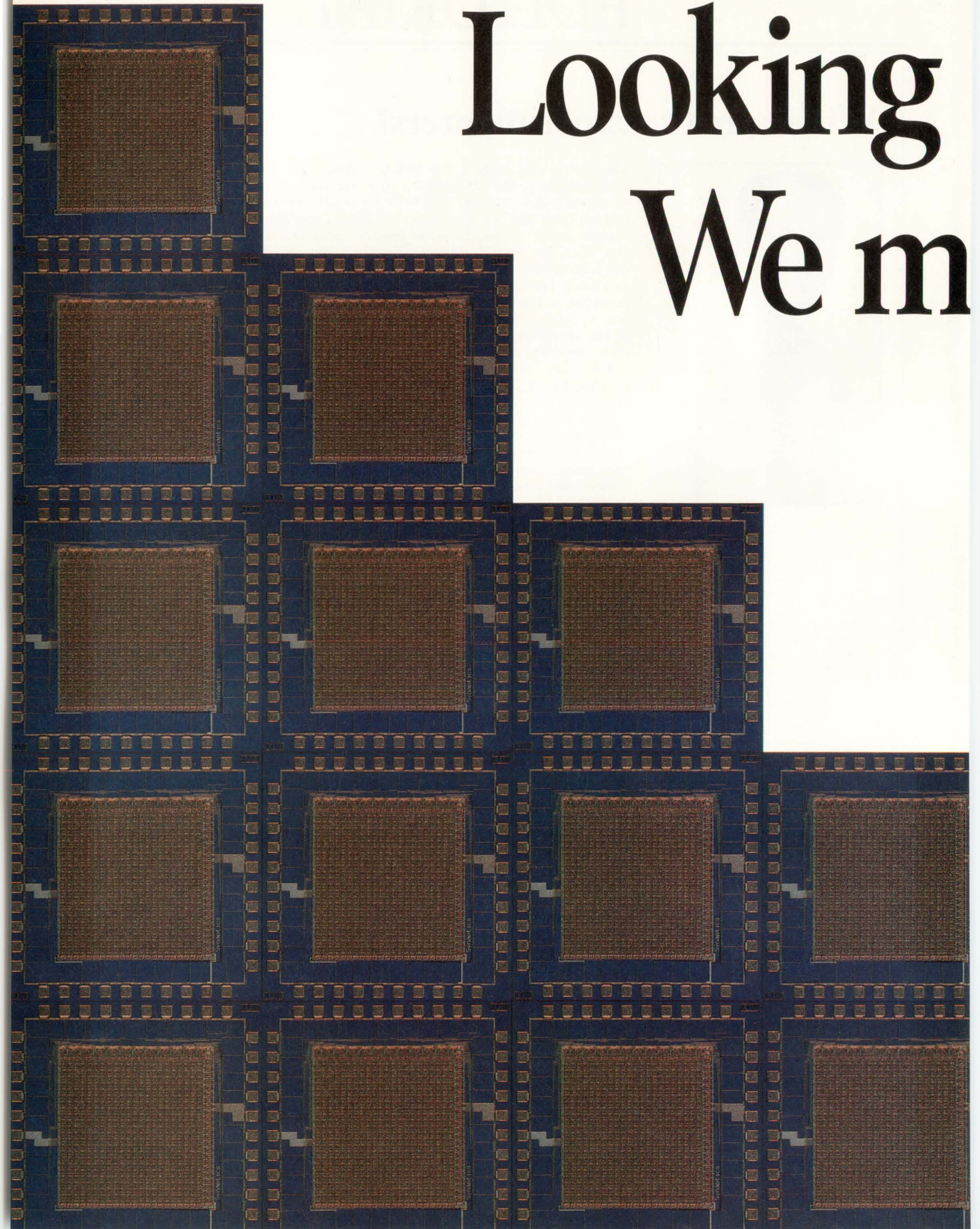

for lower NRE? make it Tiny.

Here's How To Develop Analog/Digital ASICs In Less Time, For Less Money.

Now, for an absolutely tiny price, you can partition complex mixed mode ASICs and separately design and verify the critical segments through fabrication. Cost of fab will no longer stop you from a divide and conquer methodology. Use Tiny Chips and go a step at a time. Tiny Chips, available on Foresight multi-project wafer runs, reduce NRE costs and help you move confidently from prototypes into production.

Twelve packaged parts are available at a cost of just \$1,500. And Foresight runs are regularly scheduled, so development can be pipelined; some segments can be in design, some in fab, while others in test and debug... all at the same time.

Foresight runs support larger die sizes for characterization of completed designs prior to production.

As you might expect from the only foundry to guarantee quick turnaround, Tiny Chips are available in a mere 20–25 working days from CMOS runs supporting:



1.2, 1.5 and 2.0 micron feature sizes

2.0 micron buried channel CCDs

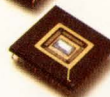

a 40 pin Tiny Chip pad frame supplied by Orbit

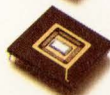

the DoD 2/1.2 micron CMOSN standard cell library with RAM and ROM generators

Getting started is easy as getting design rules and process information in our newly published Foresight User Manual.

If you are trying to build complex ASICs, without building up time and cost, Orbit's new Tiny Chip service may be the biggest news yet. To get more information in a hurry, contact Technical Marketing, Orbit Semiconductor, 1230 Bordeaux Drive, Sunnyvale, CA. Or call (408) 744-1800 or (800) 331-4617. In CA (800) 647-0222. FAX (408) 747-1263.

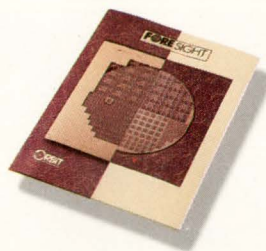
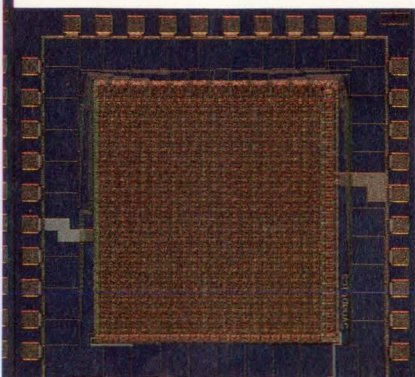

A subsidiary of Orbit Instrument Corporation.

What others promise, we guarantee.

From Star Wars



to Price Wars

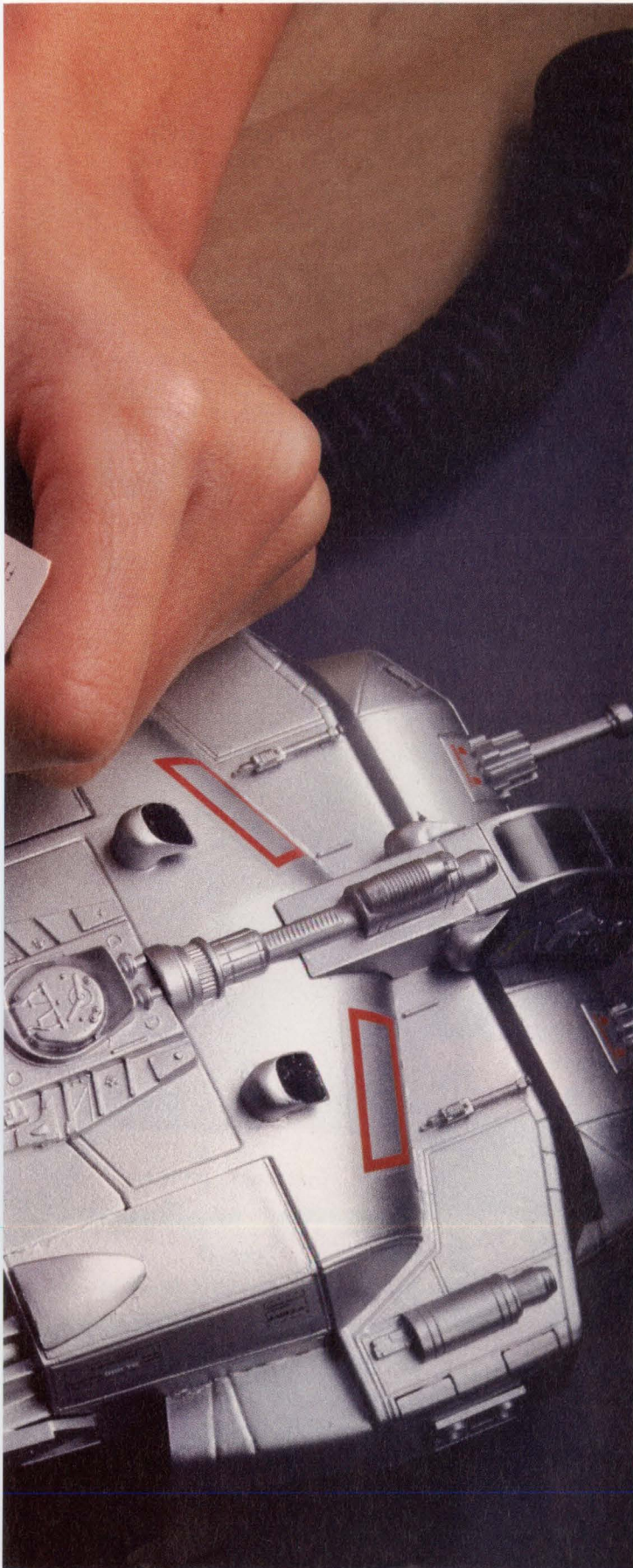

Our High Rel/Aerospace linear array experience is paying off for companies with high-volume, low-cost applications.

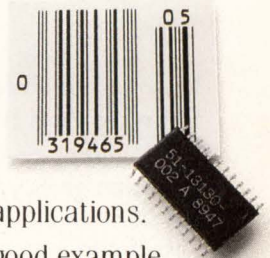

Symbol Technologies is a good example. A tiny Raytheon instrumentation amplifier helped them combine both bar code scanner and decoder in a single, lightweight, handheld unit—that's tough enough to take a five foot drop onto concrete.

Symbol also took advantage of our *Win-Win* program. It let them get to market quickly with a semicustom array, then shift to full custom as sales volumes increased.

Win-Win is fast, flexible, and makes good business sense because it eliminates the risk of getting into a full custom array before you're really ready.

Raytheon is committed to analog technology. From our design kits and engineering support to our fab and plastic assembly facility. We have the experience it takes to help you develop creative, cost effective solutions.

Find out how. Call 1-800 722-7074 for our new analog brochure.

Raytheon Company, Semiconductor Division.
350 Ellis St., Mountain View, CA 94039.

CIRCLE NO. 92

Raytheon

Where quality starts with fundamentals

Greater Than The Sum Of Its Parts

EEsof High-Frequency CAE Software Puts It All Together.

Frustrated by piecemeal CAE software that gives you partial solutions for circuit and system design but leaves you with pieces that don't fit together? EEsof's new Version 3.0 software suite cuts through multi-level microwave and high-frequency analog design problems with ease. Designed to work together from the ground up, Version 3.0 provides a smooth, seamless interface between simulation, modeling, and physical layout. Version 3.0 is a unified and upgraded release of our entire suite of high-frequency analog design tools. From device characterization to linear and nonlinear circuit design

to top-level hardware system design, Version 3.0 puts it all together.

VERSION 3.0

Designs Go Faster and Easier if You Have the Right Environment.

Version 3.0 lets you run EEsof's entire simulation suite through ACADEMY,® a single, easy-to-use graphical environment that is specifically

designed to meet your requirements. EEsof's simulators Touchstone,® Libra,® Microwave SPICE,® and OmniSys® are all available at a touch of a key, and data files from one are instantly available to others. ACADEMY makes linear and nonlinear hierarchical design practical, using high-frequency simulation techniques you already know!

Call Us Today; Let Us Help You Put the Pieces of Your Puzzle Together!

For more information on EEsof's full suite of software tools for high-frequency analog design, call us today at (800) 624-8999, ext. 155. Or if you prefer, send the details of your CAE puzzle by FAX to (818) 889-4159. In Europe, call (49) 8105-24005, or FAX to (49) 8105-24000.

We'll answer your questions and send you a copy of our new Version 3.0 catalog.



Corporate office:
5601 Lindero Canyon Road,
Westlake Village, CA 91362

European office:
Rudolf Dieselstrasse 17,
D-8031 Gilching, Germany

Breaking the Barriers...

EEsof®

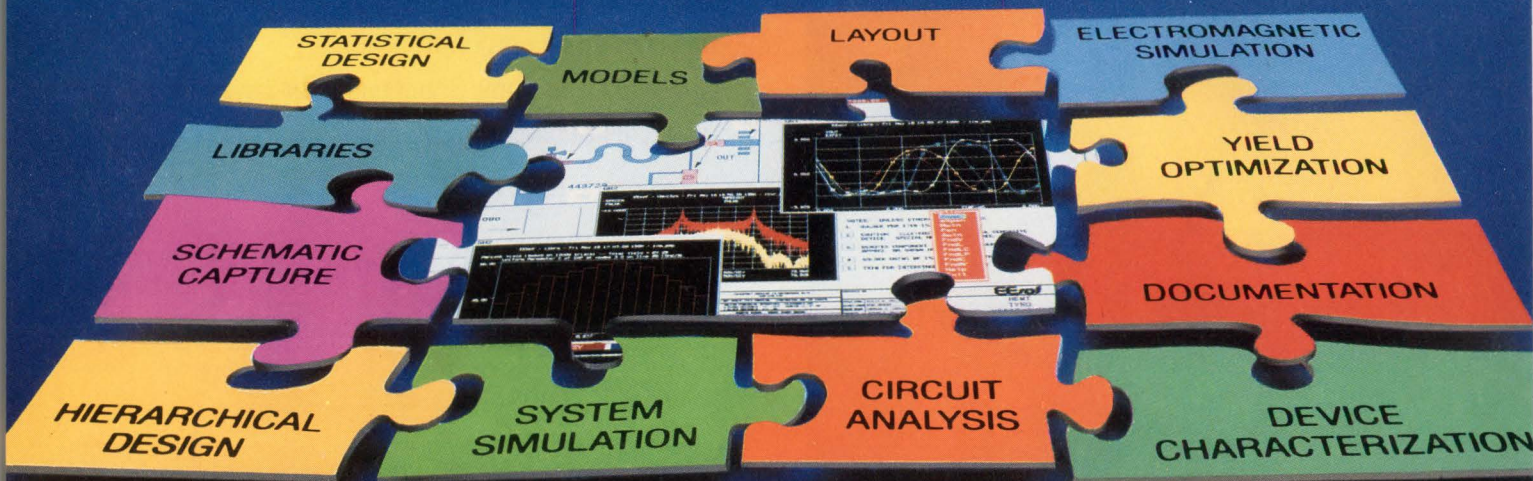

SEMICUSTOM ANALOG ASICs

Design methods resist generalization



Designing an analog ASIC requires a tremendous amount of communication between system and IC designers.

Anne Watson Swager,
Regional Editor

Choosing the appropriate design method for your analog ASIC can reduce much of the design risk currently associated with these ICs (see **box**, "Recognize risks to reap rewards"). Making this choice is not trivial because many variations of each basic method exist. Regardless of whether you, the vendor, or an independent designer or fabless design house do the majority of the designing, a close working relationship among all concerned parties is the only way to ensure design success.

Analog-ASIC design methods fall into two general categories: full custom and semicustom. Full-custom ASICs are completely handcrafted from bare silicon, generally by an experienced IC designer.

Semicustom analog ASICs split into array-based and standard-cell designs.

Traditional component arrays consist of a slate of transistors, resistors, and capacitors on a piece of prefabricated silicon. Tile arrays comprise fixed circuit blocks. Each block contains a fixed number and type of active and passive components. For both types of arrays, the designer's job is to connect the elements by defining one or sometimes two final metallization layers.

Standard-cell designs start out as a blank slate. By defining the functions you want from the vendor's library—or by speci-

fying some new cells of your own—you create the entire mask set for the chip. The vendor has already designed and characterized the cells' corresponding mask sets. Most vendors of cells and arrays have some capacity to place digital gates on their ICs. These vendors still consider themselves analog vendors, despite the mixing of analog and digital circuitry.

Full-custom ICs clearly make the best use of their die area, but they incur the longest design times and highest NRE costs. Standard cells place second on the silicon-efficiency scale. You choose only the exact circuit elements you need. However, standard-cell designs are only half a step from full custom. Rarely does a vendor's library contain all the cells you need; the vendor must often create new "custom" cells.

Arrays trade a standard-cell design's

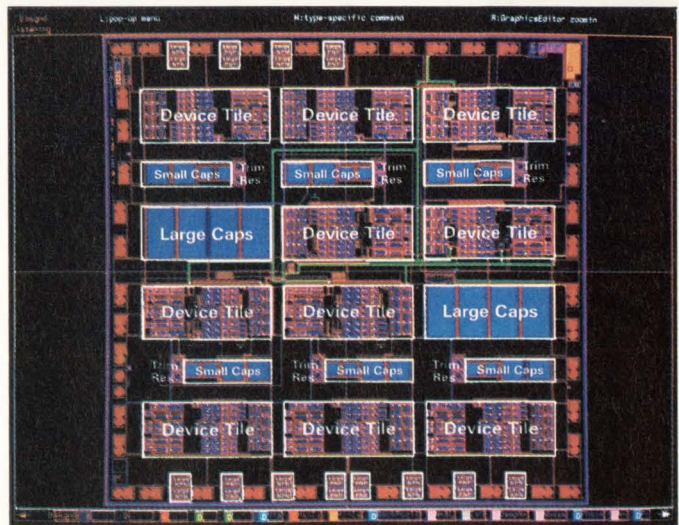

Tile arrays use silicon less efficiently than standard-cell designs do, but they generally have faster turnaround times. Many tile arrays, such as the HTA2000 from Harris Semiconductor, also have cell functions.

When Time Is Money ... Tektronix QuickCustom™ ASICs



Tektronix' QuickCustom ASICs make it easy for you to create your own analog designs fast. And error free.

Our high speed QuickCustom family of bipolar products, together with Tek's QuickCustom design system, help ensure that your design works right the first time, reducing development time and cutting costs.

◆ Tektronix QuickChips™ help you move from concept to finished product with minimum design and fabrication time. ◆ For even higher performance and greater flexibility, the Tektronix QuickTile™ design method offers standard building blocks for fast implementation of analog and mixed signal functions. ◆ And finally for optimum performance and functionality, Tektronix' Full Custom design method is also available.

All three QuickCustom products

provide convenient access to our high performance bipolar process ($f_T = 8.5$ GHz and $V_{CE0} \geq 8$ V) with Schottky diodes, JFETs, NiCr resistors, and PNPs. Typical applications include high speed data converters, L-Band amplifiers and mixers, and low noise transducer amplifiers. Our advanced QuickCustom design system, which includes complete CAD tools, thorough characterization of all devices, and support, allows even the first time user to successfully complete the design.

When time and performance are critical, choose QuickCustom from Tektronix.

Your quickest solution.

For more information, please circle our reader number, or call 1-800-835-9433, extension 100.

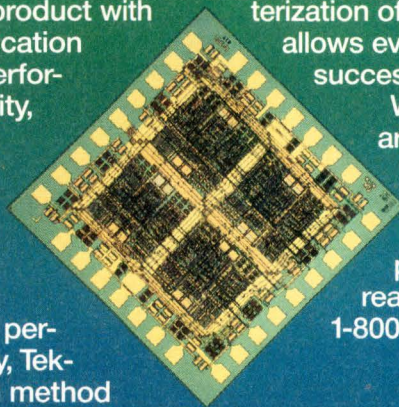

Tektronix[®]
COMMITTED TO EXCELLENCE

CIRCLE NO. 42

TECHNOLOGY UPDATE

Semicustom analog ASICs

efficient use of silicon for lower NRE costs and faster turnaround times. Tile arrays constrain a design if that design calls for an element or number of elements not on the array. Also, tile arrays may waste silicon by leaving some passive or active components unused.

Volume will also influence your design-method choice. For example, if you're planning to build a small number of ICs, a tile array will get you started with less NRE costs. Also, many vendor's fabrication processes and design methods may only be viable for high-volume customers (many vendors define high volume as 100,000 to 250,000 units per year). Unless a vendor has a substantial business interest in your particular application area, you may not be able to find a company to build your chip in small volumes.

Now, the exceptions

Unfortunately, these generalizations about design methodologies make choosing a design approach

sound cut and dried. It's not. For one thing, analog-ASIC design capabilities are changing fast. **Table 1** can serve as a guide, but tables tend to oversimplify the design choices. The equivalent of the digital gate array does not exist in the analog world: There's no consensus or well-accepted standard approach to designing analog ASICs.

For example, making assumptions about the process technology you need may be risky. Analog ASICs can be CMOS, bipolar, or BiCMOS. You might assume that you have to use a bipolar process to build a function with a particular performance level, but even the vendors themselves are surprised at what they can accomplish with CMOS processes. Don Bartlett, an analog-design project leader at NCR Microelectronics, says his company now has a 10-bit ADC as a standard cell—a goal engineers didn't think they could achieve a year ago.

Both standard cells and arrays are changing in ways that either

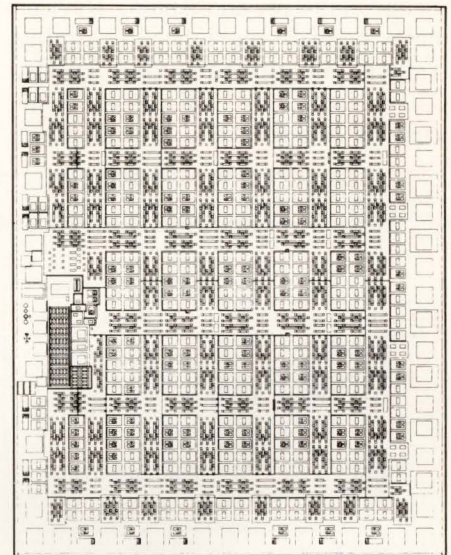

Bandgap references are a permanent fixture of some tile arrays. The Genesis 5200 semicustom IC from Cherry Semiconductor has a reference on the lower left-hand side of the array.

minimize or remove their previous limitations. Tools continue to become available to system designers. Large and well-established semiconductor companies such as Texas Instruments, Motorola, National

Recognize risks to reap rewards

Analog ASICs are laden with many design risks and tool shortcomings that digital ASICs have long since overcome. Common design problems include isolating noise, isolating the substrate, interfacing the chip with external electronics, and keeping NRE costs low and all schedules short. Designers measure the "first-time silicon success" of analog ASICs functionally. Many analog ICs work on the first pass, but they often require some form of tweaking to perform exactly as you want.

Inadequate tools and the lack of test methods are the two big stumbling blocks for analog and mixed-mode ASICs. Spice and its derivatives serve many pure analog designs well, but capable mixed-mode simulation tools are just beginning to become available. Worst-case modeling is difficult, and vendors don't guarantee a part will work based on simulation results alone.

No systematic or widely accepted test method for analog ASICs exists. Vendors don't have much to say about test except that they're working on it. They do say that testing a highly embedded function requires early planning on how the testing equipment will access the chip.

The good news is that you don't necessarily need expensive tools to design analog ASICs. Many vendors have made IBM PCs and compatibles their hardware of choice. Other design methods don't even require that you simulate the ASIC because you're combining proven building blocks. Micro Linear's semistandard ICs let you specify a combination of proven circuits. Advanced Linear Devices provides building blocks identical to those of the final IC. You can connect these blocks and troubleshoot them on a pc board.

TECHNOLOGY UPDATE

Semicustom analog ASICs

Semiconductor, and Analog Devices have much experience designing analog and mixed-signal ASICs. These companies will design semi-custom ICs for you, as will other

companies listed in **Table 1**, using their proprietary tools and standard cells. They generally work with very-high-volume customers and only make their tools available to

special customers. However, these companies envision a time when tools will be available to all their customers. Within the next couple of years, TI will make parts of its

Table 1—Representative semicustom analog ASIC design methods

Manufacturer	Product	Design method	Vendor/customer relationship	Process	Typical NRE costs
Advanced Linear Devices	Function specific linear ICs	Cell based with standard products	Customer designs	CMOS	\$20,000 to \$50,000
Analog Devices	Mixed-signal ASICs	Cell based	Turnkey supplier only	BiCMOS	\$50,000 to \$100,000
AT&T Microelectronics	CBIC process	Array based	Customer/vendor designs	Bipolar	\$30,000 to \$50,000
Cherry Semiconductor	Genesis	Array based	Customer designs	Bipolar	\$10,000
Custom Arrays Corp	MM/MV	Array based	Customer designs	Bipolar	\$5000 to \$15,000
Exar	Flexar	Array based	Customer designs	Bipolar	\$2500 to \$9500
Gould AMI	Mixed-signal design solution	Cell based	Customer designs	CMOS	\$50,000 to \$70,000
Harris Semiconductor	Mixed-signal, analog and power ASICs	Cell based	Customer designs	Bipolar, CMOS, BiCMOS	From \$40,000
ICS	Mixed-signal ASICs	Cell based	Turnkey supplier only	CMOS	\$30,000 to \$70,000
International Microelectronic Products	Mixed-signal ASICs	Cell based	Turnkey or joint designs	CMOS, NMOS	\$90,000
Micro Linear Corp	Semistandard ICs	Array and cell based	Turnkey supplier only	Bipolar, CMOS	\$5000 to \$50,000
Motorola	Mixed-signal ASICs	Cell based	Turnkey or joint designs	CMOS bipolar	\$30,000 to \$55,000
National Semiconductor	Clasic	Cell based	Turnkey or joint designs	Bipolar, CMOS, BiCMOS	\$45,000 to \$65,000
NCR Microelectronics	Mixed-signal ASICs	Cell based	Turnkey or joint designs	CMOS	\$40,000 to \$50,000
Plessey Semiconductor Corp	ULA mixed-signal ICs	Array based	Turnkey or joint designs	Bipolar	\$5000 to \$6500 (customer designs) from \$18,500 (turnkey designs)
Raytheon Semiconductor	RLA, RFA	Array based	Customer designs	Bipolar	From \$21,000
SGS-Thomson Microelectronics	ANACA mixed-signal and linear ASICs	Array and cell based	From turnkey to customer designs	Bipolar, CMOS, BiCMOS	\$30,000 to \$75,000 (standard cell) \$25,000 to \$40,000 (arrays)
Sierra Semiconductor	Mixed-signal ASICs	Cell based	Turnkey or joint designs	CMOS	\$20,000 to \$120,000
Tektronix	QuickTile	Array based	Customer designs	Bipolar	\$85,000 to \$91,000
Texas Instruments	LinASIC	Cell based	Primarily turnkey	Bipolar, CMOS, BiCMOS	\$50,000 to \$150,000

Note: The mixed analog/digital methods included in this table have the ability to integrate large amounts of analog circuitry. Vendors that offer primarily digital ASICs with only a small analog portion are not included here.

TECHNOLOGY UPDATE

tools compatible with Mentor Graphics' Falcon framework. Gould AMI is announcing the final version of its Mixed-Signal Design Solution system this quarter. The system

will include model-building software that lets you create cells in house.

Categorizing array-based methods is difficult. Array-based meth-

ods range from AT&T's high-speed, high-performance CBIC process to Advanced Linear Devices' standard IC building-block approach. Many arrays now have features that minimize their previous limitations, too.

First of all, designing with tile arrays doesn't require designing exclusively with discrete transistors, capacitors, and resistors. Instead of transistors, for example, Raytheon Semiconductor uses gain blocks as the basic element in its arrays. Most tile-array vendors feature macrocells and defined tiles. In most cases, these tiles are located at specific locations on the tile array.

For example, Cherry Semiconductor's Genesis 5200 high-frequency array features a programmable bandgap voltage reference on the lower-left edge of the array. You can program the reference's voltage between 1.25 and $V_{CC} - 2V$. By using a fuse-link trim option, you can achieve a voltage deviation of $\pm 3.5\%$. You can internally structure the tile in four configurations.

SGS-Thomson's TSFJ series of mixed bipolar arrays also have built-in bandgap references in addition to tiles for oscillators, voltage regulators, and R-2R ladders for a 6-bit DAC. Raytheon's RLA ICs consist of op-amp cells, comparator cells, and thin-film resistors. Plessey's ULA DA family of analog/digital arrays include a bandgap reference, voltage regulators, low-offset transistors, matched precision resistors, capacitors, and 120-mA transistors.

Tile arrays suit many applications, including military ones. Late last year, Harris Semiconductor announced the dielectrically isolated HTA2000 analog tile array. The two versions of the array meet class S and class B reliability requirements. The dielectric isolation lets the arrays use both vertical npn and pnp transistors. The arrays' library

Typical turnaround times (weeks)	Comments
12 to 16	User designs and breadboards the ASIC with completely specified, standard ICs provided by the vendor. Specializes in low-power designs.
24 to 52 from signed specification	NRE charge includes all design and fabrication to deliver final packaged and tested silicon. Specializes in high-performance (12-bit accuracy) circuits.
6 to 8	High-speed and high-performance process. Some arrays are laser trimmable. Building block kits are available. Vertical pnp and npn transistors.
8 to 12	Company maintains BBS for users to transfer design information (1-800-272-2447).
4 to 8 from layout	Macrocell library contains amplifiers, comparators, timers, regulators, buffers, flip-flops, S/H amplifiers, and Schmitt triggers. Kit parts available. Company sells design software for 386-based IBM PC.
3 to 6	Designer can move tiles to different locations and can create either an npn or a pnp transistor in a given location. Macro library of proven circuits.
From 20	Model-building software lets designers create models in house.
6 from final design	Tile arrays and standard cells part of FastTrack design system. Runs on Unix workstations.
16 to 20 from first specification	Design services include "free-look" prototyping. Vendor can make changes at this stage without scrapping masks and prototype wafers. Specializes in low-power designs, not locked into 5V process.
22 to 24	Also offers manufacturing services for customer designs.
6 to 14 (bipolar) 12 to 24 (BiCMOS) after design verification	You create a semistandard IC by modifying an existing standard product.
6 from simulation	Company provides engineering design assistance for \$3000/week. NRE and lead times are quoted for company's MOS products.
12 to 16 (conception to first prototype)	1-week training course is free to customers and \$1000 for others. Dense bipolar process yields high integration.
10.5 from design review	Accurate cell models have timing information from silicon built in. Turnaround time includes customer-performed post-simulation layout. High-performance CMOS.
4 to 12	Library of analog and digital macro functions. Special cells located at chip corners. 5-mask process keeps costs down.
6 to 8 from design verification	Macrocell op amps and comparators. Dual-layer metal. Thin-film resistors. Kit parts available.
6 to 9 (standard cell) 3 to 4 (arrays)	Tiles have kit parts. Macrocell library includes op amps, comparators, timer/oscillator, video amplifier, bandgap reference, transconductance amp Schmitt trigger, NOR, NAND, flip-flop, and DAC.
9	Company has large library of cells. Process technology combines analog and digital circuitry and EEPROM.
10	Startup package with software and training course costs \$15,000. Software runs on Sun workstation. High-speed designs, accurate models.
16 to 52	Specializes in high-performance, high-integration designs.

TECHNOLOGY UPDATE

Semicustom analog ASICs

of cells includes op amps, comparators, S/H amplifiers, buffers, references, and differential video circuits.

Tile arrays get more flexible

Possibly the biggest design deterrent to using tile arrays is their inflexibility, but vendors are coming up with ways to make tile arrays more flexible. Tektronix's QuickTiles, relatives of the company's QuickChip family of ICs, combine full-custom fabrication with a tile-like design method. Designers define the circuit by snapping together standard tiles at any desired location on a coarse grid. Because the location of the devices

in the arrays varies, all mask levels must be generated and the wafers must be fabricated from bare stock. The grid eliminates the risk of violating layout rules.

Both Exar and Custom Arrays Corp (formerly Interdesign) have tile arrays from which you can create either pnp or npn transistors. Exar's Flexar array lets you select either an npn or a pnp transistor from the same location using a single layer of metal. Custom Arrays' MV array has what the company calls a pnpn structure. The pnpn elements can serve either as lateral pnp or normal npn transistors. The arrays have a modular structure of cells that repeats throughout the

chip. Thus, you can place macro functions anywhere on the array. Flexar's arrays come with a soft-macro library of proven circuits as well as kit parts and Spice device models. **EDN**

References

1. Quinnell, Richard A, "Mixed analog-digital ASICs," *EDN*, June 22, 1989, pg 147.
2. Pryce, Dave, "Semicustom circuits: Analog-digital ICs provide versatility," *EDN*, March 1, 1990, pg 91.

Article Interest Quotient (Circle One)

High 518 Medium 519 Low 520

For more information . . .

For more information on the analog ASIC products discussed in this article, circle the appropriate numbers on the Information Retrieval Service card or use EDN's Express Request service. When you contact any of the following manufacturers directly, please let them know you saw their products in EDN.

Advanced Linear Devices Inc
1180F Miraloma Way
Sunnyvale, CA 94086
(408) 720-8737
FAX (408) 720-8297
Circle No. 700

Exar Corp
Box 49007
San Jose, CA 95161
(408) 434-6400
FAX (408) 943-8245
Circle No. 705

Micro Linear Corp
2092 Concourse Dr
San Jose, CA 95131
(408) 433-5200
FAX (408) 433-0295
Circle No. 710

Raytheon Semiconductor Co
350 Ellis St
Mountain View, CA 94043
(415) 968-9211
FAX (415) 966-7620
Circle No. 715

Analog Devices Inc
Box 9106
Norwood, MA 02062
(617) 329-4700
FAX (617) 326-8703
Circle No. 701

Gould AMI
2300 Buckskin Rd
Pocatello, ID 83201
(208) 233-4690
Circle No. 706

Motorola Inc
Box 6000
Austin, TX 78762
(512) 928-6880
Circle No. 711

**SGS-Thomson
Microelectronics Inc**
1310 Electronics Dr
Carrollton, TX 75006
(214) 466-7346
FAX (214) 466-6572
Circle No. 716

AT&T Microelectronics
555 Union Blvd
Allentown, PA 18103
(800) 372-2447
Circle No. 702

Harris Semiconductor
Box 883
Melbourne, FL 32901
(800) 442-7747
Circle No. 707

National Semiconductor Corp
Box 58090
Santa Clara, CA 95052
(408) 721-6042
Circle No. 712

Sierra Semiconductor
2075 N Capitol Ave
San Jose, CA 95132
(408) 263-9300
FAX (408) 263-3337
Circle No. 717

Cherry Semiconductor Corp
2000 S County Trail
East Greenwich, RI 02818
(401) 885-3600
FAX (401) 885-5786
Circle No. 703

ICS
Box 968
Valley Forge, PA 19482
(215) 666-1900
FAX (215) 666-1099
Circle No. 708

NCR Microelectronics
2001 Danfield Ct
Fort Collins, CO 80525
(303) 226-9500
Circle No. 713

Tektronix Inc
Box 500
Beaverton, OR 97077
(503) 627-2515
FAX (503) 627-5560
Circle No. 718

Custom Arrays Corp
525 Del Rey Ave
Sunnyvale, CA 94086
(408) 749-1166
FAX (408) 749-1718
Circle No. 704

**International Microelectronic
Products**
2830 N First St
San Jose, CA 95134
(408) 432-9100
FAX (408) 434-0335
Circle No. 709

Plessey Semiconductor Corp
1500 Green Hills Rd
Scotts Valley, CA 95066
(408) 438-2900
FAX (408) 438-7023
Circle No. 714

Texas Instruments Inc
Box 655303
Dallas, TX 75265
(214) 997-6400
Circle No. 719

Count On IDT

The R3001 RISController™: The Embedded Processing Solution

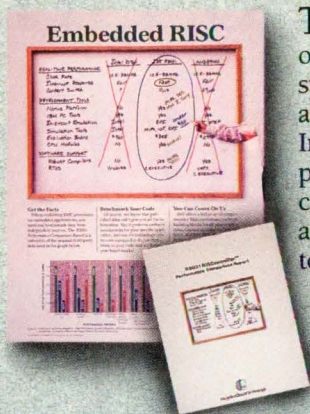

The R3001 is the first derivative of the R3000 processor designed specifically for embedded control applications. Compared to the Intel 960 and AMD 29K processors, the R3001 is the most cost-effective solution for these applications—we have the data to prove it! Call and ask for **KIT CODE 0091A** to get an **R3001 Performance Comparison Report**.

BiCEMOS™ ECL SRAMs: Technology for the '90s

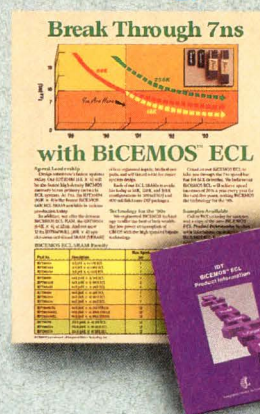

Design the fastest systems with IDT's BiCEMOS ECL family. At 7ns, the IDT10494 is the fastest BiCEMOS 64K ECL SRAM in production. 256K and synchronous self-timed SRAMs are also available in 10K/100K/101K configurations. Call and ask for **KIT CODE 0091B** to get a copy of the **BiCEMOS ECL Product Information** booklet.

FCT-T Logic: Fastest Speed/ Lowest Ground Bounce



IDT's FCT-T Logic Family is the fastest logic family available and has the lowest ground bounce—up to 40% less than previous FCT devices! The FCT-T family provides direct TTL logic compatibility and is available in FCT, FCT-AT, and FCT-CT speeds. Call today for **KIT CODE 0091C** and get a copy of the **High-Speed CMOS Logic Design Guide**.

The SyncFIFO™ Family: Double Your FIFO Performance

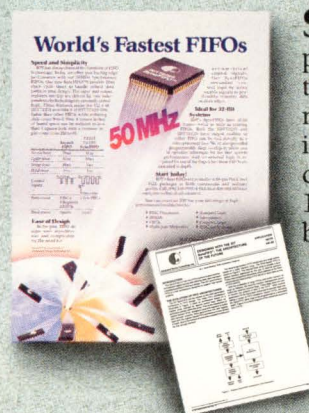

SyncFIFOs offer leading-edge performance that is 50% faster than other FIFOs. The synchronous architecture is easy to implement and reduces chip count 9-to-1. SyncFIFOs have 18-bit buses and are ideal for 32-bit systems. Ask for **KIT CODE 0091D** to get **AN-60: Designing with the IDT SyncFIFO™**.

IDT Subsystem Modules: Building Blocks for the '90s



IDT offers a complete line of board-level subsystem products, including cache memory, shared-port memory, writable control store, RISC CPU, high integration modules, and custom designs for specific applications. Call today for **KIT CODE 0091E** and receive technical data and a **free IDT puzzle!**

12ns Cache Tag SRAMs: Wait No Longer



IDT's cache tag SRAMs have the features you want to design in: single-pin block reset, totem-pole match output, 4K and 8K depths, industry standard pinouts, and an on-board comparator to simplify design. Call and ask for **KIT CODE 0091F** to get **free samples** of the IDT6178 cache tag.

RISController, BiCEMOS, and SyncFIFO are trademarks of Integrated Device Technology, Inc. The IDT logo is a registered trademark of Integrated Device Technology, Inc.

Contact us today to receive data sheets and other design information on IDT's products.

(800) 345-7015
FAX: 408-492-8454

3236 Scott Boulevard, P.O. Box 58015, Santa Clara, CA 95052-8015

EDN February 4, 1991

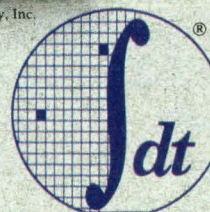

When cost-effective performance counts

Integrated Device Technology, Inc.

Our Simultaneous Eng Integrated Fro

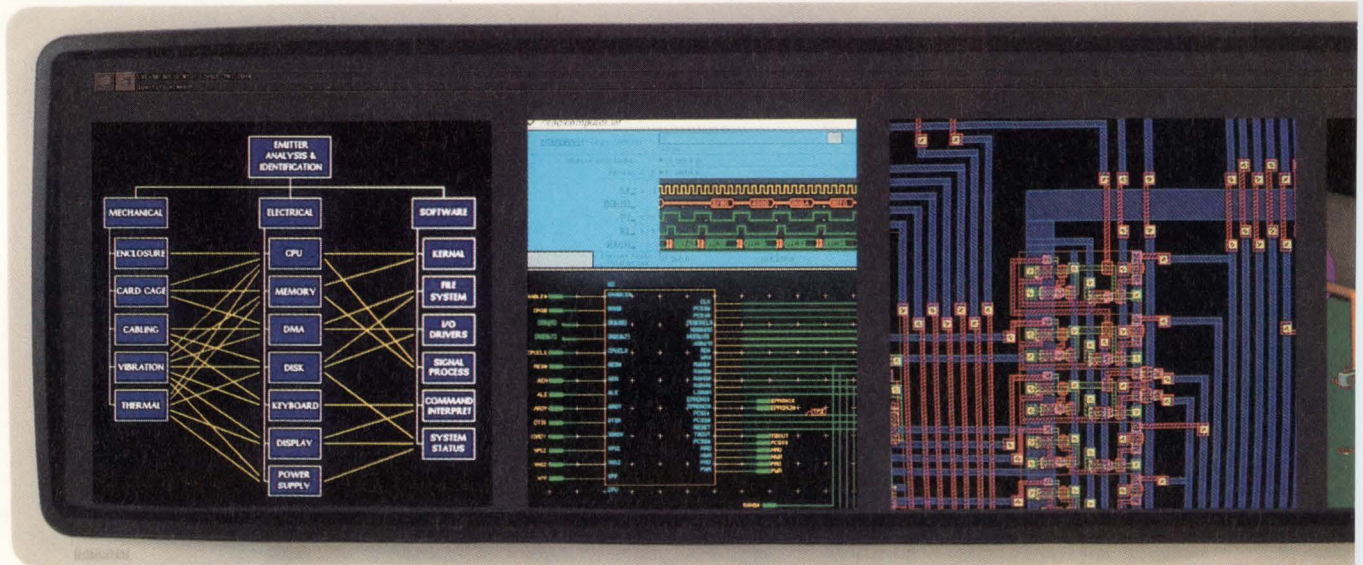

What's in it for you?

Intergraph's Simultaneous Engineering Environment (SEE) delivers the EDA functionality you've asked for. Open framework. Common database. Common user interface across applications. And a complete toolset, including solutions for front-to-back electronics design, mechanical design, manufacturing, and document management.

Plus, SEE brings you an important bonus — confidence. The confidence of partnership with the billion-dollar corporation that leads North America in CAD/CAM/CAE sales.

Choose Intergraph solutions, such as our newest MCM and mixed-mode tools. Choose third-party solutions from our InterLink partners. Then let SEE integrate those solutions into a single EDA system — using the same framework that outperformed all others in our recent contract wins with a Big Three auto manufacturer and the U.S. government.

There's more you should know. Call 800-826-3515 or send a fax to 205-730-8344. Ask for document EDA-135. We'll send you a copy of "Simultaneous Engineering: The Facts." It's free.

In Europe: call 31-2503-66333. In the Asia Pacific area: call 852-8661966.

Intergraph® is a registered trademark and Everywhere You Look is a trademark of Intergraph Corporation. Other brands and product

Delivering
Now

Engineering Environment. From End To End.

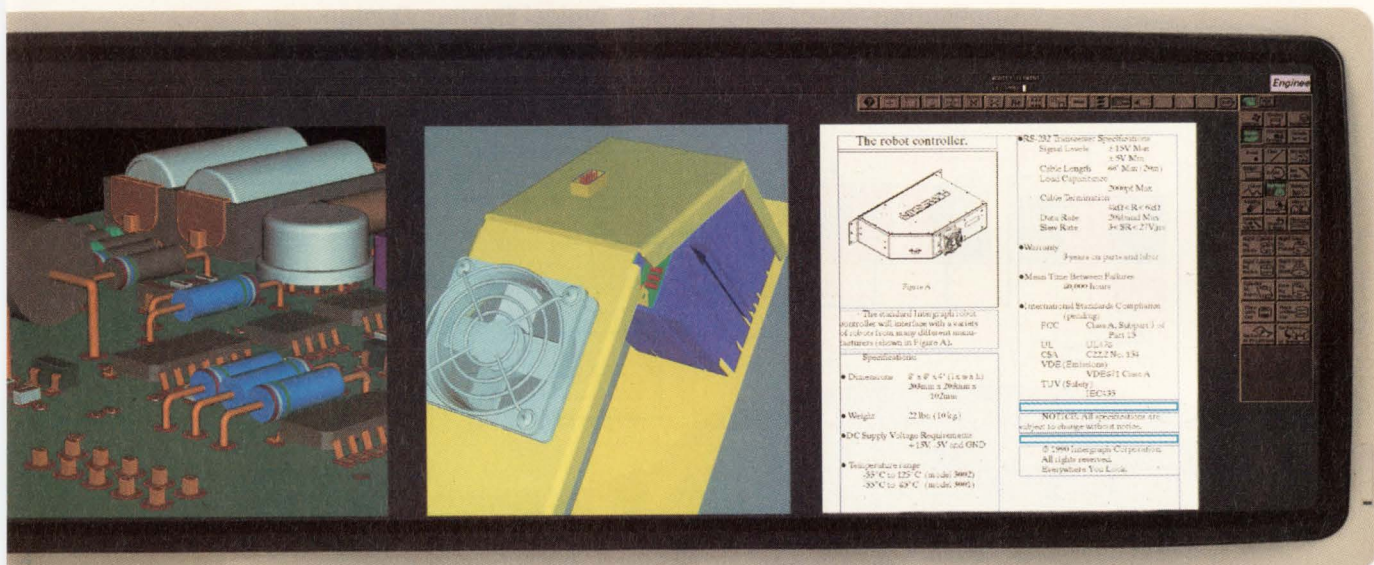

INTERGRAPH
Everywhere you look.

names are trademarks of their respective owners. Copyright 1990 Intergraph Corporation. Huntsville, AL 35894-0001. DDAD009A0.

Signetics. Because the gives you the

TO MAKE YOU A TOP DOG IN 32-BIT SYSTEM DES

Application-Specific PLDs for a Typical System Design

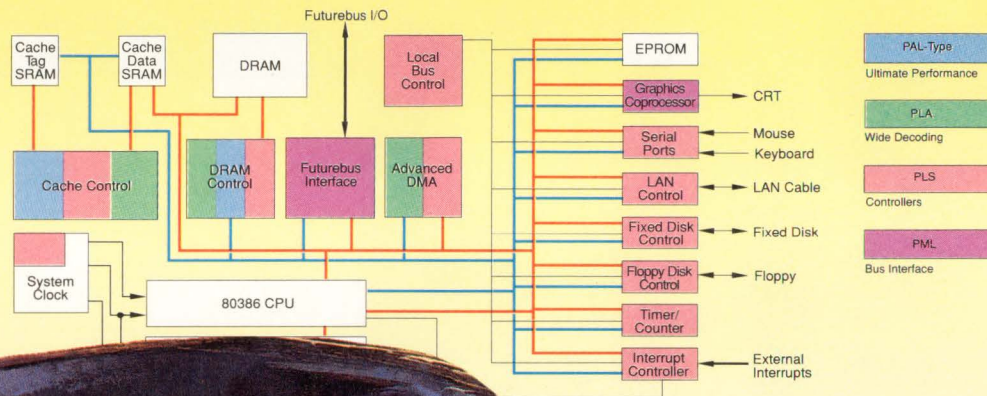

© 1990 NAPC

Philips Components

right choice of PLDs inside track.

GENS, WE'VE UNLEASHED A FULL RANGE OF PLDs.

With Signetics PLDs in your design, now you can start fast and finish strong in the race to market.

More flexible and powerful than traditional PAL® devices, our four PLD groups offer you tailor-made solutions. Each raises your productivity and lowers your design time.

To help you stay on the right track, we offer a full family of PLD products and architectures to choose from:

PAL-TYPE DEVICES. With Signetics you get the largest selection as well as the world's fastest PAL-type products. Including our 7.5ns Bipolar device. It gives you both speed and versatility to achieve zero-wait state designs that get the most from today's high-performance microprocessors. Or for such applications as cache memory control, choose our 5ns Programmable High-speed Decoder (PHD) or our 200MHz ECL 20EV8.

PROGRAMMABLE LOGIC ARRAYS (PLA). Programmed as easily and with the same software tools as PAL devices, our full family of PLAs are efficient, single-chip solutions offering the increased decoding resolution that's critical for 32-bit microsystem design. When you need more than eight product terms per output, our PLUS173-10 significantly outperforms the fastest PAL device.

PROGRAMMABLE LOGIC SEQUENCERS (PLS). Designed with dedicated buried registers, Signetics PLSs are ideal for synchronous or asynchronous timing and control functions. They're also perfect when designing bus

controllers, interrupt generators and dual-quad arbiters. For these applications our PLUS405-55 is a better solution than traditional PALs, giving you higher integration, a lower chip count and reduced system delays.

PROGRAMMABLE MACRO LOGIC (PML). When you're designing system-level interface and control solutions for any bus architecture, there's no better building block than our family of high-density PML devices. With the speed and unique architecture of our Bipolar PLHS502, you can easily design Futurebus, Microchannel® and EISA products requiring wide bandwidth multiplexers, wide data paths and multiple registers.

YOUR TICKET TO DEVELOPMENT SUPPORT. For fast, efficient product development, use our design and simulation software tools: SNAP and AMAZE. Or choose an industry-standard program such as ABEL or CUPL.

Now you have PAL solutions and more. Finish at the head of the pack with Signetics PLDs. For more information on how we're extending the dimensions of PLD performance, call today for a PLD Selection Guide and 1990 Data Handbook: 800-227-1817, ext. 712D. Ask about military and surface mount product availability for all our PLDs.

PAL is a trademark of AMD/MMI Microchannel is a trademark of IBM

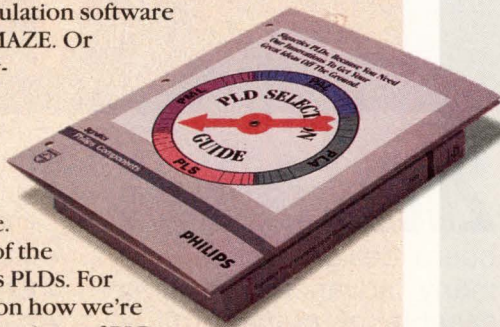

Signetics

EXTENDING THE DIMENSIONS OF PERFORMANCE



**EXPERIENCE THE FUTURE
IN CAE/CAD**

2000 PADS

2000 PADS is a Personal Computer based Printed Circuit board design system with many advanced features capable of outperforming most Workstation-based CAD systems—*at a fraction of the cost.*

As the most productive PC based board CAD system available today, PADS-2000 can handle even the most complex designs including: double sided surface mount boards, mixed technology boards, high speed designs and layouts exceeding 2000 IC's.

PADS-2000 design functionality includes:

- Over 11,000 parts/32,000 connections
- 1 micron Resolution
- True T-Routing capability

- Intelligent Copper Pour feature leaving isolated tracks and pads
- 0.1° parts/pads rotation
- Extensive Macro capability
- Digital, Analog and Critical Circuit autorouters

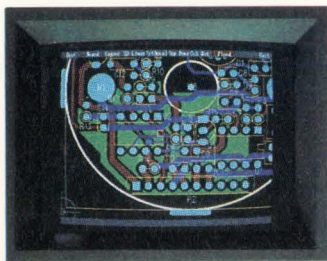

- On-line and Batch Design Rule Checking
- Instant track/segment length measurement
- Complete Forward/Backward ECO capability
- Uses 32 bit/386 native code for increased speed and functionality
- Easy-to-learn and Easy-to-use

Call today for a demonstration at your local authorized CAD Software Dealer.

Ask about our affordable Leasing Plan.

Call Today
Inside MA:
(508) 486-8929
Outside MA:
(800) 255-7814

CAD
Software, Inc.

119 Russell Street
Littleton, MA 01460

PC-BASED LOGIC SIMULATORS

Device capabilities are growing

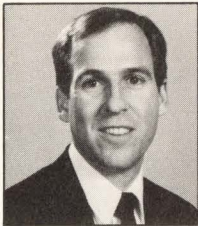

Improvements in hardware and software are making PC-based logic simulation an alternative to workstations and mainframes for small-and medium-sized designs.

Doug Conner,
Regional Editor

If you're already using a personal computer for CAD/CAE applications, you will find that you can use it for logic simulation as well. Before examining the details of PC-based simulation, it's worth looking at what simulation can offer you. Logic simulation software typically provides three types of simulation: functional, timing, and fault.

Functional simulation, normally the first step in verifying a design, checks the circuit's logic to see that it works the way you expect it to. Functional simulation typically uses unit timing delays instead of accurate timing models for component behavior. At the functional simulation level, you can find problems, such as inverted signals and improper sequential or combinatorial logic.

Once you've determined that the circuit executes the proper functions, you can concentrate on the timing simulation. Timing simulation makes more detailed demands of the simulator and the models used in the simulation. Therefore, accurate results require accurate models of the hardware.

Timing simulations often use gate-level representations. To simulate a circuit's operation more accurately, however, some designers use a switch-level representation, especially in IC design. Switch-level models represent the circuit at the

transistor level, giving a more accurate simulation of the electrical characteristics. However, not every simulator supports switch-level modeling (see Table 1).

Fault simulation is useful for test operations where you want to find stuck-at-one and stuck-at-zero faults. A fault simulation uses a set of test or stimulus inputs to check out a design, finding the percentage of cases where stuck-at-one and stuck-at-zero faults are detected. Fault simulations are often useful when developing IC test programs.

Before you can reap the benefits of logic simulation, you have to go through three steps: entering the design, obtaining models for the components, and generating a set of stimulus or test vectors.

The usual method for entering a design into a logic simulator is via a netlist that describes how the components in the circuit are connected. Simulators

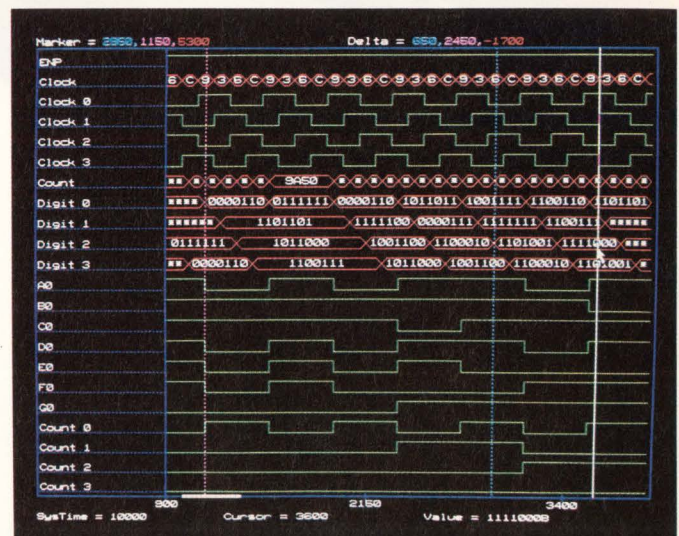

The logic-analyzer-type output display on OrCAD's VST simulator accommodates individual or bused signals. For bused signals, the display shows values in binary, octal, decimal, or hex. Cursors simplify timing measurements.

MEGA MEMORY.

SONY HIGH-DENSITY SRAMS				
MODEL	CONFIG.	SPEED (ns)	PACKAGING	DATA RETENTION
CXK581000P*	128K x 8	100/120	DIP 600 mil	L, LL
CXK581000M*	128K x 8	100/120	SOP 525 mil	L, LL
CXK581100TM*	128K x 8	100/120	TSOP	L, LL
CXK581100YM*	128K x 8	100/120	TSOP (reverse)	L, LL
CXK581001P	128K x 8	70/85	DIP 600 mil	L
CXK581001M	128K x 8	70/85	SOP 525 mil	L
CXK581020SP	128K x 8	35/45/55	SDIP 400 mil	
CXK581020J	128K x 8	35/45/55	SOJ 400 mil	

*Extended temperature range available. L = Low power. LL = Low, low power.

MEGA COMMITMENT.



As you can see, Sony's more committed than ever to meeting your high-density SRAM needs.

Just consider the enhancements we've made in a few short months: TSOP and TSOP-reverse packaging. Low data retention current. And extended temperature range.

All based on our unique 0.8-micron CMOS technology, and available in 32-pin DIP and surface-mount plastic packages.

Then consider our ever-increasing production capabilities. We've just added yet another SRAM facility in Japan. And acquired a large AMD facility in San Antonio, Texas.

So you can really count on us in a crunch. Need more proof we're serious about your each and every SRAM need?

Call us. We've got more breakthroughs on the way. Well over 100 SRAM products spanning the performance spectrum. And the desire to meet—or exceed—your toughest performance spec.

Sony high-density SRAMS are shipping now, complete with competitive pricing. So call (714) 229-4190 today. Or write Sony Corporation Of America, Component Products Company, 10833 Valley View St., Cypress, CA 90630, Attention: Semiconductor sales. FAX (714) 229-4285.

SONY®

TECHNOLOGY UPDATE

PC-based logic simulators

typically accept netlists from various schematic-capture software packages.

The simulator also needs component models to simulate what each component does, both functionally from a logic standpoint, and for timing characteristics if you are performing a timing simulation.

You need either to purchase model libraries that cover the devices you are simulating or develop your own models. Simulation vendors usually provide model libraries or offer them as an option. If they don't, you can often buy the libraries from third-party vendors.

Don't assume all the models that you need are available. When shopping for a logic simulator, check out the available model libraries carefully, unless you are planning to develop your own models. Although the functional characteristics of models are usually straightforward, timing characteristics can vary considerably in their accuracy.

The model may measure only average timing characteristics, or be able to measure minimum, maximum, and average timings. In addition, the model may or may not have accurate data concerning correct setup, hold, reset, and clock intervals.

Even if you plan to use models from existing libraries, you should be aware of the methods available for generating models yourself. Undoubtedly you'll run into cases where you cannot find a model, or perhaps you need to modify a model to look at special behavior.

Developing your own models

To build logic models, you typically use the logic-primitive models provided with the simulator. These primitives include basic logic functions, such as AND gates, OR gates, and storage functions. High-level primitives, such as D and JK flip-flops, latches, RAM, and ROM may also be available. In addition

to the logic functions, you need to know what timing constraints are included with the logic primitives.

For example, OrCAD's primitives have minimum and maximum gate delays. The storage primitives have setup and hold times and minimum clock-width parameters.

Building models up from primitives isn't the only way to develop your simulation. Behavioral or hardware description languages (HDLs) are another option on some simulators. For example, Viewlogic has an optional VHDL (VHSIC hardware description language) for modeling and simulation. Aldec's Mobic/T is a high-level IC modeling language for the company's Susie (standard universal simulation for improved engineering) series of logic simulators.

SimuCAD supplies the Silos behavioral modeling language for the company's Silos II logic simulator. You can use the modeling language to develop behavioral models that

Table 1—PC-based logic-simulation software

Manufacturer	Product	Libraries available ¹	Simulation levels	Computers supported	Price	Comments
Aldec	Susie 4	TTL ² , CMOS, ECL, memory, μ P, PLD, FPGA	Gate, behavioral	IBM PC/XT, PC/AT compatibles	\$995	Timing option \$1495
	Susie 5	TTL ² , CMOS, ECL, memory, μ P, PLD, FPGA	Gate, behavioral	IBM PC/XT, PC/AT compatibles	\$1495	Timing option \$2495 Virtual memory supported
	Susie 6	TTL ² , CMOS, ECL, memory, μ P, PLD, FPGA	Gate, behavioral	IBM, 386/486, compatibles	\$1995	Timing option \$3995 Virtual memory supported
OrCAD	VST	TTL ² , CMOS ² , ECL ² , memory ²	Gate	IBM PC/XT, PC/AT compatibles, P/S2	\$995	
SimuCAD	Silos II/386	7400 series ³	Switch, gate, behavioral	IBM, 386, compatibles	\$2500	Fault simulation Virtual memory supported
	MacSilos II	7400 series ³	Switch, gate, behavioral	Apple Macintosh II	\$2500	Fault simulation
	P/C Silos	7400 series ³	Switch, gate	IBM PC/XT, PC/AT compatibles	\$1000	Limited version \$400
Tanner	Gatesim	ASIC, FPGA, custom IC	Gate	IBM PC/XT, PC/AT compatibles	\$1295	Fault simulation Virtual memory supported
Viewlogic	Viewsim/SD	ASIC, TTL, ECL, CMOS, memory, FPGA, PLD, μ P third-party models also available	Switch, gate, behavioral	IBM, 386, PS/2 compatibles	\$7500 to \$19,000	Virtual memory supported VHSIC hardware description language available

Notes: 1. Optional unless otherwise noted.
2. Included in package.
3. Only available from third-party vendors.

TECHNOLOGY UPDATE

PC-based logic simulators

replace devices or blocks of devices in your simulation.

Behavioral or high-level description models let you design your circuit from the top down. The higher-level descriptions have faster simulation speeds than low-level descriptions, which can save development time.

Stimulus for the simulation

After you've entered the circuit's netlist and models for the components, the only remaining task is generating a set of stimulus or test vectors.

Developing stimulus vectors, and subsequently the correct response for them, is an important and potentially time-consuming part of the simulation process. The simulator can only help you verify whether a circuit design works properly by exercising the circuit simulation with input stimulus and knowing how the circuit should respond.

When developing test vectors, you typically need to concentrate on two different concerns. The first concern is making sure the circuit does everything it should do so that the design meets its specifications.

The second concern is to make sure the design doesn't do anything it should not do. For this you need to verify that the circuit behaves correctly with any legal input, and possibly with illegal inputs.

For example, if you are simulating a design for a circuit that receives its inputs from a bus, then you can test only the legal bus-cycle inputs and ignore what happens with illegal bus cycles. If you think illegal bus cycles will occasionally occur, you should test the circuit design for them. Although your design may not need to function properly with illegal bus cycles, you want to avoid a locked-up condition requiring a system reset. There-

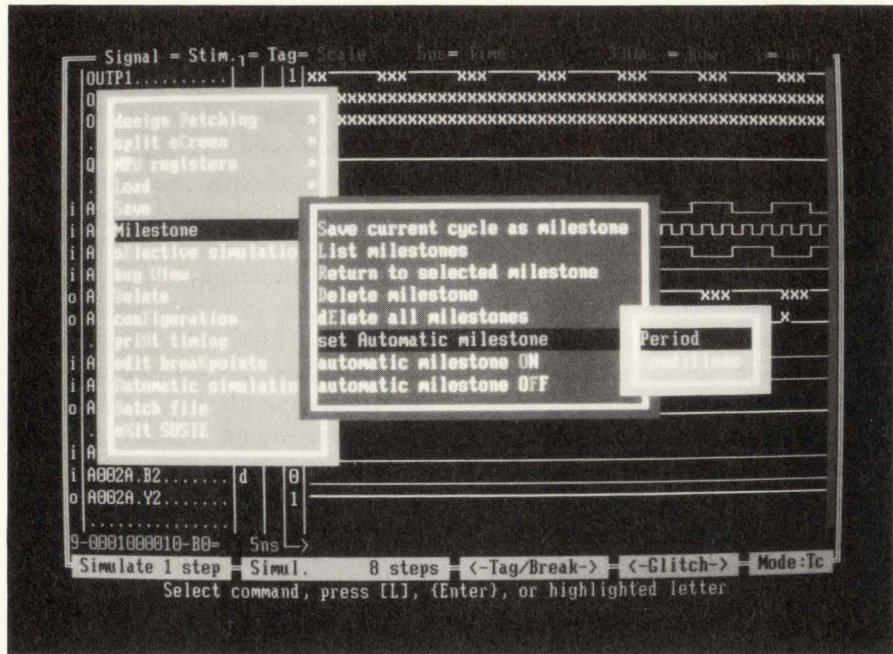

Pop-up menus make selecting different functions on Aldec's Susie series simulator easy.

fore, you need to generate the test vectors to check out potential problems.

Simulators typically let you generate test vectors using equations, tables, or a mouse. Aldec's Susie series lets you draw test vectors manually, using a mouse, or create them using equations. OrCAD's VST includes a pop-up editor for generating stimulus vectors that lets you define as many as 200 signals. You can generate clock signals in relative or absolute formats.

When you enter your design into the stimulus vectors, you are ready to run the simulation and see the results.

The usual format for simulator output is similar to a logic-analyzer timing display. The simulator presents the signal's state vs time or, in a bused format, it presents data states shown in binary, octal, decimal, or hex.

Simulators don't just leave you to hunt through these outputs for problems. They provide a variety

of tools to help you zero in on problems. For example, breakpoints are available on some of the simulators, such as VST and the Susie series. Breakpoints let you look for specific logic conditions occurring when you run a simulation.

Simulators can also look for certain errors automatically. Most will flag setup and hold time violations, minimum pulse-width violations, or bus-contention cases where two devices attempt to drive a bus simultaneously. Some simulators detect race conditions, oscillations, and spikes.

Help for finding bugs

When you run a simulation and see incorrect results, you need to find the source of the problem and fix the error. Something as simple as an inverted output won't take a master sleuth to find and correct. Other errors start much further back in the logic cycle and will take some careful backtracking to get from the point where you observed

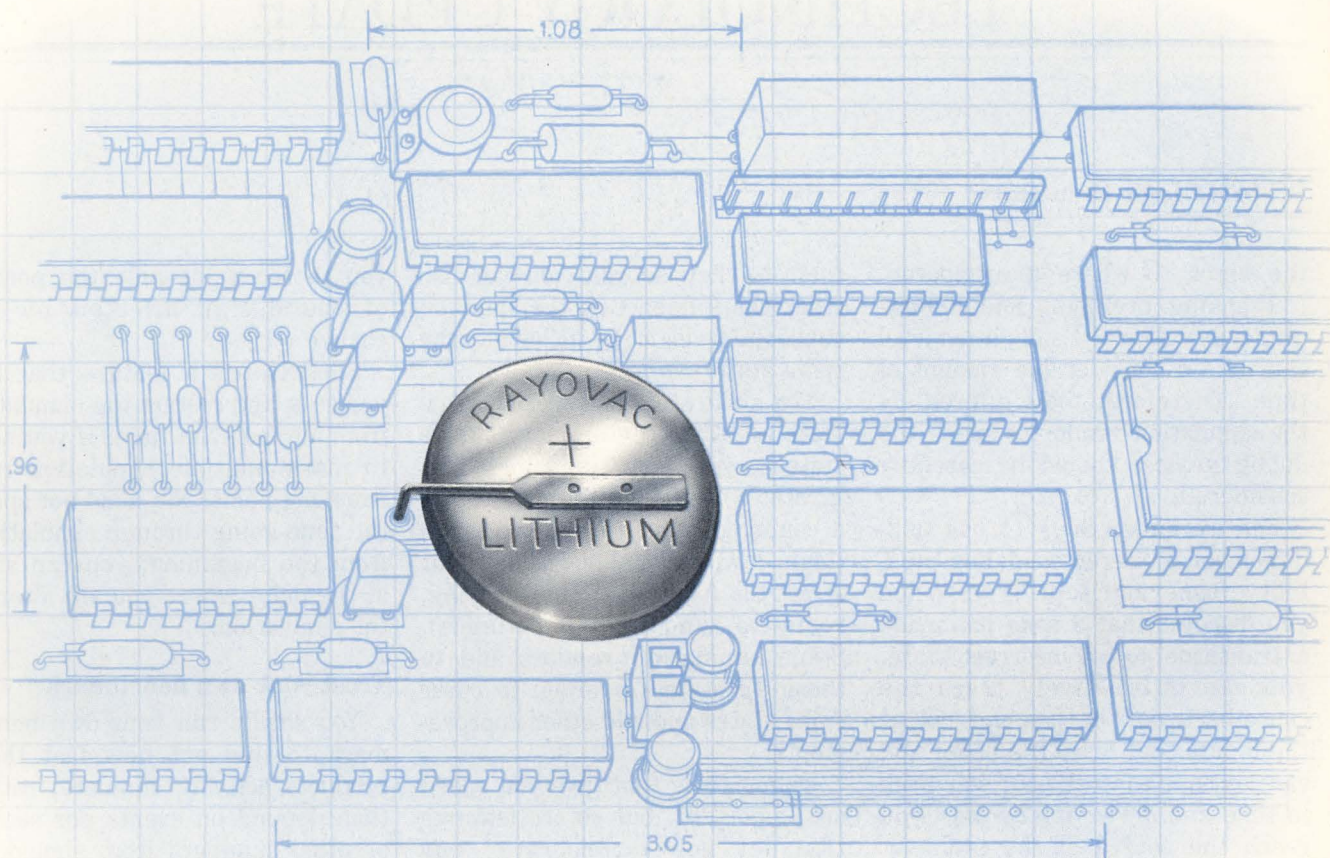

HOW MORE COMPANIES ARE ADDING LIFE TO THEIR DESIGNS.

Rayovac Lifex™ Coin Cells and Lifex FB™ Batteries have the highest reliability ratings in the industry. That's why major electronics manufacturers worldwide already specify Lifex in their product designs.

Rayovac reliability is especially valuable for critical memory applications, such as encryption codes, cash values, or control parameters.

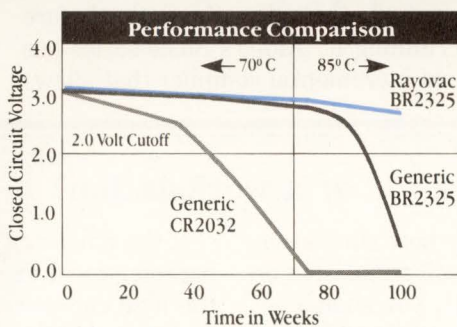

In high-temperature sustained storage, Lifex continues strong long after others fade away.

The Lifex FB offers extended temperature tolerance—operating comfortably in

a range of -40°C to $+100^{\circ}\text{C}$. And our products are made in the U.S.A., with on-time delivery available around the world.

So add longer life to your design. Specify a Rayovac Lifex Coin Cell or Lifex FB Battery in your design. Call Rayovac's Technical Sales & Marketing Department for complete information and battery specifications at 608-275-4694.

RAYOVAC®

TECHNOLOGY UPDATE

PC-based logic simulators

the error to where it originated.

Tracking problems and debugging a design at the simulation level can take a considerable amount of time. Therefore, tools offered by the simulation vendor to speed the debug process should be carefully considered.

For example, Silos II has a 2-dimensional interactive debug capability (time and topology). When you discover that a node has made a transition to an incorrect state, you can interactively trace the cause backward in time and look at the inputs that drive the node. You can continue to work your way back in time and device inputs until you reach the source of the problem. You can also trace node outputs to forward destinations.

Silos II also supports spike simulation. A spike occurs when two or more edge transitions arrive at a device's input and the edges are spaced closer to each other in time than the propagation delay of the device, causing a state change in the device. Instead of swallowing the spikes, the simulator makes them visible, allowing you to trace

them to their source. You can also track the influence of the spike on subsequent logic by following the spike state.

The spike state is a special signal state added to the ordinary twelve states covered by simulators. The 12 states are typically made up of a combination of three logic levels (high, low, and unknown) and four strengths (supply voltage, driving, resistive, and high impedance). Some simulation vendors add to these 12 states in order to cover spike states and add other improvements.

Debug tools that give you speed are important, but so are features that let you incorporate your changes and resimulate quickly. A simulator that is well integrated with a particular schematic-capture software package allows you to change the schematic representation and immediately resimulate with the changes in the design.

You also save time if, after making changes, you don't have to recompile the entire simulation before running it. Aldec's Susie series has an incremental compiler that allows

you to recompile only the portion of the design affected by the change.

Silos II has a feature that lets you save and restart the simulation from any point in time. If you need to make multiple simulation runs from one point, you need not spend the time going through simulations from the beginning; you can start at the point where you are altering the simulation.

Trust your own benchmark

You should run your own benchmark to find out how fast these products actually simulate, rather than depend on events per second or other numbers from simulation vendors. The events per second quoted by simulation vendors are not all equivalent. Furthermore, some vendors quote simulation speed by stating a design with X gates and Y stimulus vectors will run in a given amount of time, but that speed depends on how the gates are connected and how the simulation vectors exercise the design. If you run your own simulation benchmarks on simulation soft-

Should you simulate on a PC or a workstation?

Designers sometimes want to know how simulation on personal computers compares with simulation on workstations and mainframes. First, you should note that two of the companies with PC-based simulation (SimuCAD and Viewlogic) also offer simulation products for workstations and mainframes. The software is essentially unchanged, regardless of the computer.

High-end PCs, such as 386- and 486-based computers and Apple Macintosh IIs, are approaching low-end workstation performance. Provided the systems have equivalent amounts of memory, you should get logic-simulation performance close to a low-end workstation.

If the efficiency of the simulation software is comparable, you'd expect greater simulation speed on the high-end workstation than on a high-end PC. Simulation software vendors whose products run on high-end workstations or mainframes like to point out that *their* customers aren't even happy with the speed of simulation on these high-speed computers. Designers simulating large designs will often turn to hardware accelerators to speed simulation.

If you're performing a timing simulation on a 50,000+ gate circuit, you'll probably find a PC-based simulator slow, even if the circuit fits. However, you shouldn't let that discourage you from using a PC-based simulator on smaller designs.

WE'RE CHANGING THE WAY THE WORLD LOOKS AT MOTOR DRIVERS

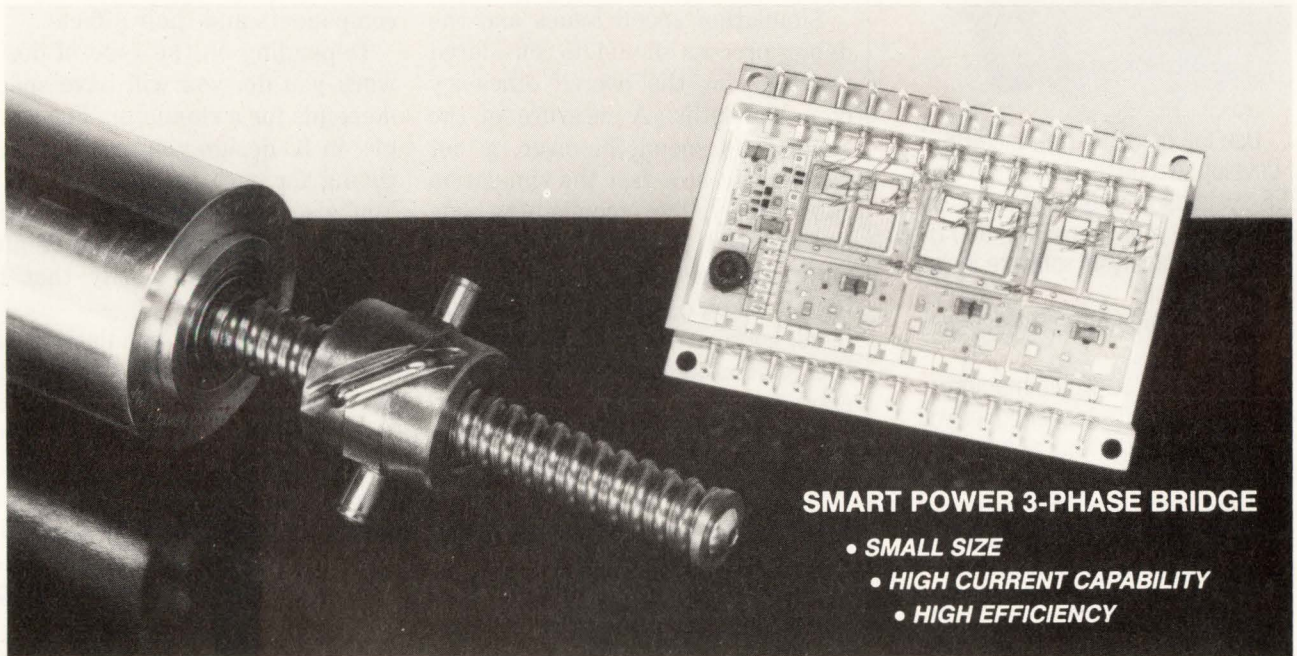

SMART POWER 3-PHASE BRIDGE

- SMALL SIZE
- HIGH CURRENT CAPABILITY
- HIGH EFFICIENCY

Motor Courtesy of Inland Motor, Kollmorgen Corporation.

That's right! The world is changing with the introduction of the PWR-82331, DDC's new family of motor drive products.

The PWR-82331 30A, 200V, 3-Phase bridge power hybrid consists of six N-channel power MOSFETs and six anti-parallel fast recovery diodes connected into a full 3-Phase bridge driver. Each MOSFET bridge is driven directly from a CMOS input through high and low side drivers without the need for external bias voltages.

Internal protection circuitry prevents in-line transistors from simultaneous conduction, but allows for multiple upper or lower conduction for sine drive or dynamic braking. A constant voltage drive to control

the MOSFETs is used to ensure uninterrupted performance of the drivers even in a motor stall situation — performance that cannot be achieved when a boot-strap configuration is utilized.

The PWR-82331 has its own built-in power source which supplies all the required internal biasing and logic supplies. The Vb input to the internal supply can either be hooked directly to the Vcc pin or to an additional external power source.

This highly efficient bridge uses all N-channel MOSFETs to ensure a very low on-resistance of 0.11 Ohm per leg and 50ns fast recovery power rectifiers to clamp inductive flyback. The PWR-82331 is packaged in a thermally efficient copper case with a

typical junction-case thermal resistance of 0.5° C/W and measures only 2.1"W x 3.0"L x 0.375"H. This hybrid is designed to operate from -55°C to +125°C case temperature.

The PWR-82331 can be driven directly from the commutating logic and when combined with a pulse width modulator creates a Servo Motor Controller, which after proper derating, can drive motors up to 6 hp over the full MIL temperature range.

In addition to the PWR-82331, DDC has introduced the PWR-82340 which is a 2-phase version.

For additional product and application information, contact Bob Fryer at 1-800-DDC-1772, x 390, or contact the DDC office nearest you. □

DDC
ILC DATA DEVICE CORPORATION

HEADQUARTERS AND MAIN PLANT: ILC Data Device Corporation, 105 Wilbur Place, Bohemia, NY 11716, (516) 567-5600, TLX: 310-685-2203, FAX: (516) 567-7358, (516) 563-5208
WEST COAST (CA): GARDEN GROVE, (714) 895-9777, FAX: (714) 895-4988;
 WOODLAND HILLS, (818) 992-1772, FAX: (818) 887-1372; SAN JOSE, (408) 236-3260, FAX: (408) 244-9767
WASHINGTON, D.C. AREA: (703) 450-7900, FAX: (703) 450-6610
NORTHERN NEW JERSEY: (201) 785-1734, TLX: 130-332, FAX: (201) 785-4132
UNITED KINGDOM: 44 (635) 40158, FAX: 44 (635) 32264
FRANCE: 33 (1) 4333-5888, FAX: 33 (1) 4334-9762
GERMANY: 49 (8191) 3105, FAX: 49 (8191) 47433; **SWEDEN:** 46 (8) 920635, FAX: 46 (8) 353181
JAPAN: 81 (3) 814-7688, FAX: 81 (3) 814-7689; **IRELAND:** 353-21-963440, FAX: 353-21-963475

Analyzer488 Benchtop or PC operation.



Use the compact Analyzer488 to develop, debug, and optimize your IEEE systems from the benchtop. Or connect it to your PC or PS/2 and use the powerful analysis software included with the unit.

Only the Analyzer488 lets you do both.

The built-in 32 Kbyte memory and comprehensive triggering let you capture bus transactions at a full 1 Mbyte/sec. And because the memory is non-volatile you can transport the Analyzer488 to your PC for further analysis and save the data to disk.

All for a surprisingly low \$1,795.

Call today for your free Technical Guide to the Analyzer488 and other IEEE 488 products from IOtech: 216-439-4091.

IBM PC, AT, 386, and PS/2 IEEE Products

Macintosh IEEE Products

Sun and DEC Workstation IEEE Products

Serial/IEEE Converters and Controllers

Analog and Digital I/O Converters to IEEE

IEEE Analyzers, Converters, and Extenders

IOtech, Inc. • 25971 Cannon Road
Cleveland, Ohio 44146
PHONE 216-439-4091 • FAX 216-439-4093

CIRCLE NO. 4

TECHNOLOGY UPDATE

PC-based logic simulators

ware you are considering, you'll have meaningful results and you'll know more about what the simulator can do.

Simulation speed issues and the debug process should be considered together for the overall efficiency of a simulator. A measure of the simulator's speed, however, is not necessarily how fast the simulation runs after you've compiled the code and started the simulation. What you really need to know is how long it will take to simulate, find problems, correct them, and verify that the simulated design works properly.

The best measure for determining whether a particular logic simulator will work in your application is to try some circuit examples that gave you trouble in the past. If the simulator can find problems that you didn't discover until you had hardware, then the simulator shows promise of saving you time and money.

Some of the problems designers typically have to look for are setup- and hold-time violations and clock

setup violations, such as the end of a reset pulse to the beginning of a clock cycle on a flip-flop. You might also be trying to detect glitches on components and their effects.

Depending on the type of design work you do, you will have special demands for a simulator. For example, in IC design you need different timing for each instance of a gate. You also need to transfer routing delays back to the simulator after physical layout to verify that the timing still works.

Most PC-based simulation software vendors have free or nominal-cost demo software that you can obtain to try out simulation. The packages have limitations either in design size or other features, but they will give you a start in evaluating the products for your applications.

EDN

Article Interest Quotient
(Circle One)

High 515 Medium 516 Low 517

For more information . . .

For more information on the logic-simulation products discussed in this article, circle the appropriate numbers on the Information Retrieval Service card or use EDN's Express Request service. When you contact any of the following manufacturers directly, please let them know you saw their products in EDN.

Aldec
3525 Old Conejo Rd, #111
Newbury Park, CA 91320
(805) 499-6867
FAX (805) 498-7945
Circle No. 720

SimuCAD
32970 Alvarado-Niles Rd,
Suite 744
Union City, CA 94587
(415) 487-9700
FAX (415) 487-9721
Circle No. 722

Viewlogic Systems
293 Boston Post Rd W
Marlboro, MA 01752
(508) 480-0881
FAX (508) 480-0882
Circle No. 724

OrCAD
3175 NW Aloclek Dr
Hillsboro, OR 97124
(503) 690-9881
FAX (503) 690-9891
Circle No. 721

Tanner Research
444 N Altadena Dr
Pasadena, CA 91107
(818) 795-1696
FAX (818) 795-7937
Circle No. 723

For Versatile VME Solutions... Turn to SBE

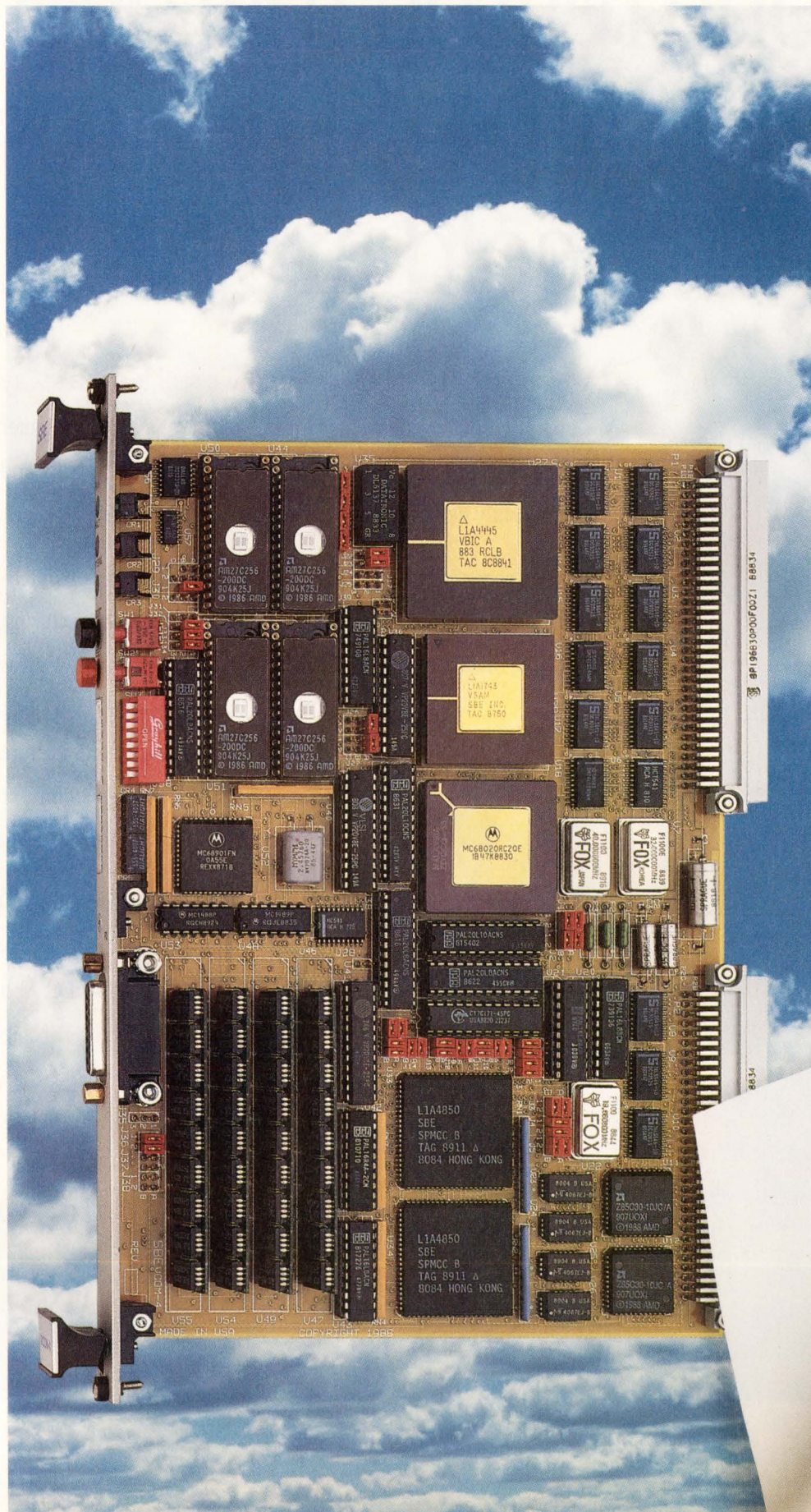

You need a wide variety of versatile VME solutions. You need the capability to customize standard configurations. You need software and support. You need SBE.

SBE's commitment to providing solutions for your OEM needs can be found in every SBE VMEbus product—VMEbus interface chips, single-board computers, high-performance communications controllers, and VMEbus systems integration solutions.

SBE VMEbus boards are designed to address a broad range of real-time data processing, control and data communications applications. All are modular, offering I/O and memory expandability. This includes the VPU-25 68020-based IndustryPack* engine with over 20 different I/O expansion modules, including D/A, latching relays, and a custom interface design kit.

And, we offer VMEbus products with a full software support program: board support packages for the popular real-time kernels, TCP/IP for the VLAN-E Ethernet LAN controller, and X.25 available on the VCOM-4 high-speed multiprotocol serial communications controller.

Plus... comprehensive documentation and prompt engineering response for your specific OEM requirements.

For over 10 years, major companies have turned to SBE for versatile solutions. You can, too. Contact SBE, Inc., 2400 Bisso Lane, Concord, CA 94520, or call 1-800-347-COMM for more information.

*IndustryPack is a trademark of Greenspring Computers, Inc.

Here's one reason that over half of all SCSI devices sold are NCR.

We created the market... and we still lead the way.

Meet NCR's SCSI development team. In 1983, they gave the computer industry its first SCSI device. By providing easy connectability and significantly reducing time to market, a new product era was born.

Since then needs have changed. By combining our system skills, high-performance standard cell methodology, and in-house manufacturing, NCR has maintained its leadership role with innovative new ideas

like the 53C700 product family. And the joint development of LADDR — a new architecture aimed at cutting the development time of OS/2 device drivers by 90%.

Today SCSI is becoming the leading I/O standard — adopted by industry giants like Apple, IBM, HP, and DEC. And no one is selling more SCSI chip level products than NCR. In fact, no one even comes close.

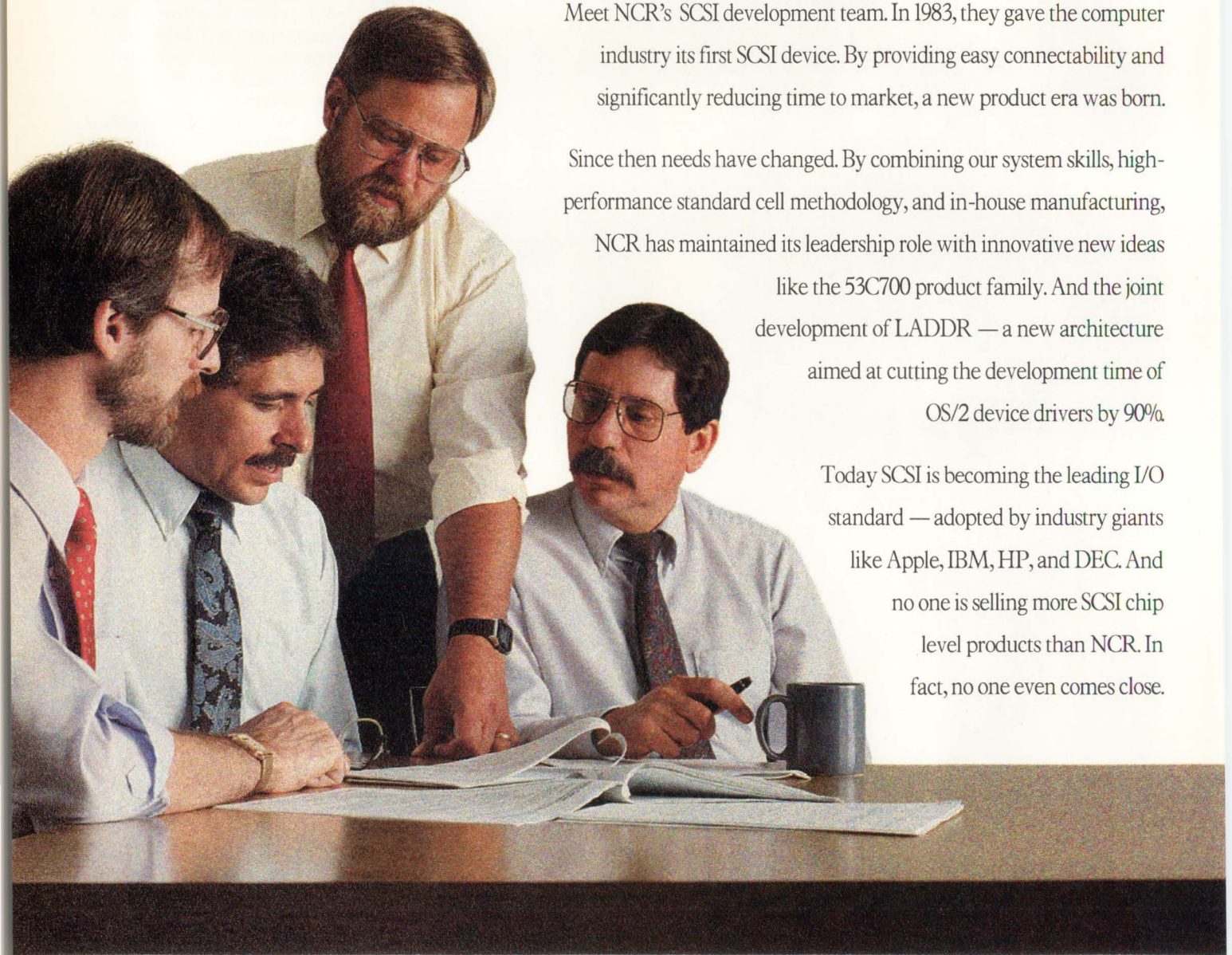

Part of the NCR SCSI Development Team: (left to right) **Jerry Armstrong**, Sr. Software Engineer; **Harry Mason**, Strategic Marketing Manager; **John Lohmeyer**, NCR Sr. Consulting Engineer and Chairman of the ANSI X3T9.2 Committee and **Dave Skinner**, SCSI Product Manager.



North American Sales Headquarters
1731 Technology Drive, Suite 600
San Jose, CA 95110
(408) 453-0303

Here's another.

The NCR 53C700 SCSI I/O Processor...
So good, *Electronic Design* named it the
product of the year.

"You can't tell a good SCSI chip just by looking at it..." and according to *Electronic Design*, NCR's 53C700 is the best there is.

The only third generation SCSI device on the market today, it concentrates all the functions of an intelligent SCSI adapter board on a single, smart and extremely fast, chip... for about 15% of the cost.

As the first SCSI I/O processor on a chip, the 53C700 allows your CPU to work at maximum speed while initiating I/O operations up to thousands of times faster than any non-intelligent host adapter. DMA controllers can burst data at speeds of up to 50 Mbytes/s. This new chip cuts down system time hookup to a fraction of what it has been.

Those are just a few of the reasons *Electronic Design's* "Best of the Digital IC's" award went to NCR's 53C700 last year.

And now the NCR 53C710!

For the complete story on the NCR SCSI product line featuring the new 53C710, as well as the upcoming SCSI seminars with the NCR SCSI Development Team, please call:

1-800-334-5454



NCR

Creating value

CIRCLE NO. 53

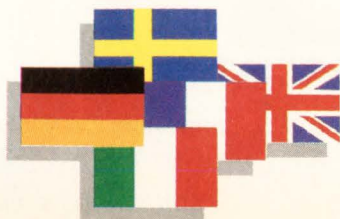

European Sales Headquarters

Gustav-Heinemann-Ring 133
8000 Munchen 83
West Germany
49 89 632202

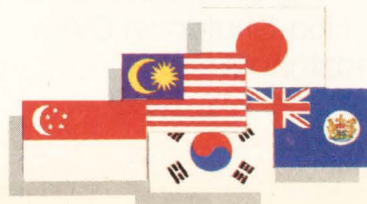

Asia/Pacific Sales Headquarters

2501, Vicwood Plaza
199 Des Voeux Road
Central
Hong Kong
825 859 6044

WORLD'S MOST ADVANCED DC-DC CONVERTER

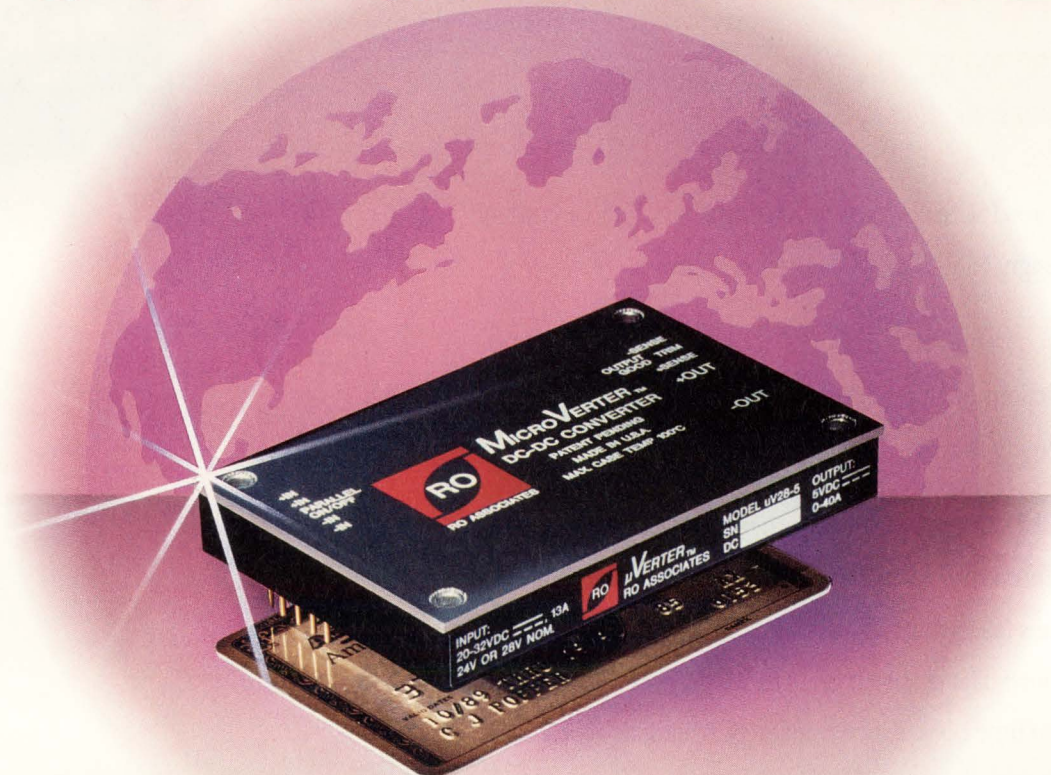

INTRODUCING THE 250 WATT MICRO-VERTER™ NEW HIGH DENSITY PACKAGE WITH A NEW STANDARD OF EXCELLENCE

Up to 58 Watts/in.³ ■ Miniature size:
0.5" x 2.4" x 3.6"(singles), 0.5" x 2.4" x 4.6"
(triples) ■ Single Outputs: 5V @ 40A, also
12, 15, 24, 28V ■ Triple Outputs: 5V @ 35A
and ±12V or ±15V @ 3A ■ 28 VDC input
per MIL-STD 704D ■ Constant Frequency
Operation ■ Current Sharing AND True
N+1 Redundancy ■ Paralleling WITH
Current Sharing ■ Hot Plug-in Capability
■ Optional Power Good Signal ■ Optional
Synchronization Pin ■ Non-Shutdown OVP
■ Logic on/off ■ Thermal/input OVP
protection ■ Ruggedized per MIL 810D
(Patent Pending)

Call or fax today for a free brochure.



RO ASSOCIATES

246 Caspian Dr., P.O. Box 61419, Sunnyvale, CA 94088
Phone: 408/744-1450

Fax: 408/744-1521

TIMING-DIAGRAM DESIGN TOOLS

Front-end tools reduce schematic drudgery

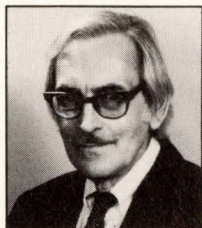

You can't draw a schematic until you find which timing requirements are critical. A new breed of computer tools takes the pain (and the pencil) out of this task.

Chris Terry,
Associate Editor

Digital logic designers constantly live on the edge. They are on the edge of a critical waveform until they know it will satisfy complex timing requirements; on the leading edge of technology if their design works correctly; on the trailing edge of disaster if they miscalculate by a few crucial nanoseconds and the product has to be recalled. Engineers spend many hours (as much as 75% of the design phase) drawing timing diagrams, analyzing the circuits these diagrams represent, and calculating the potential effect of component changes at point A on timing tolerances at point B many gates downstream.

You may draw a skeletal schematic while you're working out the timing, but until you know the mutual dependencies of the waveforms, you're in no position to specify the component and IC part numbers that a schematic-capture tool will demand of you. So you take your colored pencils and you draw . . . and you draw . . . and you redraw . . . until the schematic comes out right. It's a repetitious, tedious, and frustrating task. If you make a nasty mess with the eraser, the documentation people may displace a signal edge by a significant amount. If you're tempted not to follow a dependency all the way through the many sheets of the diagram, the components'

manufacturing tolerances may combine to make your design unreliable. Creating the final timing diagram is dogwork that often makes you wonder why you ever wanted to be an engineer.

In these days of computer-aided this and computer-aided that, why can't the computer do the dogwork? After all, that's what computers are for, isn't it?

The trouble is that CAE tool designers have so far been busy with the back

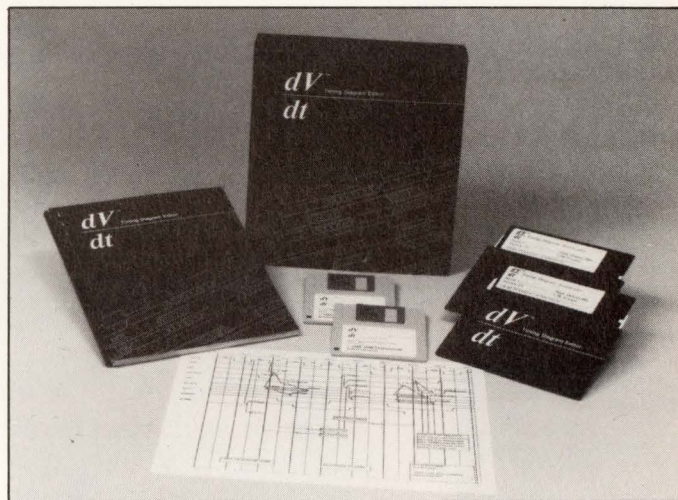

This timing-diagram accelerator (dV/dt) reduces the time you spend on drawing and redrawing complex timing diagrams. It lets you set propagation delays, verify requirements, and measure time between signal edges.

end of the design. Many board-design tools include a timing simulator that will analyze your captured schematic and use the device characteristics of the automatically placed components to run checks against your design rules. For high-speed boards, some simulators will analyze the schematic and the layout to check for undesirable transmission-line effects.

However, these simulators all require

The F80 Programmable Filter

Another exciting episode of mission impossible.

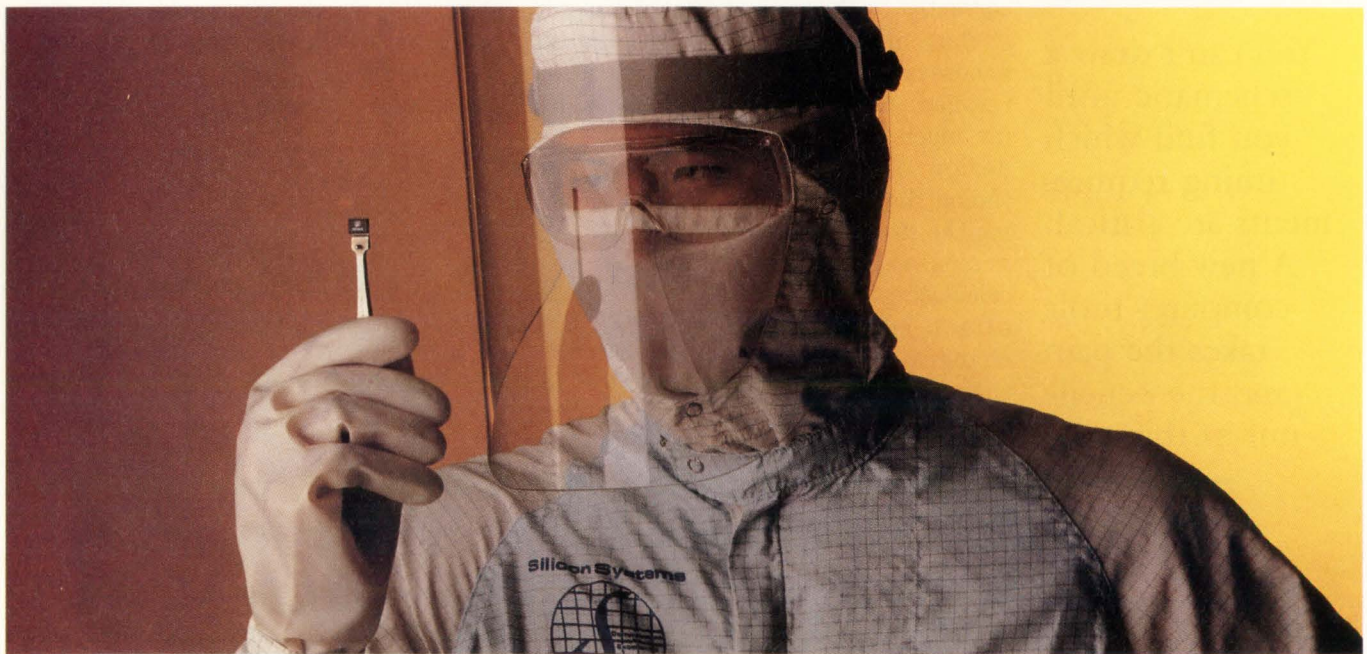

Many said it was impossible. Create a truly programmable filter that lets you skip over do-it-yourself passive-filter design and do away with many external components.

Well, they were wrong. Our F80 Series of Programmable Low Pass Filters do it dramatically. It's a real breakthrough that lets you program channel bandwidth from 5-13 MHz. Continuously. And easily. It lets you program on the fly and fully realize the potential of constant density

Circle #39 for Product Information

recording.

It's here. The F8011. One of a family of customizable filters designed for a variety of custom applications. It requires only a +5V power supply and reduces the costs and time associated with what had been one of the most engineering-intensive tasks in electronics design.

Whether you're designing hard disk drives, LANs, cellular telephone systems, radar systems or whatever, your next mission is to contact your nearest

Circle #38 for Career Information

Silicon Systems representative or distributor. Or call us for literature package SPD-4.

Silicon Systems, Inc.

14351 Myford Road, Tustin, CA 92680
Ph 1-800-624-8999, ext. 151 Fax (714) 669-8814
European Hdq. U.K. Ph (44) 79-881-2331
Fax (44) 79-881-2117

silicon systems[®]

TECHNOLOGY UPDATE

Timing-diagram design tools

that the schematic-capture, layout, and routing phases be complete. They can only verify your work on the waveform diagrams—they're not a substitute for that original work. They will flag timing violations—but then what? You have to go back to the start, either changing device types or modifying the schematic to correct the error. Then you run the simulation over again and hope that your changes have not caused more or different timing violations. These computerized iterations can take as much time and cause as much frustration as manual methods. You may find yourself drawing and redrawing timing diagrams by hand before you draw the schematic just so the simulator will give your design a clean bill of health the first time around.

Cavalry to the rescue

Two companies have turned their attention to the front end of the design phase and offer timing-diagram design tools that will help you solve your timing problems (*without* paper and pencils). Chronology Corp's Timingdesigner costs \$1495 and runs on IBM PC/ATs and compatibles under Microsoft Windows 3.0. Doctor Design Inc's dV/dt Plus also runs on IBM PC/ATs and compatibles—with at least 1M byte of extended memory and DOS version 3.0 or higher—and costs \$795. Doctor Design also offers a Macintosh version of dV/dt for \$695.

Doctor Design Inc has—perhaps too boldly—trademarked a commonly used expression, “dV/dt,” so you can expect another spate of physicist/mathematician jokes at the expense of engineers. Engineers have always been stuck at the bottom of the academic totem pole. Witness the mathematician's definition: “An engineer's a guy who uses a slide rule to multiply 2 by 2, gets the answer to 3.95, and then decides to approximate and call it 4.”

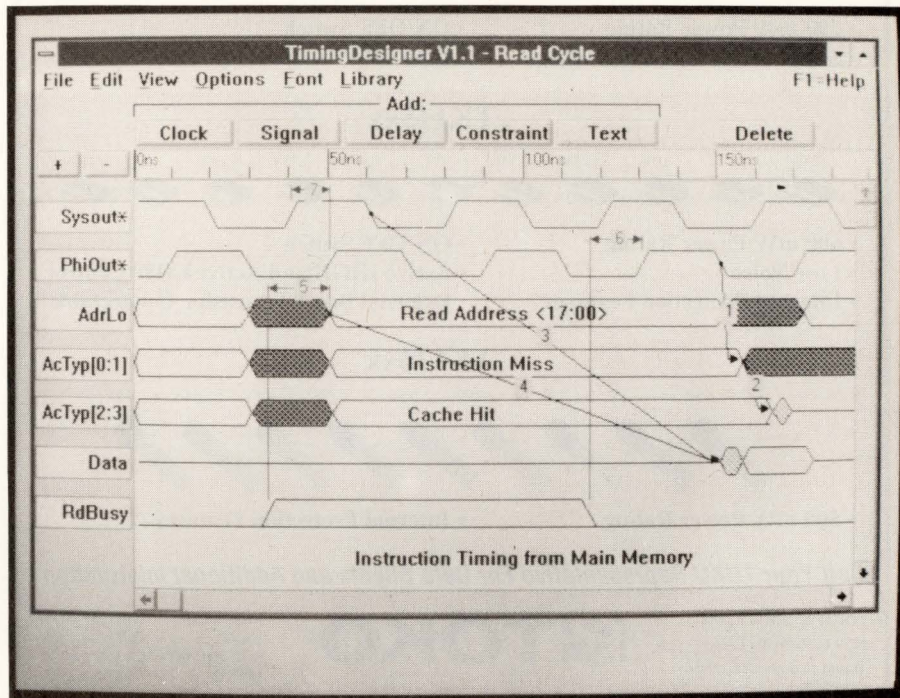

Timingdesigner lets you specify constraints and uses color to highlight violations of your design rules.

And a physicist was recently overheard saying about dV/dt: “It’s a real nifty program, but if that’s the best they can do for a name, maybe they should have stuck to designing doctors.”

Dismissing quibbles about naming, both of these programs are valuable tools that can save you hours of drudgery. Indeed, they constitute an innovative breakthrough in a CAE world, which for

several years has been refining known techniques rather than developing anything really new.

The programs offer similar facilities. You can enter duty-cycle, duration, phase, and jitter parameters for the clock. The clock generator then automatically generates clock signals throughout the diagram. You can also enter IC constraints such as setup, hold, or minimum pulse width, and the built-in ana-

For more information . . .

For more information on the timing-diagram editors discussed in this article, circle the appropriate numbers on the Information Retrieval Service card or use EDN's Express Request service. When you contact any of the following manufacturers directly, please let them know you saw their products in EDN.

Chronology Corp
2849 152nd Ave NE
Redmond, WA 98052
(206) 869-4227
FAX (206) 869-4229
Circle No. 725

Doctor Design Inc
5415 Oberlin Dr
San Diego, CA 92121
(619) 457-4545
Circle No. 726

VOTE . . .

Please also use the Information Retrieval Service card to rate this article (circle one):

High Interest 488
Medium Interest 489
Low Interest 490

NEW!

LOW DROPOUT REGULATORS

NEW!

TK114xx



- 200 mW Power Rating
- Super Small SOT23L Package
- ON/OFF Switch
- Internal Protection Features

TK115xx



- 600 mW Power Rating
- Low Noise
- Internal Protection Features
- ON/OFF Switch
- Active HIGH and Active LOW Control
- External Boost Transistor Connectable

TK116xx

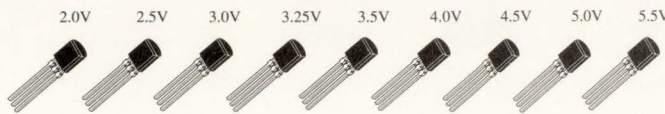

- 500 mW Power Rating
- Internal Protection Features

Call Your TOKO Representative For Data Sheets and Additional Information

TOKO AMERICA, INC.
1250 Feehanville Drive
Mount Prospect, IL 60056



MIDWEST: (708) 297-0070
EAST: (203) 748-6871
SOUTHEAST: (205) 772-8904
WEST: (408) 432-8281

CIRCLE NO. 5

Why it takes legwork to flatten your stomach

You can't reduce stomach fat by exercising abdominal muscles alone.

Research has shown that exercises that work only the abdominal region are not effective. They simply don't involve enough muscle mass to burn the calories necessary to trim fat. Instead of flattening, they merely strengthen underlying muscles, providing no reduction in girth, fatfolds, or total body fat percentage.

The exclusive NordicTrack® total-body aerobic exerciser is the most effective way to flatten your stomach.

The total-body motion involves *all* major

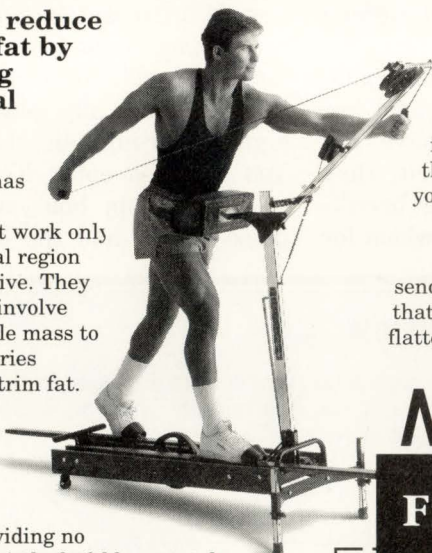

body muscles. Which means you burn more body fat in less time than with any other in-home exercise machine. And while you're at it, you're toning and defining those muscle groups, as well. So you feel as good as you look.

Free information.

Call or write us today. We'll send you a free brochure and video that describe how NordicTrack can flatten your stomach and make you look and feel your best.

NordicTrack®
A CML Company

Call or Write for a
FREE VIDEO
& Brochure

1-800-328-5888 EXT 144B1

- Please send me a free brochure
 Also a free videotape VHS Beta

Name _____
Street _____
City _____ State _____ Zip _____
Phone () _____

NordicTrack, Dept. #144B1
141 Jonathan Blvd. N. Chaska, MN 55318

UPDATE

Timing-diagram design tools

lyzer will highlight any violation of these constraints. You can display signal edges with minimum/maximum uncertainty, computed either on the basis of the known characteristics of standard library parts, or on the basis of variables such as temperature or voltage.

Both programs let you save, retrieve, and print timing-diagram files, so now you can provide accurate diagrams in a form suitable for incorporating into your design documentation. You won't have to risk the potential errors of redrawing rough sketches. The Macintosh version of dV/dt can output the diagrams to any "chooser-selectable" Mac printers, and dV/dt Plus works with all Epson MX series and HP LaserJet series printers. Timing-designer will work with hundreds of printer, plotters, graphics cards, and monitors through Windows' device drivers.

If you're a Macintosh user, dV/dt is currently your only choice. If you're a PC/AT user running Windows 3.0, Timingdesigner will probably give you the best performance. But if you don't run Windows 3.0, then dV/dt Plus in the DOS environment will still let you jettison those pencils, scrap sheets, and napkins. **EDN**

Article Interest Quotient
(Circle One)

High 488 Medium 489 Low 490

READ ON IN EDN

To find out why more and more engineers are eschewing 5¼- and 8-in. drives in favor of 3½-in. units, turn to this issue's Special Report.

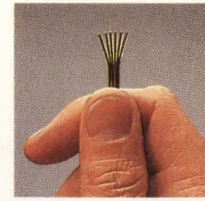
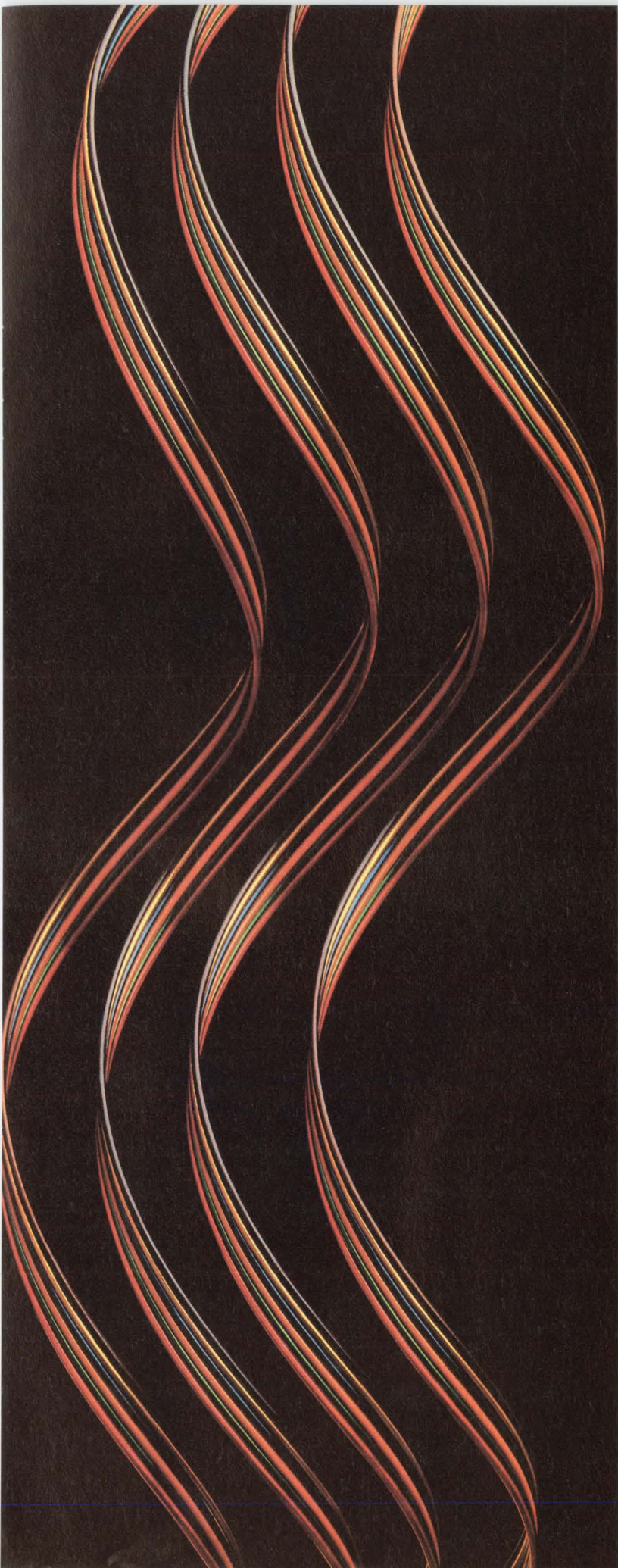

MULTIFILAR[®]

MAGNET WIRE

Parallel bonded for windings and leads.

When two or more magnet wires travel together, MULTIFILAR magnet wire is an excellent alternative.

This parallel bonded, color-coded magnet wire offers more consistent capacitance and impedance characteristics when compared to windings using two or more separate magnet wires.

And, it allows for increased layer winding speeds, as well as reduced labor and handling. Color-coding assists in conductor identification and helps eliminate termination errors.

MULTIFILAR magnet wire is custom produced to guarantee flat, parallel construction in an array of sizes, 16–52 AWG, with up to 20 conductors in some sizes.

Available constructions include round, flat or square conductors. Individual conductors meet NEMA MW 1000, JW 1177, temperature classes 105–220°C; single through quadruple film builds. Color-coded conductors are available in most insulations with up to 10 different colors in some sizes.

Call or write for your free copy of our new Technical Data and Capabilities Brochure. It contains valuable information on all wire produced and inventoried by MWS Wire Industries. Samples of MULTIFILAR are available upon request.



MWS

Wire Industries

31200 Cedar Valley Drive, Westlake Village, CA 91362

CALL TOLL FREE 800 423-5097

818 991-8553 FAX 818 706-0911

MULTIFILAR is a trademark of MWS Wire Industries

CIRCLE NO. 51

A true leader



The UNIX based DECstation™ 5000 Workstation

leads by example.

Example #1: Performance

No matter how you measure it, Digital's DECstation 5000 workstation leads all others in performance. Whether it's raw CPU performance, 2D or 3D graphics speed, or price/performance, the DECstation 5000 workstation comes out ahead. In fact, for overall performance, nothing else is close. And we've got the numbers to prove it.

PERFORMANCE COMPARISON CHART (1)	SUN SPARCstation 1+	IBM 320/520	DECstation 5000 cx
Graphics & Windowing (2)	0.24	0.71	1.59
Integer	1.04 (3)	1.34	1.61
Floating Point	1.10 (3)	2.6	1.7
Overall Performance	0.65	1.35	1.63

(1) All data normalized to DECstation 3100. Comparable configurations tested. Geometric mean used to combine results. Performance will vary depending on applications and environment. (2) Graphics and windowing data measured using X11perf benchmark. CPU Integer and Floating Point performance measured from running SPEC V1.0 workload. (3) SPEC performance estimate based on SUN 4/330 results published by Sun Microsystems, Inc.

Example #2:

UNIX based Applications

When you run with the leader, you know you're in good company. The DECstation 5000 workstation runs more than 1,500



UNIX based applications, including the industry's most popular MCAD and EDA applications.

Example #3: PowerFrame™ for Design Integration.

With Digital's PowerFrame design framework, you can easily integrate the DECstation 5000 workstation with your existing UNIX based EDA and MCAD systems. PowerFrame is the most widely

used framework for heterogeneous design management.

And, of course, as the leader in integrated multi-vendor

networked computing, you can count on Digital for full service and support. We can help you design, implement and maintain an engineering computing strategy that capitalizes on today's technol-

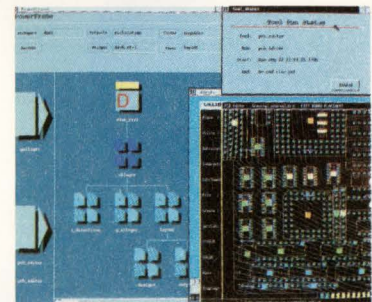

ogy, while keeping your options open for the future.

For your copy of benchmark test results and a list of available applications, call 1-800-343-4040, ext. 970. These are filled with examples of what you expect from a leader.

Digital
has
it
now.

Specs for Hard Drivers.



Maxtor 7080

Simplicity of design makes Maxtor's Cheyenne Series inch-high 80MB 7080 disk drive the most reliable in its class. Compare Maxtor's four-head, two-platter design to Seagate's six-head, three-platter design. Fewer moving parts make Maxtor's drives inherently more dependable.

Power consumption is a very low 2.8 watts, making it one of the lowest in the 80MB class. The 7080 is also Novell Labs certified, and is available with either SCSI or AT interface, giving you flexibility for a winning system.

Exceptionally fast 17ms seek time and 32K cache buffer in the new generation inch-high form factor give Maxtor faster data throughput than the competition.

Call and ask about our entire Cheyenne family of disk drives with capacities from 40MB to 130MB. Don't fall for the off-the-wall claims. Give us a shot and we'll prove Maxtor specs can't be matched. **Call your nearest Authorized Maxtor Distributor.**

3.5-inch Disk Drive Spec.	Maxtor 7080A	Seagate 1102A
Seek Time	17 Msec.	19 Msec.
Standard Buffer Size	32K	8K
Form Factor	3.5" x 1"	3.5" x 1.6"
Heads-Disks	4/2	6/3
Avg. Power Consumption	2.8 watts	9 watts

We Drive Harder.
Maxtor®

© 1991 Maxtor Corporation



Call Your Authorized Maxtor Distributors

A.D.P.I.

1-800-275-2374
301-258-2744

Anthem Electronics
408-452-2287

Arrow Commercial Systems Group
1-800-323-4373

Arrow/Klerulff
1-800-777-2776

Avnet Computer
1-800-422-7070

B.S.M./Business Solutions in Micro
1-800-888-3475
214-699-8300

Cal Abco
818-704-9100
800-669-2226

Compac Micro Electronics
1-800-426-6722
415-656-2244

Computer Brokers of Canada (C.B.C.)
416-660-1616
604-273-1155

CPC
714-757-0505
800-582-0505

Data Storage Marketing (D.S.M.)
1-800-543-6098
303-442-4747

Firstop Computer
1-800-832-4322

Future Electronics
514-694-7710

Intellect
011-525-255-5325

JACO
214-733-4300

Marshall Industries
1-800-522-0084

Microware Distributors
1-800-777-2589
503-646-4492

Mini Micro
408-456-4500

Pioneer Standard Electronics
1-800-874-6633

Pioneer Technologies
1-800-227-1693

S.E.D.
1-800-444-8962
404-491-8962

Tech Data
1-800-237-8931
813-539-7429

Technology Factory
1-800-848-2073
1-800-227-4712

Technology Marketing Group
1-800-688-7000
612-942-7000

U.S. Computer
305-477-2288

Wyle Laboratories
1-800-289-9953

EDN EDITORS' CHOICE

INNOVATION

Inexpensive 32-bit μ P chip seeks embedded systems

While giant semiconductor companies are making 32-bit μ P design look so formidable that few start-up companies even dream of developing competitive 32-bit designs, a small German company is ready to do battle. The battleground is the crowded embedded-computer market, where 10-person Hyperstone Electronics is determined to gain a beachhead in its campaign for embedded-system customers. Named the Hyperstone E1, the 85,000-transistor chip operates at a burst rate of 25 MIPS at 25 MHz. The μ P requires no external cache, and it operates with external dynamic RAM (DRAM) chips, which it controls directly.

The E1 chip offers an address space of 4G bytes, and it has separate memory and I/O addresses. The chip supplies 19 global and 64 local registers, each of which has 32 bits. Programs can directly address as many as 16 global and 16 local registers. You can also reconfigure the registers in a variable-length stack, using from 2 to 16 frames. Most of the chip's instructions are 16 bits long, although complex instructions can consume as many as 48 bits. Benchmarks yield 38,000 Dhrystones. The throughput results from a combination of pipelined load instructions, an internal 2-stage decode/execute pipeline, and a look-ahead instruction cache.

This chip is not the quixotic dream of an eccentric engineer. Hyperstone's founder and leader is Otto Müller, a computer engineer who is known in Europe for design-

ing computers for Telefunken, Nixdorf, and Triumph-Adler. After designing computers for these large companies, Müller founded his own company, CTM, which produced computers for businesses. Müller's new company, Hyperstone, is 2½ years old and is already producing μ P chips.

Although the company does not fabricate its own devices, it has a foundry in the USA that furnishes them. It has also licensed nonexclusive rights to the chip to Zilog, which currently has working silicon and expects to offer chips in March. Zilog will also offer the chip as a core in its Superintegration ASIC program.

You can purchase the E1 μ P chip directly from Hyperstone for \$150. However, the company expects the price to drop to less than \$50 (10,000) by the end of 1991. A development board, which provides an E1 CPU, 1M byte of DRAM, 256k bytes of EPROM, and an RS-232C I/O port, is available for \$1699. An assembler and a debugger cost \$350 and \$400, respectively. They run on an IBM PC or a compatible computer. You can load instructions and data into the development board through the computer's serial I/O port.

—Jon Titus

*Hyperstone Electronics, GmbH,
Robert-Bosch-Strasse 11, D-7750
Konstanz, Germany. Phone 07531-
67789. FAX 07531-51725.*

Circle No. 730

*Zilog Inc, 210 Hacienda Ave,
Campbell, CA 95008. Phone (408)
370-8000. FAX (408) 370-8056.*

Circle No. 731

Driver IC distributes 20 clock copies and offers a primary output of 80 MHz max

You can use the SC3501 BiCMOS 20-copy clock-driver IC to handle clock distribution throughout an entire high-speed-CPU board. The IC outputs TTL-compatible signals with frequencies as fast as 80 MHz. Less than 500 psec of skew characterizes the 20 leading-edge synchronized outputs.

As input, the clock-driver IC requires a signal of double the desired output frequency. A differential ECL input signal from a crystal-controlled oscillator, operating between 5V and ground, provides a high-precision output signal. Optionally, you can drive the IC with TTL signals for low-frequency applications.

The SC3501 IC offers three

groups of outputs. The first set of 10 outputs operate at the primary clock frequency of the chip (one-half the input frequency). You can set the second group of five outputs to be identical to the primary output frequency or to operate at one-half the primary output frequency. Likewise, you can set the third group of five outputs to a choice of one-half or one-fourth of the primary output frequency.

All 20 outputs provide waveforms with 50% high/low duty-factor symmetry centered around a threshold of 1.5V. You can adjust the clock-width timing symmetry in ± 0.34 -nsec increments via strappable input pins.

The outputs include complemen-

tary 24-mA-pk source and sink drivers. The outputs also feature internal source termination that minimizes signal overshoot or undershoot without requiring external termination networks. A maximum output slew rate of 2V/nsec minimizes simultaneous output switching noise and distortion. You can also connect the outputs in parallel to drive capacitance loads of 40 pF and higher.

The SC3501, in a 52-pin quad flatpack, costs \$17 (1000).

—Maury Wright

Silicon Connections Corp, 6160 Lusk Blvd, Suite C-204, San Diego, CA 92121. Phone (619) 535-0442. FAX (619) 535-1635.

Circle No. 732

CUT FREQUENCY HIGHS DOWN TO SIZE Micro/Q[®] 3000 Controls High Frequency Noise From ASICs

Design PGA packaged ASICs or MPUs into your board design and the noise level starts climbing. Surround these PGAs with standard 2 pin decoupling capacitors, and you'll use valuable board space and provide inferior decoupling.

Micro/Q 3000 decoupling capacitors from Rogers provide excellent noise suppression over a wide frequency range. For space savings, they're specifically designed to fit *under* PGA devices such as fully custom ASICs, MPUs and gate arrays - where low noise and high density are essential.

Featuring the high performance reliability you've come to expect from Rogers, this family of very low inductance

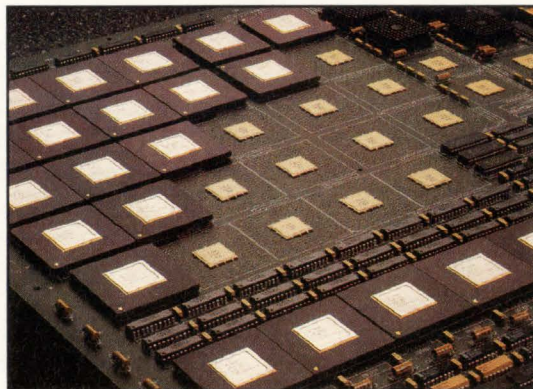

Micro/Q 3000 capacitors fit under PGA packaged ASICs and MPUs.

decoupling capacitors is through-hole mounted *under* pin grid arrays, PGA sockets, and PLCCs/LCCs mounted in sockets. They are available for all PGAs in a variety of sizes and dielectrics, including X7R and P3J dielectrics for greater temperature stability.

Micro/Q 3000 capacitors. Excellent noise suppression for high performance.

Write or call for free literature and product samples.

Technology for tomorrow built on TQC today.



ROGERS

Rogers Corporation
Circuit Components Division
2400 South Roosevelt Street
Tempe, AZ 85282
Tel: (602) 967-0624
Fax: (602) 967-9385

Also available through Mektron Europe, Ghent, Belgium and Rogers Inoue Corp., Nagoya, Japan.
Micro/Q is a registered trademark of Rogers Corporation.

The only 16-bit, 500 kSPS SADC with guaranteed dynamic performance.

For the competition, that's not a pretty picture.

If you're working in spectral imaging applications, our new AD1382 presents a very pretty picture indeed. Because it's the first 16-bit, 500 kSPS single-package sampling A/D converter to offer guaranteed ac performance.

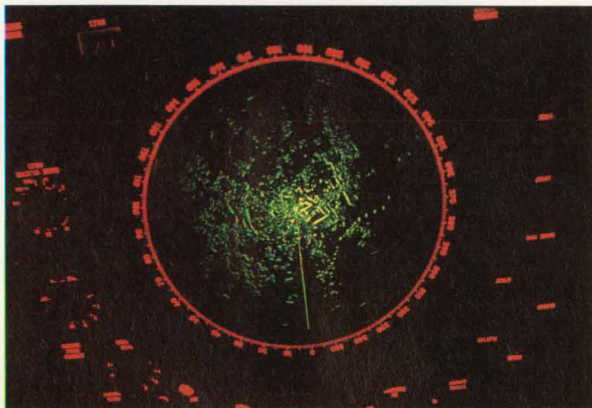

The use of the AD1382 is soaring in radar applications, thanks to its higher level of integration and guaranteed dynamic performance.

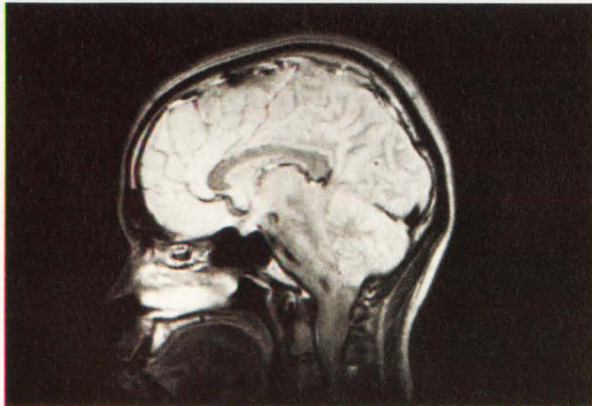

With its wide dynamic range and low noise, the AD1382 has a great image with people working in magnetic resonance imaging applications.

The AD1382 delivers guaranteed 100% production tested SNR, THD and peak distortion performance at three input frequencies and over two input ranges – testing that gives you the confidence to design for the best possible noise performance in your system.

You can also feel confident about the cost-effectiveness of the AD1382. It offers a higher level of integration with on-board track/hold and reference.

And since it's a single package, it's easier to design in and uses less

board space than more expensive modular or multipackage solutions.

For a better picture of what the AD1382 can do for you, contact Analog Devices at 1-800-262-5643. Or write to Analog Devices, P.O. Box 9106, Norwood, MA 02062-9106.

AD1382



A 16-bit 500 kSPS SADC, the AD1382 provides excellent dynamic and static performance in a dual inline ceramic package.

Guaranteed (@25°C, ±5 V input range):

SNR

- 5 kHz 90 dB min
- 100 kHz 90 dB min
- 200 kHz 88 dB min

THD & Peak Distortion

- 5 kHz – 90 dB min
- 100 kHz – 88 dB min
- 200 kHz – 82 dB min

DC specifications include:

0.0015% FSR INL, 0.0006% FSR DNL and NMC guaranteed to 16-bits

Other features include:

Zero offset autocalibration
±5 V, ±10 V Bipolar input range

An evaluation board for the AD1382 is available.



WHAT GOOD IS A BRAIN

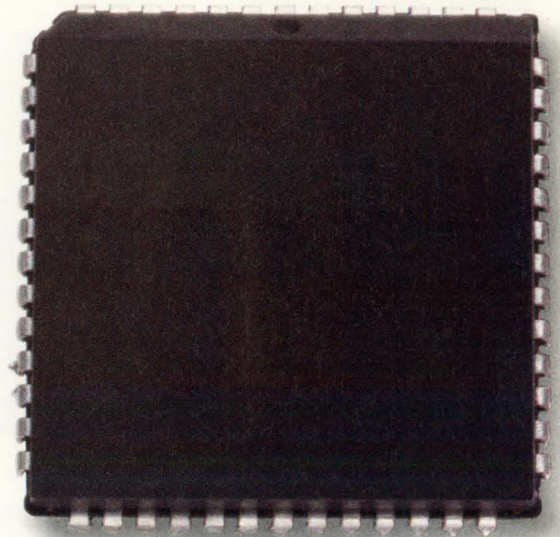

©1990 Conner Peripherals, Inc.

World Headquarters: 3081 Zanker Road, San Jose, CA 95134 Telephone: (408) 456-4500 FAX: (408) 456-4501 Sales Offices: U.S.—Boston: (508) 660-1088 • Dallas: (214) 680-2913 • Los Angeles: (714) 455-2777

WITHOUT A MEMORY?

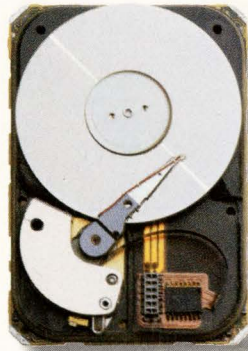

To hear most people in the computer business talk, you'd think the only valuable part of a system is its microprocessor.

Maybe they haven't lost their minds. But they've certainly forgotten about the hard drive. And the critical data it stores. Data which can't be easily replaced like a microprocessor.

So it's no surprise that many OEMs are reducing their risk of system failure with disk drives from Conner. Using proven technologies, our high performance drives consistently set the standards for form factor, reliability, and innovation.

That's because at Conner, we work closely with our customers to identify their needs sooner, and fill them faster. Providing them the quickest time to market; with exactly the right product. Plus, we're expanding our worldwide manufacturing facilities to meet growing customer demand around the globe.

All of which makes choosing Conner disk drives a low risk decision.

So call Conner today. The results should be quite memorable.

CONNER
T H E T H I R D W A V E

• San Jose: (408) 456-4500 **Europe**—Ivrea: (39) 125-631715 • London: (44) 249-444-049 • Munich: (49) 89-129-8061 • Paris: (33) 1-47-474108 **Asia** - Singapore: (65) 2845366 • Taipei: (886) 2-718-9193 • Tokyo: (81) 3-485-8901



Diminutive disk drives cram more and more data onto standard-size 3½-in. media. (Photo courtesy Quantum Corp)

HIGH-CAPACITY 3½-IN. HARD-DISK DRIVES

New 3½-in. hard-disk drives have capacities exceeding 500M bytes and perform as well as high-end 5¼-in. units. The small drives are as reliable as 5¼- and even 8-in. drives and can be found in workstations, file servers, and drive arrays.

Maury Wright, *Regional Editor*

Most hard-disk-drive trends stay the same: higher capacities, smaller units, faster performance, and cheaper prices. This year is no exception. The latest round of 3½-in. drives includes units that have capacities exceeding 500M bytes. You can now buy 100M-byte 3½-in. drives that stand only 0.75-in. high. Some manufacturers offer drives whose spindle motor speeds exceed 3600 rpm. These drives have low rotational-latency specs and fast read-channel data rates. And many 3½-in. drives are now cheaper than comparable 5¼-in. drives and have MTBF specs as high as 200,000 hours.

In fact, the widespread availability and competitive pricing of 3½-in. disk drives has completely eroded demand for 5¼-in. units with capacities of 200M bytes and less. A year to 18 months ago, you paid a premium for a 3½-in. unit—even in a low capacity such as 30M bytes. Now you can buy 3½-in. units for less than what you'd pay for 5¼-in. drives at capacities of 200M bytes and less—with the exception of sporadic fire sales by manufacturers of 5¼-in. inventory. The discounted street prices of 100M-byte 3½-in. drives have reached \$450, and some of the newer drives should drive that price lower within the next quarter.

The newly announced 400M- and 500M-byte 3½-in. drives will soon become the primary choice of designers of workstations and network file servers—applications currently dominated by 5¼-in. drives. The size of the smaller drives also suits them for arrays.

So chances are you'll be looking at 3½-in. disk drives this year unless your upcoming designs require fea-



A cache that adapts to ongoing operations optimizes the performance of Western Digital's WDSP4200 200M-byte 3½-in. drive. The on-drive controller chooses the cache algorithm number of segments and the segment size.

The emergence of 500M-byte 3½-in. drives will erode demand for 5¼-in. drives, especially for workstations and LAN servers.

tures that other form factors can better provide. For example, laptop and notebook designs will most likely take advantage of the smaller size of 2½-in. drives. (For more information on advances in 2½-in. drives see **box**, "Capacities of 2½-in. drives approach 100M bytes").

And a few reasons do remain to consider 5¼-in. drives. You can buy the larger drives in higher capacities—currently as high as 1.6M bytes. Some 5¼-in. drives offer features previously associated only with 8-in. drives. One such feature is split data channels, which doubles the raw data rate a drive can sustain. You can also buy 5¼-in. drives with a greater choice of interfaces, notably ESDI and IPI-2 (Intelligent Peripheral Interface), both of which are device-level interfaces. Drives with this type of interface require a host-resident controller board.

The new generation of 3½-in. drives seemingly

marks the end of device-level interfaces in disk drives. All the recently announced drives feature either SCSI or IDE (Integrated Device Electronics—also called the AT interface) intelligent interfaces. Drives with intelligent interfaces have embedded controllers, which make technological advances such as multiple-zone recording and on-drive caches and error handling possible. Advances in disk-control and -interface ICs have made the overhead previously associated with intelligent interfaces virtually negligible.

Few drives support ESDI

You must consider drive interface as a key system-design issue. Only a few companies offer device-level interfaces on 3½-in. drives. Some older units have ST-506 device-level interfaces. Microscience International ships 110M- and 123M-byte members of its 5100 family of drives with ESDI interfaces. NCL America Computer Products also offers 3½-in. drives with ESDI interfaces.

Dave Tovey, Toshiba's marketing vice president, says array designers will demand 3½-in. drives with some type of device-level interface. Tovey thinks a simplified version of the ESDI interface—possibly with

Capacities of 2½-in. drives approach 100M bytes

You can now buy 60M-byte 2½-in. disk drives from several sources, and 80M- and 100M-byte units will soon follow. The drives suit traditional applications such as portable, laptop, and notebook computers. But expect the tiny drives to also find use in applications such as fax machines, laser printers, and even automobiles.

PrairieTek leads the 2½-in.-drive field. The company offers the PT-120 20M-byte drives for \$432 (100) and the PT-240 40M-byte drives for \$534 (100). The drives employ one and two platters, respectively. Along with PrairieTek, Conner Peripherals and JVC have supplied most of the 2½-in. drives shipped to date. Most of these units have been 20M-byte drives.

Several other companies have recently announced 2½-in. drives, and more will soon follow. The 40M-byte drives are now main-

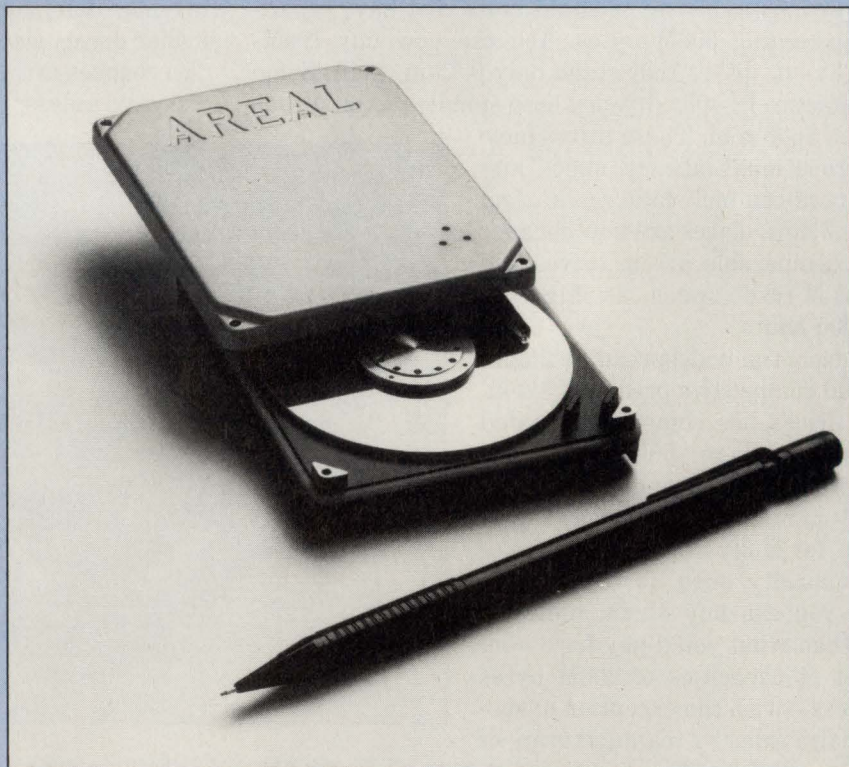

The 2½-in., 63M-byte MD-2060 hard-disk drive from Areal Technology stores data on one glass-substrate platter.

no signal drivers because the cable runs would be short—might suit such applications. Neither Toshiba nor any other company currently offers a 3½-in. drive with such an interface, however, and no standard for such an interface exists. Most of the new IDE and SCSI drives do have some features, such as spindle synchronization, that support array designs.

The IDE and SCSI offerings should suit your needs for traditional system designs. Intelligent drives typically add less than one millisecond of overhead to I/O operations. The IDE units work only in IBM PC/AT bus systems and offer plug-and-play compatibility with the original IBM PC/AT ST-506 disk controller. In fact, newer IBM PC/AT-compatible mother-board chip sets from companies such as Chips and Technologies (San Jose, CA) and VLSI Technology (Tempe, AZ) regularly include the simple IDE host interface. A single header connector on the mother board provides the primary I/O capability. IBM has developed a similar interface for its Micro Channel-based systems and, along with Conner Peripherals, manufactures compatible disk drives.

SCSI drives require nonstandard operating-system drivers or BIOS additions for use on IBM-compatible

personal computers. The drives offer performance advantages for multitasking operating systems such as Unix or Novell's NetWare that overlap I/O requests. SCSI drives are compatible with many other peripherals. You can use a single SCSI host adapter to connect tape drives, CD-ROM drives, scanners, and printers, as well as disk drives. Outside the world of IBM-compatible personal computers, the computer industry has endorsed SCSI as the interface of choice for most systems with less-than-mainframe power.

These high-capacity drives all support the SCSI-2 standard. Less than a year old, SCSI-2 formally defines a common command set for disk drives and other peripherals. The standard adds error-recovery features and command tags that facilitate command queuing. SCSI-2 also defines optional wide and fast data transfers. The wide transfer option defines the expansion of the interface from an 8-bit to a 16- or 32-bit bus. The fast option doubles the bus speed during synchronous transfers to 10 MHz, which results in a 10M-byte/sec rate on an 8-bit implementation.

The SCSI-2 drives available now don't support the optional wide or fast data transfers. Virtually all manufacturers of high-capacity 3½-in. drives plan to support

stream products, and higher-capacity drives are now emerging. Toshiba, for example, entered the market with the 40M-byte MK-1122FC drive that weighs 6.3 oz. The single-platter drive costs \$425 (100), includes a 32k-byte cache, and has an average seek time of 23 msec. The company also offers a 20M-byte version of the product. Quantum announced a single-platter 40M-byte drive, and Seagate offers a single-platter 20M-byte unit and a dual-platter 40M-byte drive.

Areal Technology, Conner Peripherals, and Western Digital have announced 60M-byte products. Western Digital's \$325 (100) 30M-byte WDAB130 and \$495 (100) 60M-byte WDAH260 drives include one and two platters, respectively. When combined with the company's 7600 Core Logic family of mother-board chip sets, the drives offer eight power-

saving modes for battery-powered notebook computer operation. The combination also yields zero-wait-state memory access between the host CPU and the IDE controller. Typically, systems with IDE drives insert one or two wait states when accessing the controller.

Conner Peripherals includes 30M, 40M, and 60M-byte drives in its Pancho series of drives. The drives' prices range from \$395 to \$495. The CP-2064 60M-byte product employs two platters and features a 19-msec average seek time. The drive requires 1.3W and can withstand shocks of 100g.

Areal Technology's MD-2060 uses a single platter to store 60M bytes. The drives use glass-substrate media—a holdover from Areal's previous attempts to enter the 3½-in. drive market with a 1-in.-high 100M-byte drive. Areal now has a manufacturing

agreement with Sanyo (Tottori City, Japan), and Sanyo holds an equity position in Areal. Evaluation units of the drive cost \$995, and Kirby says production units will be available in the first quarter.

Around midyear, expect to see 80M-byte 2½-in. drives. Prairietek has announced plans to build a 2-platter 80M-byte unit. Conner Peripherals offers a 0.75-in.-high, 85M-byte 3½-in. drive. If Areal succeeds in producing its 60M-byte unit on schedule, you may also see a 120M-byte, 2-platter offering from the company in the second half of the year. Finally, expect Maxtor to enter the market during the first half of the year with a drive designed at its Colorado division (formerly Miniscribe). Given Maxtor's reputation, expect the drive's capacity to exceed that of currently announced products.

New 3½-in. drives eschew device-level interfaces such as ESDI completely and instead offer the choice of SCSI or IDE interfaces.

fast transfers, at least as an option. Vendors of disk-controller ICs are busy adding the capability, so expect widespread availability of drives with the feature after midyear. The wide SCSI-2 data-transfer option should be more popular on 5¼- and 8-in. drives.

Choosing a disk-drive supplier will prove to be a much less exact science than choosing an interface. In the 400M- to 500M-byte product category, the list of suppliers reads like a who's who of the disk-drive industry. (See **Table 1** for suppliers and drive specifications.) Hewlett-Packard, Hitachi, IBM, NEC, Quantum, Seagate, and Western Digital all offer 3½-in. drives with capacities exceeding 400M bytes. IBM and Western Digital sell the same drive. IBM designed and builds the drive and handles sales to large customers. Western Digital sells the drives to smaller OEMs and through distribution.

Conner Peripherals, Fujitsu, Maxtor, and Rodime all offer drives with capacities exceeding 500M bytes. The companies offer depopulated versions of the drives (versions with one or more disk platters removed) that have capacities of 200M to 400M bytes. The 400M- and 500M-byte drives all have similar performance specs, but you should evaluate the actual performance of the drives in your application. Be aware that manufacturers measure performance in different ways, so comparing specified seek times or data rates is not necessarily like comparing apples and apples.

Fast spindle speed reduces latency

The Fujitsu M262XSA/T and Seagate ST1480 drives deserve note in the performance area. The drives feature a state-of-the-art average seek time of 12 msec. They have rotational speeds of 4400 rpm; most other drives have rotational speeds of 3600 rpm. The faster spin rate results in an average rotational latency spec (the time required for the platters to rotate half a turn) of 6.8 msec, compared with 8.3 msec for most competing products. The faster rotation also results in a faster raw data rate—approximately 3M bytes/sec.

Table 1—Representative high-capacity 3½-in hard-disk drives

Manufacturer	Model	Formatted capacity (M bytes)	Price	Number of disks	Track density (tpi)	Bit density (bpi)	Data encoding scheme	Spindle speed (rpm)	Average seek time (msec)
Conner Peripherals Inc	CP-3200	212	\$660	4	1700	31,800	2, 7 RLL	3485	16
	CP-3500	510	\$1295	6	2100	42,763	2, 7 RLL	3609	12
Fujitsu America Inc	M262XSA/T	520, 425, 330	\$1750, \$1500, \$1250	6, 5, 4	1751	46,383	1, 7 RLL	4400	12
Hewlett-Packard Co	C2235S	422	\$1225	5	1850	42,000	2, 7 RLL	3600	13
Hitachi America Ltd	DK314	419	\$1780 (100)	7	1800	44,200	2, 7 RLL	3600	16.8
	DK312	251, 209	\$975, \$880 (100)	6, 5	1660	38,800	2, 7 RLL	3600	16.8
IBM Corp	WDS/A-3160	206	\$625 (500)	4	1517	31,700	1, 7 RLL	3600	16
	*0661-371	320	\$1000 (1000)	8	1201	37,341	1, 7 RLL	4316	12.5
	*0661-467	400	\$1575 (1000)	8	1469	38,427	1, 7 RLL	4316	11.5
Maxtor Corp	LXT-213	213	\$930 (100)	4	1600	28,000	1, 7 RLL	3600	15
	LXT-340	340	\$1600 (100)	4	1600	44,000	1, 7 RLL	3600	13
	LXT-535, 437	535, 437	\$1450, \$1250 (100)	6, 5	1600	44,000	1, 7 RLL	3600	13
Microscience International Corp	7200	200	\$1350	4	1561	37,341	2, 7 RLL	3600	18
NCL America Computer Products Inc	9220	200	\$895	5	1378	29,700	2, 7 RLL	3565	16.5
NEC Technologies Inc	D3000	425, 330	\$1200, \$1000 (1000)	5, 4	2000	48,982	1, 7 RLL	3600	14
Quantum Corp	210S/AT	210	\$750 (100)	4	1414	30,000	1, 7 RLL	3606	15
	425S/AT,330S/AT	425, 330	\$1595, \$1350 (100)	5, 4	1695	37,146	1, 7 RLL	3606	14
Rodime Inc	3004T	540, 426, 331	\$1495, \$1295, \$1050	6, 5, 4	1905	38,000	1, 7 RLL	3600	14
Seagate Technology Inc	ST1239	210	\$910	5	1543	28,103	2, 7 RLL	3600	15
	ST1480	426, 340, 331	\$1950, \$1855, \$1740	5, 5, 4	1760	36,000	1, 7 RLL	4400	14, 12, 14
Western Digital Corp	ADP4200	212	\$650 (1000)	4	1575	56,000	2, 7 RLL	3610	16
	*WDSC8320	320	\$1350 (1000)	8	1201	37,341	1, 7 RLL	4316	12.5
	*WDSC8400	400	\$1575 (1000)	8	1469	38,427	1, 7 RLL	4316	11.5

Key: N/A = Not applicable. N/S = Not specified. *IBM and Western Digital both sell these drives; IBM sells them only in large OEM quantities.

The features of intelligent controllers can sometimes improve the performance of disk drives beyond the capabilities of the drive hardware. Quantum has offered a multisegment cache on its drives for years. Its newest Prodrive 330 and 425 products include a 256k-byte cache. The controller continues to read sequential data after an I/O request completes. The drive can service subsequent requests with no seek time or rotational latency (typically close to 20 msec) on cache hits.

Drives with this cache implementation can continue to prefetch data and service incoming I/O requests simultaneously with no extra command overhead. Thus, a new I/O request never interrupts a prefetch operation that might be retrieving the requested data. On cache hits, the controller can continue a prefetch operation and transfer the requested data from the cache at the same time.

Stigma remains on write caches

You can also specify a write cache as an option on Quantum's drives. Product Marketing Manager John Klonick says that 50% of all I/O requests write data; a cache speeds such operations by holding data tempo-

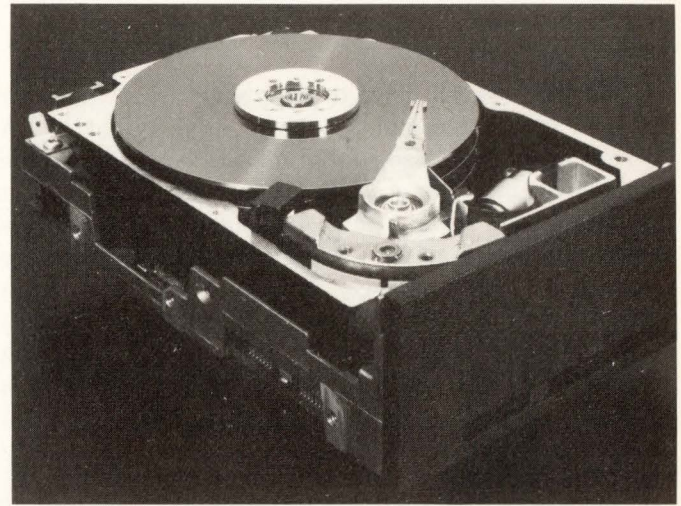

The 4400-rpm spindle speed of Seagate's ST1400 family of drives results in an average rotational latency of 6.8 msec and disk data-transfer rates as fast as 3M bytes/sec.

rarily. Traditionally, system designers resist write caches because a system or power failure could result in lost data. Klonick points out that the typical Unix system has 8M bytes of data in main memory that disappear when failures occur, but only a few kilobytes are lost on the drive.

Other companies have become serious about caching as well. For 400M- and 500M-byte 3½-in. drives, a 256k-byte cache is the rule rather than the exception. Conner Peripherals includes a 4-segment, 256k-byte cache on its CP-3500 drive. Previously, the company offered a simple 1-segment read-ahead buffer.

Quantum offers a controller feature called read on arrival. The drives can attempt to read data immediately upon arriving at the desired track without waiting for the heads to settle for a specified period. When the read is successful, the drive sometimes eliminates the latency caused by a full rotation of the disk. Of course, the technique can increase seek errors, so you can disable the feature with software.

In addition to performance, consider reliability and cost when choosing a 3½-in. drive. Manufacturers of disk drives have raised the MTBF spec of their products across the board in the last year. Hewlett-Packard started the trend by specifying an MTBF of 150,000 hours and a warranty of five years on all its drives. Fujitsu followed with a 200,000-hour spec on its products. Both companies have also published papers detailing the derivation of their published MTBF specs.

Other manufacturers have been less forthcoming with detailed information on drive MTBF specs. Manufacturers should explain the theoretical basis for a MTBF spec. Accelerated life testing should back up the theory. And field data along with ongoing life testing should further substantiate the spec.

Track-to-track seek time (msec)	Disk data rate (M bits/sec)	Recording zones	MTBF (hours)	Cache size (k bytes)
5	12	N/A	50,000	64
4	16	N/A	100,000	256
3	19 to 24	4	200,000	256
3	14.1 to 20.6	3	150,000	64
7	14	N/A	150,000	64
7	16	N/A	150,000	32
5	12	N/A	45,000	32
4	16	N/A	150,000	64
3	16	N/A	150,000	128
3	9 to 15.7	6	150,000	32
3	13.3 to 20.5	8	150,000	128
3	13.3 to 20.5	8	150,000	128
4	12.5	N/A	60,000	32
3.8	10	N/A	50,000	64
N/S	19	N/A	50,000	32
4	10.8 to 16.3	8	50,000	64
4	12.2 to 21.7	8	150,000	256
3	13.6 to 21.6	8	100,000	256
4	10	N/A	150,000	64
2.5	17 to 25	26	150,000	64
5	12.6	N/A	50,000	64
4	16	N/A	150,000	64
3	16	N/A	150,000	128

3½-in. hard-disk drives

Consider overall drive design, also, as an indicator of how producible and reliable a drive might be. A drive's design can also subtly indicate how reliable the company's next-generation product might be. Most manufacturers have specific technological strongholds that influence their drive design and how they achieve high disk-drive capacities. You can always increase a drive's capacity yourself by adding platters or increasing the bit or track density. Multiple-zone recording can boost a drive's capacity by as much as 50% and is virtually free once designed in. Also called zone-bit recording (a Seagate trademark), multiple-zone recording requires that the drive surface be divided into concentric zones. The outer tracks have more sectors than inner tracks and store more data than the inner tracks store.

Try to judge which drive-design parameters a manufacturer drives to the edge to achieve high capacities. Maxtor, for example, uses six platters, 1,7 RLL data encoding, and 8-zone multiple-zone recording to achieve the 535M-byte capacity of its LXT-535 drive. Conner Peripherals chose not to use multiple-zone recording in its 510M-byte CP-3500. The company achieved the capacity of that drive by pushing the track density to 2100 tpi; Maxtor's product has a track density of 1600 tpi.

RLL boosts capacity and tightens margins

Michael Gluck, senior vice president of Fujitsu's Computer Products Group, warns that you should watch out for the data-encoding scheme drive manufacturers use. Gluck points out that 2,7 RLL data encoding offers a 50% capacity boost compared with MFM encoding; 1,7 RLL offers a 33% relative increase. Gluck says 2,7 encoding results in tighter read-channel window margins and a potentially less-reliable drive. Fujitsu's M262XSA/T uses 1,7 RLL coding, six platters, and 4-zone multiple-zone recording. In practice, manufacturers have proven that 2,7 RLL encoding will work reliably. However, soft read errors that don't show up as drive failures cause retries and hurt drive performance.

Hewlett-Packard, NEC, Quantum, and Seagate have not announced 6-platter drives yet and, therefore, have no 500M byte products. However, you can expect such products in the future. IBM and Hitachi use more than six platters in their 400M-byte products. IBM's Model 467 has eight platters, and Hitachi's DK314 has seven.

IBM and Hitachi chose to face stiffer packaging requirements and the associated head spacing and aerodynamic problems rather than push bit or track density to achieve high-capacity drives. Neither company cur-

rently employs multiple-zone recording. Thus, they have the potential to double the present capacities of their drives without adding more disks. For now, more heads and disks translate into higher cost.

Choosing a 3½-in. drive with a capacity of 100M- to 200M bytes typically requires more attention to cost than to any other detail. Conner Peripherals' CP-3100 family of drives has been among the most popular 100M-byte drives, and mail-order houses sell the product for less than \$500. Several Seagate drives in the 100M-byte range have suggested list prices of approximately \$500. Kalok just introduced the KL3100 100M-byte 3½-in. drive. You can expect discounted street prices to near \$400 after midyear.



Synchronous 10M-byte/sec SCSI-2 data transfers suit the 540M-byte Rodime 3004T drives for use in workstations and file servers. The drives also feature spindle synchronization for array applications.

You also have various sizes of 3½-in. drives to choose from in the 100M-byte range. Most of the drives are 1.625 in. high—the standard full height for a 3½-in. product—but over the last two years, several manufacturers have introduced 1-in.-high drives.

Conner Peripherals, Fujitsu, Maxtor, Quantum, Rodime, Seagate, Teac, Toshiba, and Western Digital have introduced 1-in.-high 3½-in. drives that store more than 100M bytes. You will find differentiating the drives' performance specs tough, so be sure to test the drives in your system if performance is a prime concern. Other key parameters include power consumption, noise level, and environmental specs.

The 1-in.-high drives assume many of the features present in full-height drives from the same manufacturers. MTBF averages 100,000 hours, and the products include caches—albeit smaller ones than the full-height



NAT4882

The Only Way to Reach Full 488.2 Compatibility

PC/XT/AT CIR. #30

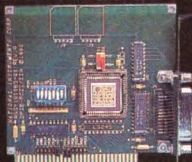

- Industry Standard
- 7210/9914 Compatible

PC AT CIR. #31

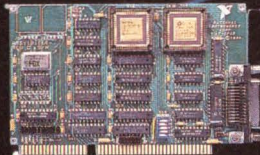

- The New Industry Standard
- 16-bit speed

Sun SPARCstation SBus CIR. #32

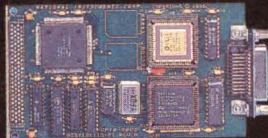

DECstation TURBOchannel

CIR. #33

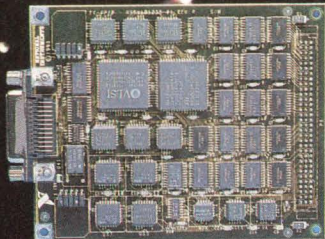

Macintosh NuBus CIR. #34

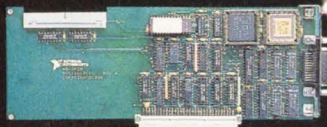

VXI Embedded Controllers

CIR. #35

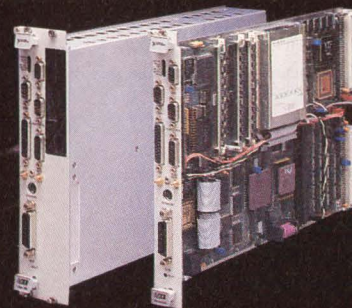

IBM Micro Channel CIR. #36

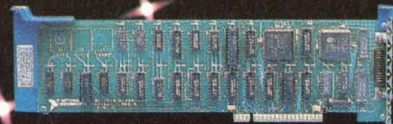

Macintosh SE/30 CIR. #37

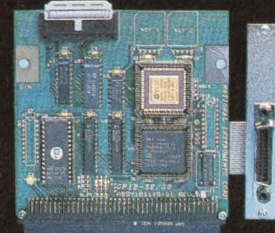

Continuing Unchallenged Leadership



NATIONAL INSTRUMENTS®
The Software is the Instrument®

Call for a **FREE** Catalog
(512) 794-0100
(800) IEEE-488 (U.S. and Canada)

6504 Bridge Point Parkway
Austin, TX 78730

3½-in. hard-disk drives

drives. Western Digital, for example, includes an adaptive 64k-byte cache on its 125M-byte AC2120. The controller monitors drive activity and adjusts the cache configuration during operation. For example, the controller can increase segment size while decreasing the number of segments available and vice versa.

You can buy a 0.75-in.-high, 85M-byte drive from Conner Peripherals, the \$495 CP-4084. You can fit two of the drives into the space a single full-high 3½-in. drive requires. Thus, products should succeed in mid-life system redesigns and updates and in the upgrade aftermarket.

Looking ahead, you can expect to see 1G-byte 3½-in. drives by this time next year. Fujitsu's Michael Gluck

predicts that by 1998 the technology will exist for drives with areal densities of 1G bit/in.²—10 times the density of the newest 500M-byte 3½-in. drives. The downsizing trend will not stop soon. Sherri Besser, Western Digital's marketing manager of 2½-in. drives, says these drives will cost less to manufacture than 3½-in. drives in two years. And some industry insiders have started talking about a new form factor that uses 1.8-in. media.

EDN

Article Interest Quotient (Circle One)
High 485 Medium 486 Low 487

Manufacturers of disk drives

For more information on disk drives such as those discussed in this article, circle the appropriate numbers on the Information Retrieval Service card, or use EDN's Express Request service. When you contact any of the following manufacturers directly, please let them know you saw their products in EDN.

Areal Technology Inc
2075 Zanker Rd
San Jose, CA 95131
(408) 436-6800
FAX (408) 436-6844
Circle No. 650

IBM Corp
3605 Highway 52 N
Rochester, MN 55901
(507) 253-1897
Circle No. 655

Microscience International Corp
90 Headquarters Dr
San Jose, CA 95134
(408) 433-9898
FAX (408) 954-0989
Circle No. 660

Rodime Inc
901 Broken Sound Pkwy NW
Boca Raton, FL 33487
(407) 994-6200
FAX (407) 997-9390
Circle No. 665

Conner Peripherals Inc
3081 Zanker Rd
San Jose, CA 95134
(408) 456-4500
FAX (408) 456-4501
Circle No. 651

JVC Companies of America
19900 Beach Blvd, Suite 1
Huntington Beach, CA 92648
(714) 965-2610
FAX (714) 968-9071
Circle No. 656

NCL America Computer Products Inc
1221 Innsbruck Dr
Sunnyvale, CA 94089
(408) 734-1006
FAX (408) 744-0709
Circle No. 661

Seagate Technology Inc
920 Disc Dr
Scotts Valley, CA 95066
(408) 438-6550
FAX (408) 429-6356
Circle No. 666

Fujitsu America Inc
3055 Orchard Dr
San Jose, CA 95134
(408) 432-1300
FAX (408) 432-1318
Circle No. 652

Kalok Corp
1289 Anvilwood Ave
Sunnyvale, CA 94089
(408) 747-1315
FAX (408) 747-1319
Circle No. 657

NEC Technologies Inc
1414 Massachusetts Ave
Boxborough, MA 01719
(508) 264-8000
FAX (508) 264-8673
Circle No. 662

Teac America Inc
Data Storage Products Div
7733 Telegraph Rd
Montebello, CA 90640
(213) 726-0303
FAX (213) 727-7621
Circle No. 667

Hewlett-Packard Co
Disk Mechanisms Div
11413 Chinden Blvd
Boise, ID 83714
(208) 323-2332
FAX (208) 323-3991
Circle No. 653

Kyocera Electronics Inc
Memory Products Div
100 Randolph Rd
Somerset, NJ 08875
(201) 563-4333
FAX (201) 560-8380
Circle No. 658

PrairieTek Corp
1830 Lefthand Circle
Longmont, CO 80501
(303) 772-4011
FAX (303) 651-3235
Circle No. 663

Toshiba America Information Systems Inc
Disk Products Div
9740 Irvine Blvd
Irvine, CA 92713
(714) 583-3109
FAX (714) 583-3133
Circle No. 668

Hitachi America Ltd
Computer Div
2000 Sierra Point Pkwy
Brisbane, CA 94005
(415) 589-8300
FAX (415) 583-4207
Circle No. 654

Maxtor Corp
211 River Oaks Pkwy
San Jose, CA 95134
(408) 432-1700
FAX (408) 433-0457
Circle No. 659

Quantum Corp
1804 McCarthy Blvd
Milpitas, CA 95035
(408) 432-1100
FAX (408) 943-0689
Circle No. 664

Western Digital Corp
8105 Irvine Center Dr
Irvine, CA 92718
(714) 932-5000
FAX (714) 932-7502
Circle No. 669

Our new ML2261 8-bit A/D converter takes speed and accuracy to an entirely new level: 670ns.

Latch onto Micro Linear's new ML2261. Without question, the fastest, most accurate micro-processor-compatible 8-bit A/D converter on the market. With performance features that'll leave most microprocessors in a no-wait state.

By utilizing half-flash techniques, the ML2261 achieves A/D conversion times of 670ns over temperature and V_{CC} . It quickly converts an analog 0V to 5V sine wave at 500 kHz to its digital representation with 48 dB signal-to-noise ratio. Digital error correction is used to achieve a total unadjusted error of better than $\pm 1/4$ LSB. (Total unadjusted error includes the sum of linearity, zero scale and full scale errors).

It's also easier to use, because the ML2261's differential architecture provides superior power supply rejection. The analog input is 0V to 5V with a 5V power supply. And because

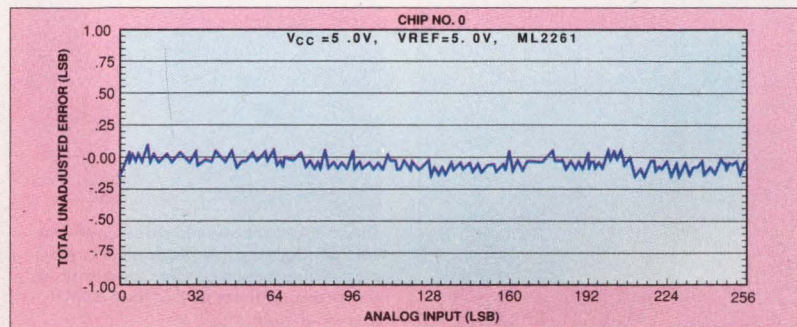

Built-in digital error correction delivers true 8-bit accuracy, with typical unadjusted error of less than $\pm 1/4$ LSB.

inputs can withstand at least 25 mA, you can achieve better latch-up immunity on analog inputs. The digital interface is also designed to keep up with the fastest microprocessors and appears as a memory location or I/O port to the microprocessor. In addition, no external clock is required and power dissipation is a mere 75 mW. All parameters are guaranteed over the supply tolerance and temperature range.

Combined, the ML2261 gives you the fastest, most accu-

rate, easiest to use 8-bit converter for a wide range of applications including disk drives, medical instrumentation and signal processing. With a price/performance ratio that's significantly lower than comparable converters.

Devices are now available in standard 20-pin DIP or surface-mount PCC packages, with 100-unit prices beginning under \$9.00.

For more information.

To find out more about how you can quickly convert your new product design to the ML2261, just call (408) 433-5200. Or write to: Micro Linear, Dept. TFA, 2092 Concourse Drive, San Jose, CA 95131. We'll send you all the specs. In a flash.

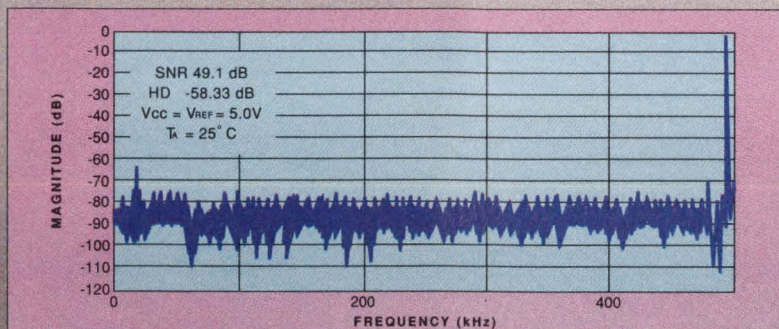

The ML2261 maintains ideal signal-to-noise ratios independent of increasing analog input frequencies to 500kHz.

 **Micro Linear**

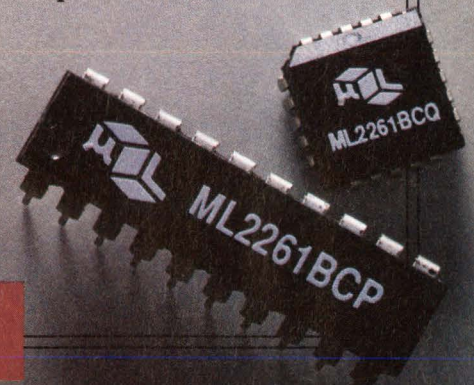

TAKE A LOT OF THE COSTS OUT OF CIRCUITS ASSEMBLY

...and improve product reliability

Inconsistent assembly steps. Time-consuming inspection procedures. Damage to existing connections on pre-populated boards. Expensive rework. All of these are significant cost factors in other circuits assembly methods that are eliminated by NAS solder and flux bearing edge clips. The result is a faster, less costly circuits assembly process.

With NAS solder and flux bearing edge clips, solder paste, solder and flux dipping and board clean-up — steps in other methods that are inconsistent and yield high rates of rejects — are replaced by simple, one-step lead attachment and reflow operations. These operations consistently produce 100% solderability.

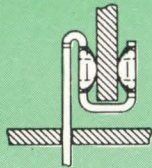

Because bonding of clips to conductor pads can be accomplished without raising the temperature of pre-populated boards to reflow levels, there is no damage to existing connections. Most, or all, of the inspection procedures required by other methods are unnecessary, and expensive rework is a thing of the past.

Preforms on edge clip terminals contain precisely the right amounts of the proper solder and flux for each application, and the exclusive NAS "Claw" grip holds each preform.

The simple, efficient method of applying NAS solder and flux bearing edge clips:

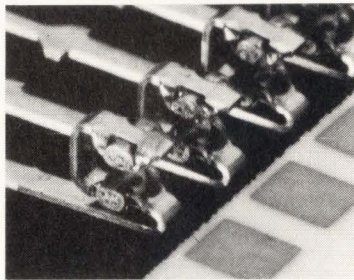

Direct contact between solder preforms and conductor pads produces a beneficial wiping action as clips are attached, either manually or with a lead attachment machine.

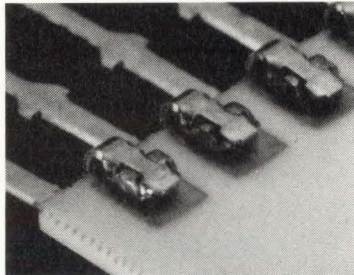

Interference fit holds clips firmly in position for reflow. Top and bottom preforms are reflowed in one operation using any method that raises temperatures to reflow levels.



Precise amounts of the right solder and the shape of the "Claw" grip provide control of solder flow without a solder stop. This assures perfect mechanical and electrical bonding without wicking or bridging.

Unretouched Macro Photography

This unique grip design provides direct contact between solder and conductor pads, a beneficial wiping action as clips are attached, and positive control of solder flow. A single reflow operation for top and bottom preforms — using any method that raises temperatures to reflow levels — produces perfect solder joints every time.

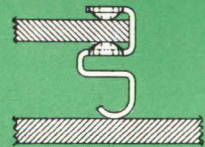

Converting to the NAS solder and flux bearing circuits assembly method requires no specialized labor skills and no significant capital investment. Immediately, you can be producing more reliable, better performing products . . . in far less time and at

significantly less overall cost.



NAS offers a large selection of edge

clips, including .100, .075 and .050 centerlines for both through-hole and surface mounting of SIP, DIP, Quad and Multi-chip devices. Our surface mount clips are the most effective solution to the problem of thermal mismatch, and are available in a variety of types. Ask about our Compliant "J" surface mount designs with .025 and 1mm centerlines.

In addition to a complete line of edge clips, NAS offers economical semi-automatic SIP, DIP and Quad lead attachment machines, and bench-top and in-line reflow machines, all of which further enhance assembly efficiency and reliability.

For complete information about any of our products, please contact:

NAS Electronics, 381 Park St., Hackensack, NJ 07602.
Phone (201) 343-3156.
FAX (201) 343-4883.

NAS
 ELECTRONICS

In Europe

Nasbrit Ltd.
 Nobel Road
 Wester Gaurdie Industrial Estate
 Dundee, Scotland DD2 4UX
 PHONE: Dundee 0382-622222
 FAX: 03826/22217

ELMITECH
 31 Chemin De Montjean
 Sentiers 505
 F-94266, Fresnes, Cedex,
 France
 PHONE: (1)46684433
 FAX: (1)46684345

100% solderability with the "CLAW" ...our exclusive grip design

CIRCLE NO. 56

an interplex technology company

A hand holding a burning PAL chip. The hand is dark and appears to be made of smoke or shadow, holding a small integrated circuit (PAL) that is on fire. The fire is bright orange and yellow, with a thick plume of dark smoke rising from the chip. In the background, other PAL chips are visible on a circuit board, but they are not burning. The overall scene is set against a dark, gradient background.

A few words of advice from high-performance μ PLDs.

Chill out, PAL.

Many designers have hot, high-performance designs. Literally.

Fortunately, Intel has a simple way to reduce system heat and still get incredible performance. The μ PLD Family of programmable logic devices.

Take, for example, the 85C220 and 85C224. They operate at 80MHz (100 MHz internally) with only a 10ns total propagation delay.

And since μ PLDs are manufactured using Intel's CHMOS* technology, they require just 1/4 the power of their pin-compatible bipolar PAL* alternatives. Which means they can lower

system heat by 35 percent and help reduce board-level failures, too. So they're certain to give your high-performance system a boost. And send chills up the spine of your motherboard.

Learn more about Intel μ PLDs and receive a μ PLD/PAL heat comparison. Call (800) 548-4725 and ask for Literature Packet #1A28.

Otherwise, you could take some heat over your system design.

The Intel logo, consisting of the word "intel" in a lowercase, sans-serif font with a registered trademark symbol (®) to the upper right of the "l".

intel®

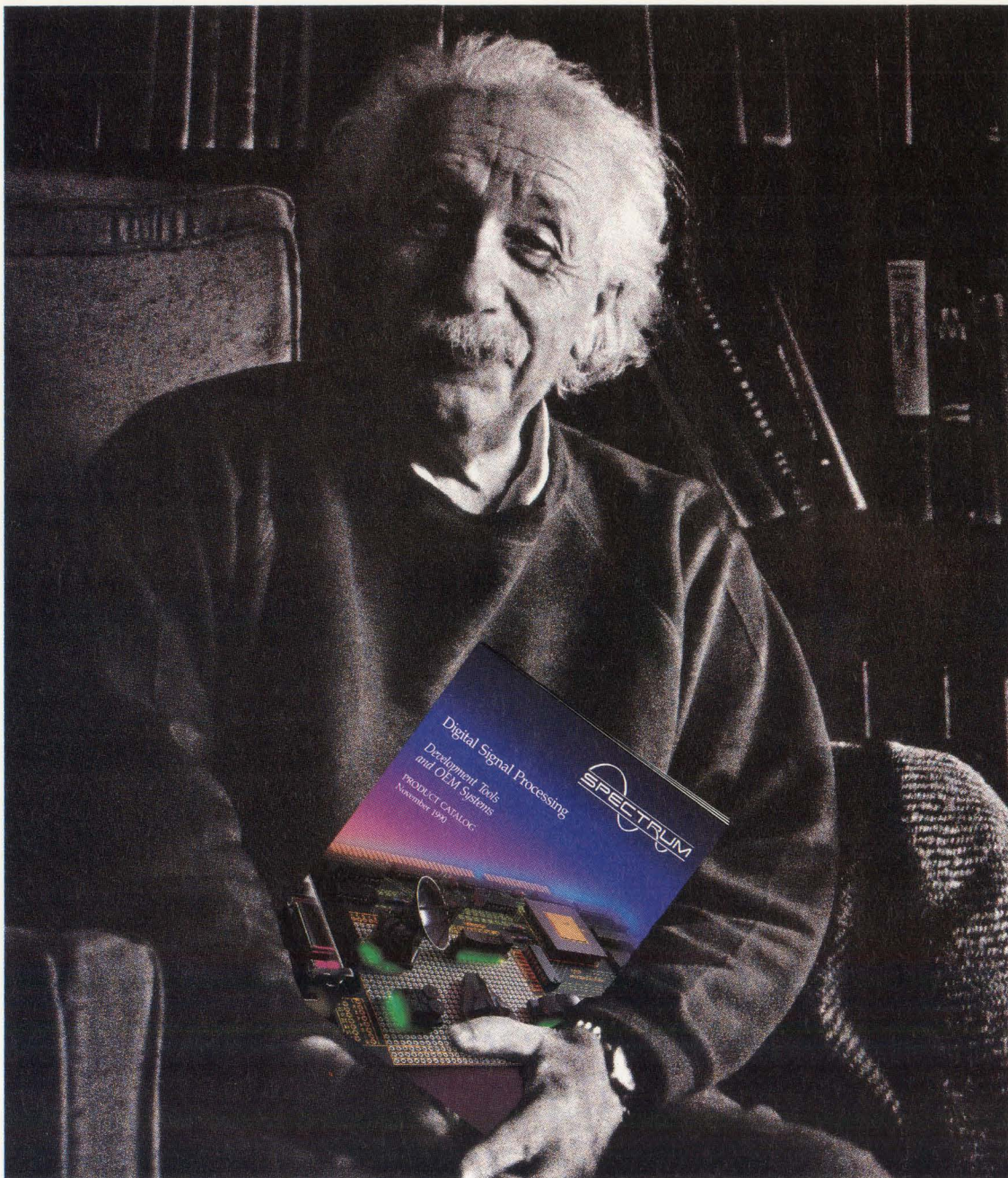

***"For Your OWN Unified DSP Solution,
Get a Copy of Spectrum's Latest Catalog."***

The smartest solution to digital signal processing (DSP) is to call Spectrum today. With our full line of system boards, processor boards, analog peripherals, even development and application tools, you'll be implementing leading-edge DSP systems in relatively no time.

For your free copy of our Catalog and "Einstein" Poster, write or call Spectrum Signal Processing at: 1500 West Park Drive, Westboro, MA 01581
1-800-323-1842 or (508) 366-7355 (Eastern Office) or
301-3700 Gilmore Way, Burnaby, B.C. V5G 4M1
1-800-663-8986 or (604) 438-7266 (Western Office)
It's a smart move.



Making DSP Technology Easy to Use

© 1990 Spectrum Signal Processing Inc. Original Einstein photograph by Sanford Roth, © Beulah Roth

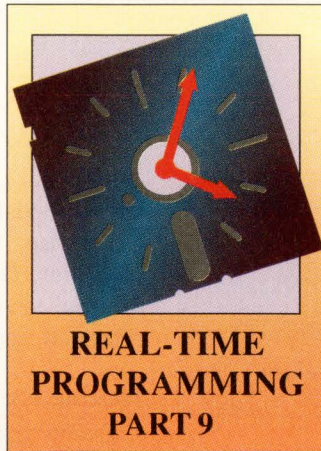

Semaphores and controlled shared variables

The discussion of task coordination methods continues in Part 9 of this series with an overview of how semaphores and controlled shared variables coordinate tasks in real-time applications. Part 10 will discuss task coordination and communication via signals.

David L Ripps, *Industrial Programming Inc*

In most applications, tasks must share sets of data, such as a table that is read by one task and updated by another. A second example of shared data are the global variables within a nonre-entrant procedure that could be called by different tasks.

A segment of code in which a task is accessing some shared resource is often called a "critical region" with respect to that resource. Not every reference to shared data forms a critical region, however. Accessing a fixed data table would not qualify. A region is critical only if there could be harmful interactions because of the sharing of the resource. For data, this means that the variables are both shared and alterable. More general resources, such as a printer or console, engender critical regions only when it is undesirable to intermix the

output from different tasks on the same page or screen.

Shared resources must be protected against potentially harmful interactions by permitting only one task at a time to enter a critical region. In the first example, while the data is being read, the update task must be blocked; while the data is being updated, the reader task must be blocked.

In real-time applications, a critical region can be so small that its existence is easily overlooked. Suppose that a certain memory-mapped byte (call it *lamps*) is used to control eight lights: a 1 in bit *i* turns the *ith* light on; a 0 turns it off. Initially all lights are off. At some point task **TskA** turns light 7 on by OR-ing with 0x80. A higher-priority task, **TskB**, turns light 0 on by OR-ing with 0x01. Most of the time this works. But occasionally, because of an ill-timed task switch, the two tasks are in the critical region for *lamps* at the same time:

TskA	lamps	TskB
lamps=>reg	0x00	blocked
OR reg with 0x80	0x00	blocked
preempted by TskB	0x00	lamps=>reg
preempted by TskB	0x00	OR reg with 0x01
preempted by TskB	0x00	reg=>lamps
preempted by TskB	0x01	...
reg=>lamps	0x01	blocked
...	0x80	blocked

From the book, *An Implementation Guide to Real-time Programming*, by David L Ripps, ©1989. Excerpted by permission of Prentice-Hall Inc, Englewood Cliffs, NJ.

Shared resources must be protected against harm by permitting only one task at a time to enter a critical region of code.

In this case, the final value is 0×80 instead of 0×81 . Problems such as these are insidious since they arise from subtle timing relationships.

Critical regions must be protected by guaranteeing one-task-at-a-time access. The MTOS-UX operating system provides two different facilities to achieve such mutual exclusion: the semaphore (SF) and the controlled shared variable (CSV), the SF being the simpler of the two.

A semaphore is an operating system object that is created by task request. In most applications, a separate SF is created for each critical region. (You could utilize a single SF to protect several regions, but this usually leads to excessive contention delays.) Prior to entering a critical region, every task must invoke *waisem* to wait for the corresponding SF to be free. If another task already has taken that SF, the new task waits. Queuing is based on the current priority of the waiting tasks. Upon exiting a critical region, a task must relinquish control to the next waiting task:

```
task A: request SF, enter critical region, ..., release SF
      |
      |
      |
---- time ---->
task B: request SF, <blocked for SF> enter critical
      | region, ..., release SF
```

A simple way to protect critical procedures is to make the first statement a wait-for-SF and the last statement before returning a release-SF. This method places all control aspects completely within the procedure. As a result, a caller does not have to know that the procedure is critical.

Creating a semaphore

A typical call to create a semaphore is

```
#define SF34 0x53463334
long int s34id; /*sample semaphore*/
s34id=crsem (SF34);
```

The argument is the external name associated with the semaphore. If a semaphore with the given key

already exists, the function just returns the identifier. Otherwise, the OS creates the SF and returns the identifier. Only in the unlikely case of not having any internal resources remaining does *crsem* fail. The value returned upon failure is **QUEFUL**.

Waiting for a semaphore

Every task that wishes to enter a critical region protected by semaphore **SF34** must first issue a wait-for-semaphore-to-be-free request. In most cases, the call would specify wait-forever (**WAIFIN**) **coordination**.

```
long int result; /*result of request*/
waisem (s34id,&result,WAIFIN);
```

The first argument must be the identifier of an existing SF, as provided by *crsem*. Otherwise, the function returns a failure value of **BADPRM**. Failure values are also stored within the results buffer addressed by the second argument. As usual, a maximum wait time can be added to the coordination mode. Thus,

```
waisem (s34id,&result,WAIFIN+10+SEC);
```

waits up to 10 sec for the SF, while

```
waisem (s34id,&result,CLEF2+1+MIN);
```

waits no more than 1 minute for that SF and sets local event flag 2 as a completion indicator. The variable *result* receives the final status when the request is completed: **NOERR**, for success; **BADPRM**, **TIMOUT**, or **QUEFUL** for failure.

Each SF either is free or is "owned" by a task that issued a *waisem* without a corresponding release. Ownership is not permanent; once the release is given, the SF becomes free again to be owned by another task.

With some operating systems, the SF has just two states: free and in use. (In use means owned by some task, but the identity of the owner is not necessarily retained.) These are called binary semaphores. With a binary SF, any task, including the current SF owner, must wait if it issues a wait-for-semaphore request and the target SF is already in use.

MTOS-UX provides counting, not binary, semaphores. The difference between the two is that a task does not wait if it issues *waisem* targeted to a semaphore that it currently owns. The SF has an internal use-count that is incremented by 1 each time the owner issues a wait request and is decremented by 1 each

time the owner issues a release. Note that the use-count is 0 when the SF is first created and when the SF is free.

There is value in providing counting semaphores, as opposed to just binary ones. In a complex application, it may be necessary for a task to make nested entries into critical regions for the same variables, say, in the main body of the code, and in some utility procedures. Each region separately needs the protection of the SF. With only a binary SF, it would be necessary for the task to know if it already has reserved the SF, and when it is safe to release it. With a counting SF, each critical region is bracketed by *waisem* and *rlsem* (release semaphore). Upon exiting from the last of these nested brackets, the SF count returns to 0, and the SF is automatically freed.

There is an essential difference between event flags and semaphores, even though both are used to achieve coordination between concurrent tasks. If several tasks are waiting for the same EF and it is set, then all those tasks continue simultaneously. If several tasks are waiting for the same SF and it is released, only one task (the one with the highest priority) continues; the others continue to wait.

The semaphore provided by MTOS-UX is similar to, but not exactly the same as, the semaphore proposed by Dijkstra (Refs 1 and 2). MTOS's *waisem* is close to Dijkstra's **P** or **wait**; MTOS's *rlsem* is close to Dijkstra's **V** or **signal**. The difference is that when a Dijkstra semaphore is created, a non-negative number (*s*) is assigned to the SF. Thereafter, *s* can increase or decrease (down to 0) via **P** and **V**. The action of **P** is

```
if (s > 0) then --s else block task on SF
```

The action of **V** is

```
if (any tasks are blocked on SF) then release 1 task else ++s
```

A Dijkstra SF need maintain only the use-count, *s*, and the list of tasks waiting for the SF; it need not record the current owner of the SF. Furthermore, the release **V** may precede the wait **P**, and the task that issues the release need not be the one that performed the wait. A Dijkstra semaphore permits *s* tasks to proceed into a critical region. These could be *s* different tasks, the same task *s* times, or any other combination that sums to *s*. MTOS-UX permits the same task to proceed any number of times, but blocks all other tasks.

Possession of a semaphore does not guarantee that a task cannot be interrupted by a task of equal or

greater priority. Pre-emption is always permitted. However, having the SF does guarantee that a pre-empting task will not be allowed past a *waisem* for that SF.

Deadly embrace

There is no limit to the number of semaphores that a task can reserve and the number of *waisem* requests it can have outstanding. Thus, a task may wait for one SF while it has reserved another. But beware the deadly embrace. To illustrate this phenomenon, suppose that task **D** has reserved SF **SFN1** and seeks SF **SFN2**. Task **E** already has SF **SFN2** and seeks SF **SFN1**. Deadlock.

In principle, the solution is easy: Have all tasks that seek multiple semaphores always seek them in the same order. In complex cases, this may not be easy to arrange.

Deadly embraces can also arise from other combinations of limited resources. For example, a task that has a semaphore and is seeking a memory pool allocation can deadlock with a task that has a large portion of the memory and is waiting for that SF.

To reduce the effects of a deadly embrace, avoid unlimited waits. Use **WAIFIN + 10 MS**, rather than just **WAIFIN**. And when you fail to obtain one of the needed resources, relinquish other limited resources and then try again. Furthermore, you should use different time limits in different tasks to make it unlikely that the same deadly embrace will reappear on each cycle of retry.

Releasing a semaphore

The request

```
result = rlsem (s34id);
```

decreases the use-count of the given semaphore and releases it to the next user if the count becomes 0. If the argument is not a semaphore currently held by the calling task, the function returns a failure value of **BADPRM**. Two values represent success: **NOERR** means that the SF was released and is now free; **NOTFRE** means that the SF is still held since the count has not been reduced to 0.

For best overall performance, a semaphore should be released immediately upon exit from the critical region.

Deleting a semaphore

In a dedicated real-time application it is likely that control objects, such as semaphores, would be created

Beware the "deadly embrace."
Two tasks are blocked, because each needs a semaphore that the other has reserved for itself.

by an initialization task and then remain "forever." In contrast, the semaphores created by transient (temporary) tasks are not likely to be permanent. Thus, the OS provides a mechanism to delete a semaphore once it is no longer needed.

```
result = dlsem (s34id);
```

If the argument is not the identifier of a semaphore, the function returns a failure value of **BADPRM**. The function returns **NOERR** for success.

Usually, the SF is not in use when it is deleted. If it is in use, the delete request is discarded, and the function returns the warning value **NOTFRE**. Each task that accesses a nonpermanent SF should delete the SF before it exits.

Controlled shared variables

As already noted, it is common in real-time applications for a set of tasks to share a group of alterable variables. The semaphore facility permits the OS to grant each task exclusive access to the variables to prevent possibly harmful interference.

In some cases, however, a task does not simply want exclusive access to the variables; it wants that exclusivity only after a certain relation exists among variables in the group. Until then the task must be blocked. For example, suppose the group contains 32 binary variables akin to event flags. The task might have to be blocked until a given set of these variables are all equal to 1. Thus, the task might have to leave the critical region so that other tasks can access and change the variables, but then re-enter the critical region when the desired relation is true (**Ref 3**). MTOS-UX includes five service calls that make it efficient to handle this type of coordination.

```
crcsv create a group of controlled shared variables
usecsv wait for exclusive access to a group of controlled
shared variables
waicsv wait for given function of controlled shared variables
to be TRUE
rlscsv release exclusive access to a group of controlled
shared variables
dlcsv delete a group of controlled shared variables
```

Creating a group of CSVs

The first step toward establishing a group of con-

trolled shared variables is defining their structure. To illustrate the creation and use of CSVs, assume that you are interested in maintaining multiple windows on a CRT screen. The supporting data is

```
#define NW 4 /*maximum number of windows*/

struct mw
{
long int wid[NW]; /*width*/
long int len[NW]; /*length*/
short int avl[NW]; /*0=available*/
... /*position and other data*/
};
```

You can create a set of controlled shared variables having this structure via the sequence

```
#define WNDO 0x574E444F
#define MWSIZ sizeof (struct mw)

struct mw *wndgid; /*identifier of group=addr of first
variable*/

wndgid=(struct mw*) crcsv (WNDO, (long) MWSIZ);
```

The first argument (**WNDO**) is the usual key associated with the group of variables. The second argument (**MWSIZ**) is the overall size of the variables, in bytes. If a group with the given key already exists, the group identifier is returned as the value of the function when the current and original lengths match. When they do not match, **BADPRM** is returned. For a new key, the OS attempts to create the group. If successful, again the identifier is returned. If there is not enough internal memory currently available for creation, the function returns the error code **QUEFUL**.

The group identifier is also the address of the first variable. The group is created with all variables initialized to 0.

Waiting for exclusive access to CSVs

For tasks to share the variables successfully, all users must wait until the OS grants exclusive access. (This is the implication of the term controlled.) If the task needs exclusive access with no preconditions having to be met, it would invoke the unconditional form of the wait request. For example,

```
usecsv (wndgid,NOEND);
```

provides a wait without limit, while

```
usecsv (wndgid,100+MS);
```

sets a maximum of 100 msec to the wait. If the group does not exist, *usecsv* returns **BADPRM**. If the requesting task already has exclusive access to the

group, the return value is **DUPTSK** (duplicate task request). If the group is available or becomes so during the specified interval, the return value is **NOERR**. Finally, if the group remains unavailable during the given interval, the request is canceled and the return value is **TIMOUT**.

Once exclusive access is granted, the task may freely and safely read and write the group variables. Recall that the group identifier is also the address of the first of the variables. Continuing the example just introduced,

```
if (usecsv (wndgid,100+MS)==NOERR)
{
    printf ("Size of window #1 is %lx by %lx\nr",
        wndgid->wid[0], wndgid->len[0]);
    .
    .
}
```

Releasing CSVs

When a task no longer needs its exclusive access to a group of CSVs, it must issue a release request.

```
rlscsv (wndgid);
```

The argument identifies the group. Once the group is released, the task must not alter any of the group variables, even though the OS does not have the ability to enforce this rule.

Calls to *waicsv* and *rlscsv* mark the entry into and exit from the critical region for the group, in a way analogous to *waitsem* and *rlsem*.

Waiting for the function of CSVs to be true

If only unconditional waits for access are needed, it is easier and faster to implement the variables as a task-level, public structure and protect the structure with an ordinary semaphore. The strength of CSVs arises when a task wishes to enter a critical region only when a certain condition is met among the variables. Alternatively, a task already within a critical region may wish to leave it until a condition is met.

The C function to wait for a certain relation among CSVs to be true is formally defined as

```
int waicsv (gid,bfun,interval)
long int gid,interval;
int (*bfun) ();
```

The first argument identifies the variables group, the second argument supplies the address of the evaluation function, and the third argument indicates the maximum time to wait before returning from *waicsv*. If the

interval is **NOEND**, the service can never time out. Possible return values are **NOERR** (for success), **TIMOUT** (if *bfun* is never TRUE during the specified interval), **QUEFUL** (if the timer cannot be allocated), and **BADPRM** (if the group does not exist).

When it is called, *bfun* is presented with a pointer to the group variables as its only argument. The function must return an integer value of TRUE (nonzero) if the task is to be blocked or FALSE (zero) if the task is to be continued. No task-level service calls are permitted within *bfun*.

The wait service call may be made either as a way into the critical region or as a way to exit the region until *bfun* is TRUE. In either case, *waicsv* does not return successfully until both *bfun* is TRUE and the task has been given exclusive access to the variables.

The *bfun* evaluation function is called immediately after *waicsv* is invoked if the requesting task already has exclusive access to the variables or the variables are free. If the task is to be blocked, *bfun* will be called again each time a task leaves the critical region via *rlscsv* or *waicsv*. Whenever more than one task could be unblocked because its evaluation function is TRUE, only the highest priority task will be continued at that point. The others will have to wait until the variables are available again.

To complete the example already started,

```
static int idx;          /*index of available window*/
static int mwid;        /*min width of available window*/
static int mlen;        /*min length of available window*/

int testw ();           /*test value function*/

waicsv (wndgid,testw, 5+MIN); /*wait for testw to be TRUE*/
.
.
testw (data)            /*sample function*/
{
    struct mw *data;
    {
        register int i; /*search index*/

        for (i=3;i>=0;--i)
        {
            if ((data->avl[i]!=0)&&
                (data->wid[i]>=mwid)&&(data->len[i]>=mlen))
            {
                data->avl[i]=1; /*take window*/
                idx=i; /*note which one*/
                return (1); /*end wait*/
            }
            return (0); /*keep waiting*/
        }
    }
}
```

Whether or not a task had exclusive access to the group originally, it loses this privilege while it is blocked and regains it when the task becomes unblocked because the evaluation function was satisfied. However, it does not have access upon a time out or

other unsuccessful return. Thus, the application must have the following overall structure

```
if (waicsv (wndgid,testw,5+MIN)==NOERR)
{
.
.
.
rlscsv (wndgid);
}
```

Deleting a group of CSVs

When a group of controlled shared variables is no longer needed by any task, it may be deleted by invoking

```
result = dlcsv (wndgid);
```

The function returns **NOERR** for success and **BADPRM** for failure.

The same problem arises in deleting a group of CSVs as in deleting a group of public event flags: how to know when the last task is finished with the group so that it can be removed. The same solution is used. Thus, *dlcsv* does not immediately delete the group if there are any tasks waiting because of *waicsv*. If there are, the group is internally marked "deletion requested." Actual removal does not occur until there are no more tasks waiting. In the interim, all CSV functions may be applied in their normal manner.

Priority inversion

Once the OS grants task **LP** a semaphore, a group of controlled shared variables, or any other exclusive-access object, the OS is not free to take the object back and give it to another task. (That would defeat the whole purpose of providing exclusive-access objects.) As a result, if a higher-priority task (**HP**) seeks the same object, it must wait until **LP** releases the object. But, because **LP** is a low-priority task, it may take a very long time for **LP** to execute. Thus, a low-priority task can block a higher-priority one for an indefinite period. This is known as priority inversion.

Equivalent forms of priority inversion can occur when a task

- is blocked waiting to restart another task that is executing at a low priority,
- is blocked waiting to communicate with a partner that is executing at a low priority,
- or needs memory or another shared resource that is held by a low-priority task,

among other cases. This is not the same as a deadly embrace since in principle the high-priority task does get to run eventually.

In very simple cases, it is tempting to have the OS temporarily raise the priority of task **LP** to that of **HP** to break the inversion. However, because of the

many and subtle ways in which priority inversions can occur, and the complexity of nested blockages, there is no easy way to avoid inversions completely. These problems are actively being investigated at the Software Engineering Institute of Carnegie-Mellon University (**Ref 4**) and other places.

To sum up, a critical region is a segment of code in which alterable variables or some other resource is being shared by two or more tasks. The resource must be protected against potentially harmful interactions by enforcing one-task-at-a-time entry into any critical region for that resource. Semaphores and controlled shared variables can provide the required mutual exclusion.

A semaphore is sufficient to protect a set of shared alterable variables when all entries into their critical regions are unconditional, that is, do not depend upon the current values stored in the variables. A semaphore is created for the set of variables. Before every task enters a critical region, it requests temporary ownership of that SF by issuing *waicsem*. The OS allows only one task to proceed; it blocks all others. When a task leaves the critical region, it releases the SF by issuing *rlssem*. If there are no tasks waiting for the SF, the SF is set free. Otherwise, only the highest priority task is unblocked.

Controlled shared variables are a further refinement of the idea of semaphore protection. The request to enter a critical region can contain a condition function. Now the task may be blocked until both exclusive access can be granted and the function (evaluated with respect to the variables) returns TRUE. The same service also permits a task that is already in a critical region to exit until the same two criteria are met.

Part 10 of this series will discuss task coordination and communication via signals. **EDN**

References

1. Dijkstra, EW, "Cooperating Sequential Processes," Technological University, Eindhoven, Netherlands, 1965. Reprinted in F Genuys ed, *Programming Languages*, New York: Academic Press, 1968.
2. Deitel, HM, *An Introduction to Operating Systems*, Section 4.11, Reading, MA: Addison-Wesley, 1984.
3. Brinch Hansen, P, *Operating System Principles*, Englewood Cliffs, NJ: Prentice-Hall, 1973.
4. Locke, D and L Sha, et al, "Priority Inversion and Its Control: An Experimental Investigation," Second International Workshop on Real-Time Ada Issues, June 1988. Reprinted in Sha, L, ed, "An Overview of Real-Time Scheduling Algorithms," Software Engineering Institute, Dept of Computer Science, Carnegie-Mellon University, Pittsburgh, PA, June 8, 1988.

Article Interest Quotient (Circle One)
High 479 Medium 480 Low 481

NEW

You'd Have to Go to Great Lengths to Match the Capacity of Our New VALUMAX™ Cells.



No matter how you stack it, when it comes to capacity, other Ni-Cd batteries seem to come up short. That's because Gates' new VALUMAX cells pack more capacity than any other standard cells on the market.

At Gates, we've gone to great lengths to give you the longest possible run times in a wide range of cell sizes for virtually every application. For example, the VALUMAX C cell gives you up to 25% more run time

than any other standard C cell. And the VALUMAX 4/5 Cs, Cs and AA cells deliver as much as 33%

more run time than even our closest competitor.

In fact, with VALUMAX you get premium performance without paying the premium price. And that makes VALUMAX the best value—dollar for dollar—of any standard cell you can buy.

The way we see it, the others still have a long way to go. And, at Gates, we think you shouldn't have to go to great lengths when you want a standard cell that lasts a long time. Gates

Energy Products, Inc., P.O. Box 861, Gainesville, FL 32602, 1-800-67-POWER.



The power of great ideas.



The 1991 EDN Caravan Tour

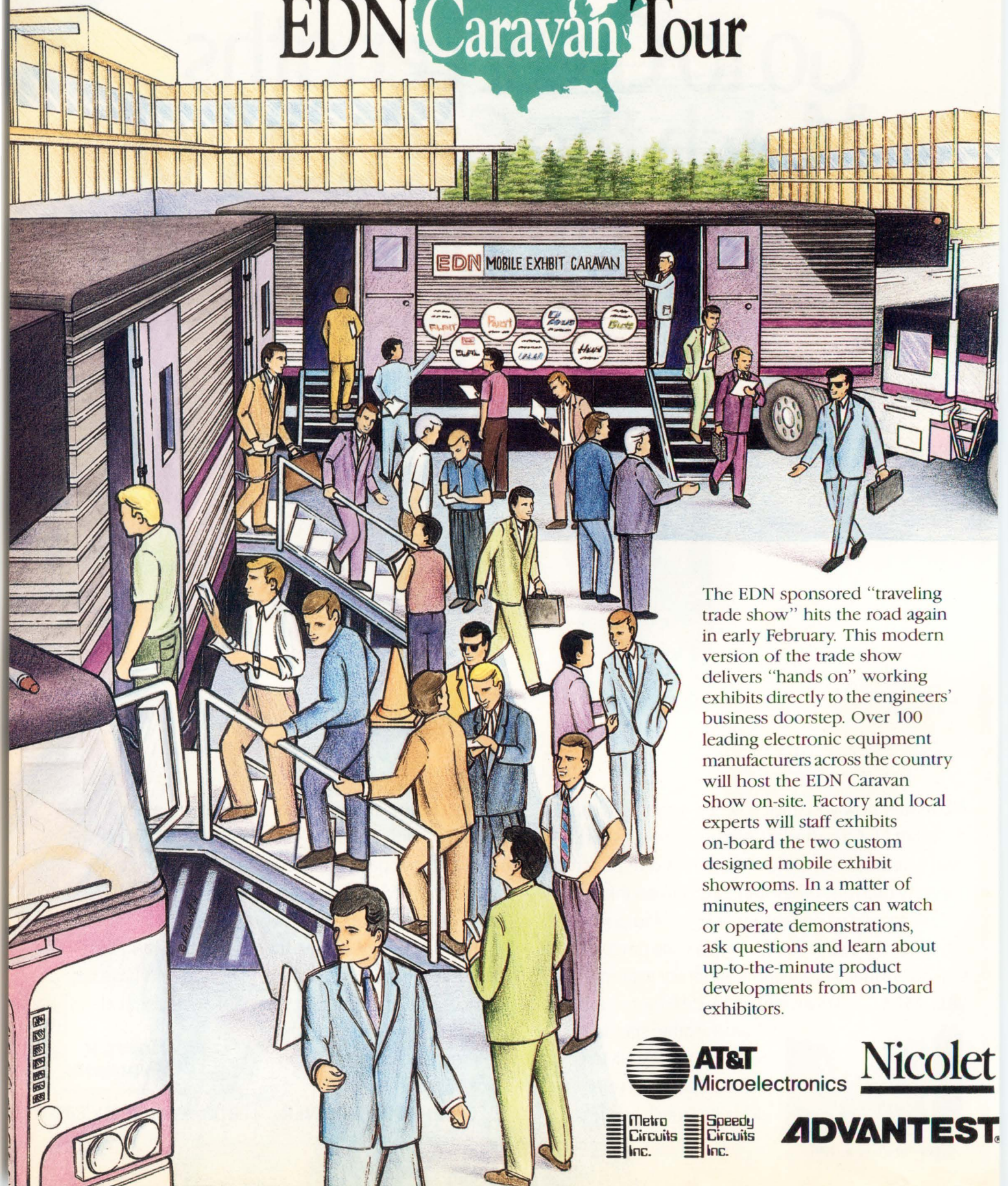

The EDN sponsored "traveling trade show" hits the road again in early February. This modern version of the trade show delivers "hands on" working exhibits directly to the engineers' business doorstep. Over 100 leading electronic equipment manufacturers across the country will host the EDN Caravan Show on-site. Factory and local experts will staff exhibits on-board the two custom designed mobile exhibit showrooms. In a matter of minutes, engineers can watch or operate demonstrations, ask questions and learn about up-to-the-minute product developments from on-board exhibitors.



AT&T
Microelectronics

Nicolet



Speedy Circuits Inc.

ADVANTEST

EDN CARAVAN ELECTRONIC SHOW TOURS

Bringing New Products and Ideas to Your Business Doorstep

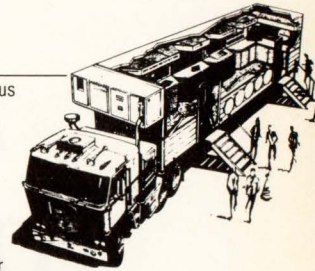

DATE	TIME	SITE
2/11	11:00-2:00 AM-PM	HUGHES AIRCRAFT TUSCON Old Nogales Hwy., Tucson, AZ
2/12	9:00-11:30 AM	IBM CORPORATION S. Rita Road, Tucson, AZ
2/12	1:30-4:00 PM	AiRESEARCH TUSCON DIV. 11100 N. Oracle Rd., Tucson, AZ
2/13	9:00-11:30 AM	MOTOROLA GEG, Strategic Electronics 2501 S. Price Rd., Chandler, AZ
2/13	1:00-3:00 PM	HONEYWELL, Industrial Automation 16404 N. Black Canyon Hwy, Phoenix, AZ
2/14	9:00-12:00 AM	MOTOROLA GEG, Communications/Tactical 8201 E. McDowell Rd., Scottsdale, AZ
2/14	1:30-4:00 PM	HONEYWELL INC., Air Transport Avionics 21111 N. 19th Avenue, Phoenix, AZ
2/15	9:00-11:30 AM	HONEYWELL INC., Bus/Commuter Aviation 5353 W. Bell Road, Glendale, AZ
2/15	1:00-3:00 PM	HONEYWELL INC., Satellite Systems 19019 N. 59th Avenue, Glendale, AZ
2/18	9:00-12:00 AM	GENERAL DYNAMICS, Electronics & Convair Convair & Missile Drive, San Diego, CA
2/18	1:30-4:00 PM	SAI TECHNOLOGY 4224 Campus Point Court, San Diego, CA
2/19	8:30-10:00 AM	SCIENTIFIC-ATLANTIC 13112 Evening Creek Dr., San Diego, CA
2/19	11:30-1:15 AM-PM	TRW MEAD DIVISION 1 Rancho Carmel Drive, San Diego, CA
2/19	2:00-4:30 PM	NGR CORPORATION 16550 W. Bernardo Drive, San Diego, CA
2/20	8:30-11:00 AM	UNISYS CORPORATION 25725 Jeronimo Road, Mission Viejo, CA
2/20	12:00-1:30 PM	PRINTRONIX, INC. 17500 Cartwright, Irvine, CA
2/20	2:30-4:00 PM	AST RESEARCH 16215 Alton Parkway, Irvine, CA
2/21	10:00-12:30 AM-PM	LORAL AERONUTRONIC Ford Road, Newport Beach, CA
2/21	1:30-4:00 PM	ROCKWELL INTL, Satellite & Space 2600 Westminster Blvd., Seal Beach, CA
2/22	9:00-11:30 AM	ROCKWELL INTL, Autonetics 3370 Miraloma Avenue, Anaheim, CA
2/22	1:00-3:30 PM	CALCOMP INC. 2411 W. La Palma Avenue, Anaheim, CA
2/25	9:00-12:00 AM	SUN MICROSYSTEMS 2550 Garcia Avenue, Mountain View, CA
2/25	1:30-4:00 PM	GTE Government Systems 100 Ferguson Drive, Mountain View, CA
2/26	9:00-10:30 AM	NORTHERN TELECOM INC. 685A East Middlefield Road, Mountain View, CA
2/26	11:15-12:30 AM-PM	ACUSON INC. 1220 Charleston Road, Mountain View, CA
2/26	2:00-4:00 PM	ARGOSystems, Inc. 310 N. Mary Avenue, Sunnyvale, CA
2/27	8:30-11:00 AM	3-COM CORPORATION 5400 Bayfront Plaza, Santa Clara, CA
2/27	12:00-1:30 PM	CAE-LINK CO., Link Flight Simulation 1077 E. Arques Avenue, Sunnyvale, CA
2/27	2:15-4:15 PM	STANFORD TELECOMMUNICATIONS INC. 2421 Mission College Blvd., Santa Clara, CA
2/28	8:00-10:00 AM	LOCKHEED MISSILE & SPACE CO. 1111 Lockheed Way, Sunnyvale, CA
2/28	10:30-12:00 AM	LOCKHEED MISSILE & SPACE CO. 1111 Lockheed Way, Sunnyvale, CA
2/28	1:30-4:00 PM	LORAL CORPORATION, Space & Range 1260 Crossman Avenue, Sunnyvale, CA
3/1	9:00-10:00 AM	DIASONICS INC. 1565 Barber Lane, Milpitas, CA
3/1	11:00-1:00 AM-PM	EVEREX SYSTEMS 48431 Milmont Drive, Fremont, CA
3/4	9:00-1:00 AM-PM	BOEING COMMERCIAL AIRPLANE-Everett Complex 526 Casino Freeway, Everett, WA
3/4	2:30-4:00 PM	ALLLIANT TECHSYSTEMS INC. 6500 Harbour Heights Parkway, Everett, MA

DATE	TIME	SITE
3/5	9:00-10:30 AM	ELDEC CORPORATION, Martha Lake Campus 16700 13th Avenue, Lynnwood, WA
3/5	11:30-1:00 AM-PM	ELDEC CORPORATION, Sensing System 22000 Bothel Way S.E., Bothel, WA
3/5	2:00-4:00 PM	SUNDSTRAND DATA CONTROL 15001 N.E. 36th Street, Redmond, WA
3/6	9:00-11:30 AM	BOEING AEROSPACE-Plant 2 7755 East Marginal Way So., Seattle, WA
3/6	1:00-3:30 PM	BOEING AEROSPACE-Developmental Center 9725 East Marginal Way So., Seattle, WA
3/7	9:00-12:00 AM	BOEING COMMERCIAL AIRPLANE-Renton Plant Logan Avenue No., Renton, WA
3/7	1:30-4:00 AM	BOEING ELECTRONICSS & SPACE CENTER 820 S.W. 41st Street, Renton, WA
3/8	9:00-11:30 AM	NEC AMERICA, INC. 3100 N.E. Shute Road, Hillsboro, OR
3/8	1:30-3:30 PM	SEQUENT COMPUTER INC. 15450 S.W. Koll Parkway, Beaverton, OR
3/11	8:30-11:00 AM	LAWRENCE LIVERMORE NAT'L LABORATORIES 7000 East Avenue, Livermore, CA
3/11	1:30-4:00 PM	ROLM SYSTEMS INC. 4900 Old Ironsides Drive, Santa Clara, CA
3/12	9:00-11:00 AM	TANDEM COMPUTERS 19333 Vallco Parkway, Cupertino, CA
3/12	12:30-3:30 PM	APPLE COMPUTER, INC. 20650 Valley Green Drive, Cupertino, CA
3/13	8:00-10:30 AM	LORAL CORP., Western Development Labs 3200 Zanker Road, San Jose, CA
3/13	11:30-1:00 AM-PM	MAXTOR CORPORATION 211 River Oaks Parkway, San Jose, CA
3/13	2:00-4:00 PM	CONNERS PERIPHERALS 3061 Zanker Road, San Jose, CA
3/14	8:30-11:00 AM	LORAL ROLM MIL-SPEC COMPUTER 3151 Zanker Road, San Jose, CA
3/14	12:30-2:00 PM	UNISYS CORPORATION 2700 N. First Street, San Jose, CA
3/14	2:45-4:30 PM	WATKINS-JOHNSON COMPANY 2525 N. First Street, San Jose, CA
3/15	9:00-11:30 AM	IBM CORPORATION 5600 Cottle Road, San Jose, CA
3/15	12:30-3:00 PM	LITTON APPLIED TECHNOLOGY 4747 Hellyer Avenue, San Jose, CA
3/18	9:00-11:30 AM	DELCO ELECTRONICS 6767 Hollister Avenue, Goleta, CA
3/18	1:00-3:30 PM	HUGHES AIRCRAFT, Santa Barbara Research Center 75 Coromar Drive, Goleta, CA
3/19	9:00-10:30 AM	TELEDYNE ELECTRONICS 649 Lawrence Drive, Newbury Park, CA
3/19	11:30-1:15 AM-PM	TELEDYNE SYSTEMS 19601 Nordhoff Street, Northridge, CA
3/19	2:00-4:00 PM	MICROPOLIS CORPORATION 21211 Nordhoff Street, Chatsworth, CA
3/20	9:00-11:00 AM	HUGHES AIRCRAFT CO., Space & Communications 222 N. Sepulveda Blvd., El Segundo, CA
3/20	11:30-1:30 AM-PM	HUGHES AIRCRAFT CO., Electro-Optical/Data Syst. 2000 E. El Segundo Blvd., El Segundo, CA
3/20	2:15-4:30 PM	XEROX CORPORATION 701 So. Aviation Blvd., El Segundo, CA
3/21	8:30-11:00 AM	TRW ELECTRONIC SYSTEMS One Space Park, Redondo Beach, CA
3/21	11:45-1:15 AM-PM	MAGNAVOX Advanced Products & Systems 2829 Maricopa Street, Torrance, CA
3/21	2:15-4:30 PM	HUGHES AIRCRAFT CO., Electron Device/Microwave 3100 West Lomita Blvd., Torrance, CA
3/22	8:30-11:00 AM	JET PROPULSION LABORATORIES 4800 Oak Grove Parkway, Pasadena, CA
3/22	12:00-1:30 PM	GENERAL DYNAMICS, Air Defense Systems Div. 1675 West Mission, Pomona, CA
3/22	2:15-4:00 PM	GENERAL DYNAMICS, Air Defense Systems Div. 11000 East Fourth St., Rancho Cucamonga, CA

B Basler Electric

Tektronix
WAVETEK



BUSSMANN

EAGLE **EP** **PICHER**

CAHNERS
CAPS
Computer Aided
Product Selection

APEX
μ tech

MITSUBISHI
ELECTRONICS

DATA I/O
Corporation

LeCroy
Innovators in Instrumentation

CIRCLE NO. 59

For the fastest SRAMs, come to the record holder.



NEC offers the fastest CMOS SRAMs on the market today: 64K/12ns, 256K/15ns, and 1M/20ns.

That's fast enough to eliminate wait states in most applications, including mainframes, minis, workstations and mass storage. Our 256K family includes a device with a parity check function.

All our SRAMs are fabricated with NEC's leading-edge 0.8 μ m CMOS technology. And we're already developing 4M fast SRAMs

with 0.55 μ m technology.

If you're working on a speed-intensive system, we've got some

very quick solutions. For more information on the fastest SRAMs, contact NEC today.

Capacity	Part Number	Organization	Access Time (ns)	Package
64K	μ PD4361B	64K x 1	12/15/20	DIP/SOJ
	4362B	16K x 4	12/15/20	DIP/SOJ
	4363B	16K x 4 OE	12/15/20	DIP/SOJ
	4368	8K x 8	15/20	DIP/SOJ
72K	4369	8K x 9	15/20	DIP/SOJ
	43251B	256K x 1	15/20/25	DIP/SOJ
256K	43254B	64K x 4	15/20/25	DIP/SOJ
	43253B	64K x 4 OE	15/20/25	DIP/SOJ
	43258A	32K x 8	15/20/25	DIP/SOJ
	43250A	32K x 8 (with parity check)	15/20/25	DIP/SOJ
288K	43259A	32K x 9	15/20/25	DIP/SOJ
1M	431001	1M x 1	20/25/35	SOJ
	431004	256K x 4	20/25/35	SOJ

For fast answers, call us at:

USA Tel:1-800-632-3531. Fax:1-800-729-9288. Germany Tel:0211-650302. Telex:8589960. The Netherlands Tel:040-445-845. Telex:51923.
Sweden Tel:08-753-6020. Telex:13839. France Tel:1-3067-5800. Telex:699499. Spain Tel:1-419-4150. Telex:41316. Italy Tel:02-6709108. Telex:315355.
UK Tel:0908-691133. Telex:826791. Ireland Tel:1-6794200. Telex:90847. Hong Kong Tel:755-9008. Telex:54561. Taiwan Tel:02-719-2377. Telex:22372.
Korea Tel:02-551-0450. Fax:02-551-0451. Singapore Tel:4819881. Telex:39726. Australia Tel:03-267-6355. Telex:38343.



State-machine design curbs illegal states and transitions

You can learn theoretical state-machine design from myriad sources, but most neglect to tell you how to design state machines that work reliably. Such neglect is unfortunate—and unnecessary—because reliability is fairly easy to come by.

Ricardo Rabinovich, *Librascope Corp*

Different design enhancements can decrease the likelihood that your state machine will reach an illegal state or illegally reach a legal state. Synchronizing or deglitching the inputs and filtering or decoupling the supply and ground rails are among the less obtrusive techniques you can use.

Unless the number of valid states in your state machine is a power of 2, the machine will have illegal states. An illegal state is a state that the machine cannot reach during its normal operation. The machine reaches an illegal state as a result of electrical noise, a power glitch, transient illegal input combinations, or other unfavorable conditions.

Another functional concern in designing state machines is the problem of the machine's reaching a legal state via an illegal transition. Most textbooks recommend that you explicitly specify a legal transition from illegal states to an initial idle state to recover from illegal state assignments. However, they generally do not address illegal transitions to legal states.

Unfortunately, in practical situations, defining an

idle state is often difficult. Many state-machine designs have more than one idle state. Even when only a single idle state exists, changing to that state could hang-up the machine or system by leaving the system waiting for some output that doesn't occur.

Synchronizing and deglitching inputs require a simple circuit. **Fig 1** shows a circuit that synchronizes an input with the system clock regardless of the input signal's normal polarity. This circuit consists of three D-type flip-flops, one of which has a multiplexed input and an exclusive-OR gate. The same clock-edge clocks all three flip-flops. The exclusive-OR gate validates the input-level change before that input change is transmitted to the rest of the state machine. If both inputs of the exclusive-OR gate are the same, the mul-

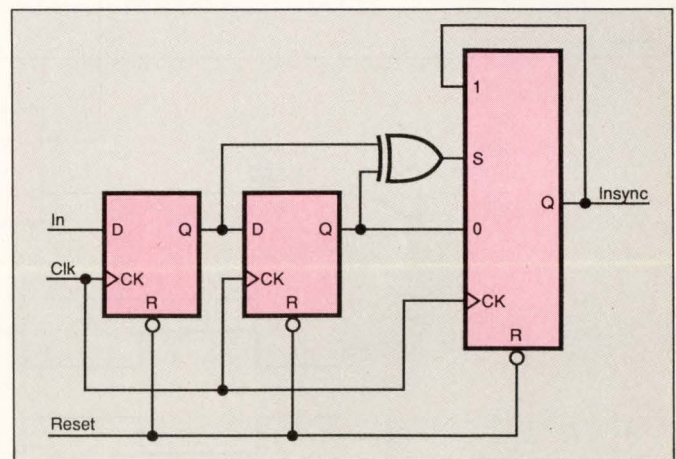

Fig 1—A synchronizer circuit, such as this one, improves state-machine reliability by aligning asynchronous inputs to the clock while removing input glitches.

State machines aren't supposed to reach illegal states, but because they occasionally do, you should design conservatively.

plexer selects the state machine's input signal. If the input levels are different, the multiplexer refreshes the existing signal. Therefore, the input signal must remain stable for at least one clock cycle before the state machine acknowledges it. In addition to synchronizing and deglitching inputs, this pipeline arrangement prevents a metastable condition from propagating through the state machine.

The second step toward freedom from illegal states is to filter and decouple the power and ground rails. Usually all you have to do is connect a 0.1- μ F capacitor between the two. Be sure to connect the decoupling capacitor as close as possible to each component. Decoupling is especially important when using high-speed logic, such as FAST or FCT parts.

Even with these precautions, building a highly reliable state machine demands that your design include logic that specifically prevents unwanted states and illegal transitions to valid states. An effective technique for detecting and suppressing illegal transitions is to sample the value of the next state in the middle of the system clock cycle and compare it with the value of the present state. If the transition is legal, the next state becomes the present state at the beginning of

the next clock cycle. If the transition is not legal, the clock latches the present state again, ignoring the next state.

Is the potential transition legal?

The block diagram in Fig 2 demonstrates this technique. (For clarity, logic blocks have been labeled in all upper case, and signals have been labeled in lower case with an initial capital.) This circuit uses the SYNC block from Fig 1. Insync is the output signal of the SYNC block and is an input to the NSD (next-state decoder) block. The NSD is a combinatorial circuit that generates the next-state signal, Unsig. Unsig is strictly a function of Insync and the present state, Prst, of the state machine, and does not indicate the legality of the transition. The falling edge of the system clock latches Unsig into the NSR (next-state register) in the middle of the clock cycle. The output of NSR and the Prst signal are inputs into the NSVAL (next-state validation) block of combinatorial logic, which evaluates the legality of the transition between states. The output of NSVAL controls a multiplexer. If the transition is illegal, then the NSVAL output is low, and the multiplexer feeds the state machine's present state back to

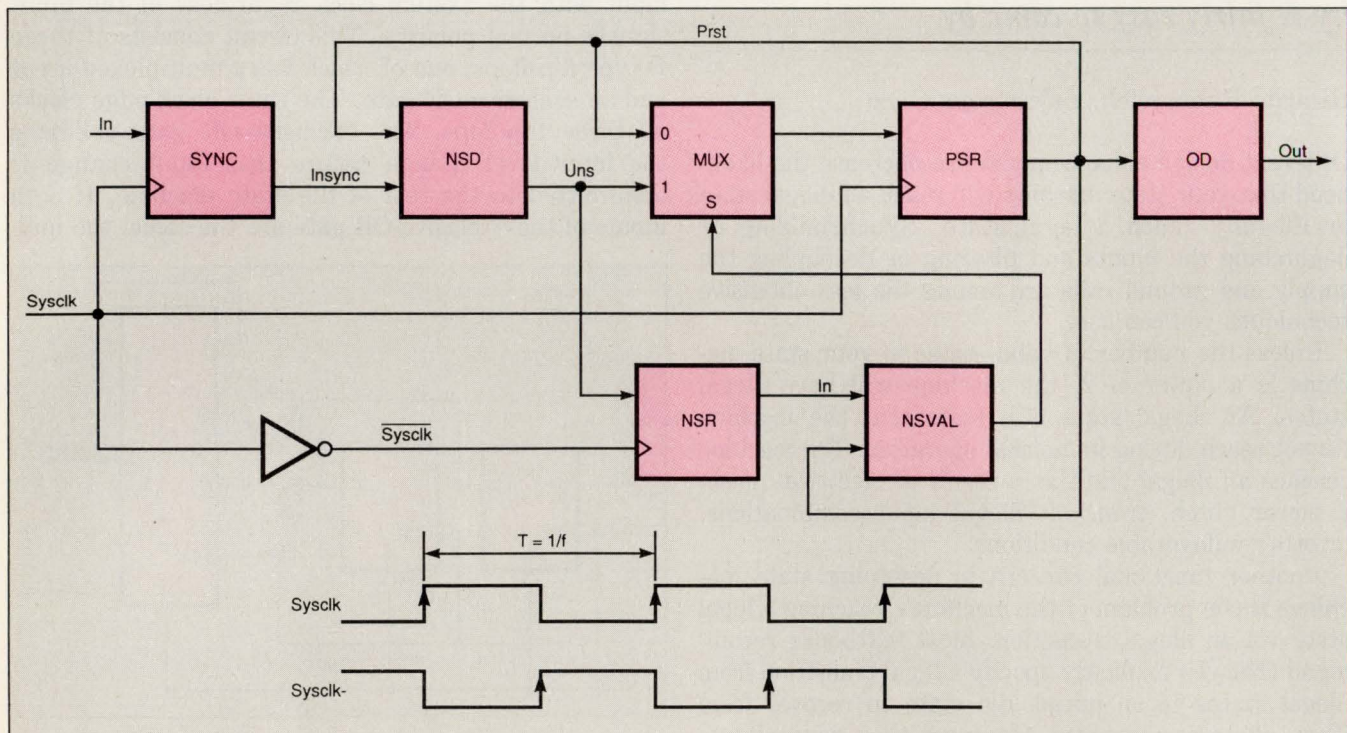

Fig 2—Adding logic that checks the legality of all state transitions before the machine executes them reduces the risk that your machine might enter states illegally.

the PSR (present-state register). If the transition is legal, the NSVAL output goes high and the rising clock latches Uns into the PSR.

The NSVAL block checks whether a transition is legal on the rising edge of Sysclk. The OD (output decoder) block drives the output signal, Out, as a function of the present state only, regardless of changes that occur at the input of the state machine. By definition, then, the state machine in Fig 2 is a Moore machine, and its outputs are solely a function of the present state. A state machine whose outputs are a function of both the inputs and the machine's present state is a Mealy machine. You can use similar logic to design reliable Mealy machines. However, please note that Mealy machines are more prone to output glitches because the inputs and the system clock are asynchronous.

Designing a simple state machine will help clarify these reliability-ensuring techniques. Assume you must create a firing mechanism for a rocket launcher. To minimize the risk of false launches, the operation of the firing system requires the sequential assertion of two toggle switches. The wrong toggle-switch sequence invalidates the entry. The state diagram in Fig 3 describes the machine.

Toggle switches X_1 and X_2 are the inputs to the system. The logic value of each switch is 0 when idle and 1 when active. Output variable Y controls the launch of the missile; the missile launches when Y is 1.

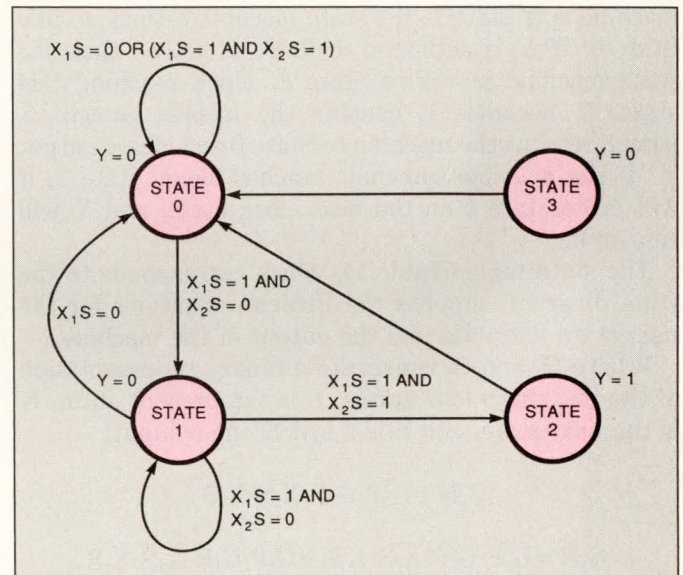

Fig 3—This state machine, controlled by inputs X_1S and X_2S , launches a rocket from State 3.

Calculating how fast the machine will run

After you have designed your state machine, you often want to know its maximum operating frequency: $f_{MAX} = 1/T_{MIN}$. To simplify the calculations, you can assume the inverter delay is negligible. The worst-case delay among four circuit paths limits the maximum operational frequency. First, the delay through the SYNC circuit in Fig 1 is

$$T_{MIN1} > T_{MET} + T_{XORD} + T_{FFMXS}$$

and

$$T_{MIN2} > T_{CKD} + T_{XORD} + T_{FFMXS}'$$

where T_{MET} is the duration of metastability for a given MTBF,

T_{XORD} is the exclusive-OR gate delay, T_{FFMXS} is the MUX and flip-flop data setup time, and T_{CKD} is the flip-flop clock-to-output delay.

Then, the half-cycle delay through the SYNC circuit and the next-state register in the state machine of Fig 2 is

$$T_{MIN3/2} > T_{SYNCD} + T_{NSDD} + T_{NSRS},$$

where T_{SYNCD} is the clock-to-output delay of the SYNC block, T_{NSDD} is the NSD (Next State Decoder) block delay, and T_{NSRS} is the NSR (Next State Register) data set up time.

Lastly, the half-cycle delay from the NSR block through the

present-state register in Fig 2 is

$$T_{MIN4/2} > T_{NSRD} + T_{NSVALD} + T_{MUXD} + T_{PSRS},$$

where T_{NSRD} is the NSR (Next State Register) clock-to-output delay, T_{NSVALD} is the NSVAL (Next State Validation) block delay, T_{MUXD} is the MUX block delay, and T_{PSRS} is the PSR (Present State Register) data set up time.

The longest of the above four delays determines your state machine's operating frequency:

$$f_{MAX} = 1/T_{MIN},$$

where $T_{MIN} = \text{MAX}(T_{MIN1}, T_{MIN2}, 2 \cdot T_{MIN3/2}, 2 \cdot T_{MIN4/2})$.

A state machine should test all transitions to determine whether they are legal before the machine executes them.

State 0 is the idle state. As long as X_1 is 0, the machine ignores the value of X_2 and Y remains 0. When only X_1 is activated, the state machine goes to state 1 while Y remains 0. If X_1 is released while the state machine is at state 1, the state machine returns to idle State 0. If X_2 is activated while X_1 is active, then the state machine moves to State 2. Upon reaching this state, Y becomes 1, causing the missile launch. A launch returns the machine to State 0 and clears output Y . If the machine somehow reaches illegal state 3, it will go to state 0 on the next clock cycle, and Y will remain 0.

The state table (Table 1), which corresponds to the state diagram, supplies the Boolean equations for the next-state variables and the output of the machine.

Where G_1 and G_2 constitute a binary representation of the machine's four states, P is the present state, N is the next state, and S is a synchronous input:

$$G_2N = \overline{G_2P} \cdot G_1P \cdot X_2S \cdot X_1S,$$

$$G_1N = \overline{G_2P} \cdot \overline{G_1P} \cdot \overline{X_2S} \cdot X_1S + \overline{G_2P} \cdot G_1P \cdot \overline{X_2S} \cdot X_1S,$$

$$\text{and } Y = G_2P \cdot \overline{G_1P}.$$

A Karnaugh map can help you simplify G_1N :

		$X_2S \ X_1S$			
		00	01	11	10
G_2P	G_1P	00	1	3	2
		4	5	7	6
G_1P	11	12	13	15	14
		8	9	11	10

which yields

$$G_1N = \overline{G_2P} \cdot \overline{X_2S} \cdot X_1S.$$

The logic in the equations for G_1N and G_2N constitutes the NSD block. The equation for Y defines the OD block. The next-state validation circuit, NSVAL, is a combinatorial circuit that analyzes each next-state transition for all possible present states and determines whether the transition is legal. If the

Table 1—Missile launch when $Y=1$

Present state		Inputs		Next state		Output
G_2P	G_1P	X_2S	X_1S	G_2N	G_1N	Y
0	0	X	0	0	0	0
0	0	1	1	0	0	0
0	0	0	1	0	1	0
0	1	X	0	0	0	0
0	1	0	1	0	1	0
0	1	1	1	1	0	0
1	0	X	X	0	0	1
1	1	X	X	0	0	0

Table 2—Multiplexer control logic

G_2P	G_1P	G_2N	G_1N	M
0	0	0	0	1
0	0	0	1	1
0	0	1	0	0
0	0	1	1	0
0	1	0	0	1
0	1	0	1	1
0	1	1	0	1
0	1	1	1	0
1	0	0	0	1
1	0	0	1	0
1	0	1	0	0
1	0	1	1	0
1	1	0	0	1
1	1	0	1	0
1	1	1	0	0
1	1	1	1	0

transition is legal, output variable M is 1. Conversely, M is 0 for all illegal transitions. The output of this circuit controls the multiplexer block.

The diagram shows legal transitions

Inspecting Fig 3 allows you to determine the legal transitions. These transitions are:

- From State 0, the state machine can go to State 0 or 1.
- From State 1, the state machine can go to States 0, 1, or 2.
- From State 2, the state machine will go to State 0.
- From State 3, the state machine will go to State 0.

The output variable, M , is a function of both the

DESIGN WITH ANALOG WORKBENCH II AND YOU WON'T HAVE TO MANUFACTURE EXCUSES.



2820 Orchard Parkway, San Jose, CA 95134 *ASIC Technology & News: Focus Report, August, 1990.

© 1990 Valid Logic Systems, Inc.

Go ahead, explain it.

Tell them how small variations in component tolerances, process parameters and operating temperatures can cause an analog design to fail in manufacturing. Or worse yet, in the field. Even though it worked in the lab or in SPICE.

That's a problem Valid can help you avoid. As the leading supplier of analog EDA systems, we understand how downstream factors can sabotage your analog circuits.

That's why our Analog Workbench II provides the most complete selection of in-process analysis tools. So you can dramatically improve the quality, reliability and manufacturability of your analog ASICs or boards.

Choose from sophisticated tools like parametric, worst case and sensitivity analysis to identify critical design dependencies. Advanced statistical analysis to predict and optimize manufacturing yields. And Smoke Alarm™ stress analysis to ensure that com-

ponents stay within safe operating limits.

All analyses support DC as well as AC and transient measurements. And with Valid's unique Distributed Network Processing option, you can automatically partition compute-intensive runs across a network of workstations. Providing desktop performance of 100 MIPS or more, to give you more time to refine your design.

Analog Workbench II delivers all this capability in an integrated, easy-to-use environment that *ASIC Technology & News* calls "a designer's dream."* With system-level function blocks for top-down design. The world's largest analog component libraries. And tight integration with IC or PCB physical design tools.

It's all part of Valid's Process Integration Architecture, the industry's most practical and comprehensive approach to concurrent engineering.

For more information, call 1-800-48-VALID today. We'll take the excuses out of your next analog design.

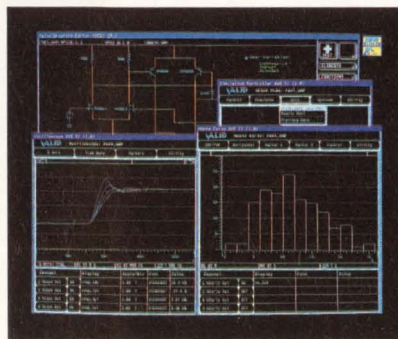

Valid's in-process analysis lets you catch downstream errors before they occur.

Surge Sentry®

Our best defensive line

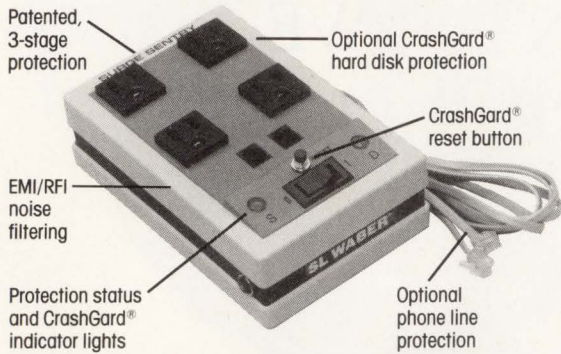

We have so much confidence in our top-of-the-line Surge Sentry® surge suppressors that we back them with a lifetime warranty and the SL Waber Power Protection Promise. We will repair/replace equipment damaged by a transient voltage surge while properly connected to any Surge Sentry®. The Surge Sentry® Series carries UL's best suppressed voltage rating of 330V and is CSA certified. And if you have a unique application, we can custom design to meet your exact specifications. Because if you use electricity, you need SL Waber.



WABER, INC.

A Subsidiary of SL Industries, Inc.
(800) 634-1485 • In NJ call (609) 866-8888

CIRCLE NO. 8

SUCCESSFUL SURFACE MOUNT POWER DEPENDS ON THERMAL CLAD®

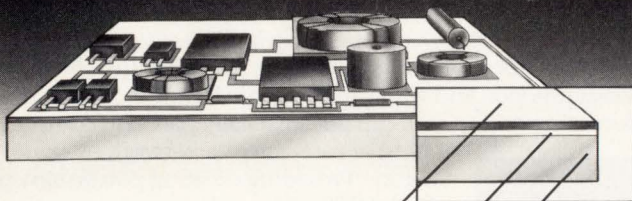

Etched Copper Circuit Layer Insulation Layer Metal Base Layer

HERE'S WHY:

- THERMAL CLAD is more thermally effective than FR4, PCB material. Devices will dissipate up to four times more power. (TR 1 °C/Watt)
- THERMAL CLAD metal base plate is tougher than ceramic. No breakage and larger panel sizes.
- THERMAL CLAD increases your design flexibility. Call Bergquist today with your custom application for THERMAL CLAD! Toll Free: 800-347-4572

BERGQUIST

5300 Edina Industrial Blvd., Minneapolis, MN 55435
Tel: (612) 835-2322 • Fax: (612) 835-4156

CIRCLE NO. 9

present- and the next-state inputs (Table 2). A Karnaugh map helps simplify the Boolean equation for M:

		G_2N G_1N			
		00	01	11	10
G_2P G_1P	00	0	1	3	2
	01	4	5	7	6
G_1P	11	12	13	15	14
	G_2P	8	9	11	10

which yields

$$M = \overline{G_2N} \cdot \overline{G_1N} + \overline{G_2N} \cdot \overline{G_2P} + \overline{G_1N} \cdot \overline{G_2P} \cdot G_1P.$$

The equations for G_2N , G_1N , Y, and M provide the information you will need to build a simple state machine that is better protected against illegal states and illegal transitions.

Techniques such as synchronizing the inputs, preventing illegal transactions, and providing for the safe transition to an idle state from illegal states can increase the reliability of state machines. The requirements for your particular state machine will determine the most appropriate method to resolve illegal states or transitions. Design techniques that build forgiveness into your circuits are only part of your design arsenal. The best way to avoid state-machine hang-ups is to prevent noise from reaching the system and ensure clean input signals.

EDN

Acknowledgment

The author would like to thank L Prater for his collaboration in the development of some of the concepts presented in this article.

Author's biography

Ricardo Rabinovich is a staff engineer with Librascope Corp (Glendale, CA). A graduate of an electronic-engineering program at Buenos Aires University, Ricardo is a computer design engineer. He has worked with 68020-based micro-computer designs and recently helped design an ASIC containing a VMEbus interface.



Article Interest Quotient (Circle One)
High 482 Medium 483 Low 484

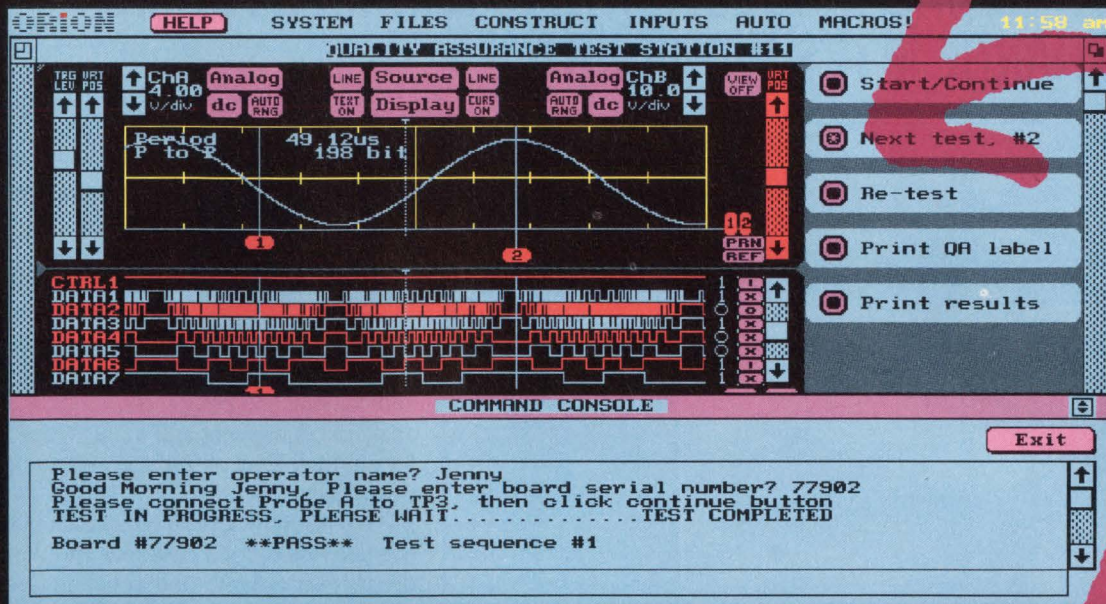

If you want to slash test set-up and debug time, click here.

OMNILAB™ INTEGRATES SIX INSTRUMENTS INTO A POWERFUL TEST PROGRAMMING ENVIRONMENT.

Develop complete functional test set-ups in 1/10th the time with OmniLab — the PC-based Programmable Test Station that integrates six test instruments into one fast and easy programming environment. Quickly develop automated test set-ups for pilot production runs or manufacturing tests.

OmniLab invokes the power of hundreds of



OmniLab's shown: self-contained portable with built-in 386SX computer and rack/stack model that connects to any IBM PC/AT, 386, or PS/2.

lines of test program code with a few mouse clicks. Interactive software eliminates the editing, compiling, linking and most debugging tasks. OmniMacros™ speed the entire process by recording test set-ups on-the-fly.

Save time troubleshooting hard-to-find faults, too. Mixed A/D Triggering™ and time correlated 100 MHz analog and digital displays easily capture elusive bugs and mixed mode problems that stump other instruments

What's more, OmniLab pleases both design and manufacturing managers. It's a snap to reconfigure. Designers can zip through their R&D test chores and manufacturing won't tie up expensive ATE equipment for prototype production runs.

Thanks to convenient pull-down menus and an intuitive graphical user interface, training is fast and easy.

If you're like most test engineers, up to 75% of your set-up time is spent developing programs. OmniLab cuts that job down to size.

FREE KIT—FREE VIDEO
Before you start another test set-up, call for your FREE Test Express Kit and video tutorial. See how easy it is to let OmniLab slash set-up and debug time.

Call: 800/729-7700

Or, fax your request to 415/327-9881

ORION
 INSTRUMENTS

Orion Instruments, Inc.
 180 Independence Drive
 Menlo Park, CA 94025
 415/327-8800

© 1990 ORION Instruments, Inc. OmniLab, OmniMacros, and Mixed A/D Triggering are trademarks of Orion Instruments, Inc.

"WE'VE HAD GREAT SUCCESS WITH CARROLL TOUCH. WHY CHANGE IF IT'S WORKING?"

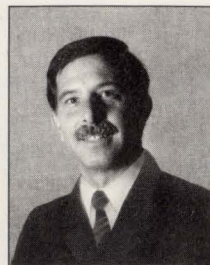
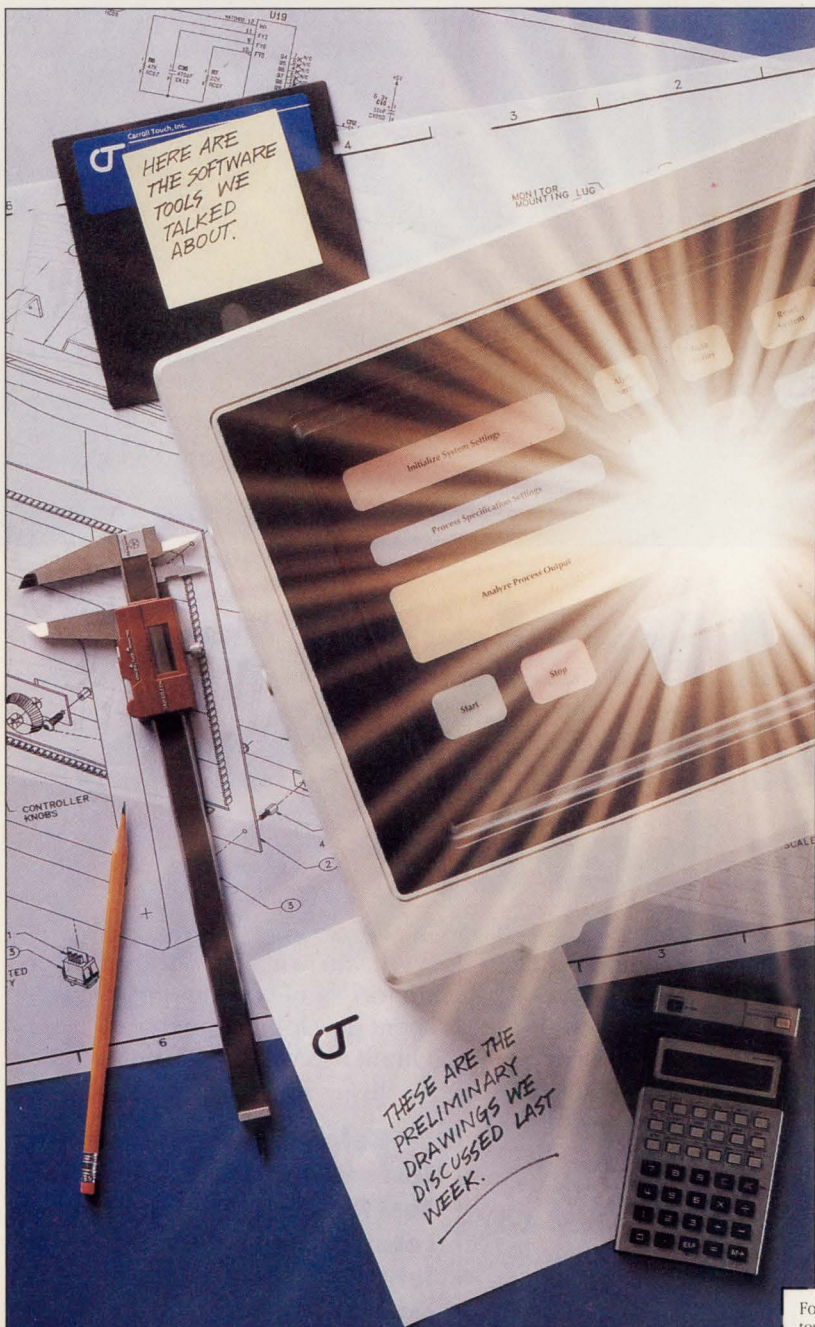

John Santacroce
*Mechanical Engineering
 & Project Manager*
 Hewlett-Packard Company

"As a diverse international corporation, Hewlett-Packard manufactures everything from computers, measurement and computation equipment, medical equipment, analytical equipment and more. We're known for our high level of test and measurement systems capabilities.

"We recently developed a touch-based automotive test system for a customer and there was no debate over using Carroll Touch in designing this. Our past experience with them has been very successful.

"From my point of view, Carroll Touch has provided good, reliable touch frame assemblies. They also bring a high level of engineering expertise to our team, especially in the materials selection area.

"Carroll Touch people really approach our projects as a team project."

"Working with Carroll Touch people is great because everybody is part of the team – which helps us create a very successful product. Their willingness to go that extra step makes our job much easier.

"In developing a recent functional spec for a touch frame, Carroll Touch engineers worked closely with us in making sure that the assemblies would survive electrostatic discharge.

"We held design reviews of the various approaches and all of our recommendations were considered very sincerely by Carroll Touch. Comments were intelligently relayed back to us and everything we asked for was delivered in the specified time."

For more information on how Carroll Touch can help you create success with your touch technology applications, call 512/244-3500, or simply mail your business card with this coupon to Carroll Touch, P.O. Box 1309, Round Rock, Texas 78680.

Name _____ Title _____

Company Name _____

Address _____

City _____ State _____ Zip _____

Carroll Touch
 The Next Level of Contact

Carroll Touch
 The Next Level of Contact
 EDN020491

© 1990 Carroll Touch

n,n,...nanoseconds

If your board tester takes too long to place an edge, you're going to pass a lot of marginal product.

And that means quality problems later on. Often with your customers.

Your engineers have pushed the latest technology. Every board is a significant investment. All devices meet spec. But timing faults keep slipping through.

Your ATE choice is critical. There's no room for error.

It's edge placement accuracy that's important here.

And at 2.5 ns the GR2750 series of Performance Test Systems lead their class.

If you're ready for a new way of thinking about 'true' high-performance testing, request your copy of "Perspectives On Digital Timing Accuracy."

Call 1-800-4-GENRAD in the U.S., or the GenRad office nearest you in Austria, Canada, England, France, Germany, Italy, Japan, Singapore, Switzerland.

 **GenRad**
A New Way of Thinking

Pretty & Simple

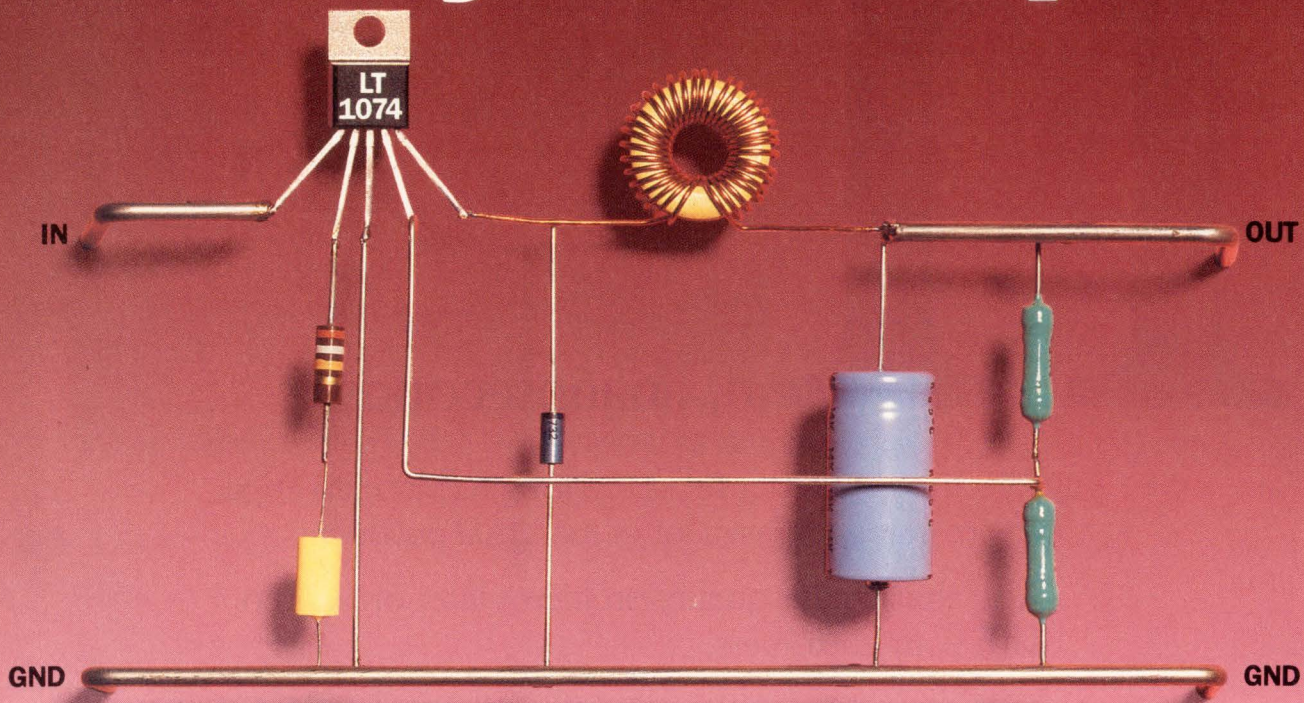

5A positive or negative stepdown or positive to negative voltage conversion.

Talk about easy. Linear's new LT1074 is a simple, elegant solution for your stepdown and inverting switching regulator applications. It's a 5 amp monolithic bipolar regulator with up to 200kHz switching frequency and internal adjustable current limiting. Power switch, oscillator and control circuitry and output monitor are also on the chip. It's a positive "buck" (stepdown) converter with several LTC innovations that also allow the device to be used as a positive to negative converter, a negative boost converter, and a flyback or forward converter.

As a stepdown converter, the LT1074 input voltage range is 8V to 60V. The switch out-

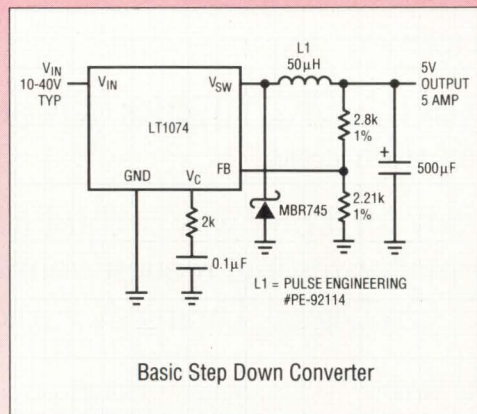

put can swing 40V below the ground, a feature that permits the regulator to perform positive to negative conversion with inputs down to 4.5V. It also allows the use of a tapped inductor for output currents up to 10A with no external switching transistor. A true analog multiplier in the feedback loop lets it respond quickly to input voltage fluctuations. The LT1074 is available in either a 5-lead TO-220 package or an 11-lead single-in-line package at \$5.25 and \$6.45, respectively, in 100-up quantities. For a data sheet and applications note contact: Linear Technology Corporation, 1630 McCarthy Blvd., Milpitas, CA 95035 or call 800-637-5545.



TOUGH PRODUCTS
FOR TOUGH APPLICATIONS.

DESIGN IDEAS

EDITED BY CHARLES H SMALL

Buffers stabilize oscillator

Maxwell Strange
Goddard Space Flight Center, Greenbelt, MD

Adding a CMOS buffer to a classic op-amp oscillator dramatically improves its performance, while preserving its low cost and low power consumption.

The overriding source of frequency drift in Fig 1a is the nonsymmetry and variability of the op amp's output-saturation voltages. These effects produce output-amplitude variations, which, when fed to the inputs via R_1 and R_2 , produce switching-threshold changes. Supply voltage, temperature, loading, and op-amp selection also affect these saturation voltages. You can clamp the op amp's output with reference diodes, but these diodes are expensive and power hungry.

The circuit of Fig 1b overcomes these problems and has other advantages as well. Gates A and B produce a rail-to-rail voltage swing to feed back to the circuit's input, eliminating the saturation-voltage drops of the op amp. If you select the proper op amp, only the circuit's passive components will affect its frequency stability. The circuit's output symmetry is near perfect

over a wide range of supply voltages. Further, the buffers' output transitions are much faster than the op amp's slew-rate-limited transitions, allowing you to use a micropower op amp.

The circuits' output frequency is

$$f_0 = \frac{\log e}{2 \log \left(1 - \frac{2R_1}{2R_1 + R_2} \right)} RC,$$

$$R_1 = \frac{R'_1 R'_2}{R'_1 + R'_2}$$

$$\text{if } R_2 = 3R_1, f_0 \approx \frac{0.979}{RC}$$

(EDN BBS DI #933)

EDN

To Vote For This Design, Circle No. 746

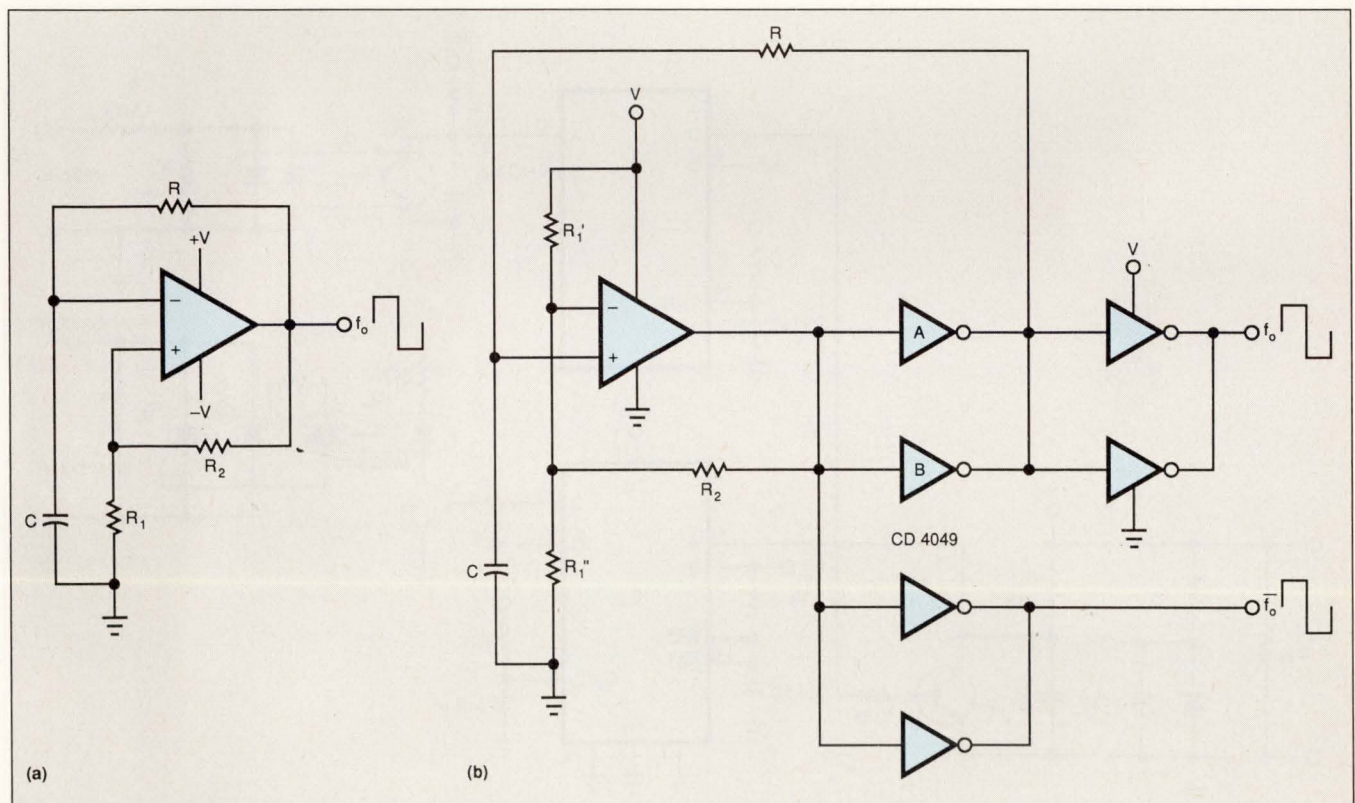

Fig 1—Adding CMOS buffers to a classic op-amp oscillator (a) improves the oscillator's performance without significant increases in power consumption or cost (b).

Current loop controls SCRs

Robert Diffenderfer
Gordos, Rogers, AR

The circuit in Fig 1 allows a 4- to 20-mA loop to control an isolated (4000V) SCR drive. The SCR drive can, in turn, control lighting intensity or motor speed. With a 4-mA control input, the SCRs will turn on at 90 and 270° with respect to the power input. By increasing the control input to 20 mA, the SCRs will turn on at 0 and 180°.

The current loop develops a control voltage across R_1 . D_1 and associated components clamp this voltage to 5V max to power 1-shots IC_{1a} and IC_{1b} .

Optoisolator Q_2 detects the zero crossings of the 120V ac input, providing a low-to-high transition that triggers 1-shot IC_{1b} . R_3 and R_4 affect the transition's timing. You can adjust these components to compensate for propagation delays. When triggered, 1-shot IC_{1B} produces a 0.1-msec pulse. The pulse turns on Q_1 , discharging capacitor C_2 .

When Q_1 turns off, C_2 begins charging. The voltage across R_1 and the value of R_2 set the rate at which C_2

charges. IC_{1a} will produce a 0.1-msec pulse when the voltage on C_2 reaches approximately 2.5V. This pulse turns on either SCR_1 or SCR_2 via optoisolator Q_3 . C_2 's charge time is

$$t = -R_{32} \times C_2 \times \ln \left\{ 1 - \left(\frac{V_C - V_1}{V_F} \right) \right\},$$

where

V_C = the input-logic threshold voltage (voltage across C_2),

V_F = the voltage across R_1 (a function of the input current), and

V_1 = the voltage to which C_2 was discharged ($\approx 0.3V$).

You may want to adjust the values of R_2 and C_2 to compensate for highly inductive loads.

(EDN BBS DI #935)

EDN

To Vote For This Design, Circle No. 747

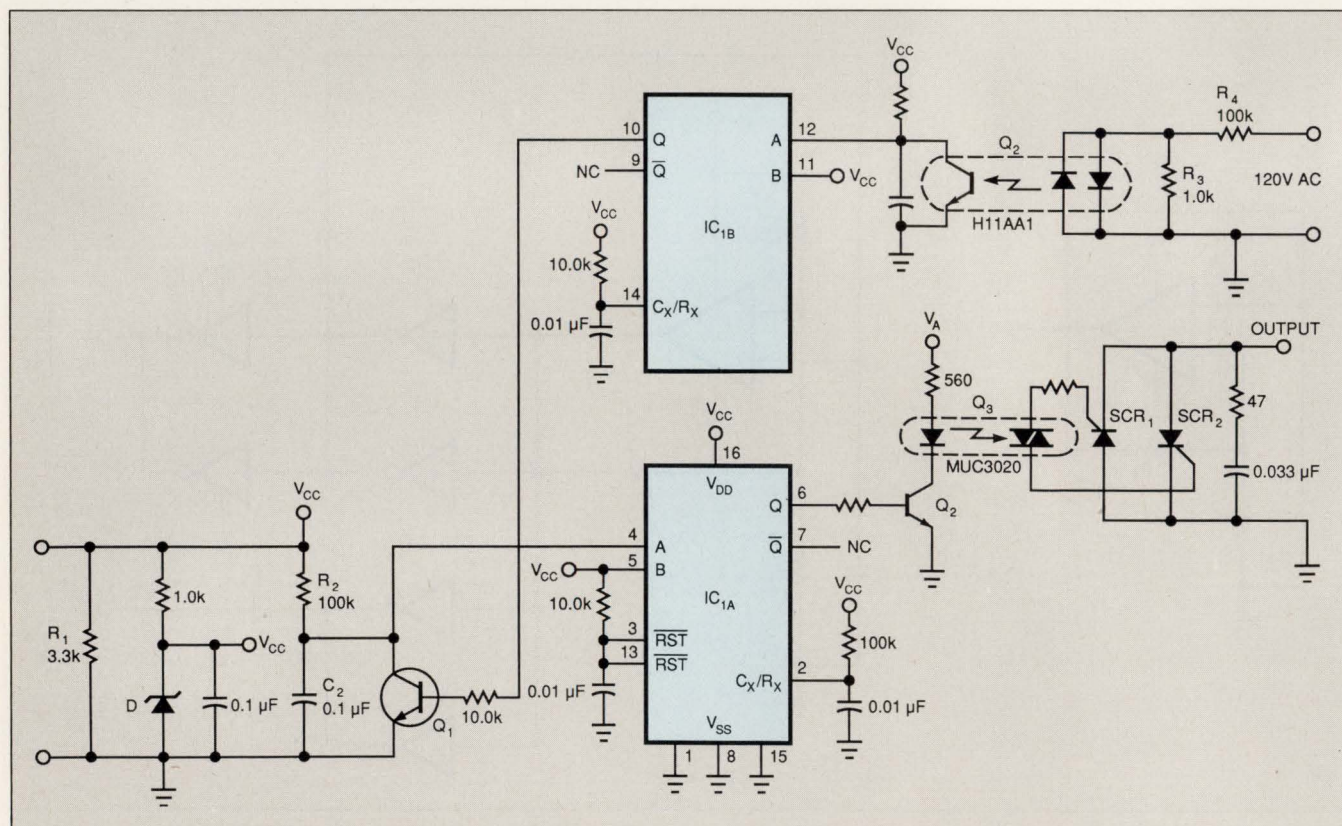
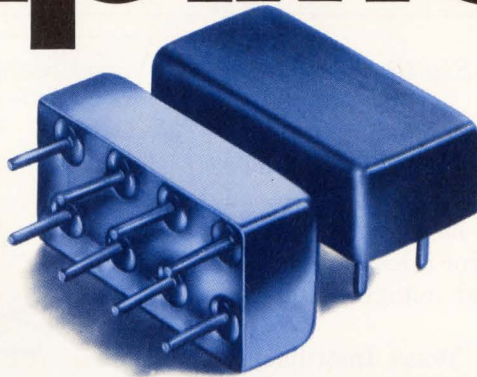

Fig 1—A couple of 1-shots and optoisolators let a 4- to 20-mA current loop control lighting intensity or motor speed.

rugged plug-in amplifiers



0.5 to 1000 MHz from \$13.95 (10 to 24 qty)

Tough enough to meet full MIL-specs, capable of operating over a wide -55° to $+100^{\circ}\text{C}$ temperature range, in a rugged package... that's Mini-Circuits' new MAN-amplifier series. The MAN-amplifier's tiny package (only 0.4 by 0.8 by 0.25 in.) requires about the same pc board area as a TO-8 and can take tougher punishment with leads that won't break off. Models are unconditionally stable and available covering frequency ranges 0.5 to 1000MHz, NF as low as 2.8dB, and power output as high as +15dBm. Prices start at only \$13.95, including screening, thermal shock -55°C to $+100^{\circ}\text{C}$, fine and gross leak, and burn-in for 96 hours at 100°C under normal operating voltage and current.

Internally the MAN amplifiers consist of two stages, including coupling capacitors. A designer's delight, with all components self-contained. Just connect to a dc supply voltage and you are ready to go.

The new MAN-amplifiers series...
another Mini-Circuits' price/performance breakthrough.

MODEL	FREQ. RANGE (MHz)	GAIN dB		MAX. OUT/PWR† dBm	NF dB (typ)	DC PWR 12V, mA	PRICE \$ ea. (10-24)
	f_L to f_U	min	flatness††				
MAN-1	0.5-500	28	1.0	8	4.5	60	13.95
MAN-2	0.5-1000	19	1.5	7	6.0	85	15.95
MAN-1LN	0.5-500	28	1.0	8	2.8	60	15.95
◇MAN-1HLN	10-500	10	0.8	15	3.7	70	15.95
*MAN-1AD	5.500	16	0.5	6	7.2	85	24.95

††Midband $10f_L$ to $f_{U/2}$, $\pm 0.5\text{dB}$ †IdB Gain Compression ◇Case Height 0.3 in.
Max input power (no damage) +15dBm; VSWR in/out 1.8:1 max.

*Active Directivity (difference between reverse and forward gain) 30 dB typ.

finding new ways ...
setting higher standards

Mini-Circuits

A Division of Scientific Components Corporation
P.O. Box 350166, Brooklyn, New York 11235-0003 (718) 934-4500
Fax (718) 332-4661 Domestic and International Telexes: 6852844 or 620156

Regulator measures battery voltage

Mark Freeman
Stratos Product Development, Seattle, WA

If your low-power μP system is battery powered, the μP can use a precision regulator to monitor its own battery voltage. The circuit in Fig 1 uses no precision passive components and requires no trimming. Error is less than $\pm 3\%$, and linearity error is less than $\pm 1\%$. You must write a short control and voltage-calculation routine for your μP .

The heart of the circuit is a Texas Instruments TL431 precision shunt regulator functioning as both a voltage reference ($V_{\text{REF}} = 2.5\text{V}$) and as an integrator/amplifier.

In operation, the μP first sets an output buffer high for a programmed interval. Then the μP sets the buffer low and waits for a trigger signal back from the monitor circuit. The ratio of the two time intervals yields the supply voltage.

While the output buffer is high, effectively connecting R_1 to the positive rail, capacitor C_1 discharges at the rate of $(V_{\text{CC}} - V_{\text{REF}})/(R_1 C_1)$. When the μP 's output buffer goes low, connecting R_1 to ground, C_1 begins charging at the rate $(V_{\text{REF}})/(R_1 C_1)$. When C_1 's voltage reaches the turn-off voltage of Q_1 , Q_1 turns off, developing the TRIGGER signal for the μP .

The μP fixes the discharge time τ_{DIS} . V_{CC} determines the charge time, τ_{CHG} . Battery voltage is

$$V_{\text{CC}} = V_{\text{REF}}[(\tau_{\text{CHG}} / \tau_{\text{DIS}}) + 1].$$

The components in Fig 1 yield a 16.7-msec τ_{DIS} , which will integrate out 60-Hz interference. V_{CC} may vary between 3.5 and 6.0V.

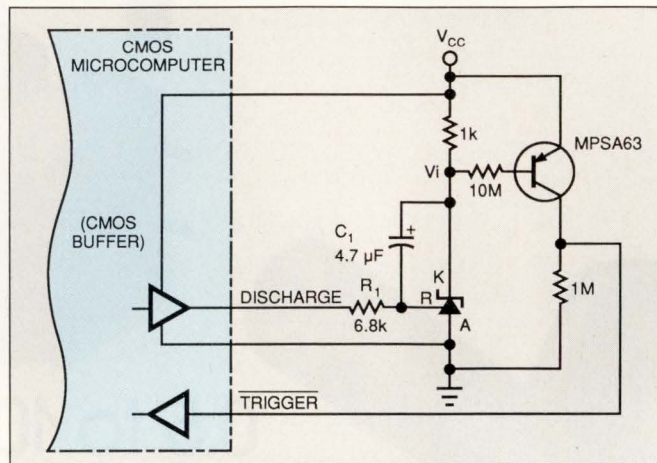

Fig 1—A precision shunt regulator, functioning as both a voltage reference (V_{REF}) and as an integrator/amplifier, measures its own supply voltage via voltage-dependent charge/discharge time intervals.

Component values are not critical, and your μP 's clock need not be accurate, as long as it does not drift during a conversion cycle. Choose C_1 such that at the highest value of V_{CC} , C_1 's voltage never goes lower than V_{REF} , because at that point the regulator will quit operating. Use a low-leakage, solid-tantalum capacitor for C_1 .

If you want to measure some voltage other than the supply voltage, you can use an external CMOS switch or buffer to handle the switching chores. The only restriction is that the voltage to be measured must be greater than V_{REF} . (EDN BBS DI #932) **EDN**

To Vote For This Design, Circle No. 748

Programmable source operates precisely

Jim Williams
Linear Technology Co, Milpitas, CA

Precise, voltage-programmable, ground-referenced current sources are usually complex and require trimming. Fig 1's simple configuration produces output current in strict accordance to the sign and magnitude of

the control voltage, V_{IN} . The circuit's dynamic response is well controlled, and the circuit requires no trimming; the circuit's accuracy and stability depend almost entirely upon resistor R.

IC_1 , biased by V_{IN} , drives current through R (in this case, 10Ω and the load). Instrumentation amplifier, IC_2 , operating at a gain of 100, senses the voltage across

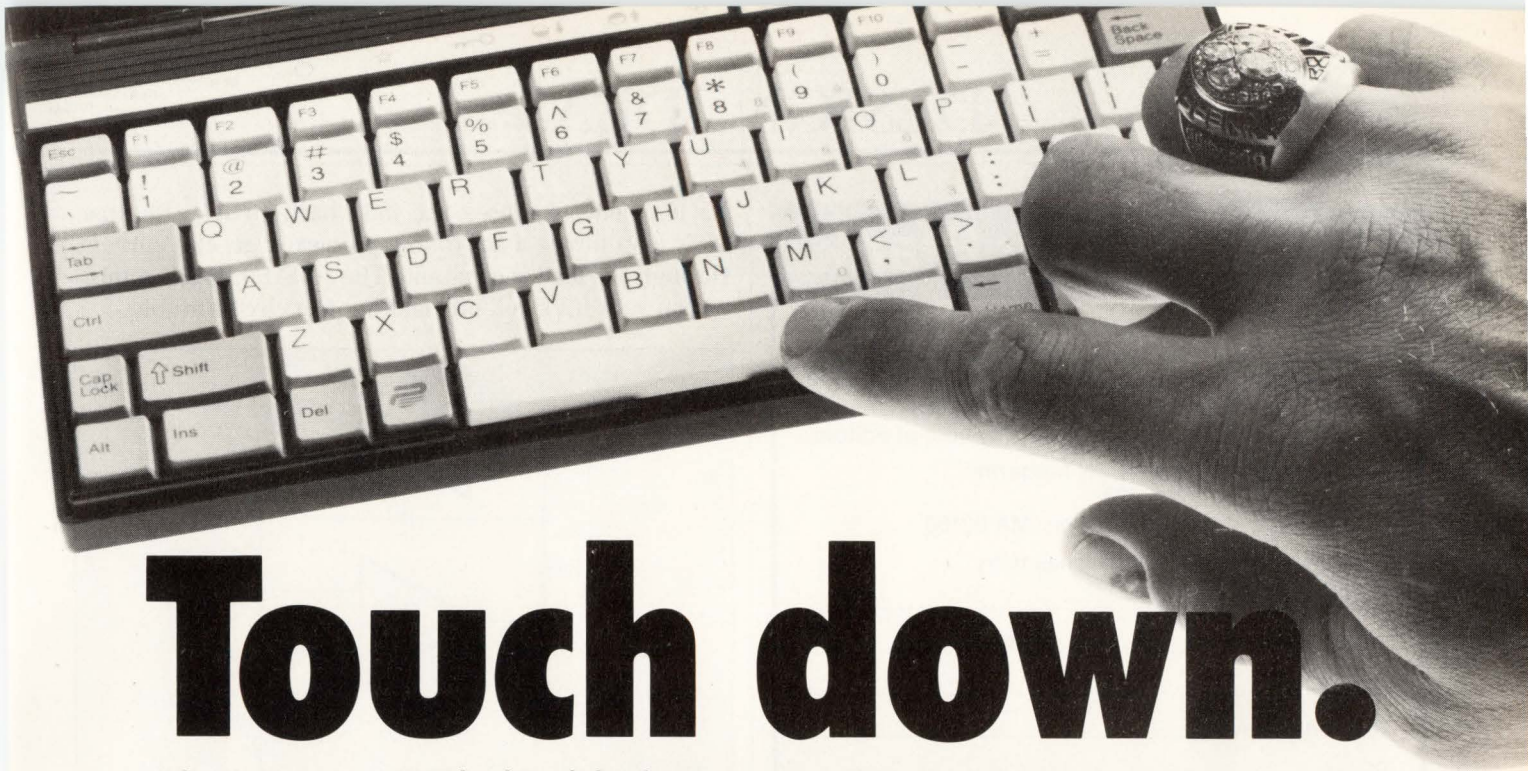

Touch down.

When it comes to custom keyboards for the next generation of desktop, laptop, and notebook PCs, nobody outscores Fujitsu for quality, durability, and touch.

Today, the name of the game is ultra-small, ultra-light laptop and notebook PCs. To score big points with today's PC buyers, you've got to be small, lightweight, agile in the corners, and have the right touch.

Which may be why Fujitsu leads the league in providing both standard and custom keyboards for a long list of major OEMs.

Take the snap.

When it comes to tight spots, look to our new FKB7800 and FKB8800 series of keyboards. Each provides the comfortably crisp feel of an ergonomically optimal 3.8mm stroke depth and 20g snap pressure in a smaller, lighter, lower-height package. With the same quality and reliability as our full-sized keyboards.

Or call your own plays.

You can also rely on Fujitsu's expertise to help you design custom keyboard solutions. We'll work with you every step of the way to determine the best combination of keyboard layout, size, height, color, enclosure, and interface for your system.

We hit the extra points.

Of course, what makes our new keyboards the best choice is what has made our FKB4800 and FKB4700 keyboards the 101 standard—our attention to the extra details. Like our superior tactile feedback and reliability

Get in touch with us.

To win today's PC game, you've got to field a strong product. With Fujitsu keyboards on your team, you'll have the advantage in touch, height, weight, and reliability.

To receive our winning stats, call 1-800-556-1234 and ask for ext. 238. In California, call 1-800-441-2345 and ask for ext. 238.

Product Selection Guide			
Series	Stroke	Tactile	Height (C-Row Center)
FKB7800	3.8mm	55gr	14.48mm
FKB8800	3.8mm	55gr	14.48mm
FKB4700	3.8mm	55gr	22.0mm*
FKB4800	3.8mm	55gr	22.0mm*

*without enclosure



Every step of the way.SM

Fujitsu Component of America, Inc.
3545 North First Street • San Jose, CA 95134-1804.

Photo courtesy of Poqet Computer and Matt Millen, San Francisco 49er

Every step of the way is a service mark of Fujitsu Microelectronics, Inc.

© 1990 Fujitsu Component of America, Inc.

DESIGN IDEAS

Design Entry Blank

\$100 Cash Award for all entries selected by editors. An additional **\$100 Cash Award** for the winning design of each issue, determined by vote of readers. Additional **\$1500 Cash Award** for annual Grand Prize Design, selected among biweekly winners by vote of editors.

To: Design Ideas Editor, EDN Magazine
Cahners Publishing Co
275 Washington St., Newton, MA 02158

I hereby submit my Design Ideas entry.

Name _____

Title _____ Phone _____

Company _____

Division (if any) _____

Street _____

City _____ State _____

Country _____ Zip _____

Design Title _____

Home Address _____

Social Security Number _____
(Must accompany all Design Ideas submitted by US authors)

Entry blank must accompany all entries. Design entered must be submitted exclusively to EDN, must not be patented, and must have no patent pending. Design must be original with author(s), must not have been previously published (limited-distribution house organs excepted), and must have been constructed and tested. Please submit software listings and all other computer-readable documentation on a 5¼-in. IBM PC disk.

Exclusive publishing rights remain with Cahners Publishing Co unless entry is returned to author or editor gives written permission for publication elsewhere.

In submitting my entry, I agree to abide by the rules of the Design Ideas Program.

Signed _____

Date _____

ISSUE WINNER

The winning Design Idea for the November 8, 1990 issue is entitled "Buffer increases precision," submitted by Barry L Siegel of Elantec Inc (Milpitas, CA).

Your vote determines this issue's winner. All designs published win \$100 cash. All issue winners receive an additional \$100 and become eligible for the annual \$1500 Grand Prize. **Vote now**, by circling the appropriate number on the reader inquiry card.

R. IC₂'s output closes the loop back to IC₁. Because IC₁'s loop forces a fixed voltage across R, the current through the load is constant. The 10-kΩ/0.05 μF combination sets IC₁'s roll-off, making the circuit stable.

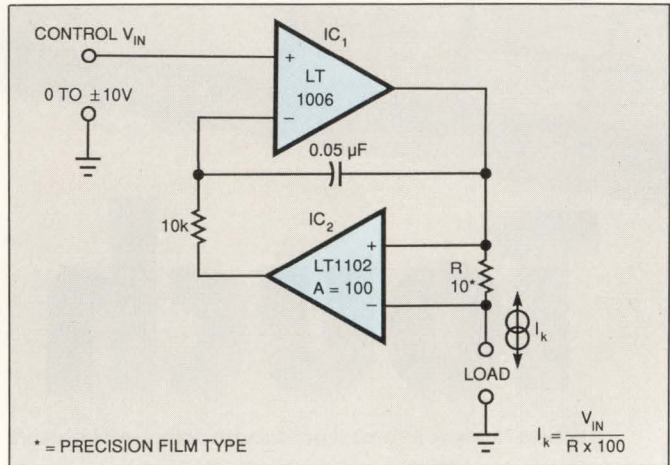

Fig 1—This programmable current source's dynamic response is well controlled, and the circuit requires no trimming.

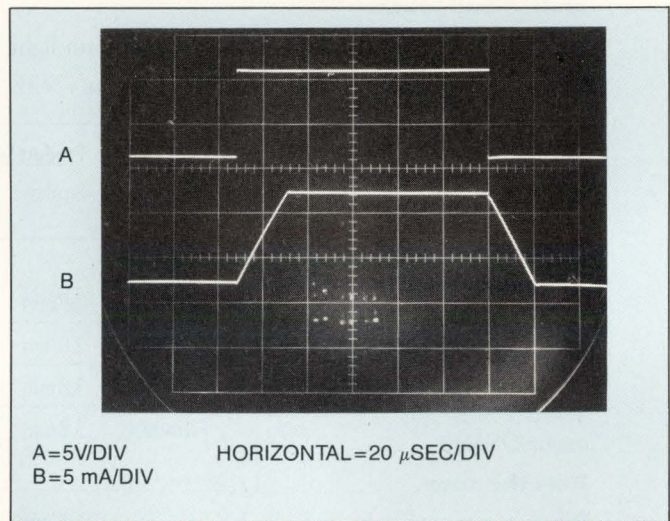

Fig 2—For a full-scale input step, Fig 1's response is clean with no slew residue or aberrations. Trace A is the voltage-control input, and Trace B shows the output current.

Assuming an errorless component for R, IC₂'s 0.05% gain specification and its 5-ppm/°C temperature coefficient dominate the circuit's initial error. High-grade film or wirewound resistors will not degrade this level of performance.

Fig 2 shows the circuit's dynamic response for a full-scale input step. Trace A is the voltage-control input, and Trace B is the output current. Response is clean, with no slew residue or aberrations.
(EDN BBS /DI_SIG #931)

EDN

To Vote For This Design, Circle No. 749

30 MS/s DSO PLUS A TEST BENCH OF FUNCTIONS TIED UP IN ONE PORTABLE PACKAGE.

Leader's new battery-powered DSO/DMM weighs only 2.6 lbs., yet performs the functions of four different pieces of test equipment. Two functions the Model 300 offers are those of a DSO and DMM, with simultaneous display of each—including channels 1 and 2 peak-to-peak voltage and frequency. Two additional functions are an 8-bit logic analyzer, which lets you compare 8 signals at once, and a data logger for recording long-term phenomena.

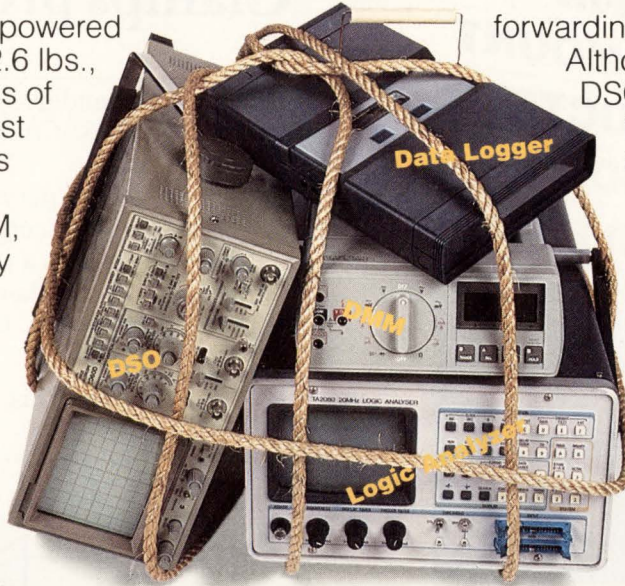

forwarding it to a lab for analysis. Although our new portable DSO is compact, it's also feature-packed. Included are: HF rejection, add and subtract, and full auto setup for vertical sensitivity, sweep speed, vertical position, and trigger level. For documentation purposes the 300 can interface with an optional dedicated printer (Leader Model 710). A supertwist LCD display (a full 2 1/2" x 4 1/2") provides high contrast and

The 300 has a remarkable sampling rate of 30 MS/s, giving you the ability to observe 10-MHz signals. A powerful 1.8k word/channel memory provides a detailed view of rapidly occurring events.



A 20-waveform capacity is standard, but an optional IC card lets you store an incredible 80 waveforms. The IC card is especially handy for saving information and

a large viewing angle.

You'll find that the 300 makes the perfect traveling companion, letting you travel light without leaving a single vital function back in the shop. For our full-line catalog, in NY call 516 231-6900. Or call toll free: 1 800 645-5104.

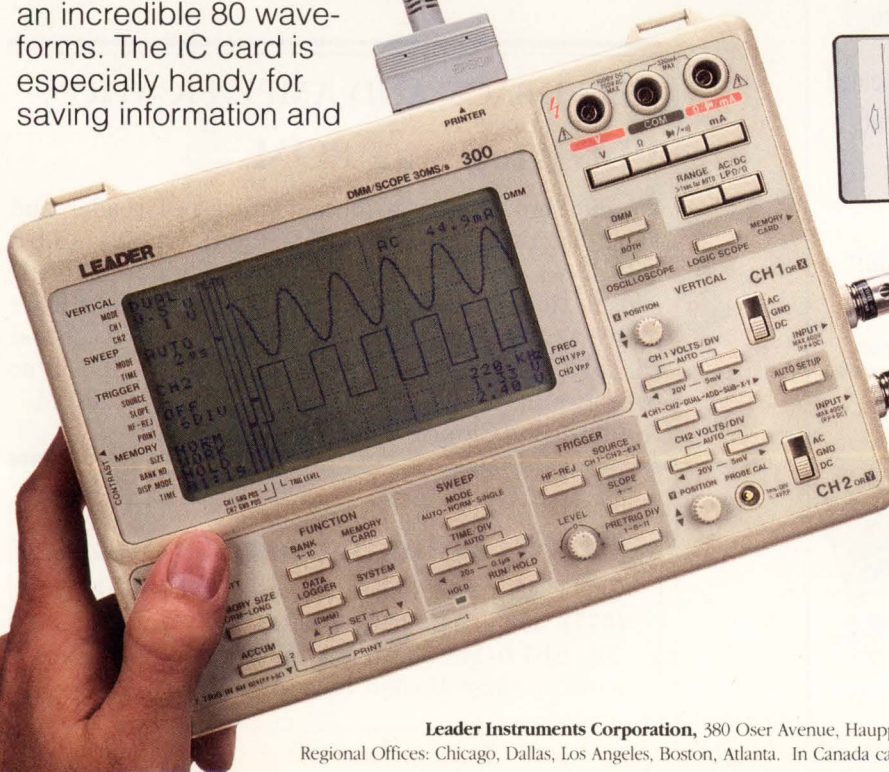
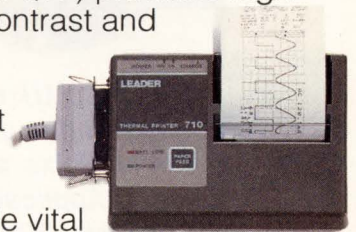

1 800 645-5104

LEADER
FOR PROFESSIONALS WHO KNOW THE DIFFERENCE

Leader Instruments Corporation, 380 Oser Avenue, Hauppauge, New York 11788
Regional Offices: Chicago, Dallas, Los Angeles, Boston, Atlanta. In Canada call Omnitronix Ltd., 416 828-6221.

PICO POWER INDUCTORS

PLUG-IN
SURFACE MOUNT
AXIAL INDUCTORS
TOROIDAL
INSULATED LEADS

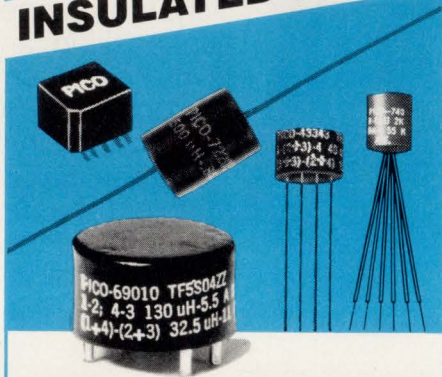

PICO's Ultra-Miniature Power Inductors are ideal for Noise, Spike and Power Filtering Applications in Power Supplies, DC-DC Converters and Switching Regulators.

- QPL standards available MIL-T-27/356
- Temperature range -55°C to $+130^{\circ}\text{C}$
- All units are magnetically shielded
- All units meet the requirements of MIL-T-27 (TF5S04ZZ)
- Minimum possible size
- Split windings
- Inductance values to 20mH with DC currents to 23 amps

PICO manufactures complete lines of Transformers, Inductors, DC-DC Converters and AC-DC Power Supplies

Delivery—
stock to
one week

SEE EEM,
THOMAS REGISTER
OR SEND DIRECT FOR
FREE PICO CATALOG

PICO
Electronics, Inc.
453 N. MacQuesten Pkwy. Mt. Vernon, N.Y. 10552

Call Toll Free **800-431-1064**
IN NEW YORK CALL **914-699-5514**

DESIGN IDEAS

Clamps provide self-test

Maxim Jay Skender
Microrobotics, St Charles, IL

You can get double duty from your clamping diodes if you tie them to the output of a D/A converter (or an op amp configured as a converter). In this fashion (Fig 1), you can use the clamping diodes as a controllable input during self-tests. (EDN BBS DI #934) **EDN**

To Vote For This Design, Circle No. 750

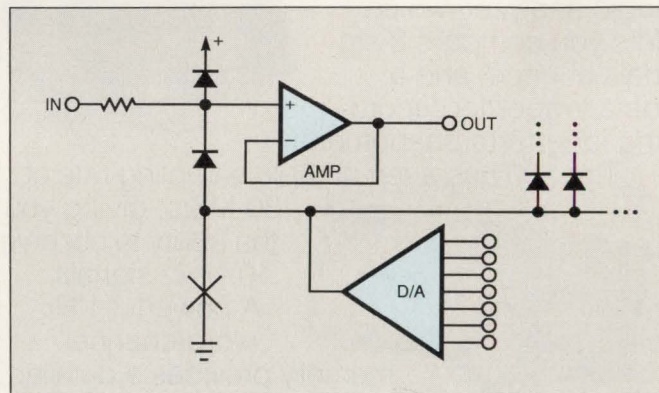

Fig 1—Clamping diodes become controllable inputs during self-test if you connect them to a D/A converter instead of either the supply rail or ground.

FEEDBACK AND AMPLIFICATION

PLD is really a PROM

We did some checking for an interested reader and found out that a part an author (and company) called a PLD was really a PROM. The Design Idea "PLD adds flexibility to motor controller" on pg 177 of EDN's March 1, 1990 (DI #808) issue contains a part labeled PLE5P8. This part number is an obsolete Monolithic Memories Inc designation for a simple 32×8 -bit PROM.

Anne Watson Swager and Charles H Small
Design Ideas Editors

EDN

EDN's bulletin board is on line

Call EDN's free bulletin board service (BBS) at (617) 558-4241 (1200/2400,8,N,1) and select /DI_SIG to get additional information or to comment on these Design Ideas.

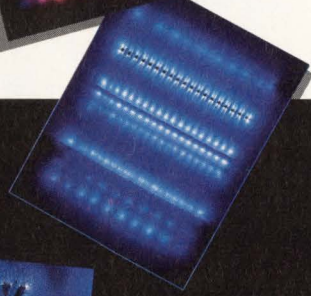

United States Europe Japan Korea Singapore

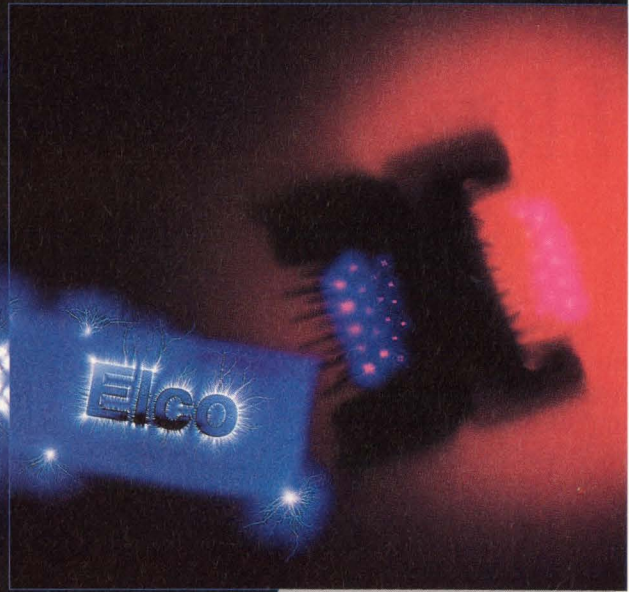

***GREATER
WORLD CLASS
POWER FROM
OUR NEW
GLOBAL
CONNECTIONS***

The recent alliance of Elco and AVX with Kyocera forms a solid business relationship that gives us even stronger connections to today's exciting world of technology.

These connections strengthen our own high quality standards and link us to new sources of innovation throughout the world.

Together we combine our talents, energies, and experience to provide you with an ever-expanding line of advanced connector products of unsurpassed value. These new connections also contribute to a fresh spirit of efficient service and delivery and

assure you of timely response to your ever-evolving needs.

From a new source of energy emerges a powerful new Elco.



World Class Connections

Copyright 1990, Elco Corporation. All rights reserved.

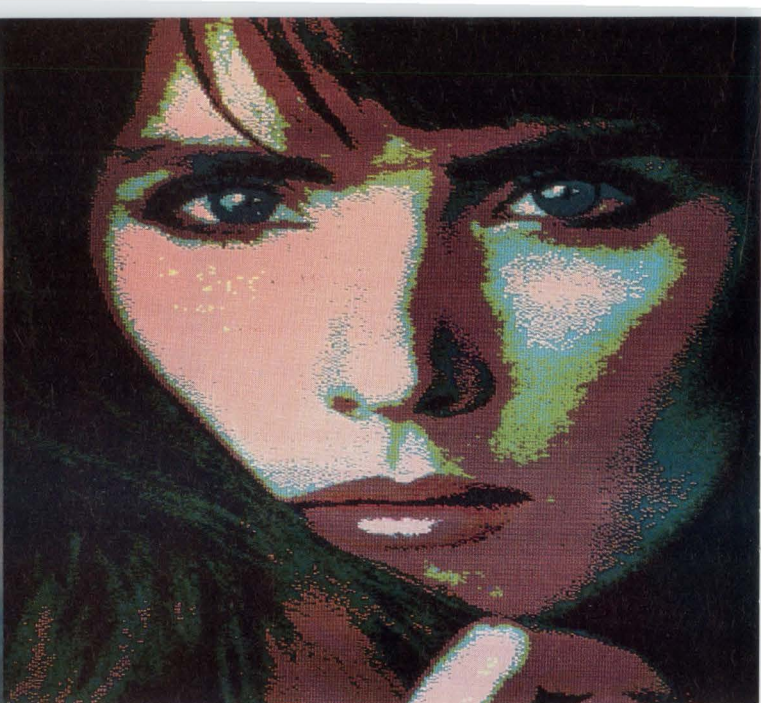

Picture your flat panel display using Cirrus Logic controller chips. They actually add colors to your display capabilities for more realistic shading.

The same panel looks flat without our enhanced VGA capabilities. And it will lose face faster without our optimized power management system.

How To Avoid Losing Face On Your Color LCD Display.

Face it. The first thing everybody notices about your newest laptop is the display quality. Is it bright? Are the images clear and well modeled? Are the colors vivid?

With Cirrus Logic LCD VGA controllers, your answer is yes. Which is why we're the leading supplier of display controller chips in the laptop and notebook market.

For life-like 3-dimensional imaging, Cirrus Logic color LCD controllers offer technology leadership for your color products. With direct support for the latest active-matrix color LCD panels. Our controller chips do more than support your panel's color capabilities — they enhance it with full VGA color support and a fuller color palette. To give you color so good it competes with CRT quality.

Our monochrome solutions give you displays that *PC Magazine* called "the stars of our VGA color-mapping tests"* with up to 64 shades of gray. And with a lower dot clock rate, your power consumption

is lower than other solutions for longer battery operation.

Cirrus Logic LCD controllers are fully compatible with the popular PC video standards and will work with LCD, plasma, or electroluminescent displays.

Simplify your design job. A higher level of integration gives you all this in the smallest form factor available. We also supply software and hardware design notes and full design support. You get the results you want quickly and easily.

Design a more competitive product. One that looks better — and makes you look better. That lasts longer on a battery. Use the display solutions from a proven technology leader in laptop and motherboard VGA: LCD controller chips from Cirrus Logic.

Get the picture. Get more information on LCD controllers.

Call 1-800-952-6300, ask for dept. LL24

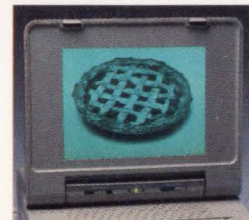
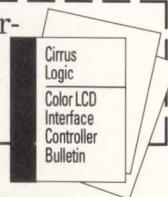

Cirrus Logic monochrome LCD controllers will also make everything from realistic scanned images to business charts look tastier.

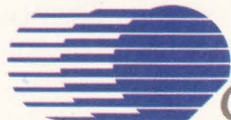

CIRRUS LOGIC

C L O S I N G T H E G A P

©1991 Cirrus Logic, Inc., 3100 West Warren Avenue, Fremont, CA 94538 (415) 623-8300; Japan: 462-76-0601; Singapore: 65-3532122; Taiwan: 2-718-4533; West Germany: 81-52-2030/6203
Cirrus Logic and the Cirrus Logic logo are trademarks of Cirrus Logic, Inc. All other trademarks are registered to their respective companies. * PC Magazine, March 13, 1990, p. 204.

NEW PRODUCTS

INTEGRATED CIRCUITS

2.5-GHz-Bandwidth, Variable-Gain Amplifier

- Provides 20-dB gain control
- Comes in surface-mount SO-8 package

The HPVA-0810 is a monolithic variable-gain amplifier that features 20 dB of gain and gain control over its entire dc-to-2.5-GHz bandwidth. Operating from a single 6V supply, the amplifier dissipates only 250 mW. Designed for use in VHF/UHF receivers, RF data links and broadband local-area networks, the amplifier can replace more expensive hybrid devices, which typically have narrower bandwidths. The device is available in a surface-mount SO-8 package. HPVA-0810, \$13.25 (100).

Hewlett-Packard Co, 19310 Pruneridge Ave, Cupertino, CA 95014. Phone (800) 752-0900.

Circle No. 351

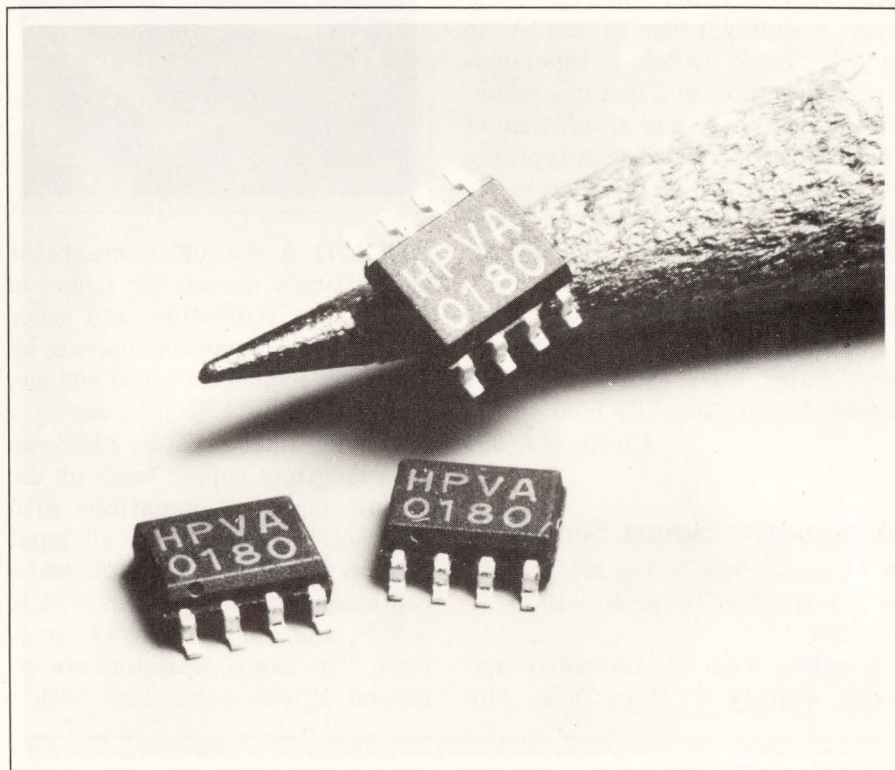

1M-Bit CMOS DRAMs

- Feature 60-nsec speed
- Support μ Ps with speeds to 16 MHz

With Read/Write cycle times as low as 110 nsec, the AAA1M300 series of CMOS DRAMs (dynamic RAMs) allows designers to implement zero-wait systems utilizing 16-MHz μ Ps. Complex interleaving or caching schemes are not necessary. The high-speed DRAM is also available in enhanced-page-mode versions with Read/Write cycle times of 25 nsec. The devices work over a supply range of 4.5 to 5.5V and a temperature range of 0 to 70°C. The DRAMs are available in DIPs, ZIPs, and SOJ packages with industry-standard interfaces and pinouts. \$5 (10,000).

NMB Technologies, 9730 Independence Ave, Chatsworth, CA 91311. Phone (818) 341-3355. FAX (818) 341-8207. TLX 651340.

Circle No. 352

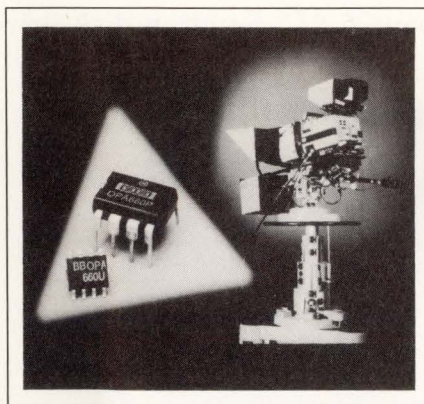

Transconductance Op Amp

- Has 700-MHz bandwidth
- Slew rate is 3000V/ μ sec

Called an operational transconductance amplifier (OTA), the OPA660 combines a voltage-controlled current source with a separate buffer amplifier. By programming the quiescent current using a single external resistor, users can optimize gain- and bandwidth-tradeoffs. The complementary emitter-follower buffer section provides a 700-MHz

bandwidth, a 3000V/ μ sec slew rate, 0.06% differential gain error, and 0.02% differential phase error. Transconductance for the OTA section is 125 mA/V. You can connect the OTA and buffer sections to create a current-feedback amplifier. The OPA660 comes in 16-pin DIPs and SO packages, \$4.35 (100).

Burr-Brown Corp, Box 11400, Tucson, AZ 85734. Phone (602) 746-1111. FAX (602) 889-1510. TWX 910-952-1111.

Circle No. 353

Quad SPST Analog Switch

- Operates from a 5 to 30V supply
- Needs no V_{REF} supply

The HI-201 monolithic quad spst analog switch operates from a single 5V to 30V supply. The IC eliminates the need for a V_{REF} supply, which is normally required for operation with power supplies other than $\pm 15V$ to maintain TTL compatibility without pull-up resistors.

A plug-in upgrade for the Harris HI-201, the IC typically consumes only 4 mW of power while operating over a supply range of $\pm 4.5V$ to $\pm 18V$. Each switch is independently selectable and features an on-time of 260 nsec and an off-time of 100 nsec. On-resistance is typically 45Ω . The device is available in 16-pin DIPs, ceramic DIPs, SO, and 20-pin LCC packages in commercial, industrial and military temperature ranges. From \$2.06 (1000).

Maxim Integrated Products, 120 San Gabriel Dr, Sunnyvale, CA 94086. Phone (408) 737-7600.

Circle No. 354

Automotive Smart Sensor

- Operates from a 9 to 30V supply
- Temperature range is -40 to $125^{\circ}C$

Operating from an automotive battery supply of 9 to 30V, the

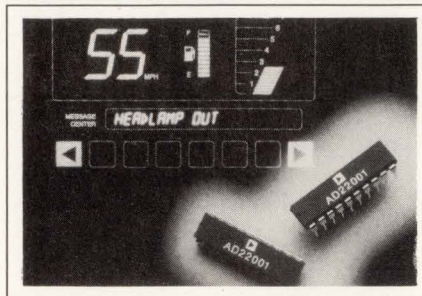

AD22001 5-channel comparator automatically detects the failure of headlamps, indicators, and other lights. The comparators operate by detecting a small threshold voltage, nominally only 1.75 mV, across a low-value shunt resistor, which can be a length of copper track on the circuit board. Compatible with automotive applications, all input pins on the sensor will withstand a continuous dc voltage from -34 to $+36V$, and a 60V transient for 40 msec. The five comparators are arranged as two pairs, each with a

common output, and one comparator with a dedicated output. The comparator pairs test any two related lights in either the on or off condition, indicating a failure of one or both. The single comparator is intended for brake-light testing. The AD22001, which comes in a 20-pin plastic DIP, is specified for operation of a -40 to $125^{\circ}C$ temperature range. \$2 (OEM qty).

Analog Devices Inc, 804 Woburn St, Wilmington, MA 01887. Phone (617) 937-2381. Circle No. 355

Motor Controller

- Needs no Hall sensor
- Compatible with Delta/Y/Star motors

The first of the company's Hall-sensorless ICs, the SSI-32M595 provides motor speed control for both 5V and 12V Delta/Y/Star motors. The μP 's starting the motor

All you need to know about 5.25" Semicon disk drives, inside

120MB Full-height 5.25"

SCSI Interface

< .35ms Access time

40MB Half-height 5.25"

4.0MB/Second sustained transfer rate

Up to 220,000 hours MTBF

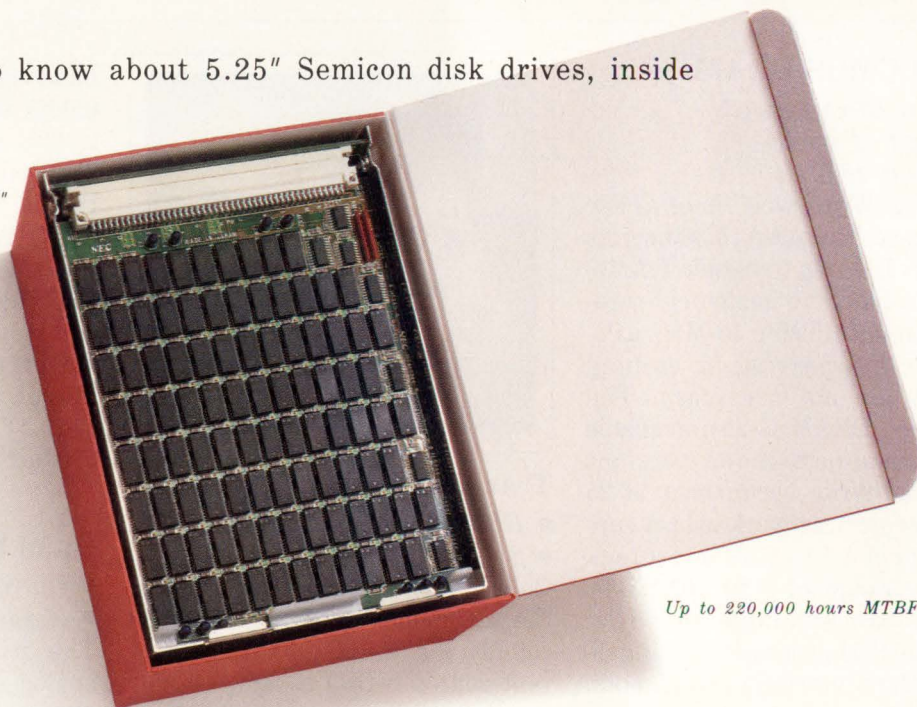

Computers and Communications

It's nice to know that NEC disk drives have the most advanced technical features. And it's reassuring that they're consistently available, and with a DOA rate of less than 1%, and up to 220,000 hours MTBF rate that they're reliable.

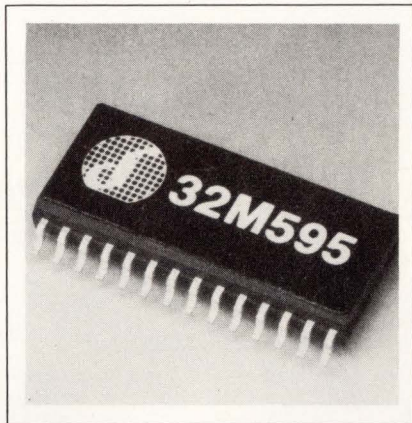

in a variety of packages, including a 28-pin SO package. \$5 (1000).

Silicon Systems, 14351 Myford Rd, Tustin, CA 92680. Phone (714) 731-7110. FAX (714) 669-8814.

Circle No. 356

High-Speed, 6-Bit Flash A/D Converter

- Conversion speed of 75 MHz
- 140-MHz full-power bandwidth

A pin-compatible upgrade to the AD9000, the MN5903 offers improved S/N ratios and a wider bandwidth. At 540 kHz, the S/N ratio is 38 dB; at 35 MHz, it remains high, at 36 dB. Full-power bandwidth is 140 MHz. The converter is available in two logic configurations. You can also use the MN5903A as a stand-alone 6-bit ADC or as a terminating device for 7- or 8-bit applications. The MN5903 is for use as a cascading device with the MN5903A for

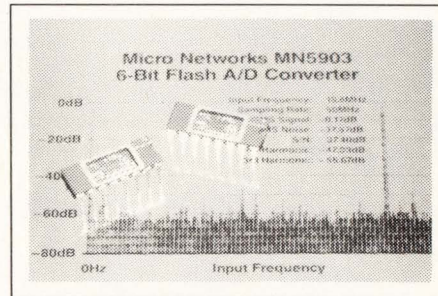

initiates the drive control, which activates EMF-induced self-commutation in the SSI-32M595. The controller's EMF circuitry typically detects motion within the first revolution of the motor. Speed control, which is implemented through a control loop, is maintainable over a range of speeds to an accuracy of $\pm 0.017\%$. The controller operates from a single 5V supply and comes

7- or 8-bit applications. The parts differ only in their output coding for signals greater than V_{REF} . In the overrange, the MN5903's outputs are set to a logic "0;" the MN5903A's outputs are set to a logic "1." The converters come in a 16-pin, hermetically sealed DIP. Commercial devices, from \$39; extended-temperature-range devices, from \$85 (100).

Micro Networks, 324 Clark St, Worcester, MA 01606. Phone (508) 852-5400. FAX (508) 853-8296.

Circle No. 357

and out.

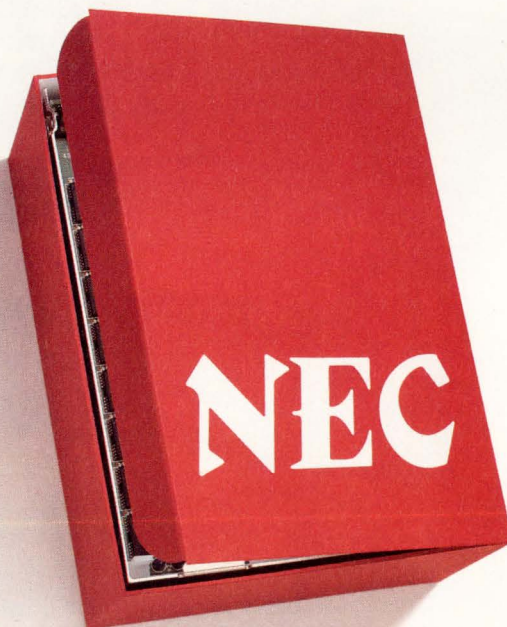

© 1990 NEC Technologies, Inc.

But all you really need to know is that they're made by NEC, a 24-billion-dollar company, and the fourth largest manufacturer of disk drives in the world. For more information, call 1-800-NEC-INFO.



CUSTOMIZING YOUR WAVEFORM ANALYSIS DOESN'T TAKE A PC.

IT JUST TAKES A LITTLE TACT.™

The company that gave you the first digital oscilloscope, the longest memory, best resolution and greatest storage capacity has gone a giant step further toward the perfect scope. All you need is a Nicolet 400 Series DSO - and TACT.™

TACT software elevates Nicolet's 400 Series DSO into the first application-specific oscilloscope. It gives you the power to say and do the right thing at the right time - to enhance the productivity of your test capabilities.

No computer needed.

Other scopes give you waveforms. Nicolet gives you answers. Forget the PC. You don't need one. Program directly on the scope using a built-in, full-screen editor and 101-key PC-type keyboard. Creating your own custom

programs, calculations and plots has never been this fast...this simple. Time savings are dramatic as TACT's LEARN mode writes and remembers most of your programs for you. Automatically.



Perform complex data reductions. Print a complete analysis. Plot trends from previous tests. And automate pass/fail decisions. They're no problem. You just need TACT.

BASIC language - SUPERIOR performance.

A built-in BASIC language with easy access to on-screen prompts and menus puts even more power in your hands. All scope functions, conditional testing, variable storage, custom printer and plotter output capabilities are just a touch away. With TACT, put waveforms in; get reliable answers out.

To simplify your testing you need two things. Nicolet...and a little TACT. Call Nicolet toll free 1-800-356-3090 for further information.

Nicolet Test Instruments Division

5225 Verona Road, Madison, WI USA 53711-4495, Tel. 608-273-5008
Toll free in U.S. 1-800-356-3090.

Nicolet
INSTRUMENTS OF DISCOVERY

NEW PRODUCTS

TEST & MEASUREMENT INSTRUMENTS

1-GHz-Bandwidth Telecomm And General-Purpose DSOs

- Automatically make eye-pattern measurements
- Make statistical measurements

With appropriate plug-ins, the CSA 404 and 11403A DSOs have a 1-GHz repetitive-signal bandwidth. Both units have color displays. The CSA 404 makes measurements that are useful in communications work. For example, as it acquires signals, the DSO constructs a statistical database, allowing it to measure jitter and noise without user intervention. The same database enables the unit to make direct, automatic eye-pattern pulse measurements. To determine whether a device under test meets specs, the scope can make mask tests; it stores ten

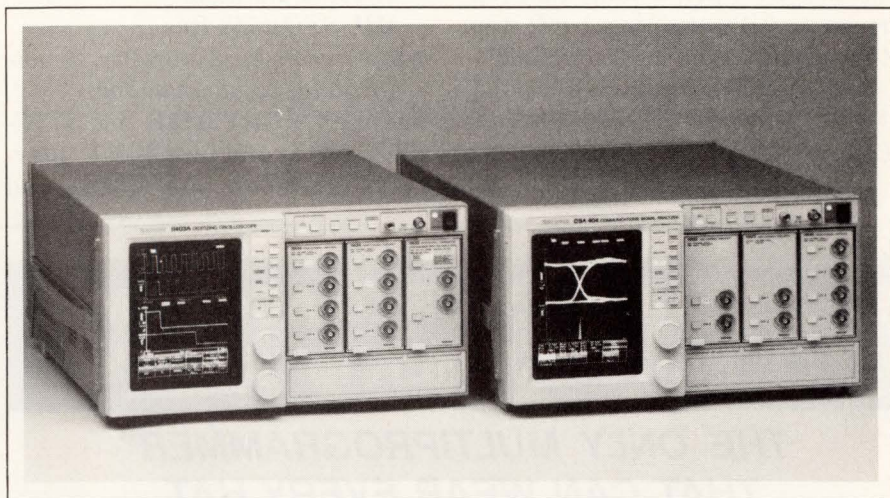

masks in nonvolatile memory. The 11403A, a general-purpose scope with DSP capabilities and as many as eight channels, also makes pass/fail tests. It can display six such

measurements simultaneously. CSA 404, \$22,000; 11403A, \$18,950.

Tektronix Inc, Box 19638, Portland, OR 97129. Phone (800) 426-2200. **Circle No. 360**

Real-Time ICE For 33-MHz i960CA RISC μ P

- Interfaces with MS Windows 3.0
- Performs nonintrusive monitoring and control

The Express Plus is an IBM PC/AT-hosted real-time in-circuit emulator that nonintrusively monitors and controls the 33-MHz version of the i960CA RISC (reduced-instruction-set computer) μ P. The unit's software runs under MS Windows 3.0. The target processor remains in the target system, reducing the likelihood that connecting the emulator will interfere with proper target operation. Besides passively monitoring the μ P's bus, the instrument uses all of the control information available from the μ P to reconstruct programs executing from cache memory. It lets you halt the processor, execute single instructions, set software and hardware breakpoints, examine registers, and trace program execution. The unit is compatible with C-language tools from Intel and Microtec Research. You can obtain interfaces

to the SGDB960 and Xray source-level debuggers. \$28,750. Delivery, 60 days ARO.

Step Engineering Inc, Box 3166, Sunnyvale, CA 94088. Phone (800) 538-1750; in CA, (408) 733-7837. FAX (408) 733-1073. TWX 910-339-9506. **Circle No. 361**

Programmable Power Supply

- Has three outputs—6V at 2A and dual 28.1V at 125 mA
- Uses 12-bit ADC to read back voltages

The PPS-2806 is a triple-output programmable power supply on a card that plugs into the IBM PC bus. The unit contains one supply rated at 6V and 2A, and a pair of supplies that can produce 28.1V at 125 mA. Besides furnishing constant voltage, the last two supplies can produce or absorb constant current. You can also connect them in series or ground their positive or negative terminals. In addition to the supplies, the board contains a 12-bit ADC that can monitor voltage, cur-

rent, or resistance. The board comes with menu-driven software that displays the outputs and ADC readings in numerical and graphic form. You can also control and monitor the board by reading from, and writing to, its registers. \$1295.

Analyx Inc, Box 14644, Fremont, CA 94539. Phone (415) 656-8017. FAX (415) 657-0927.

Circle No. 362

RTD Simulators

- Produce errors as low as $\pm 0.005\%$
- Use Waidner-Wolf shunt circuits to minimize errors

The RTD-100, RTD-100X, RTD-200, and RTD-500/1000 simulate resistance-temperature detectors (RTDs), sometimes called platinum resistance thermometers. The RTD-100X is accurate to $\pm 0.005\%$ over its range of 10 to 1111.11 Ω . To minimize errors caused by contact resistance, the units use Waidner-Wolf shunt circuits on their three most sensitive ranges. With

this technique, a contact resistance of 1.5 mΩ affects the measured resistance by 4 μΩ, a value that represents a 0.4% error in a 1-mΩ step, the smallest step. \$600 to \$1795.

General Resistance, Box 185, North Branford, CT 06471. Phone (203) 481-5721. FAX (203) 481-8937.
Circle No. 363

VMEbus-Based Simulators For MIL-STD-1553 Bus

- *Test and simulate MIL-STD-1553 Bus*
- *Operate as bus controller, remote terminal, or bus monitor*

The EXC-1553VME/E and EXC-1553VXI/E are intelligent interfaces between the VME- and

VXIbuses and the MIL-STD-1553 bus. The modules can also simulate and test the MIL-STD-1553 bus. The vendor furnishes the modules in B and C sizes. They can operate as bus controllers, remote terminals, or bus monitors. In all of these modes, they can detect errors; in the controller and terminal modes, they can inject errors under program control. The units have a memory-mapped interface. Options include sinusoidal and variable-amplitude transceivers. From \$6995.

Excalibur Systems Inc, Box 6839, Fresh Meadows, NY 11356. Phone (718) 357-3500. FAX (718) 357-3544. TWX 650-347-3609.

Circle No. 364

EXPERIENCE A WORLD ACCLAIMED PLD PROGRAMMER for the 90's.

THE ONLY MULTIPROGRAMMER® THAT CAN WEAR EVERY HAT.

BYTEK's Model 135H is a GANG/SET or Universal PLD MULTIPROGRAMMER® All-In-One Site. Performs well in both Production or Development environments. Purchase only the technology support you need today and expand support as required through simple micro disk device library updates.

Programming algorithms are approved by major semiconductor manufacturers. Plus, BYTEK's after-sale support is guaranteed with **over 10 years** as the world's leader in **Low-Cost, High Performance** programming equipment.

- ✓ Supports virtually all Memory Devices and PLDs.
- ✓ 25-key Integrated Keyboard & 40 Character LCD.
- ✓ RS232 & Parallel I/O Port for High Speed Data Transfer.
- ✓ Extensive SET Programming capabilities in either Standalone or Computer Remote operations including Set of Sets.
- ✓ Automatically **Serializes** up to 16 devices at one time.
- ✓ **FREE** Warranty plus **FREE** Device Library Updates for one year.

Also available: EZ-WRITER™ low-cost portable Engineering Programmers, MULTITRAK™-4000 high volume Production Programmers, & UNITRAK™ Universal PLD Programmers.

Order Today on a 15 Day Money-Back Guarantee:

1-800-523-1565

Prices from **\$995^{00*}**



Made in the USA.

BYTEK
Corporation
* U.S. list price only

543 NorthWest 77th Street, Boca Raton, FL 33487
(407)994-3520 * FAX: (407)994-3615 * TELEX: 4998369BYTEK

SPARCstation Interfaces To VXI and VME Buses

- *Plugs into workstation's Sbus*
- *Interfaces to 6U VME systems and B- and C-size VXI systems*

The VXI-SB2020 and VME-SB2020 kits allow you to control VXI and VME systems from Sun Microsystems' SPARCstation workstations. Each kit includes a card that plugs into the workstation's Sbus and generates the MXI (multisystem extensions interface) bus. A 2m MXI cable is included. Also in each kit is a module that receives the MXI bus and plugs into the VXI or VME bus. The VXI kit includes a C-size slot-0 board. The VME kit contains a 6U VME card that works in VME systems and in B-size VXI systems. Both kits include software tools that run under the SunOS operating system. These tools allow you to configure system resources and to control and transfer data to

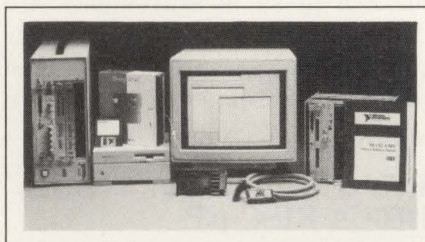

A picture is worth a thousand points in a time interval measurement.

SR620 Output

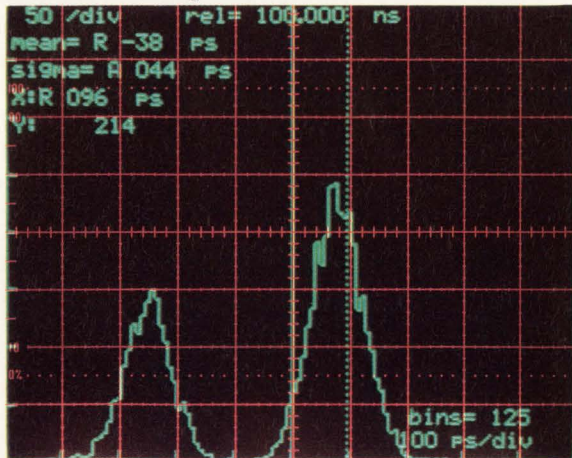

The SR620 brings graphic statistical analysis to time interval and frequency measurements. The SR620 shows you more than just the mean and standard deviation - multimode frequency distributions or systematic drift for example. Histograms or time variation plots are displayed on any X-Y oscilloscope, complete with Autoscale, Zoom, and Cursor functions. Hardcopy to plotters or printers is as easy as pushing a button.

HP5370B Output

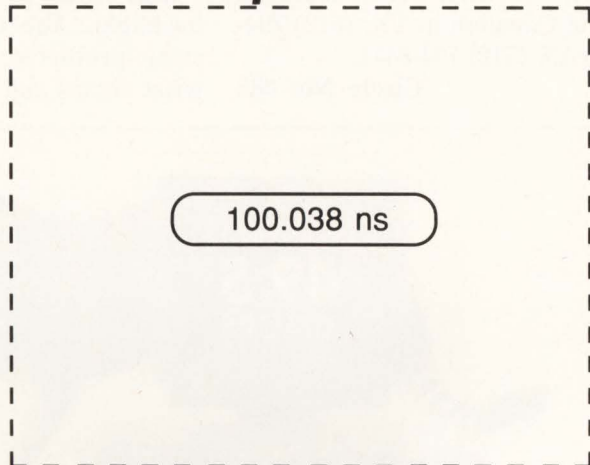

Of course, the SR620 does everything else you'd expect from a high resolution universal counter, such as frequency, period, time interval, pulse width, rise / falltime, and phase measurements. The SR620 offers 25 ps single-shot time and 11 digit frequency resolution and complete statistical analysis, all for a fraction of the cost of comparable instruments.

For the whole picture, call SRS and ask about the SR620.



SR620

\$4500

- 4 ps single shot least significant digit
- 25 ps rms single shot resolution
- 1.3 GHz maximum frequency
- 10^{-9} Hz frequency resolution
- Sample size from 1 to 1 million
- Frequency, period, time interval, phase, pulse width, rise and fall time
- Statistics - mean, standard deviation, min max, and Allan variance
- Analyzer display on any X-Y oscilloscope
- Hardcopy to printer or plotter
- GPIB and RS232 interfaces
- Optional oven timebase



STANFORD RESEARCH SYSTEMS

1290 D Reamwood Avenue, Sunnyvale, CA 94089 TEL (408) 744-9040 FAX 4087449049 TLX 706891 SRS UD

VXI and VME modules. C-size VXI kit, \$3700; VME/B-size VXI kit, \$3300.

National Instruments Corp., 6504 Bridge Point Pkwy, Austin, TX 78730. Phone (800) 433-3488 (US and Canada); in TX, (512) 794-0100. FAX (512) 794-8411.

Circle No. 365

Pocket-Size ESD Tester

- Checks static-protective items
- Shows discharges produced by touching conductors

The Zapflash electrostatic-discharge tester is the size of a pocket flashlight. You can use it to test static-protective devices, such as wrist straps and antistatic mats. It

can also show when a discharge occurs as a result of touching high conductivity areas of objects charged to different potentials—for example, an IC pin and a pc-board trace. You can also use the unit for tests unrelated to static discharges; for example, it can find the “hot” terminal of an ac receptacle. \$19.95.

Anderson Effects Inc., Box 657, Mentone, CA 92359. Phone (714) 794-3792. Circle No. 366



SURVIVAL OF THE FASTEST

Cheetah makes your AT fit for the DSP jungle

At 49.5 MFLOPS (285 MOPS, total), Atlanta Signal Processors' Cheetah™ is one of the fastest cats around. The new DSP add-in board is based on Motorola's DSP96002—the first floating point digital signal processor to use IEEE 754 Standard SP (32-bit) and SEP (44-bit) arithmetic.

In addition to the DSP96002, the Cheetah board houses two Motorola DSP56001 fixed point processors and up to two Mbytes of zero-wait state static RAM. A large family of special-purpose daughter boards is available to take advantage of Cheetah's flexible I/O and memory architecture.

The ASPI board is a versatile tool for developing DSP96002-based systems, including speech coding, color video, stereo sound, three-dimensional graphics and other multimedia applications.

Among the more useful daughter boards are an A/D-D/A data acquisition system, 64-Mbyte memory expansion board and a multi-processor interface.

And you don't need to be a fat cat to own a fast cat. Cheetah can turn your AT into a supercomputer for a very modest investment. For detailed specifications and prices, contact



WORLD LEADERS IN DSP DESIGN TOOLS

770 Spring Street • Atlanta, GA 30308 USA • 404/892-7265 • FAX: 404/892-2512

CIRCLE NO. 13

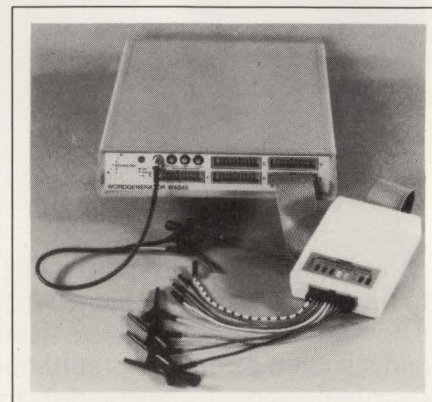

40-MHz, 36-Channel Pattern Generator

- Interfaces to IBM PC via parallel port
- Each channel has 2k-bit data buffer

The R3700 40-MHz digital pattern generator attaches to IBM PCs and compatible computers or IBM PS/2 series computers via a parallel port. It produces outputs compatible with TTL and CMOS logic in continuous, single-shot, and burst modes. The generator has 32 standard data channels and four channels with 3-state outputs. Also included are clock and trigger inputs and outputs. Each data channel has 2k bits of buffer memory (2k × 2 bits for the 3-state channels). The software that accompanies the generator allows editing of data and storing of files in a variety of formats. The software can also produce timing diagrams. \$2995.

Rapid Systems Inc., 433 N 34th St, Seattle, WA 98103. Phone (206) 547-8311. Circle No. 367

Position-Sensitive/ Ranging Components

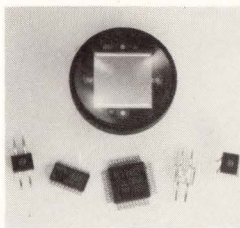

Hamamatsu offers a variety of auto-focus and position detectors especially designed for proximity switching, displacement sensing and

optical distance measurements. They are smaller, faster, require less power and feature more stable performance than comparable types.

Applications include auto-focus cameras, computer disc drives, linear motion detection in industrial equipment, beverage dispensers, robotic controls and automated car wash equipment.

CIRCLE NO. 79

Hamamatsu Photocouplers

Don't miss our newest catalog. It covers the complete line of Hamamatsu photocouplers including CdS Cell, Photo IC and Phototransistor output types. Also included are photointerrupters and photoreflectors.

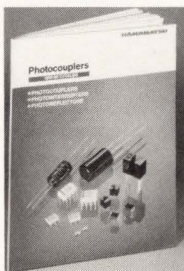

Many can be used in surface-mount applications for non-mechanical position sensing and high voltage isolation of circuits.

Applications include color video signal interface for TV, high speed I/O computer interface, line receiver interface, electronic motor control and switching regulators.

CIRCLE NO. 79

Hamamatsu CdS Photoconductive Cells

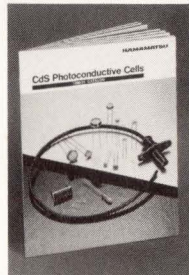

This catalog is a must for every electronics designer. Hamamatsu CdS cells are available in plastic-coated, metal-case and glass-bulb type assemblies for a wide variety of applications.

Applications include exposure meters, light dimmers, musical equipment, flame monitors, street light controls and many others.

CIRCLE NO. 79

Hamamatsu Photodiodes

Did you know that Hamamatsu offers a complete line of photodiodes? From UV to IR, GaAsP, Si, PIN, APD and GaP, they're all here in our latest catalog. Send for it today.

Applications include high speed light sensors, CAT scanners, X-ray monitors, illuminance meters, light absorption meters, light-to-logarithmic voltage conversion circuits and more.

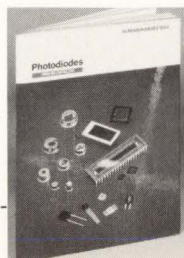

CIRCLE NO. 79

P2288 and P2613 Pyroelectric Detectors

These competitively priced devices feature a large sensitive area and offer optimal spectral response in the near IR. Built-in impedance converting circuitry makes them easy to design into equipment.

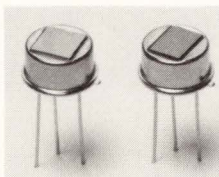

Applications include intrusion and fire detectors, industrial robots and other electronic sensing devices.

CIRCLE NO. 79

Hamamatsu UVtron R2868 Flame Sensor

The UVtron flame sensor can detect the ultraviolet radiation of a match from distances greater than 15 feet. Quick detection, wide directivity and compact design make it easy to integrate the R2868 into your products.

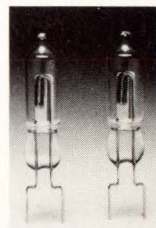

Applications include flame detectors for industrial, automotive and petroleum plant environments; also in horse or livestock stables.

CIRCLE NO. 79



Shed the Shades...

WITH SYNCHRONOUS OPTICAL DETECTION.

Hamamatsu's new S3599 Modulated Photo IC rejects background light up to 10,000 lux (5,000 minimum) without even squinting. That makes it ideal for component environments found in office equipment, industrial control equipment or anywhere photo switches are used.

You'll see the light with Hamamatsu's famous quality. For quantity pricing, call 908-231-0960 or FAX 908-231-1539 today.

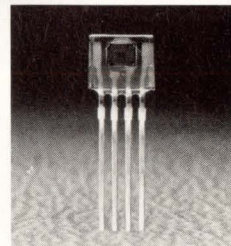

HAMAMATSU

HAMAMATSU CORPORATION • 360 FOOTHILL ROAD, P. O. BOX 6910, BRIDGEWATER, NJ 08807 • PHONE: 908/231-0960

International Offices in Major Countries of Europe and Asia

See Hamamatsu At Sensors Expo West, San Jose, California March 12-14

CIRCLE NO. 79

American Takes A New Approach To Tokyo.



Beginning March 2, American Airlines brings you Japan in a new way. With convenient nonstop service from San Jose/Silicon Valley to Tokyo. That's in addition to our current nonstop from Dallas/Fort Worth.

You'll fly in our new MD-11 LuxuryLiner, specially designed for comfortable long-range travel. And you'll enjoy our International Flagship Service® with everything from roomy leather and sheepskin seats in First and Business Class to award-winning food and wine, including a choice of authentic Japanese entrees. And of course, members of our AAdvantage® travel awards program will earn valuable mileage credit.

Only American brings you Tokyo like this. So call your Travel Agent or American Airlines at 1-800-624-6262. And experience the American approach to Japan.

American Airlines®
Something special to Japan.

Schedules subject to change. AAdvantage® is a registered trademark of American Airlines, Inc. American Airlines reserves the right to change AAdvantage program rules, regulations, travel awards and special offers without notice, and to end the AAdvantage program with six months notice.

NEW PRODUCTS

CAE & SOFTWARE DEVELOPMENT TOOLS

Source-Level C Debugger For Motorola's 68000 μ P family

- Includes cable to connect a target ROM socket to a PC host
- Provides six display windows for program I/O and debugging data

The Quickfix C-language source-level debugger complements the vendor's cross-compiler for 68000-based embedded applications. The debugger makes use of a cable that connects the ROM socket of a target system to a parallel port on the host IBM PC or compatible. To configure the ROM socket driver, you need only specify the ROM socket base address, the socket width (8, 16, or 32 bits), and the ROM size. You can use host RAM in place of the ROM, or you can piggy-back the displaced ROM onto the cable so that both the ROM and the debugger operate simultaneously through the common socket. The debugger provides six windows: The source window displays the C or assembly-language execution context whenever the debugger stops; the register window displays the contents of the processor registers; the command window accepts your commands and displays their results; a

```
Terminal
Alphabetized Colors: Blue Green Indigo Orange Red Violet Yellow

Data Display
1) listfil = "Blue"          2) listli + 1j = "Green"

Registers
00-00000001 00000000 2-0000ffff 00000000 4-00000006 00000000 6-00000000 00000000
00-00003ff4 000063fc 2-00000000 00f3fffa 4-000059fd 00006614 6-00003fe4 00003fd4

Source
 8  for( top = sizeof(list) / sizeof(char *) - 1; top; top-- ) {
 9  for( i = 0; i < top; i++ ) {
10) if( strcmp(listfil, listli + 1j) > 1 ) {
11      j = listfil;
12      listfil = listli + 1j;
13      listli + 1j = j;
14  }
15  }
16  }
17  for( i = -1; i < (sizeof(list) / sizeof(char *)); i++ )
18  printf("%s ", (i == -1) ? "Alphabetized Colors:" : listfil);
    Module: colors.c      Func: main

> run
Starting program colors.out at 0x5000
Breakpoint 1: main() .. colors.c line 18
>
```

data-display window shows the current values of specified C expressions; a terminal window emulates a terminal connected to the target and displays output from the program under test; and a help window provides on-line, context-sensitive

debugger command and usage information. Quickfix, \$1750; Quickfix with the Sierra C compiler, \$1500.

Sierra Systems, 6728 Evergreen Ave, Oakland, CA 94611. Phone (415) 339-8200. FAX (415) 339-3844.

Circle No. 358

Printed-Circuit-Board Design System

- All modules share the same database and user interface
- Symbol library includes IBM PC expansion-board symbols

Eagle (Easily Applicable Graphics Layout Editor) handles all phases of pc-board design, from net-list input through layout to autorouting. All modules share the same database and menu-driven user-interface, so moving from one module to another is fast and easy. You can issue commands from a mouse, a keyboard, or a combination of both; the macro facility lets you assign frequently used command se-

quences to a function key; the total number of macros is limited only by the amount of available memory. The symbol library includes DIP and SMT devices, Zilog, Intel, and PAL devices, passive components, and standard IBM PC expansion boards. You can edit any of the library symbols and create your own symbols for inclusion in the library. The Undo/Redo feature backs up all command sequences in an unlimited history file, thereby allowing you to recover from errors or unsuccessful design steps. The system can work with both EGA and VGA graphics (color or monochrome) and can output to dot-matrix and laser

printers, or to a Gerber photoplotter. To run the program, you need an IBM PC or compatible with at least 640k bytes of RAM and a hard disk; the program will use a mouse or a math coprocessor if these are present. Schematics editor, \$495; Eagle alone, \$399, or \$699 with autorouter; complete system with schematics editor, layout editor, autorouter, and Gerber driver, \$1199.

American Small Business Computers Inc, 327 S Mill St, Pryor, OK 74361. Phone (918) 825-4844. FAX (918) 825-6359.

Circle No. 359

SAMTEC SLASHES SHIPMENTS TO 5 DAYS



MON	TUE	WED	THU	FRI
1	2	3	4	5

On orders of up to 1000 connectors.

With Samtec "Super Service" we'll ship up to 1000 of just about everything in our catalog in just 5 days. This includes *all* machined strip, DIP and PGA interconnects, *all* .025" square post headers and sockets, *all* board stackers, *all* low profile interconnects, *all* .050" centerline micro interconnects... virtually everything in over 100 pages of interconnect solutions. The only excluded items are cable assemblies and other custom interconnects.

For common connectors shipped from stock, in two days guaranteed, or nearly anything else shipped in just five, experience Samtec Sudden Service today.

Call your local stocking Samtec distributor, or

1-800-SAMTEC-9

Until 7:00 pm EST



**SUPER
SERVICE**

1000
CONNECTORS
SHIPPED IN
5 DAYS



samtec

IS SUDDEN SERVICE

New Albany, Indiana USA • Sacramento, California USA • Cumbernauld, Scotland UK • Singapore

SAMTEC, INC. P.O. Box 1147 • New Albany, IN 47151-1147 USA • Phone 812-944-6733 • Fax 812-948-5047 • TWX 810-540-4095 • Telex 333-918

NEW PRODUCTS

COMPONENTS & POWER SUPPLIES

Low-Power Switches

- Available in multiunit versions
- Have switch life of 100,000 operations min

KS Series switches are available in individual (KSM) and multiunit (KSR) versions. The spst KSM units handle loads as high as 24V at 50 mA. Contact resistance measures 100 m Ω max, and switch life is 100,000 operations at rated load. Insulation resistance and dielectric strength equal 100V dc and 250V ac, respectively. KSR devices are available in 4-, 6-, and 14-switch blocks. Offered in spst and dpst configurations, the multiswitch units are rated for loads of 20V at 2 mA max. Insulation resistance and dielectric strength for these devices measure 100V dc and 150V ac, re-

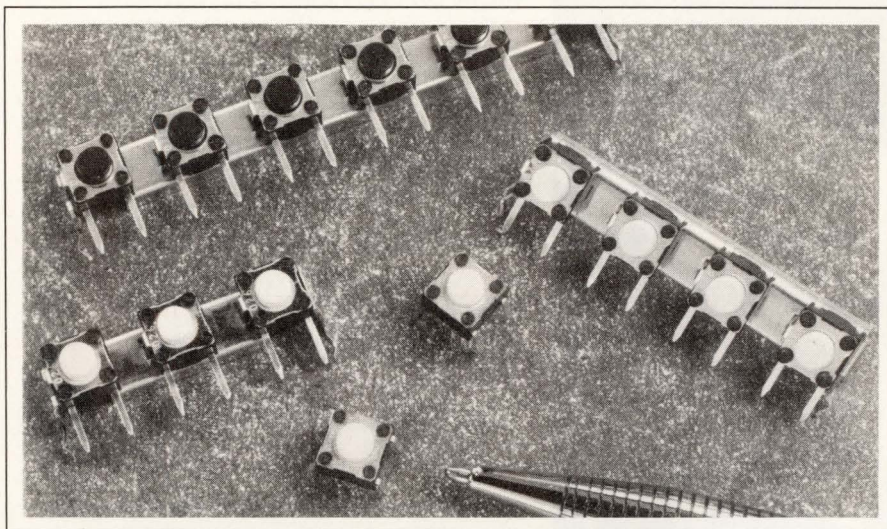

spectively. With a 5V/1A load, switch life for KSR devices equals 200,000 operations. Contact resistance measures 500 m Ω max. KSM

versions, from \$0.04 (OEM qty).

Hokuriku USA Ltd, 8145 River Dr, Morton Grove, IL 60053. Phone (708) 470-8440. **Circle No. 368**

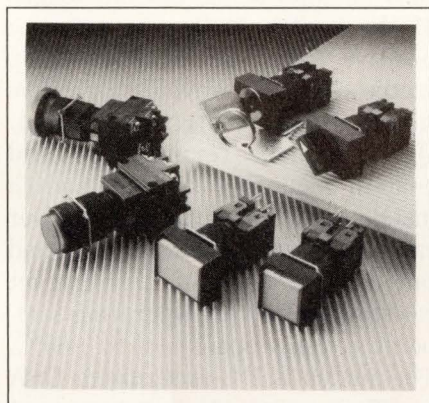

Lighted Pushbutton Switches

- Offer a choice of light sources
- Available with spdt or dpdt contact configurations

A3G LPB switches feature a snap-lock, socket-mount design that allows you to connect the actuator to the base easily. The units mount in 16-mm panel cutouts, have a 100,000-operation lifetime, and are available with spdt or dpdt contacts in momentary, alternating, or indicator versions. Pushbuttons and indicators are available in round, square, or rectangular styles with

a choice of LED, incandescent, or neon light sources. General-purpose contacts are rated for 3A at 250V ac, 5A at 125V ac, or 3A at 30V dc. Ratings for low-level applications are 100 mA at 125V ac or 30V dc. The switches feature oil-resistant (IP65) service ratings. The line also includes nonlighted, selector switch, and key-type versions. Lighted switches, from \$7.80; non-lighted models, from \$5.90 (500).

Omron Electronics Inc, 1 E Commerce Dr, Schaumburg, IL 60173. Phone (708) 843-7900. FAX (708) 843-7787. **Circle No. 369**

IDC Sockets/Headers

- Offer as many as 100 positions
- Rated for 5A at 30V

The sockets in this line of IDC (insulation displacement connector) devices accept 0.025-in. pitch cable. The sockets and headers are available in sizes ranging from 10 to 100 positions and come with either straight or right-angle leads. The units accept #30 AWG pitch planar

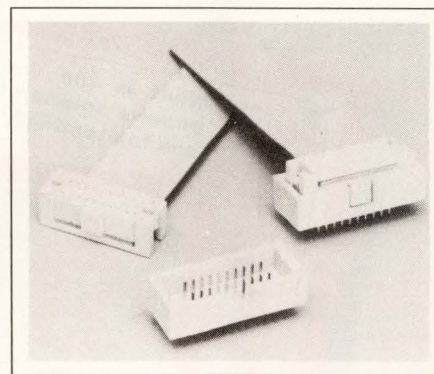

cable and mate with 0.016-in. square pins. The socket and header combination is rated for 30V at 0.5A. The socket features a double-beam contact design. Contacts are phosphor bronze with 30 μ m of gold plating over 100 μ m tin. The glass-filled polyester insulators carry a 94V-0 UL flammability rating. \$0.045 to \$0.050 (1000) per position for sockets; \$0.03 per pin for headers. Delivery, stock to six weeks ARO.

Carrot Components Corp, 4620 Calle Quetzal, Camarillo, CA 93012. Phone (805) 484-0540. FAX (805) 484-7458. **Circle No. 370**

- Crystals
- Crystal Oscillators
- Crystal Filters
- Ceramic Resonators

RALTRON

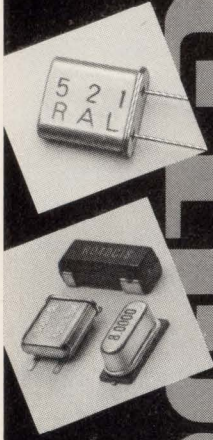

WHEN IT COMES TO HIGH ACCURACY CRYSTAL UNITS, ONLY RALTRON HAS IT ALL.

RALTRON manufactures one of the industry's most complete lines of high quality crystal units. Call us for all your crystal needs from micro-processor to AT strip to tuning fork to high accuracy. Or call us for our 28 page catalogue.

HIGH ACCURACY CRYSTAL UNITS

- Frequency Range: 1.0 MHz-360 MHz
- Mode of Oscillation: Fundamental to 9th O.T.
- Frequency Tolerance: @ 25°C: ± 2.5 ppm to ± 100 ppm
- Frequency Stability: ± 3 ppm (- 10°C to + 60°C) to ± 50 ppm (- 55°C to + 105°C)

SURFACE MOUNT CRYSTAL UNITS HC-45/U SMD, TT SMD, HC-49S SMD

- Frequency Range: 3.5 MHz-360 MHz
- Mode of Oscillation: Fundamental to 9th O.T.
- Frequency Tolerance: @ 25°C: ± 2.5 ppm to ± 100 ppm
- Frequency Stability: ± 3 ppm (- 10°C to + 60°C) to ± 100 ppm (- 10°C to + 70°C)

The Products. The Prices. The People. Only RALTRON has it all.

RALTRON ELECTRONICS CORP.

2315 NW 107th Avenue, Miami, Florida 33172
FAX (305) 594-3973 TELEX 441588 RALSENUI
(305) 593-6033

CIRCLE NO. 14

COMPONENTS & POWER SUPPLIES

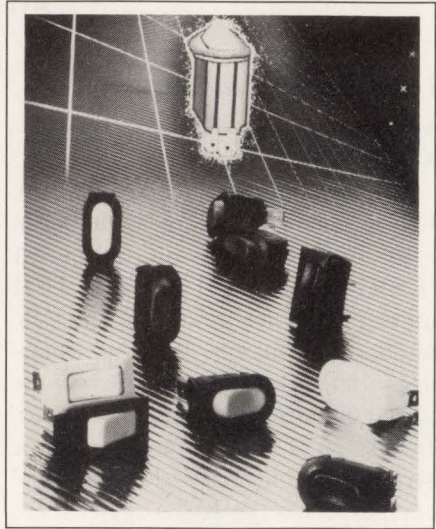

Rocker Switch

- Handles 16A
- Provides tactile feedback

STR Series 16A rocker switches are available in oval-shaped and rectangular versions. The units have tapered bezels and a recessed channel that extends along the full length of the rocker surface to promote positive finger positioning. Crisp tactile feedback provides a positive indication of switch activation. Quick-connect termination and snap-in mounting simplify switch installation. The devices have silver cadmium contacts. The housing and button are made of high-impact resistant polyester. Operating temperature range spans - 40 to + 65°C. The switch is UL recognized, CSA certified, and is designed to meet VDE standards. \$0.57 (10,000). Delivery, 8 to 10 weeks ARO.

Micro Switch, 11 W Spring St,
Freeport, IL 61032. Phone (815)
235-6600. **Circle No. 371**

Supertwisted LCD

- Features a 640 × 400-pixel display area
- Has an 18-cd brightness

The TLX-1641-G3B is a 640 × 400-pixel transmissive, electroluminescent-backlit, blue-mode supertwisted LCD. The unit features a 9.3-in.-diagonal screen, an outline di-

What is the world's most popular solution for modem and fax testing?

Q. _____

Q. _____

Q. _____

Q. _____

Q. _____

A. Drop three times from a height of 10'

A. Transfer files to all your friends

A. Build some kind of test gizmo

A. Buy the TAS 100



You Guessed It! TAS 100 Series Telephone Network Simulators provide full-featured modem and fax testing in a compact, easy-to-use package.

- Complete, bi-directional simulation of transmission impairments for thorough testing
- Fully automatic emulation of worldwide central office (exchange) formats

- Compatible with U.S., international, and major manufacturer standards
- Works with the TAS Gemini dual data analyzer and TASKIT software to provide completely automatic modem performance evaluation.



TAS 100: Field-Proven Advanced Technology for Modem and Fax Testing

Telecom Analysis Systems, Inc.

34 Industrial Way East, Eatontown, NJ, 07724-9917 • (908) 544-8700 • FAX (908) 544-8347

CIRCLE NO. 15

NEW

Introducing the Highest Standards in the Industry.



Gates New High Capacity VALUMAX™ Line.

At Gates, our standards have reached new heights. With our VALUMAX line of Ni-Cd cells—the best value cells on the market.

VALUMAX cells are available in all the sizes you need to make virtually any product perform like no other standard cell can. For example, the VALUMAX C cell gives you up to 25% more run time. And our 4/5 Cs, Cs and AA cells deliver as much as 33% more capacity than even our closest competitor.

In fact, with VALUMAX you get premium performance without paying the premium price. And that makes VALUMAX the best value—dollar for dollar—of any cell you can buy.

So isn't it time you raised your standards? Gates VALUMAX—we're setting the standard.

Gates Energy Products, Inc.,
P.O. Box 861, Gainesville, FL
32602, 1-800-67-POWER.



The power of great ideas.

The "OEM Solution": A low-cost, single-board development system for ROM-based, embedded applications

The CPU-186

CMOS construction means low power consumption

Up to 512k battery-backed SRAM

16-bit 80C186 CPU, up to 16 MHz operation for real-time applications

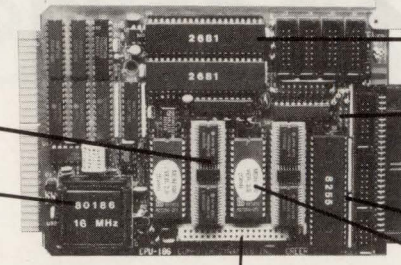

4 serial channels; includes RS-422/485 interface

Battery-backed clock/calendar and watch-dog timer

24 TTL/PIO lines

4 counter/timers

Up to 256k EPROM

SBX interface for piggy-backing extra functions

The Software

1. Develop your code on your PC.
2. Our source-level debugger lets you test your program right on the target hardware.
3. Our ROMing utility gives you everything you need to ROM your program. Even duplicates the disk-less MS-DOS environment!

Price—\$476 (OEM Quantities)

FREE Demo Diskette available JUST CALL

**Delivery Now!
803-877-8700
FAX 803-879-2030**

Member **STDMG**

Computer DYNAMICS
COMPUTER DYNAMICS SALES
107 SOUTH MAIN STREET, GREER, SC 29650

CIRCLE NO. 16

COMPONENTS & POWER SUPPLIES

mension of 256 × 146 × 10.5 mm, and an active area of 191.97 × 119.97 mm. Total weight of the display, including the electroluminescent backlighting, is 400g. Dot pitch and size measure 0.30 × 0.30 and 0.27 × 0.27, respectively. Typical contrast is approximately 5:1. At 2.7W, the display has an 18-cd/m² surface brightness. An integral 8-bit parallel interface is standard. \$200 (10,000). Delivery, 12 weeks ARO.

Toshiba America Inc, 1 Pkwy N, Suite 500, Deerfield, IL 60015. Phone (708) 945-1500.

Circle No. 372

Cooling Fan

- Features automatic speed control
- Reduces noise by 15 dB

Smart Fan's self-contained electronics automatically controls its speed to regulate temperature in equipment enclosures against changes in room temperature, system power dissipation, flow resistance, and altitude. A self-contained thermistor senses the temperature changes, and proprietary control electronics adjusts the airflow to maintain a constant temperature once the system temperature exceeds a preset minimum level. This scheme protects critical components against temperature-related failure and reduces the overall noise by 15 dBA. The fans are available with an internal alarm, which activates when temperatures exceed the norm by 10°C, or when there is a loss of cooling-system power. The fans are offered in a variety of popular sizes including 4.7 × 4.7 × 1.5, 3.6 × 3.6 × 1, and 4.7 × 4.7 × 1 in. \$15 (5000).

NMB Technologies Inc, 9730 Independence Ave, Chatsworth, CA 91311. Phone (818) 341-3355. FAX (818) 341-8207. TLX 651340.

Circle No. 373

We listen, we hear, we lead.



Fifty, seventy-five, one-hundred-year-old companies survive today because they listened and learned from experience. At 60 plus, we're still listening and learning.

By listening to your problems and needs, we're able to develop and bring new ideas to the table—solutions that often lead to a long working relationship. Listening! It's part of what we're known for.

If you use *short run metal stampings*, give us a call. You talk, we'll listen. It could be the beginning of a lasting relationship. Call TOLL FREE.

1-800-677-8881

Dayton Rogers

MANUFACTURING CO.

& subsidiaries Federal Stampings, Inc.

Call or write for our free booklet "How To Design Metal Stampings."



2824-13th Avenue South, Minneapolis, MN 55407
Fax: 612-871-2646

Minneapolis, MN • Rochester, NY
St. Petersburg, FL • Columbus, OH
Arlington, TX • Eugene, OR
Van Nuys, CA

CIRCLE NO. 17



The Standard for Circuit Simulation

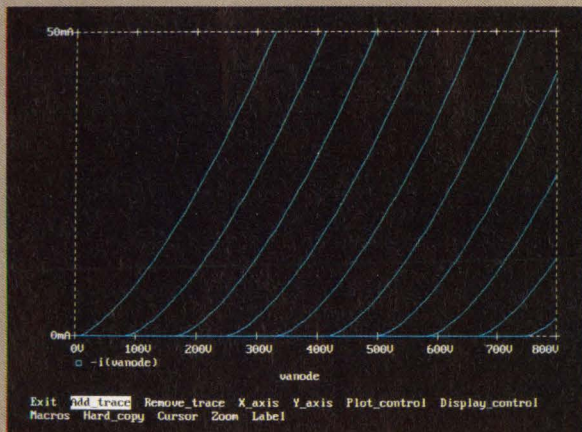

I-V curves of a triode vacuum tube

Analog Behavioral Modeling

The Analog Behavioral Modeling option for the PSpice Circuit Analysis package allows you to describe analog components, or entire circuit blocks, using a formula or look-up table. Linear blocks may be described using either a Laplace transform or a frequency response table. Once defined, you can use these blocks in all PSpice analyses, including DC, AC, and transient.

Modeling entire blocks of circuitry is a powerful aid in designing a system from the top down. You can describe a functional block by its behavior without worrying about how that function will be implemented. Later on in the design process, you can replace the block with the actual circuitry.

Another application is the modeling of electronic components which are not built into PSpice. The photo shows an example of simulating the DC characteristics of a 3/2-power-law device.

Since its introduction over six years ago, MicroSim's PSpice has sold more copies than all other SPICE-based programs combined. PSpice provides broad capabilities, accurate results, diverse options, and availability across a wide range of computer platforms. PSpice includes an extensive device library of 3,000+ analog parts and 1,300+ digital parts, at no extra charge.

Besides Analog Behavioral Modeling, PSpice provides the following options:

Digital Simulation: simulation of mixed analog/digital circuits with feedback between the analog and digital sections.

Monte Carlo Analysis: calculates the variations in a circuit's performance allowing for component tolerances. This option performs statistical analyses: Monte Carlo, Sensitivity, and Worst Case.

Probe: acts as a "software oscilloscope" to provide an interactive viewing and processing environment for simulation results (see photo).

Parts: is a parameter extraction program allowing the extraction of device model parameters from data sheet information.

PSpice is available on the PC (running DOS, Protected Mode DOS, or OS/2), Macintosh II, Sun 3, Sun 4, and SPARCstation, DECstation 2100, 3100, and 5000, and the VAX/VMS families.

In addition to the Circuit Analysis package, the PSpice family of products also contains the Circuit Synthesis package, which consists of our two filter synthesis products: Advanced Filter Designer and Standard Filter Designer. Filter Designer is an interactive design aid for synthesizing and analyzing active filters. Features include:

- Analysis of low pass, high pass, band pass, and band reject filter types.
- Synthesis of all available filter types using Butterworth, Chebyshev, Inverse Chebyshev, and Elliptic (Cauer) functions.
- Capability to synthesize arbitrary transfer functions and delay equalization filters (only available in Advanced Filter Designer).

Each copy of our Circuit Analysis and Circuit Synthesis programs comes with MicroSim's extensive product support. Our technical staff has over 150 years of combined experience in CAD/CAE, and our software is supported by the engineers who wrote it.

For further information about the PSpice family of products, call us at (714) 770-3022 or toll free at (800) 245-3022. Find out for yourself why PSpice has become the standard for circuit simulation.

20 Fairbanks • Irvine, CA 92718 USA • FAX (714) 455-0554

Recording the Past... ... Plotting the Future

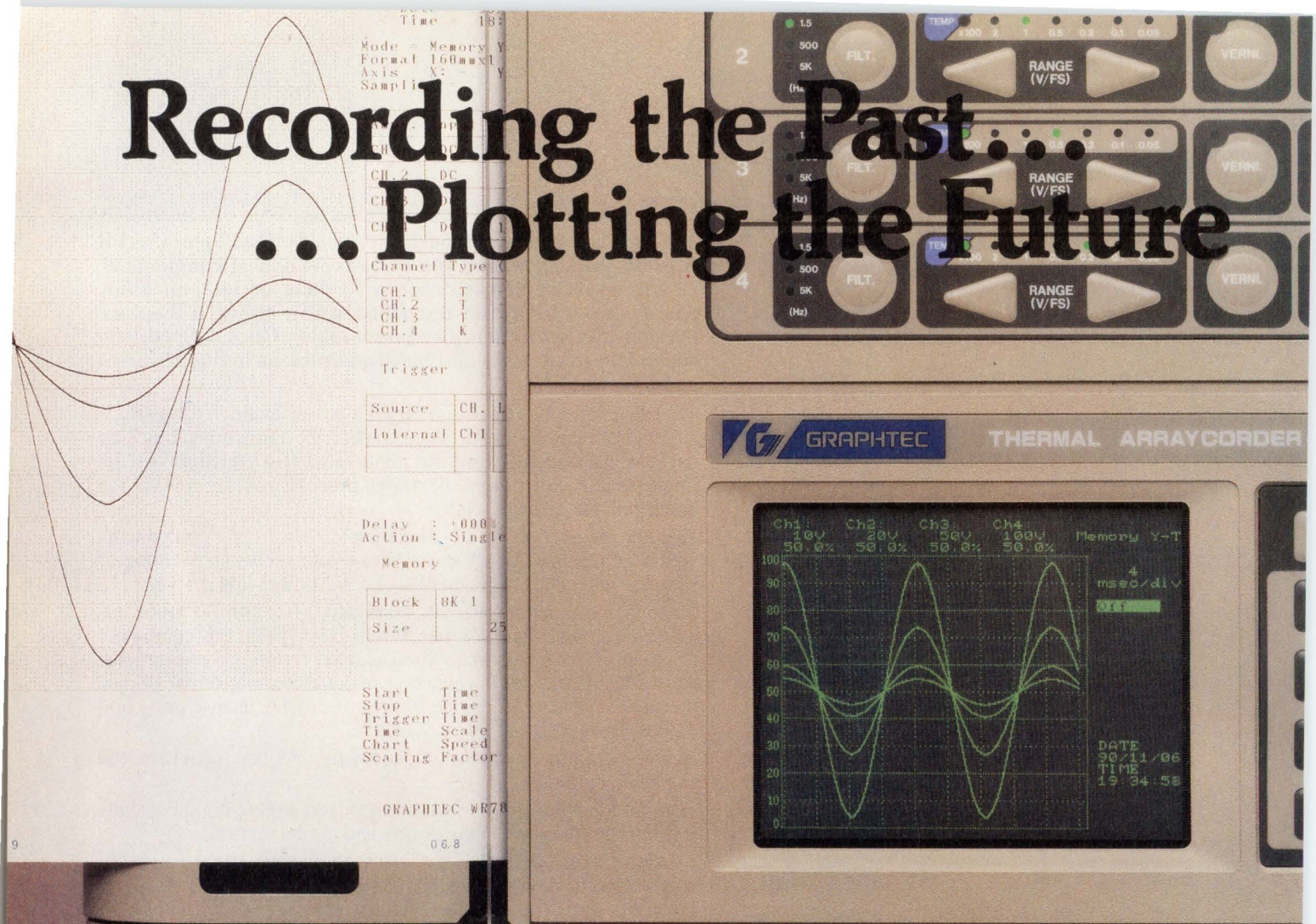

Our reputation precedes us! From 5 subsidiaries and 35 distributors in more than 40 countries worldwide, thousands of customers purchased more in 1989 than ever before. And they were able to choose new products from an ever-expanding array of plotters, penless plotters, digitizers, recorders and supplies.

The Graphtec reputation is one of building products that work well and last a long time. We earned that reputation the hard way, by delivering over 40 years of the best innovation, support, and after-sales service in the industry.

You really can see the difference in Graphtec products. Our new WR7800 Thermal Arraycorder not only has a 14-bit A/D converter for better waveform accuracy, it also includes an easy-to-read 320x256 dot electroluminescent screen for monitoring real-time or stored data. Other notable features include 32Kb and 256Kb memory cards, 3 built-in thermocouple inputs, an RS-232C interface (GPIB optional), and a jog dial for easy operability.

We invite you to go see a Graphtec WR7800 and experience these enhanced features firsthand.



WR7800



GRAPHTEC CORPORATION 503-10 Shinano-cho, Totsuka-ku, Yokohama 244, Japan Tel: (045) 825-6250 Fax: (045) 825-6396
U.S.A.: Western Graphtec, Inc. Tel: (714) 770-6010 Fax: (714) 855-0895 **Australia: Southern Graphtec Pty. Ltd.** Tel: (02) 748-4888 Fax: (02) 748-4882
Europe: Graphtec Europe GmbH Tel: (040) 511-5059 Fax: (040) 511-9155 **United Kingdom: Graphtec (UK) Ltd.** Tel: (0270) 625-115 Fax: (0270) 626-733

NEW PRODUCTS

COMPUTERS & PERIPHERALS

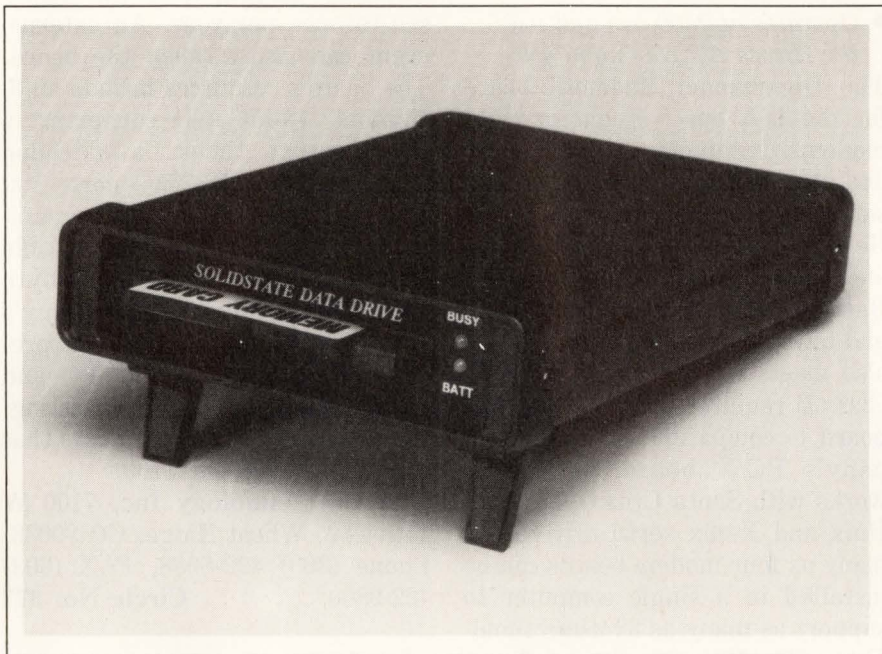

Solid-State Drive

- Transfers data between memory cards and desktop computers
- Drives interface with RS-232C and parallel ports

The family of Solidstate data drives can transfer data between memory cards used in notebook computers and desktop computers. Because the drives have either an RS-232C port, a parallel port, or a floppy-disk controller interface, virtually any desktop computer can access data on the memory cards. Memory

cards are more reliable than floppy disks for two reasons: They don't require read-write heads that can crash, and they are less susceptible to shock and magnetic fields. Device drivers are available for MS-DOS-compatible computers. Drive with RS-232C port, \$350; drive with parallel port, \$350; internal drive with floppy-disk-drive interface, \$295.

Adtron Corp, Box 1848, Gilbert, AZ 85234. Phone (602) 961-7511.

Circle No. 374

Sbus Expansion Boards

- Consist of a SCSI host adapter and communication board
- Communications board has one parallel and eight serial ports

Two Sbus expansion boards are available for the company's desktop SPARC workstations. The serial parallel controller, a communications board, has eight serial ports and one parallel port. You can install three boards in a SPARCstation 1/1+ to connect as many as 18 asynchronous devices such as modems, printers, and terminals.

Each port on the card can transfer data at 38.4k baud. A SCSI host adapter connects as many as seven SCSI devices to the workstation. The board can transfer data at 5M bytes/sec and divides heavy disk traffic between two SCSI channels. It supports disk drives with as much as 2.6G bytes of storage. Serial parallel controller, \$1095; SCSI host adapter, \$495.

Sun Microsystems Inc, 2550 Garcia Ave, Mountain View, CA 94043. Phone (415) 960-1300. FAX (415) 969-9131. Circle No. 375

Technical calculations made easy!

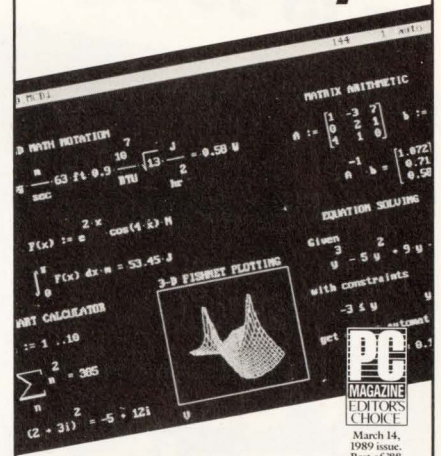

Perform engineering and scientific calculations faster... and with fewer errors.

- **MathCAD 2.5** does your numerical analyses quickly, easily... and inexpensively! The live document interface™ lets you integrate equations, text, and graphics on your computer screen. You can see what you solve... and update your equations and graphs with a single keystroke.
- **You do the thinking while MathCAD does the work.** MathCAD picks up where calculators and spreadsheets leave off. With over 120 commonly-used functions built-in, MathCAD can handle your formulas, exponentials, differentials, cubic splines, FFTs, and matrices.
- **Applications Packs** customize MathCAD to your work. Seven different packs are available for electrical, mechanical, and chemical engineering and other technical applications.
- **MathCAD works on your PC, Macintosh, or UNIX workstation.** More than 100,000 engineers and scientists are already using MathCAD to turn their computers into powerful workstations that can handle virtually any technical application.

Call 800-MathCAD, ext. 335 to request a free demo disk!

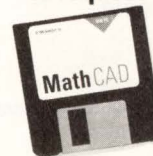

In Massachusetts, call 617-577-1017, ext. 335.

For a free MathCAD Introductory Kit, clip this coupon and mail it back to us. Or circle your reader service card.

Yes! Tell me more about MathCAD!

Name _____

Title _____

Company _____

Address _____

City _____ State _____ Zip _____

Phone (____) _____

MathSoft, Inc.
201 Broadway
Cambridge, MA 02139
Tech/EDN990 #13 EDN020491

CIRCLE NO. 18

Lowest Profile
0.5" ht.,
up to 55 Watts



PICO AC-DC Power Supplies

- Input Voltage 90 to 130 VAC (47/440Hz)
- Single, Dual, Triple Outputs
- 1200V Rms Isolation
- Low Isolation Capacity Available
- Continuous Short Circuit Protection
- High Efficiency
- Fully Regulated Voltage Outputs
- Operating Temperature -25°C. to +70°C. with No Heat Sink or Electrical Derating Required
- Expanded Operating Temperature Available (-55°C. to +85°C. ambient)
- Optional Environmental Screening Available

PICO manufactures complete lines of Transformers, Inductors, DC-DC Converters and AC-DC Power Supplies

Delivery—
stock to
one week

SEE EEM,
THOMAS REGISTER
OR SEND DIRECT FOR
FREE PICO CATALOG

**PICO
Electronics, Inc.**

453 N. MacQuesten Pkwy. Mt. Vernon, N.Y. 10552

Call Toll Free **800-431-1064**

IN NEW YORK CALL **914-699-5514**

CIRCLE NO. 19

COMPUTERS & PERIPHERALS

Modem Board

- Has as many as eight modems on one ISA bus board
- Operates at 2400 bps and uses the Hayes AT command set

The Digichannel Modem/X board for the ISA bus has four or eight modems. It can operate at 2400 bps and utilizes the Hayes AT command set. The modem conforms to the Bell 103, Bell 212A, CCITT V.22, and CCITT V.22 bis specifications. Besides providing autoanswering and tone or pulse dialing, the board also meets FCC Part 68 and FCC Class B requirements. Because the board is compatible with the company's PC/X board, the board works with Santa Cruz Operation's Unix and Xenix serial drivers. As many as four modem boards can be installed in a single computer to support as many as 32 users simultaneously. You can also configure the board's address and interrupt requests in software. 4-modem board, \$1195; 8-modem board, \$1995.

Digiboard, 6751 Oxford St, Minneapolis, MN 55426. Phone (612) 922-8055. **Circle No. 376**

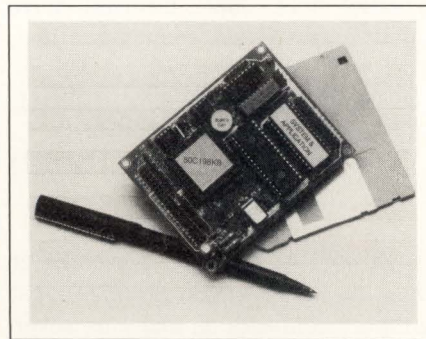

Single-Board Computer

- Measures 3×4 in.
- Uses 80C196KB μ P and runs Forth programs

The SBC196 single-board computer for embedded applications uses a 12-MHz 80C196KB or 80C196KC μ P and measures 3×4 in. It runs from a single 5V supply and draws 80 mA while operating, 20 mA while idling, and <1 mA in a sleep

mode. A real-time clock can awaken the board from the sleep mode at intervals varying from 100 times/sec to once per year. An external event can also awaken the board. The board's resources include an 8-channel, 10-bit A/D converter; a PWM output; timers; a watchdog timer; and an RS-232C port. You can use the serial port to communicate with an IBM PC-compatible computer. An onboard 32k-byte EPROM contains the company's version of Forth, F83+. You prepare source code on the PC and download it to the board for testing. The board has two serial buses that connect peripherals. \$169.

Vesta Technology Inc, 7100 W 44th Ave, Wheat Ridge, CO 80033. Phone (303) 422-8088. FAX (303) 422-9800. **Circle No. 377**

SPARC Workstation

- Runs at 40 MHz and has 16M bytes of RAM
- Has three Sbus slots and Ethernet port

The SPARCstation 2 family of workstations uses a 40-MHz CMOS SPARC integer and floating-point processor. The system's CPU board also contains a SCSI controller; an Ethernet controller; 16M bytes of memory expandable to 96M bytes; an audio port; and two serial ports. The system achieves 21 Specmarks, which is a figure that represents the geometric mean of 10 benchmark tests. The system runs the SunOS operating system and supports the following network protocols: NFS, TCP/IP, PC-NFS, and TOPS. Features include three Sbus expansion slots; a 3½-in., 1.44M-byte floppy-disk drive; and support for an internal 414M-byte drive. You can also attach an external drive for a total capacity of 7.6G bytes. A GS and a GT model has 3D color graphics. \$14,995.

Sun Microsystems Inc, 2550 Garcia Ave, Mountain View, CA 94043. Phone (415) 960-1300. FAX 969-9131. **Circle No. 378**

Fan and filters engineered to minimize dust, maximize air flow.

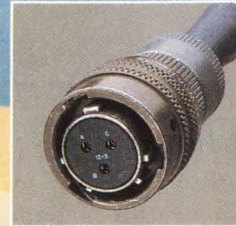
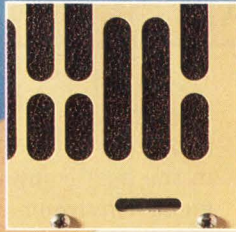

Sealed, military-type connectors for the power supply and video input.

Individually ruggedized printed circuit boards protect against damaging shock and vibration.

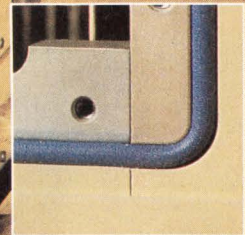
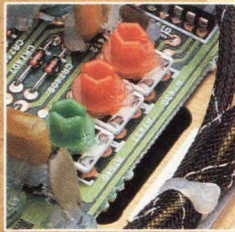

Silver impregnated shield gasket keeps moisture out and controls EMI.

BUILT RUGGED FROM THE GROUND UP

THE KMS IP-1617/U COLOR MONITOR

Now, a desert-ready rugged monitor so versatile, it can handle any C⁴I application. So tough, it can take it all: Shock. Vibration. Cold. Heat. Dust. Rain. And sand.

The IP-1617/U color monitor has been customized for rugged applications. Many systems are in use today with armed forces throughout the world on land, sea and in the air.

KMS products have incredibly low return-for-repair rates. And KMS support is legendary; we can handle your questions and unique engineering problems immediately.

- Advanced Flat Technology Monitor (FTM™)
- Superior Glare Resistant 14" Screen
- Full Analog Capability
- Infinite Array of Brilliant Colors
- VGA, EGA, CGA, MDA and HGC Compatible
- 640 dots x 480 Lines Resolution
- Compliant with MIL-STD-810 Environmental Tests and MIL-STD-461/462 EMI/RFI Requirements
- 90-135/200-265 VAC, 48-62 and 400 Hz, Switch Selectable
- Horizontal Scan Frequency 31.5 kHz

- 0.31 mm Dot Pitch
- Front Mounted Controls
- On/Off Circuit Breaker
- Portable or Rack-Mount
- TEMPEST Model Available

It's no wonder KMS has been the leader in rugged engineering of computer systems since 1987.

For more information on the complete line of KMS rugged computer products, call **1-800-521-1524**. In Europe, call ACAL/Technitron ISD 44 (0252) 851085.

GSA Schedule #GS00K89AGS6289
FTM is a trademark of Zenith Data Systems Corp.

KMS Advanced Products

700 KMS Place, Ann Arbor, MI 48106-1868 FAX: 313/769-8660

Image-Compression Board

- Compresses frame-buffer images
- Can achieve compression ratios as high as 40:1

The ZR73660 image-compression and decompression board for the 16-bit ISA bus can compress an image from a frame buffer to a disk or decompress an image from a disk

to a frame buffer in approximately 3 sec. It accepts data from frame buffers that have 512x480-pixel, 24-bit Targa-24 color images. Compression ratios are as high as 40:1. The company's ZR34161 vector μ P calculates algorithms and mathematical transforms, using single instructions that operate on the en-

tire data set. The board has an 80286 μ P and occupies a single slot in the host computer. The Development Environment includes three software packages and the company's Imagineering DSP board. Board and software, \$875; Development Environment, \$4500.

Zoran, 1705 Wyatt Dr, Santa Clara, CA 95054. Phone (408) 986-1314. **Circle No. 379**

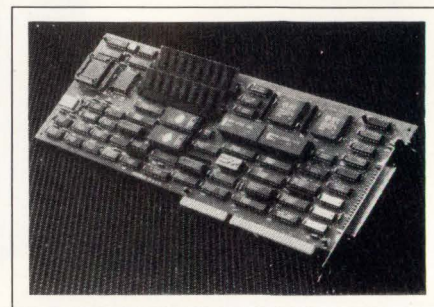

G T O POWER!

The Biggest And Fastest, With The Most Options

BEST PERFORMANCE

- Low VTM • High di/dt-dv/dt • Smallest Snubber Requirements
- Fast Switching Times-Low Losses

BROADEST LINE

- Up To 4000A- Up To 6000V

Asymmetric And Symetric Designs

High Frequency Products (up to 3 KHz)

Gate Drivers Available

NEWEST TECHNOLOGY

- Reverse Conducting Types

MOST PACKAGE OPTIONS

- Pow-R-Brik- isolated for quick easy mounting

- Pow-R-Pak- isolated for quick easy mounting

- Module-isolated for quick easy mounting

- Stud
- Disc

A continuing investment for the advanced products of tomorrow.

Call **THE POWER LINE** at 1-800-451-1415.



Joint Venture Corporation of Westinghouse, General Electric, and Mitsubishi Electric
Hillis Street, Youngwood, PA 15697
FAX 412-925-4393

Synchronous Communications Board

- Has 80376 μ P and DMA
- Two 16C30 multiprotocol chips control four serial ports

A synchronous communications board is available for the 16-bit ISA bus. It uses Intel's 80376 μ P, a member of the 80386 μ P family for embedded control. The 16-MHz μ P relieves the host of synchronous-protocol overhead and communications tasks. The μ P has use of 256k bytes of dual-ported RAM, 512k or 2M bytes of local RAM, and from 32k to 128k bytes of EPROM. An Intel 82370 chip provides DMA for the serial communications channels. Two Zilog 16C30 multiprotocol controller chips control full-duplex data transfers at 10M bps for each of the four synchronous serial ports. An X.25 software package, which allows a Unix system to operate as a LAN server, is also available. Board, \$1800; board and X.25 software, \$2495.

Star Gate Technologies Inc, 29300 Aurora Rd, Solon, OH 44139. Phone (800) 782-7428; in OH, (216) 349-1860. FAX (216) 349-2056.

Circle No. 380



The *INTEGRATED* USC. More buffer management. More system efficiency. Less cost.

Zilog's integrated universal serial communication controller (Z16C31™) combines two 32-bit full duplex DMA channels with a powerful single-channel USC cell. And that means efficient bus access, sophisticated buffer management, higher throughput, a greatly reduced CPU workload, and considerably lower cost for complex data communications applications.

Fast, multi-protocol operation.

Zilog's USC cell gives you 10 Mbps/sec speed for multi-protocol operation. It also gives you 32-byte RX and TX FIFOs for improved latency and up to 32-byte block moves. There's a Time Slot Assigner for multiplexing in ISDN/TI applications, a flexible 16-bit bus interface — multiplexed or non-multiplexed — for easy CPU interconnect, and a daisy-chain interrupt structure for simpler interrupt handling. And, best of all, the USC can reduce the CPU workload as much as 60%.

Integrated buffer management.

The IUSC's two 32-bit DMA channels provide for 32-bit addresses and 16-bit data word transfers... and they allow full duplex operation at 10 Mbps/sec. The two simple DMA modes, normal and buffered, mean your design can be tailored to common buffer management schemes. The two chained DMA modes, array chained and link array chained, reduce CPU overhead in advanced buffer management schemes. The daisy-chain DMA priority structure makes it easy to design multiple IUSC systems.

Versatility and reliability.

The IUSC's flexible, multi-protocol design lets you adapt your system to a variety of networks as interconnect standards evolve. The IUSC supports ten protocols and eight data encoding formats, including asynchronous, bit and byte synchronous, HDLC, isochronous, Ethernet and MIL-STD 1553B. And it all comes to you off the shelf, backed by Zilog's proven quality and reliability. To find out more about the IUSC or any of Zilog's growing family of Superintegration™ products, contact your local Zilog sales office or your authorized distributor today. Zilog, Inc., 210 Hacienda Ave., Campbell, CA 95008, (408) 370-8000.

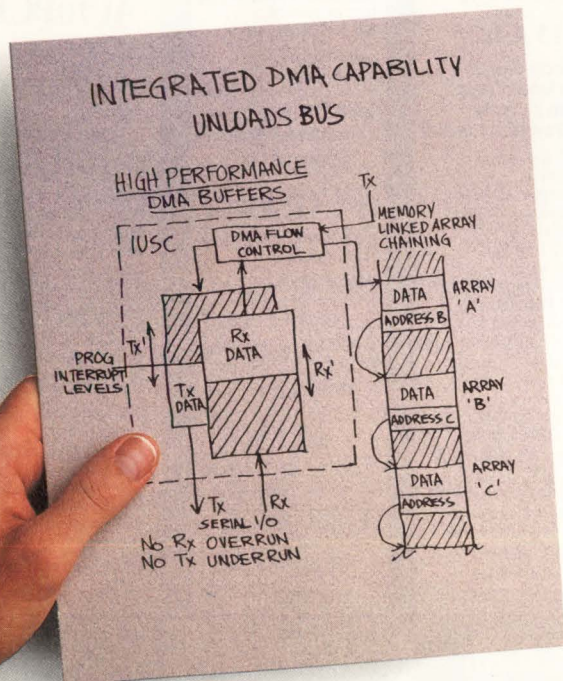

Right product. Right price. Right away.



ZILOG SALES OFFICES: CA (408) 370-8120, (714) 838-7800, (818) 707-2160, CO (303) 494-2905, FL (813) 585-2533, GA (404) 448-9370, IL (312) 517-8080, NH (603) 888-8590, MN (612) 831-7611, NJ (201) 382-5700, OH (216) 447-1480, PA (215) 653-0230, TX (214) 987-9987, WA (206) 523-3591, CANADA Toronto (416) 673-0634, UNITED KINGDOM Maidenhead (44) (628) 39200, W. GERMANY Munich (49) (89) 672045, JAPAN Tokyo (81) (3) 587-0528, HONG KONG Kowloon (852) (3) 723-8979, KOREA (82) (2) 552-5401, TAIWAN (886) (2) 741-3125, SINGAPORE 65-235 7155, DISTRIBUTORS: U.S. Anthem Electronics, Hall-Mark Electronics, JAN Devices, Inc., Schweber Electronics, Vargas Electronics, Western Microtechnology, CANADA Future Electronics, SEMAD, LATIN AMERICA Argentina — Tel. (1) 46-2211, Brazil — Digibyte (011) 581-1945, Semiconductores Profesionales (5) 536-1312.

ATTENTION!



PADS-PCB™
CADSTAR



NORTH AMERICA'S #1
"SUPERVAR"

FREE DEMO DISKS

- The CAD T.E.A.M. is a three-phase company:
- DESIGN SERVICE BUREAU
 - CAD SOFTWARE/HARDWARE DISTRIBUTION
 - CAD TRAINING CENTRE

We offer both the services/software and training you require to get the job done! Fast!

WE USE WHAT WE SELL,
AND WE SELL WHAT WE USE.

Project Management
VIEWPOINT
TELEMAGIC

CAE

CAD

CAM

Schematic
PCAD
PADS-PCB
RACAL-REDAC
AUTOSCHEMA

Simulation
P-SPICE
SUSIE
AUTOCAE

Thermal
Analysis
BETASOFT
PACIFIC
NUMERIX

Service
Bureau
PCB Layout
Photoplotting
Board Mfg.
Assembly + Test

Board Layout
PCAD
PADS-PCB
RACAL-REDAC
AUTOPCB
AUTOHYBRID

Autorouting
MAXROUTE
SUPERROUTE
RIP N ROUTE

AutoCAD
AUTOCAE
AUTOPCB
AUTOHYBRID

Photoplotter
Lavenir 1620
Lavenir 2024

Manufacturing
DATA I/O
QA3000
ACEDAMI

CIRCLE 121

CIRCLE 122

CIRCLE 123

CIRCLE 124

CIRCLE 125

CIRCLE 126

CIRCLE 127

CIRCLE 128

CIRCLE 129

**PROJECT MGMT
VIEWPOINT**

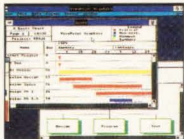

CAD Systems for Project Management

- No limits • Windows 3.0
- Mouse-operated
- **Free Demo Disks**

CIRCLE 130

TRAINING

Complete training courses from our CAD CLUB

- ViewPoint • PCAD
- AutoCAD • PADS PCB
- Simulation
- Autorouting

Call for next class

CIRCLE 131

HARDWARE

- 386/486 CAD Workstations
- Sun Workstations
- H.P. Pen Plotters
- Electrostatic Plotters
- LAN's • Printers/Mouse
- Laptop CADStations

CIRCLE 132

**SIMULATION
PSPICE**

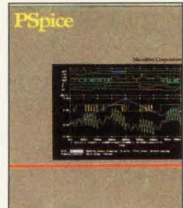

Analog and Mix Mode Simulator from \$995.00 US

- Breadboard on screen
- Save months in design
- Reduce number of revs
- Save money
- Greater product reliability

• **Free Demo Disks**

CIRCLE 133

SUSIE

The industry standard digital simulator

- From \$995 US
- Support for all PC CAE vendors schematic capture

• **Free Demo Disks**

CIRCLE 134

PADS



PADS-LOGIC

- 3rd generation schematic
- Multisheet database
- Unmatched group functions
- Interfaces to all CAD systems
- \$450 US

PADS-PCB

- World's most popular low cost ECAD system
- Completely upgradable to 2000 from \$995 US
- SuperRoute option

CIRCLE 135

PADS-2000

- 3rd generation PCB layout
- Full 32 bit system
- Virtual memory
- No limits
- On the fly design
- T-Routing
- Over 2000 IC capability
- Push n' shove
- \$6,995 US

• **Free Demo Disks**

CIRCLE 136

SERVICE



SPECIAL

FROM
99¢ A PIN

FROM
\$13 A FILM

We can design your board and return it in any CAD system format!

- SMT and analog specialists
 - Concept Engineering
 - Schematic Capture
 - Simulation
 - Board Layout
 - Autorouting
 - Photoplotting/MIVA25
 - PCB Manufacture
 - Assembly and Test
 - CAD Translations: to Mentor to PCAD to PADS-PCB to Racal Redac
- CIRCLE 137**

ASK US ABOUT THE CAD CLUB

for exclusive Savings on both services & software

CIRCLE 138

MAXROUTE

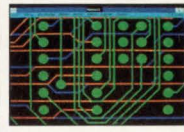

If you're using... RACAL-REDAC, P-CAD, PADS-PCB... you owe it to yourself to see the MAXROUTE Autorouting tool in action!

FREE BENCHMARKS!

- UNIX and DOS
- Push/Shove/Rip up
- Use in conjunction with your present CAD

• **Free Demo Disks**

CIRCLE 139

PCGERBER

If you work with Gerber data, you need:

PCGERBER - View and edit your Gerber files before you photoplot...\$995 US

GPLOT - PenPlot & Print Gerber files...\$595 US

CIRCLE 140

ECAM

ECAM for only \$2,995 US yet provides PCB CAM features found in products retailing between \$7,000 and \$30,000 US.

• **Free Demo Disks**

CIRCLE 141



AUTOCAE

- Schematic capture
 - Analog/Digital
 - PSpice/Susie simulation
- CIRCLE 142**

AUTOPCB

- PCB design
 - SMT support
 - Push & Shove Routing
 - Real-Time DRC
 - Bill of material
- CIRCLE 143**

AUTOHYBRID

- Hybrid circuit design
 - World's only PC solution
 - Component synthesis
 - Auto die geometry
 - Definable substrate pads
 - Automatic ink list
- **Free Demo Disks**
- CIRCLE 144**

FABMASTER

- Putting CAD data on the factory floor
- Input any CAD data
 - Output any manufacturing data
 - Board tester
 - Auto insertion
 - Drilling profile
- **Free Demo Disks**
- CIRCLE 145**

THE CAD T.E.A.M.

BOSTON • NEW YORK • TORONTO • ORLANDO • VANCOUVER • SAN FRANCISCO • L.A.

1-800-668-0726

US HEAD OFFICE: 1313 Main Street, Niagara Falls, NY 14301

LITERATURE

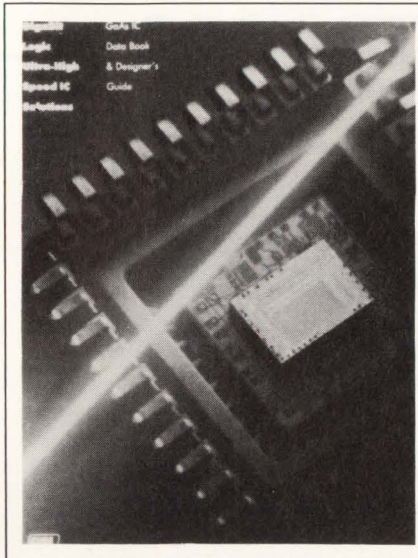

Data Book And Designer's Guide For GaAs ICs

The 1991 GaAs IC Data Book and Designer's Guide describes GaAs ICs, including the Picologic, NanoRAM, and NanoROM families, fiber-optic communications products, and standard cell arrays. The 496-pg publication highlights seven new devices, making a total offering of 46 IC products. Other featured products include chip sets for direct digital synthesis, PLL frequency synthesis, and an 800-MHz pin drive for automatic-test-equipment pin electronics applications. The Designer's Guide contains 14 application notes.

Gigabit Logic, 1908 Oak Terrace Lane, Newbury Park, CA 91320.

Circle No. 381

Real-Time Data-Acquisition Products

This 30-pg catalog describes real-time IBM PC-based instrumentation. It provides product specifications, comparisons with competitive products, and advice for buying a data-acquisition system. The publication features application notes and a guide to the Codaq product line, a PC-based waveform recorder.

Dataq Instruments Inc, 825 Sweitzer Ave, Akron, OH 44311.

Circle No. 382

Booklet Discusses Servo Analyzer

This 22-pg brochure focuses on the RF9211C FFT servo analyzer. It describes the instrument step by step and provides illustrations of sample screens. The publication mentions several added functions, including analysis of low-frequency

noise in semiconductor devices or sensors; a zoom function for high-resolution measurement in steps of 100 mHz at any frequency range; and synchronous octave analysis through DSP techniques.

Advantest America Inc, 300 Knightsbridge Pkwy, Lincolnshire, IL 60069.

Circle No. 383

Conductive Rubber SwitchPads Tooled and Prototyped....Fast!



Eliminate Overseas Delays with Conductive Rubber SwitchPads from ITT Schadow, USA

Assignment:

- Become the leading on-shore source for Conductive Rubber SwitchPads.
- Improve quality and turn-around on prototypes and production of SwitchPads.

Result:

- Faster tooling/prototypes
- Custom designs and hybrid capabilities
- Multiple actuation forces, keytop sizes and shapes
- Dual durometer rubber keytops

ITT Schadow, Inc.
8081 Wallace Road
Eden Prairie, MN 55344
Phone: (612) 934-4400

Call Today For Free Samples
(612) 934-4400

ITT Schadow
An ITT ElectroMechanical Components Worldwide Company
Discover our strengths.

Proven Unmatched Quality and Performance



STRADIVARIUS — Circa 1700

The standard by which all violins
are compared.

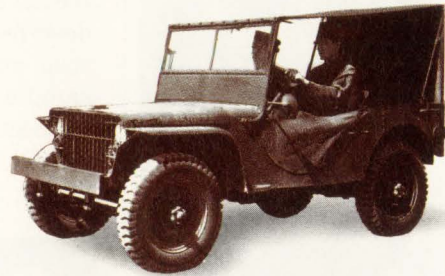

JEEP — Circa 1941

Designed to reliably carry troops
over any terrain.



1Ø & 3Ø SCR High Power DC Power Supplies — Circa 1980

And still sets the standard for quality and performance.

- 600 Watts to 10 KW
- More watts per \$ for the best price/performance value in SCR type power supplies
- 65 Standard models. 100's of custom and modified models
- Complies with VDE-875, Level N and VDE-871, Level A for line conducted RFI
- Remote Programmable via IEEE-488
- Highest Power Per Cubic Inch In Industry
- 5 Year Warranty

E/M has a well documented history of SCR technology that dates back to 1967. Today, there are over 50,000 Series TCR power supplies that have been shipped since 1980. The quality and performance is unmatched ... worldwide ... from the heat and humidity of Kuala-Lumpur to the frigid wastelands of Greenland.

For more information or literature, call
Toll Free 1-800-631-4298 or write:
Electronic Measurements, Inc.
405 Essex Road, Neptune, NJ 07753
(In NJ, HI, AL & Canada, call
201-922-9300)



**ELECTRONIC
MEASUREMENTS
INC.**



EDN PRODUCT MART

This advertising is for new and current products.

Please circle Reader Service number
for additional information from manufacturers.

LOW COST INTERFACE CARDS FOR PC/XT/AT

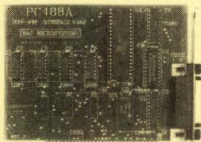

RS-485/422 Card [PC485] \$95/125

- Serial Async. Communication up to 4,000ft; 2 or 4 wires; NS16450 UART;
- COM1-4; Max. Baud Rate: 56KB; High speed version (256KB) - \$145.
- Dual drivers/receivers/Handles 64 devices/Compatible with most comm. S/W.
- DB9 or phonejack. Sample programs included.Optional S/W (w/ source) - \$150

IEEE-488 Card [PC488A] \$145

- Includes DOS Device Driver and sample Communication program in BASIC.
- Additional sample programs in C, Pascal & Assembly - \$50.
- Selectable IRQ (1-6). DMA channel 1 or 2. Up to four boards per computer.
- Compatible with most IEEE-488 Software packages for IBM-PC.
- I/O Addresses and Control registers compatible with NI's GPIB-PC/HA.

IEEE-488 Card [PC488C] With Built-In Bus Analyzer \$445

- Software Support for BASICA, QuickBASIC and GWBASIC.
- Additional libraries for C, Pascal, FORTRAN, Assembly available - \$50 (all)
- Powerful menu-driven BUS ANALYZER runs in the background while 488 programs or commands are executed; Features Program Stepping, Break points, real time bus data capture (4K buffer), instant screen toggling.
- Complete Controller / Talker / Listener capability. Based on NEC-7210.
- Compatible with NI's GPIB-PC/HA. (TMS-9914 based card - \$345).

Stepper Motor Card [PCL738] \$395

- Capable of independent and simultaneous control of up to 3 stepper motors.
- Programmable speed from 3.3 PPS to 3410 PPS; Built-in acceleration control.
- Step Position Read-back; Opto-isolated outputs; Crystal based timing.
- Pulse/Direction or CW/CCW pulse output. Includes 8 bit digital I/O port.



B&C MICROSYSTEMS INC.
750 N. Pastoria Ave., Sunnyvale, CA 94086 USA
TEL: (408)730-5511 FAX: (408)730-5521

CIRCLE NO. 325

☆☆☆☆
"The Best 8051 Emulator"

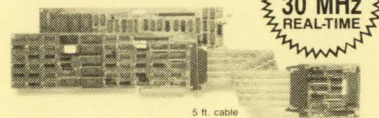

NEW
30 MHz
REAL-TIME

8051

SEE EEM 90/91
Pages D 1320-1323

PC based emulators for the 8051 family

8031, 8032, 8051, 8052, 80C152/154/321/451/452/51FA/51GB/51S/517/535/537/
552/562/652/851, 80532, 83C451/552/652/751/752/851, 8344, 87C451/552/751/
752, 8751, 8752, DS5000 + CMOS ... more.

- PC plug-in boards or RS-232 box.
- Up to 30 MHz real-time emulation.
- Full Source-level Debugger w/complete C-variable support.
- 48 bit wide, 16K deep trace, with "source line trace."
- "Bond-out" pods for 8051, 83C552, 83C451, 83C652, 83C751, 80C515/80C517, 83C752.

Prices: 32K Emulator 8031 \$1790; 4K Trace \$1495*

CALL OR WRITE FOR FREE DEMO DISK!

Ask about our demo VIDEO

NOHARU 51 E. Campbell Avenue
CORPORATION Campbell, CA 95008
(408) 866-1820 FAX (408) 378-7869

*US only

CIRCLE NO. 326

PLD Design Software

Get Started with CUPL™ for only
\$149.95

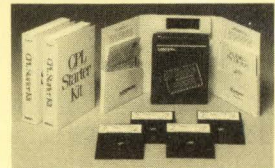

Now you can have a PLD Starter Kit that gives you all the horsepower that the CUPL PLD compiler offers, at a fraction of the cost. For more information, call 1-800-331-7766 or 305-974-0967.

**LOGICAL
DEVICES, INC.**

CIRCLE NO. 327

Elegant, concise, fast & standardized FLOATING POINT libraries for embedded applications

Based on the IEEE 754 standard, FPAC (32 bit) and DPAC (64 bit) libraries are mature, well documented, and fully tested. The libraries are fully ROMable and include the following:

- Basic Operations
- Square Root
- Trigonometric
- ASCII Conversion
- Integer Conversion
- Logarithmic

U S Software supports most Intel, Motorola, Zilog and Hitachi micros, including 80X86, 80386, 680X0, 80960, 8051, 8096, 68HC11, Z80, 6809 and 6301.

For additional information, please contact:



U S SOFTWARE
United States Software Corporation
14215 NW Science Park Drive
Portland, Oregon 97229
800-356-7097
503-641-8446
503-644-2413 (FAX)

CIRCLE NO. 328

FCC CISPR NoiseKen VDE

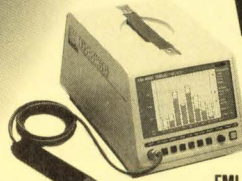

EMI NOISE SENSOR
FVC-777

FVC-777

100KHz~500KHz	30MHz~88MHz
500KHz~3MHz	88MHz~216MHz
3MHz~10MHz	216MHz~470MHz
10MHz~30MHz	470MHz~1000MHz

*Simultaneous 8 SPECTRA measurement

U.S.A. WATAHAN NOHARA INTERNATIONAL, INC.
TEL (800)366-3515

CIRCLE NO. 329

DS-51 μP DEVELOPMENT SYSTEM DB-51 μP DEVELOPMENT BOARD MP-51 μC AND EPROM PROGRAMMER

CEIBO

NEW

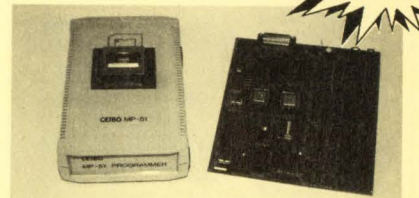

IN-CIRCUIT EMULATORS AND BOARDS

Supporting: 8031/2, 80C31/2, 80C51/2/3/8, 80C51FA, 80C51FB, 80C51FC, 80C51GB, 8044, 80C154, 80C321, 80C451, 80C521, 80C528, 80C541, 80C550, 80C552, 80C562, 80C652, 87C654, 80C751, 80C752, 80C851, 86C410 and others.

μC, EPROM AND PLD PROGRAMMERS

Programming the most popular devices: 2716 to 27512 NMOS and CMOS, 8751H, 8751BH, 87C51, 87C52, 87C51FA, 87C51FB, 87C51FC, 87C51GB, 8744, 87C75, 87451, 87550, 87C528, 87C652, 87C654, 87C751, 87C752, 87C851, 87C257, 88C257 and others.

USA:
105 GLEASON RD.
LEXINGTON MA 02173
TEL: 617-863-9927 FAX: 617-863-9849

ISRAEL:
MERKAZIM BUILDING
P.O. BOX 2106 HERZELIA 46120
TEL: 972-52-55387 FAX: 972-52-553297

CIRCLE NO. 330

To advertise in Product Mart, call Joanne Dorian, 212/463-6415

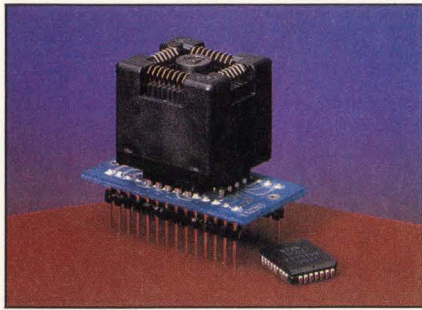

PAL/PROM Programmer Adapters

- Any EPROM programmer designed for DIPs can be converted to accept LCC, PLCC, and SOIC sockets in seconds!
- To program, just insert an Adapt-A-Socket™ between the programmer's DIP socket and the circuit to be programmed.
- Designed to fit all types of EPROM programmers, including Data I/O 120/121A, Stag, Logical Devices, etc.
- Quick turnaround on custom engineering services, if needed. For a free catalog, contact:

Emulation Technology, Inc.
2344 Walsh Ave. Santa Clara, CA 95051
Phone: 408-982-0660 FAX: 408-982-0664



CIRCLE NO. 331

PLASTIC QUAD FLATPAK

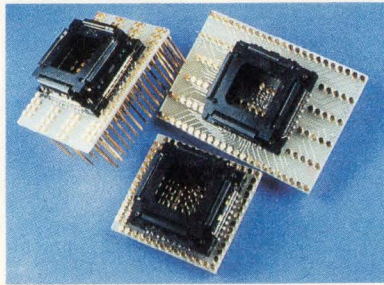

PROTOTYPING

Plastic Quad Flatpak adaptors have been added to our line of prototyping and test adaptors. The device is constructed with all gold plated pins (solder tail or wirewrap) and the highest quality plastic quad flat pack sockets. Parts included in this line handle 84 to 164 pin devices. Ask about our custom design services for unique solutions in packaging.

IRONWOOD ELECTRONICS
P.O. BOX 21151, ST. PAUL, MN 55121
(612) 431-7025

CIRCLE NO. 332

DEVICE INTERCONNECT

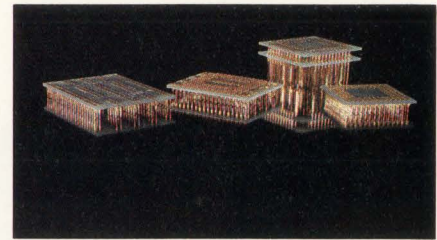

SOLUTIONS

IRONWOOD Electronics offers a comprehensive line of devices for your interconnect needs. We have hundreds of prototyping adaptors and sockets for PGA, QFP, PLCC, LCC, PGA, ZIP, and many more packages. Our line of clips for probing all different sizes of the different packages also number in the hundreds. We also do custom designs quickly and inexpensively including SMT components and tight spacing and supply the highest quality solutions. Call us for your interconnect needs.

IRONWOOD ELECTRONICS
P.O. BOX 21151, ST. PAUL, MN 55121
(612) 431-7025; FAX (612) 432-8616



CIRCLE NO. 333

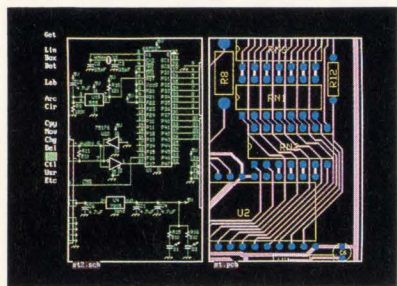

New Schematic and PCB Software

With support for extended and expanded memory, HiWIRE II can handle your most demanding schematic and PCB designs quickly and easily. The unique HiWIRE editor allows you to display and edit schematics and PCBs simultaneously, using the same commands for each. HiWIRE II is \$995, and is guaranteed.

Wintek Corporation

1801 South St., Lafayette, IN 47904
(800) 742-6809 or (317) 448-1903

CIRCLE NO. 334

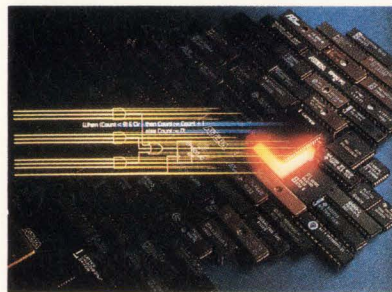

MacABEL

PLD Design on the Apple Macintosh!

Data I/O's industry-standard ABEL PLD design package is now available on the Macintosh, exclusively from Capilano Computing!
• Use Boolean and integer equations, state machines and truth tables to describe your design • Communicates directly with any serial PLD programmer • Best device support in the industry, including ALTERA, AMD, ATMEL, CYPRESS, GOULD, HARRIS, ICT, INTEL, LATTICE, NATIONAL, RICOH, SAMSUNG, SGS, SIGNETICS, SSS, TI, VTI and others • Interactive "in-circuit" schematic entry and simulation when used with DesignWorks

Call (604) 669-6343 today for your free demo kit!

Capilano Computing
FAX (604) 669-9531

CIRCLE NO. 335

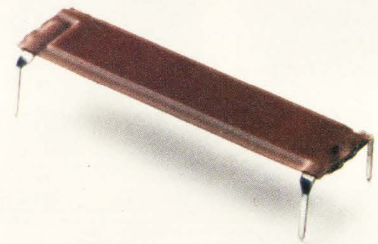

SIMPLIFY BOARD LAYOUT

MICRO/Q 1000 ceramic decoupling capacitors share board mounting holes with IC pins to simplify board design. Now add more active devices with increased density in the same space, or design the same package on a smaller board. Rogers Corp. 2400 S. Roosevelt St., Tempe, AZ 85282. 602/967-0624

CIRCLE NO. 336

Little Giant™

C Programmable Controller

This shirt pocket sized computer interfaces directly to the outside world. Use it to control anything. Instantly programmable using your PC with Dynamic C. ROM and battery backed RAM to 1024k bytes. 8 Channel, 10/12 bit, A/D with conditioning. High voltage and current drivers. Battery backed time and date clock. Watchdog and power fail. 4 serial channels. 24 parallel I/O lines. Timers. Integral power supply. Terminations for field wiring. Expansion connector. Plastic or metal field packaging available. OEM versions from \$199.00.

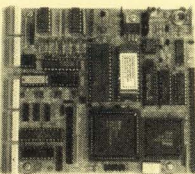

Z-World Engineering
1340 Covell Blvd., Davis, CA 95616
(916) 753-3722
Fax: (916) 753-5141

CIRCLE NO. 337

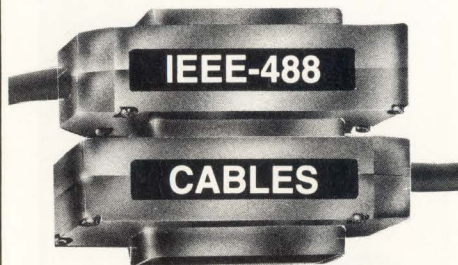

IEEE-488, (GP-IB, HP-IB) CABLES

- Reliable gold plated contacts.
- Durable metal connectors.
- High strength strain reliefs.
- Two shields for high noise immunity.
- Custom lengths at low prices.



Capital Equipment Corp.
Burlington, MA. 01803

Informative catalog 800-234-4232
Applications help (617) 273-1818

CIRCLE NO. 338

There is a Difference.

Lifetime Free Updates

EP-1140
\$895



A programmer is not just another programmer. That is why BP Microsystems is committed to bringing our customers the highest quality programmers at an affordable price. This commitment is evident in our EP-1140 E/EPROM programmer supporting thousands of 24-, 28-, 32- and 40 pin devices. A 32-pin model, EP-1132, is available also for \$695. And, all of our programmers include future chip support at no charge and an unconditional money back guarantee.

BP MICROSYSTEMS
1-800-225-2102
(713) 461-9430

CIRCLE NO. 339

To advertise in Product Mart, call Joanne Dorian, 212/463-6415

TELEBYTE



RS-232 TO CURRENT LOOP CONVERTER

MODEL 65 - OPTICALLY ISOLATED

CALL 1-800-835-3298

- ACTIVE/PASSIVE LOOPS
- 9.6 KBAUD
- 20/60 MA OPERATION
- HDX/FDX
- DTE/DCE SELECT
- SELF POWERED

\$105

TELEBYTE
TECHNOLOGY, INC.

270 E. Pulaski Rd., Greenlawn, NY
11740 • 516-423-3292/516-385-9080
1-800-835-3298 • FAX: 516-385-9184

CIRCLE NO. 340

EPROM PROGRAMMER

FOR THE PC \$139.95

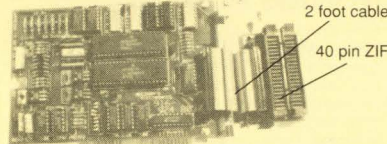

- 2716 to 4 Meg
- Programs 2764A in 10 seconds
- 16/32 bit split programming
- Menu driven software
- No personality modules required
- Adapter for 8748, 49, 51, 52, 55, TMS 7742, 27210, 57C1024, and memory cards
- 1 year warranty • 10 day money back guarantee
- Made in the U.S.A.



For more information, call (916) 924-8037
EMPDEMO.EXE available BBS (916) 972-8042

NEEDHAM'S ELECTRONICS

4539 Orange Grove Ave. • Sacramento, CA 95841
(Monday - Friday 8:00 a.m. - 5:00 p.m. PST)

CIRCLE NO. 341

EMI?

Take One - Pass FCC

Now in the USA the patented Filmac® EMI filters from Japan. Find out why they are used by most big Japanese makers to pass FCC class B.

- Low cost
- Capacitor like construction
- Distributed low pass filter
- Sales over 1 million pcs /month
- Better results than built up filters

14 piece sample kit. Call today.

800-899-7888

Zyrel, Inc.

1900 McCarthy Blvd.
Suite 201
Milpitas, CA 95035

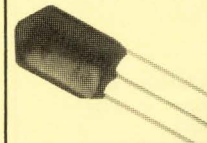

CIRCLE NO. 342

200 MHz Logic Analyzer

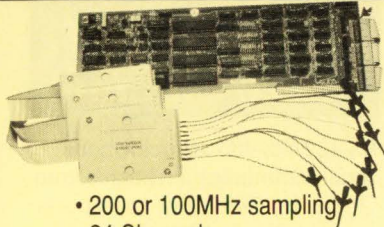

- 200 or 100MHz sampling
- 24 Channels
- Expansion to 72 channels
- 16 Levels of triggering
- 16K samples/channel
- Variable threshold levels
- 3 External Clocks
- 12 Clock Qualify lines

\$ 799-12100 (100 MHz)

\$1299-27100 (100 MHz)

\$1899-27200 (200 MHz)

UNIVERSAL PROGRAMMER

PAL
GAL
EPROM
EEPROM
PROM

87C51...
874x

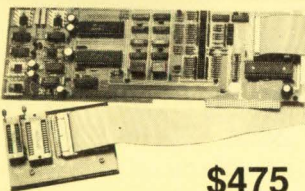

\$475

5ns PALs 4 Meg EPROMs
26V12 & 22V10 Gals
FREE software updates on BBS

GANG PROGRAMMER

- 4 32pin Sockets (8 Socket option)
- 2716-27010 EPROMs

\$215

Call - (201) 994-6669

Link Computer Graphics, Inc.

4 Sparrow Dr., Livingston, NJ 07039 FAX:994-0730

CIRCLE NO. 346

ICCON™

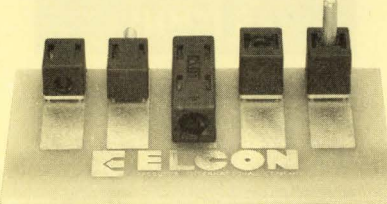

BOARD LEVEL, HIGH-CURRENT CONNECTORS

- High current, low voltage drop
- Power distribution applications
- Board-to-board configurations
- Blind mate capability
- Standard DIP footprint
- Parallel or perpendicular modules

EELCON
PRODUCTS INTERNATIONAL COMPANY

P.O. Box 1885, Fremont, CA 94538
PH: (415) 490-4200 • FAX: (415) 490-3740

CIRCLE NO. 344

UNIVERSAL PROGRAMMER

Lifetime S/W via BBS

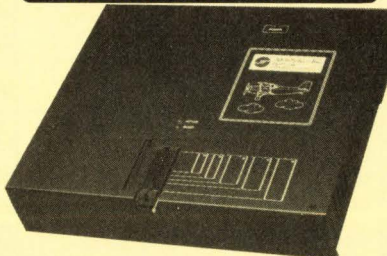

PILOT-U40 is our second generation 40-pin universal programmer, following our very successful and popular Sailor-PAL line of programmers. Programs PALs, GALs, PEELs, PROMs, E/EPROMs, micros, MACH, etc. 24-, 28- and 32-pin versions also available. Industrial quality. Starting from \$1,095. SATISFACTION GUARANTEED.

408-243-7000, 800-627-2456, Fax 408-736-2503



ADVIN SYSTEMS INC.

1050-L E. Duane Ave., Sunnyvale, CA 94086

CIRCLE NO. 347

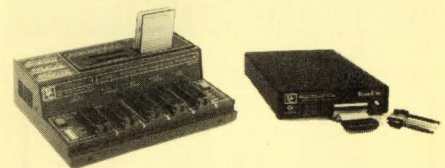

RS232 EE/EPROM, MICRO & MEMORY CARD PROGRAMMER \$345/495

- Programs EE/EProms, Flash EProms, ZPRams, Intel Micros, Memory Cards.
- Stand-Alone Mode for EE/EProms and Memory Card Duplication / Verify.
- All 24/28/32 pin EE/EProms to 8 MBits (upgradable to 32 Megabits).
- Micros: 8741A, 2/A, 4, 8, 9, 51, CS1, CS1FA/B, 52, 53, 55, CS21, CS41, 9761.
- Accepts dedicated modules: Memory Card Programming Module (Seiko, Fujitsu) - \$145, Eraser/Timer Module - \$50, Gang Module (4 sockets) - \$145. Simultaneously duplicates up to 5 devices in stand-alone mode (with Gang).
- Can be operated with any computer containing an RS-232 serial port.
- User Friendly Menu-Driven Interface Program for IBM-PC or Macintosh.
- Full 1 year warranty. Customer support via voice line, fax or dedicated BBS.

INTELLIGENT ROM EMULATOR \$395

- Emulates 2716 through 27512 EProms with a single unit. Access time 120ns.
- Connects to the standard parallel printer port via a standard printer cable.
- User friendly software. Command set includes: Load(data), Write(data), Display(memory), Type(of EProm), Edit(memory), Fill(memory), Calculator, Reset(target system), Activate(debugging feature), Monitor(selected feature).
- Address Compare with Halt output, Address Snapshot, Trigger input.
- Fast data loading via parallel printer port (64k bytes in less than 10 sec).
- Cascadable up to 8 units. Includes target cable with Trigger/Reset/Halt clips.
- CMOS (stand-alone) model with rechargeable NiCad battery backup. \$495



B&C MICROSYSTEMS INC.
750 N. Pastoria Ave, Sunnyvale, CA 94086 USA
TEL: (408) 730-5511 FAX: (408) 730-5521

CIRCLE NO. 345

Telecom Solutions from Teltone

Telecom IC Data Book

The reference for telecom design engineers. Includes:

- DTMF and call progress tone receivers and transmitters
- MF trunk receivers and transmitters
- DC signaling devices
- Key system/PBX enhancements
- Test and demonstration equipment
- Telecom signaling application notes



1-800-426-3926

Or: 206-487-1515 Fax: 206-487-2288

TELSTONE®

INNOVATING SOLUTIONS
In Telecom Interface Components

Teltone Corporation, 22121-20th Avenue SE, Bothell, WA 98021

CIRCLE NO. 348

To advertise in Product Mart, call Joanne Dorian, 212/463-6415

HAND HELD TERMINAL *\$199.

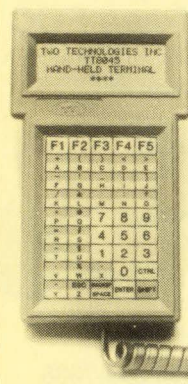

- 80 character display
- 30 or 45 keys
- RS 232 or RS 422
- Low power
- ST-32 Compatible
- Standard or custom overlay
- Single 5V or 8-12V supply
- 15 Programmable function keys
- Simple menu set-up
- 300-9600 baud
- 7 or 8 data bits
- Even, odd, mark, space
- 7 1/2" x 4" x .9"
- 8 ounces

Internal Batteries and Built in Charger — Optional

TWO TECHNOLOGIES, INC.

419 Sargon Way, Horsham, PA 19044
215-441-5305

* SINGLE PIECE OEM OR VAR PRICE

CIRCLE NO. 349

SIL-PAD THERMALLY CONDUCTIVE INSULATORS

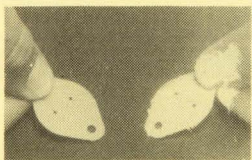

BERGQUIST Thermal Management Products include Sil-Pad thermally conductive insulators, the original silicone based insulation material. Sil-Pads are a clean, "grease-free" alternative to grease and mica. There is a complete family of Sil-Pads to meet the diverse requirements of design engineers. A complete family of Kapton® based Sil-Pads provide additional performance characteristics to meet the engineers requirements. Poly-Pad® thermally conductive insulators are designed specifically for silicone sensitive applications such as telecommunications. These insulators are constructed with polyester resins coating either side of a fiberglass carrier or a Kapton® carrier. Q-Pad® is a thermally conductive material designed for "grease-only" applications, (those requiring no isolation). For more information ask for your free copy of the new Sil-Pad Design Guide.

The Bergquist Company

5300 Edina Industrial Blvd., Minneapolis, MN 55439
Call Toll Free: 1-800-347-4572
Telephone: (612) 835-2322, Fax: (612) 835-4156

CIRCLE NO. 350

JUNCTION TEMPERATURE!

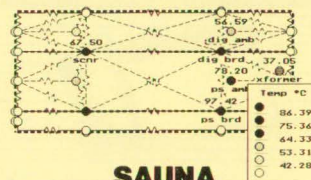

SAUNA

a better way to deal with heat

- Interactive menu-driven.
- Models: enclosures, plates, circuit boards, heat sinks.
- Analyze the whole system.
- All heat transfer modes.
- Powerful edit features.
- Thermal parameters library.
- English language design summaries.
- IBM PC & Macintosh II.

Call For Free Evaluation Kit

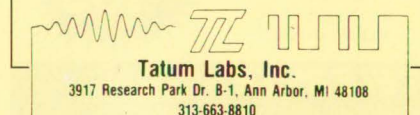

Tatum Labs, Inc.

3917 Research Park Dr. B-1, Ann Arbor, MI 48108
313-663-8810

CIRCLE NO. 751

SPICE SOFTWARE

CAE TOOLS FOR THE PC

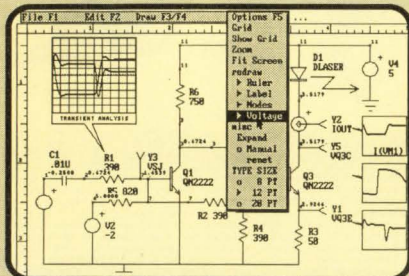

From Schematic Entry, through SPICE Simulation, to Graphical Post Processing, only \$790

- ISpICE - Full Featured SPICE Circuit Simulation
- SPICENET - Graphical Schematic Entry for SPICE
- INTUSCOPE - Waveform Display and Plotting
- PRESPICE - Model Libraries, Monte Carlo analysis
- SPICEMOD - SPICE Model generation from data sheets



P.O. Box 710 San Pedro, CA 90733-0710
Tele (213) 833-0710
FAX (213) 833-9658

CIRCLE NO. 752

Wave Form 20MHz-32K \$1290

The WSB-100 Wave Form Synthesizer Board from Quatech has the best set of numbers in the market. With speed to 20MHz and a 32K memory at \$1290, it's making waves in more ways than one. The WSB-100 is also a star performer as a digital pulse/word generator with the optional digital module.

Call for our free
PC Interface Handbook
1-800-553-1170



CIRCLE NO. 753

RS-422/RS-485 Boards for AT, Micro Channel

RS-422/RS-485 asynchronous serial communication boards from Quatech available in 1 to 4 ports for PC-AT and compatibles and 1 to 4 ports for PS/2 Micro Channel.

Call for our free
PC Interface Handbook:
1-800-553-1170



662 Wolf Ledges Parkway
Akron, OH 44311

PC-AT, Micro Channel, and PS/2 are trademarks or registered trademarks of IBM Corp.

CIRCLE NO. 754

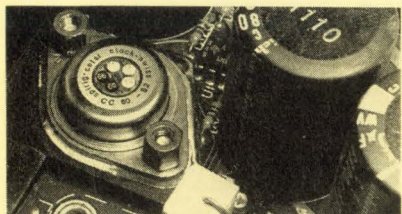

Put a low cost temperature monitor CelsiClock® on any surface.

The indicating triangle of the CelsiClock® labels turns permanently black when the surface reaches the specific »switch« temperature level of that triangle. Highly reliable labels are available as single temperature spots or in multiple sequenced temperature increments. Labels are self-adhesive and quickly placed on any dry surface. Temperature ranges from 105° F (40° C) to 550° F (260° C). FREE SAMPLE on all inquiries. CELSI's, the reliable »Temperature Watch-dog« for years.



Solder Absorbing
Technology Inc.

144 Oakland Street, Springfield MA 01108
(413)788-6191/call TOLL FREE (800)628-8862
Fax (413)788-0490

CIRCLE NO. 755



Multi-Tasking EXECS

U S Software offers hi-performance software tools for embedded applications.

Get the full details by calling:

800-356-7097
503-641-8446
503-644-2413 (FAX)



U S SOFTWARE

United States Software Corporation
14215 NW Science Park Drive
Portland, Oregon 97229

CIRCLE NO. 756

DC/CAD

CAD Showdown Results!

HIGH DENSITY EXPERTS!

Schematic Capture ♦ PCB Layout ♦ Autorouting

Top-rated DC/CAD out-routed the competition in the 1990 CAD Showdown. Routing the challenging benchmark on a double-sided board while competing routers used four to six layers, DC/CAD displayed the power and flexibility needed in a top-notch design package to tackle high density board jobs. This non-copy protected package with surface mount support includes:

- High capacity schematic capture
- Multi-strategy 1-mil parts autoplacer
- "1-mil" autorouting w/ripup & retry
- Thorough annotating design rule checker
- Full 2-way GERBER and DXF support
- Optional autoround plane support with cross-hatching
- Optional protected-mode version for 386 Users and much more!

CALL TODAY. Priced at \$495.



DESIGN
COMPUTATION

Rt. 33, Sherman Square Farmingdale, NJ 07727
(201) 338-6661 • (201) 338-6662 (FAX)

Smart Software for Tough Board Design.

CIRCLE NO. 757

To advertise in Product Mart, call Joanne Dorian, 212/463-6415

FREE & EASY

Try SCHEMA III for free, and see how easy schematic capture can be. SCHEMA III performs more functions at the drawing sheet level and is compatible with workstation formats. Call Omation for your FREE demo disk today!



1-800-553-9119

CIRCLE NO. 758

Tango-PLD. The New Price/Performance Leader.

Tango-PLD, a universal PLD design tool with sophisticated features at an affordable price, creates complex designs with multiple PALs and GALs. Our top-down approach, emphasizing logic description first and part selection second, along with a "C-like" design language, makes Tango-PLD easy to use.

Tango™

Describe designs with Boolean equations, truth tables, state machines, high-level C expressions, or existing JEDEC files. Simulation with test-vector coverage checking guarantees no surprises. Rich functionality, one year's updates, free tech support and BBS, plus our 30-day guarantee. All this for just \$495. Call today.



FREE EVALUATION PACKAGE

800 433-7801 619 554-1000 619 554-1019 Fax

Now with Schematic Entry

ACCEL™ Technologies ■ 6825 Flanders Drive ■ San Diego, CA 92121 USA International prices may vary. Contact us for the distributor nearest you

CIRCLE NO. 759

Tango-Schematic Series II.™ It simply works better.

We listened to your suggestions and built the best in PC-based schematic capture. More versatile than OrCAD.™ More features than Schemal.™ Easier to use than DASH.™ Thanks to our streamlined interface and integrated approach, Tango-Schematic makes creating complex schematics simple. Compare for yourself.

Tango™

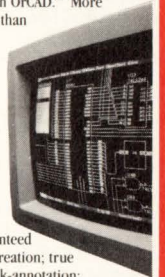

Tango-Schematic features SEDCO™ libraries, with over 8,000 parts guaranteed for accuracy; integrated component creation; true ANSI/IEEE support; forward- and back-annotation; PostScript and DXF output; free tech support; and much more. It's all there for just \$495—guaranteed.

Enhanced with New Features



FREE EVALUATION PACKAGE

800 433-7801 619 554-1000 619 554-1019 Fax

ACCEL™ Technologies ■ 6825 Flanders Drive ■ San Diego, CA 92121 USA International prices may vary. Contact us for the distributor nearest you.

CIRCLE NO. 760



NEW PRODUCT!

dV * Timing Diagram
dt Accelerator

The Digital Designer's Spreadsheet!

- Create timing diagrams in minutes
- Get effective tradeoffs on memory, wait states and logic speeds
- Analyze worst-case uncertainty
- Display available time between edges
- Create timing documentation quickly and easily

CALL Doctor Design for your FREE DEMO!

619-457-4545

5415 Oberlin Drive, San Diego, CA 92121

CIRCLE NO. 761

ROM-IT



EPROM EMULATION SYSTEM

- Emulates up to 8 1-Megabit EPROMs with one control card.
- Downloads 1-Megabit programs in less than 10 seconds.
- Allows examination and modification of individual bytes or blocks.
- Accepts Intel Hex, Motorola S-Record, and Binary files.
- Software available for IBM PC and Macintosh systems.

Call or fax today for more information!

Base 27256 EPROM System \$395.00
Other configurations available.



Incredible Technologies, Inc.
709 West Algonquin Road
Arlington Heights, Illinois 60005
(708) 437-2433 Fax (708) 437-2473

CIRCLE NO. 762

TRANSMISSION-LINE PROBLEMS?



Interactive Transmission-Line Simulator

Designing digital systems? With today's fast edges, chances are good you've got transmission-line problems.

LineSim is a new tool just for transmission-line design.

It features:

- a push-button schematic
- two PCB-impedance calculators
- models for major device families
- an oscilloscope display
- a totally interactive environment

LineSim shows you your signals when it makes the most sense: before you build boards. And it'll teach you more about how transmission lines work than a whole pile of dusty books.

30-day money-back guarantee.

\$595

Requires IBM PC with EGA.

HyperLynx

P.O. Box 3578 Redmond, WA 98073-3578 (206) 869-2320

CIRCLE NO. 763

MCP-550

Complete Data Acquisition Card

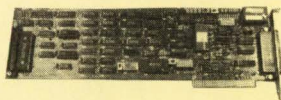

- High performance, low cost data acquisition card with multi-functions: A/D, D/A, D/I, D/O
- Maximum sampling rate of 100K samples/sec (option) or 60K samples/sec (standard)
- Industry standard 12-bit resolution
- 16 single ended or 8 differential A/D channels
- Two 12-bit monolithic multiplying D/A channels
- TTL compatible 24 D/I & D/O channels
- Switch selectable analog input range: 0-10V or +10V
- With MCE-730: a versatile 16 channel analog input multiplexing and signal conditioning card
- Complete support of vendor application S/Ws such as Labtech Notebook, ASYST...

XELTEK

764 San Aleso Ave.
Sunnyvale, CA 94086
TEL(408)745-7974
FAX(408)745-1401

CIRCLE NO. 764

UNIPRO

40-Pin Universal Device Programmer

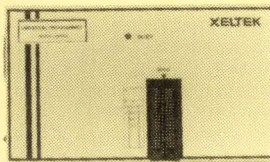

- Programs PLD, E(E)PROM (upto 4MB), Bipolar PROM & Microcontroller
- Tests TTL/CMOS logic & D/S memory
- Reliable and fast programming with Normal, Intelligent, Interactive, Quick pulse algorithms
- Accepts JEDEC, INTEL extended HEX, Motorola S, Tektronix HEX, Binary formats
- Manages 8, 16, and 32-bit word split
- Supports most compilers in JEDEC format
- S/W controlled 40-pin universal programmer
- Interfaces w/ IBM PC/XT/AT/386 or compatibles
- High speed parallel interface card to PC

XELTEK

764 San Aleso Ave.
Sunnyvale, CA 94086
TEL(408)745-7974
FAX(408)745-1401

CIRCLE NO. 765

MFI-421

Multi Functions in One Instrument



- Frequency counter * Range: 1 Hz - 100 Mhz
- Sensitivity: 1 Hz - 60 Mhz (15mV) 60 - 100 Mhz (25mV) * Accuracy: ± (1 Hz + 1 dgt + Time base error) * Display: 8 digits LED w/ units annunciator
- Function generator * Frequency: 0.02 Hz - 2 Mhz * Output waveform: Sine, Square, Tri-angle, Skewed sine, Ramp, Pulse, TTL level square * Output: 0.1 - 20 Vpp * Output Impedance: 50Ω / 600Ω
- Digital multimeter * 3.5 digit LCD display * Auto ranging (DCV, ACV, Ω, DCA, ACA) * Basic accuracy: ± (0.5% + 2 dgt)
- Power supply * Triple output, Ripple, Load regulation * Full over current protection

XELTEK

764 San Aleso Ave.
Sunnyvale, CA 94086
TEL(408)745-7974
FAX(408)745-1401

CIRCLE NO. 766

To advertise in Product Mart, call Joanne Dorian, 212/463-6415

16 MHz 80C186/C187

R.L.C.'s large selection of 8 and 16-Bit STD Bus Single Board Computers offer an Intel 80C186/188 CPU and 80C187/8087 Numeric Co-Processor at true bus speeds up to 16 MHz. On-board functions include MEMORY, SERIAL PORTS, REAL TIME CLOCK, TIMERS, DMA, INTERRUPT CONTROLLER, and BATTERY BACK-UP, WATCHDOG TIMER and much more. R.L.C. also offers 16-Bit support cards, card cages and complete software support using the award winning TURBO-DEBUGGER. For more information and technical assistance please call Robert Coomer.

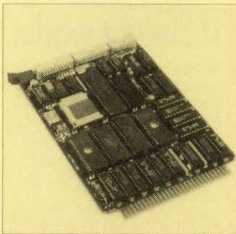

R.L.C. Enterprises
(805) 466-9717
4800 Templeton Road Atascadero, CA 93422

CIRCLE NO. 767

Half the time/ Half the cost

- Affordable 8, 16 & 32 bit emulators
- Download 250,000 bytes/second
- Built-in performance analysis
- Full speed, zero wait state operation
- C, C++ & PL/M source level support



Z80 8085
64180/Z180 64180S
8088/86 80188/186
V20/30 V40/50
647180X Z280
68000 80386

SOFAID, Inc.

1-800-433-8812
Columbia, Md.

CIRCLE NO. 768

RELIABILITY AND MAINTAINABILITY PREDICTION AND FMECA ANALYSIS SOFTWARE

Hundreds have used this leading computer-aided engineering software since 1982.

Powertronic Systems offers software to predict Reliability and Maintainability and for Failure Modes Effects and Criticality Analysis. Hundreds of users have selected from PSI's large, versatile and integrated software family for military and industrial equipment and for both electrical and mechanical systems. And, data inputs to these programs may be interactive or batch mode from other CAE or database programs.

Programs implement MIL-STD-1629; MIL-HDBK-217 including E Notice 1; and MIL-HDBK-472.



Powertronic Systems, Inc.
P.O. Box 29109 New Orleans 70189
(504) 254-0383 FAX (504) 254-0393

CIRCLE NO. 769

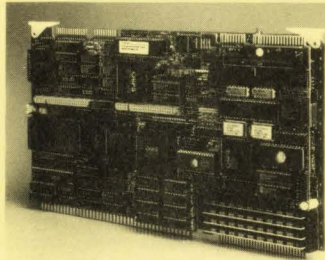

PC/AT™ COMPATIBILITY ON MULTIBUS

In 1989 our MAT286™ SBC brought PC-DOS to Multibus I. Since then no competitor has come close in terms of features, price, or technical support. We've added capabilities, such as 8 megabytes of on-board EPROM capacity, MATxSSD Solid-State Disk software, EMS 4.0, and low power CMOS components. Now we are announcing our new MATxSYSIO2 daughter-card with 16-bit VGA and LCD flat-panel interfaces, 1-1 interleaved MFM/RLI ST506 hard-disk/floppy disk controller, and a PC/AT Bus short-card adaptor. And, yes, we are working on MAT386, the 386-based Multibus AT that will be compatible with the 286-based standard, MAT286.

Phone (408) 253-0250 for more information.

Single Board Solutions, Inc.

20045 Stevens Creek Blvd, Cupertino, CA 95014
PC/AT™ IBM

CIRCLE NO. 770

Touch!



TekTouch™, our analog capacitive touch screen, has six UL certifications. Its rugged construction allows it to stand up to harsh environments and heavy-use applications, but its exceptional optics make it ideal for more delicate uses, such as medical equipment.

We've got the best touch. Send drawings of your projects for a quotation and we'll prove it.

The Graphics Technology Company, Inc.
5524 Bee Caves Road
Austin, Texas 78746
FAX: (800) 962-3860
Telephone: (512) 328-9284



CIRCLE NO. 771

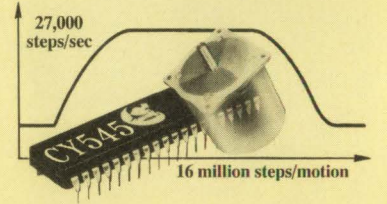

STEP MOTOR CONTROL 27K steps/sec! 16 Million steps!

New CY545. Rates up to 27K steps/sec, up to 16 million steps per single motion. Separately programmable start rate, accel/decel rate, and max rate. Pulse & direction output. External jog mode and limit switch detection. Serial or parallel interface, LED/LCD & Thumbwheel interface lines, and more. ASCII commands. Supports 64K external memory. CMOS 40-pin DIP. \$75 each (\$25/1000). Credit Cards OK.



Cybernetic Micro Systems
Box 3000, San Gregorio CA 94074
(415) 726-3000 Tlx: 910-350-5842

CIRCLE NO. 772

C for the 8051 Compare:

Benchmark Results—Sample program: Eratosthenes Sieve Program from BYTE (1/83), expanded with I/O and interrupt handling.

	FRANKLIN SOFTWARE C-51 v2.1	MCC51 v1.2	Archimedes ICC51 v2.20A
Linkage time	6 sec	9	29
Execution time	0.88 sec	9.00	11.45
Total code size	1726 bytes	3798	5318
Compilation time	17 sec	18	12
Sieve module size	541 bytes	1021	736

Call now for your free DEMO disk.



888 Saratoga Ave. #2 • San Jose, CA 95129
(408) 296-8051 • FAX (408) 296-8061

CIRCLE NO. 773

Z280-Z80-64180-8085

Advanced Relocating Macro Cross Assembler

- Includes linker, librarian, and cross-reference utility
- Generates full source-level debugging information
- Automatically bank switches program greater than 64K using MMU
- Linker allows code placement at both physical & logical addresses
- Outputs binary, Intel Hex and Extended Intel Hex files
- Compatible with M80, SLR, 2500AD, and Avocet Assemblers
- Built-in MAKE facility supports dependency file checks
- FREE demo disk available
- Compatible C-Compilers available soon!

If you're ready for a fast, full-featured, affordable product, give us a call. You'll be pleasantly surprised.

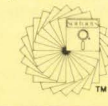

SOFTTOOLS INC.
8770 Manahan Drive
Ellicott City, MD 21043
301-750-3733
301-750-2008-Fax/BBS

ONLY \$249

CIRCLE NO. 774

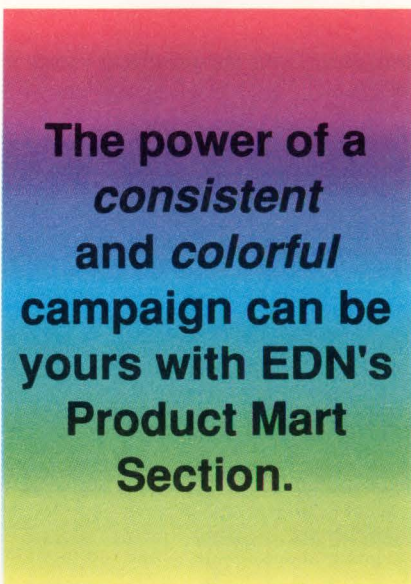

CIRCLE NO. 775

To advertise in Product Mart, call Joanne Dorian, 212/463-6415

NEPCON West '91 Puts the Design In "Design For Manufacturability"

Design...re-design...Design...re-design...To get a product to market first you can't afford to re-design twice. Your entire product development team must work together. Concurrently. To shrink market windows and keep competitors at bay, Design For Manufacturability must become a reality.

NEPCON West '91 makes Design For Manufacturability a reality. It is the largest event that brings together all aspects of electronic manufacturing. You'll see leading design companies including Mentor Graphics, Intergraph, Valid Logic, Dazix, and Data I/O—in EPCAD our special design center devoted to the newest methods in design automation software, imaging and photoplotting techniques.

Find the newest advancements in design techniques when you attend our conference program which has an

entire track devoted to CAE/CAD/CAM/CIM. Learn from industry experts including Robert Myers, the President of Omnimation, as he speaks about Open CAM Systems and the use of CAD Data in PCB Manufacturing. Discover the latest developments in concurrent engineering and Design For Manufacturability in sessions presented by Dr. Sam Shina of The University of Lowell.

NEPCON West '91 is the best, most important industry event for design solutions. It is the one event where you will find the design products that *you* need as well as the packaging, production and test products your manufacturing team needs. All in one place. All at one time.

For information on attending the show and conference or exhibiting in NEPCON West '91, please call (708) 299-9311.



Expanded to four days of exhibits, five days of conference program.

Conference: February 24-28, 1991 ■ Exposition: February 25-28, 1991
Anaheim Convention Center ■ Anaheim, California

A World Class Electronic Manufacturing Event

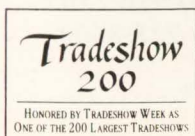

Cahners Exposition Group ■ Cahners Plaza ■ 1350 East Touhy Ave. ■ P.O. Box 5060
Des Plaines, IL 60017-5060 ■ Tel.: (708) 299-9311 ■ FAX: (708) 635-1571
U.S. Telex: 256148 CEGCGO DSP ■ Int'l Telex: 82882 CEG CHGO

©Reed Publishing (U.S.A.) Inc., 1990



Look Around.

Who's into disk drives for the long haul? One look around the industry shows you that no one's doing disk drives — or planning for long-term growth — better than Quantum.

That's because we realize that success comes easier when you're surrounded by good, dependable people. And you're linked with some of Silicon Valley's hottest companies.

The results so far? Unprecedented third quarter sales of \$231.6 million, an increase of 108% over the same period in 1990. That growth and a penchant for continuous innovation has created opportunities for you to get in on some great development work at Quantum.

Our location in the **San Francisco Bay Area** also gives you a year-round Mediterranean climate, blue skies and weather that enables you to enjoy recreational activities that range from hiking and sky-diving to skiing and surfing. Find out more about joining Quantum in one of these positions.

Disk Drive Engineers

- Servo Engineer, Dept. 618EDNM
- High-Speed Digital Design Engineer, Dept. 641EDNM
- Test Equipment Design Engineer, Dept. 633EDNM
- Software Test Engineer, Dept. 621EDNM
- Firmware Engineer, Dept. 609EDNM
- ASIC Design Engineer, Dept. 630EDNM
- Mechanical Design Engineer, Dept. 614EDNM
- Read/Write Engineer, Dept. 617EDNM
- PCB Electrical Engineer, Dept. 629EDNM

Manufacturing Engineering

- Manufacturing Engineer-Test Equipment, Dept. 633MEEDNM
- Commodity Engineering Manager, Dept. 466EDNM

Quality

- Failure Analysis Engineer, Dept. 553EDNM
- Reliability Engineer, Dept. 552EDNM
- Field Product Assurance Engineer, Dept. 558EDNM

Still up in the air?

Maybe you should know about the great benefits at Quantum. Like profit sharing and stock options. Plus friendly, supportive people and new facilities currently under construction. To find out more, send your resume, indicating the appropriate department code, to: Quantum Corporation, Human Resources, 1804 McCarthy Blvd., Milpitas, CA 95035; or fax it to (408) 922-0611. We are an equal opportunity employer. Principals only, please.

Quantum



CAREER OPPORTUNITIES

1991 Recruitment Editorial Calendar

Issue	Issue Date	Ad Deadline	Editorial Emphasis
Magazine Edition	Mar. 1	Feb. 6	Communications Special Issue, ICs & Semiconductors, CAE • Computer Peripherals • Fiber Optics
News Edition	Mar. 7	Feb. 14	Special Supplement: State of Engineering • Medical Electronics**
Magazine Edition	Mar. 14	Feb. 21	Software Tools, Computer Architectures, Materials Technology, ICs & Semiconductors/Instrumentation Circuits
Magazine Edition	Mar. 14	Feb. 21	Software Engineering Special Issue, (To be polybagged with the March 14th Magazine Edition issue)
News Edition	Mar. 21	Mar. 1	CAE, Computer Buses**, Regional Profile: Alabama, Georgia, N. Carolina**
Magazine Edition	Mar. 28	Mar. 7	ICs & Semiconductors/Microprocessors, Software • CAE • Computer Boards, Electro Preview Issue
News Edition	Apr. 4	Mar. 15	Optical Interconnects, Automotive Electronics**, Electro Show Issue
Magazine Edition	Apr. 11	Mar. 21	Power Sources, CAE/ASICs, Test & Measurement, Sensors, Electro Show Issue
News Edition	Apr. 18	Mar. 29	Distribution, Optics**, Regional Profile: No. California**
Magazine Edition	Apr. 25	Apr. 4	Computers & Peripherals Special Issue, Computers & Peripherals/Memory Design, Data Storage Technology, ICs & Semiconductors, ASICs
News Edition	May 2	Apr. 11	Automotive Electronics, ASICs**
Magazine Edition	May 9	Apr. 17	Analog Technology Special Issue, ICs & Semiconductors, Test & Measurement, CAE, Power Sources
News Edition	May 16	Apr. 26	ICs & Semiconductors, Telecommunications**, Regional Profile: Texas & Oklahoma**
Magazine Edition	May 23	May 2	ICs & Semiconductors, High Speed Memories • Computers & Peripherals, Graphics ICs, Packaging •
Magazine Edition	June 6	May 15	CAE • Software • Digital/Analog CAE • Time Analysis, ASICs
News Edition	June 13	May 23	Special Supplement: Electronic Design Automation (EDA) • CASE/CAE**
Magazine Edition	June 20	May 30	Software, ICs & Semiconductors, High Speed Memory Technology • Computer Bus Boards

Call today for information on Recruitment Advertising:

East Coast: Janet O. Penn (201) 228-8610
 West Coast: Nancy Olbers (603) 436-7565
 National: Roberta Renard (201) 228-8602

EDN Magazine Edition
 News Edition



© 1989 Honeywell Inc.

HONEYWELL: OPENING THE DOOR TO AVIONICS TECHNOLOGY OF THE 90s.

Honeywell in Phoenix offers a variety of career opportunities in our Commercial Flight Systems Group. Our continuing growth has created the following positions:

Systems Design Engineer — In this area, you will be involved in guidance and control systems analysis and hardware/software design trade-offs. Specification designs, including guidance, navigation and control algorithm development, as well as systems integration and installation, flight test and customer liaison activity, are a part of these positions.

System Software Development — This area involves development of flight software for advanced guidance and control systems for aircraft using modular and structured programming techniques. You will be involved with algorithms and development of real-time programs in both assembly (8086 family Z8002, 68000) and high order languages such as Pascal, "C," Ada and PLM/86, with subsequent hardware integration.

Electronics Engineering — These positions involve the development of new processor/bus architectures and specifications

to support fault tolerant/redundant airborne applications.

Display Systems — These positions offer systems, software and hardware opportunities with CRT/LCD display technology. You should be familiar with digital hardware design and/or real-time programming. Systems functions include overall system definition, design and customer interaction.

To qualify for the positions listed above, you should have a BSEE or a BSCS degree and at least three years of experience.

Quality Engineering — To qualify for this position, you should have a BS degree in an engineering curriculum. A minimum of two to five years of experience in quality engineering/assurance, reliability and/or product engineering is required. You should have computer applications experience. Customer interface experience is preferred.

Additional opportunities are available in:

- CRT/LCD Display Technology
- Avionics Systems Simulation

- CAE Engineering (Apollo Mentor Systems)
- Artificial Intelligence
- VAX Systems Administration
- Fiber Optic Pressure Sensors
- EMI/HERF
- Software Tools Development

Make a career move. Honeywell offers you a competitive salary and benefits package. All new employees are required to successfully complete a drug screening test. Send your resume and salary history, in confidence, to Honeywell, Commercial Flight Systems Group, Professional Employment (EDN-E845), P.O. Box 21111, M/S I-17C, Phoenix, AZ 85036.

Honeywell

HELPING YOU CONTROL
YOUR WORLD

Equal Employment Opportunity/Affirmative Action Employer
U.S. citizenship required for some positions



IOMEGA™

Makers of the Bernoulli Box

LEADING THE WAY IN ADVANCED TECHNOLOGIES

Are you looking for a company that continually moves forward with exciting and dynamic technologies? A company that will appreciate your abilities and expertise? Then take a look at IOMEGA CORPORATION. We are known as a leading developer of high-tech removable mass storage devices and innovator in the field. But we also offer a prime Utah location with its dry, mild climate and an abundance of recreational activities amidst some truly beautiful scenery. Add to that affordable housing, excellent schools and big-city conveniences combined with small-town friendliness, and you have a combination that can't be beat. We currently have the following positions available for qualified candidates:

DRIVE FIRMWARE ENGINEERS

- BSEE/BSCS/BSCE (Computer Engineering)
- MSCS preferred
- Assembly, "C" languages
- 10 years experience
- Experience in disk or tape drives
- Controller firmware
- SCSI experience preferred

SUBSYSTEM ENGINEERS

- BSME
- 3-5 years experience in electromagnetic/electromechanical devices
- Disk drive industry experience preferred

SERVO DEVELOPMENT ENGINEERS

- BSEE/ME with electrical background
- 3 years experience in the disk drive industry
- Prefer digital signal processing, adaptive servo, and feedforward servo background

PRODUCTIVITY ENGINEERS

- Advanced degree or equivalent combination of education and experience in engineering and business
- Duties include implementation and enhancement of product development, product management, and delivery processes
- Conduct special projects and studies for R&D and provide analyses and reports

In addition, we have continuous openings for qualified experienced Engineers in the field of magnetic recording for data storage.

Along with our advanced opportunities and prime location, we offer an excellent salary and benefits package. Please send resume to: **IOMEGA Corporation, Professional Staffing, Code 0065-1042, 1821 West 4000 South, Roy, UT 84067.**

Qualified female and minority candidates are specifically encouraged to apply.
Equal Opportunity Employer M/F/H/V

Knock, Knock.

In EDN's
Magazine
and News
Editions,
opportunity
knocks all
the time.

Call today for information on
Recruitment Advertising:

East Coast: Janet O. Penn (201) 228-8610
West Coast: Nancy Olbers (603) 436-7565
National: Roberta Renard (201) 228-8602

EDN Magazine
Edition
News
Edition

"WITH EDN'S MAGAZINE AND NEWS EDITIONS, WE GET THE RIGHT CANDIDATES FOR THE RIGHT PRICE."

Mike Paradis
Personnel Manager
HTS

"Meeting the staffing needs of HTS is an ongoing job. Finding qualified engineers is a high priority on our corporate agenda, and of critical importance to our technical recruiting manager who is directly responsible for evaluating technical candidates," says Mike Paradis, Personnel Manager for HTS, a leading manufacturer of television satellite components and peripherals for the consumer market. "Local recruitment advertising produced shotgun results. I'd have to plow through piles of resumes, most of which weren't position related at all."

Then in 1988, Paradis began advertising in EDN. Cost-effectiveness was his biggest concern. But not for long. "The results were gratifying. With EDN's magazine and news editions, I was finally hitting my target audience. The editorial features, like the articles on RF (Radio Frequency) engineering, were pulling the readership I wanted. By advertising in EDN, we were—and still are—getting the right candidates for the right price."

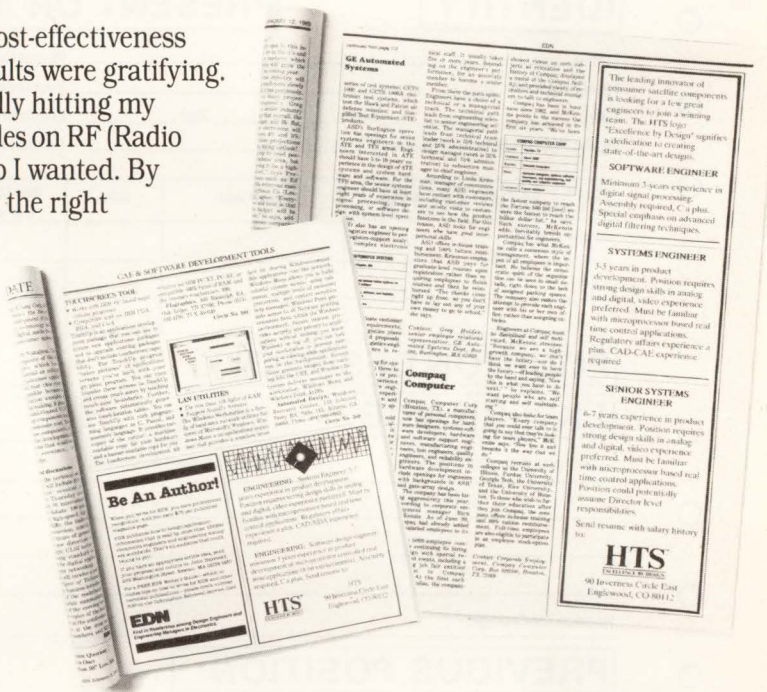
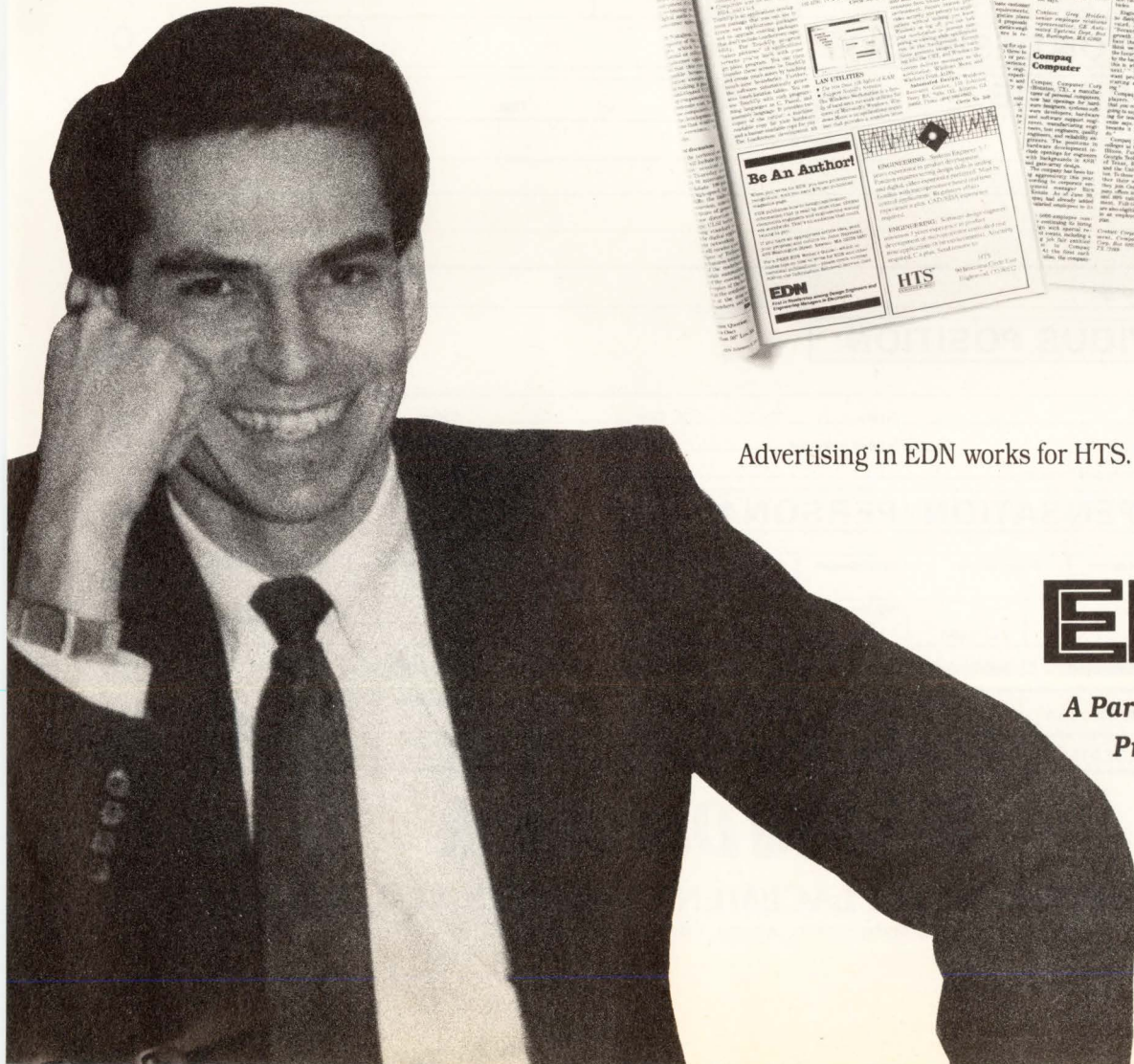

Advertising in EDN works for HTS. It can work for you.

EDN Magazine
Edition
News
Edition

A Partnership in Power and
Prestige Worldwide.

EDN Databank

Professional Profile

Announcing a new placement service for professional engineers!

To help you advance your career, Placement Services, Ltd. has formed the EDN Databank. What is the Databank? It is a computerized system of matching qualified candidates with positions that meet the applicant's professional needs and desires. What are the advantages of this new service?

- It's absolutely free. There are no fees or charges.

- The computer never forgets. When your type of job comes up, it remembers you're qualified.
- Service is nationwide. You'll be considered for openings across the U.S. by PSL and its affiliated offices.
- Your identity is protected. Your resume is carefully screened to be sure it will not be sent to your company or parent organization.

- Your background and career objectives will periodically be reviewed with you by a PSL professional placement person.

We hope you're happy in your current position. At the same time, chances are there is an ideal job you'd prefer if you knew about it.

That's why it makes sense for you to register with the EDN Databank. To do so, just mail the completed form below, along with a copy of your resume, to: Placement Services, Ltd., Inc.

IDENTITY

Name _____ Parent Company _____
 Home Address: _____ Your division or subsidiary: _____
 City _____ State: _____ Zip: _____ Location (City, State) _____
 Home Phone (include area code): _____ Business Phone if O.K. to use: _____

PRESENT OR MOST RECENT EMPLOYER

EDUCATION

Degrees (List)	Major Field	GPA	Year Degree Earned	College or University

POSITION DESIRED

EXPERIENCE

Present or Most Recent Position _____ From: _____ To: _____ Title: _____
 Duties and Accomplishments: _____ Industry of Current Employer: _____

Reason for Change: _____

PREVIOUS POSITION:

Job Title: _____
 Employer: _____ From: _____ To: _____ City: _____ State: _____
 Division: _____ Type of Industry: _____ Salary: _____
 Duties and Accomplishments: _____

COMPENSATION/PERSONAL INFORMATION

Years Experience	Base Salary	Commission	Bonus	Total Compensation	Asking Compensation	Min. Compensation
Date Available	I Will Travel <input type="checkbox"/> Light <input type="checkbox"/> Moderate <input type="checkbox"/> Heavy			I own my home. How long? _____		I rent my home/apt. <input type="checkbox"/>
<input type="checkbox"/> Employed	<input type="checkbox"/> Self-Employed	<input type="checkbox"/> Unemployed	<input type="checkbox"/> Married	<input type="checkbox"/> Single	Height _____	Weight _____
Level of Security Clearance		<input type="checkbox"/> U.S. Citizen	<input type="checkbox"/> Non-U.S. Citizen	My identity may be released to: <input type="checkbox"/> Any employer <input type="checkbox"/> All but present employer		
<input type="checkbox"/> WILL RELOCATE		<input type="checkbox"/> WILL NOT RELOCATE		<input type="checkbox"/> OTHER _____		

EDN Databank

A DIVISION OF PLACEMENT SERVICES LTD., INC.

265 S. Main Street, Akron, OH 44308 216/762-0279

WORLD CLASS ENGINEERING SOLUTIONS

That's what you'll find at Electro/International, the East Coast's only global electronics conference and exhibition for the entire engineering team with:

Over 700 exhibits of problem-solving products

38 professional/technical sessions and six tutorials organized in eight tracks: ■ Global Business ■ Computers, Software and Digital Systems ■ Medical ■ Communications ■ Manufacturing and Testing ■ IC Technology ■ Career ■ General Interest

Half-day short courses offering intensive learning opportunities

■ Keynote speech by Congressman Don Ritter ■ Purchasing conference ■ Blue ribbon panel exploring vital issues in technology, business and the profession ■ Newest developments in EDA tools in the Automated Design Center

Don't miss this outstanding educational opportunity with real bottom line returns for you and your company. Fax or write today for more information and plan now to attend.

April 16-18, 1991
Jacob Javits Convention Center
New York, N.Y.



Send me more information about Electro/International. I am interested in information about:

exhibits technical/professional sessions short courses special events

Name _____ Address _____

Title _____ City _____ State _____ Zip _____

Company _____

EDN020491

Fax: 213/641-5117 • Mail to: Electro/International Preview • 8110 Airport Blvd. • Los Angeles, CA 90045

BUSINESS/CORPORATE STAFF

Peter D Coley

VP/Publisher
Newton, MA 02158; (617) 558-4673
Ora Dunbar, Assistant/Sales Coordinator

Mark J Holdreith

Associate Publisher
Newton, MA 02158; (617) 558-4454

Deborah Virtue

Business Director
Newton, MA 02158; (617) 558-4779

BOSTON

Chris Platt, Regional Manager
Clint Baker, Regional Manager
199 Wells Ave
Newton, MA 02159; (617) 964-3730

STAMFORD 06904

George Isbell, Regional Manager
8 Stamford Forum, Box 10277
(203) 328-2580

NEW YORK/NEW JERSEY

Daniel J Rowland, Regional Manager
249 West 17th St; (212) 463-6419

PHILADELPHIA

Steve Farkas, Regional Manager
487 Devon Park Dr, Suite 206
Wayne, PA 19087; (215) 293-1212

CHICAGO

Greg Anastos, Regional Manager
Jack Johnson, Regional Manager
Hollis Gronset, Telemarketing
1350 E Touhy Ave, Box 5080
Des Plaines, IL 60018; (708) 635-8800

ARIZONA

John Huff, Regional Manager
44 Cook St, Denver, CO 80206
(303) 388-4511

COLORADO

Bill Klanke, Regional Manager
44 Cook St, Denver 80206
(303) 388-4511

DALLAS 75251

Al Schmidt, Regional Manager
12201 Merit Dr, Suite 730
(214) 419-1825

SAN JOSE 95128

Frank Granzeier, Regional Manager
Bill Klanke, Regional Manager
Philip J Branon, Regional Manager
James W Graham, Regional Manager
3031 Tisch Way, Suite 100; (408) 243-8838

LOS ANGELES

Charles J Stillman, Jr Regional Manager 12233 W Olympic Blvd Los Angeles, CA 90064 (213) 826-5818	Susan Green Regional Manager 18818 Teller Ave, Suite 170 Irvine, CA 92715 (714) 851-9422
---	--

ORANGE/SAN DIEGO/RIVERSIDE COUNTIES

Jim McErlan, Regional Manager
18818 Teller Ave, Suite 170
Irvine, CA 92715; (714) 851-9422

PORTLAND, OREGON 97221

Pat Dakin, Regional Manager
1750 Skyline Blvd, Box 6
(503) 297-4305

EUROPEAN OPERATIONS

Tully Giacomazzi, Managing Director
27 Paul St, London EC2A 4JU UK
Tel: 44-71-628-7030

UK & BENELUX

Colin Smith Oliver Smith & Partners 18 Abbeville Mews 88 Clapham Park Road London SW4 7BX	Tracey Lehane Martin Sutcliffe 27 Paul St London EC2A 4JU UK Tel: 44-71-628-7030
---	--

SCANDINAVIA

Stuart Smith
27 Paul St, London EC2A 4JU UK
Tel: 44-71-628-7030; Fax: 44-71-628-5984

FRANCE/ITALY

Laura Whiteman 14 Rue des Parisiens 92600 Asnieres sur Seine France Tel: 331-47900507 Fax: 331-47900643	G Reina srl Via Filippo Carcano, 6 20149 Milan Italy Tel: 39 2 4819 3542 Fax: 39 2 4981 283
--	---

BAVARIA/GERMANY

Karin Steinbacher New Media Munchen Ismaninger Str. 108 8000 Munchen 80 Germany Tel: 49-89-98-51-35 Fax: 49-89-981-0117	Wolfgang Richter Sudring 53 D-7240 Horb 1 A/N West Germany Tel: 49-7451-7828 Fax: 49-1-451-1794
---	--

ISRAEL

Asa Talbar, Talbar Media
Box 22917
Tel Aviv 61228, Israel
Tel: 972-3-223-621; Fax: 972-2-247-403

HONG KONG

Adonis Mak
Cahners Asia Limited
22nd fl, Lo Yung Court Commercial Bldg
212-220 Lockhart Road
Wanchai, Hong Kong
Tel: 852-572-2037; Fax: 852-838-5912

JAPAN

Kaoru Hara
Dynaco International Inc
Suite 1003, Sun-Palace Shinjuku
8-12-1 Nishishinjuku, Shinjuku-ku
Tokyo 160, Japan
Tel: 81-3-3366-8301; Fax: 81-3-3366-8302

KOREA

Jeong-guon Seo
DooBee International Inc
Centre Bldg, 1-11 Jeong-dong
Choong-ku, Seoul, Korea
Tel: 82-2-776-2096; Fax: 82-2-755-9860

SINGAPORE/MALAYSIA

Hoo Siew Sai
Ad Media Private Ltd
95, South Bridge Rd
#09-13 Pidemco Centre
Singapore 0105
Tel: 65-632-4026; Fax: 65-532-4027

AUSTRALIA

Alexandra Harris-Pearson
World Media Network Pty Ltd
Level 2, 285 Clarence Street
Sydney, NSW 2000 Australia
Tel: 61-2-283-2788; Fax: 61-2-283-2035

TAIWAN

Parson Lee
Acteam International Marketing Corp
Box 82153
Taipei, Taiwan ROC
Tel: 886-2-7114833; Fax: 886-2-7415110

PRODUCT MART

Joanne Dorian, Manager
249 West 17th St
New York, NY 10011
(212) 463-6415; Fax: (212) 242-6987

INFO CARDS

Heather McElkenny
Newton, MA 02158; (617) 558-4282

CAREER OPPORTUNITIES/CAREER NEWS

Roberta Renard, National Sales Manager
Janet O Penn, Eastern Sales Manager
Diane Phillipbar, Sales Assistant
103 Eisenhower Pkwy
Roseland, NJ 07068
(201) 228-8602, 228-8610, 228-8608
Fax: (201) 228-4622

Nancy Olbers, Western Sales Manager
238 Highland St
Portsmouth, NH 03801
(603) 436-7655; Fax: (603) 436-8647

REPRINT ORDERS

Andrea Marowitz
Cahners Plaza
1350 E Touhy Ave
PO Box 5080
Des Plaines, IL 60017-5080
Tel: (708) 390-2240

Wendy A Casella, James P Joyce
Advertising/Contracts Coordinators
(617) 964-3030

William Platt, Senior Vice President,
Reed Publishing USA

Cahners Magazine Div
Terry McDermott, President, Cahners Publishing Co
Frank Sibley, Senior Vice President/General Manager,
Boston Div
Tom Dellamaria, VP/Production & Manufacturing

Circulation: Denver, CO: (303) 388-4511
Eric Schmierer, Group Manager

Reprints of EDN articles are available on a custom printing basis at reasonable prices in quantities of 500 or more. For an exact quote, contact Andrea Marowitz, Cahners Reprint Service, Cahners Plaza, 1350 E Touhy Ave, Box 5080, Des Plaines, IL 60018. Phone (708) 635-8800.

EDN's CHARTER

EDN is written for professionals in the worldwide electronics industry who design, or manage the design of, products ranging from circuits to systems.

EDN provides accurate, detailed, and useful information about new technologies, products, design techniques, and careers.

EDN covers new and developing technologies to inform its readers of practical design matters that will be of concern to them at once or in the near future.

EDN covers new products

- that are immediately or imminently available for purchase
- that have technical data specified in enough detail to permit practical application
- for which accurate price information is available.

EDN's Magazine Edition also provides specific "how to" design information that its readers can use immediately. From time to time, EDN's technical editors undertake special "hands on" engineering projects that demonstrate EDN's commitment to readers' needs for useful design information.

EDN's News Edition also provides comprehensive analysis and news of technology, products, careers, and distribution.

EDN

275 Washington St
Newton, MA 02158
(617) 964-3030

At last, an entirely new approach to clock speed

Get five times faster throughput from NEC K-Series™ microcomputers.

As a developer of real-time control systems, you know that designing in a faster CPU is not enough. You also need intelligent I/O management for the best possible system throughput.

NEC's K-Series™ microcomputers are perfect for real-time control designs requiring multi-tasking, such as automotive control, ISDN and computer peripheral controllers.

Peripheral Management Unit™

The K-Series' unique architecture includes a revolutionary Peripheral Management Unit™ macro service for nonstop instruction execution while processing up to 16 I/O requests at the same time. By designing in the K-Series microcomputer, you can improve your system throughput by as much as 5X.

The K-Series 8-bit and 16-bit microcomputers give you a real-time output port; an advanced counter/timer system; a high-speed, high-resolution A/D converter; and many other on-chip intelligent peripherals.

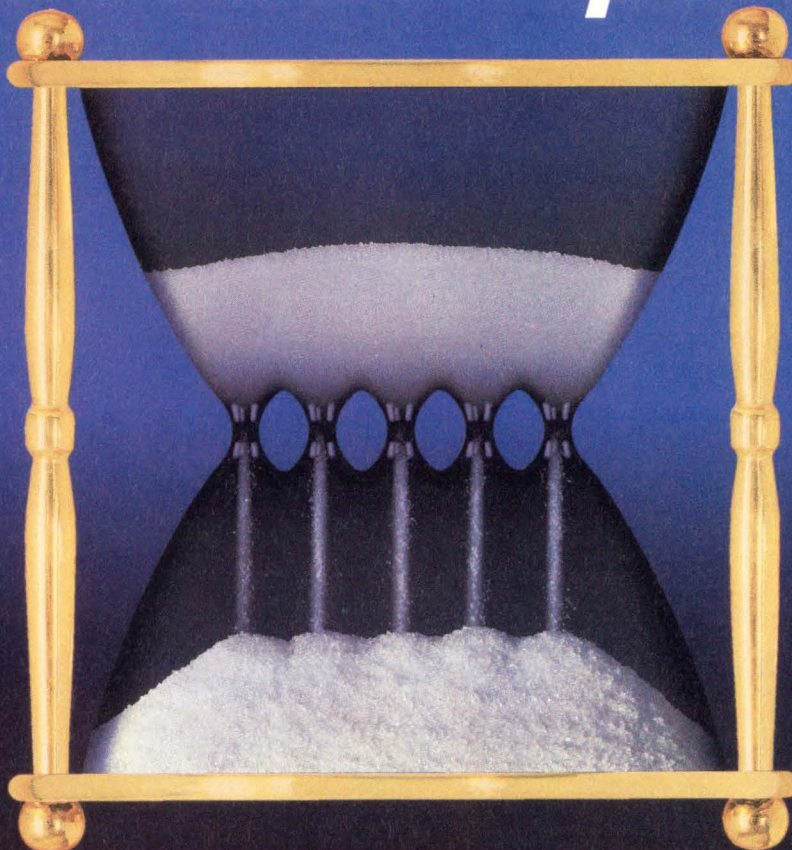

Not since the invention of the hourglass has anyone come up with a more ingenious way to speed up silicon.

The K-Series provides you a worry-free upgrade path from the 8-bit K2 microcontroller family to the 16-bit K3 devices. And your future designs will exploit the power of the lightning-fast 125-ns K6, with real-time operating system in

microcode, and complete K3 software compatibility.

To learn more about the K-Series microcomputers with up to 1K bytes of on-board RAM, 32K bytes of ROM/EPROM, and Peripheral Management Unit coprocessing power, call now.

For fast answers, call us at:

Australia Tel:03-267-6355. Telex:38343.
 France Tel:1-3067-5800. Telex:699499.
 Germany Tel:0211-650302. Telex:8589960.
 Hong Kong Tel:755-9008. Telex:54561.
 Ireland Tel:1-6794200. Telex:90847.
 Italy Tel:02-6709108. Telex:315355.
 Korea Tel:02-551-0450. Fax:02-551-0451.
 The Netherlands Tel:040-445-845. Telex:51923.
 Singapore Tel:4819881. Telex:39726.
 Spain Tel:1-419-4150. Telex:41316.
 Sweden Tel:08-753-6020. Telex:13839.
 Taiwan Tel:02-719-2377. Telex:22372.
 UK Tel:0908-691133. Telex:826791.
 USA Tel:1-800-632-3531. Fax:1-800-729-9288.

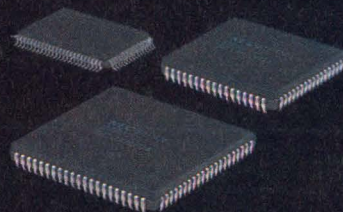
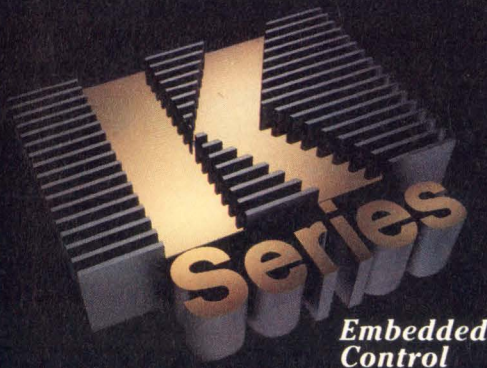

NEC

EDN's INTERNATIONAL ADVERTISERS INDEX

ACCEL Technologies Inc	145	ILC Industries Inc	53	Samtec Inc	126
Advin Systems	143	Incredible Tech	145	SAT Solder Absorbing Tech	144
American Airlines	124	Intel Corp	83	SBE	55
AMP	8-9	Intergraph Corp	42-43	Seagate Technology	24-25
Analog Devices Inc	69	Intusoft	144	Siemens Matsushita Components GmbH Munich**	20-21, 151
Atlanta Signal Processors Inc	122	IOtech Inc	54	Signetics Corp*	44-45
B&C Microsystems	141, 143	Ironwood	142	Silicon Systems Inc	60
Belden Corp	C4	ITT Schadow	139	Single Board Solutions	146
Berquist Co	100, 144	Kepeco Inc	10-11	SL Waber	100
BP Microsystems	142	KMS Advanced Products	135	Softaid Inc	146
Bruel & Kjaer Instruments**	130A	Kristel Corp	23	Softools	146
Burr-Brown Corp	C2	Leader Instruments Corp	111	Sony	48
BYTEK Corp	120	Linear Technology Corp	104	Spectrum Software	84
CAD Software Inc	46	Link Computer Graphics Inc	143	Stanford Research Systems Inc	121
Cad TEAM	138	Logical Devices Inc	141	Tatum Labs	144
Cahners Exposition Group*	102, 130A-D, 147	LSI Logic Corp	12-13	TEAC Corp**	44
Capilano Computer Systems Inc	143	MathSoft Inc	133	Tektronix Inc	136
Capital Equipment Corp	142	Maxtor	66-67	Telebyte Technology Inc	143
Carroll Touch Inc	137	Micro Linear	81	Telecom Analysis Systems	128
Ceibo Ltd*	141	MicroSim Corp	131	Teltone Corp	143
Cirris Logic	114	Mini-Circuits Laboratories	3, 4, 18-19, 26-27, 107	Toko America Inc	62
Computer Dynamics	130	Molex Inc	158	Two Technologies	144
Connor Peripherals	70-71	MWS Wire Industries	63	Universal Data Systems	C3
Cybernetic Micro Systems	146	NAS Electronics	82	US Software	141, 144
Cypress Semiconductor	17	National Design	153	Vacuumschmelze**	109
Dale Electronics Inc	1	National Instruments	79	Valid Logic Systems Ind	99
Dayton Rogers Mfg Co	130	NEC Corp	94, 156	Westcor	6
DigiKey	2	NEC Electronics	116-117	Western Graphtec	132
Digital Equipment Corp	64-65	NCR Corp	56-57	Wintek Corp	142
Dr Design	145	Needham Electronics	143	Xeltek	145
ECM	154	Nicolet Instrument Corp	118	Z-World	142
EDN Caravan	92-93	Nohau Corp	141	Zyrel Inc	143
EEsof	34	Noise Laboratory Co	141		
Elcon	143	NordicTrack	62		
Elco Corp	113	OKI Semiconductor*	20-21		
Electronic Measurements Inc	140	Omaton Inc	145		
Emulation Technology Inc	142	Orbit Semiconductor	30-31		
Franklin Software Inc	146	OrCAD Systems Corp	22		
Fujitsu Inc*	109	Orion Instruments	101		
Gates Energy Products Inc	91, 129	Oyster Terminals**	130B		
Genrad	103	Pico	112, 134		
Graphics Technology	146	Powerex Inc	136		
Hamamatsu Corp	123	Powertronic	146		
Hewlett-Packard Co	14, 28	Qua Tech Inc	144		
Hughes Microelectronics Europe Ltd**	45	Raltron	128		
HyperLynx	145	Rayovac	51		
IDT	41	Raytheon	32-33		
		RLC Enterprises	146		
		RO Associates Inc	58		
		Rogers Corp	68, 142		

Recruitment Advertising 148-152

Honeywell Commercial Flight
Systems Group
Quantum

*Advertiser in US edition

**Advertiser in International edition

This index is provided as an additional service. The publisher does not assume any liability for errors or omissions.

With our SL™ connector system, design flexibility and cost savings are yours.

Automatically.

You'll find Molex SL connectors in some of the world's leading—and most dependable—makers of electrical and electronic equipment. Of course, reliability is a big reason for this preference.

But the versatility and lower applied cost that SL provides are critical factors, too, especially in systems with several interconnections.

Modular, stackable, and lower in profile, SL connectors give you virtually unlimited flexibility when you're designing wire-to-wire, wire-to-board, and ribbon cable systems.

The single-piece IDT connectors feature, pre-assembled terminals in the housings, and interconnects with locking shrouded headers. In short, they're ideal for high-speed, high-efficiency automated assembly.

Ask your Molex representative about SL connectors, and learn how they can multiply design options and automate assembly.

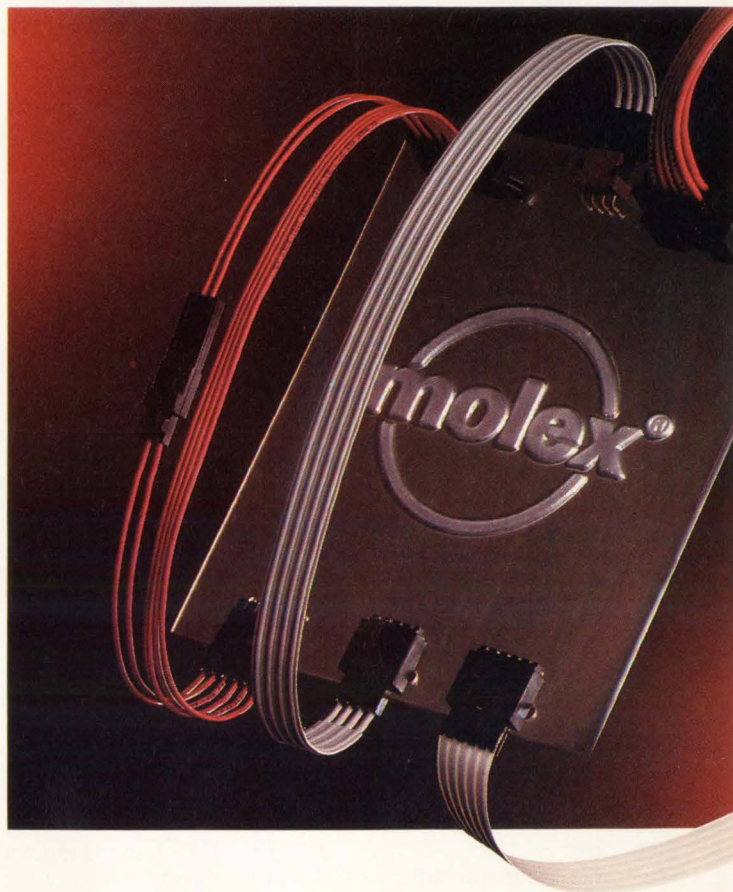

Bringing People & Technology Together, Worldwide™

Corporate Headquarters: 2222 Wellington Ct., Lisle, IL 60532 U.S.A., Tel: (708) 969-4550 • European Headquarters: Munich, West Germany, Tel: 49-89-413092-0
Far East North Headquarters: Tokyo, Japan, Tel: 81-427-21-5539 • Far East South Headquarters: Jurong Town, Singapore, Tel: 65-660-8555

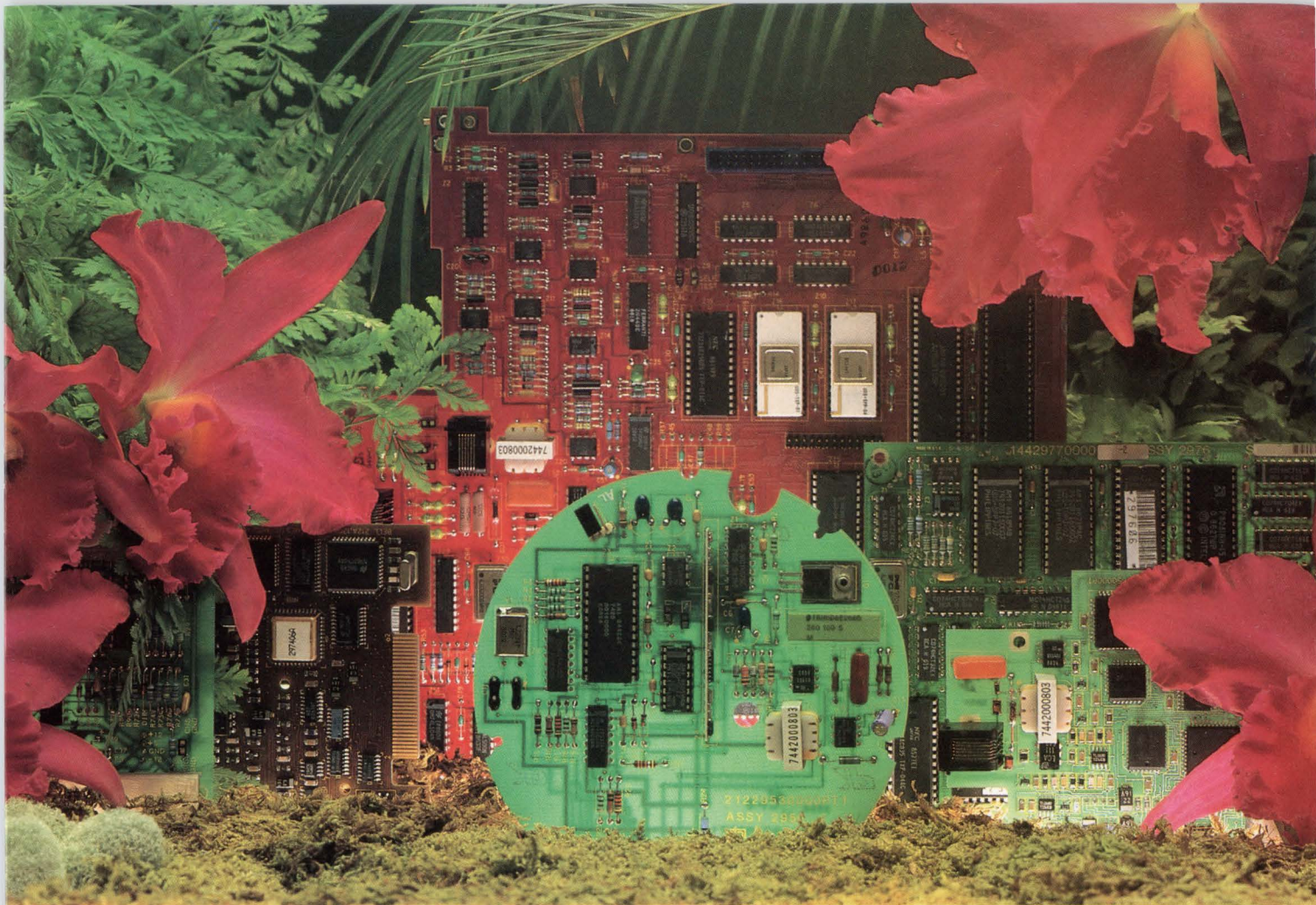

Exotic Customs at UDS

The special requirements of data communications OEMs have resulted in some pretty exotic custom modem cards from UDS.

Funny form factors are routine fare for our custom designers. Nooks, crannies and odd card configurations are no problem, given sufficient square inches of real estate. UDS engineers have even designed a complete 2400 bps modem that's the size of a credit card.

Non-standard modem functions are another specialty of the house. For example, UDS engineers have already designed and delivered a hand-held RF modem operating at 9600 bps!

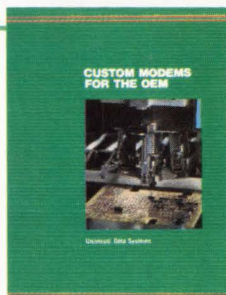

For a generous sampling of UDS' custom design capabilities, ask for the new, free OEM modem brochure.

UDS has successfully handled more than 3,000 custom OEM modem design assignments — and we can handle yours. To begin an exotic custom, contact UDS, 5000 Bradford Drive, Huntsville, AL 35805-1993. Phone 205/430-8000; FAX: 205/430-8926.

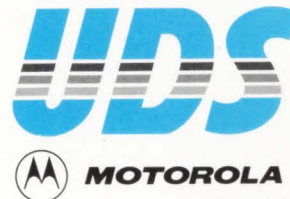

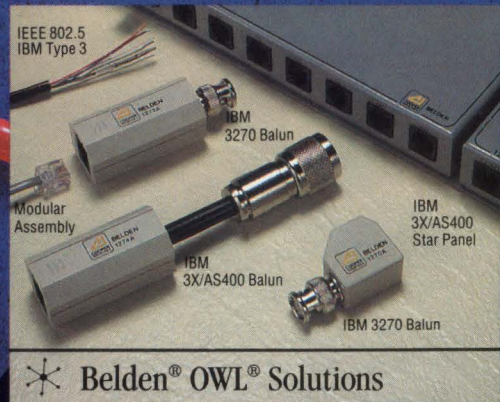
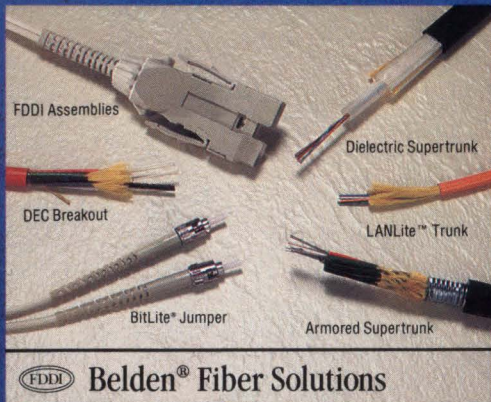

BELDEN
The Connection
For All Your
LAN Cable

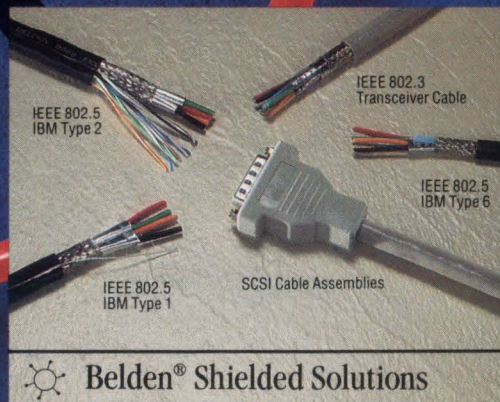

Belden Simplifies Networking

Your system is only as good as its connection. Belden helps you make the right connection to ensure system uptime, comply with regulations for premise wiring and prepare your company for its future network plans. That's no small task. It takes a resourceful company like Belden to keep abreast of system developments, help drive industry network standards and manufacture reliable cable solutions to meet a myriad of requirements. Belden helps you protect your system investment.

Belden—The Source You Can Trust
Because Belden offers the most extensive and unique cable solutions,

you can rely on us for an unbiased recommendation of the right cable for the job. No one matches Belden's selection of unshielded twisted pair (UTP) and OWL™ accessories, shielded twisted pair (STP) and coaxial cables, fiber optic cables and assemblies. Whether your need is for Ethernet⁺ or Token Ring, shielded or unshielded, metallic or fiber, Belden has a reliable cable for every application. New Flamarrest™ cables present even more options as low cost plenum alternatives meeting NEC* requirements.

How To Get The Help You Need
A simple call to Belden today will provide you a personal copy of

Belden's LAN Catalog and refer you to:

- A Belden Network Specialist for cabling consultation, or
- The Belden Distributor nearest you to supply your cable needs, or
- The Authorized Belden Systems



Integrator nearest you for system design, hardware, cabling, installation or maintenance services.

1-800-BELDEN-4

Belden Wire and Cable, P.O. Box 1980, Richmond, IN 47375

*Trademark of National Fire Protection Association, Quincy, MA.

*Xerox trademark
Copyright © 1990 Cooper Industries, Inc.



BELDEN