

EDN[®]

Part 4 of EDN's
Decade 90 Series

Dynamic testing of ADCs

Tools for IEEE-488
program generation

Electro/88 preview

ELECTRONIC TECHNOLOGY FOR ENGINEERS AND ENGINEERING MANAGERS

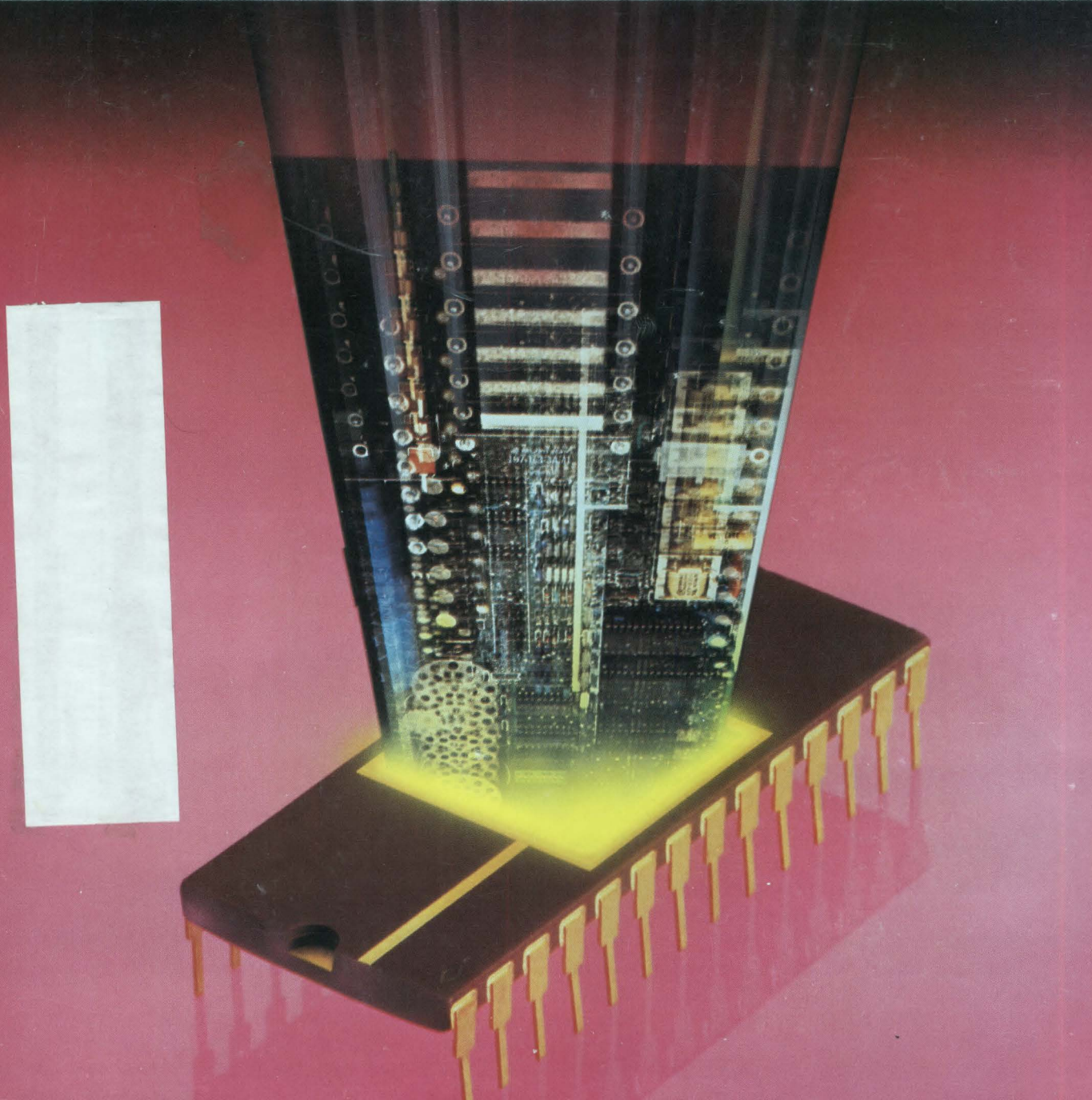

Single-IC modems perform
as full-size boards

FEATURES

- 12-Bit Resolution and Accuracy
- Fast Conversion Time
 - AD7672XX03 - 3 μ s
 - AD7672XX05 - 5 μ s
 - AD7672XX10 - 10 μ s
- Unipolar or Bipolar Input Ranges
- Low Power: 110mW
- Fast Bus Access Times: 90ns
- Small, 0.3", 24-Pin Package

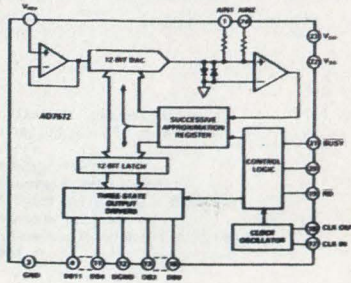

AD7672 Functional Block Diagram

PRODUCT DESCRIPTION

The AD7672 is a high-speed 12-bit ADC, fabricated in an advanced, mixed technology, Linear-Compatible CMOS (LC²MOS) process, which combines precision bipolar components with low-power, high-speed CMOS logic. The AD7672 uses an accurate high-speed DAC and comparator in an otherwise conventional successive-approximation loop to achieve conversion times as low as 3 μ s while dissipating only 110mW of power.

To allow maximum flexibility, the AD7672 is designed for use with an external reference voltage. This allows the user to choose a reference whose performance suits the application, or to drive many AD7672s from a single system reference, since the reference input of the AD7672 is buffered and draws little current. For digital signal processing applications, where absolute accuracy and temperature coefficients may be unimportant a low-cost reference can be used. For maximum precision, the AD7672 can be used with a high-accuracy reference such as the AD588.

The on-chip clock-circuit may be used with a crystal for accurate definition of conversion time. Alternatively the clock input may be driven from an external source such as a microprocessor clock.

PRODUCT HIGHLIGHTS

1. Fast, 3 μ s, 5 μ s and 10 μ s conversion speeds make the AD7672 ideal for a wide range of applications in telecommunications, sonar and radar signal processing or any high-speed data acquisition system.
2. LC²MOS circuitry gives high precision with low power drain (110mW typ)
3. Choice of 0 to +5V, 0 to +10V or \pm 5V input ranges, accomplished by pin-strapping.
4. Fast, simple, digital interface has a bus access time of 90ns allowing easy connection to most microprocessors.
5. Available in space-saving 24-pin, 0.3" DIP or surface mount package.

**AT 5 μ S, WE SET
THE 12-BIT A/D RECORD. THIS PAGE
TELLS HOW WE BROKE IT.**



When we introduced our AD7572, it set the monolithic 12-bit A/D conversion speed record at 5 μ s.

Now, our AD7672 establishes a new record with an even faster conversion time of only 3 μ s.

This blazing speed is reached with only 110mW of power dissipation because the AD7672, like the AD7572, is manufactured on an advanced merged bipolar/CMOS process.

The 90ns bus access time of the AD7672 affords easy interfacing with most microprocessors, while the +5V and -12V nominal power supply voltages allow its use in PC and modem designs. All this is available in a narrow 0.3" DIP or a surface mount package.

The AD7672 also features unipolar or bipolar analog inputs that are selected by pin-strapping. This lets you avoid external circuitry for input range changing.

The 3 μ s version of the AD7672 is available for as little as \$63.75; the 5 μ s version, from \$37.40; and the 10 μ s model, from \$28.05 (1000s).

For more information on how the AD7672 can speed up your designs, call Applications Engineering at (617) 935-5565, Ext. 2628 or 2629. Or write to Analog Devices, P. O. Box 9106, Norwood, MA 02062-9106.

Less is More.

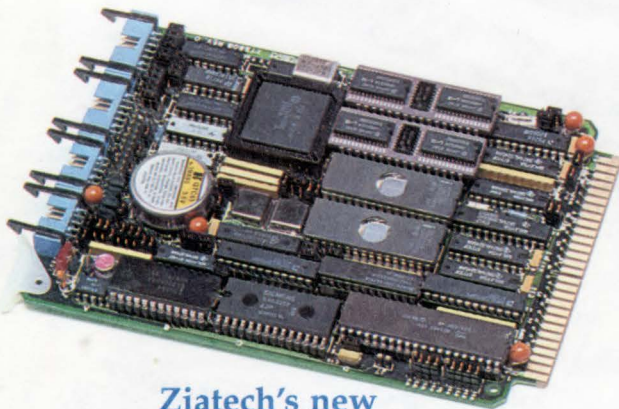

Ziatech's new
STD Bus ZT 8809
Single Board System
for OEM applications.



Another manufacturer's
"function-per-board"
STD Bus card set
with equivalent capability.

- **PERFORMANCE** (NEC V20 at 8 MHz clock speed)
- **ON-BOARD MEMORY** (520K)
- **IBM PC HARDWARE COMPATIBILITY**
- **ON-BOARD I/O** (2 serial: COM1, COM2; 1 Centronics: LPT1)
- **DEVELOPMENT CAPABILITY** (industry acclaimed Virtual System Console)
- **OPERATING SYSTEM OPTIONS** (STD DOS, VRTX, Multi-DOS, and more)
- **COMPACTNESS** (one board implementation)
- **RELIABILITY** (fewer connectors, components, boards)
- **VALUE** (Ziatech's single board system is \$675 less than the 5-board set pictured above*)

To learn **more** about how **less** (Ziatech's new single board system) is **more** (when compared to the 5-board set pictured above), call Ziatech at 805-541-0488. We'll send you a detailed comparison and all the technical data you'll need.



3433 Roberto Court
San Luis Obispo, California 93401
ITT Telex 4992316
Fax (805) 541-5088
Telephone (805) 541-0488



* Prices are according to manufacturers' literature as of 1/88.

WHO'S THE REAL PERFORMER IN HIGH-PERFORMANCE LINEAR?

FOR THE BEST IN LSP, LOOK TO VTC.

The facts speak for themselves: VTC is eminently qualified to be your supplier of high-performance linear ICs.

Our linear signal processing (LSP) line can deliver all the performance your most demanding linear applications require. It's an entire family of solutions you can design-in with confidence, whether your commercial or military high-performance linear system involves:

- High-speed video
- High-speed/high-res data acquisition
- Scientific or medical instrumentation
- Or many other applications

All our LSP products feature $\pm 5V$ operation to help simplify your system power requirements, and reduce power consumption. All parts are available in commercial or military temp ranges.

We offer a choice of industry-standard packages. Including a full line in surface-mount (SOIC) packages . . . even quad op amps.

The LSP line includes *Op Amps* to 500MHz bandwidth . . . precision, high-speed, and fast settling, plus dual or quad . . . with no sacrifice in performance. *A/D Converters* to 12 bits, 1 usec conversion. *Flash Converters* to 8 bits, 250MHz. *DACs* to 12 bits, 100 nsec settling time. A family of ECL and TTL *High-Speed Comparators* to 1.5GHz. *Video Amps* and *Unity Gain Amps* to 2000V/usec, 500MHz. And *Operational Transconductance Amplifiers* to 50V/usec, 75MHz.

So, put us to the test. See how VTC's LSP devices can perform for you.

Call or write today for our short-form product catalog, and our LSP application note on how to design with $\pm 5V$ linear.

VTC Incorporated, 2401 East 86th Street, Bloomington, MN 55425. (In Minnesota, call 612-851-5200.) Telex 857113. Fax 612-851-5199.

Call 1-800-VTC-VLSI today!

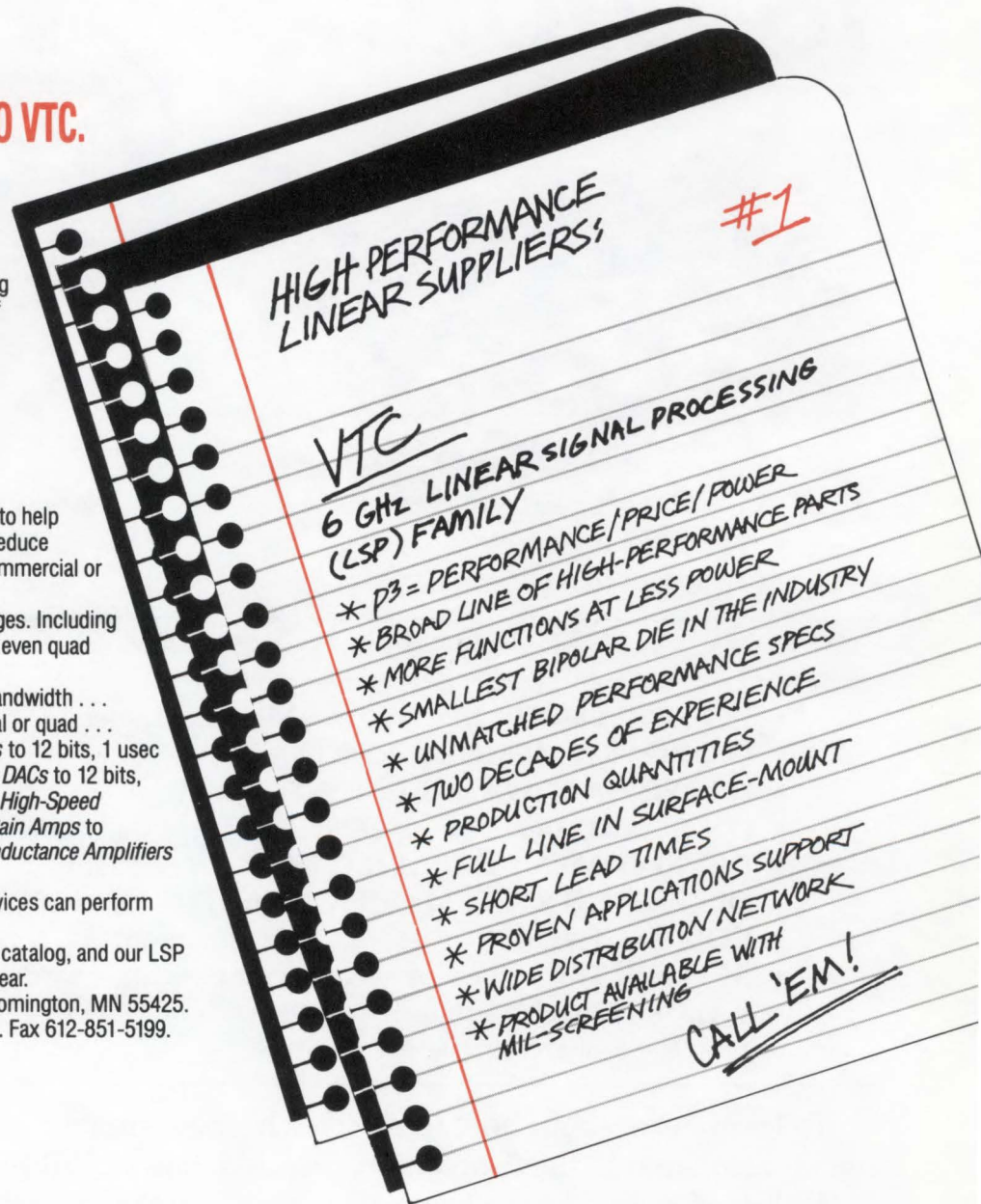

VTC Incorporated
Performance, Pure & Simple.™

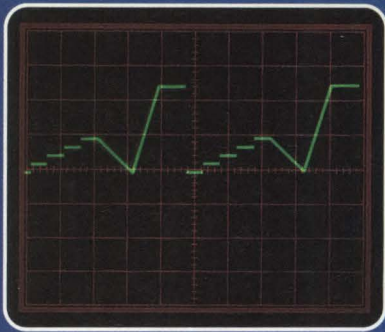

Vibration analysis with stop and hold.

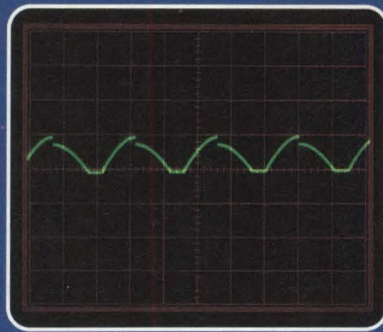

Complex waveforms for servo drives.

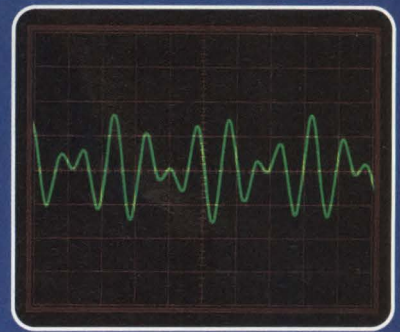

Dual tones for telephone testing.

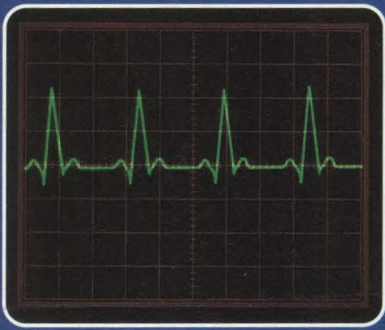

EKG and hemodynamic waveforms.

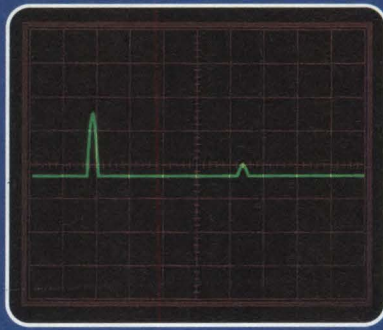

Radar/sonar envelope simulation.

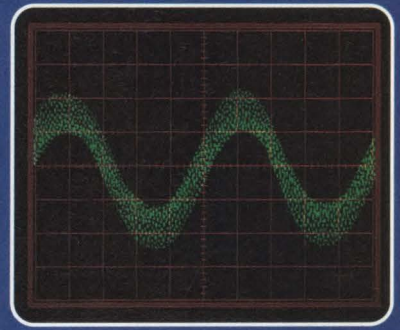

Noise added to any waveform.

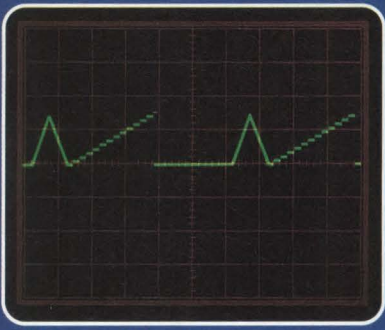

A/D, amplifier development and calibration.

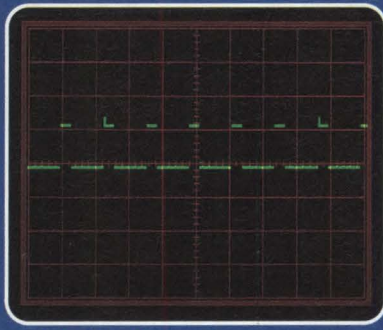

Digital testing and troubleshooting.

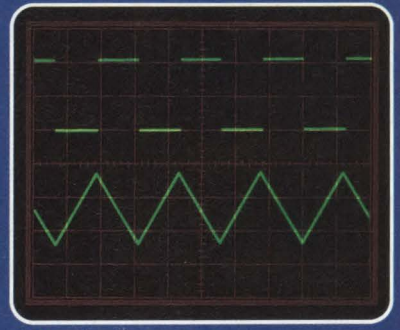

Standard waves at the push of a button.

We've been making waves for 25 years. Now it's your turn.

A quarter-century ago, Wavetek brought you the first waveforms produced by a solid-state function generator. Now our Model 75 Arbitrary Waveform/Function Generator puts you in control.

Model 75 lets you generate waveforms without entering x/y coordinates. Thumbtack and rubberband modes allow easy development and editing of any waveform. There are also nine standard functions which you can use at the push of a button.

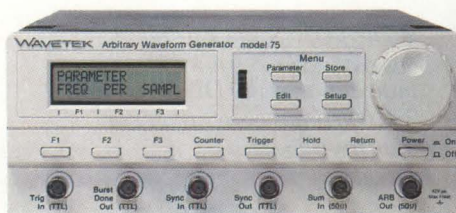

Waveforms are stored in nonvolatile memory, with more than 4,000 vertical points and 8,000 horizontal points of resolution. They can be played back at any rate, up to 500ns per point.

By linking two or more Model 75's together, you can superimpose waveforms to introduce phase displacement or other special effects. And at the low price of \$2295, you might want to buy several.

For literature or to arrange an amazing demonstration, call or write Wavetek San Diego, Inc., P.O. Box 85265, San Diego, CA 92138. Phone (619) 279-2200; TWX (910) 335-2007.



330,000 X Performance Booster

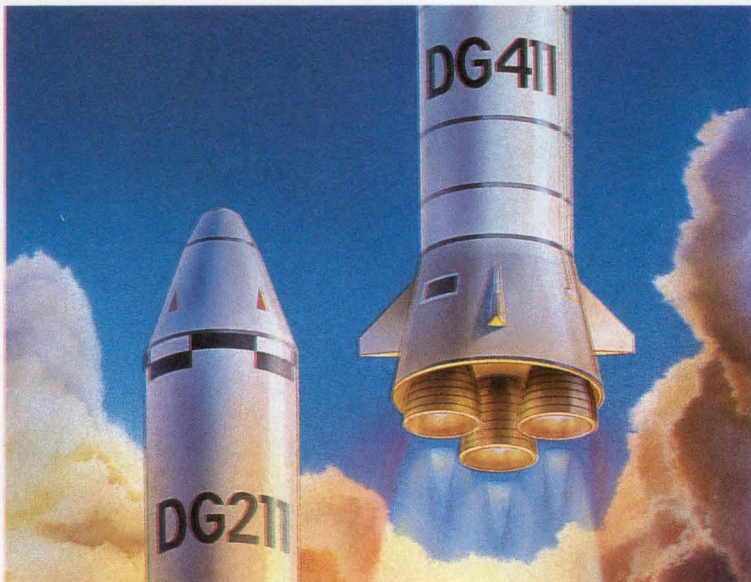

Switch to the next generation with Siliconix' new silicon-gate DG400 family of analog switches.

Boost performance with lower ON-resistance, less leakage current and faster switching!

The next generation DG411/12/13 series of CMOS quad analog switches combine high performance, precision and low power. Previous technologies have forced the trade-offs of speed for low power, or ON-resistance for leakage. But the DG400 family lets you maximize all these parameters.

Next generation performance is only the beginning. Siliconix' new 44 V silicon-gate CMOS technology is more rugged! 2500 V (min.) ESP (Electro Static Discharge Protection) meets category B of MIL-STD 883B, method 3015.2 for your toughest reliability needs.

Quad Analog Switch
Performance Comparison

DG211		DG411
1000 ns	Switching Speed	175 ns
20.4 mW	Power Dissipation	35 μ W
5 nA	Leakage	250 pA
175 Ω	On Resistance	35 Ω
1	Normalized Performance Product	330,000

The DG411 family is optimized for minimum charge injection and for TTL-compatibility: Either unipolar 12 V supply or split supply operation.

◀ *The performance product, $r_{DS(ON)} \times I_{S(ON)} \times t_{ON} \times PD$, indicates that the DG411 is 330,000 times better than the industry standard DG211.*

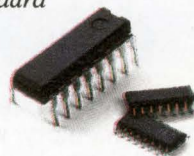

Get a 330,000 X performance boost! Call Siliconix at 1 (800) 554-5565 ext. 933 for a free DG411 sample and Design Kit.

Siliconix
incorporated

2201 Laurelwood Road, Santa Clara, CA 95054

© 1988 Siliconix

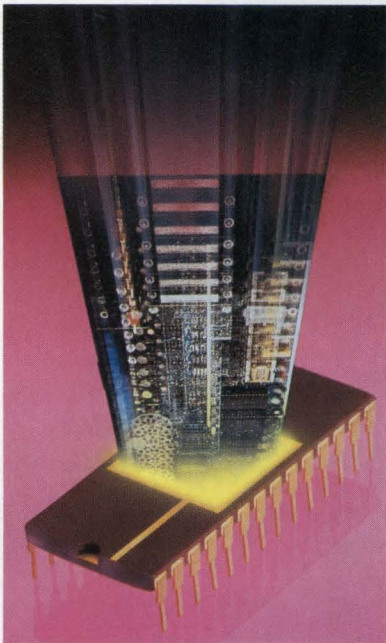

On the cover: Single-IC modems are eliminating board-level modems that transmit at 1200 bps or less. And by adding a single-IC modem to your embedded application, you can have a virtual front-end processor for communicating over the public switched-telephone network or via a communication satellite link. See pg 118. (Photo courtesy Silicon Systems Inc)

SPECIAL ISSUE: COMMUNICATIONS TECHNOLOGY DESIGN FEATURES

Special Report: Single-IC modems 118

Integrating all the functions of a modem on a single IC has made it feasible to implement a virtual front-end processor for the PSTN.

—John Gallant, Associate Editor

Decade 90: The future of system design—Part 4 140

The ubiquitous DIP and board-and-backplane technologies have dominated electronic packaging for the last 25 years. However, the growing sophistication of devices and systems signals the decline of such packaging schemes.—Steven H Leibson, Regional Editor

High-resolution LCD panels change demands on driver electronics 157

Today's LCD technology places new requirements on driver electronics.—Carl Fenger and Kurt Muhlemann, Philips/Faselec

Spice extensions dynamically model thermal properties 169

By performing dynamic thermal analysis with an extension of Spice, the venerable electrical-circuit modeling tool, you can avoid temperature-related problems.—Eric Filseth, Analog Design Tools, and Mike Jachowski, Precision Monolithics Inc

Equivalent circuits model subtle traits of advanced CMOS ICs 189

Subtle characteristics of an advanced CMOS logic IC's transistors, packaging, bypass capacitor, and load combine to affect the output waveshape. Some of the subtleties are inherent in the IC, but some are under your control.—Charles Dike, Signetics Corp

Dynamic testing describes behavior of high-frequency ADCs 215

Using improved dynamic-testing methods, you can accurately characterize the performance of an A/D converter that is operating near its theoretical limits.—Eric D Blom, Sipex Corp

Continued on page 7



V BPA ABP



EDN® (ISSN 0012-7515) is published 38 times a year (biweekly with 1 additional issue a month) by Cahners Publishing Company, A Division of Reed Publishing USA, 275 Washington Street, Newton, MA 02158-1630. Terrence M McDermott, President; Frank Sibley, Electronics/Computer Group Vice President; Jerry D Neth, Vice President/Publishing Operations; J J Walsh, Financial Vice President/Magazine Division; Thomas J Dellamaria, Vice President/Production and Manufacturing. Circulation records are maintained at Cahners Publishing Company, 44 Cook Street, Denver, CO 80206-5191. Telephone: (303) 388-4511. Second-class postage paid at Denver, CO 80206-5191 and additional mailing offices. POSTMASTER: Send address corrections to EDN® at the Denver address. EDN® copyright 1988 by Reed Publishing USA; Saul Goldweitz, Chairman; Ronald G Segel, President and Chief Executive Officer; Robert L Krakoff, Executive Vice President; William M Platt, Senior Vice President. Annual subscription rates for nonqualified people: USA, \$100/year; Canada/Mexico, \$115/year; Europe air mail, \$135/year; all other nations, \$135/year for surface mail and \$210/year for air mail. Except for special issues where price changes are indicated, single copies of regular issues are available for \$6, \$8, and \$10 (USA, Canada/Mexico, and foreign). Please address all subscription mail to Eric Schmierer, 44 Cook Street, Denver, CO 80206-5191.



PHILIPS

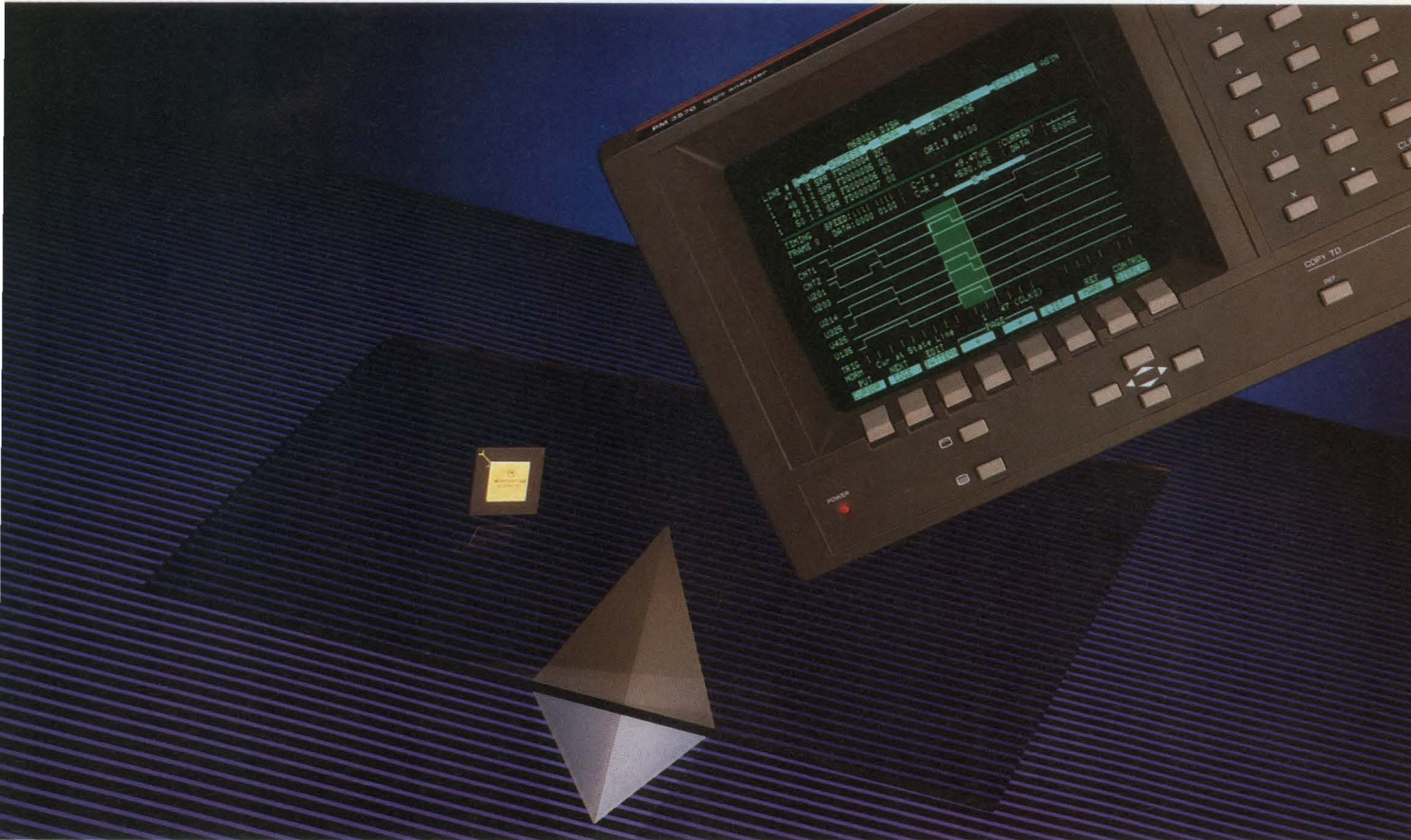

Introducing perfect 32-bit balance

The Philips PM 3570 Logic Analyzer. A no-compromise solution for true 32-bit systems integration. At a price that won't weigh you down.

HEAVYWEIGHT PERFORMANCE

- **32-bit channel width:** No other logic analyzer in its class offers 83 state plus 32 transitional timing channels for simultaneous, time-correlated display of software flow and high-speed hardware signals.
- **Unmatched acquisition speed:** Up to 400 MHz with 2.5 ns resolution for data capture four times faster than similarly-priced instruments.
- **Transitional Timing:** A Philips' innovation, this feature provides the equivalent of 132 GBytes of conventional RAM.
- **Plus broad support:** Get dedicated personality modules for quick connection to most 8-, 16- and 32-bit micros.

EASY MEASUREMENTS

- **Softkey simplicity:** Eight menu-driven softkeys give you direct access to over 300 different functions.
- **Labeled timing channels:** Lets you identify each channel with your own code names.
- **Time-tagged events:** Logs time between events for stored signals in synchronous and asynchronous acquisition modes.
- **Non-volatile memory:** Stores four complete user settings, measurement data and your last set-up—even at power-down.

UPSCALE SUPPORT

Count on a one-year warranty and all the application and service assistance you'll ever need. From Fluke—the people who believe that extraordinary technology deserves extraordinary support.

WEIGH THE DIFFERENCE

Call Fluke today at **800-44-FLUKE ext.77**. And discover how easy it is to achieve perfect 32-bit balance.

John Fluke Mfg. Co., Inc., P.O. Box C9090, M/S 250C, Everett, WA. 98206
 U.S.: 206-356-5400 CANADA: 416-890-7600
 OTHER COUNTRIES: 206-356-5500

© Copyright 1987 John Fluke Mfg. Co., Inc. All rights reserved. Ad No. 1171-P3570



PM 3570 • LOGIC ANALYZER



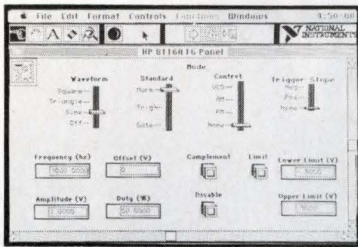

You can now obtain PC-based CASE tools that speed up the process of developing software for IEEE-488 systems (pg 71).

TECHNOLOGY UPDATE

Program-generation tools for PCs ease IEEE-488 system integration 71

The IEEE-488 bus (or GPIB) provides a quick, convenient method of connecting instruments as an ATE system, but generating the software to control these instruments has always been a time-consuming task.—*Peter Harold, European Editor*

Largest-ever Electro adds software to its showcase of electronics technology 87

The theme for the Electro/88 conference, scheduled for May 10 through 12 at Boston's Bayside Exposition Center and World Trade Center, centers on the technology bridge between hardware and software.—*Tarlton Fleming, Associate Editor*

PRODUCT UPDATE

Tiny telecommunications module 97
DSP in-circuit emulator 98

DESIGN IDEAS

Signal-powered switch connects devices 227
XOR gate doubles counting frequency 228
Time-slotting scheme speeds loop execution 228
Algorithm determines highest-priority task 233
XOR gates generate complementary signals 234

Continued on page 9

EDN magazine now offers Express Request, a convenient way to retrieve product information by phone. See the Reader Service Card in the front for details on how to use this free service.



Cahners Publishing Company, A Division of Reed Publishing USA Specialized Business Magazines for Building & Construction Manufacturing Foodservice & Lodging Electronics & Computers Interior Design Printing Publishing Industrial Research & Technology Health Care and Entertainment. Specialized Consumer Magazines: American Baby and Modern Bride.

A STRIKING NEW COMBINATION OF SPEED, RESOLUTION, ACCURACY AND RECORD LENGTH!

200 MS/s., 10-bit resolution, +.4% gain accuracy, and 64K record length: the best balance in high-resolution digitizers is clearly the new RTD 710 from Tektronix.

The RTD 710 lets you work with fast transients, from DC to 100 MHz, in standalone, semi-automated or fully automated test and measurement environments.

You can partition its 64K memory to store signals of different lengths. Acquire data simultaneously on two different channels. Switch sampling speeds up to five times in a single acquisition.

Add a TV triggering option for video applications. And choose from a variety of computer-based measurement packages.

Call 1-800-835-9433 for more information or to arrange a personal demonstration.

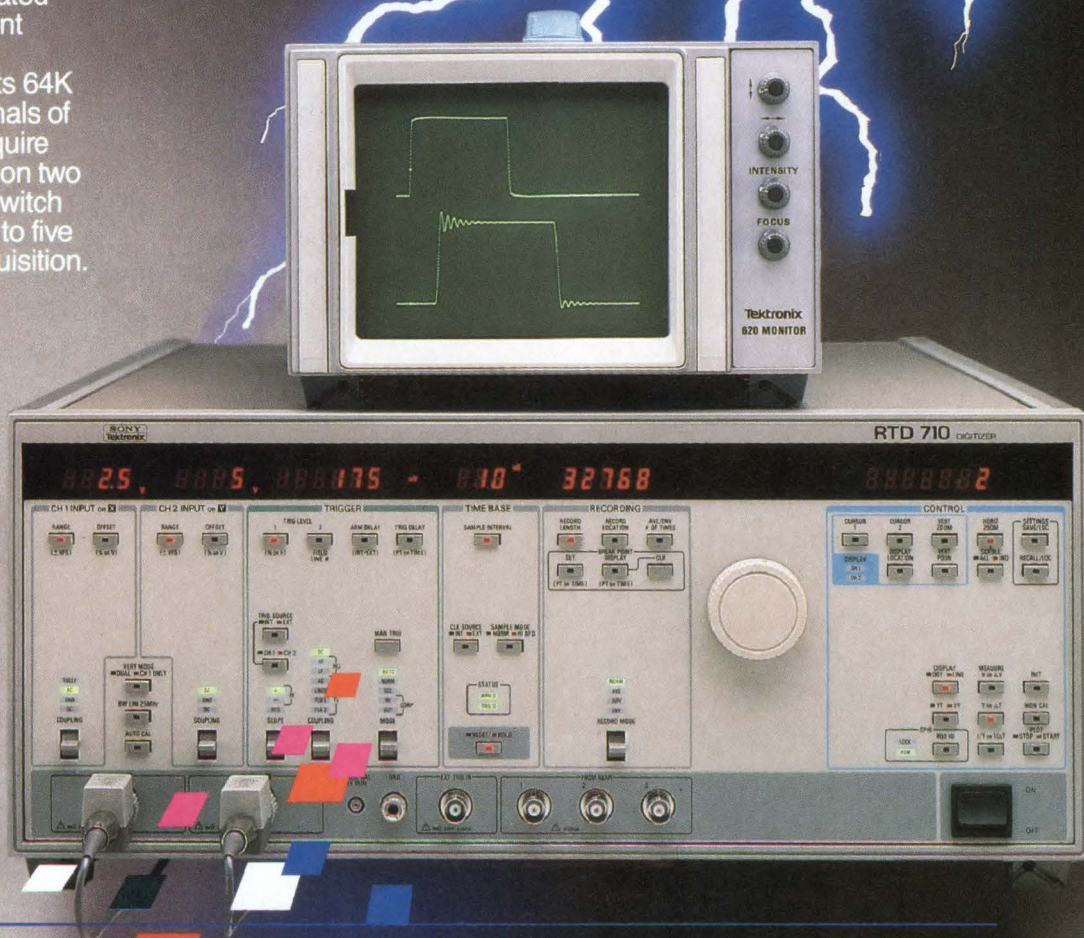

Tektronix
COMMITTED TO EXCELLENCE

VP/Publisher
F Warren Dickson

VP/Associate Publisher/Editorial Director
Roy Forsberg

Editor
Jonathan Titus

Managing Editor
John S Haystead

Assistant Managing Editor
Joan Morrow

Special Projects
Gary Legg

Home Office Editorial Staff
275 Washington St, Newton, MA 02158
(617) 964-3030

Tom Ormond, *Senior Editor*
Deborah Asbrand, *Associate Editor*
Joanne Clay, *Associate Editor*
Tarlton Fleming, *Associate Editor*
John A Gallant, *Associate Editor*
Clare Mansfield, *Associate Editor*
Dave Pryce, *Associate Editor*
Cynthia B Rettig, *Associate Editor*
Charles Small, *Associate Editor*
Dan Strassberg, *Associate Editor*
Chris Terry, *Associate Editor*
Ron Gilbert, *Staff Editor*
Valerie Lauzon, *Staff Editor*
Helen McElwee, *Staff Editor*
Steven Paul, *Senior Production Editor*

Editorial Field Offices

Margery S Conner, *Regional Editor*
Los Osos, CA: (805) 528-0833

Doug Conner, *Regional Editor*
Los Osos, CA: (805) 528-0865

Bob Cushman, *Special Features Editor*
Port Washington, NY: (516) 944-6524

Steven H Leibson, *Regional Editor*
Boulder, CO: (303) 494-2233

J D Mosley, *Regional Editor*
Arlington, TX: (817) 465-4961

Richard A Quinell, *Regional Editor*
San Jose, CA: (408) 296-0868

David Shear, *Regional Editor*
San Jose, CA: (408) 997-5452

Maury Wright, *Regional Editor*
San Diego, CA: (619) 748-6785

Peter Harold, *European Editor*
0603-630782
(St Francis House, Queens Rd,
Norwich, Norfolk NR1 3PN, UK)

Contributing Editors
Robert Pease, Bob Peterson,
Don Powers, Bill Travis

Editorial Services
Kathy Leonard, *Office Manager*
Loretta Curcio, Nancy Weiland,
Sharon Gildea

Art Staff
Kathleen Ruhl, *Art Director*
Ken Racicot, *Assistant Art Director*
Chin-Soo Chung, *Graphic Designer*
Cathy Filipski, *Graphic Designer*

Production/Manufacturing Staff
William Tomaselli, *Production Supervisor*
Donna Pono, *Production Manager*
Andrew A Jantz, *Production Assistant*
Linda Lepordo, *Production Assistant*
Diane Malone, *Composition*

Graphics Director
Norman Graf

VP/Production/Manufacturing
Wayne Hulitzky

Director of Production/Manufacturing
John R Sanders

Director of Research
Deborah Virtue

Marketing Communications
Janice Molinari, *Manager*
Jennifer Ware, *Communications Manager*
Anne Foley, *Promotion Assistant*

EDITORIAL

65

As markets mature, buyers and sellers must become more like partners. Partnerships can also strengthen the workplace.

NEW PRODUCTS

Integrated Circuits	243
Components & Power Supplies	263
Computers & Peripherals	280
CAE & Software Development Tools	296
Test & Measurement Instruments	308

PROFESSIONAL ISSUES

339

Coaching turns engineers into public-speaking pros.—*Deborah Asbrand, Associate Editor*

LOOKING AHEAD

355

IC sales should achieve 12% CAGR from 1983 to 1992.

DEPARTMENTS

News Breaks	21
News Breaks International	24
Signals & Noise	32
Calendar	52
Readers' Choice	104
Leadtime Index	110
Literature	328
Business/Corporate Staff	336
Career Opportunities	346
Advertisers Index	354

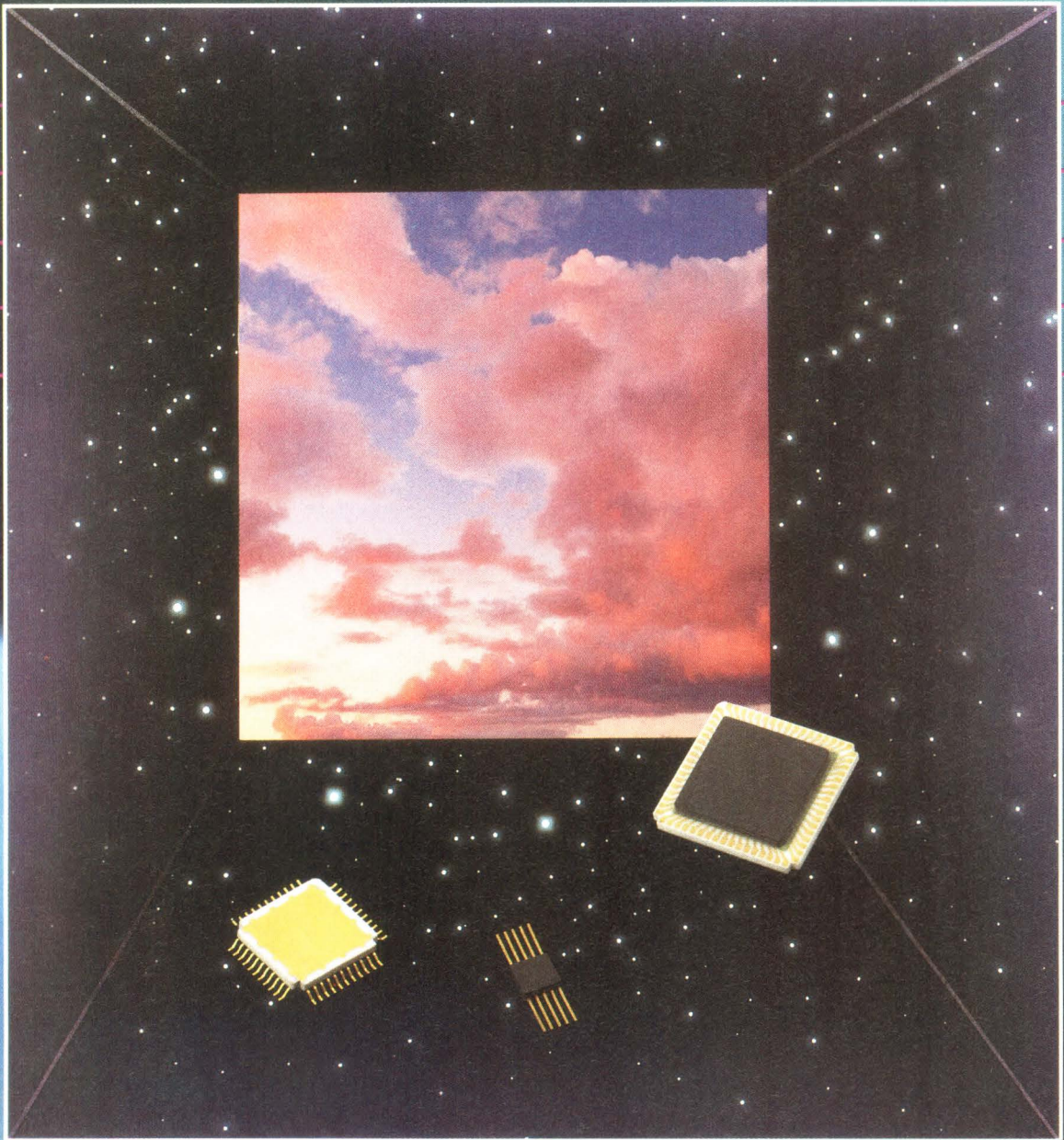

Touchstone is a trademark of EEsol, Inc. Interleaf is a trademark of Interleaf, Inc.
Copyright © 1988, Tektronix, Inc. All rights reserved. CAE-802M

Microwave IC Creation. Now Integrated. Automated. And Only From Tek.

Suddenly, microwave IC design is light-years ahead of manual, piecemeal, error-prone techniques.

The new Tektronix MMIC WorkSystem brings to microwave engineers a completely integrated design system featuring foundry-endorsed microwave component libraries. Automatic back-annotation. Interactive layout. And a streamlined documentation system.

It's the first end-to-end CAE solution, from concept to physical implementation, for MMIC designs.

You may never need to look at a netlist again. All that manual coding and typing... all that painstaking

revision after component optimization—you can put them behind you. Now creating a microwave circuit is simple as selecting components. Specifying their values. And connecting them.

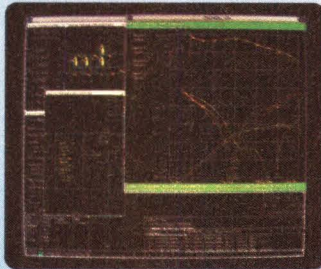

Multi-window, multi-tasking feature lets you view graphical simulation data and the automatically back-annotated schematic simultaneously. You get instant feedback of optimization routines.

The Tek EEsol Touchstone™ simulation interface module automatically back-annotates optimized component values to the schematic.

You view analysis and optimization results simultaneously which no system has made possible before.

The MMIC WorkSystem lets you combine for tuning all subcircuit blocks in a single step, so team-engineered components easily become monolithic circuits.

A custom layout editor is all part of the package. Complete with direct read-write of CALMA GDSII files and automatic rule checking, it keeps the entire process in your department, under your control.

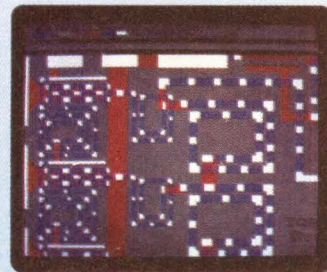

The Tek MMIC WorkSystem is the first package to integrate the development of monolithic microwave IC designs, from schematic capture to mask file generation and comprehensive documentation.

Finally, Tek's Interleaf™ automatic documentation package simplifies and accelerates what until now was the most time-consuming job of all.

Call 1-800-835-9433 to learn how to launch your circuit in record time. Or talk to your Tek CAE specialist about the MMIC WorkSystem soon.

Tektronix
COMMITTED TO EXCELLENCE

Choose Teledyne First!

AUTHORIZED DISTRIBUTORS

Alabama

Marshall Industries
Huntsville, AL
(205) 881-9235
Quality Components
Huntsville, AL
(205) 830-1881

Arizona

Future/Cetec Electronics
Phoenix, AZ
(602) 968-7140
Marshall Industries
Phoenix, AZ
(602) 496-0290

California

All American
Torrance, CA
(213) 320-0240
All American
San Jose, CA
(408) 287-0190
Future Electronics
San Jose, CA
(408) 434-1114
Marshall Industries
Milpitas, CA
(408) 942-4600
Marshall Industries
Rancho Cordova, CA
(916) 635-9700
Future/Cetec Electronics
Chatsworth, CA
(818) 700-0914
Marshall Industries
Chatsworth, CA
(818) 407-0101
Marshall Industries
El Monte, CA
(818) 459-5500
Future/Cetec Electronics
Irvine, CA
(714) 250-4141
Marshall Industries
Irvine, CA 92718
(714) 859-5050
Future/Cetec Electronics
San Diego, CA
(619) 278-5020
Marshall Industries
San Diego, CA
(619) 578-9606
Micro-Die Systems
Torrance, CA
(213) 373-0687

Colorado

Future Electronics
Westminster, CO
(303) 650-0123
Marshall Industries
Thornton, CO
(303) 451-8383

Connecticut

Future Electronics
Bethel, CT
(203) 743-9594
Marshall Industries
Wallingford, CT
(203) 265-3822

Florida

All American
Miami, FL
(305) 621-8282
Chip Supply
Orlando, FL
(305) 298-7100
Future Electronics
Clearwater, FL
(813) 578-2770
Future Electronics
Altamonte Springs, FL
(305) 767-8414
Marshall Industries
Ft. Lauderdale, FL
(305) 977-4880
Marshall Industries
Altamonte Springs, FL
(305) 767-8585
Marshall Industries
St. Petersburg, FL
(813) 576-1399
Quality Components
Tampa, FL
(813) 854-2614

Georgia

Future Electronics
Norcross, GA
(404) 441-7676
Marshall Industries
Norcross, GA
(404) 923-5750
Quality Components
Norcross, GA
(404) 449-9508

Illinois

Advent Electronics
Rosemont, IL
(312) 298-4210
Future Electronics
Schaumburg, IL
(312) 882-1255
Marshall Industries
Schaumburg, IL
(312) 490-0155

Indiana

Advent Electronics
Indianapolis IN
(317) 872-4910
Marshall Industries
Indianapolis, IN
(317) 297-0483

Iowa

Advent Electronics
Cedar Rapids, IA
(319) 363-0221

Kansas

Marshall Industries
Lenexa, KS
(913) 492-3121

Maryland

All American
Rockville, Maryland
(301) 251-1205
Future Electronics
Columbia, MD
(301) 995-1222

Marshall Industries
Gaithersburg, MD
(301) 840-9450
Pyttronic Industries
Savage, MD
(301) 792-0780

Massachusetts

Now Electronics
Framingham, MA
(617) 872-5876
Future Electronics
Westborough, MA
(617) 366-2400
Marshall Industries
Wilmington, MA
(617) 658-0810

Michigan

Advent Electronics
Farmington Hill, MI
(313) 477-1650
Marshall Industries
Livonia, MI
(313) 525-5850
Future Electronics
Detroit, MI
(313) 261-5270

Minnesota

All American
Minneapolis, MN
(612) 884-2220
Marshall Industries
Plymouth, MN
(612) 559-2255
Future Electronics
Eden Prairie, MN
(612) 944-2200

Missouri

Marshall Industries
Bridgeton, MO
(314) 291-4650

New Jersey

Future Electronics
Mt. Laurel, NJ
(609) 778-7600
Marshall Industries
Mt. Laurel, NJ
(609) 234-9100
Future Electronics
Fairfield, N.J.
(201) 227-4346
Marshall Industries
Fairfield, NJ
(201) 882-0320

New York

All American
Ronkonkoma, NY
(516) 981-3935
Future Electronics
Liverpool, NY
(315) 451-2371
Future Electronics
Rochester, NY
(716) 272-1120
Marshall Industries
Hauppauge, LI, NY
(516) 273-2424
Marshall Industries
Johnson City, NY
(607) 798-1611

Marshall Industries
Rochester, NY
(716) 235-7620
Future Electronics
Hauppauge, NY
(516) 234-4000

North Carolina

Marshall Industries
Raleigh, N.C.
(919) 878-9882
Quality Components
Raleigh, N.C.
(919) 876-7767
Future Electronics
Charlotte, N.C.
(704) 529-5500

Ohio

Hughes-Peters, Inc.
Cincinnati, OH
(513) 351-2000
Hughes-Peters Inc.
Columbus, OH
(614) 294-5351
Marshall Industries
Dayton, OH
(513) 898-4480
Marshall Industries
Solon, OH
(216) 248-1788
Marshall Industries
Westerville, OH
(614) 891-7580

Oklahoma

Quality Components
Tulsa, OK
(918) 664-8812

Oregon

Cetec Future
Beaverton, OR
(503) 645-9454
Marshall
Beaverton, OR
(503) 644-5050

Pennsylvania

Marshall Industries
Pittsburgh, PA
(412) 963-0441
Pyttronic Industries
Montgomeryville, PA
(215) 643-2850

Texas

All American
Richardson, TX
(800) 541-1435
Future Electronics
Richardson, TX
(214) 437-2437
Marshall Industries
Austin, TX
(512) 837-1991
Marshall Industries
Carrollton, TX
(214) 233-5200
Marshall Industries
Houston, TX
(713) 895-9200
Marshall Industries
El Paso, TX
(915) 593-0706

Marshall Industries
Brownsville, TX
(512) 542-4589
Quality Components
Addison, TX
(214) 733-4300
Quality Components
Austin, TX
(512) 835-0220
Quality Components
Sugarland, TX
(713) 491-2255

Utah

Future Electronics
Salt Lake City, UT
(801) 972-8489
Marshall Industries
Salt Lake, UT
(801) 485-1551

Washington

Future Electronics
Redmond, WA
(206) 881-8199
Marshall Industries
Bellevue, WA
(206) 747-9100

Wisconsin

Marshall Industries
Brookfield, WI
(414) 797-8400
Taylor Electronic Co.
Mequon, WI
(414) 241-4321

Alberta

Future Electronics
Calgary Alberta
(403) 235-5325
Future Electronics
Edmonton, Alberta
(403) 438-2858

British Columbia

Future Electronics
Vancouver, B.C.
(604) 294-1166

Ontario

Future Electronics
Ottawa, Ontario
(613) 820-8313
Future Electronics
Dowdview, Ontario
(416) 638-4771

Quebec

Future Electronics
Pointe Claire, Quebec
(514) 694-7710
Future Electronics
St. Foy, Quebec
(418) 682-5775

Manitoba

Future Electronics
Winnipeg, Manitoba
(204) 339-0554

Seeking a +5V Supply Voltage Analog Switch?They Exist Here!

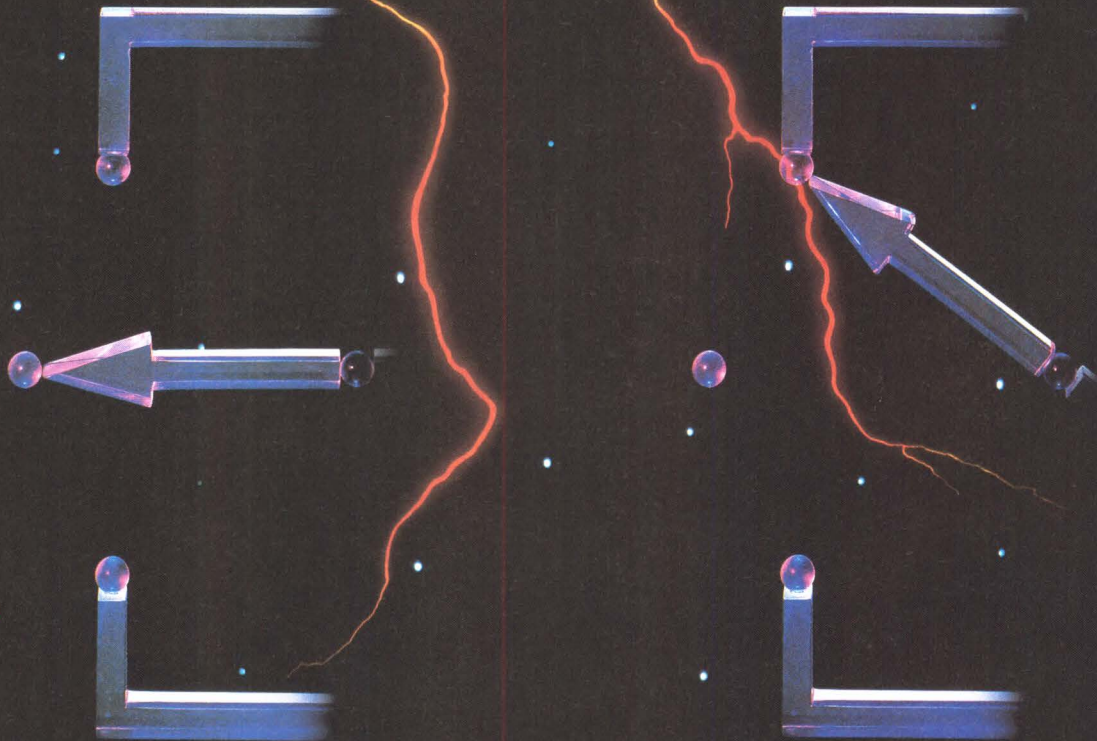

Teledyne Semiconductor's **TSC44X** precision **CMOS** analog switch family sets the standard in low supply voltage switch technology. Sharing the same 5V or $\pm 5V$ power supply levels modern CMOS data converters and operational amplifiers need, your designs now benefit from low 10 pA switch leakage current, 95 ohm "ON" resistance, and 1.5mW power dissipation. Single supply operation from 3 to 18V for battery powered systems. Full microprocessor compatibility too!

Switch architectures cover all your application needs from quad **SPST** to dual **SPDT**. Normally closed, open and mixed versions. The innovative **TSC444 SPDT** switch features a neutral, switch "OFF" position. On chip latches eliminate external components in μ -processor controlled systems. Disable latches for transparent operation. Standardize on the **TSC44X** family for your job today and tomorrow's breakthrough.

Pin compatible with many old, high supply voltage only parts like the DG221 and AD7590/1/2. Available in DIP or "SO" surface mount technology. Call or write for full information, design help and data sheets. Samples available now.

All devices are backed by Teledyne's reputation for quality, service and support - a reputation earned through 25 leadership years in the semiconductor industry.

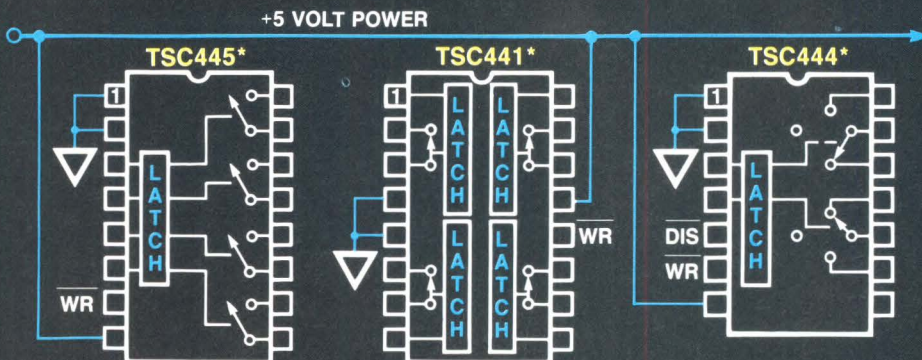

*All Configurations Available

CIRCLE 9 FOR LITERATURE ONLY
CIRCLE 77 FOR DIRECT FACTORY CONTACT

1-800-888-9966
415-968-9241

1300 Terra Bella Avenue
Mountain View, CA 94039
TWX: 910-379-6494
FAX: 415-967-1590

 **TELEDYNE
SEMICONDUCTOR**

It's your choice.

PRODUCT DEVELOPMENT SCHEDULE

PAGE 2

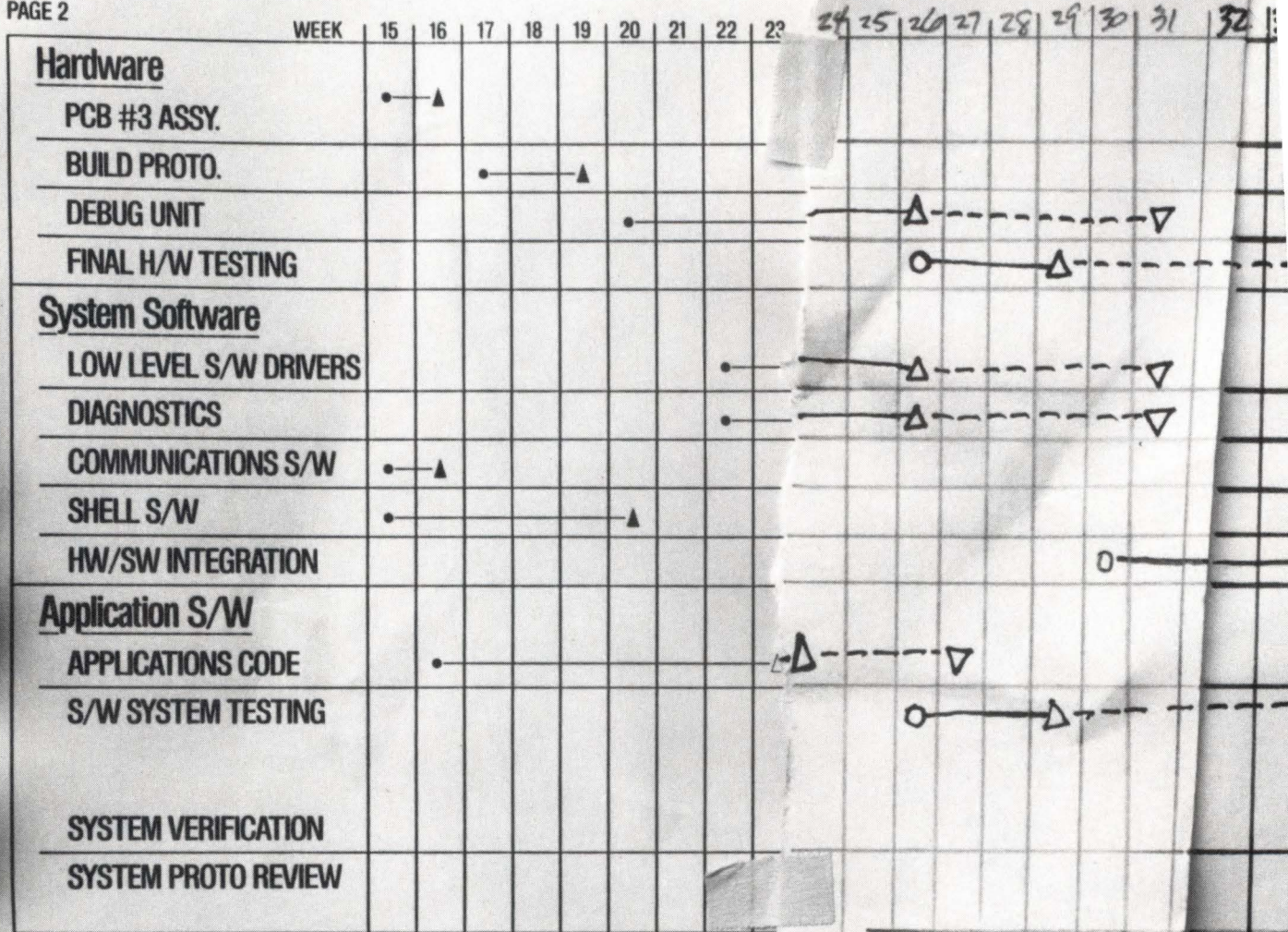

Let's face it. Slipped development schedules and budget overruns can mean lost opportunities. Yet many traps that seriously delay a development schedule are quite complex, especially when they are compounded by problems that arise in cross development work.

Like not knowing whether the errors you are getting from your prototype processor are real. Or losing bugs in the cracks between your development system and the prototype.

Fortunately, the answer to these complex problems is simpler than you might think. Because now Applied Microsystems offers what we call performance packages: complete, fully integrated development solutions, designed to meet your development requirements and to detect even subtle problems quickly.

Performance Packages that Live Up to Their Name.

Each package includes a powerful in-circuit emulator, the only tool that can

successfully bridge the gap between host computer and prototype. With features like complex triggering, reliable memory, built-in target diagnostics, I/O simulation, and special interrupt handling.

And to complement the power of our emulators, we provide software tools that work with a variety of platforms and languages.

Whichever package you choose, you're getting the highest performance.

Invest now or pay later.

are designed for any language producing complete Intel OMF information.

A PC-based, in-circuit source level debugger and simulator are closely cou-

remote control and simulation of I/O; plus user-definable windows for viewing registers, stacks and variables

High-speed Symbolic Debugging for Intel, Motorola and Zilog Microprocessors

Our VALIDATE/ES DRIVER package includes easy-to-use (menu-driven and remote control) software that smoothly links the host functions to the ES 1800 emulator. This allows the upload and download of programs, symbol tables and command files.

```

15: for (count = 1; count <= 100; count++)
16: {
17:   beep (); /* 'Beep' at user. */
18:   outscope (); /* Display "--> SOFTSCOPE 2.0 */
19:   outlang (); /* Display "--> C86 example */
20:   outcountcount (); /* Display "--> Count=xx */
21:   do_data (); /* Data reference demo. */
22:   delay (); /* Slow display down. */
23: }
24: }
*reg
AX=0000 SP=0006 CS=30D0 BP=0000
BX=0000 BP=0000 DS=30B7 FI=0000 = 0D D0 10 10 S0 Z0 A0 P0 C0
CX=0000 SI=0000 SS=3052
DX=0000 DI=0000 ES=0000
*mem 12
12: main ()
2FD3:0001 56 PUSH SI
2FD3:0001 57 PUSH DI
2FD3:0002 55 PUSH BP
2FD3:0003 3BEC MOV BP,SP
2FD3:0004 C1E1 CWD; completed
  
```

pled with our ES 1800 emulator. You can use commands to examine variables on the fly, check contents of registers, and determine current position in code. And real-time trace is displayed as source level statements, machine instructions or bus cycles.

The packages also include a logic state analyzer probe, and provide up to 2 Megabytes of overlay memory plus full protect mode support for the 80286.

Source Level Debugging for Motorola Microprocessors

The window-oriented VALIDATE/XEL package combines our XEI source-level debugger, a simulator and the MCC68K compiler with our ES 1800

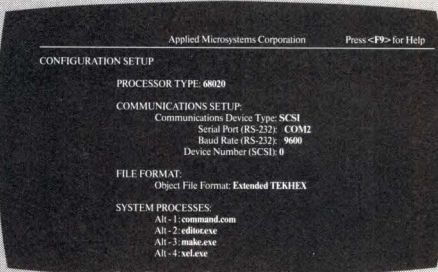

Also included are a logic state analyzer probe; the SCSI option for increasing download speeds by up to 30 times; plus up to 2 Megabytes of overlay memory.

To find out more about 8, 16 or 32-bit development solutions that save money in the long run, write Applied Microsystems Corp., P.O. Box 97002, Redmond, WA 98073-9702. Or call 1-800-426-3925 (In Washington, call 206-882-2000).

In Europe, contact Applied Microsystems Corporation Ltd., Chiltern Court, High Street, Wendover, Aylesbury, Bucks, HP22 6EP, United Kingdom. Call 44-(0)-296-625462.

```

          DATA          TRACE
1 count          0          0 00006012 TURINGSTART
2 ptr            0x4E724E72
3 tape[count]   0x00
          CODE
* 13 for (i = 0; ptr = tape; i < TAPE_SIZE; i++)
14   *ptr++ = 0; /* Clean the tape */
15   state = 0; /* Starting state */
16   count = 0; /* Initial count */
17   ptr = &tape[TAPE_SIZE] / 2; /* Start in the middle */
18   do {
19     switch (state) {
20       case 0:
21         if (*ptr == '1')
22
  
```

emulator. The package also includes a logic state analyzer probe and our well-known SCSI interface option, that significantly decreases download time.

In addition to up to 2 Megabytes of overlay memory, you get target control from your source code; powerful "C" language macros for code patching,



development tools available.

Source Level Debugging for Intel Microprocessors

Our VALIDATE/Soft-Scope and VALIDATE/Soft-Scope 286 packages

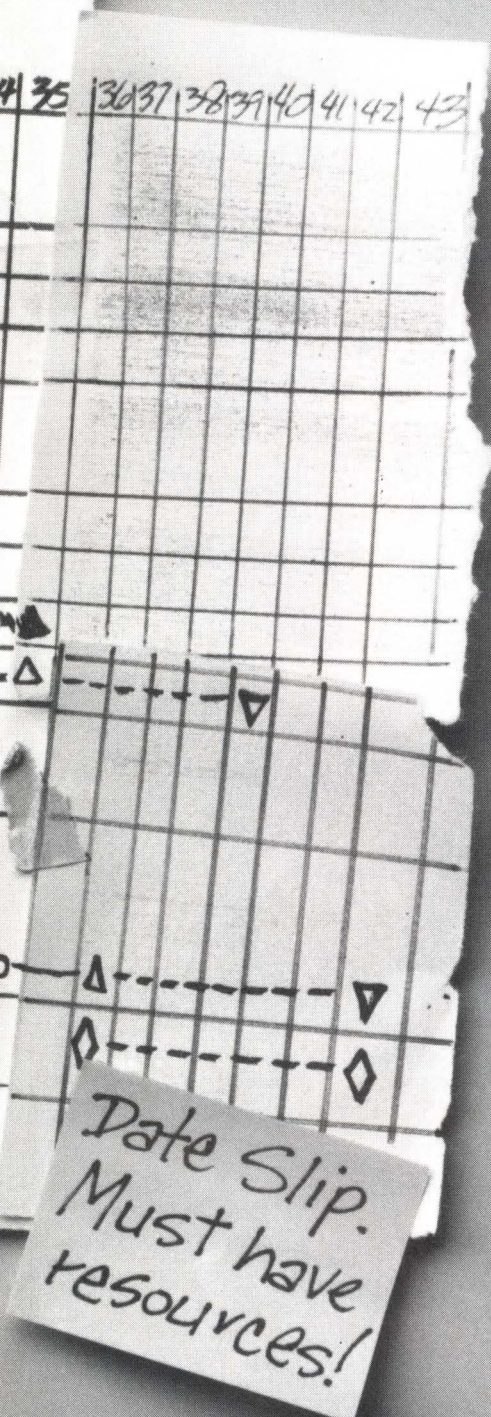

Our ASICs

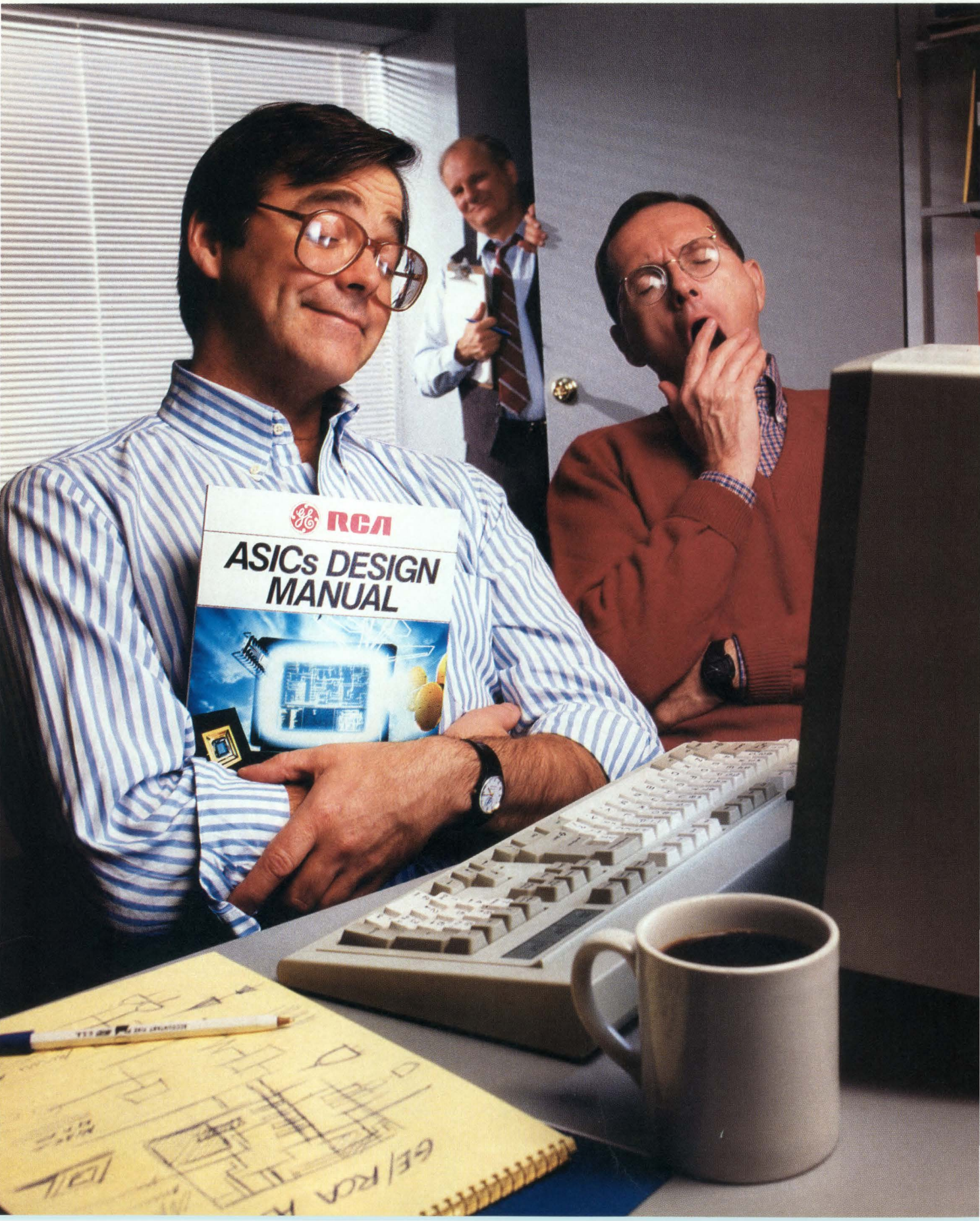

are boring.

They're easy to design. They're ready on time.
And first-time success is virtually 100%.

You've heard all about the excitement of ASICs.

They improve performance, lower costs and make many new designs possible.

But, unfortunately, you've probably also heard about one big potential problem: while many ASICs pass the tests specified by the designer, they don't always work in the real world. And that causes excitement you can do without.

How to get first-time success.

It starts with our Design Simulation Software. It's been rated the best in the industry by the people who should know—designers who have used it. Within three days, you can be up to speed, working at any of the major workstations in the industry, creating and revising your ASIC with ease.

The standard cell advantage.

You'll really appreciate the power of our standard cells, which allow you to integrate a whole system, including macros, memories, logic and peripherals, onto a single chip.

We have cells with effective gate length as small as 1.5μ ($.9\mu$ coming soon). And double-level metal for higher-density chips that can handle higher clock speeds.

You can choose from a wide range of Supercells, including the leading-edge RS20C51 core micro, RAMs, analog functions, bit-slice processors, HC/HCT logic, Advanced CMOS Logic, and high-voltage cells.

If they aren't enough, we can even generate

Supercells to your specs.

And we're also in the forefront of silicon compiler technology. So we can offer you the ability to create designs that are heavily BUS-structured, with your ROMs, RAMs, PLAs and ALUs compiled right into the design.

We also bring you the resources of some very powerful partners, thanks to our alternate-source agreements with VLSI on standard cells; WSI on macrocells and EPROMs; and a joint-development agreement with Siemens and Toshiba on the Advancell[®] library of small-geometry cells.

Gate arrays, too.

If gate arrays are better for your design, you'll be able to choose from our full line up to 50,000 gates, with effective gate length as small as 1.2μ and sub 1 ns gate delays.

These gate arrays use "continuous gate" technology for up to 75% utilization. They are an alternate source to VLSI Technology arrays.

We also alternate source the LSI Logic 5000 series.

And we have a unique capability in high-rel ASICs, including SOS. Our outstanding production facilities here in the U.S. produce high-quality ASICs in high volume at very low costs.

It almost sounds exciting for something so boring, doesn't it?

For more information, call toll-free today 800-443-7364, ext. 25. Or contact your local GE Solid State sales office or distributor.

In Europe, call: Brussels, (02) 246-21-11; Paris, (1) 39-46-57-99; London, (276) 68-59-11; Milano, (2) 82-291; Munich, (089) 63813-0; Stockholm (08) 793-9500.



GE Solid State

GE/RCA/Intersil Semiconductors

Three great brands. One leading-edge company.

*Trademark of General Electric Company, U.S.A., not connected with the English Company of a similar name.

Hitachi MOS Memory Leadership Has Been Earned

The stag faces constant challenges from aspiring leaders of his herd. He maintains his leadership only by winning those battles—over and over again. Similarly, in the highly competitive MOS memory market, leadership must be earned . . . not just claimed.

Hitachi's MOS memory leadership is well documented. For example:

1983 Hitachi is ranked the number one CMOS RAM manufacturer by engineers in *Electronic Design's* Audit of Brand Recognition.

1984 Hitachi again is rated the leading CMOS RAM manufacturer in *Electronic Design's* study.

1985 Hitachi again is rated number one in CMOS RAMs, in *ED's* Brand Recognition Study.

1986 Hitachi is the first manufacturer that purchasing agents consider when buying CMOS RAMs, as reported by *Electronic Buyers' News*, Buyers' Preference Study.

1986 Hitachi rated the most preferred CMOS RAM vendor in *EBN's* Japanese Semiconductor Manufacturers' Benchmark Study. First in quality, customer service, technical assistance, trust, ease of doing business . . . and first in eight additional categories.

Marketplace recognition has been building over the years. This is due, in part, to our uncompromising QA programs, which have given our memory products a legendary reputation for quality and reliability. Our long-range investment in production technology is also important to our customers. It means that our products are in constant, dependable supply.

Supremacy Achieved

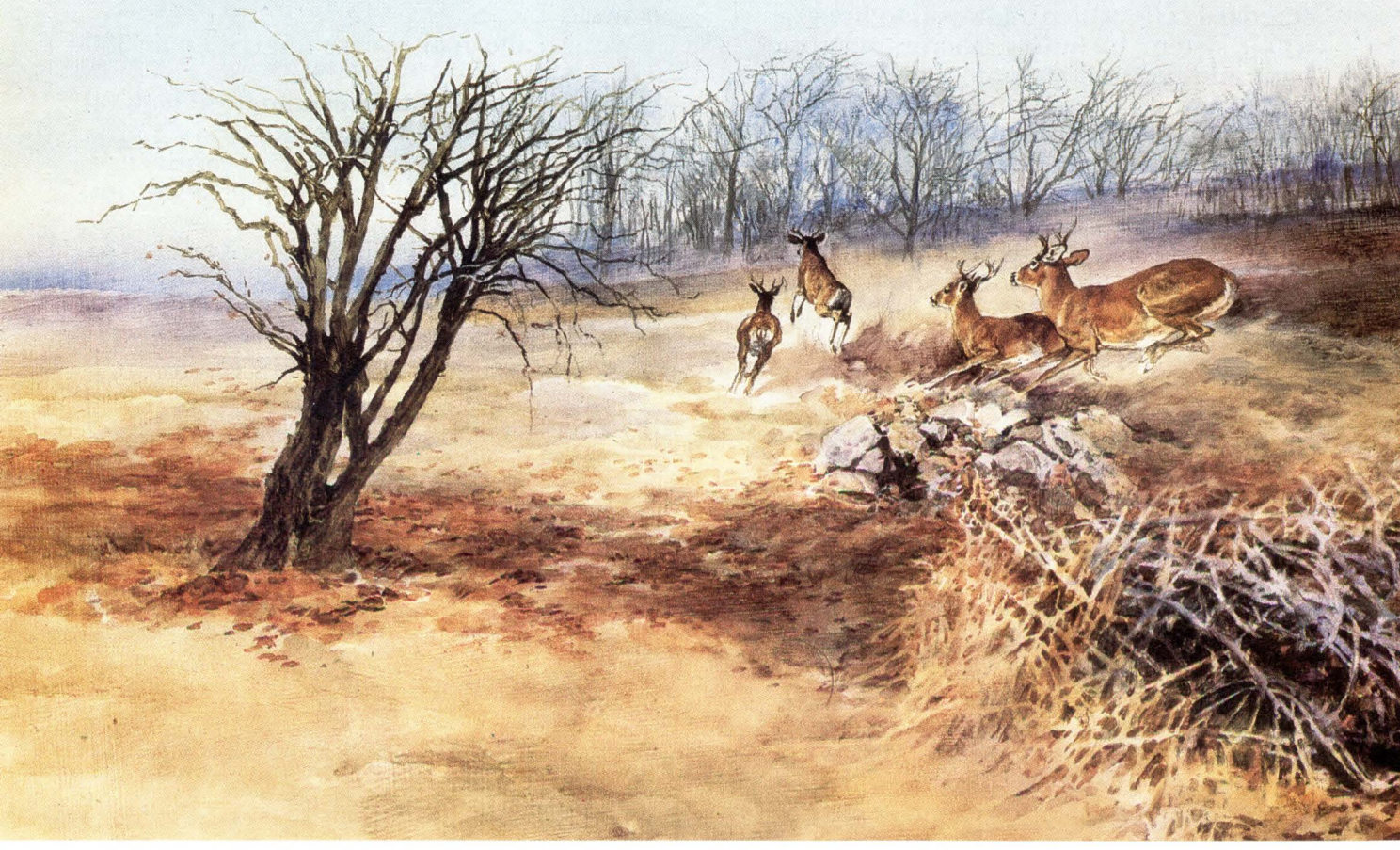

Hitachi's technology pushes MOS Memory to new levels of performance. Recently, we introduced our HM62256 32K x 8 SRAM, featuring an incredible 85ns access time, while drawing only 40mW power. And now, we're announcing the HM66204, with an unprecedented 1-Megabit (128K x 8) of storage! We've surface mounted four HM62256 devices into a standard 600-mil DIP package . . . a four-fold increase in density levels. The HM66204 will be pin-for-pin compatible with our future 1-Megabit monolithic SRAM.

So, the next time someone claims they're "number one" in MOS memories, consider the facts. If you're like the survey participants mentioned above, you'll call Hitachi first. Contact us through your local Hitachi Sales Representative or Distributor Sales Office today.

Fast Action: To obtain product literature immediately, CALL TOLL FREE, 1-800-842-9000, Ext. 6809. Ask for literature number R16.

Hitachi America, Ltd.

Semiconductor and IC Division
2210 O'Toole Avenue, San Jose, CA 95131
Telephone 1-408/435-8300



We make things possible



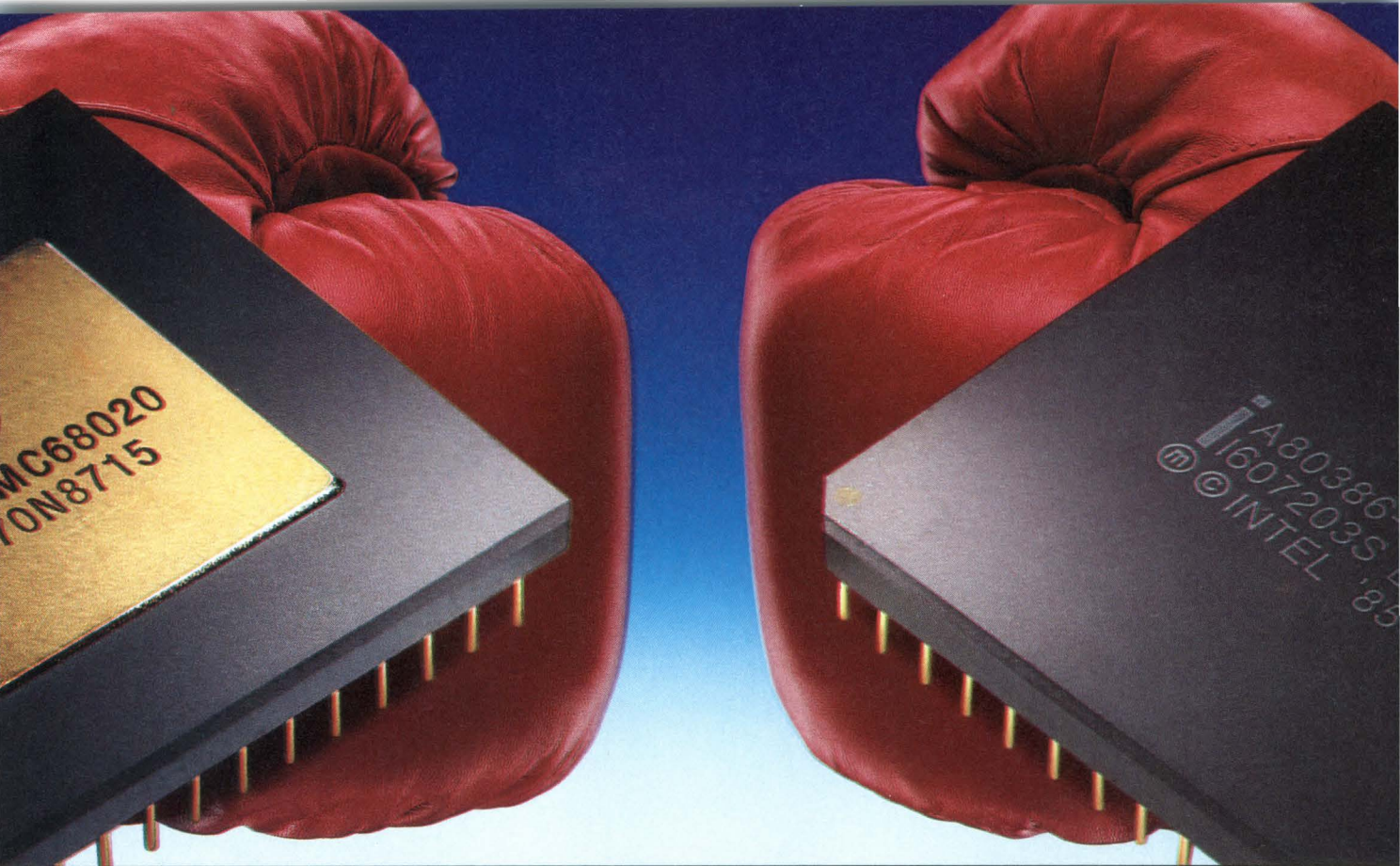

68020 vs. 80386 Who wins? Microtek.

When choosing between the two leading 32-bit processors, don't let emulator support slow you down. NWIS is the exclusive U.S. source of Microtek in-circuit emulators for both. And for all their other family members as well, like the 68010, 68000, 80286, 80186 and 8086. And many others.*

In fact, Microtek emulators have a long track record of being first to market with quality support for every major microprocessor. Which gives you shorter time-to-market and an assured expansion path for product upgrades.

Every Microtek emulator can be used as a stand-alone device, or as part of an integrated system. All use simple command structures and include a symbolic debugger for rapid insight into your software's real-time behavior. And each communicates with the IBM® PC/XT/AT, VAX®, MicroVAX®, Apollo and Sun computers.

Microtek emulators are just one part of NWIS's complete line of embedded microprocessor software development tools.

Our Software Analysis Workstation (SAW) brings you hardware-based, real-time software analysis in a source code environment. Including performance analysis, time-aligned dual processor trace, code coverage analysis, and Context Trace™, which lets you trace high-level events and related assembly-level code at the same time.

And for source code development, our Microtec® Research products provide you with C and Pascal cross-compilers, cross-assemblers and debuggers for the same wide range of popular processors.

Best of all, NWIS backs all these products with solid applications support, both at the local and factory level. So let us become your single source for emulators and other microprocessor Computer-Aided Software Engineering (CASE) tools.

1-800-547-4445.



Pioneering Microprocessor CASE

NWIS
NORTHWEST INSTRUMENT SYSTEMS, INC.

P.O. Box 1309 • Beaverton, OR 97075 • 1-800-547-4445

IBM is a registered trademark of International Business Machines. VAX and MICROVAX are registered trademarks of Digital Equipment Corporation. Microtec is a registered trademark of Microtec Research Inc.

* Processors supported by Microtek: 80386, 80286, 80186, 80188, 8086, 8088, 68020, 68010, 68008, 68000, 6809, 6809E, 6502, Z80, NSC800, 8085, 8032, 8051, 8031, 8344, 8048, 8049, 8050, Z8, SUPER 8, 68HC11, 64180, 80515.

Circle No. 13 for demonstration

Circle No. 12 for literature

NEWS BREAKS

EDITED BY JOANNE CLAY

MODULAR LOGIC ANALYZER GROWS WITH YOUR NEEDS

The ML4400 Logic Analyzer from Arium Corp (Anaheim, CA, (714) 978-9531) is based on a mainframe that can accept as many as four capture modules. At present, you can choose from a high-speed module and a standard module. The high-speed module acquires four channels at 400 MHz (32,768 samples), eight at 200 MHz (16,384 samples), or 16 at 100 MHz (8192 samples). The standard module acquires 20 channels asynchronously at 100 MHz (8192 samples) or 40 channels synchronously at 50 MHz (4096 samples). With an expansion pod, you can acquire 80 channels at 25 MHz (2048 samples). You can also use any combination of the modules, so you can configure the system to acquire 80 channels synchronously at 50 MHz and eight channels asynchronously at 400 MHz. Or, with four of the standard modules, you could trace program flow from four separate 68020 pods or have a 160-channel, 50-MHz synchronous logic analyzer. The ML4400 mainframe costs \$2895 and comes with a 7-in. CRT, parallel and serial printer outputs, a CGA/EGA-compatible color video interface, an IBM-PC-style keyboard interface, trigger outputs, eight nonvolatile setups, and a ROM emulator (minus the probe). A number of options are available: a 3.5-in. floppy-disk drive costs \$795, a high-speed module is \$1995, a standard module is \$1795, and a 200- or a 400-MHz probe sells for \$1995. You can purchase a starter system that includes the mainframe, a standard module, and a 40-channel logic pod for \$4995. Many popular μ P pods are also available.—David Shear

SOFTWARE LIBRARIES IMPLEMENT SIGNAL-PROCESSING FUNCTIONS

The 387FFT from MicroWay (Kingston, MA, (617) 746-7341) is a library of assembly-language signal-processing functions—such as FFT, convolution, correlation, and autocorrelation—for use on the IBM PC, PC/XT, PC/AT, and compatible computers with numeric coprocessors. The library supports most popular MS-DOS, C, Fortran, and Basic compilers. Although the 640k-byte MS-DOS memory limits you to a maximum 2-dimensional FFT size of 256 \times 256, you can use the library's DISKFFT utility to perform 2-D transforms on data files as large as 32M bytes that can hold as many as 2048 \times 2048 complex points (an array size common in image-processing applications). For RAM-based 2-D transforms on arrays requiring as many as 16G bytes, the vendor supplies the 387FFT-PM library. The 387FFT-PM runs only in protected mode and requires the vendor's protected-mode C or Fortran compiler. Each library is \$249.

—Margery S Conner

CAE SOFTWARE FOR THE IBM PC BREAKS THE 640k-BYTE BARRIER

IBM PCs and compatible computers impose a severe handicap on most application software: a 640k-byte memory ceiling. The Workview 2000 and 3000 CAE software packages from Viewlogic Systems (Marlboro, MA, (617) 480-0881) break this barrier and, according to the vendor, deliver workstation-like performance on a PC. Both packages incorporate the schematic-capture, analog- and digital-simulation, and XNS network-communications capabilities of the company's earlier products. To these features, the new packages add support for high-resolution graphics (1024 \times 768 pixels) for selected graphics boards, VHDL behavioral-level simulation, EDIF 2 0 0 data-file capability, the TCP/IP network protocol, a preplacement editor, and a schematic librarian. Though both software products operate with DOS, Workview 2000 (for 80286-based PCs) can use as much as 16M bytes of memory, and Workview 3000 (for 80386-based machines), can use as much as 4G bytes of RAM, if you can find a way to cram that much memory into your computer. The packages, which will begin shipping in June, will cost \$10,000 to \$14,000.—Steven H Leibson

NEWS BREAKS

SYSTEMS MAKE μ PROGRAM DEVELOPMENT EASIER AND LESS COSTLY

If the development systems just introduced by Step Engineering (Sunnyvale, CA, (408) 733-7837) and Hilevel Technology (Irvine, CA, (714) 727-2100) are any indication, the industry is about to witness a resurgence of interest in microprogrammed computing architectures. Step aims its entry, the Step 50, at the middle of the market: A PC-hosted, 96-bit-wide, 25-MHz unit with probes and a built-in logic analyzer costs \$16,800. The Step 50's capabilities far exceed those of the company's Microstep, which sells for \$6500. Step's top-of-the-line product, the Step 40, targets the integration of multiple microprogrammed processors and starts at \$25,000. Hilevel's 50-MHz DS5000 includes a 256-channel logic analyzer and a 512-bit-wide emulation memory. It sports innovations that make it easier to use than its predecessors; at \$10,000 to \$20,000, it's also less expensive, but its specs are better. The DS5000's probes contain CMOS static RAMs, and 7-ft ribbon cables link the probes to the mainframe. Because signals don't have to travel over cables to get to and from memory, the probes can contain relatively low-cost, medium-speed RAMs.—Dan Strassberg

GATE-ARRAY SOFTWARE DELIVERS OVER 80% UTILIZATION

Silvar-Lisco (Menlo Park, CA, (415) 324-0700) has announced its vendor-independent layout software for the design of very large gate arrays. Called Avant Gards, the software can be used to design arrays that use more than 150,000 gates. The software supports a variety of technologies, including CMOS, BiCMOS, and GaAs. You can use the sea-of-gates, row, column, and island gate-array styles. Floor-planning, partitioning, placement, and routing are all automatic and ensure that every net meets user-defined timing constraints. The vendor claims that gate utilization for designs employing sea-of-gates construction and three metal layers has been proven at 80 to 90%. The software is fully integrated with the existing CAD tools from Silvar-Lisco and runs on a variety of workstations. The software will be available by mid-April. The Avant Gards product family starts at \$60,000, depending on host and configuration.—Richard A Quinnell

INTERFACE CHIP FAMILY SUPPORTS PROPOSED SCSI-2 STANDARD

Marketing and technology partners NCR Microelectronics Div (Dayton, OH, (800) 334-5454) and Emulex Corp (Costa Mesa, CA, (714) 662-5600) have added four devices to their 53C90 family of SCSI (Small Computer Systems Interface) ICs. All of the new ICs support the proposed SCSI-2 standard; they have such features as bus-initiated selection for extended message selections, select with ATN3 command, and 10-byte Group 2 commands. The chips also include state machines that perform common SCSI-2 bus sequences along with the SCSI sequences supported by the 53C90. The 53C90A adds the SCSI-2 features, yet is pin compatible with the 53C90. The 53C90B adds a parity check to operations between the SCSI bus and memory.

Like the 53C90, the new chips operate with 8-bit maximum asynchronous and synchronous transfer rates of 3M bytes/sec and 5M bytes/sec, respectively. The 53C94 and 53C95 also include a split-bus feature that supports wider SCSI data paths, allowing faster transfers. Both devices support a 16-bit SCSI data path, and both can perform either 8- or 16-bit DMA transfers to memory. The 53C94 handles only single-ended SCSI operations, but the 53C95 includes logic that can control differential transceivers. The software for all members of the 53C90 family is compatible. The 53C90A/B costs \$20.44 (1000); samples will be available in July. Samples of the 53C94/95 will be available in June; the part will cost \$25.55 (1000).—Maury Wright

NOW IT ONLY TAKES TWO TO TRANSFORM YOUR IMAGE

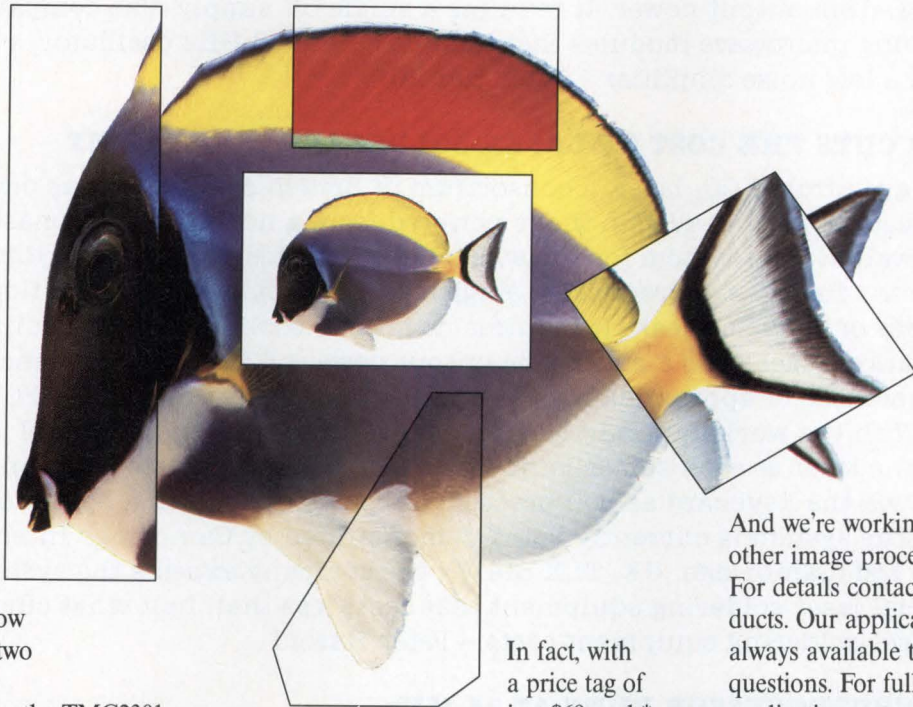
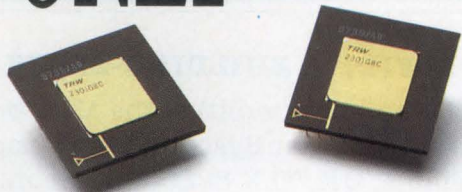

Sound fishy?
Believe it.
Video image
manipulation is now
possible with just two
chips. TRW LSI

Products introduces the TMC2301
Image Resampling Sequencer — the
industry's first low-cost solution to
real-time graphics manipulation. One
pair eliminates literally hundreds of
components and costly board space
previously required to perform the
same graphic functions.

A TMC2301-based board system
can offer performance equal to many
video-effect systems currently avail-
able. This powerful two-chip set, along
with three multiplier-accumulators,
can expand, rotate, zoom, pan, com-
press, warp and/or filter a two-
dimensional bit-mapped color image.
Even complex transformations such
as polar-to-rectangular coordinates
and video standards conversion can
be achieved easily and economically.

In fact, with
a price tag of
just \$69 each*,

the TMC2301 reduces the cost of
video manipulation by hundreds of
dollars.

The TMC2301 utilizes power-
conserving CMOS technology and
operates at up to 18MHz from a single
5V supply. It's ideal for video broad-
cast equipment, personal computer
graphics, medical imaging, satellite
image processing and defense elec-
tronic systems. And, it's available now
from your nearby Hall-Mark or
Hamilton/Avnet distributor.

**TRW LSI Products — bringing the
worlds of Data Acquisition and DSP
together.**

TRW has made video image
manipulation easy and inexpensive.

And we're working to simplify many
other image processing tasks for you.
For details contact TRW LSI Pro-
ducts. Our applications engineers are
always available to help answer your
questions. For full data sheet and
application notes, contact:

TRW LSI Products
P.O. Box 2472
La Jolla, CA 92038
619.457.1000

In Europe, phone:
TRW LSI Products
Munich, 089.7103.124;
Paris, 1.69.82.92.41;
Guildford (U.K.), 0483.302364

In the Orient, phone:
Hong Kong, 3.880629;
Tokyo, 03.234.8891; Taipei, 751.2062;
Seoul, 2.553.0901

TRW
TRW LSI Products

NEWS BREAKS: INTERNATIONAL

ICs PROVIDE A BUILDING-BLOCK APPROACH TO MICROWAVE DESIGN

In the next few months, the Microwave Common Module Group—which comprises Ferranti Computer Systems Ltd (Manchester, UK, TLX 76166), M/A-Com Ltd (Dunstable, UK, TLX 82295), Marconi Electronic Devices Ltd (Lincoln, UK, TLX 56380), and Plessey Microwave Ltd (Towcester, UK, TLX 311441)—will release a 6- to 18-GHz, low-noise, single-stage broadband amplifier. This component represents the first of a series of microwave ICs that let you adopt a building-block approach when designing microstrip subsystems. All these ICs (referred to as microwave common modules) will be built to a common standard that includes interface, performance-level, and physical-dimension requirements. The broadband amplifier, which is expected to sell for around £100 (500), specs 5.5-dB gain, ± 0.5 -dB gain ripple, 5-dB noise, and 10-dBm output power. It requires a single 8V supply. The companies are also developing microwave modules that include a 6- to 18-GHz oscillator, a mixer, a switch, and a low-noise amplifier.—Peter Harold

CO₂ LASER CUTS THE COST OF LASER-SOLDERING EQUIPMENT

By using an infrared CO₂ laser, a consortium of British companies has developed an automatic laser-soldering system that's powered from a normal single-phase ac line supply. To evaluate the system for the soldering of surface-mount and hybrid assemblies, the firms have produced a single-operator soldering workstation that's about the size of an office desk. It requires no special cooling, air, or vacuum supplies. The workstation's laser has a maximum output power of 30W and can generate a minimum spot size of approximately 0.3 mm. It is controlled by an IBM PC-compatible computer. With the workstation in learn mode, you use a CCD camera and joystick control to aim the laser at each solder joint. You enter the appropriate soldering parameters via the keyboard as you proceed. Subsequent soldering operations are automatic. The system is currently being demonstrated by Cambridge Interconnection Technology Ltd (Cambridge, UK, TLX 81417); the company expects the system to lead to commercial laser-soldering equipment that costs less than half what currently available laser-soldering equipment costs.—Peter Harold

16-BIT MICROPROCESSOR RUNS AT 16 MHz

NEC has recently developed a 16-MHz version of its V30 16-bit microprocessor. The new μ P's program-handling capacity reportedly approaches that of 32-bit μ Ps, yet the processor's peripheral circuits allow it to use available 16-bit systems, including printers and disk drives. The μ P uses the same command set that Intel's 8086 uses, and it's believed to be compatible with the company's V30, which runs at 8 MHz and has a 640k-byte address space. According to Japanese news reports, the 16-MHz μ P is reputedly 30% faster than Intel's 80286 and Motorola's 68010. NEC is expected to begin shipping samples of the device in the next few weeks.—Joanne Clay

1k-BIT DRAM HAS 570-PSEC ACCESS TIME, DISSIPATES 13 mW

Using high-speed Josephson junctions, NEC has developed a 1k-bit dynamic RAM with an access time of 570 psec. The device dissipates 13 mW. The 4.4×4.4-mm die incorporates 10,000 niobium/aluminum oxide/niobium Josephson junctions, which are resilient to temperature cycles; they form 1000 gates and 1000 memory cells. The RAM's memory structure is organized as 1k word×1 bit. The company reduced the part's access time by means of three proprietary developments: a niobium-planarization technology, an ac/dc power source, and an ac-driven memory cell.—Joanne Clay

0.7μ CMOS 64K SRAMS

This blazing 64K SRAM, with 12ns address access time, is twice as fast as any non-Performance 64K. It joins our family of 64K architectures—all with 6 transistor storage cells to optimize for performance, margins, temperature range, and supply tolerances.

		Com'l	Mil
P4C187	64K x 1	12ns	15ns
P4C188	16K x 4*	17ns	25ns
P4C164	8K x 8	20ns	25ns

*Also available: Common I/O with output enable and separate I/O.

For optimal packing density, our standard 64K SRAMs are delivered in the popular 0.3" package widths, in either hermetic or plastic.

But that's not all. While others are still trying to catch up to the pace set by our 0.8 micron channel lengths and 2.75 micron metal pitch, we have pushed the frontiers of technology out even further. Now Performance's PACE Technology™ features 0.7 micron effective channel lengths, and 2.25 micron metal pitch. (As we've said before, metal pitch is the design rule that separates the men from the boys in VLSI technology.)

All of our chips are made here in our Sunnyvale facility for six-inch wafers, which has now attained Class 1 status.

Memory technology with the highest speed and greatest density gives you faster systems at a lower cost. So don't be left behind. Call the company that is ready to deliver the performance your system needs.

Performance Semiconductor
610 E. Weddell Drive
Sunnyvale, CA 94089
Telephone: 408-734-9000
Telex: 6502715784
FAX: 408-734-0258

CIRCLE NO 15

© 1987 Performance Semiconductor Corporation. PACE Technology is a trademark of Performance Semiconductor Corporation.

12NS

PERFORMANCE SEMICONDUCTOR SHATTERS THE SPEED BARRIER with a new CMOS 64K x 1 SRAM



"It is with enormous pride in the achievements of the employees of our young company that we are able to announce that our technological pace is accelerating. Our engineers and scientists are smart, dedicated, and focused. New levels of technical productivity are being established every month. We are at the tip of the technology vector into the future and we intend to stay there."

Tom Longo
President

PERFORMANCE
SEMICONDUCTOR CORPORATION

I want a faster system! Please send me detailed information on your SRAMs.

NAME _____

TITLE _____

COMPANY _____

ADDRESS _____

CITY/ST/ZIP _____

PHONE _____

EDN041488

rugged plug-in amplifiers

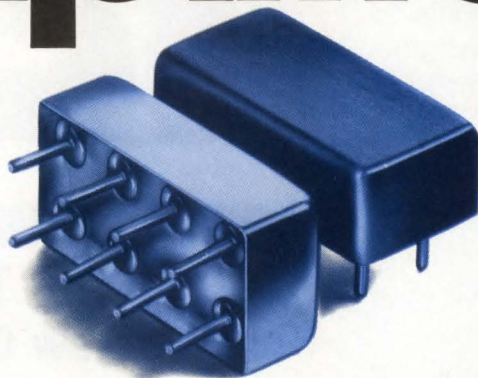

0.5 to 1000 MHz from \$13⁹⁵ (5 to 24 qty)

Tough enough to meet full MIL-specs, capable of operating over a wide -55°C to $+100^{\circ}\text{C}$ temperature range, in a rugged package... that's Mini-Circuits' new MAN-amplifier series. The MAN-amplifier's tiny package (only 0.4 by 0.8 by 0.25 in.) requires about the same pc board area as a TO-8 and can take tougher punishment with leads that won't break off. Models are unconditionally stable and available covering frequency ranges 0.5 to 500MHz and 0.5 to 1000MHz, and NF as low as 2.8dB.

Prices start at only \$13.95, *including* screening, thermal shock -55°C to $+100^{\circ}\text{C}$, fine and gross leak, and burn-in for 96 hours at 100°C under normal operating voltage and current.

Internally the MAN amplifiers consist of two stages, including coupling capacitors. A designer's delight, with all components self-contained. Just connect to a dc supply voltage and get up to 28dB gain with +9dBm output.

The new MAN-amplifier series...
another Mini-Circuits' price/performance breakthrough.

MODEL	FREQ. RANGE (MHz) f_L to f_U	GAIN dB min flatness ^{††}	MAX. OUT/PWR [†] dBm	NF dB (typ)	DC PWR 12V, mA	PRICE \$ ea. (5-24)
MAN-1	0.5-500	28 1.0	8	4.5	60	13.95
MAN-2	0.5-1000	19 1.5	7	6.0	85	15.95
MAN-1LN	0.5-500	28 1.0	8	2.8	60	15.95
◇MAN-1HLN	10-500	10 0.8	15	3.7	70	15.95

^{††}Midband $10f_L$ to $f_{U/2}$, $\pm 0.5\text{dB}$ [†]1dB Gain Compression ◇Case Height 0.3 In.
Max input power (no damage) +15dBm; VSWR in/out 1.8:1 max.

finding new ways ...
setting higher standards

Mini-Circuits

A Division of Scientific Components Corporation
P.O. Box 350166, Brooklyn, New York 11235-0003 (718) 934-4500
Fax (718) 332-4661 Domestic and International Telexes: 6852844 or 620156

SURFACE MOUNT MIXERS



\$2.49
(1,000 qty)

The opportunity for automated, low-cost assembly is a key benefit of surface-mount technology, but is often wiped out by the high price of surface-mount components. Now, Mini-Circuits offers a new series of mixers to meet the pricing demands of SMT ... only \$2.49 in 1,000 quantity (\$3.75 ea. in quantity of 10) ... at a cost even lower than most conventionally-packaged mixers.

The SCM-1 spans 1 to 500MHz with only 6.0dB conversion loss, 45dB LO-RF isolation, and 40dB LO-IF isolation. Housed in a rugged, non-hermetic 0.4 by 0.8 by 0.3 in. high (maximum dimensions) plastic/ceramic package. Spacing between connections is 0.2 in. The mixer is offered with leads (SCM-1L) or without leads (SCM-1NL) to meet a wide range of pc board mounting configurations.

Each SCM-1 is built to meet severe environmental stresses including mechanical shock/vibration as well as temperature shock. The operating and temperature storage range is -55°C to +100°C. Each SCM-1, designed and built to meet today's demanding reliability requirements, carries Mini-Circuits' exclusive 0.1% AQL guarantee of no rejects on every order shipped (up to 1,000 pieces).

When you think SMT for low-cost production, think of Mini-Circuits' low-cost SCM mixers.

finding new ways ...
setting higher standards

Mini-Circuits

A Division of Scientific Components Corporation
P.O. Box 350166, Brooklyn, New York 11235-0003 (718) 934-4500
Fax (718) 332-4661 Domestic and International Telexes: 6852844 or 620156

SPECIFICATIONS (typical)	SCM-1L (with leads)	SCM-1NL (no leads)
FREQ. RANGE (MHz)		
LO, RF	1-500	
IF	DC-500	
CONVERSION LOSS (dB)		
Mid-Band (10-250MHz)	6.3	
Total Range (1-500)	7.5	
ISOLATION (dB)	(L-R)	(L-I)
Low-Band (1-10MHz)	60	45
Mid-Band (10-250MHz)	45	40
High-Band (250-500MHz)	40	35
PRICE	\$2.49 (1,000 qty)	
	\$3.75 (10-49)	

Units are shipped in anti-static plastic "tubes" or "sticks" for automatic insertion.

Your Mind. Our Machines.

Think what you can do when you put your brain to work with the best machines in the business. Pen and raster plotters. Digitizers. Color graphics equipment. Software. Everything you need.

Tools For The Mind. By CalComp.

Put your idea in pictures. In color. Or black-and-white. From simple charts all the way to complex, dense drawings for a multitude of purposes. In continuous rolls. Or one-at-a-time on a single sheet. For professional presentations. And just plain communications.

Start With The Pen Plotter.

CalComp got so good at this mind-machine link, some people think pen plotters are all we make. Well, we happen to make the best of them. They're being used in greater numbers and applications today, wherever computer-generated data might be translated into a picture. For mapping. Schematics. Charts. By mechanical, electrical and electronic minds. And by architects, facilities managers, and many more.

MicroVAX II is a registered trademark of Digital Equipment Corporation. We draw on your imagination. PlotMaster and DrawingBoard are trademarks of CalComp. ColorMaster is a registered trademark of CalComp.

When you're just starting out, start with ease of use in a sound, basic plotter.

The 1040GT series, one of today's most popular pen plotters, means speed and reliability and plots from A to E size. Then later, as your needs grow, that same 1040GT is ready for you.

The Next Logical Step. Raster Plotters.

CalComp delivers twenty-four different versions. Take the 5700 series. These black-and-white wizards will plot

Plotted results from CalComp's PlotMaster, Raster Plotter, Pen Plotter, and ColorMaster.

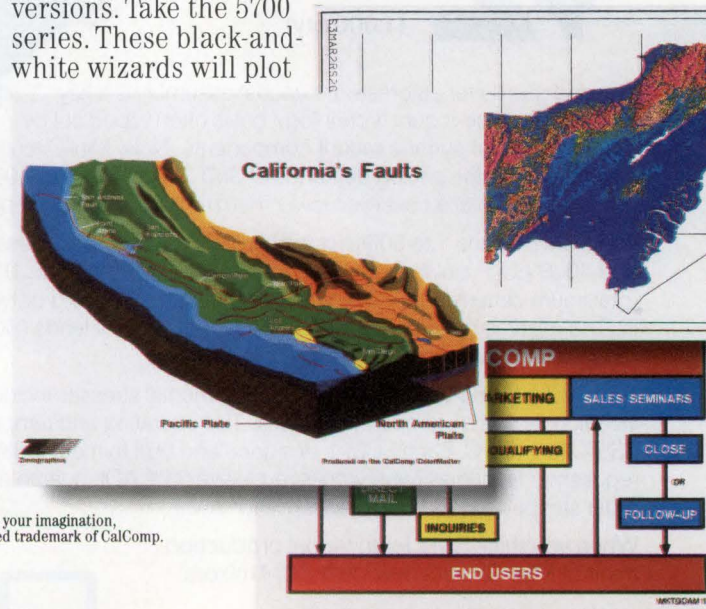



CalComp's Graphics Engine in action.

circles around your office with their speed and sound CalComp reliability.

The top of our line are the clearly colorful 5800s. One thousand twenty-four colors, 256 color intensities or patterns, 400 dots

per inch resolution and integrated vector to raster conversion. Four separate toner stations and multi-passes create full-color images. If monochrome is your metier, one pass makes it happen.

Is Your Business Colorful Enough?

If your business could use some color, our ColorMaster® and PlotMaster™ are two tools for presentation graphics and small size CAD drawings that you can't afford to be without.

Of Course, You'll Need A Digitizer.

No output without input. Sure, you can use your keyboard. But, remember, keyboards were designed for words, not pictures.

On the other hand, our newest digitizer, the DrawingBoard™, is exactly what it says it is. A drawing board. What you put your pen to on the board, you see on the screen. Create your own drawing.

Or trace one.

CalComp, the number one digitizer company in the world, can provide large and small format digitizers. 12" x 12" to table size.

The Graphics Engine Company, Circa 1987.

The DEC MicroVAX II™ Special. A powerful graphics engine system that delivers resolution quality at a low, low price. MicroVAX users may purchase

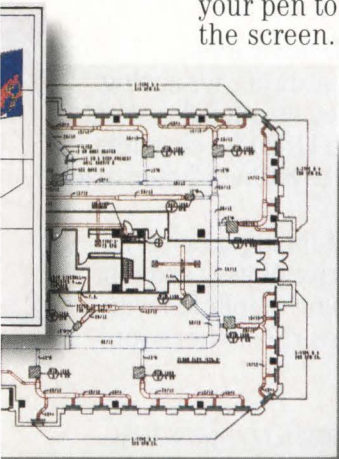

the hardcard alone, or the whole caboose with it—digitizer, high resolution terminal and a mouse.

Machinery For The Mind.

When you're thinking about graphic images of any kind, you can't do better than the best name in the business. From pen plotters to raster plotters. Business and presentation graphics. Input devices, and supplies.

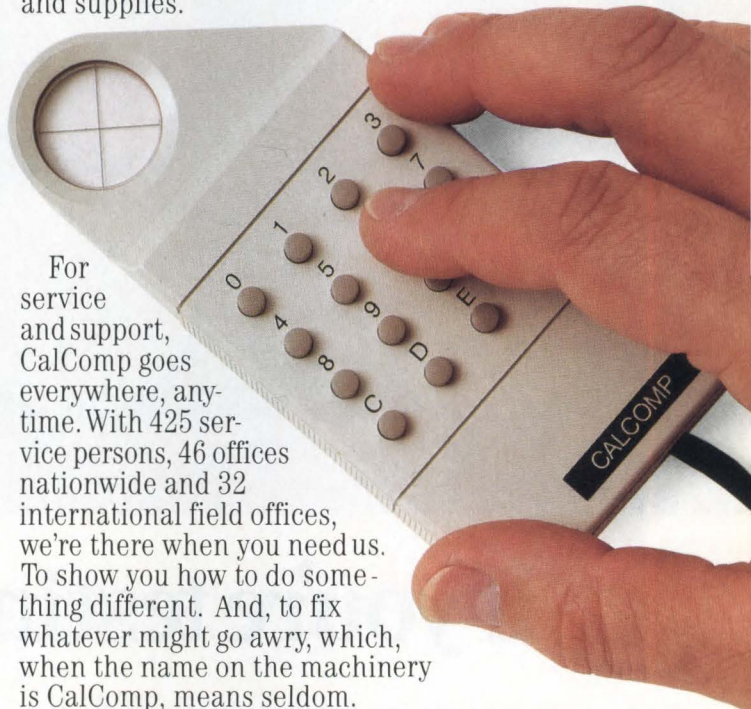

For service and support, CalComp goes everywhere, anytime. With 425 service persons, 46 offices nationwide and 32 international field offices, we're there when you need us. To show you how to do something different. And, to fix whatever might go awry, which, when the name on the machinery is CalComp, means seldom.

Take a good look at computer graphics today and in the future. Call 1-800-CALCOMP or 416-635-9010 from Canada. Or write CalComp, P.O. Box 3250, Anaheim, CA 92803, and we'll send you more information about the machines that work hand-in-hand with your mind.

**We draw on
your imagination.™**



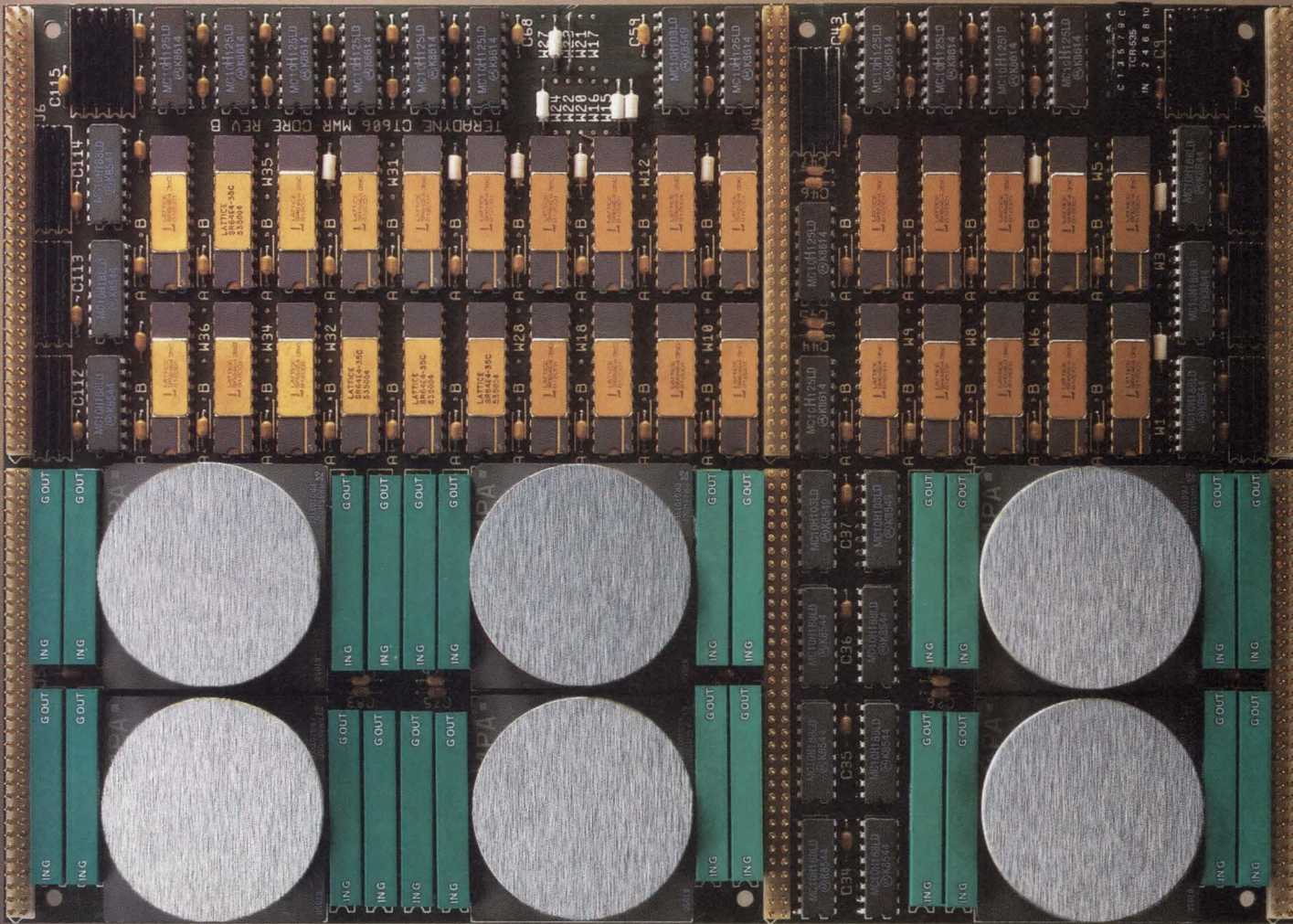

If you're testing complex boards,

You're facing one of test engineering's toughest challenges. VLSI boards like this one. But with a Teradyne L200 board tester on your side, complex test problems can be conquered quickly.



The L293 VLSI Module Test System.

Stay in front of VLSI/VHSIC advances.

Start with the most advanced hardware for analog and digital testing. An L200 fires functional test patterns at 40 MHz rates. At up to 1152 test channels. Top speed is 80 MHz. That's 4 to 8 times faster than any competitor can deliver.

And the L200 hits test signal timing precisely. With up to 32 timing sets for drive phases and test windows. Its 250 ps programming resolution with zero dead time puts signal edges right where you want them.

Divide and conquer.

VLSI/VHSIC boards demand large, complex test programs. But the L200's distributed computer architecture simplifies matters.

Testing is controlled by a VAX computer. It sends tasks to specialized processors for rapid deployment of analog, digital, and memory tests.

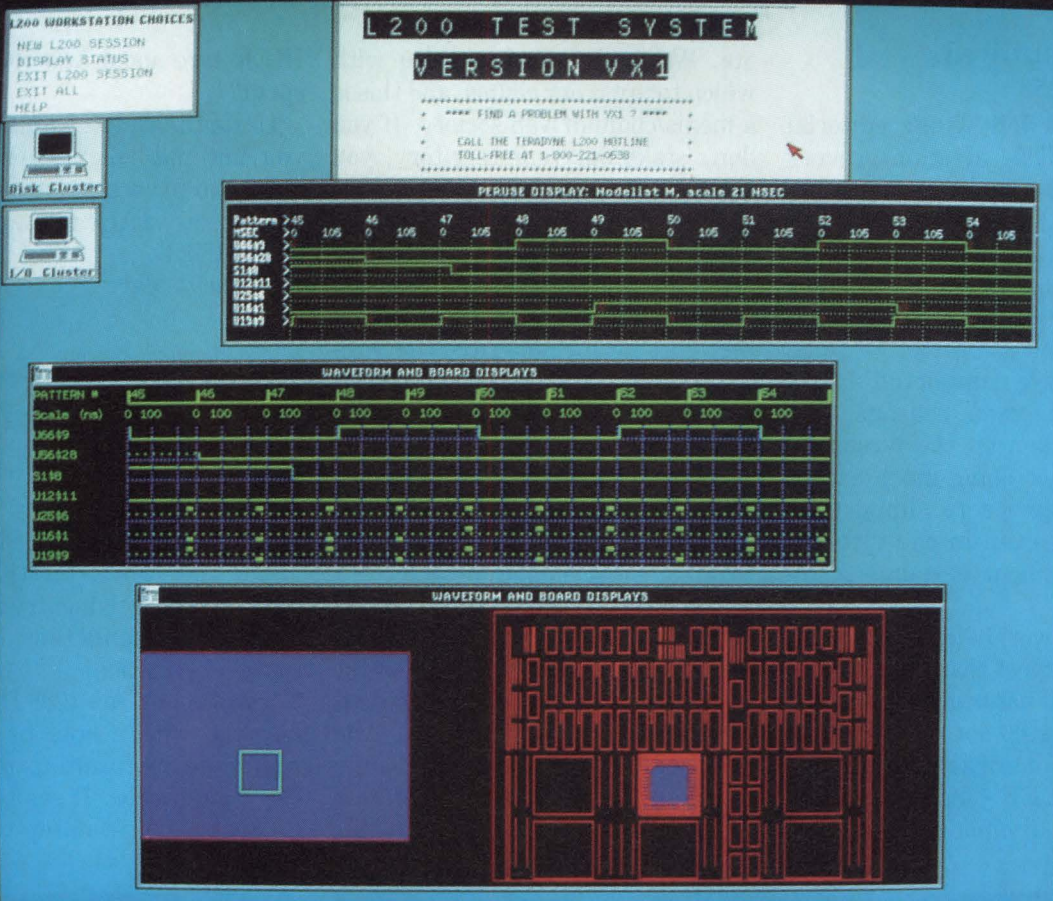

here's a simple plan of attack.

Programmers will appreciate clustered VAX workstations. Graphics, like waveforms and shmoo plots, make heavy debug and analysis light work. **Simulation and other tactics.**

High-powered software tools tailor L200 test development to modern design techniques and test

	Test Channels	Maximum Pattern Rate	Channel Skew
L297	1152	80 MHz	± 1.5 ns
L293	576	80 MHz	± 1.5 ns
L280vx	1152	10 MHz	± 10 ns
L210vx	576	10 MHz	± 10 ns

L200 VLSI board test systems are the performance leaders.

strategies. Precisely the caliber of tools you need to get tests up and running fast. Take our LASAR simulator. It works closely with the L200 for both cluster and board-level testing. LASAR accurately predicts VLSI circuit responses and reports test program fault coverage.

Significantly, LASAR simulates L200 charac-

teristics. So test programs automatically include when to test board responses. And what response is expected. The result is uncompromising go/no go tests as well as precise guided probe or fault dictionary diagnosis.

A powerful ally.

L200's have proven themselves under fire at hundreds of advanced manufacturing sites worldwide. So if you're about to take on a new VLSI/VHSIC project, find out how to launch a winning test strategy. Call Daryl Layzer at (617) 482-2700, Ext. 2808 without delay.



VAX is a trademark of Digital Equipment Corp.

SIGNALS & NOISE

IEEE has outlived its usefulness

I've just read Jon Titus's editorial on the IEEE election-process change ("The IEEE faces extinction," EDN, February 4, 1988, pg 53), and I want to thank him for supporting the working engineer and the Committee of Concerned EEs. I have felt as he does for some time, and have supported Irwin Feerst for the same reasons. The IEEE has taken on the wrong issues and is not doing much except paying lip service to support its membership, even in the international environment it claims to revere.

Engineers worldwide are not afforded the respect that their contributions should naturally attract, because they are not getting the recognition that organizations the size of the IEEE (and its counterparts in other disciplines) can gener-

ate. We do not have a voice with which to press our claims, and this is a media/claim-driven society. If you don't stake out your territory, you don't get it.

I would hate to see the IEEE go, but it has lived beyond its usefulness in its present incarnation. The vast majority of the engineering community does not benefit from the position that the professors and managers who run the IEEE have taken. Engineers need exactly the help Mr Titus mentioned: portable pensions, fair pay, protection as whistleblowers, and the enforcement of tough age-discrimination rules.

The professional journals of the IEEE are so esoteric that I doubt more than a small percentage of the pages are read outside the onerous professional review process. And how can a magazine with the circulation and ad coverage of *Spectrum* lose so much money? Does the

IEEE care about how the money is spent?

Unfortunately, I must ask that you not publish my name if you choose to print this letter. My company is very active in the high levels of the IEEE.

Name withheld

IEEE needs to clean house

Jon Titus's February 4 editorial about the IEEE hit the mark. I have been receiving Irwin Feerst's newsletters, and they have been quite a revelation!

I will renew my 1988 IEEE membership, with a note to the IEEE regarding my future membership in the organization. It seems to need a housecleaning from top to bottom.

"Erector Set"



We'll put this versatile TRU-GLIDE® Series 375QD steel chassis slide together for you but then we offer a wide choice of adjustable mounting brackets and insertable bar nuts to make it easy for you to finish your chassis installation in any standard 19" cabinet. Thin design, low profile, as well as smooth ball-bearing action and quick disconnect features are pleasant alternatives to the cumbersome slip-stick friction slides now in use. Get complete information on this versatile 75-lb. capacity slide series for your own cabinet... and they're off the shelf!

Jonathan Manufacturing Corporation • 1101 So. Acacia Ave., Fullerton, CA 92634 • (714) 526-4651 • TWX: 910-592-1241

Jonathan's extensive line of aluminum slides are industry standards in military and aerospace application - with load ratings to 800 lbs.

THERE'S MORE IN STORE FROM SEEQ.

64K E²PROMs. Now There Are 150 μ A Answers to Your 64K Questions.

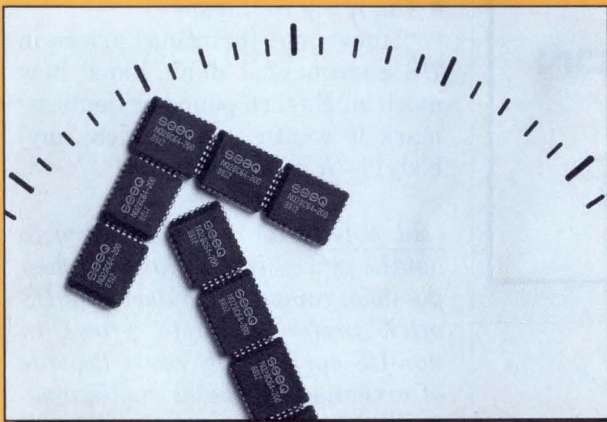

If you're looking for ways to cut the power needs on designs, SEEQ has some high density CMOS answers.

Our byte-wide 28C64s, for example, operate on less than 3/4 watt per Megabyte—about 1/10 the power of competitive parts. In fact, they actually use 150 μ A in standby mode. That's 400 times less than NMOS devices.

With four versions to choose from, our 64K E²s give you exactly those on-chip options you need. That includes peripheral functions—like input latches, times and power up/down protection—that make it easy to interface our E²s to popular microprocessors.

These full-featured E²s outperform the competition, too. In page mode, for instance, you can write our 64Ks in 80 μ sec per byte, which means you can update the entire memory in just 0.7 seconds—four times faster than the industry average.

You still get the high endurance and reliability that SEEQ E²s are known for, as well as operation over extended and full military temperature ranges.

At SEEQ, we have a lot more in store.

SEEQ Technology, Inc., 1849 Fortune Drive, San Jose, CA 95131.

Part	Power	Page Mode	Ready/Busy	Packaging	Screening
52B33 (NMOS)	110 mA (active) 40 mA (stand-by)	No	No	DIP LCC	883 Class B
2864 (NMOS)	110 mA (active) 40 mA (stand-by)	No	Yes	DIP LCC PLCC Flat Pack	883 Class B JAN
28C64 (CMOS)	50 mA (active) 150 μ A (stand-by)	64 bytes	No	DIP LCC PLCC	883 Class B
28C65 (CMOS)	50 mA (active) 150 μ A (stand-by)	64 bytes	Yes	DIP LCC PLCC	883 Class B

Note: All parts have read access time of 200 ns.

**Call Us On It:
(408) 432-9550**

seeq

E² Is Our Middle Name

LCD readability taken to new heights!

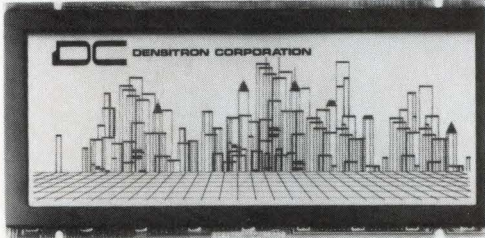

- Fluorescent backlighting and Supertwist technology combine to create the brightest and most dynamic graphic liquid crystal display available today.
- Long life 20,000-hr. fluorescent tube emits a bright, even light.
- Supertwist LCD produces a high contrast display with a wide viewing angle.
- Available in 3 sizes: 400x640, 200x640 and 128x256.
- Available in positive or negative images with white, yellow or blue background.
- Thin package with CMOS drivers.
- Controller cards available.

DC
DENSTRON
CORPORATION

2540 West 237th Street
Torrance, CA 90505
(213) 530-3530
FAX: G2/G3: 213-534-8419
TELEX II: 910-349-6200
Europe/UK: (0959) 76600

CIRCLE NO 23

Programmable positioning

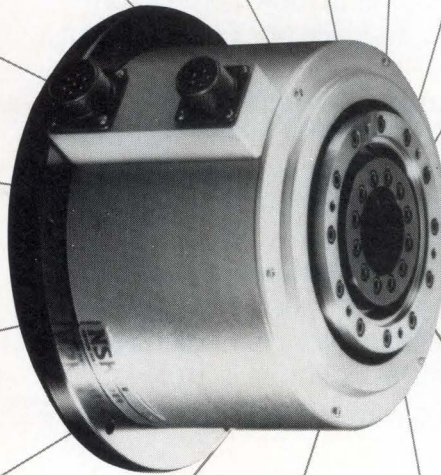

Fast acceleration
Short cycles
Resolution to 614,400
counts per revolution

Program up to 16 moves
through RS232C interface

Precision repeatable position and motion control for robots, indexers, automatic assembly and machining applications. Megatorque is a complete closed-loop servo system with its own position sensor. Low speed, high torque allows direct coupling eliminating loss of accuracy due to backlash. Eliminates speed reducers, gears, encoders, tachometers, bearings or couplings. Five standard diameters from 4" to 14", torque ranging up to 180 lb-ft. Speeds up to 3 rps. (4.5 rps on 4" dia.)

Ask about our other motion and positioning components, ball screws, linear guides and precision positioning tables.

MEGATORQUE®

Electronic, high torque, direct drive, rotary positioning component

Call or write for your FREE comprehensive specifications and literature packet.



NSK PRECISION PRODUCTS DIVISION
420 W. Wrightwood Avenue, Elmhurst IL 60126
Telephone 312-530-5777 FAX: 312-530-8407

©1988 NSK Precision Products



CIRCLE NO 24

SIGNALS & NOISE

I'm also sending a hefty contribution to the Committee of Concerned EEs.

Sidney Feldman
Sound Technique Inc
New York, NY

Readers' comments

- *Service economy*
"Five stars for 'The service-economy myth' [EDN, December 10, 1987, pg 53]! It's just a new term for a very old idea—serfdom."
—C F, Pinole, CA
- *Currency confusion*
"How about [printing] prices in US currency? I don't know how much an English pound or deutsche mark is worth . . . rubles, anybody?"—R R, Nekoosa, WI

(Ed note: Although we do try to obtain prices in US dollars when possible, companies outside the US often prefer to quote prices in non-US currency. Because the rate of exchange fluctuates continuously, it's best to check a major newspaper; most print the exchange rates daily. Major banks can also supply this information quickly.)

And a gracious hello

Oops! You can't reach DigiBoard Inc—of St Louis Park, MN—by calling the New York, NY, phone number listed on pg 293 of EDN's February 18, 1988, issue. The correct phone number is (612) 922-8055.

WRITE IN

Send your letters to the Signals and Noise Editor, 275 Washington St, Newton, MA 02158. We welcome all comments, pro or con. All letters must be signed, but we will withhold your name upon request. We reserve the right to edit letters for space and clarity.

**Gould has features
you won't find at the
ordinary ASIC house.**



A nose to the grindstone.

What do twenty-one years as an ASIC vendor do for your customers? A lot.

Two decades give you the time you need to develop and manufacture over 6000 successful designs. The time you need to accumulate 900 man-years of engineering experience. The time you need to learn things not found in the textbooks.

That's the kind of experience Gould Semiconductors can put to work for you on every circuit you do.

Gould recognized early how valuable the combination of CMOS processes and CAD/CAE technology would be for our customers. We have been an innovator in both of these areas.

6000 DESIGNS
INNOVATOR IN CMOS
900 ENGINEERING MAN-YEARS
21 YEARS IN ASICS

We've also had time to fully develop application-specific IC techniques that still frustrate other vendors. For instance, Gould is an acknowledged industry leader in analog/digital circuit combinations. Many ASIC producers can't even offer them.

The most important advantage to you, though, is that Gould has probably produced a design similar to yours already. We know the problems to look for and how to avoid them. In many cases, we can

recommend easily incorporated features that add value to your system.

That's what twenty-one years of hard work can do for you.

**Manufacturer of Gould AMI
Semiconductors.**



GOULD
Electronics



An ear for your problems.

All ASIC customers want essentially the same things: better system performance, lower system cost, quick development and production cycles. But every ASIC project has a different set of priorities.

Your only guarantee of success is the vendor's sensitivity to your individual needs. For two decades, Gould has

listened and responded with strategies to provide the best system solution. The ASIC Continuum is one such strategy.

The ASIC Continuum provides a design solution effective for any application. There are low-cost E²PLDs for instant prototypes and small volume production applications. Also gate arrays for fast prototyping

LOW COST

FASTER DELIVERY

EASIER DESIGNS

SPECIAL NEEDS

and cost-effectiveness over a broad range of volumes.

More advanced implementations get standard cell or cell-based custom circuits. These are ideal for analog/digital combinations, high-density systems and other circuits requiring special performance characteristics.

We are also meeting your needs with expert-based design aids. Extensive cell

and macro families for PCs and workstations. A full-service design group. And more comprehensive programs to give you the best ASIC solution.

Manufacturer of Gould AMI Semiconductors.



GOULD
Electronics

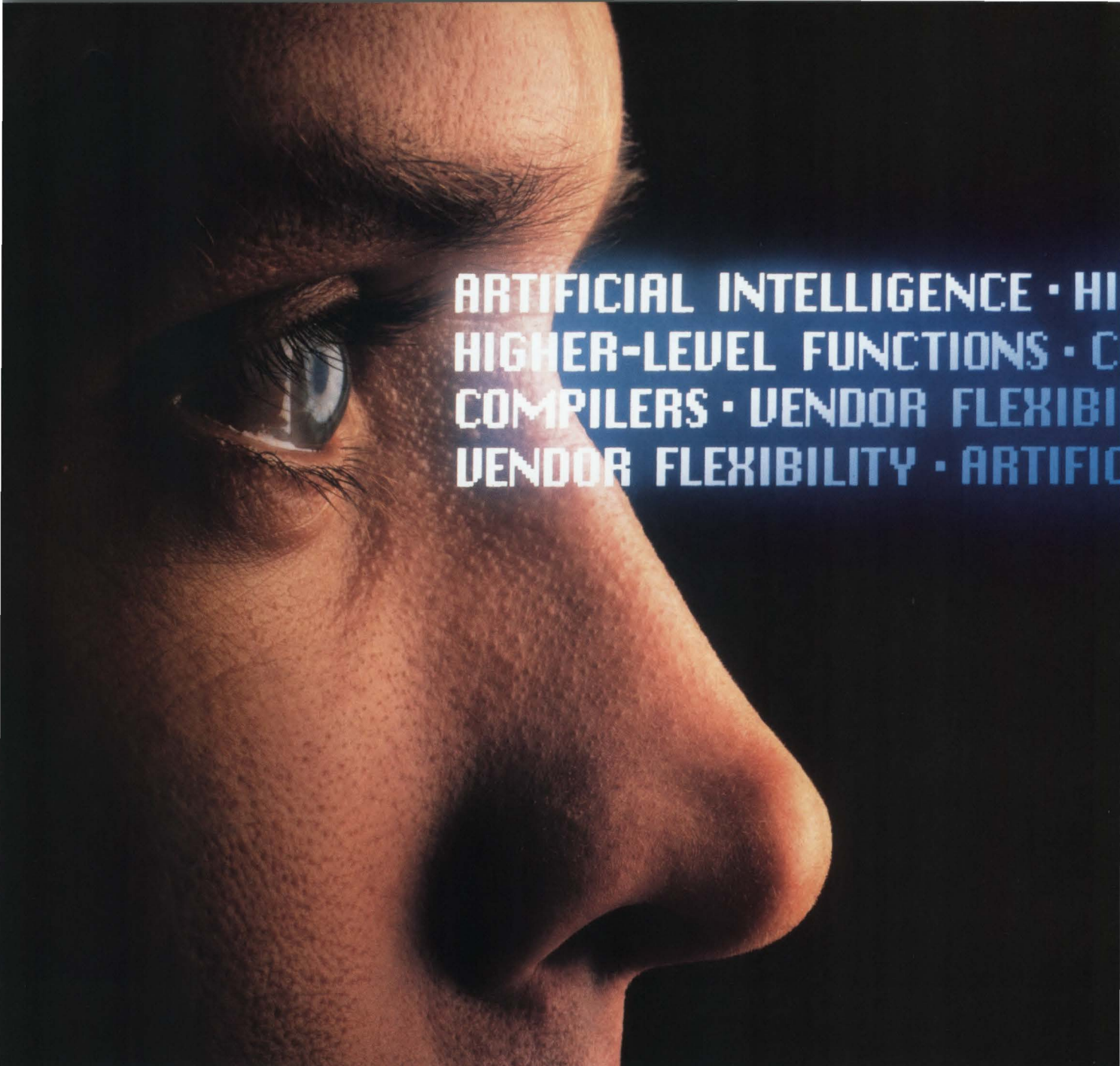

ARTIFICIAL INTELLIGENCE • HI
HIGHER-LEVEL FUNCTIONS • C
COMPILERS • VENDOR FLEXIBI
VENDOR FLEXIBILITY • ARTIFICIO

An eye on the future.

The pressure on system designers will continue to be intense. Gould has responded by cutting development spans, increasing functions and performance. And now we're using artificial intelligence (AI) to go even further.

Already Gould Expert Systems™ tools are adding value for system designers.

AI-based generators and compilers create cells in days instead of weeks. Standard cells. ROMs. RAMs. Even analog cells, like op amps and filters. And these tools are process independent, making our libraries some of the easiest to tailor to your needs.

Going a step further, megacell compilers create large custom functions (bit-slice

ER-LEVEL FUNCTIONS · COMPILERS · VENDOR FLEX
PILERS · VENDOR FLEXIBILITY · ARTIFICIAL INTELL
Y · HIGHER-LEVEL FUNCTIONS · COMPILERS · VENDO
L INTELLIGENCE · HIGHER-LEVEL FUNCTIONS · COM

μ Ps, DSPs, etc.) in half the space of standard cells. And our newest Expert ASIC tool, Circuit Cincher,[™] finds logic errors missed in simulation, so you get silicon that's right the first time.

A Gould exclusive is Netrans[™] universal netlist translator. This single tool makes Gould a ready alternate source for any ASIC you do. No matter who your primary vendor is. Use any CAD/CAE system and cell library you want: our Netrans translator

will convert your netlist for production at Gould. That's true vendor flexibility.

Come see how Gould's Expert ASIC tools can play a major role in your future.

**Manufacturer of Gould AMI
Semiconductors.**



GOULD

Electronics

3400 hands to help you succeed.



Gould ASIC professionals are dedicated to giving you the best system solution. And a competitive edge found nowhere else. We invite you to come meet our team. Once you see what we can do for you, you'll choose Gould hands down.

Shouldn't you find out more about us? Just return the Gould business reply card adjacent to this ad. If someone beat you to it, write: Gould Inc., Semiconductor Division, 3800 Homestead Road, Santa Clara, CA 95051, Attn: N. Greene.

If we receive your card or letter by May 31, 1988, you will be entered in a sweepstakes to *win one of ten compact disk players**. To get information faster, call 1-800-GOULD 10.

**Manufacturer of Gould AMI
Semiconductors.**



GOULD
Electronics

Solutions to Your Design and Management Problems from **TPR** TAB Professional and Reference Books

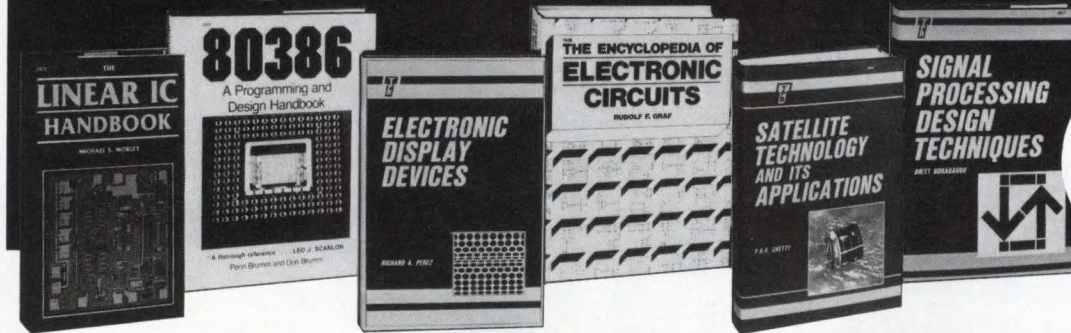

Examine
FREE
for 15 Days!

80386—A PROGRAMMING AND DESIGN HANDBOOK.

P. Brumm and D. Brumm. Preview everything Intel's 386 has to offer including: memory paging, debugging applications, the Virtual 8086 Mode, and 32-bit instruction enhancements. Features actual software applications for entering into the protected mode. "The Brumms have produced a thorough reference for the 80386. Programmers and hardware designers alike should find it a valuable addition to their technical libraries." —Leo J. Scanlon, bestselling author **\$29.95**
To order, Circle No. 25 for free 15-day exam

NEW

SATELLITE TECHNOLOGY AND ITS APPLICATIONS.

Dr. P.R.K. Chetty. A rich source of proven designs and applications, this illustrated handbook covers system descriptions, data, formulas, structural systems, and more. Highlighted with actual international application examples ranging from communications to weather. **\$39.95**
To order, Circle No. 174 for free 15-day exam

WIRING AND CABLE DESIGNER'S HANDBOOK. *B.S. Matisoff.*

Comprehensive and complete, this reference includes all the data you need to design and manufacture reliable cable and wiring assemblies. Includes charts and tables of design and manufacturing parameters for specific conductor requirements. **\$32.50**
To order, Circle No. 224 for free 15-day exam

THE ENCYCLOPEDIA OF ELECTRONIC CIRCUITS. *R.F. Graf.*

Designed for quick-reference and on-the-job use, this well-illustrated source puts over 1,700 of the most useful and versatile state-of-the-art circuit designs in the industry at your fingertips—nearly 100 circuit categories from A to Z. "The drawings are all clear and distinct, and include part numbers and notes for users . . . Highly recommended."—Choice To order, Circle No. 225 for free 15-day exam **\$60.00**

NEW

INTEGRATED LOGISTICS SUPPORT HANDBOOK. *J.V. Jones.*

Written by an ILS expert who helped develop DoD policies, this handbook is essential for dealing with ILS regulations. Covers contracts, equipment repair/replacement, technical documentation development, and the use of computers. **\$42.95**
To order, Circle No. 226 for free 15-day exam

SWITCH-MODE POWER SUPPLY DESIGN. *P.R.K. Chetty.*

Effectively utilize power electronics with this state-of-the-art sourcebook. Highlighted with actual application examples, it covers practical hardware design, techniques for improving reliability, and the use of pulse width modulator ICs. **\$22.95**
To order, Circle No. 227 for free 15-day exam

SIGNAL PROCESSING DESIGN TECHNIQUES. *B. Rorabaugh.*

Exploring both signal processing theory and practical design methods, this invaluable reference is a must for engineers, technicians, and circuit designers. Includes more than 200 diagrams, schematics, and tables. To order, Circle No. 228 for free 15-day exam **\$32.50**

FIBEROPTICS—A REVOLUTION IN COMMUNICATIONS—2ND EDITION. *J.A. Kuecken.*

Stay on top of the latest advancements in fiberoptics theory and the development of useful applications. Covers speech digitizing, fiberoptic connectors, LANs, and more. **\$28.95**
To order, Circle No. 229 for free 15-day exam

HANDBOOK OF ELECTRICAL NOISE MEASUREMENT AND TECHNOLOGY—2ND EDITION. *C.A. Vergers.*

Fully supported by equations, examples, drawings, and diagrams, this updated sourcebook provides an exhaustive examination of electrical noise. Includes methods for reducing noise levels. **\$39.95**
To order, Circle No. 230 for free 15-day exam

NEW

ELECTRONIC DISPLAY DEVICES. *R.A. Perez.*

This one volume covers all types of commercially available electronic display devices—VFDs, ELDs, LCDs, LEDs, Plasma displays and more. An essential tool for making the best display selection for your needs. **\$39.95**
To order, Circle No. 231 for free 15-day exam

NEW

AUTOCAD®: METHODS AND MACROS. *J. Guenther, E. Ocoboc, and A. Wayman.*

Illustrated with working examples, this definitive guide builds a solid understanding of the features, commands and capabilities of AutoCAD. Covers third-party software interfacing, macros, menus and more. **\$29.95**
To order, Circle No. 232 for free 15-day exam

NEW

VERSACAD® TUTORIAL: A PRACTICAL APPROACH TO COMPUTER-AIDED DESIGN. *C. Buehrens.*

This hands-on tutorial features tried-and-true techniques applicable to all versions of the software including releases 4.0, 5.0, 5.1, 5.2 and Omnidraft Version 1.0. Examples include over 300 illustrations to aid in understanding and applying each technique. **\$28.95**
To order, Circle No. 233 for free 15-day exam

THE LINEAR IC HANDBOOK. *M.S. Morley.*

Gain instant access to specifications, prices, and other vital data on the full range of linear integrated circuits from all the major manufacturers. Enables you to evaluate alternative circuit design approaches and techniques for design. To order, Circle No. 234 for free 15-day exam **\$49.50**

TO ORDER FOR 15-DAY, FREE EXAM: Simply circle the appropriate number(s) on the Reader Service Card at the back of this magazine—limit of 3 for free trial. Your book(s) will be sent to you for your 15-day exam. If you are satisfied, keep the book(s) and pay the purchase price plus postage and handling. Otherwise, return the book(s) by the end of the 15-day period and owe nothing.



NEW FROM TEK: ANALOG FUNCTION, ARBITRARY WAVEFORM AND SWEEP GENERATION IN ONE COMPACT PACKAGE.

The Tek AFG 5101 Programmable Arbitrary/Function Generator is the latest addition to Tek's TM 5000 family of proven, programmable, modular test instruments.

An analog function generator, the AFG 5101 can generate standard sine, square and triangle waveforms, plus dc level, with frequencies from .012 Hz to 12 MHz and amplitudes of 10 mV to 9.99V peak-to-peak, into 50 ohms. Waveforms can be continuous, triggered, gated or burst, from a

full range of triggering modes.

With synthesizer option, the AFG 5101 achieves frequency accuracies to .005% (120 Hz to 12 MHz) over and above the .2% frequency accuracies in the standard instrument.

An arbitrary waveform generator, the AFG 5101 uses two independent 12-bit by 8K waveform memories to build any imaginable signal from an array of 8,192 horizontal addresses and 4,096 vertical addresses. Enter the waveforms manually from the front panel, from computer data—or select one of the unit's predefined, 1,000-point waveforms.

A sweep generator, the AFG 5101 includes linear,

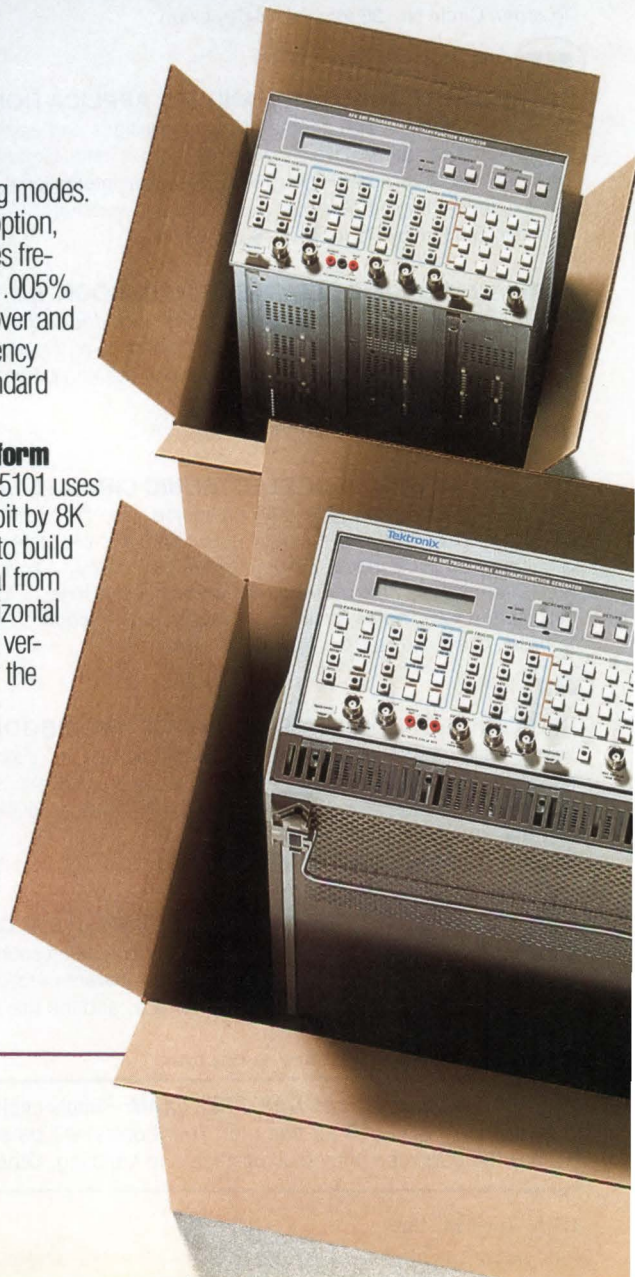

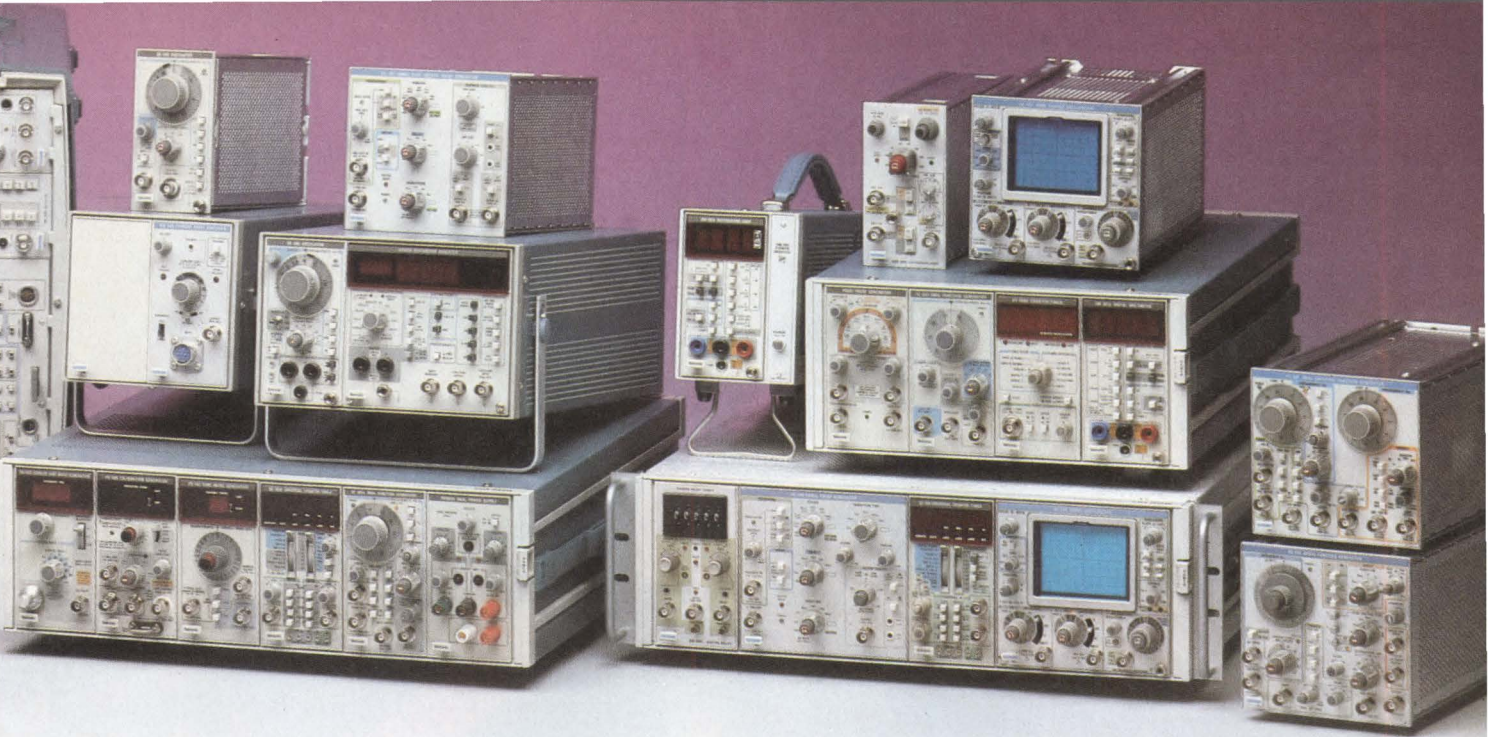

logarithmic and arbitrary sweeps, with any sweep usable in continuous, triggered, gated or burst mode. Users can receive instant frequency readout of breakpoints, notches, or response anomalies.

The applications are wide open. Use the AFG 5101 to drive sensors, timers, and other R&D equipment. To simulate metal stress or vibration characteristics. To teach waveform theory to students. And much more.

Easy waveform editing capabilities... non-volatile storage of up to 99 front panel settings and two 8K point waveforms... binary block GPIB transfer... two waveform memories plus third, execution memory—these and other features make the AFG 5101 a simple, powerful and uniquely flexible tool.

AVAILABLE IN THREE CONFIGURATIONS.

The first triple-duty test instrument of its kind, it is available in monolithic (AFG 5501), as a plug-in (AFG 5101), or in our Programmable Arbitrary Stimulus/Masurement package (EBS 5002).

Take 10% off with our package offer. Order the AFG 5101 in our Programmable Arbitrary Stimulus/Masurement package and take 10% off catalog prices.

For the full story on these and other Tek modular instruments, call 1-800-426-2200. Or contact your nearby Tektronix field office.

(Center photo) The AFG 5101 can be ordered in either monolithic version, top right, or as a plug-in for the TM 5000 series mainframes, top left. Or, combine it with the DM 5010 4.5 Digit Multimeter and DC 5009 135 MHz Digital Counter within a TM 5006 mainframe (EBS 5002), as shown at bottom, and take 10% off the normal catalog price.

Tektronix
COMMITTED TO EXCELLENCE

CIRCLE NO 26



MOTOROLA



ORATES

Silicon talks.

The most popular communication protocols are available in silicon to simplify your designs.

With protocol controllers from Motorola, designing data communications is easier and their markets are more universal than ever before. Standard protocols are built into silicon so there's no need to burden your host. Built with Motorola's proven HCMOS technology, they offer the reliability you've come to expect and the advanced designs you demand.

Communicate now with our family of protocol controllers.

Our MC68000 Family offers three different protocol controllers to handle all your data communication needs; whether it's across the building or around the world there's a Motorola device that will make your job easier. With our '68000 Family you can choose the protocol and system designs that get you on line quickly and economically.

X.25 Protocol Controller 1984 CCITT X.25 LAPB.

The MC68605 Protocol Controller (XPC) implements the 1984 CCITT Recommendation X.25 Link Access Procedure Balanced (LAPB) for U.S. and European T1 applications. By generating link-level commands and responses, the XPC relieves the host processor of communication link managerial tasks. It's also fully DDN and Telenet certifiable.

Our XPC features an optional transparent mode which allows the implementation of other HDLC-based protocols, with user generation of all frames. The XPC handles full-duplex synchronous serial data rates up to a maximum 10 Megabits Per Second (Mbps) for high-speed computer links.

Multi-link LAPD Controller CCITT Q.920/Q.921 LAPD.

The MC68606 Multi-link LAPD (MLAPD) Protocol Controller fully implements CCITT Recommendation Q.920/Q.921 Link Layer Access Procedure (LAPD) protocol for ISDN networks. The MLAPD is designed to handle both signalling and data links in high-performance ISDN primary rate applications.

This VLSI device provides a cost-effective solution to ISDN link-level processing with simultaneous support for up to 8K logical links. The MC68606 is an intelligent communications protocol

controller compatible with AT&T specifications for ISDN devices and features low power consumption and high performance, with an aggregate data rate in excess of 2.048 Mbps.

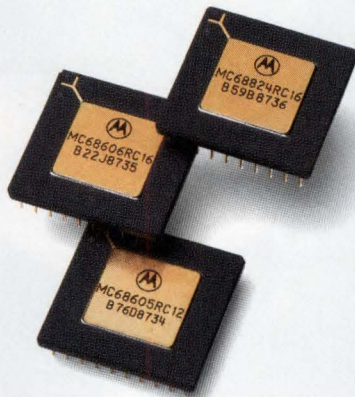

Token Bus Controller IEEE 802.4 MAC.

The MC68824 Token Bus Controller (TBC) is the only single-chip solution to implement the IEEE 802.4 Media Access Control (MAC), specified by Manufacturing Automation Protocol (MAP). The TBC implements four levels of message priority and the Request With Response (RWR) frame type to meet the real-time needs of factory floor communications and MAP 3.0.

The TBC conforms to the IEEE 802.4G standard MAC to Physical layer serial interface to support broadband, carrier-band, and fiber optic networks. The TBC's low power consumption coupled with its extended temperature range versions make it ideally suited for factory automation applications.

Token Bus Frame Analyzer Software speeds development of token bus networks.

The MC68KTBEA Token Bus Frame Analyzer Software (TBFA) is a real-time software tool that speeds development of token bus networks. The TBFA keeps track of statistics while monitoring network performance. By using the simple menu-driven interface, the user can define triggers to selectively store and display frames, creating a powerful tool for network analysis.

The TBFA is a set of four EPROMs which runs on a VMEbus MVME372 Token Bus Controller board and requires a modem, a VT100 terminal, and a power source. The cost-effective TBFA sells for about one-tenth the cost of existing token bus protocol analyzers.

One-on-one design-in help.

Get an engineer-to-engineer update on designing-in Motorola's M68000 Family of protocol controllers.

1-800-521-6274

Call toll-free any weekday,
8:00 a.m. to 4:30
p.m., M.S.T. If the
call can't cover
your needs, we'll
have a local applica-
tions engineer
contact you.

We're
on your
design-in
team.



MOTOROLA

To: Motorola Semiconductor Products, Inc.
P.O. Box 20912, Phoenix, AZ 85036

Please send me information on the following:
 MC68606 Multi-link LAPD Protocol Controller MC68824 Token Bus Controller
 MC68KTBEA Token Bus Frame Analyzer MC68605 Protocol Controller (X.25)

Name _____ 335EDN041488
Title _____
Company _____
Address _____
City _____ State _____ Zip _____
Call me (_____) _____

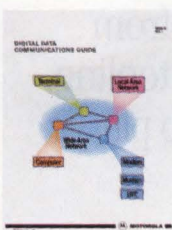

Some of the most sensitive components in satellites and telescopes are shipped and stored in reusable containers we custom-design. So before they travel the vacuum of space, they travel the earth in Hardigg.

Proven protection.

Protecting these components in an extremely dry environment, that could also withstand shock up to 30g's, were two of the stringent requirements Hardigg containers met and exceeded. And just one of many problems we've solved for customers over the last 20 years.

All Hardigg containers are custom-engineered inside and out. To meet all critical specs including humidity and temperature extremes. Every container one-piece rotationally molded for superior strength and wear. Just like the one we designed specifically for a delicate diagnostic component to a CAT Scan system.

Proven performance.

Nearly 200 off-the-shelf sizes are easily customized

Before they travel at 17,500 MPH, they travel in Hardigg containers.

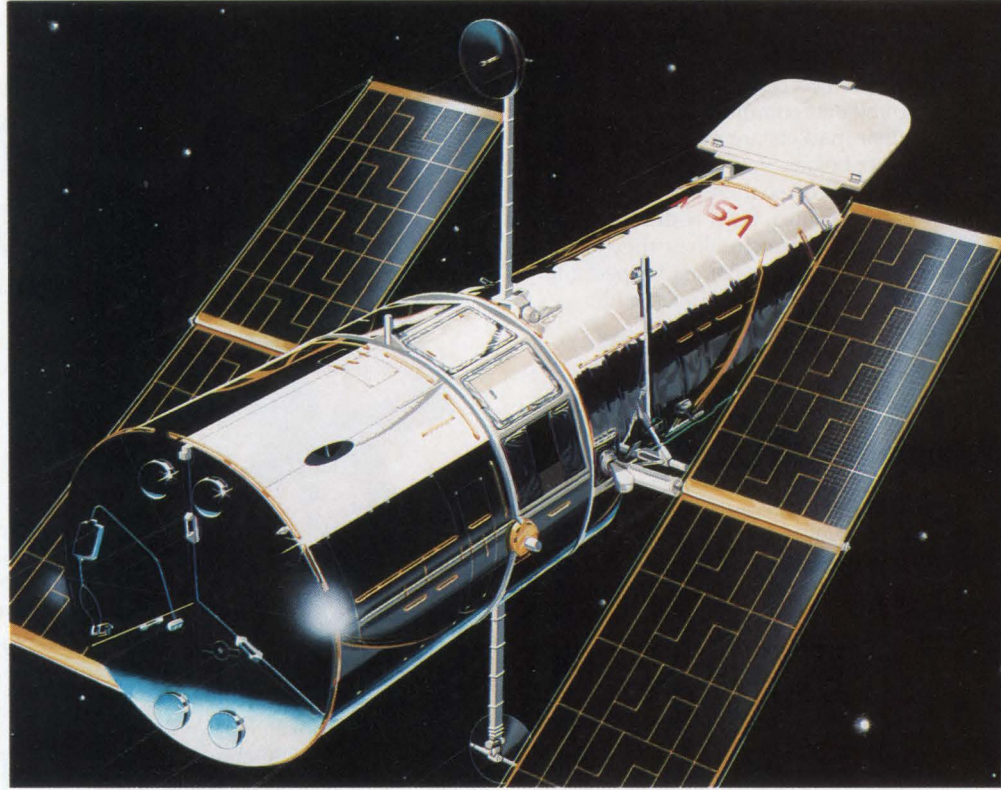

by a top-flight staff of shock-mitigation and environmental engineering specialists. With state-of-the-art equipment and facilities that allow us to control every aspect of the manufacturing process—from mold making to tooling, metal working to plastic fabrication.



So before you send your next product on a journey—across the country or around the world—call the container company that's a proven traveler, Hardigg.



**HARDIGG
INDUSTRIES, INC.**

PROTECTION BY DESIGN
P.O. Box 201
North Main Street
South Deerfield, MA 01373
(413) 665-2163
Facsimile (413) 665-4801

PHILIPS IR LED'S SPEED AND ENDURANCE

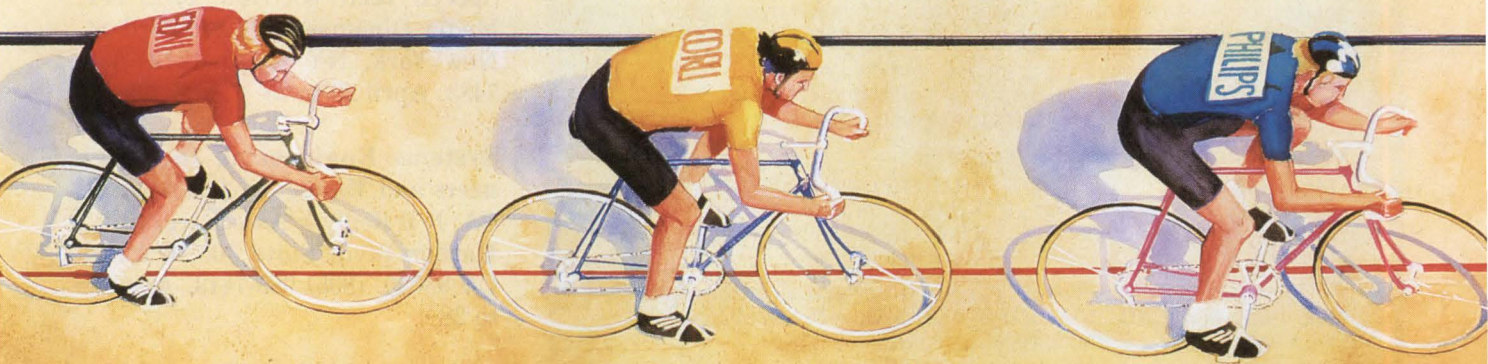

INTRODUCING THE FASTEST, LONGEST LASTING INFRARED LED EVER MADE.

Still going strong after 10,000 hours. Philips brings you the world's first infrared LEDs based on a single heterojunction gallium aluminum arsenide technology. A new technology that allows them to operate at 80% of their initial intensity after 10,000 hours of continuous operation. When you get that kind of longevity in your remote controls, why settle for anything less?

New technological advantages; Faster response (50ns). Complementary technology for use with existing circuits. Ability to operate at low and high currents makes them well suited to carrier frequencies up to 1MHz. 830nm emission wavelength for standard photodiodes and transistors, 740nm for integrated photoreceivers. Available in 3mm, 5mm and flat pack packages. In stock now.

GET THE JUMP ON YOUR COMPETITION

Call (401) 232-0500, ext. 267 or write for information on how to obtain free product samples and specifications on our new heterojunction GaAlAs infrared LEDs.

Name _____
Title _____
Company _____
Address _____
City _____ State _____ Zip _____
Telephone/ext. _____

Mail to: Amperex Electronic Company EDN041488
A Division of North American Philips
Providence Pike
Slatersville, RI 02876
ATTENTION: Marketing Communications

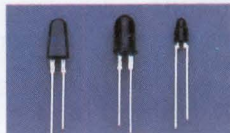

Amperex®

OPTOELECTRONIC PRODUCTS GROUP

PHILIPS



See us at Electro Booth Nos. 1356-1358

CIRCLE NO 27

Amperex Electronic Corporation, George Washington Highway, Smithfield, RI 02917, (401) 232-0500.
In Canada: Philips Electronics Ltd., 601 Milner Ave., Scarborough, Ontario M1B 1M8, (416) 292-5161

"MATHCAD IS THE BEST THING TO HAPPEN TO THE ENGINEER SINCE THE POCKET PROTECTOR."

— PC Magazine

For problems involving engineering calculations or scientific analysis, the answer is MathCAD.[®]

MathCAD is the only PC-based software package specifically designed to give technical professionals the freedom to follow their own scientific intuition. You decide how to solve the problem — MathCAD does the "grunt work."

- Ends tedious programming and debugging.
- Displays instant answers as you change variables.
- Generates quick plots to help you view results.

MathCAD includes such built-in features as:

- Matrix operations
- Simultaneous equation solver
- Real and complex numbers
- Dynamic error flagging
- Automatic unit conversions
- Greek character set
- Fast Fourier Transform and much more

To find out what MathCAD can do for you, call us today for a **free demo disk: 1-800-MathCAD** (in MA, 617-577-1017). Or write to MathSoft, Inc., One Kendall Square, Cambridge, Massachusetts 02139.

Requires IBM[®] PC or compatible, 512KB RAM, graphics card.

Math Soft
 $\Sigma + \sqrt{-} = \times \int \div \delta$
 Software Tools for Calculating Minds

CIRCLE NO 30

The Amazing **\$29.75*** Industry Standard DC/DC Converters



*U.S. prices in 1000s

Amazingly Low Prices, Amazingly High Performance, and they're pin-for-pin replacements for over 30 "competitive" models. Our PWR5104/05 DC/DC converters are setting the standards. Just \$29.75 each in 1000s buys you a full 9W of output power at $\pm 12\text{VDC}$ or $\pm 15\text{VDC}$, maximum ripple and noise of only 35mVp-p, and 0.02% line/load regulation.

Add features like input and output filtering, six-sided shielding, $\pm 0.5\%$ accuracy, and an operating temperature of -40°C to $+100^\circ\text{C}$. Then, top off the list with high barrier voltage and low barrier leakage, designed to meet UL544, VDE750, and CSA C22.2, and the exclusive use of surface-mounted components and assembly techniques for ruggedness and long-term reliability. Now you can start to see the real value that typifies the PWR5104/05 devices and our entire line of over 450 models.

For more information on these amazing \$29.75 bargains or our other DC/DC converters, write or call Burr-Brown Corp., P.O. Box 11400, Tucson, AZ 85734. 602-746-1111.



Your Partner In Quality

CIRCLE NO 31

CALENDAR

Troubleshooting Microprocessor-Based Equipment and Digital Devices (seminar), Cincinnati, OH. Micro Systems Institute, 73 Institute Rd, Garnett, KS 66032. (800) 247-5239; in KS, (913) 898-4695. April 25 to 28.

Speech Tech '88, New York, NY. Media Dimensions, 42 E 23rd St, New York, NY 10010. (212) 533-7483. April 26 to 28.

Systems Engineering for Engineers and Managers, Los Angeles, CA. N B Reilly & Associates, 4220 S Harbor Blvd, Suite 305, Oxnard, CA 93030. (805) 985-7413. April 26 to 28.

Analog Applications (seminar), San Diego, CA. Precision Monolithics Inc, (800) 843-1515. April 28.

Uninterruptible Power Systems: Design, Selection, and Specification (short course), Milwaukee, WI. Center for Continuing Engineering Education, University of Wisconsin-Milwaukee, 929 N 6th St, Milwaukee, WI 53203. (414) 227-3120. April 28 to 29.

Analog Applications (seminar), San Jose, CA. Precision Monolithics Inc, (800) 843-1515. April 29.

AutoCAD Expo, Chicago, IL. Autodesk, 2320 Marinship Way, Sausalito, CA 94965. (415) 332-2344. May 2 to 5.

Midwest Electronics Expo, St Paul, MN. MG Expositions Group, 1050 Commonwealth Ave, Boston, MA 02215. (617) 232-3976. May 3 to 5.

CASEXPO Spring, Dallas, TX. CASEXPO Spring Coordinator, 3825-I South George Mason Dr, Falls Church, VA 22041. (703) 845-1657. May 3 to 6.

Capture Your Solutions

With SCHEMA PCB LAYOUT and SCHEMA AUTOROUTER



Introducing The SCHEMA Family Of Integrated CAE Solutions.

Omation, the originators of SCHEMA I and II, announces two new solutions in the SCHEMA family of integrated software for the professional PCB design engineer — SCHEMA PCB LAYOUT and SCHEMA AUTOROUTER.

Now, you can enter a schematic using SCHEMA II, then process it with SCHEMA-PCB and SCHEMA-ROUTE into a finished printed circuit card — *from start to finish in one easy step.*

SCHEMA-PCB and SCHEMA-ROUTE operate on an IBM personal computer or compatible, yet they offer all the features of design work-stations costing \$50,000 or more *for a fraction of the cost:*

- Boards of over 400 equivalent ICs, up to 32" x 32", and up to 30 layers
- Resolution on placement and tracking of 1 mil
- Autoplacement
- Selectable track width and pad size/shape (250 increments of 1 mil each)
- Integrated schematic input and back annotation
- Entry of engineering changes at the schematic level
- Autorouting with 4 separate algorithms for accuracy
- Complete manufacturing kit output
- 'Air Gap' and connectivity design rule checking

As always, each member of the SCHEMA family of products comes with a *30-Day Money Back Guarantee.*

Capture your solutions by calling us Toll Free: **1-800-553-9119** (in Texas, 214-231-5167). Ask us about our SCHEMA Family Demo Evaluation Kit.



OMATION

1210 E. Campbell Rd., Suite 100
Richardson, Texas 75081

CIRCLE NO 32

A Breakthrough in Higher Performance.

CMOS/DMOS

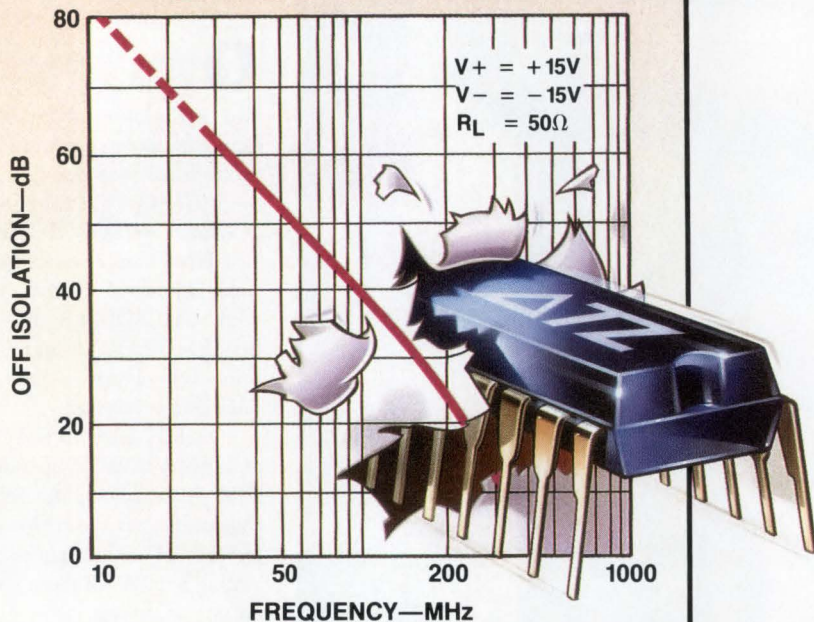

Topaz combines the best of CMOS and DMOS: high off-isolation at frequencies up to 250 MHz with low insertion loss, achieved only through DMOS, and the low-power control circuitry of CMOS.

Our CMOS/DMOS ICs are available in 1x, 2x and 4x SPST analog switches, 2x SPDT with latches, and 4-to-1 multiplexers, all available in standard DIPs and S.O. packages.

Data sheets are available on Topaz CMOS/DMOS products as well as our full line of DMOS FETs, high-frequency analog switches and digitally controlled attenuators. Break through the performance barrier with Topaz products.



TOPAZ
SEMICONDUCTOR

Topaz Semiconductor, 1971 N. Capitol Avenue, San Jose, CA 95132-3799
 TEL (408) 942-9100 TWX 910-338-0025 FAX (408) 942-1174

CIRCLE NO 33

CALENDAR

Analog Applications (seminar), Los Angeles, CA. Precision Monolithics Inc, (800) 843-1515. May 4.

Pittsburgh Conference on Modeling and Simulation, Pittsburgh, PA. William Vogt or Marlin Mickle, 348 Benedum Engineering Hall, University of Pittsburgh, Pittsburgh, PA 15261. May 5 to 6.

Worst-Case Circuit Analysis (seminar), Washington, DC. Design and Evaluation, 1000 White Horse Rd, Suite 304, Voorhees, NJ 08043. (609) 770-0800. May 9 to 11.

Electro '88, Boston, MA. Electronic Conventions Management, 8110 Airport Blvd, Los Angeles, CA 90045. (800) 421-6816; in CA, (213) 772-2965. May 10 to 12.

EMC Expo, Washington, DC. Karen Smith, EMC Expo, Box D, Gainesville, VA 22065. (703) 347-0030. May 10 to 12.

Analog Applications (seminar), Chicago, IL. Precision Monolithics Inc, (800) 843-1515. May 13.

DOD-STD-2167A and DOD-STD-2168—Defense System Software Development (seminar), Washington, DC. David Maibor Associates, Box 846, Needham, MA 02194. (617) 449-6554. May 16 to 17.

IEEE Custom Integrated Circuits Conference, Rochester, NY. Roberta Kaspar, 20 Ledgewood Dr, Rochester, NY 14615. (716) 865-7164. May 16 to 19.

DID YOU KNOW?

Half of all EDN's articles are staff-written.

EDN

0 to 60 in 5 seconds



with new UniLab 8620 analyzer-emulator.

- 64Kbytes from hard disk in 5 seconds. That's moving. But today you've got to be fast just to stay in the race for better micro-processor designs.

- The secret is a new, high-speed parallel interface: the Orion bus. Which zips data between your PC/AT and the 8620 analyzer-emulator, breaking the RS-232 bottleneck.

- The 8620 with O-bus gives you complete program diagnosis — and solutions — in real time. For more than 150 different micro-processors. Using the same command set environment.

- A generous 2730 trace-cycle buffer with selective filtering lets you cut through the clutter and display just the traces you wish. And you get μ sec resolution in program time measurement. Plus continuous InSight monitoring of your program's key functions as they are performed.

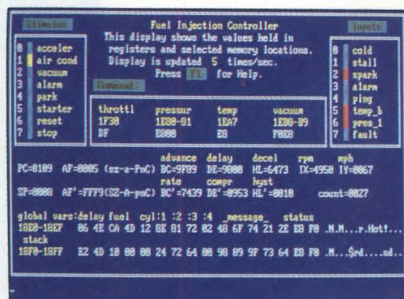

InSight Display. InSight blends analyzer-emulator techniques to give you continuous, real time monitoring of key processor functions. And still services user interrupts. It displays changing register contents, I/O lines, ports, user-defined memory windows. With your own labels.

- On top of that, you get UniLab's trademark ability to debug by symptom, not just by breakpoint and single step. And, to help you complete the job on time, on the spot, a stimulus generator and EPROM programmer are included.

- Ease of use, another Orion trademark, is also built in. So you have all the familiar features and formats you're used to working with. It doesn't matter if your project is a single chip controller or complex 16-bit

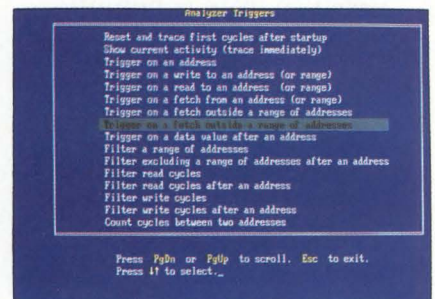

Analyzer Triggers. Commonly used triggers can be selected quickly from a list of standard and user-defined triggers.

microprocessor, the 8620 is the top price/performance analyzer-emulator that does it all. At just \$4380. With processor Personality Paks typically \$550 each.

- UniLab 8620. Fast-lane debugging that gets you to market quicker.

Call toll-free: 800/245-8500.

In CA: 415/361-8883

ORION
INSTRUMENTS

See us at Electro
Booth 2741-45

702 Marshall St., Redwood City, CA 94063
TLX 530942 FAX 415/361-8970

Computer Integrated Instrumentation

DO YOU HAVE WHAT IT TAKES TO MAKE IT BIG IN ASICS?

Not long ago, designing ASICs wasn't even part of your job. Now it's the part everyone's counting on.

That's where Daisy comes in.

Daisy CAE tools are used by more ASIC designers than any other CAE workstations.

Because from schematic creation through post-layout

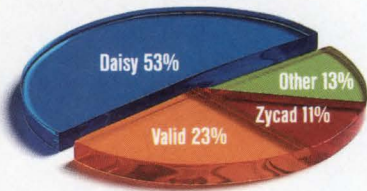

Simulation accelerator market share. Source: Prime Data, 1985 and 1986 unit shipments.

simulation, Daisy has what it takes to keep ASICs on time and on budget.

For example, our MegaLOGICIAN™ simulation

accelerator is seamlessly integrated with the schematic, so you can locate and correct design problems interactively. That means faster debugging and more time to improve the quality of your design. Plus no other accelerator is as well supported,

with more than 170 design kits supplied by 70 different vendors. So you can build productivity instead of libraries.

Which may explain why more MegaLOGICIANs are in use today than all other accelerators combined.

Speaking of combining, you



can share a MegaLOGICIAN with a network of our 386-based desktop workstations, for a high-powered low cost ASIC design environment.

And that's just the beginning.

With our library of more than 4,500 system-level components, you can include your ASIC in complete "real world" system simulations to ensure that your designs will be ready for production, instead of revision.

All of which makes Daisy today's choice for no-sweat ASIC success.

But what about tomorrow?

Gate counts are on the rise. If your tools run out of steam at 5,000 gates, so could your future.

No problem.

Our ASIC design tools glide through 20,000-



gate designs without even breathing hard.

In fact, new design kits already support arrays of over 100,000 gates.

So you'll never have to worry about hitting a dead-end.

But don't take our word for it, listen to what

Rockwell and other industry leaders have to say. For a free copy of "Making It Big In ASICs" call Daisy at 1 (800) 556-1234, Ext. 32. In California, 1 (800) 441-2345, Ext. 32.

European Headquarters:
Paris, France (1) 45 37 00 12.

Regional Offices:
England (256) 464061;
West Germany
(89) 92-69060;
Italy (39) 637251.



NCR keeps standards

Finally,
a cure for SCSI
overheadaches.

NCR's 53C90 is the only chip that can give you fast, fast, fast relief from overheadaches... and that includes the newest "A" and "6250" versions from the competition.

Using combination commands, dedicated sequential logic and dual-ranked registers for command pipelining, the 53C90 is magnitudes faster on and off the bus. Plus NCR implements complex bus sequencing in hardware, not time-wasting software.

Here's our benchmarks. But run your own and you'll see the other guys cause overheadaches, we cure them.



How our data
transfer rates
rate.

You either got great numbers. Or you don't. We got 'em. NCR 53C90 delivers the SCSI bus maximum of 5.0 MBytes/sec synchronous at 25 MHz for the full length of the bus. That's at least 1MByte/sec better than most competitive chips can do, without migraine-sized overheadaches. Asynchronous? NCR's rate of 3.0MBytes/sec—for the full bus—is twice as fast as 99.9% of all others SCSI chips.

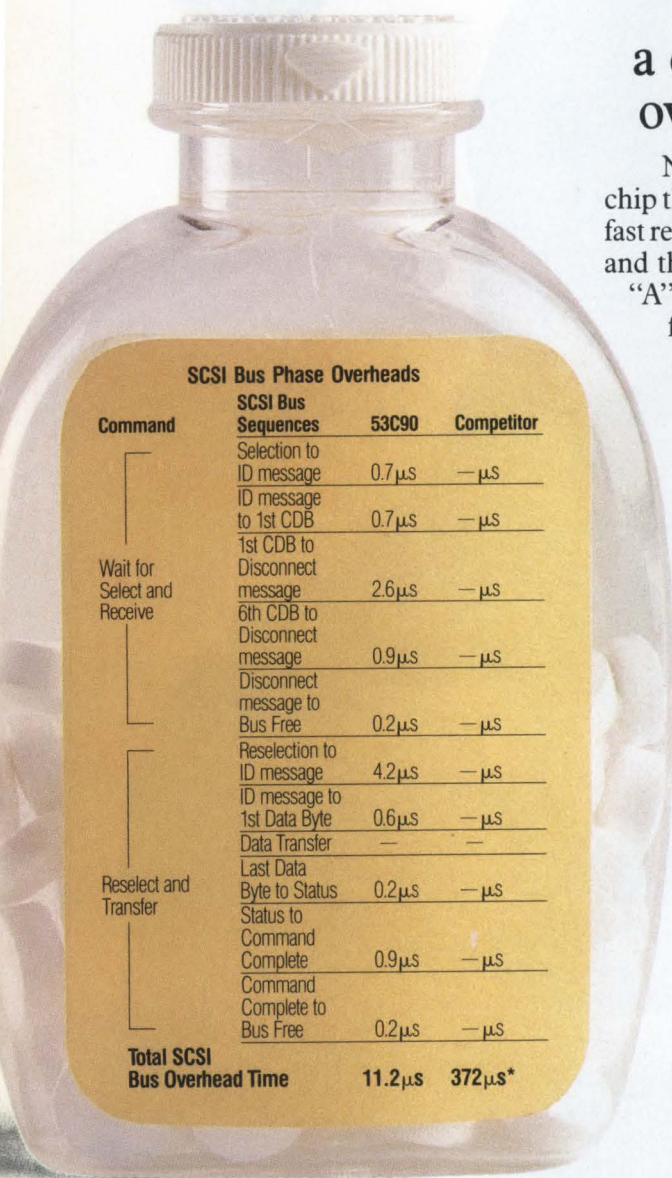

SCSI Bus Phase Overheads

Command	SCSI Bus Sequences	53C90	Competitor
Wait for Select and Receive	Selection to ID message	0.7 μ s	— μ s
	ID message to 1st CDB	0.7 μ s	— μ s
	1st CDB to Disconnect message	2.6 μ s	— μ s
	6th CDB to Disconnect message	0.9 μ s	— μ s
	Disconnect message to Bus Free	0.2 μ s	— μ s
	Reselection to ID message	4.2 μ s	— μ s
Reselect and Transfer	ID message to 1st Data Byte	0.6 μ s	— μ s
	Data Transfer	—	—
	Last Data Byte to Status	0.2 μ s	— μ s
	Status to Command Complete	0.9 μ s	— μ s
	Command Complete to Bus Free	0.2 μ s	— μ s
	Total SCSI Bus Overhead Time		11.2 μs

*Electronics Magazine August 20, 1987 Pg. 65

raising the for SCSI.

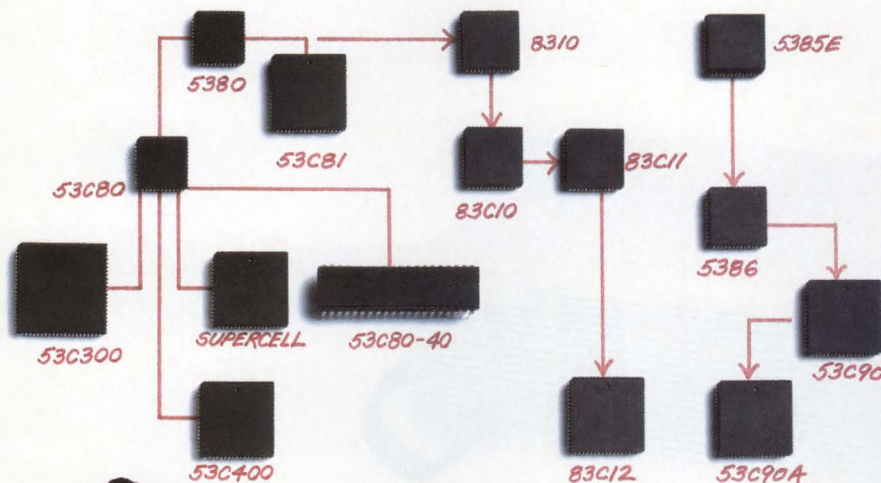

A big well-connected family.

Other suppliers can't show you much of a family tree compared to NCR. That's because NCR goes back to the "Mayflower" of SCSI controllers with the 5385 in 1982. The most recent offshoot of that original line is the high-performance 53C90A. Consistent with

good family planning the software for the 53C90 is similar to our 5385 and 5386, so you can quickly convert to the 53C90. A single chip host bus adapter (53C400), integrated buffer controller (53C300) and an ASIC supercell fill out our product offering. And you can bet we'll be there when you need SCSI II.

It's time to raise your standards.

In SCSI, it's not so much if you implement the standard, but how. Because our chips have an edge over other chips from other manufacturers, they can help give you and your product an edge in the market. We've shipped more than 3-million 5385's and 5380's and production quantities of the 53C90. If you don't want to just settle for the standard, call NCR today.

For documentation call our hot line 1-800-334-5454. Or write to, NCR Microelectronics, SCSI Products, 1635 Aeroplaza Drive, Colorado Springs, CO 80916.

For technical assistance, call 800-525-2252, Telex 452457.

How to get
zap-resistance,
latch-up
protection and
the blessings of the FCC.

For example, the NCR 5380 and 53C90 families give you ESD protection up to 10,000 volts on the SCSI bus. NCR also provides controlled fall times to reduce the undershoot that could cause other CMOS chips to latch-up. Controlled assertion rates also reduce generated RFI, an important factor in winning FCC approval for the final product.

NCR

NCR Microelectronics Division

New high performance PC-based emulators from HP.



Introducing the HP 64700 Series emulators. Low-cost, entry-level, PC-based emulators with features you won't find with any others in the price range—or even higher. The HP 64700s deliver unmatched capability, ease-of-use, measurement power, flexibility, and reliability... plus HP support.

While the HP 64700s are tailored to meet the needs of individual engineers and small design teams, they'll

perform equally well for large teams working on complex projects.

The rapidly expanding family of HP 64700 emulators provide real-time, transparent emulation at full processor speeds with no wait states. The PC user interface gives a new meaning to the term "friendly" with features like multiple windows, single-letter keystroke command entry, access to symbols for powerful debugging

capability, timing diagrams, and on, and on, and on. The experienced user as well as the beginner will appreciate how easy these emulators are to work with.

In addition to the features shown above, there are lots of others that put the HP 64700s in a class by themselves. To name a few: function with IBM-PC, HP Vectra and compatibles, RS-422 high-speed serial

we never stop asking

"What if..."

You could spend a lot more and get a lot less.



Multiwindow viewing allows up to eight displays on-screen simultaneously.

"Sky-hook" handles plus flexible 2- to 3-foot cables and low-profile probes allow easy access into target systems.

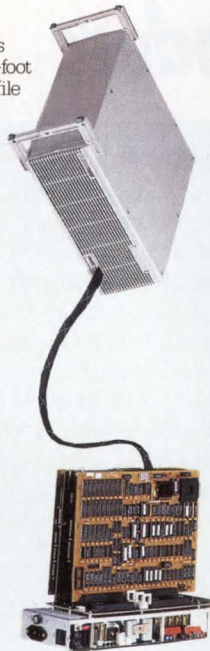

Powerful emulation bus analyzer with 8-level sequencing and optional 16-channel, 25 MHz state & 100 MHz timing analyzer available.

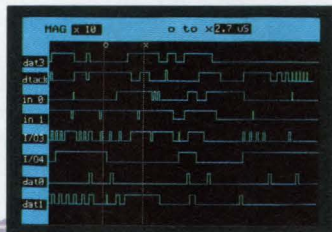

Entry level HP 64700 emulators are hardware and software compatible with the HP 64000-UX environment.



Up to 32 emulators can be interconnected, synchronously started, cross armed, cross triggered, and halted.



interface for superior download and upload speed, code coverage analysis for efficient software testing and design, host-independent portability, and compatibility with popular absolute file formats such as Tektronix and Intel hexadecimal and Motorola S record.

Once you get your hands on an HP 64700 emulator, you'll agree that this is the new standard in the field. Especially at a starting price of \$8,900.

Free demo disc.

For a free demo disc that gives you the "hands-on" feel for HP 64700 Series capabilities, call HP at 1-800-752-0900 ext. 215N, or mail the attached business reply card.



©1988 Hewlett-Packard Co. DS15830/EDN



PLD 22V10 24-Pin Reprogrammable.
Performance: 25ns.
Low power: 90mA (55mA max "L").
Variable product terms.
User programmable Macrocell.
Up to 22 input terms, 10 outputs.

Why our high performance 22V10 PLD is the market leader:

First, all the great architectural features of the standard 22V10.

Including Macrocell I/O, so one part can be programmed to replace up to 10 different PLD devices, plus many additional logic configurations. Inverted or non-inverted, registered or combinatorial operating modes. As many registers as you want—1 to 10. Synchronous Preset and Asynchronous Reset features. Configurable with up to 22 inputs and 10 outputs. A Variable Product Term architecture lets you easily tailor the 22V10 for high performance in a wide variety of applications, without burdening the product term structure.

And you get the benefit of easy programming, using industry standard languages like CUPL[®] or ABEL[™], standard programmers, or our handy QuickPro[™] programming accessory for PC or PC-compatible.

In other words, you get superb flexibility and ease of use. The 22V10 gives you the convenience of PLD design for logic functions in the 500 to 800 gate array complexity. But without the design complexity of gate arrays.

Now add Cypress CMOS leadership and you have the market-leading 22V10.

Blazing performance, with speeds to 25ns combinatorial/33.3MHz registered.

Quarter-Power for cool performance.

Optional windowed versions for the convenience of reprogrammability.

Skinny DIP or surface mount packaging. Greater than 2000V ESD tolerance on every pin, and the ability to tolerate $\pm 10\%$ power supply fluctuations.

No wonder this is such a best seller.

Get the databook that has the information you need on this great part, and you'll have the information you need on ALL our high performance parts.

CMOS high speed SRAM.

CMOS high speed PROM.

CMOS high speed PLD.

CMOS high speed Logic.

This databook, packed with high speed, low power parts, is yours for a phone call.

DataBook Hotline:

1-800-952-6300

Ask for Dept. C42

1-800-423-4440 In CA

Ask for Dept. C42

(32) 2-672-2220 In Europe

(416) 475-3922 In Canada



CYPRESS
SEMICONDUCTOR

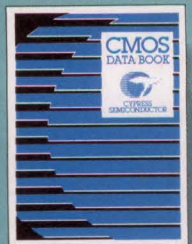

Cypress Semiconductor, 3901 North First Street, San Jose, CA 95134, Phone: (408) 943-2666, Telex: 821032 CYPRESS SNJ UD, TWX: 910-997-0753 ©1988 Cypress Semiconductor. QuickPro is a trademark of Cypress Semiconductor. CUPL is a registered trademark of Assisted Technology. ABEL is a trademark of Data I/O Corporation.

EDITORIAL

There is strength in partnerships

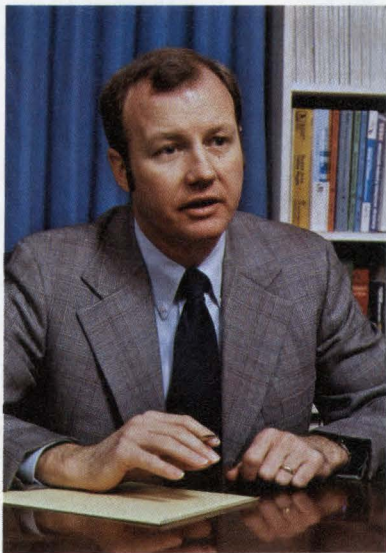

If the recent Buscon show in Anaheim, CA, is any indication, the bus-level computer business is maturing. More and more, suppliers and customers are treating each other like partners rather than just buyers and sellers. These partnerships aren't the strategic alliances you read about in the *Wall Street Journal* or *Business Week*, and they don't involve lawyers and lengthy agreements for sharing technologies or designs. Instead, they represent changing attitudes on the part of manufacturers and customers alike. Manufacturers are dropping the take-it-or-leave-it attitude. Customers, instead of trying to grind a supplier down to the lowest possible price, are now more concerned with quality, reliable sources of supplies, and service.

Under such partnership arrangements, progressive companies try to provide a complete line of products to meet as many of their customers' needs as possible. For example, a traditional manufacturer of computer-board card cages wishing to remain competitive must now offer a product line that includes enclosures, power supplies, backplanes, and connectors, as well as card cages. Customers want customized products, too, so successful manufacturers pay attention to special requirements and supply the needed products. After all, that's what partners are for. It's no longer sufficient for a supplier to offer a limited range of products.

Likewise, customers look to manufacturers to solve as many of their problems as possible. Customers will shun companies that simply manufacture a few add-in computer boards, for example. The customers want more than just boards. They want to buy software drivers, compilers, operating systems, and debugging tools that will get the boards up and running as quickly as possible.

Although it might seem like I'm stretching the point, coworkers can act like partners, too. Perhaps that's what gives some of our foreign competitors such strength. The technicians are partners with the engineers, the engineers are partners with their group leaders, and so on. Each group acts like a "buyer" and a "seller." For instance, the engineers buy technical assistance from the technicians, and sell designs to management. Each group in the partnership strives to offer as broad a line of talents and services as possible. Whether we're describing companies or people, the future belongs to the general "suppliers" who offer an extensive line of quality products or services and to the "customers" who put quality, reliability, and service above a few cents shaved off a price.

Jon Titus
Editor

OPA501/883B



This is the only true military power op amp in the world.

Can you afford anything less for your program?

OPA501/883B is a unity-gain stable, high power operational amplifier capable of 260W peak output. It drives heavy loads, including motors, with a wide margin of safety.

Full Military Processing, Fully Certified Lines

A true military hybrid part, like the OPA501, has to be fully compliant with MIL-STD-883, Rev. C, Class B processing. And it has to be manufactured on lines which are DESC certified to MIL-STD-1772. Burr-Brown is the **only** manufacturer of power op amps who currently meets these rigorous

requirements, and we hope you won't settle for anything less than the real thing.

Key OPA501/883B Features

- wide $\pm 10V$ to $\pm 40V$ supply range
- high $\pm 10A$ peak output current
- high 260W peak output power
- low $2.2^{\circ}C/W$ DC thermal resistance
- full /883C, Class B processing; other processing available, including Class S
- complete test and reliability documentation
- off-the-shelf delivery

If your systems require true military power amps, you can obtain complete details from your Burr-Brown technical rep, or contact Applications Engineering, 602/746-1111. Burr-Brown Corporation, P.O. Box 11400, Tucson, AZ 85734.

BURR-BROWN®
BB

Omron Relays Respond— Alone or in Combination

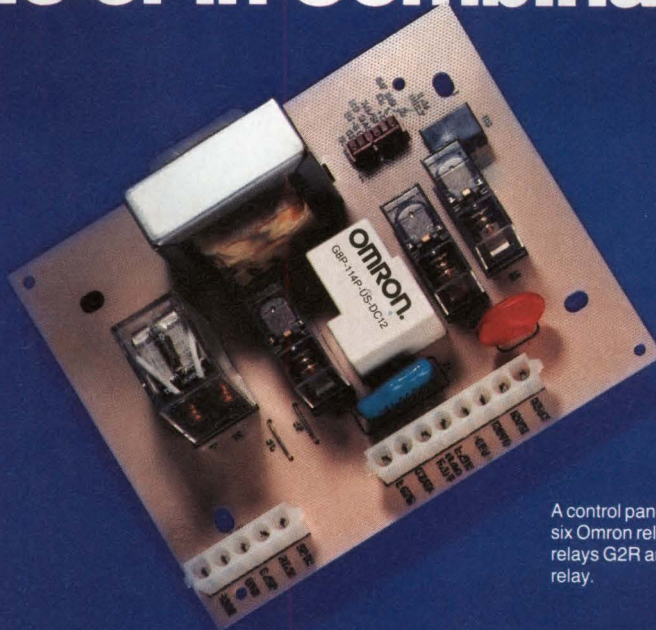

A control panel of a major appliance manufacturer shows six Omron relays—a general purpose LY2, power PCB relays G2R and G8P, as well as a G6E signal control relay.

Omron Has Your Relay

From industry standard general purpose relays to power PC board relays, Omron relays provide low power consumption, high speed operation and high reliability to meet your application needs. In addition to your standard relay requirements, Omron relays offer a wide variety of options, including LED indicators, push-to-test buttons, high switching capacity, and more.

Designed To Meet Customer Needs

Because there are as many application requirements as there are design engineers, Omron backs up its extensive relay line with a commitment to product innovation. Many of our best-selling standard relays were initially developed to meet specific customer requirements in a wide variety of industry applications.

Shown here are key specifications for some of Omron's most popular power and general purpose relays.

Power Relays

Model	G2R		G4W		G4B	G5D		G8P			MK			MY			LY				MJ					
	1A, 1C	2A, 2C	1A	2A	1A, 1B, 1C	1X	2X	1A	1B	1C	1C	2C	3C	2C	3C	4C	1C	2C	3C	4C	1C	2C	3C			
Contact Form	1A, 1C	2A, 2C	1A	2A	1A, 1B, 1C	1X	2X	1A	1B	1C	1C	2C	3C	2C	3C	4C	1C	2C	3C	4C	1C	2C	3C			
Rated Load	10A, 250VAC/ 30VDC	5A, 250VAC/ 30VDC	15A, 230VAC/ 24VDC	10A, 220VAC/ 24VDC	25A, 220VAC/ 24VDC	30A, 250VAC	20A, 250VAC	30A, 250VAC 20A, 28VDC	15A, 250VAC 10A, 28VDC	20A/ 10A* 250VAC/ 28VDC	5A/220 VAC 3A/24 VDC	3A/ 220 VAC 2A/ 24 VDC	5A/220 VAC 5A/24 VDC	3A/ 220 VAC 3A/ 24 VDC	15A/ 110 VAC 10A/24VDC	10A/110VAC 10A/24VDC	10A/110VAC 10A/24VDC									
	High Capacity Type 16A, 250VAC/ 30VDC										High Capacity Type 10A/230 VAC 10A/28 VDC			High Capacity Type 5A/240 VAC 5A/28 VDC												
Terminal Types	PCB, QC, Solder		PCB, QC, Solder, QC and PCB		QC, QC and PCB (coil)	QC		PCB			Octal Pin			PCB or Solder/Plug-in			PCB or Solder/Plug-in				QC or Plug-in					
Coil Types	AC/DC		DC		AC/DC	AC/DC		DC			AC/DC			AC/DC			AC/DC				AC/DC					
Coil Power	AC: 0.9 VA DC: 0.53 W		0.8 W		AC: 1.3 VA DC: 1.2 W	AC: 3.0 VA DC: 1.9 W		0.9 W			2.1 VA 1.2 W			1.2 VA 0.9 W			1.2 VA 0.9 W		2.0 VA 1.4 W		2.5 VA 1.5 W		2.1 VA 1.2 W		2.5 VA 1.2 W	
Approved Standards	UL, CSA, TUV, VDE, SEV, SEMKO		UL, CSA, VDE, SEV, SEMKO		UL, CSA	UL, CSA, VDE, TUV		UL, CSA			UL, CSA, LR			UL, CSA, SEV, LR			UL, CSA, VDE, SEV, LR				UL, CSA					

*No/NC contacts

In Stock Where You Need Them

Count on your local Omron stocking distributor for assistance and off-the-shelf delivery of Omron switches and relays. Our commitment to customer service has forged one of the strongest distributor networks in the industry. But don't just take our word for it. Contact Omron for more information and a distributor list today.

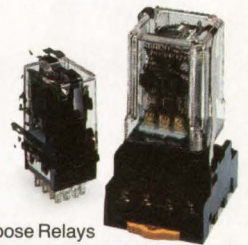

Omron General Purpose Relays include our MY, MK, LY and MJ models.

1-800-62-OMRON

OMRON[®]
Responsive Innovation

EDN April 14, 1988

CIRCLE NO 38

OMRON ELECTRONICS, INC.
One East Commerce Drive
Schaumburg, IL 60173
TWX 910-291-0426

The Great 16-bit Solution!

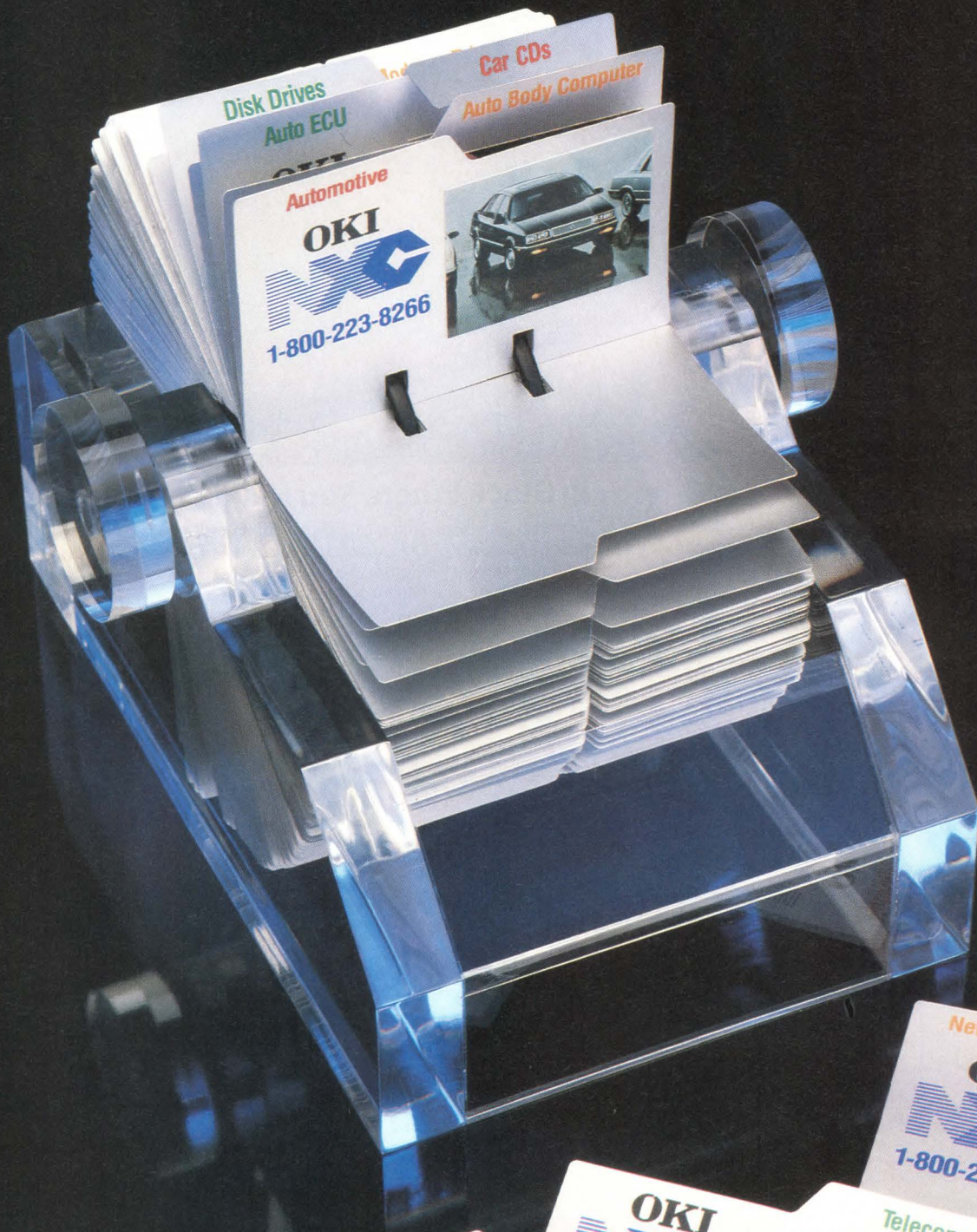



the first core-based 16-bit CMOS MCU.

From OKI system technologies, the solution for high-end multitasking applications.

Call on OKI **NXC**, and you move that tough multitasking application into the next generation of microcomputing. It's the performance of tomorrow — available today, with OKI's new 66301 MCU. The industry's first core-based 16-bit CMOS controller. Our first **NXC** solution.

OKI system technologies have implemented a true macro-cell approach with the 66301. Essentially a static part, this MCU presents a whole new level of integration. On board, in addition to the 16-bit CPU: 16K bytes of ROM (48K bytes external). 512 bytes of built-in RAM (512K bytes external).

You also get four 16-bit timers, 2 PWMs, plus a watchdog timer. And a rich range of instructions, including special instruc-

tions for word-length multiplication and division.

Now add in an 8-channel, 10-bit A-D converter and a baud rate generator, with variable bit length operations and context switching. On a single chip, our revolutionary macro-cell design packs far more options, capabilities and sophisticated functions than any 16-bit industry standard can now offer.

With the 66301 on line (and an E² version available soon), OKI's exclusive **NXC** introduces a new generation of high-level integration — for your most demanding automotive, telecomm and instrumentation system requirements.

16-bit development solutions

OKI's total commitment to development ease and support gives you a headstart in **NXC** microcomputing.

We can provide a special development version of the 66301 chip — built to accept an EPROM piggyback. To check out your design in realtime, snap on your coded memory. This allows you to keep burning code variations into inexpensive EPROMs, until you get a working prototype ...at a very minimal cost.

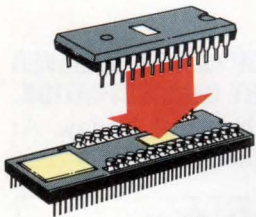

Of course, OKI's 66301 MCU is solidly backed with a full-scale development system. For realtime in-circuit emulation (ICE), use the **NXC** EASE system. The portable EASE package includes your ICE hardware,

user's manual, plus complete assembler and debugger software for both MSDOS and VMS. With a compatible high-efficiency C-Compiler option as well. All available from OKI. All part of the **NXC** solution to high-end multitasking applications, produced by the most system-oriented technologies in the field today.



16-bit Solutions — on call.

- Please send complete technical data on the NXC 16-bit CMOS MCU solution produced by OKI system technologies.
- Call me, I have immediate requirements.
Tel: () _____

Name _____

Title _____

Company _____

Please clip coupon to business card or letterhead and return to: **NXC Customer Service, OKI Semiconductor**, 650 N. Mary Ave., Sunnyvale, CA 94086. (408) 720-1900.

EDN041488

OKI

SEMICONDUCTOR

CIRCLE NO 40

WHO YA GONNA CALL TO ICE 68020 BUGS? ATRON BUGBUSTERS!

We recently received a competitive analysis written by a billion-dollar competitor of ours. In it, they rank in-circuit emulation companies in order of importance. We were number one.

SO WHO'S ATRON?

Today, Atron is the number-one supplier of hardware-assisted software debuggers for 8088/80286/80386-based PCs. Nine of the top ten software packages were written by Atron customers. Everybody from AST to Borland to Oracle to Zenith. Now, we can make the same claim in the 68020 marketplace.

Everybody from Apple (MAC IIs) to Wellfleet (datacom) will attest to the superiority of Atron's 68020 debugging technology. One Atron customer even said, "We sent our non-Atron ICE unit out several months ago for repairs; nobody around here seems to know or care if it's back yet. The Atron unit is the tool of choice."

25-MHZ, REAL-TIME, EMULATION: SOONER OR LATER, YOU KNOW YOU'LL NEED IT.

Why invest in a slower emulator (especially one that costs more)? Some bugs only occur in real time, and you know your next design will be 25 mhz. Before Atron's state-of-the-art design, there was no such thing as a 25-mhz emulator. There still isn't another one anywhere near our price.

PROBE CAN TRACE IT THROUGH THE PIPELINE, SO YOU WON'T LOSE YOUR MIND.

The 68020 has an on-board pre-fetch pipeline. Without Atron's 68020 PROBE, your best software engineer will spend a lot of time figuring out which instructions actually execute, and then, which bus cycles go with those instructions. The 68020 PROBE eliminates all these

tedious mental translations and displays what the processor really did. The technology, called pipeline dequeuing, is only available from Atron. Because the Atron bugbusters are the only ones anywhere who've figured out how to do it. And it took us 100,000 lines of code. Consider it our contribution to your sanity. (It was a dirty job, but somebody had to do it.)

Accu Ray Advanced Digital
Allen Bradley Apple Computer
Arete Systems BBN Bell North-
ern Bally Sente Clearpoint
Compugraphics Control Data DY-4 Sys-
tems Douglas Aircraft Eastman Kodak Fla-
vors Tech Forestyle Gener-
al Motors General
Electric Graftec IBM
Kurzweil Computer
LaserCo MAI/Basic Four
Marquette Electronics
McDonell-Douglas
McFadden Systems
National Research
Council Naval Ocean
Systems Center Off-
shore Systems Ltd. P-
Can Robotics Palladium
Data Plexus Computer
Radius Republic Elec-
tronics Rockwell Interna-
tional Spartacus Stan-
ford Telecommunica-
tions Versatec Vitro Ser-
vices Wang Laboratories Wellfleet Communications
Xyvisio

68020 PROBE SPECIFICATIONS

Clock speed	25 mhz
Execution	Transparent
Trace	2048 cycles by 96 bits Qualified trace region Dequeued trace data Pre and center triggered Includes symbols and source Dynamic cache control
Breakpoints	8 hardware on execute Read, write, fetch, logic Single or range addresses 16 software breakpoints Sequential triggers - 4 terms Real-time pass counter Guarded access on memory Output lines for cross trigger Input lines for external logic 512K
Mapped RAM	512K
Source debug	Yes for C, Pascal, Assembler S, Tek, Cof, 4.2 BSD, SUN and IEEE formats
Symbolic debug	Limited only by AT disk size
Symbol table	Multiple windows and menus
User interface	Yes, and conditional execution
Macros	To target system at 375k baud
Download	68881,68851
Coprocessor	

LET THE SOURCE BE WITH YOU.

Why spend all day doing mental translations between your C source code and the machine code in your target? These tedious operations are eliminated with Atron's source-level debugging capabilities.

Since PROBE uses a PC AT as its instrumentation chassis, you can get compiled code to its target via Ethernet, VAXNet, SUNNet, SCSI or RS-232. And whether you are compiling on a PC, a workstation or a VAX, Atron supports more object-module formats than anybody else (see specification box).

YOU'LL BE A BELIEVER AFTER A SHORT DEMONSTRATION.

So who ya gonna call? Bugbusters! Today. At 408/741-5900. Or send in the attached coupon.

My business card or company letterhead is attached:

- I've got to see this for myself. Please have a representative call me to schedule a demonstration.
- Please send me your 36-page 68020 PROBE user's guide, with its command summary and examples of use.



BUGBUSTERS

A division of Northwest Instrument Systems, Inc.

Saratoga Office Center • 12950 Saratoga Avenue
Saratoga, CA 95070 • Call 408/253-5933 today.

EDN041488

TECHNOLOGY UPDATE

Program-generation tools for PCs ease IEEE-488 system integration

Peter Harold, *European Editor*

The IEEE-488 bus (or GPIB) provides a quick, convenient method of connecting instruments as an ATE system, but generating the software to control these instruments has always been a time-consuming task. Now, however, you can obtain personal-computer-based CASE (computer-aided software engineering) tools that speed up the process of developing software for IEEE-488 systems. Most of these tools allow you to program in conventional languages; one eliminates the need for a conventional programming language. Further, some of these tools help you generate good documentation for your programs. IEEE-488 program-generation tools are available for both IBM PC-family and Apple Macintosh computers (see **box**, "Macintosh icons ease IEEE-488 programming").

The main reason why IEEE-488 software has often proved difficult to write is that it required the software developer to know in detail how particular instruments operate on the IEEE-488 bus. For example, the programmer had to know the instruments' programming codes, data formats, status-code responses, and internal timing. Despite attempts to standardize some of these parameters—notably in the US Air Force's MATE (modular automated test equipment) program and, more recently, in the new IEEE standard (IEEE-488.2) produced by the organization's P981 committee—currently available instruments vary widely in the way you control them via their IEEE-488 interfaces.

To overcome this problem, soft-

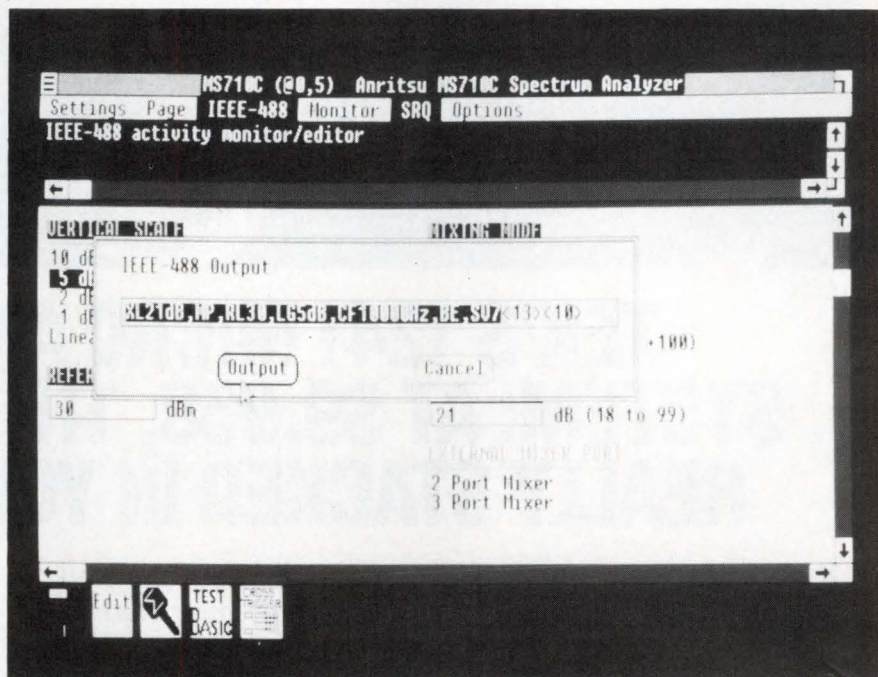

This custom device window from the instrument library for Summation's Testwindows typifies the approach to instrument control used in many IEEE-488 programming packages. You set up an IEEE-488 instrument by selecting the appropriate instrument setting from an on-screen function menu. The inset window illustrates the IEEE-488 programming string that is automatically generated from your selections. You can send the string directly to the instrument to test it, and then incorporate it in your Basic program.

ware vendors have devised a generation of PC-based software-development tools that include libraries of instrument drivers for popular IEEE-488 instruments. These drivers provide you with an on-screen description of an instrument's functions. After you select the functions you require, the driver automatically assembles both the programming string for the corresponding instrument and the program statement required to transmit the string over the IEEE-488 bus. You can execute this program statement immediately to test whether the instrument responds correctly, and then incorporate the statement in your runtime program.

If you want to use an instrument for which the library doesn't provide

a driver, however, you'll either have to write it yourself, or coax the instrument manufacturer, software supplier, or a third party to write it for you. Clearly, the instrument manufacturer has the most intimate knowledge of the instrument, and the software supplier understands best how to generate instrument library files. Ideally, therefore, a new instrument driver would be a cooperative effort between the instrument manufacturer and the software supplier.

If you're left to write the driver yourself, you're back to square one. You'll need a detailed understanding of the instrument, the library-generation tools, and the operation of the IEEE-488 bus in order to do the job competently. Fortunately, most



TEK'S 1241 MICRO ANALYSIS SYSTEM: AT \$9,950, THE CHIPS ARE REALLY STACKED IN YOUR FAVOR!

Tek's 1241 microprocessor analysis system includes the Tek 1241 Logic Analyzer. The micro support package of your choosing. Plus performance analysis, storage and communications options. At a total price of \$9,950. If you're looking for a system to minimize your risk and maximize your return, this is the package you can bet on.

It's proven. The 1241 is known and accepted worldwide as the best of the leading

logic analyzers.

It supports more than 45 microprocessors, microcontrollers and digital signal processors. That's more than any other logic analyzer. You can add additional micro support for as little as \$400.

It comes with a specialist.

Tek's dedicated logic analysis sales and applications engineers give you expert support whenever you need it.

It's the best deal on the table. For immediate value and long-term practicality, nothing else can touch it.

Call us. Talk to your local Tek sales representative, or call 1-800-245-2036 for more information about the total Tek 1241 package.



CIRCLE NO 42

Tektronix
COMMITTED TO EXCELLENCE

TECHNOLOGY UPDATE

companies would only need to hire one programmer with this detailed knowledge to serve the instrument-driver needs of all their application programmers.

Check library support

Before you buy IEEE-488 program-generation software, check carefully to find out how much support you'll get from the supplier in extending the instrument library to cope with your current and future IEEE-488 instrumentation needs. Remember, that it's in the software supplier's best interest—as well as your own—to extend the instrument library. Therefore, as long as the instrument you want to use isn't one of a kind, you might have success in persuading the software supplier to generate the driver for you at no charge. If possible, you should lend the supplier the instrument so that the driver can be fully tested.

User groups, such as the one run by Summation Inc, are another useful source of instrument drivers. However, irrespective of where you obtain instrument drivers, it's important to ensure that they're capable of exercising all of an instrument's functions—not simply a subset of the instrument's functions that satisfies some other user's requirement.

Well-documented code

IEEE-488 program generators don't just overcome the problem of writing instrument-driving software: They also help you generate well-documented, error-free program code. Because they let you allocate a meaningful name to each IEEE-488 bus address, you can select devices by name rather than by number. For the standard bus functions (for example, device triggering, device initialization, and serial polling), which are selectable from on-screen menus, the program generator only requires you to define a set of device names; it can then construct a syntactically correct program statement to execute the

function. When you list programs on a printer, this symbolic addressing automatically appears on the printout, together with a comment field that explains the function of the program statement.

A window on your problems

Most IEEE-488 program generators produce Basic source code, so when you use these packages, it's usually an advantage to have some experience with the Basic programming language. To run Summation's Testwindows, for instance, you need to be familiar with the TestBasic language. Operating within a Mi-

screen at the same time.

One of the windows gives you direct access to the MS-DOS operating system, allowing you to call up any MS-DOS-compatible software package from within Testwindows. It's therefore easy to integrate data-analysis and -display software packages—such as Write, Lotus 1-2-3, Excel, and Paint—in Testwindows.

Although you'll have to generate much of your application program in TestBasic, each time you need to control external instrumentation via the IEEE-488 bus, you can call on the services of an IEEE-488 win-

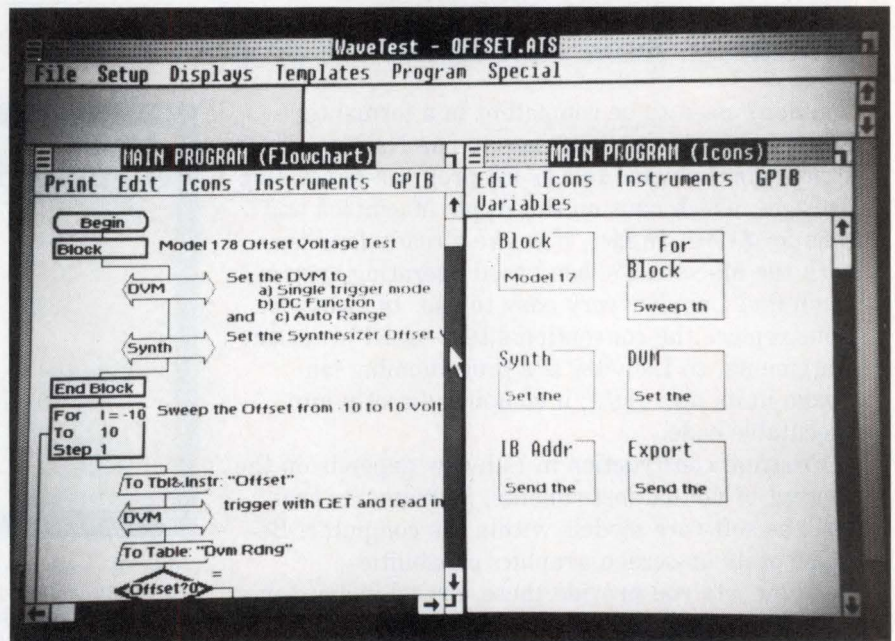

The flowchart- or module-programming techniques provided by Wavetek's Wavetest package let you use 19 standard program-module icons to program IEEE-488 systems. Where necessary, however, you can also incorporate segments of Basic code in your program.

crosoft Windows environment (the latest release, Testwindows 3.0, runs under Windows 2.0 or Windows/386 and is upwardly compatible with the OS/2 Presentation Manager Interface) Testwindows subdivides the task of programming IEEE-488 systems into a number of individual tasks, each supported by its own window and extensive mouse-driven pull-down menus. Because Testwindows operates under Microsoft Windows, you can have several active windows on the

screen that automatically generates the required code in the form of documented TestBasic statements. The IEEE-488 window exists either as an uncommitted IEEE-488 window or as a custom device window.

The uncommitted window provides simple menu selection and parameterization of TestBasic's normal IEEE-488-bus commands. The custom device window, however, provides on-screen lists that detail an instrument's capabilities (for example, a DMM's functions, ranges,

TECHNOLOGY UPDATE

read rates, and filter selections). You select the required instrument functions from these lists, and Testwindows automatically generates the appropriate IEEE-488 command strings and TestBasic program statements.

To assist you in debugging your application software, Testwindows devotes part of the IEEE-488 window to displaying the data transfers that take place over the IEEE-488 bus. The display indicates the direction of the transfer—system controller to instrument or instrument to system controller—and the state of the IEEE-488 bus's serv-

ice-request line (SRQ). In addition to selecting an instrument's functions from within the custom device window, you can also use the learn mode featured in some IEEE-488 devices. In learn mode, you set up the instrument from its own front panel, and then command it to send its current state over the bus. The IEEE-488 window can translate this state information and highlight the appropriate functions on the custom device window's function lists.

Summation's instrument library currently contains more than 100 instrument drivers that the compa-

ny's user group distributes free of charge. Most of these drivers were written by Summation. Those that users write are vetted by Summation before being distributed.

Create your own drivers

To help you generate custom device windows, Testwindows includes a special IEEE-488 window editor. Pull-down menus within the editor allow you to create lists of instrument functions and to assign the appropriate IEEE-488 programming codes to each function. You can also set up procedures that perform other IEEE-488 opera-

Macintosh icons ease IEEE-488 programming

You don't need to be competent in a formal text-based programming language to use National Instruments' Labview IEEE-488 program-generation package, which runs on the Apple Macintosh and sells for \$1995. In fact, if you're already familiar with the Macintosh's icon-based operating system, you'll find Labview very easy to use. In Labview, icons replace the conventional text-based program statements, so Labview is a programming language in its own right; it compiles directly into executable code.

Program construction in Labview depends on the concept of virtual instruments, instruments that exist as software models within the computer. Because of its on-screen graphics capabilities, Labview lets you provide these virtual instruments with front-panel controls and data displays very similar to those you'd find on a physical instrument: slider controls, rotary knobs, pushbuttons, thumbwheel switches, analog meters, and digital readouts, for example. Note, however, that virtual instruments don't always mimic real instrumentation; they can just as easily implement computation functions for analyzing data.

Labview includes virtual-instrument libraries for data analysis and display, as well as a library of IEEE-488 instrument drivers. The data-analysis library contains waveform-analysis, statistical-analysis, matrix- and vector-arithmetic, signal-processing, curve-fitting, and database-management functions. The instrument-driver library includes more than 90 commonly used IEEE-488 instruments. If the instrument you want to use isn't in the library, as with the company's Labwindows

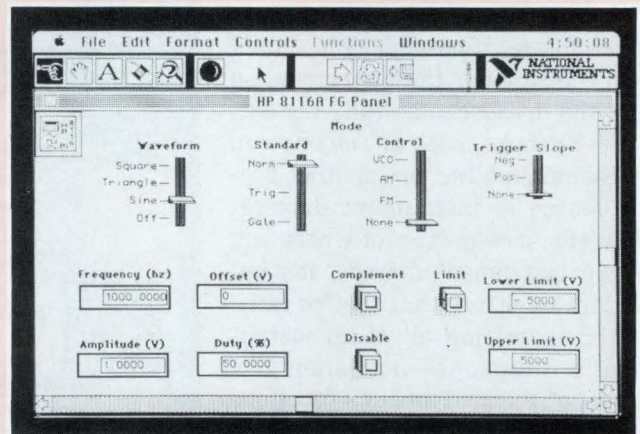

Using the sophisticated graphics icons provided by Labview, you can generate virtual-instrument front panels with controls that mimic a real instrument's controls. Each front panel also has an associated block diagram in which you can simulate the instrument's functions, so you can evaluate your program without connecting any actual instrumentation to the Macintosh.

drivers, you can ask National Instruments to write a driver for you at no charge.

Labview doesn't only control instrumentation connected via an IEEE-488 bus. The package also supports instrumentation connected via an RS-232C or RS-422 serial bus, as well as IBM PC/AT-compatible I/O cards that plug into the MacBus I/O expansion box.

Because the company recognizes that Labview's icon programming on its own won't solve everyone's application problems, the latest release (version 1.2) of Labview lets you integrate in your programs segments of code written in Think Technologies' LightspeedC.

The New 4180 Plug-In

SPEED TRIALS.

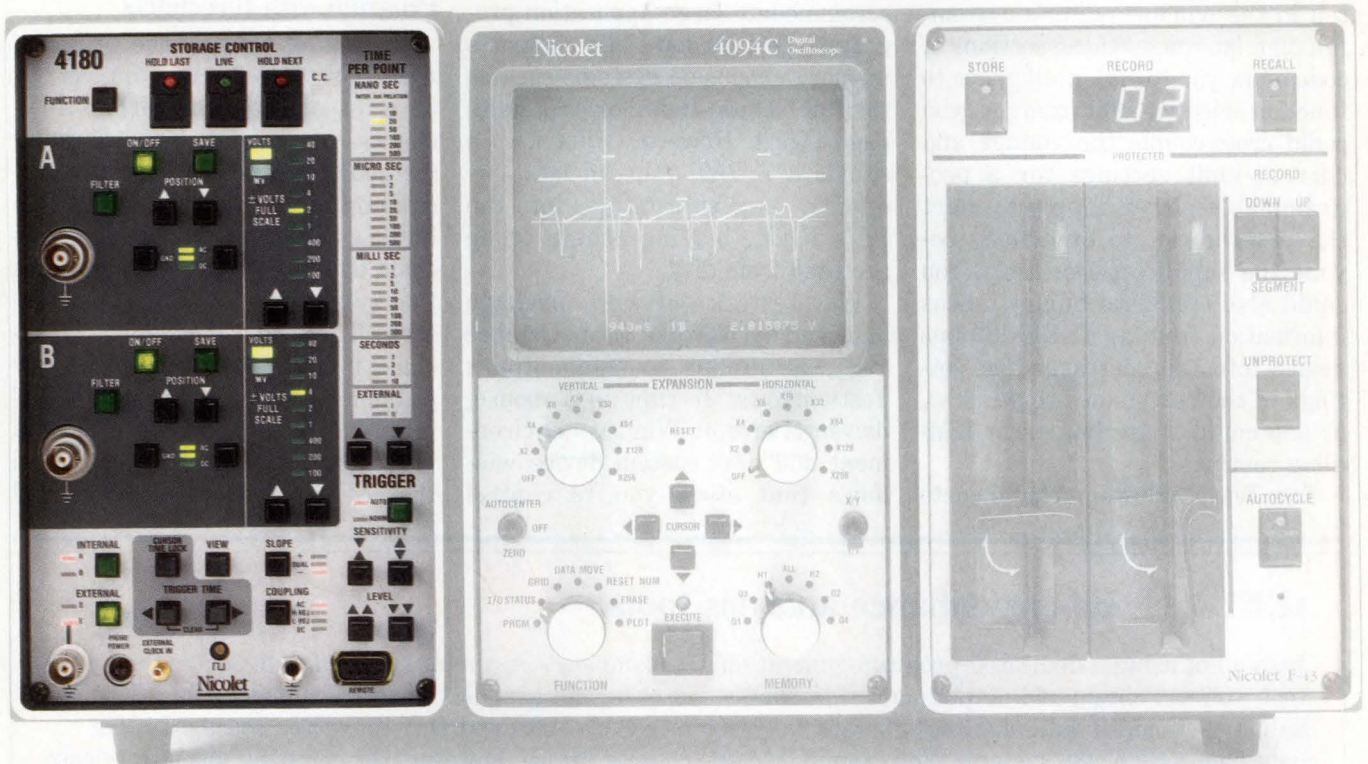

- Multi-channel: two or four channel configurations.
- Unmatched single-shot capabilities.
- High speed, 200 MHz digitizing.
- 100 MHz analog input bandwidth.
- Real-time math functions.
- For your Free Speed Trial call: 800-356-3090 or 608-273-5008

Nicolet Digital Oscilloscopes

Speed. Using the latest designs in ADC technology, your input signal can be digitized at speeds up to 200 MHz (5ns per data point) and saved for analysis. The wide band input amplifiers allow signals up to the 100 MHz Nyquist limit to be input without distortion. Sophisticated trigger setup displays allow you to accurately set the level, sensitivity, and slope to make one-shot transients easy to catch; eliminating the usual hit or miss guesswork. For multi-channel applications two 4180's can operate together in one mainframe producing a four channel scope with no degradation in speed or performance.

Real-Time Math. In addition to the extensive post-processing capabilities in the mainframe, the 4180 has several useful routines which present computed results as live, real-time displays: *FFT*, *MAX/MIN*, *A+B*, *A-B*, *A×B*, *A/B*, and *AVERAGING*.



Nicolet Test Instruments Division
P.O. Box 4288
5225-2 Verona Road
Madison, WI 53711-0288
EDN April 14, 1988

Nicolet

INSTRUMENTS OF DISCOVERY

CIRCLE NO 43

75

TECHNOLOGY UPDATE

tions, such as reading data from an instrument or evaluating its serial-poll status-byte responses.

Besides using the program's simple fill-in-the-blank procedure for creating the custom device window, you can add a section of code to each item or group of items in the custom device window's function lists. Written in the window editor's custom-function language, these sections of code allow you to add intelligence to function selection. For example, you could cross-couple the voltage and current-limit settings for a programmable power supply to alert the programmer to excursions beyond the supply's power limit. You could also translate binary status information from an IEEE-488 bus device into the corresponding settings in the custom device window, or you could write bus-error-handling routines.

The Testwindows package costs

\$2950 and includes Microsoft Windows 2.0 and a selection of Microsoft-supplied windows. To run it, you need an IBM PC/AT or compatible computer with 640k bytes of memory, an EGA card, a suitable color monitor, and either a National Instruments PCII or PCIIA card or an IBM GPIB interface card. To accommodate large application programs, Testwindows also supports memory-expansion systems such as the Intel Above-Board or AST Ram-page board. However, even with a standard PC/AT you can lock frequently used subroutines into the PC's RAM, leaving others to be accessed from disk.

Wavetest, a software package launched by Wavetek Inc in October 1987, is similar to Summation's Testwindows. It runs in a mouse-driven Microsoft Windows environment and uses custom device windows that allow you to control

IEEE-488 instruments. Wavetest is significantly different from Testwindows, however, in that it doesn't require you to generate syntactically correct Basic statements in order to generate the bulk of your program: Hence, Wavetek claims, you get no syntax errors.

Program with flowcharts

Instead of writing the program with Basic statements, you can opt to write it by using either flowchart- or module-programming methods. Wavetest's flowchart-programming window allows you to build an on-screen program flowchart by using 19 flowchart modules that you can parameterize as necessary. These flowchart modules include program-flow structures (for example, DO-WHILE loops, FOR-NEXT loops, subprogram calls, and IF statements); modules to control the IEEE-488 bus; and I/O control

IEEE-488 add-ons enhance analysis tools

Instead of using a dedicated program-generation tool, you can obtain add-on packages that allow industry-standard data-analysis software to gather data from IEEE-488 systems. For example, by integrating Lotus Measure in Lotus 1-2-3, you can transfer data directly between an IEEE-488 bus system and a Lotus 1-2-3 worksheet. However, Lotus Measure doesn't provide an instrument-driver library, so you'll have to generate your own drivers by building worksheet macros that invoke the required IEEE-488-bus command sequences.

Supplied on a floppy disk, Lotus Measure's IEEE-488 module contains additional routines that you can add to Lotus 1-2-3's normal device-driver file. The module provides two sets of IEEE-488 routines: one for use with National Instruments' IEEE-488 interface cards; and one for use with a Hewlett-Packard HP-IB interface card. The IEEE-488 module provides Lotus 1-2-3 with 22 additional bus-oriented macro commands that you can invoke through Lotus 1-2-3's normal menu-access procedures. A similar package is available for use with Lotus Symphony. Both packages sell for \$495.

In the coming months, you can also expect to see a new data-acquisition and -analysis package from Asyst Software Technologies Inc. At present, the

company's Asystant range of data-acquisition, analysis, and graphics software supports only PC-compatible A/D- and D/A-converter boards. In the near future, however, the company plans to release a \$695 software package, Asystant-GPIB, that incorporates menu-driven IEEE-488 functions, so it can control and acquire data from IEEE-488 systems rather than from data-acquisition cards. Asystant-GPIB runs on the whole family of IBM PCs and can accommodate a range of IEEE-488 interface cards.

Upon entering Asystant-GPIB, you can allocate a symbolic name, a primary and secondary bus address, and a bus timeout to each instrument on the IEEE-488 bus. After that, you have the choice of entering either an interactive mode or a program-generation mode. In the interactive mode, you're presented with a menu of IEEE-488 operations that lets you directly control instruments on the bus. By executing these operations, you can check such things as programming strings and instrument responses. The program mode allows you to incorporate these bus operations in your application program. Whichever mode you're using, you can still invoke Asystant's numerical- and statistical-analysis functions.

Time interval measurement. \$3850.

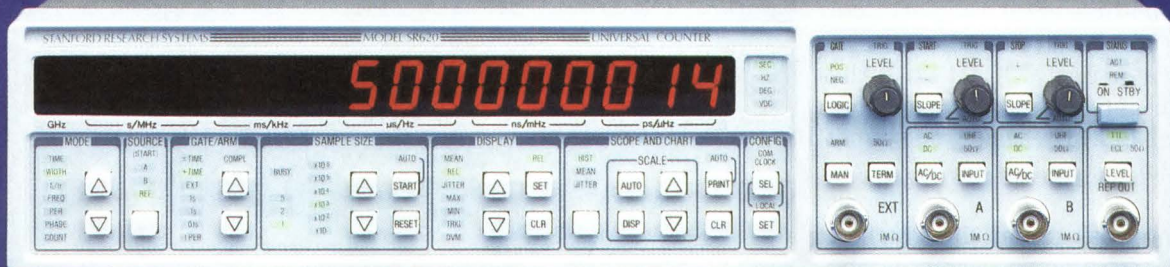

4 ps single-shot resolution
1.3 GHz frequency response
Statistics, analysis, and graphics

Finally, high resolution time interval measurement at an affordable price. The SR620 Universal Time Interval Counter offers 4 ps single-shot LSD on time intervals, and 11 digits of frequency resolution in one second. With powerful arming, gating, and triggering modes, the SR620 can measure time interval, frequency, period, pulse width, and phase, as well as rise and fall times.

The SR620 has built-in statistical functions, including mean, min, max, standard deviation, and Allan variance

for up to 1 million samples. Results may be displayed on the front panel, and graphed in histogram or strip chart form on an X-Y oscilloscope. Hardcopy is directly available on a plotter, printer, or chart recorder.

With both RS-232 and GPIB interfaces standard, the SR620 is also ideal for ATE applications.

Whatever your time or frequency measurement needs may be, the SR620 is the answer. For more information, call us at (408) 744-9040.

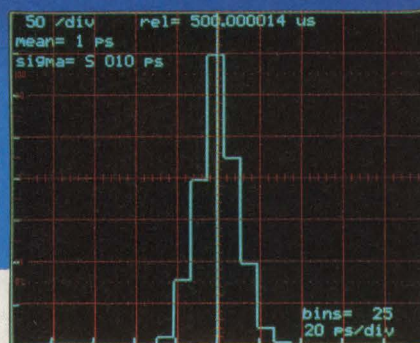

The SR620 provides graphic display of histograms and strip charts on any X-Y oscilloscope. With Autoscale and Zoom, graphics can be easily scaled. Attach a dot matrix printer or an HP-GL plotter and obtain hardcopy of any graph.

SR620 **\$3850**

Single-shot resolution	4 ps
Time interval jitter	20 ps rms
Maximum time interval	1000 s
Maximum frequency	1.3 GHz
Frequency resolution	10^{-9} Hz
Phase resolution	0.001°
Statistics	Mean, Min, Max, Std. Dev, and Allan Var.
Sample size	1 to 10^6
Analyzer	Display on X-Y scope
Graphics	Histogram and Strip Chart
Hardcopy	Printer/Plotter
Interfaces	GPIB and RS-232

Oven Timebase (5×10^{-10} /day) **\$950**



STANFORD RESEARCH SYSTEMS

1290 D Reamwood Avenue, Sunnyvale, CA 94089
 TEL (408) 744-9040 FAX 4087449049 TLX 706891 SRS UD

TECHNOLOGY UPDATE

modules to control file generation and to direct output to computer peripherals.

Other modules allow you to incorporate delays in the program, generate test-report documentation, set up run-time error handlers, and activate an operator window so that an operator can interact with the program during its execution. To program an instrument, you simply go to the instrument menu, select its custom device window, interact with the instrument until you're sure that it responds correctly, and then incorporate the operation in your flowchart.

The program also offers the Basic module, which lets you use TransEra Corp's (Provo, UT) TBasic programming language to write those parts of your program that can't be created from the standard flowchart modules. The standard flowchart modules let you create the program structure and I/O-con-



The Labview software package from National Instruments turns a Macintosh computer into a powerful IEEE-488 controller that you can program entirely with icons. The latest release of Labview (version 1.2) also allows you to integrate code written in Think Technologies' LightspeedC in your programs.

trol segments of your program. You'll have to resort to using TBasic to generate code that analyzes the captured data (for example, to com-

pute the standard deviation of measurement values for entry into a test report).

In addition to using individual

Samsung's flash converters



TECHNOLOGY UPDATE

modules, you can also create block modules that comprise the other modules. You can also nest block modules within other block modules. Therefore, a single block-module icon can represent a large section of code, which you can examine by opening the icon.

Wavetest's alternative to flowchart programming is module programming. To construct a program in this window, you simply arrange the icons that represent the modules in the order in which you want them to execute, from left to right and top to bottom on the screen. Reordering the icons on the screen rearranges the program flow. You can have the flowchart window and module window on the screen simultaneously. If you make changes in one window, the other window is automatically updated to reflect the revised program.

One advantage of using the flowchart programming technique is

that it forces you to write structured programs, overcoming a common criticism of Basic—namely, that it doesn't encourage structured programming. In addition, by downloading the flowchart and listings of each module to a printer, you can generate program documentation. To make the documentation easier to understand, listings for the standard module set include English-language descriptions of the module's function rather than containing only the Basic source code.

In addition to the normal debugging aids found in most of these programming packages—for example, breakpoint set, program-step, and trace-variable functions—Wavetest also includes a built-in IEEE-488 bus analyzer. This analyzer captures all IEEE-488 bus traffic, displaying both the talk and listen addresses associated with each message transfer and the transferred device-dependent data.

Although Wavetest recommends that you run Wavetest on an IBM PC/AT or compatible computer with 640k bytes of RAM, an EGA card and monitor, and a Microsoft Windows-compatible mouse, you can run the program on a monochrome IBM PC/XT. The \$3990 price includes Microsoft Windows, an IEEE-488 interface card for the PC, and an instrument library that currently contains drivers for over 50 popular IEEE-488 instruments.

National Instruments' latest software package, Labwindows, costs only \$495, but boasts IEEE-488 program-generation facilities similar to those provided in Summation's Testwindows package. Labwindows also runs on a wider range of IBM PCs—from a 512k-byte, IBM PC with at least two floppy-disk drives (however, the company recommends 640k bytes of RAM and a hard-disk drive) to an IBM PC/AT or PS/2—and allows you to

How to get A/D-D/A in one.

The pacesetter technology of our single-chip KSV3110 A/D-D/A flash converter provides independent 8-bit A/D converter functions and 10-bit R-2R D/A converter functions over an operating range of DC to 20MHz.

High performance at low cost.

Not only does the new KSV3110 operate from DC to 20MHz, it also gives TTL-compatible input/output, has

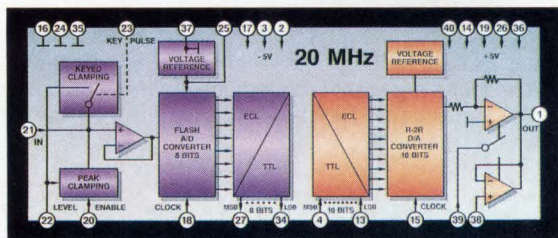

1% absolute non-linearity, and selectable input peak level or keyed clamping—all for less than half the cost.

Introducing a low-cost 20 MHz KSV3208 8-bit A/D converter.

The impressive linear characteristics of the KSV3110

FLASH CONVERTER PARTS LIST

Part	Resolution A/D	D/A	Linearity A/D	D/A	Conversion Speed	Industry Part
KSV3110N-10	8 bits	10 bits	$\pm\frac{1}{2}$ LSB	$\pm\frac{1}{2}$ LSB	20 MSPS	
KSV3110N-9	8 bits	10 bits	$\pm\frac{1}{2}$ LSB	± 1 LSB	20 MSPS	
KSV3110N-8	8 bits	10 bits	$\pm\frac{1}{2}$ LSB	± 2 LSB	20 MSPS	
KSV3110N-7	8 bits	10 bits	$\pm\frac{1}{2}$ LSB	± 4 LSB	20 MSPS	
KSV3100AN-8	8 bits	10 bits	$\pm\frac{1}{2}$ LSB	± 2 LSB	20 MSPS	UVC3101
KSV3100AN-7	8 bits	10 bits	$\pm\frac{1}{2}$ LSB	± 4 LSB	20 MSPS	UVC3101
KSV3208N	8 bits		$\pm\frac{1}{2}$ LSB		20 MSPS	

are shared by our new KSV3208. It provides the same features for those applications that don't require D/A conversion.

Samsung also offers the support chips needed to ease the integration of our flash converters into video applications: the KA2606 Sync Separate IC, the KA2153 Chrominance Signal Processor for NTSC systems, and the KA2154 Video Chroma Deflection System for NTSC and PAL systems.

Write or call Samsung Flash Converter Marketing today at 408-434-5400 for samples, data books, and a full listing of our data converter products.

Setting the pace.



SAMSUNG

Semiconductor
3725 North First Street
San Jose, CA 95134-1708

©1988 Samsung Semiconductor, Inc.

CIRCLE NO 45

TECHNOLOGY UPDATE

program in Microsoft QuickBasic and Microsoft C.

Part of the reason for the lower price is that Labwindows doesn't operate under Microsoft Windows, so the vendor doesn't have to pass along the cost of Windows to the consumer. Although you'll save money, however, you'll have to put up with a less-sophisticated programmer interface that uses simpler text-based screens, and you won't be able to work in multiple screen windows at the same time.

Labwindows provides three basic windows in which you can generate, edit, and execute application programs: a program-buffer window with a full-screen editor, a standard I/O screen that allows user-input and data display during program execution, and an interactive window that allows you to selectively execute or debug sections of program. As with Testwindows, Labwindows offers pull-down menus, so you can access the functions and libraries relevant to the window that you're working in, and you operate the windows and menus with the PC's keyboard or a mouse.

Labwindows was released at the end of February this year, and at that time its instrument library contained only six instrument drivers. Michael Santori, National Instruments' product marketing manager for Labwindows, points out that these drivers are included in the package largely to illustrate the type of drivers that users could write themselves. However, Santori says, the company will continue to develop and supply instrument drivers free of charge, at least until the library is large enough to satisfy the majority of users.

If you undertake the task of writing an instrument driver yourself, you'll have help: Labwindows provides libraries of IEEE-488 bus control, and data-formatting routines. As with the instrument library itself, you apply these libraries by using on-screen function panels selected from pull-down menus. The

IEEE-488 bus-control library contains more than 30 routines (the ones normally supplied in National Instruments' PC-DOS GPIB handler) which provide both high- and low-level control over the IEEE-488 bus. Labwindows also provides menu assistance in building the graphics screens for the instrument's on-screen function panels.

In addition to the GPIB and data-formatting libraries, Labwindows also comes with libraries of routines for presentation graphics and basic data analysis (for example, array arithmetic, complex arithmetic, and statistics). For an additional \$895, you can buy a library of advanced data-analysis routines.

All Labwindows' library routines are accessible from within the program's interactive environment via function panels. Once you've generated a complete program, you can run it through the Labwindows compiler or save it as QuickBasic or C source code, which you can run through third-party compilers if necessary.

Another software package, the Guru-II from Tektronix, is primarily intended to support waveform acquisition and analysis on the company's digitizers and digital oscilloscopes. Unlike the other packages

discussed so far, this package doesn't include an editor that allows you to generate on-screen, menu-driven instrument drivers for IEEE-488 instrumentation from other companies. What it does provide is a set of Basic subroutines that execute standard IEEE-488 bus functions (for example: send a bus message, read a device, conduct a serial poll) and a test-program generator that allows you to create tests and modify test procedures. However, when creating these test procedures, you'll have to enter the required instrument-programming strings manually. The Guru-II software package runs on the IBM PC, PC/XT, or PC/AT. It's available with or without an IEEE-488 interface card and interface cable; it costs \$850 with the card and cable and \$450 without.

Back to Basic

All the IEEE-488 program-generation packages discussed so far allow you to program directly in Basic if you want to. At times, the ability to write directly in Basic—coupled with a thorough understanding of IEEE-488 bus protocols and instrument operation on the bus—may prove invaluable.

For example, if you want a high-

For more information . . .

For more information on the IEEE-488 program-generation tools described in this article, contact the following manufacturers directly, circle the appropriate numbers on the Information Retrieval Service card, or use EDN's Express Request service.

Asyst Software Technologies Inc
100 Corporate Woods
Rochester, NY 14623
(716) 272-0070
Circle No 700

Lotus Development Corp
55 Cambridge Parkway
Cambridge, MA 02142
(617) 577-8500
Circle No 701

National Instruments Corp
12109 Technology Blvd
Austin, TX 78727
(512) 250-9119
Circle No 702

Summation Inc
11335 NE 122nd Way
Kirkland, WA 98034
(206) 823-8688
Circle No 703

Tektronix Inc
Box 1700
Beaverton, OR 97075
(503) 627-7111
Circle No 704

Wavetek Inc
9045 Balboa Ave
San Diego, CA 92123
(619) 279-2200
Circle No 705

THE TANTALUM PLACE.

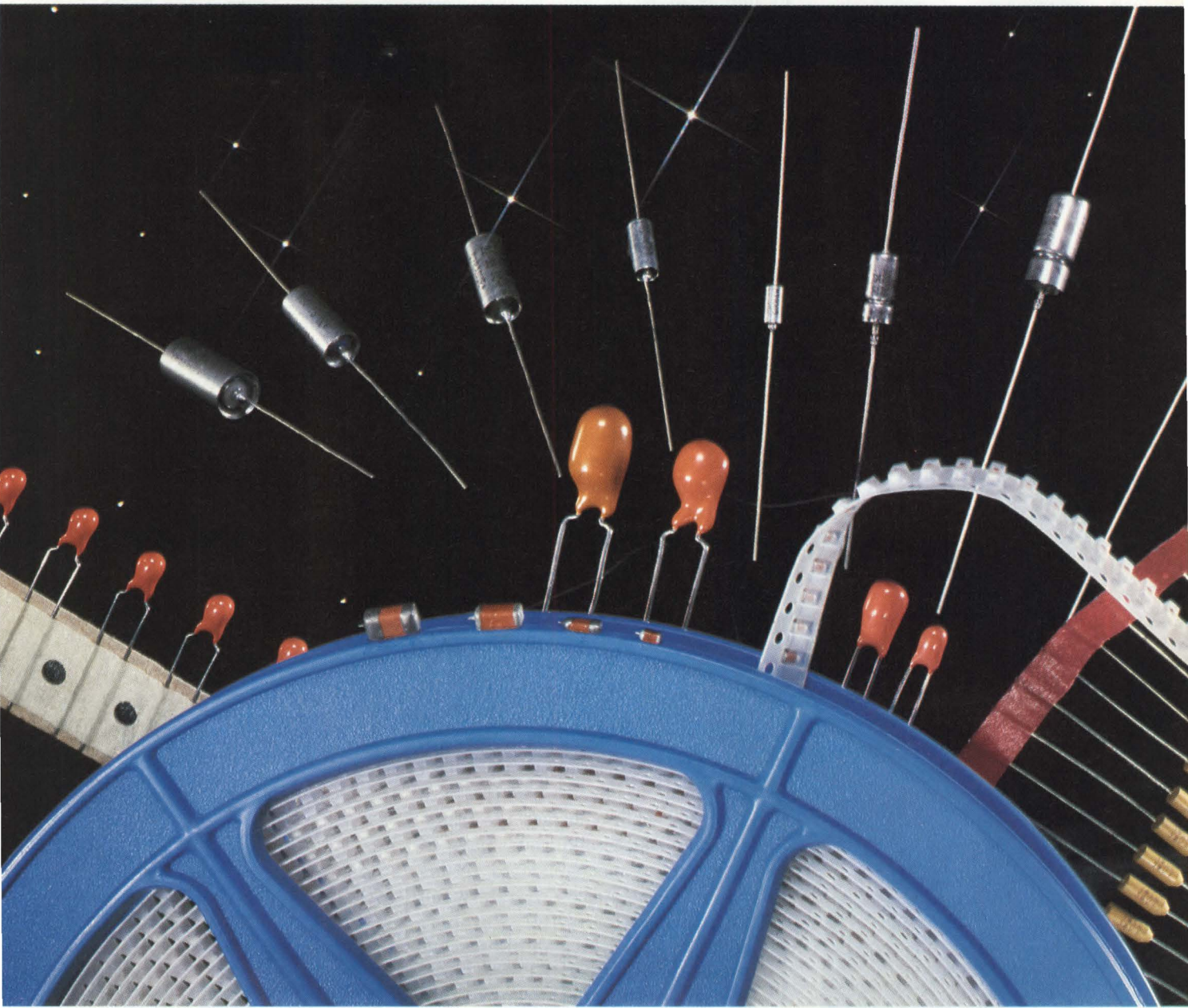

4SW-4133R5

SPRAGUE IS THE TANTALUM SUPPLIER... TODAY & TOMORROW.

You can count on getting the Sprague tantalum capacitors you want when you want them. Sprague is the key source of supply for all types of tantalum capacitors . . . solids, wets, and foils. And Sprague makes tantalums in the U.S. as well as in Europe, in Southeast Asia, in Japan,

and in Canada. Almost anywhere you're located, you can benefit from local approvals, local support, and local service. Sprague is committed to making the most reliable tantalums in the world. So when you need tantalum capacitors, look to Sprague for reliability and performance today and tomorrow.

For additional information on product assistance, delivery, or price, contact your Sprague Electric district office or sales representative. For a copy of our new Quick Guide To Tantalum Capacitors ASP-638, write to Technical Literature Service, Sprague Electric Company, P.O. Box 9102, Mansfield, MA 02048-9102.



CIRCLE NO 46

The Ultimate Programmer:

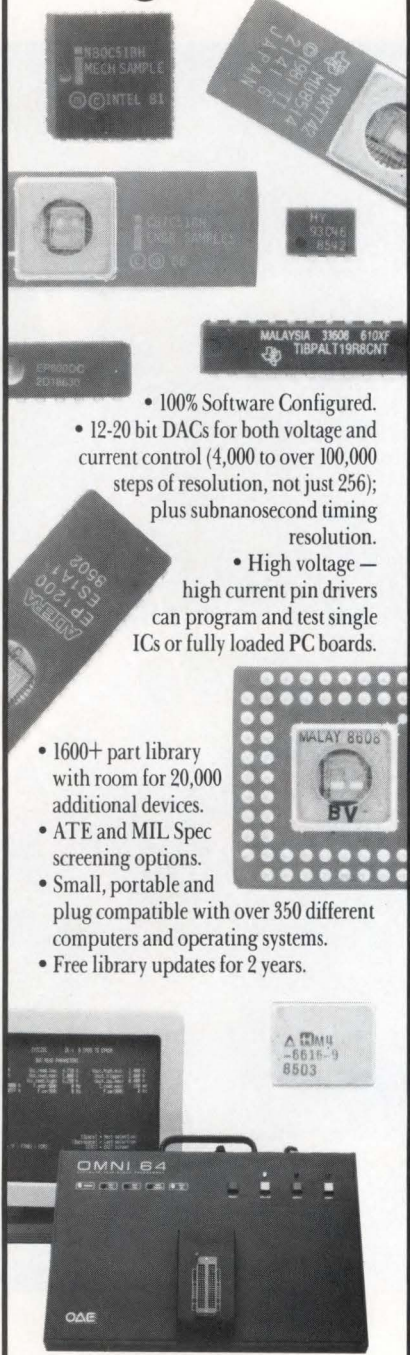

- 100% Software Configured.
- 12-20 bit DACs for both voltage and current control (4,000 to over 100,000 steps of resolution, not just 256); plus subnanosecond timing resolution.
- High voltage — high current pin drivers can program and test single ICs or fully loaded PC boards.

- 1600+ part library with room for 20,000 additional devices.
- ATE and MIL Spec screening options.
- Small, portable and plug compatible with over 350 different computers and operating systems.
- Free library updates for 2 years.

The OMNI. With prices that start at just \$3,250, why settle for anything less?



Oliver Advanced Engineering, Inc.
320 West Arden Street
Glendale, CA 91203
(818) 240-0080
(800) 828-0080
(800) 423-8874 in California.
TWX (510) 600-8099 FAX (818) 240-6131

CIRCLE NO. 49

UPDATE

speed instrument to operate continuously at its maximum read rate and to send measurement data over the IEEE-488 bus, you'll probably need to set up a fast I/O channel. This task involves leaving the instrument addressed to talk and opening up a DMA channel to transfer the instrument's output data directly into the PC's memory. Because you can't afford the overhead of sending the instrument an Untalk (UNT) command followed by a group-execute-trigger (GET) command, you'll have to operate the instrument in an automatic-retriggering mode, so that it retriggers itself as soon as it has generated (but not sent out) new measurement data. When you're operating the instrument in this maximum read-rate mode, you'll have to ensure that the instrument can send its data over the IEEE-488 bus during the time it takes to generate new measurement data—for example, during the conversion period of an A/D converter or the gating period of a counter.

In addition, to ensure that the PC's IEEE-488 interface gets instant DMA access to the PC's data bus, you may have to halt the PC's processor while the fast I/O transfers take place, and you'll have to implement a mechanism to return control to the Basic program when the DMA buffer is full. Further, don't be fooled into thinking that just because your IEEE-488 interface card specs a data-transfer rate of 1M byte/sec, data transfers will take place at that rate. The IEEE-488 handshake is a two-way affair involving both the interface card and the addressed instruments. Typical instruments will slow the actual transfer rate to a few hundred thousand bytes per second.

EDN

Article Interest Quotient
(Circle One)
High 515 Medium 516 Low 517

SSI TELECOM INTEGRATED CIRCUIT FAMILIES

SPOTLIGHT #32
IN A SERIES

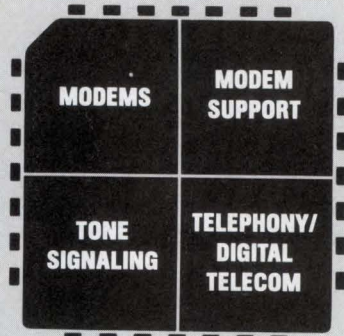

Silicon Systems has developed the following families of advanced telecommunication chips.

MODEMS: Silicon Systems offers the industry's most advanced designs in single-chip modem IC's. All members of the SSI K-Series family of one-chip modems are designed to the same footprint, with total hardware and software compatibility, allowing easy product upgrading over the entire Bell and CCITT range of full-duplex, split-band standards at data transfer speeds from 300 to 2400 BPS.

MODEM SUPPORT: SSI has designed a line of high performance filters, special purpose FSK modems, and high speed modem analog processors, which make possible efficient modem designs for custom applications.

TONE SIGNALING: Since pioneering the DTMF receiver, SSI has not only developed a whole family of DTMF receivers but has also introduced DTMF transceivers that can both generate and detect all 16 standard Touch-Tone digits. This Tone Signaling Family of products also includes a group of telephone-band call progress detector chips, which simplify design of automatic calling systems.

TELEPHONY / DIGITAL TELECOM: This family is comprised of standard integrated circuits for use in T1 transmitters and receivers, as well as chips for DS-1 line interfacing, central office MF tone detection, and 4-wire loopbacks for use in low-cost maintenance termination units.

Send for the Silicon Systems Telecom and Modem brochures today. **Silicon Systems**, 14351 Myford Road, Tustin, CA 92680.

Phone: (714) 731-7110, Ext. 575

silicon systems
INNOVATORS IN INTEGRATION

"YOU NAME THE APPLICATION— WE'VE GOT THE MODEM IC."

For Today's Designs

A quick glance at our Selection Chart shows that at data transfer speeds of 300 to 2400 BPS for U.S. or world-wide market applications, Silicon Systems has the industry's most advanced family of pin-compatible, single-chip modems available now for your current designs.

For Tomorrow's Designs

We call this versatile family the SSI K-Series line of single-chip modems. These CMOS integrated circuits are all software and hardware compatible, allowing for easy product upgrading over the entire Bell and CCITT ranges of full-duplex, split-band telecom standards needed for your present and future designs.

Special Features For Special Applications

The family includes an easy-to-use micro-processor control interface, and versatile features suitable for a wide variety of applications. The "U" versions integrate an industry standard UART with the modem function in a design optimized for integral bus applications, and the low-power "L" versions operate from a single + 5 volt supply, making portable, battery, or line powered designs possible.

Call Now!

(714) 731-7110, Ext. 575

For more information on the K-Series Family, or our complete line of Tone Signaling, Telephony, and Digital Telecom products, send for our Modem and Telecom brochures today.

Silicon Systems,
14351 Myford Road,
Tustin, California 92680.

*silicon systems*TM
INNOVATORS IN INTEGRATION

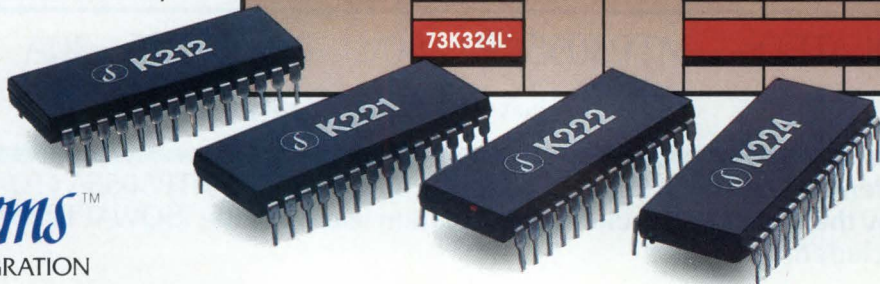

MODEM IC SELECTION CHART

APPLICATIONS	PRODUCTS	OPERATING MODES						PRODUCT FEATURES
		103 0-300 BPS	212A 1200 BPS	V.21 0-300 BPS	V.22 600/ 1200 BPS	V.22 bis 1200/ 2400 BPS	V.23 0-1200 BPS	
UNIVERSAL APPLICATIONS Stand-Alone or Integral Modem Designs	73K212	█						High performance single-chip modems with easy-to-use cost-effective features.
	73K221			█				
	73K222				█			
	73K224					█		
LOW POWER APPLICATIONS • Lap Tops • Portable Terminals • Line Powered Modems • Battery-Powered Units	73K212L	█						High performance single-chip modems providing low-power operation from a single + 5 volt supply.
	73K221L			█				
	73K222L				█			
	73K224L					█		
DEDICATED INTEGRAL APPLICATIONS • Bus-Oriented Systems • Credit Verification • Automatic Teller Machines • Pay Telephones • Diagnostic Equipment	73K212U	█						Enhanced single-chip modems with a fully integrated 16C450 UART function, and added circuitry to simplify integral designs.
	73K221U			█				
	73K222U				█			
EUROPEAN DATA COM APPLICATIONS Multi-standard modems requiring videotex compatibility	73K322*			█				Single-chip modems add V.23 and special features to standard operating modes; available in +12 volt or +5 volt versions. * Available 1988
	73K322L*				█			
	73K324*					█		
	73K324L*						█	

"Where we design to your applications."

Circle No. 47 for career information

Circle No. 48 for product information

This Year's Brightest a Variety

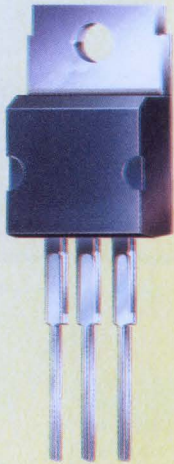

Black

Ultra fast switching and reliability for less than a quarter! No wonder our MTP3055A Power MOSFET in TO-220 is such a bright idea—even in basic black. But if you want to see real high-tech chic, take a look below at the Power MOSFET package that's getting everyone's attention.

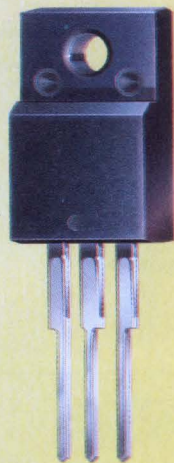

& Black

MTP3055AP. Black on black (That's right no metal on the back)! Only four cents more and worth every penny. Because this SGS-THOMSON developed package—the breakthrough ISOWATT220™—is "FULLY ISOLATED" to 2000V DC (guaranteed) with thermal performance equal to non-isolated technology. Mounts directly to a heatsink with no insulating washers, bushings, etc. needed. Actually cuts parts and assembly costs, while improving equipment quality and reliability. No wonder SGS-THOMSON Microelectronics is the brighter power.

PACKAGE	TYPE	V_{DSS}	$R_{DS(ON)}$	I_D	P_D
FULLY ISOLATED	MTP3055AP	60V	0.15 OHMS	10A	30W
NON-ISOLATED	MTP3055A	60V	0.15 OHMS	12A*	40W*

*Parts have identical electrical characteristics. I_D and P_D for the MTP3055A (TO-220) need to be derated by the designer depending on isolation used. For the ISOWATT220, this derating is already included.

Power FETs Come in of Colors.

Free Brighter Power Data Book.

Take an in-depth look at the bright side of Power MOS. Send for your free copy of the SGS-THOMSON Power MOSFET data book. It includes a wide range of industry standard Power MOSFETs—all of them available in SGS-THOMSON's revolutionary cost, space and time-saving ISOWATT220 and ISOWATT218™ packages.

Call 602/867-6259 now or write: SGS-THOMSON Microelectronics, 1000 East Bell Road, Phoenix, Arizona 85022. The brighter your Power MOSFETs, the brighter your design's future.

ISOWATT220 and ISOWATT218 are trademarks of SGS-THOMSON Microelectronics.



SGS-THOMSON
MICROELECTRONICS

CIRCLE NO 50

μ P SUPERVISORY IC PERFORMS ALL ANALOG FUNCTIONS

So long multi-component supervisory solutions. Hello MAX690/691.

Defined to drastically reduce design complexity and component count, the MAX690 and MAX691 from Maxim are likely the only 'housekeepers' your μ P will ever need.

The MAX690 combines all the supervisory functions that μ Ps commonly need into a single CMOS IC. It comes in an 8-pin package that's ideal for applications where board space is at a premium.

The 16-pin MAX691 adds versatility to the basic MAX690 for applications that require chip-enable gating and programmability of timing. Both monitor your μ P and its power supply with improved voltage accuracy and reset reliability compared to discrete circuits.

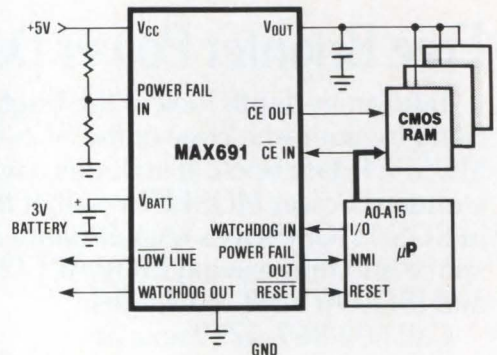

Power-On Reset.

The MAX690 and 691 have a precise 4.65V threshold detector and 50ms timer that generates an accurate reset signal for any power-on, brown-out or momentary interrupt condition.

Internal Watchdog Timer.

A watchdog circuit built into each MAX690/691 constantly monitors all μ P activity. It detects both hardware and software malfunctions and automatically issues a reset command to the μ P—effectively eliminating 'lock-up' conditions.

Automatic Battery Switchover.

The MAX690 and 691 constantly monitor incoming power and automatically switch to battery back-up mode when the power supply drops below the battery voltage. This lowers quiescent current to less than 1μ A and ensures that data in CMOS RAM or EEPROM remains intact until power is restored.

Power-Fail Detection.

An uncommitted 1.25V threshold comparator is built into each MAX690/691 for use as a power-fail indicator or for monitoring the back-up battery voltage. Like many of the functions on-board the 690/691, built-in power-fail detection can save you components and valuable design time.

Both the MAX690 and MAX691 are available in DIP and S.O. packages and—like every other Maxim part—each is tested to rigorous reliability standards absolutely free. At \$3.30* and \$3.80* respectively, they offer you a price/performance value unmatched in the marketplace.

Call your authorized Maxim representative or distributor today for data sheets and samples. And tell them you'd like a new housekeeper. Maxim Integrated Products, 510 N. Pastoria Ave., Sunnyvale, CA 94086, (408) 737-7600.

* 100-up price



Distributed by Anthem/Lionex, Bell/Graham, Hall-Mark, and Pioneer. Authorized Maxim Representatives: Alabama, (205) 830-4030; Arizona, (602) 860-2702; California, (408) 727-8753, (619) 278-8021; (714) 739-8891; Colorado, (303) 841-4888; Connecticut, (203) 754-2823; Florida, (305) 365-3283; Georgia, (404) 992-7240; Idaho, (503) 620-1931; Illinois, (312) 956-8240; Indiana, (317) 849-4260; Iowa, (319) 377-8275; Kansas, (316) 838-0884, (913) 339-6333; Maryland, (301) 799-7490; Massachusetts, (617) 449-7400; Michigan, (313) 968-3230; Minnesota, (612) 944-8545; Missouri, (314) 291-4777; Montana, (503) 620-1931; Nevada, (408) 727-8753; New Jersey, (609) 933-2600, (201) 428-0600; New Mexico, (505) 884-2256; New York, (516) 752-1630, (315) 437-8343; North Carolina, (919) 846-6888; Ohio, (216) 659-9224, (513) 278-0714, (614) 895-1447; Oklahoma, (214) 386-4888; Oregon, (503) 620-1931; E. Pennsylvania, (614) 895-1447; W. Pennsylvania, (609) 933-2600; South Carolina, (704) 365-0547; Tennessee, (404) 992-7240; Texas, (214) 386-4888, (512) 451-2757, (713) 778-0392; Utah, (801) 266-9939; Virginia, (301) 621-1313; Washington, (206) 453-8881; Wisconsin, (414) 476-2790; Canada, (416) 238-0366, (604) 439-1373, (613) 726-9562, (514) 337-7540.

Maxim is a registered trademark of Maxim Integrated Products. ©1988 Maxim Integrated Products.

Largest-ever Electro adds software to its showcase of electronics technology

Tarlton Fleming, *Associate Editor*

The theme for the Electro/88 conference, scheduled for May 10 through 12 at Boston's Bayside Exposition Center and World Trade Center, centers on the technology bridge between hardware and software. To underscore this theme and emphasize the growing importance of software in the development of electronic products, the show is featuring a "spotlight on software." There will be 35 software-oriented technical sessions, and a record number of software companies will be exhibiting. As usual, Electro's other exhibits, technical presentations, and general-interest events should draw a large audience from the electronics community. The show's sponsors, the IEEE and the Electronics Representatives Association, expect attendance to be about 50,000.

Electro and Mini/Micro Northeast were separate conferences last year, but Electro/88 will combine the two and offer 1300 exhibits and 54 technical sessions. Exhibition hours are 9:30 AM to 5:00 PM; technical-session hours are 9:00 AM to 5:30 PM. Before April 21, the registration fee is \$5; after that, admission is \$20 (\$10 for IEEE and ERA members).

IEEE awards medals

Two IEEE awards ceremonies will precede the official activities of Electro/88. In the Sheraton-Boston Hotel at a noon luncheon on Monday, May 9, the IEEE Engineering Leadership Recognition and the Corporate Innovation Recognition awards will take place. At 6:00 PM, the hotel will host the IEEE's annual medals presentation, which will include the awarding of three newly established medals. These activities are open to members only.

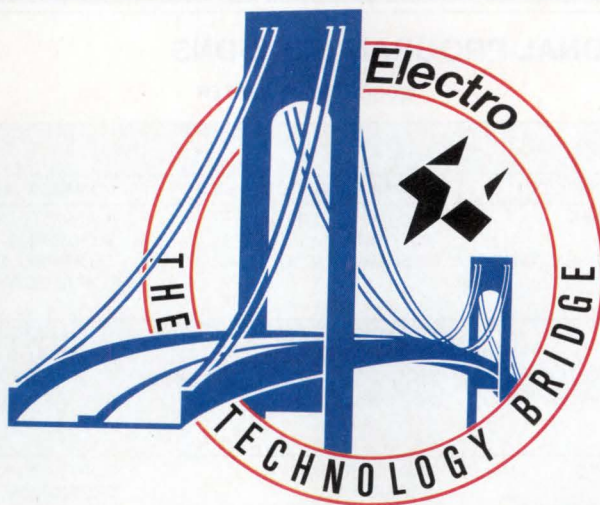

Several other special events are scheduled during Electro/88. On Tuesday May 10, Lester C Thurow will deliver the keynote address, "building a world-class US economy." Thurow is an economist, a professor of management and economics at MIT, and the dean of MIT's Sloan School of Management. The keynote breakfast will be held at Anthony's Pier 4 restaurant at 8:00 AM.

A marketing-management conference, "how to pick the right sales force and make it work," will offer insights into choosing the proper sales channels, measuring results, and motivating salespeople to generate forecasts. The 2-hour conference, based on case histories and featuring audience participation, will begin at 10:00 AM on Wednesday, May 11, in the World Trade Center. Marketing consultants John Haskell and Jerry Frank will run the conference.

At noon on Wednesday, Michael Tinkham will speak on "superconductivity, past, present, and future" at Anthony's Pier 4 restaurant. Tinkham is a professor of physics at Harvard University and an experi-

menter in superconductivity. The talk is open by invitation only to IEEE life members (those for whom their age plus years in the IEEE adds up to at least 100). Admission is \$2.50 for members and spouses, and \$15 for guests.

Tutorial sessions are free

Last year at Electro, you had a choice of five tutorial sessions that cost between \$280 and \$410 for non-IEEE members. This year's 12 tutorials, mixed into the schedule of professional-program sessions, are free. These tutorials offer you an overview of a subject that may not be within your field. For convenience, many are followed by one or more sessions on related topics. Some topics are marketing, technical documentation, electronic publishing, software development, GaAs devices, testing, CAE, CIM, and mechanical CAD/CAM.

Highlights of the technical sessions include "simulation of analog and mixed-mode circuits," "floating-point coprocessors for advanced personal microprocessors," "RISC technology enters the mainstream," "high-temperature superconduc-

TECHNOLOGY UPDATE

tors," "robots in the real world," "development tools for digital-signal processors," and "recent advances in 'application-specific' PLDs."

In addition to the applications-oriented technical presentations,

the professional-program sessions cover an assortment of nontechnical engineering issues. These include "engineering education—responding to real-world demands," "Strategic Defense Initiative: assessment

of progress and prospects," "supporting the ethical engineer," and "social implications of artificial intelligence."

The exhibits at Electro/88 will cover active and passive compo-

PROFESSIONAL-PROGRAM SESSIONS

WORLD TRADE CENTER

			TUESDAY, MAY 10
COMMERCIAL COMPLEX 1	COMMERCIAL COMPLEX 2	COMMERCIAL COMPLEX 3	TEACHERS UNION E
9:00 AM TO 11:30 AM TUTORIAL 1 MARKETING, THE KEY TO PRODUCT SUCCESS	9:00 AM TO 11:30 AM TUTORIAL 2 ELECTRICAL CAD	9:00 AM TO 11:30 AM TUTORIAL 3 TECHNICAL DOCUMENTATION FOR ELECTRONIC PRODUCTS	9:00 AM TO 11:00 AM SESSION 4 MODERN METEOR-BURST COMMUNICATIONS
12:30 PM TO 2:30 PM SESSION 7 SALES AND MARKETING: CLOSING THE SOFTWARE GAP	12:30 PM TO 2:30 PM SESSION 8 MODELING STRATEGIES FOR ASIC DESIGN	12:30 PM TO 2:30 PM TUTORIAL 9 COMPUTER-AIDED ACQUISITION AND LOGISTIC SUPPORT (CALs)	12:30 PM TO 2:30 PM SESSION 10 HIGH-TEMPERATURE SUPERCONDUCTORS
3:30 PM TO 5:30 PM SESSION 13 EXPORTING SOFTWARE TO JAPAN—FACT OR FANTASIES	3:30 PM TO 5:30 PM SESSION 14 DESIGN TOOLS FOR NEW PROGRAMMABLE SILICON DEVICES: DOES ONE SIZE FIT ALL?	3:30 PM TO 5:30 PM SESSION 15 CORPORATE ELECTRONIC PUBLISHING	3:30 PM TO 5:30 PM SESSION 16 ROBOTS IN THE REAL WORLD
			WEDNESDAY, MAY 11
9:00 AM TO 11:30 AM TUTORIAL 19 ENGINEERING TO MEET CUSTOMER NEEDS	9:00 AM TO 11:30 AM TUTORIAL 20 SOFTWARE DEVELOPMENT FOR REAL-TIME EMBEDDED SYSTEMS	9:00 AM TO 11:30 AM TUTORIAL 21 DESIGN FOR TESTABILITY	9:00 AM TO 11:30 AM TUTORIAL 22 COMPUTER INTEGRATED MANUFACTURING AND BUSINESS DECISIONS
12:30 PM TO 2:30 PM SESSION 25 SYSTEM SOLUTIONS FOR INCREASING SALES AND MARKETING PRODUCTIVITY	12:30 PM TO 2:30 PM SESSION 26 CASE TOOLS IMPROVE MANAGEMENT OF THE SOFTWARE CYCLE: INTRODUCTION, USAGE, HISTORIES, FUTURE TRENDS	12:30 PM TO 2:30 PM SESSION 27 SUCCESSFUL SYSTEM-DESIGN TECHNIQUES USING ASICs	12:30 PM TO 2:30 PM SESSION 28 CLEAN-ROOM AUTOMATION FROM CIM TO ROBOTS
3:30 PM TO 5:30 PM SESSION 31 SOFTWARE DESIGN TECHNIQUES FOR INNOVATIVE PLD ARCHITECTURE	3:30 PM TO 5:30 PM SESSION 32 COMPUTER-AIDED SOFTWARE ENGINEERING (CASE)	3:30 PM TO 5:30 PM SESSION 33 CHARACTERIZATION AND TESTING OF ANALOG-TO-DIGITAL CONVERTERS FOR DIGITAL SIGNAL PROCESSING APPLICATIONS	3:30 PM TO 5:30 PM SESSION 34 MACHINE-VISION APPLICATIONS IN ELECTRONICS MANUFACTURING
			THURSDAY, MAY 12
9:00 AM TO 11:30 AM TUTORIAL 37 MARKETING YOUR PRODUCT, YOUR DEAL, AND YOUR COMPANY	9:00 AM TO 11:00 AM SESSION 38 ENGINEERING EDUCATION—RESPONDING TO REAL WORLD DEMANDS	9:00 AM TO 11:00 AM SESSION 39 STRATEGIC DEFENSE INITIATIVE: ASSESSMENT OF PROGRESS AND PROSPECTS	9:00 AM TO 11:30 AM TUTORIAL 40 MECHANICAL CAD/CAM
12:30 PM TO 2:30 PM SESSION 43 SIMULATION OF ANALOG AND MIXED-MODE CIRCUITS	12:30 PM TO 2:30 PM SESSION 44 THE ROLE OF CONFIGURATION-MANAGEMENT TOOLS IN SOFTWARE DEVELOPMENT ENVIRONMENTS	12:30 PM TO 2:30 PM SESSION 45 SOFTWARE TOOLS FOR TEST AND MEASUREMENT APPLICATION PROGRAM DEVELOPMENT	12:30 PM TO 2:30 PM SESSION 46 HIGH-INTEGRATION SOLUTIONS FOR PERSONAL COMPUTER/PERSONAL SYSTEM DESIGN
3:30 PM TO 5:30 PM SESSION 49 LEAP INTO THE 90s WITH AN ACCELERATED NEW-PRODUCT DEVELOPMENT CYCLE	3:30 PM TO 5:30 PM SESSION 50 UNIQUE SOFTWARE CONSIDERATIONS FOR MICROCONTROLLERS WHEN LISTING HIGH-LEVEL LANGUAGES	3:30 PM TO 5:30 PM SESSION 51 TEST PROGRAM GENERATION: EXTRACTING TESTER PROGRAMS FROM SIMULATION	3:30 PM TO 5:30 PM SESSION 52 INDUSTRIAL REQUIREMENTS FOR REAL-TIME DIGITAL SIGNAL PROCESSING (DSP) APPLICATIONS

TECHNOLOGY UPDATE

nents, microelectronics, computer hardware and software, instrumentation, test equipment, control systems, production equipment, assembly tooling, mechanical/electronic packaging, and power sources. **EDN**

Article Interest Quotient
(Circle One)
High 518 Medium 519 Low 520

BAYSIDE EXPOSITION CENTER

TEACHERS UNION F

9:00 AM TO 11:30 AM
TUTORIAL 5
IMPLEMENTING COMPUTER INTEGRATED MANUFACTURING (CIM)

12:30 PM TO 2:30 PM
SESSION 11
INTRODUCING NEW PRODUCTS TO MANUFACTURING THROUGH CIM

3:30 PM TO 5:30 PM
SESSION 17
PROCESS PLANNING AND SIMULATION OF MANUFACTURING OPERATIONS

9:00 AM TO 11:00 AM
SESSION 23
RECENT ADVANCES IN "APPLICATION SPECIFIC" PLDs

12:30 PM TO 2:30 PM
SESSION 29
ARTIFICIAL INTELLIGENCE IN MANUFACTURING

3:30 PM TO 5:30 PM
SESSION 35
PUBLISHING OPPORTUNITIES IN THE IEEE

9:00 AM TO 11:00 AM
SESSION 41
COMPUTER BACKPLANE INTERFACE USING HIGH-SPEED LOW-POWER CMOS INTERFACE ICs

12:30 PM TO 2:30 PM
SESSION 47
MECHANICAL CAE IMPACTS ON PRODUCT DEVELOPMENT

3:30 PM TO 5:30 PM
SESSION 53
SUPPORTING THE ETHICAL ENGINEER

TEACHERS UNION G

9:00 AM TO 11:30 AM
TUTORIAL 6
INTRODUCTION TO GaAs DEVICES, TESTING AND EVALUATION METHODS

12:30 PM TO 2:30 PM
SESSION 12
ADVENTURES IN TECHNOLOGICAL INNOVATION: HOW THE MASSACHUSETTS MIRACLE WORKS

3:30 PM TO 5:30 PM
SESSION 18
DEVELOPMENT TOOLS FOR DIGITAL SIGNAL PROCESSORS (DSPs)

9:00 AM TO 11:00 AM
SESSION 24
ENHANCING GLOBAL SECURITY THROUGH INFORMATION SHARING

12:30 PM TO 2:30 PM
SESSION 30
RISK ASSESSMENT AND RESPONSE

3:30 PM TO 5:30 PM
SESSION 36
SOCIAL IMPLICATIONS OF ARTIFICIAL INTELLIGENCE

9:00 AM TO 11:00 AM
SESSION 42
RISC TECHNOLOGY ENTERS THE MAINSTREAM

12:30 PM TO 2:30 PM
SESSION 48
FLOATING-POINT COPROCESSORS FOR ADVANCED PERSONAL MICROPROCESSORS

3:30 PM TO 5:30 PM
SESSION 54
AN ARCHITECTURAL OVERVIEW OF CACHE CONTROLLERS FOR 32-BIT MICROPROCESSORS

MCI
introduces
three new low
cost temperature
controllers.

In Stock for
Immediate
Delivery



SAS Bi-Metal Switch

SAH Hermetic Bi-Metal Switch



MTS Reed Switch

SAS Bi-Metal Switch

- Operated by 1/2" dia. bimetal disc
- Good for 100,000 cycles
- 5°C to 175°C in 5° increments
- Large or small quantities available
- Many non-standard terminal configurations offered at no extra cost
- U.L., C.S.A. Approved
- Competitively priced

SAH Hermetic Bi-Metal Switch

- Hermetically sealed T-05 case allows wave soldering
- Good for 40,000 cycles
- PC board mountable
- 30°C to 120°C in 10° increments
- Large or small quantities available
- U.L., C.S.A. Approved
- Competitively priced

MTS Reed Switch

- Hermetically sealed in glass
- Low contact resistance (100 Milliohms or less)
- 3,000,000 operations at a full rated load
- Smaller size for faster response
- -5° to 115°C in 5° increments
- Tight reset tolerances
- U.L. Approved
- Competitively priced

All three switches available in normally open and normally closed configurations.

Call or write for your free temperature control manual and engineering sample.

MIDWEST
COMPONENTS
INC.

Midwest Components, Inc.
P.O. Box 787
1981 Port City Boulevard
Muskegon, MI 49443
(616) 777-2602 FAX 616-773-4307

A Good Deal. A Good Deal Faster.



*The Key Tronic 101.
Priced Right.*

Right now Key Tronic has thousands of top quality 101 keyboards in stock at competitive prices.

Also available is our popular 102 model in ten European languages.

Because we manufacture and stock the 101 and 102 at three different locations around the world, you won't have to wait for delivery. Regardless of your deadline or location.

The 101 and 102 are built to Key Tronic's high standards of quality. Standards that have made Key Tronic the world's leading independent

keyboard manufacturer. Take our 100 million cycle guarantee, for example.

What's more, the keyboards are switch selectable to work with standard or enhanced PCs, XT's, AT's, as well as most compatibles.

And like all our keyboards, the 101 and 102 have the famous Key Tronic touch that really makes a difference in speed and productivity.

Whether you choose the 101 or 102, orders placed on Monday will be shipped by Friday. So quality worth waiting for



*Our inventory's in stock.
Ready for immediate delivery.*

*101s and 102s
can be shipped
within
five days of
your order.*



really requires no waiting at all.

For a good deal on a great keyboard, call your local Key Tronic representative today. Or call Key Tronic, OEM Sales at (509) 928-8000.

key tronic
The Responsive Input Company



The Key Tronic 101 Keyboard.

Make it friendly. Touch it.



Design a system that gives you a competitive edge. Make it simple to use. Easy to learn. Make it friendly. With a touch input system from Carroll Touch, the world's leading OEM supplier of touch products.

Discover the full line of solutions Carroll Touch offers. From infrared to overlay touch products. Select from a wide range of standard add-on units in a variety of sizes. Or from a line of fully integrated computer displays equipped with touch. Or specify your own unique requirements.

Once you've chosen the Carroll Touch product that's right for your system, you'll discover even more. Exceptional quality and ruggedness. High reliability. Low maintenance. Making touch more affordable and cost-effective than ever.

Whether it's sophisticated test equipment for automotive technicians. Or a medical diagnostic system for patient care. Make your next system friendly. Touch it. Begin by calling 512/244-3500.

See us at Electro Booths 523 and 525

Carroll Touch

a subsidiary of AMP Incorporated

P.O. Box 1309
Round Rock, Texas 78680
512/244-3500 Telex 881906

CIRCLE NO 55



Burndy introduces the world's most advanced connector for the world's most advanced personal computers.

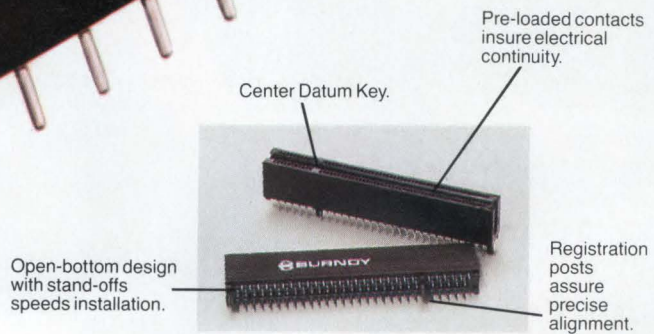

Polyphenylene Sulfide housing for greater dimensional stability.

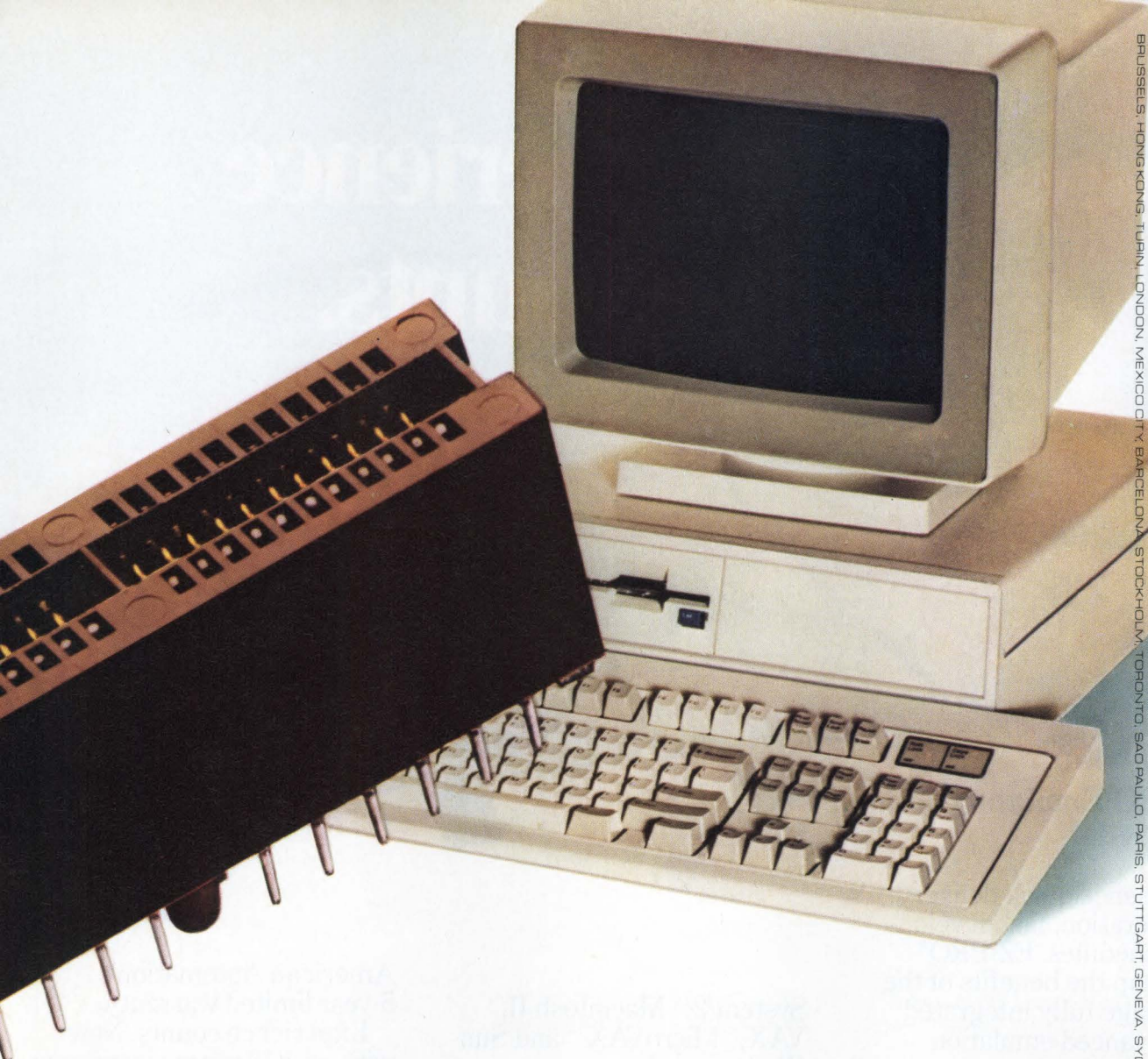

BRUSSELS, HONG KONG, IJLAIN, LONDON, MEXICO CITY, BARCELONA, STOCKHOLM, TORONTO, SAO PAULO, PARIS, STUTTGART, GENEVA, SYDNEY, TOKYO, DOMINICAN REPUBLIC, AUSTRALIA, NORWALK, CT AND THROUGHOUT THE U.S.

BURNDY-VALUE BY DESIGN

COMPUTERBUS®—the new card-edge connector that's setting the standard for 2nd generation PCs.

Developed for one of the world's leading computer companies, it represents state-of-the-art technology from start to finish.

New concepts. New materials. New manufacturing techniques have all been incorporated into this remarkable connector.

The results are outstanding.

It's a high density .050 connector. Which means overall space and weight reduction. Shorter signal paths. And greater design flexibility.

It's cost-effective. Engineered that way—with everything designed for quick, easy installation and robotic handling.

It has unmatched reliability over

repeated card insertion and withdrawal cycles through severe environmental testing. Built for maximum durability, it incorporates state-of-the-art material and design concepts for dimensional stability and predictable performance over time.

It's a shortcut to compatibility. It's already the standard for 2nd generation PC plug-in feature cards. And it's available now. Today. For test and evaluation. Or in quantity for full production runs. Get the complete story. Call or write: Burndy Corporation, Norwalk, CT 06856. (203) 852-8337.



Experience Counts.



EZ-PRO Emulators

Experience quick delivery, easy operation, fast development schedules. EZ-PRO® users reap the benefits of the C language fully integrated with advanced emulation tools, including precedence triggering, Deep Trace™, on-line code revisions, and performance analysis tools.

In addition to IBM® PC-XT/AT, hosts include IBM Personal

System/2™, Macintosh II™, VAX™, MicroVAX™, and Sun Workstation®.

EZ-PRO users also have the advantage of the best post-sales support in the industry.

They know that their emulators are covered by

American Automation's 5-year limited warranty.

Experience counts. Now with over 10 years experience, American Automation has designed more emulators than anyone. Count on EZ-PRO to provide the most cost/effective development support.

Intel: 8031	Motorola: 6800	Hitachi: 6301R	Rockwell: 6502	RCA: 1802	Zilog: Z80A
8032	68B00	6301V1	6503	1805	Z80B
8086 8035	68HC11A2	6301X	6504	1806	Z80H
8088 8039	68HC11A8	6802	6505	CDP6805C4	Z180
80186 8344		68B02	6506	CDP6805C8	Z8001
80188 8048	68000	146805E2	6507	CDP6805D2	Z8002
80286 8049	68008	6803	6512	CDP6805E3	
8050	68010	6808	6513		
8051		68B08	6514	Harris: 80C86	NEC: V20 V40
8085A		6809	6515	80C88	V30 V50
8085A2		6809E		National: NSC800	Signetics: 8X300
8096/97		68B09			8X305
		68B09E			

...AND MORE

*Assumes EZ-PRO Development Station connected to MSDOS host.

american automation 

2651 Dow Avenue, Tustin, California 92680 (714) 731-1661

FAX: 714/731-6344

CIRCLE NO 57

IBM is a registered trademark of International Business Machines, VAX and MicroVAX are registered trademarks of Digital Equipment Corporation, Macintosh is a registered trademark of Apple Computer, Inc., Sun Workstation is a registered trademark of Sun Microsystems, Inc.

INTRODUCING 2AG FUSES

The world's smallest glass fuse.



Actual size: 0.177" diameter x 0.58" long;
Slo-blo® and fast-acting types, rated: ¼~7A, 250V or less.

Now you can get 3AG reliability and performance in a new economical subminiature size. Our Slo-blo® and fast-acting fuses are perfect for p.c. board and other limited space applications. Order them in bulk, or on tape and reel for high speed automatic insertion. New mating 2AG p.c. board fuse clips are also available.



CIRCLE NO 58

Littelfuse® Tracor

800 E. Northwest Highway • Des Plaines, IL 60016
(312) 824-1188

**2AG SPACE-MAKERS—SLO-BLO® OR FAST-ACTING
PERFORMANCE IN A NEW SUBMINIATURE SIZE**

VME + FCC = Electronic Solutions

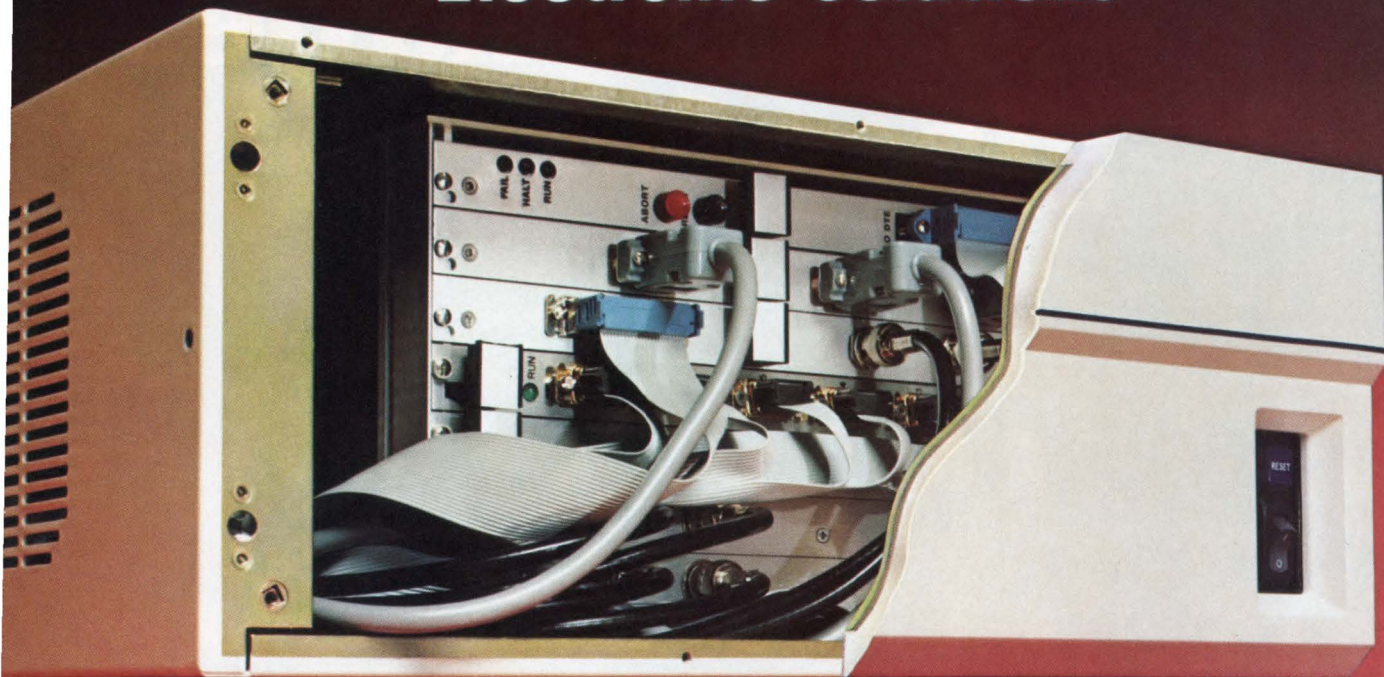

The only VME System Enclosures with EMI/RFI Compliance

With Electronic Solutions VME enclosures you don't have to take any static about FCC compliance. Because your VME system can meet or exceed FCC Class A Part 15 EMI/RFI standards. No other enclosure manufacturer can make that statement.

Here's why: Only Electronic Solutions puts a new face on VME, an outer front panel that—with other design features—keeps your EMI/RFI signals from straying. What's more, it hides those I/O connectors and dangling cables so your system looks a lot cleaner and more attractive.

Electronic Solutions enclosures for VME—and Multibus I/II—come assembled complete with card

cage, backplane, power supply, room for peripherals and more. You can get slim enclosures with 3 slots all the way up to multi-system enclosures with 40—count 'em—40 slots. And you buy them ready for your system at a tiny fraction of what it would cost to develop your own packaging.

In addition, there are a few other agencies besides the FCC that can help multiply your system's success. So Electronic Solutions enclosures pass UL, CSA, and TUV/IEC 380 as well.

Call today for complete details. Because no matter what formula you planned to use for system packaging, putting your system in our enclosures is the one that really adds up.



GEMINI enclosures to 40 slots.



SERIES enclosures to 12 slots.



**We'll FAX you
the facts.**

REQUESTED INFORMATION
PLEASE RETURN IMMEDIATELY TO ADDRESSEE

TO: _____
COMPANY: _____
FAX: _____

Electronic Solutions
3775 La Jolla Village Drive
San Diego, CA 92121
(619) 452-9333

Series 57V
VME
SYSTEM
ENCLOSURES

1. High density design (19" rack height) fits more equipment in less space.

2. Full depth front panel provides excellent protection for equipment.

3. Full depth front panel provides excellent protection for equipment.

4. Full depth front panel provides excellent protection for equipment.

5. Full depth front panel provides excellent protection for equipment.

6. Full depth front panel provides excellent protection for equipment.

7. Full depth front panel provides excellent protection for equipment.

8. Full depth front panel provides excellent protection for equipment.

9. Full depth front panel provides excellent protection for equipment.

10. Full depth front panel provides excellent protection for equipment.

Want the latest data in a hurry? Nothing is faster than Electronic Solutions' new "FAX the FACTS" program. If you have a FAX machine, just call our "800" number, give us your FAX number and type of FAX machine, and the information you need from us. We'll FAX it to you immediately.



**Electronic
Solutions**
UNIT OF ZERO CORPORATION

6790 Flanders Drive, San Diego, CA 92121 • (619) 452-9333 Telex II(TWX): 910-335-1169

Call Toll Free: (800)854-7086 In Calif: (800)772-7086

CIRCLE NO 59

Tiny telecommunications module contains a CMOS T1/CEPT line card

Touted as the first complete CMOS chip set that meets both the T1 (North American) and CEPT (Conference of European Post Telecommunications) standards, the T1/CEPT Line Card is a circuit-board module that is the size of a stick of chewing gum. Using this module, you have to make only minor modifications to convert your telecommunications equipment for access to either the T1 or the CEPT network, thus providing international-marketing possibilities for your telecommunications equipment.

The circuit comprises four chips mounted in a 0.85×3.85-in. JEDEC configuration that was originally developed for use with dynamic RAMs. The DS2187 receive-line-interface chip interprets incoming signals—after they pass through the module's coupling transformer—and removes any distortion picked up during transmission. The DS2187 uses a laser-trimmed phase-locked loop that continually tracks each signal and passes extracted clock and data information to the DS2180A T1 transceiver.

The transceiver chip formats the data stream according to T1 convention. By replacing the DS2180A with a DS2181A, you can modify the module for use with the CEPT standard. Both transceivers provide line-monitoring capability and allow your equipment to log error conditions and track line performance via a μ P port.

The third chip in the module is a DS2175 elastic store that uses a FIFO-buffer memory to resolve any mismatch between the clock of the

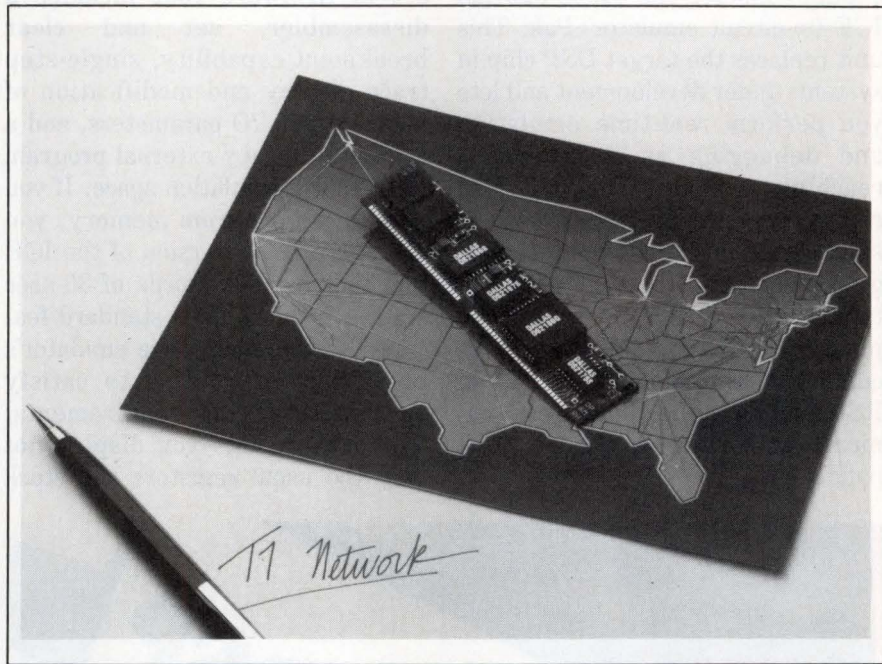

Mounted on a circuit board that's about the size of a stick of chewing gum, the T1/CEPT Line Card from Dallas Semiconductor is the first CMOS chip set that meets both the T1 and CEPT telecommunications standards.

T1/CEPT network and the clock in your equipment. This chip retains incoming data for delayed release in synchronization with the equipment clock. During transmission, the DS2175 stores outgoing signals for synchronization with the network clock.

The DS2186 transmit-line interface converts square-wave logic signals generated by your equipment to the waveforms specified by the T1/CEPT standards for twisted-pair networks. The manufacturer uses a direct laser-writing technique to set the exact waveform and associated timing in the DS2186. In the event of a revision in either the T1 or the CEPT standard, the manufacturer can replace a single chip to

meet the new requirements. Thus, you can concentrate on the design requirements of your equipment rather than preoccupying yourself with changing telecommunications standards.

You can buy the T1/CEPT Line Card for \$98 (5000). The manufacturer also offers application notes and \$100 designer kits for the chip set.—**J D Mosley**

Dallas Semiconductor, 4350 Beltwood Parkway S, Dallas, TX 75244. Phone (214) 450-0400. TWX 650-244-1669.

Circle No 695

\$1995 TMS320C25 DSP in-circuit emulator specs 40-MHz debugging speed

If you've been waiting for a low-cost in-circuit emulator for Texas Instrument's TMS320C25 DSP chip, you should consider the \$1995 320C25 ICE (in-circuit emulator) Pak. This unit replaces the target DSP chip in systems under development and lets you perform real-time emulation and debugging at clock speeds reaching 40 MHz. The ICE Pak comes with 16k words of 35-nsec static RAM for zero-wait-state program memory—the unit uses the target DSP's data memory. You can plug the ICE Pak into any host computer or terminal that has an RS-232C port, and you can communicate at a rate as fast as 19.2k baud.

For the basic price, you can buy the unit with communications software and a monitor/debug command set in firmware that includes a disassembler, set and clear breakpoint capability, single-step trace display and modification of memory and I/O parameters, and a command to copy external program ROM to the emulation space. If you need more program memory, you can buy a \$2495 version of the ICE Pak that has 64k words of 35-nsec static RAM. Another standard feature lets you modify the emulator's break-handler routine to satisfy special debugging requirements. This feature lets you display not only the usual registers and stack

during a break, but also the contents of any eight memory or I/O locations.

The TMS320 Emulator XDS/22, presently marketed by TI for their popular DSP chip, costs seven times as much as the ICE Pak. Part of the reason for the difference in cost is the ICE Pak's compact 3.5×5.6-in. size. The TI emulator is housed in an enclosure that is 25 times larger than the ICE Pak. In addition, the ICE Pak derives its power from the target 320C25 socket—drawing only 25 mA more current than the DSP chip itself—so it needs no separate power supply. Furthermore, the ICE Pak doesn't come with real-time trace capabilities, although for \$2995 you can purchase an upgraded version of the ICE Pak that includes 64k words of program memory and 512 words of memory for forward or reverse real-time trace.

The ICE Pak lets you copy the contents of any EPROM program memory from the target system directly into the emulation-program memory space. You can download programs and data files written in TI hex, Intel hex, or binary. The options include a \$199 crossassembler for IBM PC or compatible hosts, a \$299 crossassembler with an editor for Macintosh hosts, and a \$150 evaluation board for IBM PCs that has a ground plane, a crystal, and a 4×5-in. wire-wrap area. The manufacturer offers a 90-day warranty and a 30-day money-back guarantee.—**J D Mosley**

Memocom, 1301 Denton Dr, Suite 204, Carrollton, TX 75006. Phone (214) 446-9906.

Circle No 696



You can use the 320C25 DSP ICE Pak with any host computer or terminal by plugging it into the host's RS-232C port. The emulator includes a set of monitor and debug commands in firmware, so you don't need any special driver software for host communications.

Z I L O G



The highest performance and highest integration, ever. Together on a single 16-bit chip.

The Z280™ gives you a more powerful CPU and higher performance peripherals than you've ever seen on a 16-bit chip. Think of it as a complete microsystem on a chip.

Unmatched performance...

Start with the most powerful 16-bit engine available, add on-board Cache, MMU and Burst Mode memory support — and you'll begin to understand the Z280's power and potential.

...powerful on-board peripherals...

Imagine the savings in cost and board size when you have peripherals like 4 DMA channels that'll give you transfers at 6.6 Mbytes/sec, and a full-duplex UART.

... and the glue to tie it all together.

With a DRAM Controller to support up to 1 MBit DRAMs and

Programmable Wait State Logic — on board — you're really looking at significant glue reduction.

Z280: Truly a microsystem.

The Z280 gives you a lot more performance. In a lot less board space. All off the shelf and backed by Zilog's proven quality and reliability. Plus, it's binary code-compatible with the Z80*, and priced to rival 8-bit chips. And all the development support tools you need are available from industry leaders. Contact your local Zilog sales office or your authorized distributor today. Seeing is believing. Zilog, Inc., 210 Hacienda Ave., Campbell, CA 95008 (408) 370-8000.

	Z280™	80186	68070
Package	68-pin PLCC/CMOS	68-pin LCC/NMOS	84-pin PLCC/CHMOS
Typical Power	375 mW	2 W	800 mW (est)
Speed	10-25 MHz	8-12.5 MHz	10 MHz
Memory Support	16 Mb Physical Paged	1 Mb Physical Segmented	16 Mb Physical 8 or 128 Segments
16-bit Registers	12 General	8 General	15 Dedicated
Instruction Pre-fetch	256-Byte Assoc. Cache; Burst Mode	6-Byte Queue	None
Multiprocessor Support	Local or Global	Local only	Local only
Wait Logic	Programmable	Programmable	Hardwire
DMA	4 Channels, 6.6 Mb/s @ 10 MHz	2 Channels 2 Mb/s @ 8 MHz	2 Channels, 3.2 Mb/s @ 10 MHz
Counter/Timers	3 16-bit	3 16-bit	2 16-bit
Serial I/O	1 Full-Duplex UART	None	1 Full-Duplex UART
DRAM Controller	10-bit Refresh	None	None
Price (100)	\$33	\$43	\$50

The choice is clear.

Right product. Right price. Right away.

ZILOG SALES OFFICES: CA (408) 370-8120, (714) 432-9971, (818) 707-2160, CO (303) 494-2905, FL (813) 585-2533, GA (404) 923-8500, IL (312) 885-8080, MA (617) 273-4222, MN (612) 831-7611, NJ (201) 288-3737, (609) 778-8070, OH (216) 447-1480, TX (214) 231-9090, **CANADA** Toronto (416) 673-0634, **ENGLAND** Maidenhead (44) (628) 781227, **W. GERMANY** Munich (49) (89) 612-6046, **JAPAN** Tokyo (81) (3) 587-0528, **HONG KONG** Kowloon (852) (3) 723-8979, **R. O. C.:** Taiwan (886) (2) 731-2420, **U.S. AND CANADA DISTRIBUTORS:** Anthem Electric, Bell Indus., Graham Elec., Hall-Mark Elec., JAN Devices Inc., Lionex Corp., Schweber Elec., Western Microtech., **CANADA** Future Elec., SEMAD.

Zilog
an affiliate of
EXON Corporation

“I shop the specs



because it's my job. But I buy the product because it's my career."

WHAT YOU SHOULD KNOW ABOUT THE NEW PRODRIVE™ SERIES OF 3½-INCH HARD DISK DRIVES FROM QUANTUM.

The numbers are the easy part. Either a product has them or it doesn't.

But you can't build a system out of specs.

You also need dedicated product-support people who will sit down and help you solve some tough engineering problems and put those specs to work.

Quantum is ready to deliver both.

Our new ProDrive Series of 3½-inch hard disk drives offers you the broadest range of capacities in the broadest range of interfaces in the industry. 42 and 84 megabyte formatted with embedded SCSI interface right now. And later this year, up to 168 megabytes, in SCSI, ESDI, and AT-Bus. Ten new drives in all.

All with access times of 19 ms or less.

With synchronous data transfers to the SCSI bus of 4 megabytes per second, and asynchronous data transfers of 2 megabytes per second.

With an MTBF of 50,000 hours.

And with DisCache™, Quantum's unique 64 kilobyte data-buffering scheme that can make our 19-ms drive perform like a 12-ms drive—or even faster, depending on your application.

But Quantum also offers you the people who can help you put those numbers to work in your own system. A dedicated team of engineering professionals who understand the particular needs of the systems designer—and can help meet those needs quickly, efficiently, cost-effectively.

The new ProDrive Series. The specs you want. The support you need.

That's what Quantum delivers.

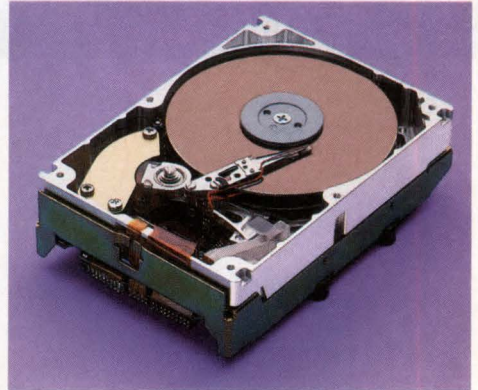

INTRODUCING THE PRODRIVE SERIES

- 3½-inch form factor
- 42, 84, 103, 120, 145, 168 MBs formatted
- SCSI, ESDI, AT-Bus
- 19 ms or faster average access time
- 64 KB buffer with exclusive DisCache™
- 50,000-hour MTBF
- 42, 84 MB SCSI evaluation units AVAILABLE NOW
- 42, 84 MB AT-Bus units available early summer '88

Quantum

Quantum Corporation
1804 McCarthy Blvd.
Milpitas, CA 95035

ProDrive and DisCache are
trademarks of Quantum Corporation.

Microprocessor Support Made Simple

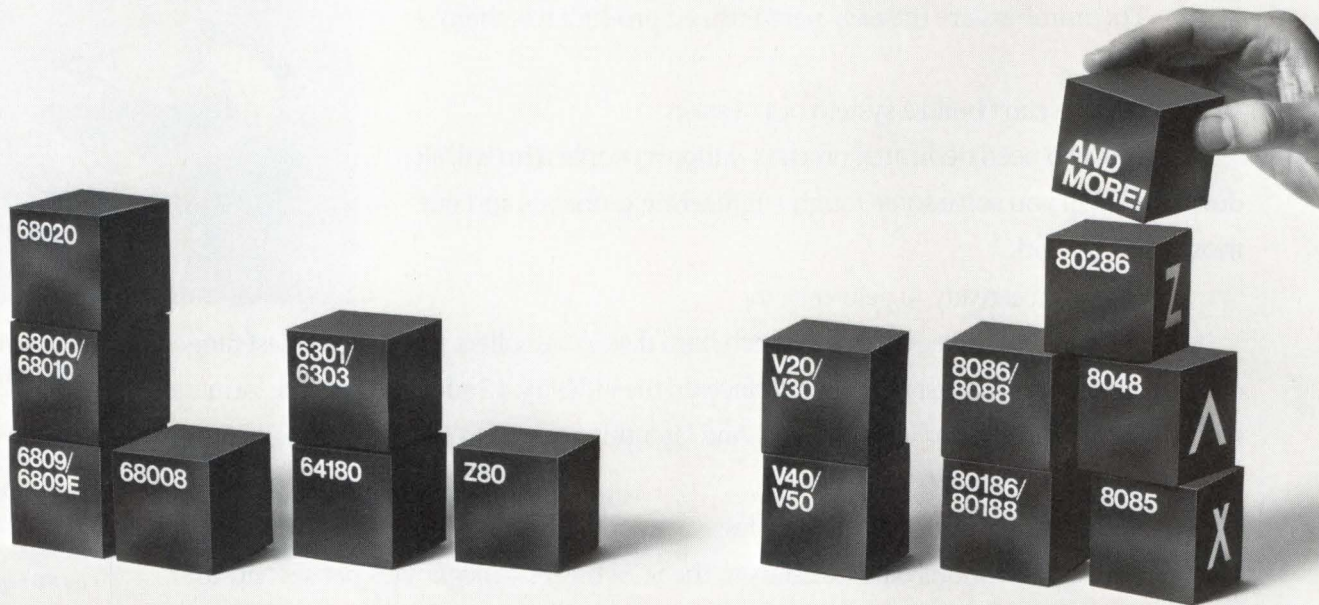

Now, ZAX simplifies microprocessor design, integration and testing with their advanced line of ERX- and ICD-series emulators. You simply tell us the processor that drives your design and we tailor a development system especially for your environment, including full software support.

Our ERX-series emulators provide over 80 debugging commands, with 256,000 hardware breakpoints, real-time performance analysis, high-level language debug and trace analysis of program execution while you emulate in real-time. And they interface directly to your personal computer (AT-class) to provide you with a complete host development station and emulation manager. This consolidated approach utilizes industry-standard equipment and eliminates the use of a proprietary dedicated chassis.

ZAX established the benchmark for standalone emulation tools when they introduced their versatile line of ICD-series emulators. Completely flexible, ICD-series emulators can be interfaced to either a simple terminal or host computer (from pc to mainframe) depending on your requirements. This makes them ideal for both in-house development and on-site testing.

Simplify support for your microprocessor development projects with the help of ZAX! Call today to arrange a product demonstration or write for complete details about our product line. Call us TOLL FREE at 800-421-0982 (in California phone 800-233-9817) or write to ZAX CORPORATION, 2572 White Road, Irvine, CA 92714.

In Europe, call United Kingdom: 0628 476 741, West Germany: 02162-3798-0, France: (03) 956-8142, Italy: (02) 688-2141.

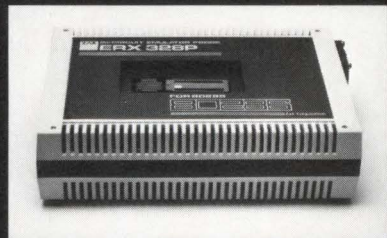
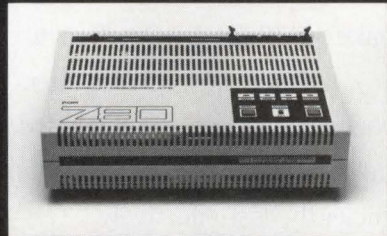

ZAX
Zax Corporation

Saratoga FIFOs.

Our new FIFOs are the world's fastest. Available now in 10, 15, 25, 40 and 50 MHz.

Slow interprocessor communication headaches. You thought you'd tried every buffering remedy in the book to get rid of them.

But here's one you haven't: *raw FIFO speed*. Using Saratoga's new family of BiCMOS FIFOs—the world's first 50-MHz first-in, first-out memories.

Organized as 64 words by-4 and by-5 bits wide, these RAM-based

devices deliver performance unmatched in the industry—at 10, 15, 25, 40 and 50 MHz.

Even so, they consume no more power than CMOS FIFOs, while offering high output drive that's TTL compatible. And they can be cascaded to expand in word width and depth. Plus they're available in both commercial and military temperature ranges, in industry-standard pin-outs.

This new generation of FIFOs

will soon include 64 by 9 and larger density 512, 1K and 2K by 9 devices. Joining Saratoga's existing lines of high-performance TTL and ECL static RAMs—also among the fastest now available. And all made possible by our proprietary BiCMOS technology—SABIC™—which combines the best of both the bipolar and CMOS worlds.

So if system timing headaches have got you down, take one of our new FIFO buffers. And call us in

the morning: (408) 864-0500. Or write: Saratoga Semiconductor, 10500 Ridgeview Court, Cupertino, CA 95014.

Saratoga FIFO Memories

Clock Frequency	50 MHz (40 MHz military)
Data Access Time	1.5 nsec
Data Set-up and Hold Time	3 nsec
Bubble-through Time	2.5 nsec (max)
Power Consumption	385 mW
Output Drive	16 mA

Introducing

The First 50-MHz FIFOs.

In BiCMOS.



The Technology Leader in BiCMOS

CIRCLE NO 63



READERS' CHOICE

Of all the new products covered in EDN's **January 21, 1988**, issue, the ones reprinted here generated the most reader requests for additional information. If you missed them the first time, find out what makes them special: Just circle the appropriate numbers on the Information Retrieval Service card, use EDN's Express Request Service, or refer to the indicated pages in our **January 21, 1988**, issue.

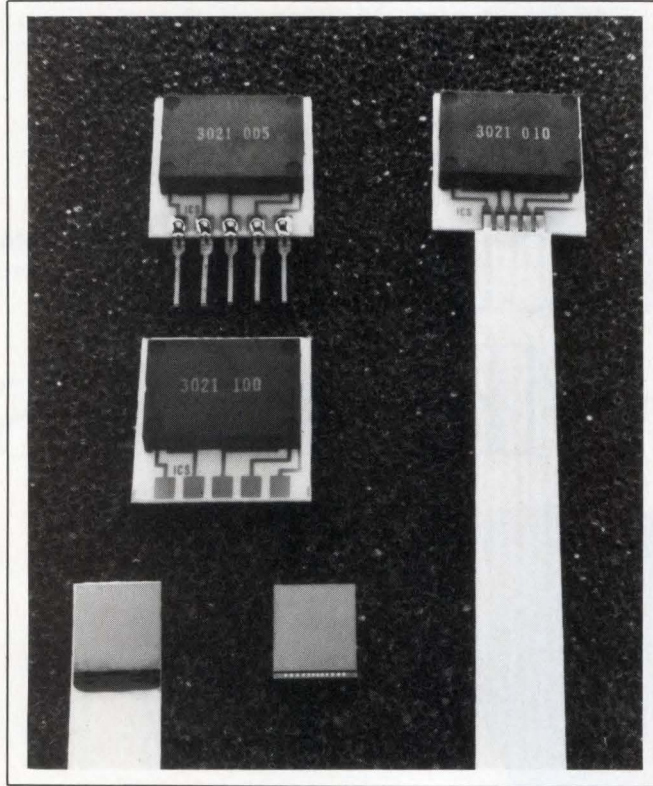

▲ ACCELEROMETER

Model 3021 monitors acceleration, vibration, and shock. It measures 7.9×7.3-mm and is well suited to applications characterized by limited sensor-mounting area (pg 234).

IC Sensors Inc
Circle No 604

TERMINAL

The pocket-size Multiportable terminal lets you read, write, and program a Memocard smart card that contains an 8-bit μ P and 2k or 8k bytes of EEPROM (pg 94).

Multimil Inc
Circle No 601

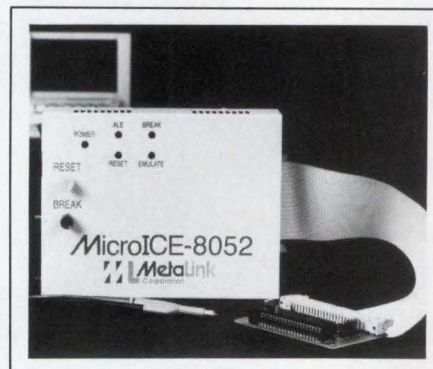

◀ EMULATOR

The in-circuit emulators in the MicroIce family connect to IBM PCs and compatible computers and support the 8051 family. They provide the same features as the vendor's earlier units, but at approximately half the cost (pg 240).

MetaLink Corp
Circle No 605

MATH SOFTWARE

The MathMate integrated mathematical-software package provides an equation solver and expression analyzer and runs on the IBM PC and compatibles (pg 243).

MCAE Technologies Inc
Circle No 606

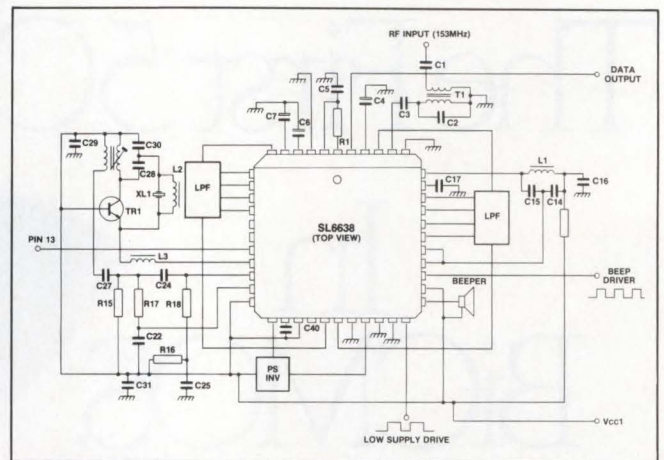

▲ RADIO IC

The SL6638 is a single-chip radio receiver designed for battery-powered time and data-paging equipment that operates at broadcast frequencies as high as 200 MHz (pg 229).

Plessey Semiconductors Ltd
Circle No 602
Plessey Semiconductors
Circle No 603

Some companies make workstations for just about anyone.



Cynthia Beers
Applications Analyst
Software Productivity Consortium

Niel D. Harding
Software Engineer
Boeing

Steve Hodge
Manager, Silicon Products Group
Racal-Redac Limited

Frank W. Cooper
Manager, ISF Engineering
WESPACE, Division of Westinghouse

Pat Wolfram
Engineer, Design & Analysis
Division, Mentor Graphics

We engineer ours only with a passion for performance.

While some companies sell a lot of computers because they make something for everyone, we sell a lot because we don't.

All the workstations we make, the applications that run on them, and the networking power that unites them with the other computers in your company were created for a select group of people.

Namely the engineers, product designers, software developers and other professionals who demand nothing less than ultimate compute performance.

People who clamor for access to processing power and graphics. Who possess an insatiable

appetite for information. And who can ill afford to endure the delays, limitations and obstacles that typically hinder the effort to attain it.

If you're such a person, you should have an Apollo workstation. For you'll realize the moment its screen is in front of you that the issue of performance is behind you.

An Apollo workstation will grant upon you enough dedicated compute power to keep your imagination charged permanently. Letting you choose from a compatible family of workstation systems whose prices start as low as a personal computer and whose perfor-



Shinsuke Onaka
Seiko Epson Corporation

Lou Horner
VP, Information Services
Chicago Research & Trading Group, Ltd.

y for those formance.

mance extends to that of supercomputers.

These machines will grant you imagery so brilliant you won't want to blink for fear of missing something. With real time two- and three-dimensional graphics that render up to 16.7 million colors at 130,000 vectors per

second. And they'll open your eyes even wider with networking power and elegance.

Every Apollo workstation, from the Series 3000™ Personal Workstation™ to our new Personal Supercomputer,™ functions as a command center from which you have unequalled access to data, processing power, development tools, and applications.

So that every mainframe, minisuper, and microcomputer on your network is at your beck and call.

In a manner almost invisible to you, our workstations show you networking performance you probably thought impossible.

For with the industry's first implementation of Network Computing Architecture,™ they make your multi-vendor network appear as one computing environment.

Letting you run a single application on a network of computers by automatically dispatching portions of a program to the processors most qualified to execute them. And providing the tools to develop and debug code running on different machines.

All while freeing you to create applications, access network resources and even move from one operating environment to another with whatever language, menus and file names you define.

A fact that might inspire you to wonder if we don't engineer our workstations only for you.

Today, there is more than one way to measure computer performance. But when the criteria include processing power, graphics and network computing, nothing measures up to Apollo.



apollo

For more information, call 1-800-323-1846. In Massachusetts call 1-800-847-1011. Or write Apollo, 330 Billerica Road, Chelmsford, MA 01824. Apollo is a registered trademark and Series 3000, Personal Workstation, Personal Supercomputer and Network Computing Architecture are trademarks of Apollo Computer Inc.

**THINGS CAN LOOK
PRETTY DARK
WHEN
CONNECTORS
DON'T WORK THE
WAY THEY'RE
SUPPOSED TO.**

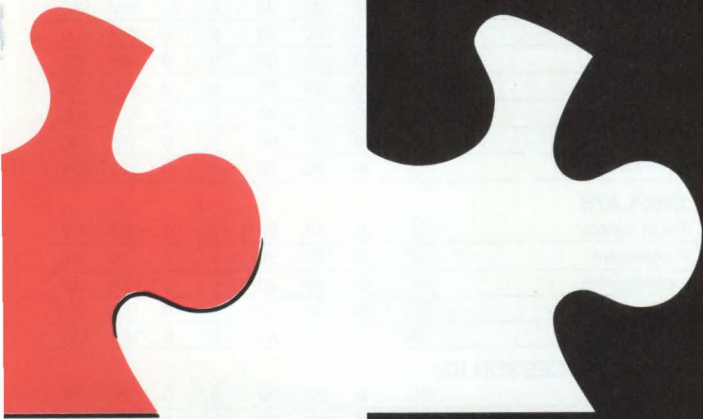

World headquarters:
HARTING ELEKTRONIK GmbH
P. O. Box 1140 · D-4992 Espelkamp
West Germany
☎ (05772) 47-1 · 📠 9 72 310-11 he d

**CONNECT UP WITH QUALITY -
WITH HARTING.**



HARTING/Netherlands, AM Etten-Leur, Tel. 01-608-354 00 · HARTING/Norway, Oslo, Tel. 02-64 75 90 · HARTING/Sweden, Spanga, Tel. (08) 761 79 80 · HARTING/Switzerland, Schwerzenbach, Tel. 01-8 25 51 51 · HARTING/USA, Chicago, Tel. (312) 519-77 00

LEADTIME INDEX

Percentage of respondents

ITEM	Percentage of respondents							
	Off the shelf	1-5 weeks	6-10 weeks	11-20 weeks	21-30 weeks	Over 30 weeks	Last month's average (weeks)	Average (weeks)
TRANSFORMERS								
Toroidal	6	23	47	18	6	0	7.2	7.3
Pot-Core	0	8	67	17	8	0	10.3	7.8
Laminate (power)	5	45	27	14	9	0	7.6	8.3
CONNECTORS								
Military panel	0	0	73	27	0	0	10.2	10.8
Flat/Cable	22	39	30	9	0	0	4.6	5.6
Multi-pin circular	9	25	25	25	8	8	8.6	9.4
PC (2-piece)	7	29	50	14	0	0	6.8	7.4
RF/Coaxial	10	50	35	5	0	0	4.6	5.3
Socket	23	54	14	9	0	0	3.6	4.7
Terminal blocks	32	59	4	5	0	0	2.3	5.4
Edge card	24	33	38	5	0	0	4.5	5.7
D-Subminiature	20	40	35	5	0	0	4.4	5.1
Rack & panel	22	36	21	21	0	0	5.8	6.4
Power	20	27	40	13	0	0	5.8	5.5
PRINTED CIRCUIT BOARDS								
Single-sided	0	47	48	5	0	0	5.6	5.4
Double-sided	0	48	48	4	0	0	5.4	5.8
Multi-layer	0	25	63	12	0	0	7.5	7.5
Prototype	0	79	13	8	0	0	3.9	4.3
RESISTORS								
Carbon film	49	27	14	10	0	0	3.3	4.2
Carbon composition	29	38	14	19	0	0	4.9	4.0
Metal film	31	35	26	8	0	0	4.1	4.4
Metal oxide	23	38	31	8	0	0	4.5	4.6
Wirewound	10	32	32	26	0	0	7.4	8.8
Potentiometers	24	40	60	16	0	0	5.0	6.1
Networks	27	32	27	14	0	0	5.0	6.3
FUSES								
	38	38	19	5	0	0	3.1	4.4
SWITCHES								
Pushbutton	24	43	28	5	0	0	3.9	5.8
Rotary	21	32	37	5	5	0	5.7	6.1
Rocker	11	47	32	10	0	0	5.1	5.4
Thumbwheel	6	22	55	6	11	0	8.7	7.7
Snap action	8	38	46	8	0	0	5.7	6.5
Momentary	17	33	39	11	0	0	5.5	6.3
Dual in-line	13	50	31	6	0	0	4.4	6.6
WIRE AND CABLE								
Coaxial	27	41	27	5	0	0	3.8	4.2
Flat ribbon	35	42	19	4	0	0	3.0	5.5
Multiconductor	22	50	17	11	0	0	4.1	4.6
Hookup	56	33	7	4	0	0	1.9	3.2
Wire wrap	31	50	12	6	0	0	2.9	4.2
Power cords	35	38	23	0	4	0	3.6	5.9
POWER SUPPLIES								
Switcher	11	17	50	11	11	0	9.0	7.4
Linear	11	33	45	11	0	0	6.0	7.7
CIRCUIT BREAKERS								
	6	26	42	26	0	0	8.0	8.0
HEAT SINKS								
	25	32	43	0	0	0	4.1	5.1
RELAYS								
General purpose	24	19	38	14	5	0	7.0	6.1
PC board	19	33	26	22	0	0	6.3	7.2

ITEM	Percentage of respondents							
	Off the shelf	1-5 weeks	6-10 weeks	11-20 weeks	21-30 weeks	Over 30 weeks	Last month's average (weeks)	Average (weeks)
RELAYS								
Dry reed	27	20	27	26	0	0	6.7	8.6
Mercury	20	20	30	30	0	0	7.6	9.1
Solid state	12	35	35	18	0	0	6.4	8.9
DISCRETE SEMICONDUCTORS								
Diode	37	27	18	12	3	3	5.6	7.0
Zener	37	19	18	18	4	4	7.0	7.3
Thyristor	11	21	47	11	5	5	8.8	8.8
Small signal transistor	30	10	20	30	5	5	9.5	7.4
MOSFET	10	35	20	30	0	5	8.7	10.2
Power, bipolar	19	25	19	31	0	6	8.8	9.3
INTEGRATED CIRCUITS, DIGITAL								
Advanced CMOS	12	19	44	25	0	0	7.9	9.6
CMOS	19	23	27	27	4	0	8.0	7.1
TTL	39	22	17	17	5	0	5.8	6.5
LS	33	29	14	19	5	0	6.0	5.9
INTEGRATED CIRCUITS, LINEAR								
Communication/Circuit	23	15	46	16	0	0	6.5	8.7
OP amplifier	23	14	36	18	5	4	8.6	6.3
Voltage regulator	27	11	35	19	4	4	8.3	7.2
MEMORY CIRCUITS								
RAM 16k	13	20	33	27	0	7	9.5	9.7
RAM 64k	11	37	16	31	0	5	8.5	8.8
RAM 256k	0	25	38	25	6	6	11.0	10.0
RAM 1M-bit	0	17	33	33	0	17	14.4	12.5
ROM/PROM	0	17	25	50	8	0	12.4	11.0
EPROM 64k	17	28	17	33	5	0	8.5	9.5
EPROM 256k	7	20	20	53	0	0	10.5	9.3
EPROM 1M-bit	0	18	27	46	9	0	12.2	11.6
EEPROM 16k	0	22	14	64	0	0	11.8	10.6
EEPROM 64k	0	19	25	56	0	0	11.3	10.9
DISPLAYS								
Panel meters	7	21	43	29	0	0	8.5	6.7
Fluorescent	0	18	27	55	0	0	11.3	8.5
Incandescent	20	40	10	30	0	0	6.4	6.5
LED	32	20	36	12	0	0	5.2	8.1
Liquid crystal	0	12	44	44	0	0	10.8	10.5
MICROPROCESSOR ICs								
8-bit	24	18	29	29	0	0	7.3	7.6
16-bit	6	25	19	50	0	0	10.0	9.3
32-bit	0	15	15	62	8	0	13.5	7.6
FUNCTION PACKAGES								
Amplifier	20	20	30	30	0	0	7.6	6.4
Converter, analog to digital	7	29	28	36	0	0	8.6	8.6
Converter, digital to analog	0	46	27	27	0	0	7.4	9.2
LINE FILTERS								
	13	20	40	27	0	0	7.9	9.4
CAPACITORS								
Ceramic monolithic	17	25	46	12	0	0	6.1	5.8
Ceramic disc	30	30	22	18	0	0	5.2	5.1
Film	14	38	19	24	5	0	7.4	4.8
Aluminum electrolytic	19	23	35	23	0	0	6.9	4.8
Tantalum	24	32	32	8	4	0	5.5	6.2
INDUCTORS								
	5	37	42	16	0	0	6.7	9.3

Source: Electronics Purchasing magazine's survey of buyers

The hot single shot.

we never stop asking

What if...

The HP 54111D digitizing oscilloscope has your numbers: 1 gigasample/s*, 250 MHz single-shot and 500 MHz repetitive bandwidth.

The HP 54111D brings you the blazing speed and complex waveform triggering you need to capture those elusive glitches that cause headaches.

The HP 54111D is loaded with features you can appreciate: simultaneous two-channel capture; 8K memory per channel; up to eight bits of vertical resolution; waveform math which now includes A vs B, A x B, and integrate; and the advantages of HP digitizing technology including automatic answers, one-button hard copy output, auto-scale, digital storage, and HP-IB programmability (waveform capture and transfer now three to six times

faster in ATE applications).

Plus the exceptional reliability you've come to expect from HP scopes, and extended warranty coverage as well.

Call HP today!
1-800-752-0900, ext. 215S.

We'll send all the details including Application Note *Sub-nanosecond Single-shot Digitizing Using The 54111D*, HP 54111D Data Sheet, and our brochure *Feeling Comfortable with Digitizing Oscilloscopes*. Or contact your local HP sales office listed in the white pages and ask for your HP rep.



HP-IB: Not just IEEE-488, but the hardware, documentation and support that delivers the shortest path to a measurement system.

© 1988 Hewlett-Packard Co. E115801/EDN(A)

*See our Application Note on 2 gigasample/s performance.

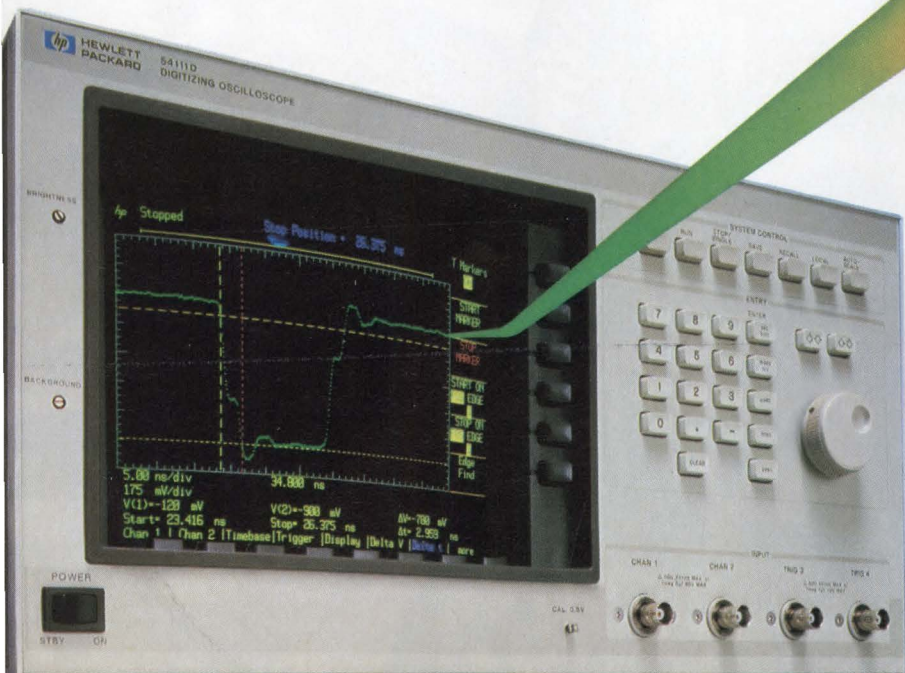

 **HEWLETT
PACKARD**

CIRCLE NO 66

Your next destination:



The ACL Computer Age.

The future belongs to computers and peripherals built with RCA Advanced CMOS Logic (ACL).

The pressure is on to make your systems smaller, faster, cheaper.

Some of your competitors are doing just that by incorporating ACL into their new designs. If you want to stay on the fast track, you can't afford not to consider ACL for your new designs.

The computer of the future.

Imagine a computer with power dissipation so low you could eliminate all cooling systems. Or design a sealed system to prevent dust problems.

And get dramatically improved reliability, thanks to the far lower heat generated. As well as far smaller system size.

You'd also be able to use it in a far wider operating temperature range (-55°C to +125°C). Even in high-noise environments.

FAST* speed, CMOS benefits.

Advanced CMOS Logic gives you high speed (less than 3ns propagation delay with our AC00 NAND gate) and 24 mA output drive current.

But unlike FAST, it gives you a whole new world of design opportunity for computers, peripherals, telecommunications and other speed-intensive applications.

ACL dissipates less than 1/8 Watt while switching, compared to 1/2 Watt for a FAST IC (octal transceiver operating at 5 MHz). And quiescent power savings are even more dramatic: ACL idles at a small fraction of the power of a FAST IC.

*FAST is a trademark of Fairchild Semiconductor Corp.

In Europe, call: Brussels, (02) 246-21-11; Paris, (1) 39-46-57-99; London, (276) 68-59-11; Milano, (2) 82-291; Munich, (089) 63813-0; Stockholm (08) 793-9500.



GE Solid State

GE/RCA/Intersil Semiconductors

Three great brands. One leading-edge company.

*Trademark of General Electric Company, U.S.A., not connected with the English Company of a similar name.

It happens. A young engineer is told to design a competitively-priced modem less than half the size and twice the speed of anything out there.

He sweats it out. Then, a senior designer who remembers what it was like says, "Problem? Try Rockwell International."

"It was my first modem project. When I had to find the right V.32 solution, my brain froze solid."

He calls. Rockwell listens. They understand his needs. They tell him about their advanced R9696DP, a low-power, full-duplex V.32 integrated data pump module that also communicates with the installed base of V.22bis, V.22, V.21 or Bell 212A/103 modems.

He uses it. His modem is right on the money for the growing 9600bps dial-up market. And Rockwell's standard 5-year warranty guarantees his customers quality and reliability.

Imagine how he felt when the engineering director told him, "We've got ourselves a winner. Good job."

Call the leader in modem technology. Rockwell *is* solutions.



Rockwell International

... where science gets down to business

Aerospace / Electronics / Automotive
General Industries / A-B Industrial Automation

CIRCLE NO 67

Semiconductor Products Division,
Rockwell International,
P.O. Box C, M.S. 501-300, Newport Beach,
CA 92658-8902 (800) 854-8099.
In California, (800) 422-4230.

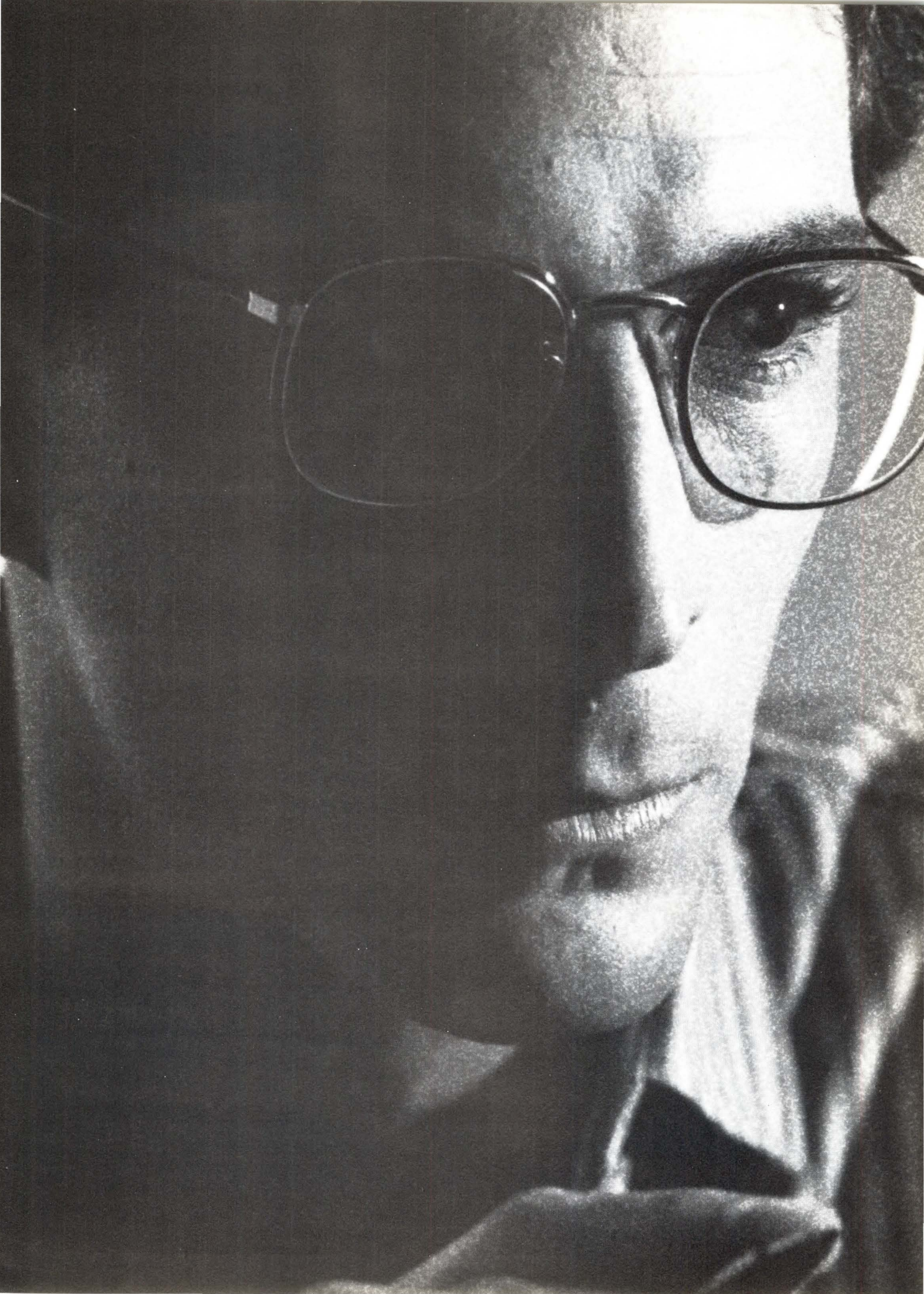



As the trend of integrating modem functions on single ICs continues, more and more chips will be available to provide worldwide communications via satellite. (Photo courtesy Cermetek)

Special Report

Single-IC modems

Integrating all the functions of a modem on a single IC has made it feasible to implement a virtual front-end processor for the PSTN. Even so, you'll still have to make provision for a μ controller and, in some cases, the 2- to 4-wire hybrid and the DAA.

John Gallant, *Associate Editor*

Single-IC modems are eliminating board-level modems that transmit at 1200 bps or less. Indeed, even single-IC modems that operate at 2400 bps are available. A recent Electronic Trend Publications' study (Ref 1) predicts that numerous applications for these chip-level modems will emerge: inventory status for vending machines, data telemetry for home or laboratory instruments, security monitors, credit-card terminals, and order entry for portable computers. Essentially, by adding a single-IC modem to your embedded application, you can have a virtual front-end processor for communicating over the public switched-telephone network (PSTN) or via a communication satellite link.

How do you define a single-IC modem?

The definition of a single-IC modem is clouded, however, because some manufacturers place all of the modem functions in a single chip, others place multiple

chips in a hybrid module, and still others place more than one chip on a single substrate. Regardless of the configuration, all single-IC modems also require a μ controller to execute the modem command set and handshake protocols; this being the case, some manufacturers have opted to transfer some of the modem functions to the external controller. Further, achieving a complete modem usually requires the addition of a 4- to 2-wire hybrid and a data-access arrangement (DAA) for connection to the PSTN.

Most of today's single-IC modems provide the following functions: modulation/demodulation (of course), transmit and receive filtering, μ controller interfacing, serial-port interfacing, asynchronous-to-synchronous conversion circuitry, scrambling and descrambling (if required), and clock generation. Most also have automatic gain control (AGC) to normalize the 45-dB dynamic range of received signals, and most have answer and call-progress tone detectors along with dial-tone multiple-frequency (DTMF) generators. In addition, many include UARTs, loop-back test modes, audio outputs, answer- and guard-tone generators, line equalizers, A/D and D/A converters, and digital signal processors.

Single-IC modems must interface with a μ controller: Connecting an interrupt line on the μ controller to the ring line on the DAA enables the detection of a ring signal. A routine in the controller, which toggles the on/off hook command line to the DAA at the proper time intervals, effects the pulse dialing. The single-IC devices primarily support Bell 212A and 103 North American standards and CCITT international standards such

The industry trend is to combine all the functions of a modem in a single IC.

as V.21, V.22, and V.23, which govern 1200-bps and 0- to 300-bps communications (see **box**, "Modulation techniques and speed characterize modems"). Single-chip modems that support the CCITT V.22bis standard for 2400-bps communications are also emerging, however.

True 1-chip modems are available

The Am79C12 from Advanced Micro Devices is a representative example of a single-IC modem that performs all modem functions on one chip. Because the Am79C12 contains an integral 4- to 2-wire hybrid, you only have to add a μ controller and a DAA to configure a complete 300- to 1200-bps modem (**Fig 1**). It conforms to Bell 212A and 103 modem specifications, and it contains all the modulation, demodulation, filtering (digital), and A/D and D/A functions for both the transmitter and receiver. The chip also has a DTMF tone generator, a UART, a call-progress tone-detection circuit, and analog and remote-digital loop-back test modes. You can switch in a compromise equalizer to compensate for line distortions. The device comes in either a 44-pin PLCC (plastic leaded chip carrier) or a 40-pin plastic DIP.

AMD has dubbed its Am79101 a World-Chip because it supports both the North American Bell 202 and 103 and the international CCITT V.21 and V.23 specifications. The FSK modem chip contains answer-tone and DTMF generators for DTMF-tone autodialing. When operating in the V.23 mode, it can transfer data in the back channel at 150 bps. The unit contains a 4- to 2-wire hybrid and uses digital signal processing (DSP) for filtering and modulation and demodulation functions. The device is available in either a 28-pin DIP or PLCC.

Silicon Systems also has a couple of single-chip modems that are in the world class family. The K222 combines Bell 212A and 103 and CCITT V.22 and V.21 capability, and the K224 provides 2400-bps CCITT V.22bis operation along with V.22 and V.21 and Bell 212A and 103 modes. By incorporating these standards, each of the chips is able to provide worldwide communications capabilities at 1200 bps. And, the two K Series members are plug compatible and upgradable with all other K Series devices. None of the K Series of single-chip modems puts the 4- to 2-wire hybrid on chip, however; **Fig 2** shows the typical circuitry necessary to build a complete modem with any of the devices in this

Modulation techniques and speed characterize modems

The Bell and the CCITT standards specify the respective data-transmission speeds for modems in North America and internationally (**Table A**). The Bell 103

and 113 and the CCITT V.21 frequency assignments define full-duplex, 0- to 300-bps FSK operation. Data transmission is asynchronous only. The mark

and space frequencies for these standards are not the same, and you must account for these differences if you want to connect a modem using the North American standard to a modem using the international standard.

The Bell 202 and the CCITT V.23 standards define the frequencies for half-duplex, 1200-bps FSK operation. The CCITT V.23 standard also provides a fallback mode to 600 bps. According to these standards, a modem can transmit and receive asynchronous data, but not simultaneously, over 2-wire phone lines. To change a call's direction, the modem must signal the far-end modem to indicate a reversal—a technique called line turnaround. To avoid this inefficiency, the standards allot a

TABLE A—SPEED AND MODULATION CHARACTERISTICS

SPEED (bps)	2-WIRE MODE	MODULATION	SPECS
0 TO 300	FULL DUPLEX	FSK, ASYNCHRONOUS	BELL 103, 113 CCITT V.21
0 TO 1200	HALF DUPLEX (WITH BACK CHANNEL)	FSK, ASYNCHRONOUS	BELL 202 CCITT V.23
1200	FULL DUPLEX	QPSK, SYNCHRONOUS	BELL 212A CCITT V.22
2400	FULL DUPLEX	QAM, SYNCHRONOUS	CCITT V.22bis
4800	HALF DUPLEX	QAM, SYNCHRONOUS	BELL 208 CCITT V.27
9600	HALF DUPLEX	QAM, SYNCHRONOUS	BELL 209 CCITT V.29

(SOURCE: ADVANCED MICRO DEVICES)

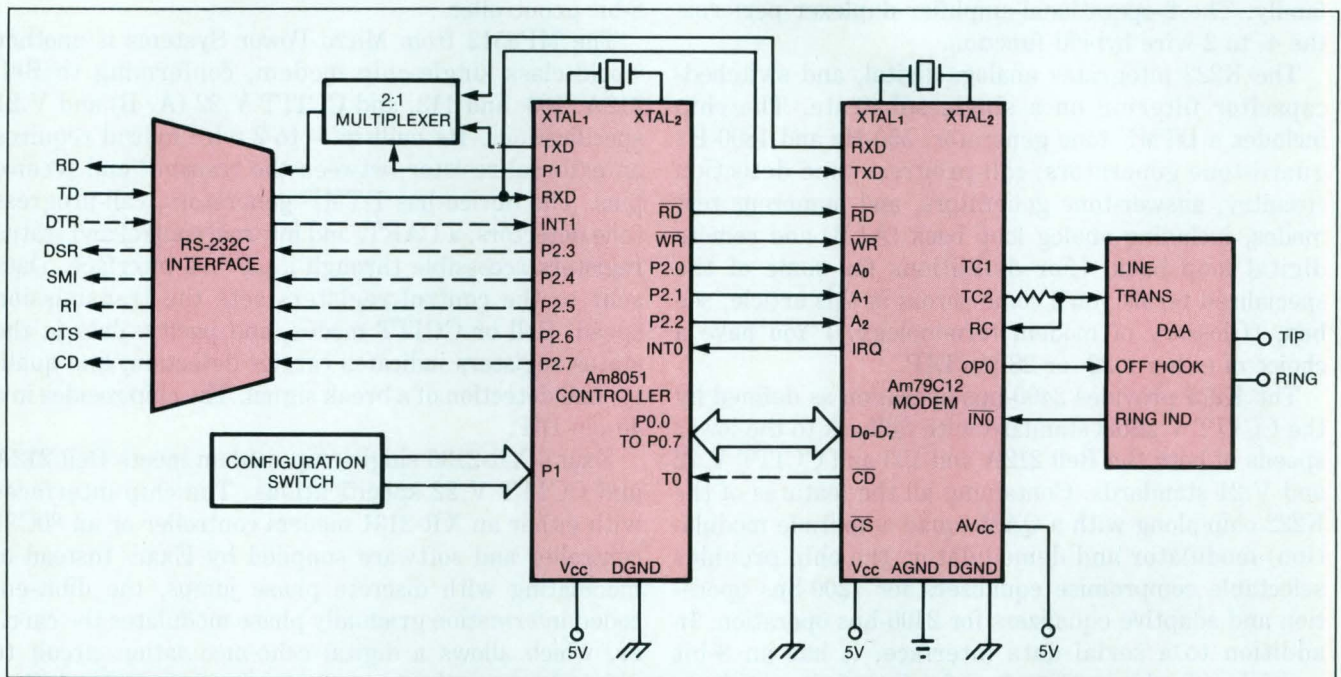

Fig 1—The Am79C12 modem has all its modem functions on one chip. You only have to add a μ controller and a DAA to have a complete 1200-bps modem.

small portion of the bandwidth as a back or reverse channel. The modem can transmit data in the back channel at a lower rate in the direction opposite to, but simultaneous, with the main channel.

The Bell 212 and the V.22 standards define the frequency assignments for full-duplex, 1200-bps operation. These standards use quad PSK (QPSK) modulation to modulate a 1200-Hz originate frequency and a 2400-Hz answer frequency. They require that two successive data bits be encoded as dibits, which perform QPSK modulation of the transmit carrier frequency at a 600-baud rate. The transmitter uses a self-synchronizing scrambler to implement a $1+X^{-14}+X^{-17}$ polynomial genera-

tor to spread energy over the allocated bandwidth. A descrambler at the receiver recovers the scrambled data.

Under these two standards, data transmission can be either synchronous or asynchronous. In the asynchronous mode, data is sent to an asynchronous-to-synchronous converter, which deletes or inserts stop bits to transmit data at a regular rate. The receiver has a synchronous-to-asynchronous converter, which reinserts any deleted stop bits.

The Bell 212 and the V.22 standards differ in the handshake sequence of detecting the originating modem's speed and disconnection. In addition, the CCITT V.22 specification calls for guard tones at 1800 Hz and

550 Hz and an answer tone at 2100 Hz. The Bell 212A specification calls for an answer tone at 2225 Hz.

The CCITT V.22bis standard defines the frequency assignments for full-duplex, 2400-bps, QAM (quad amplitude modulation) operation. According to QAM operation, the data is sent to a 4-level amplitude modulator for quad-bit encoding. The encoded data is phase modulated at a 1200-Hz originate frequency and a 2400-Hz answer frequency. Phase modulation occurs at a 600-baud rate, which creates a 16-point constellation diagram. This modulation scheme requires a complex demodulator at the answer end and adaptive-equalization networks to adapt to line variations.

By adding a single-IC modem to your embedded application, you can have a virtual front-end processor.

family. The 2-operational-amplifier duplexer performs the 4- to 2-wire hybrid function.

The K222 integrates analog, digital, and switched-capacitor filtering on a single substrate. The chip includes a DTMF tone generator, 550-Hz and 1800-Hz guard-tone generators, call-progress tone-detection circuitry, answer-tone generators, and numerous test modes, including analog loop back (ALB) and remote digital loop back. (For definitions for some of the specialized terms you'll come across in this article, see **box**, "Glossary of modem terminology.") You have a choice of either a 22- or 28-pin DIP.

The K224 provides 2400-bps operation as defined by the CCITT V.22bis standard with fallback to the lower speeds of both the Bell 212A and 103 and CCITT V.22 and V.21 standards. Containing all the features of the K222 chip along with a QAM (quad amplitude modulation) modulator and demodulator, the chip provides selectable compromise equalizers for 1200-bps operation and adaptive equalizers for 2400-bps operation. In addition to a serial data interface, it has an 8-bit multiplexed address/data bus for interfacing with an

8-bit μ controller.

The MP8512 from Micro Power Systems is another world-class single-chip modem, conforming to Bell 212A, 103, and 113, and CCITT V.22 (A, B) and V.21 specifications. Its built-in 4- to 2-wire hybrid requires an external resistor between the transmit and receive pins. The device has DTMF generators, call-progress tone detectors, a UART, and internal control and status registers accessible through a μ P bus interface. Data sent to the control registers sets the transmission speed, Bell or CCITT modes, and parity; data in the status registers indicates carrier detection, line quality, and detection of a break signal. The chip resides in a 40-pin DIP.

Exar's XR-2130 single-chip modem meets Bell 212A and CCITT V.22 specifications. The chip interfaces with either an XR-2131 modem controller or an 80C31 controller and software supplied by Exar. Instead of modulating with discrete phase jumps, the dibit-encoded information gradually phase modulates the carrier, which allows a digital echo-modulation circuit to precisely shape the transmit carrier frequency. A Cos-

Text continued on pg 126

REPRESENTATIVE MANUFACTURERS OF SINGLE-MODEM ICs

COMPANY	DEVICE	STANDARDS							POWER SUPPLIES	POWER DISSIPATION	UART	DTMF	DUPLXER	DAA
		BELL			CCITT									
		103	202	212A	V.21	V.22	V.22BIS	V.23						
ADVANCED MICRO DEVICES	Am7910	•	•		•			•	5V -5V	500 mW				
	Am7911	•	•		•			•	5V -5V	500 mW				
	Am79C12	•		•					5V	300 mW	•	•	•	
	Am79101	•	•		•			•	5V -5V	500 mW		•	•	
CERMETEK	CH1760A	•		•					5V -12V	650 mW		•	•	•
	CH1760E	•		•					12V -12V 5V	280 mW		•	•	•
	CH1770	•		•					5V -5V	600 mW		•	•	•
	CH1780	•		•	•	•	•		5V -12V	350 mW		•	•	•
	CH1765								12V 5V -12V	280 mW		•	•	•
EXAR	XR-2100				•				5V -5V	200 mW				
	XR-2130	•		•		•			5V -5V	200 mW		•		

NOTES: 1. ALB = ANALOG LOOP BACK; DLB = DIGITAL LOOP BACK.
2. PLCC = PLASTIC LEADED CHIP CARRIER.
3. SCF = SWITCHED CAPACITOR FILTER.

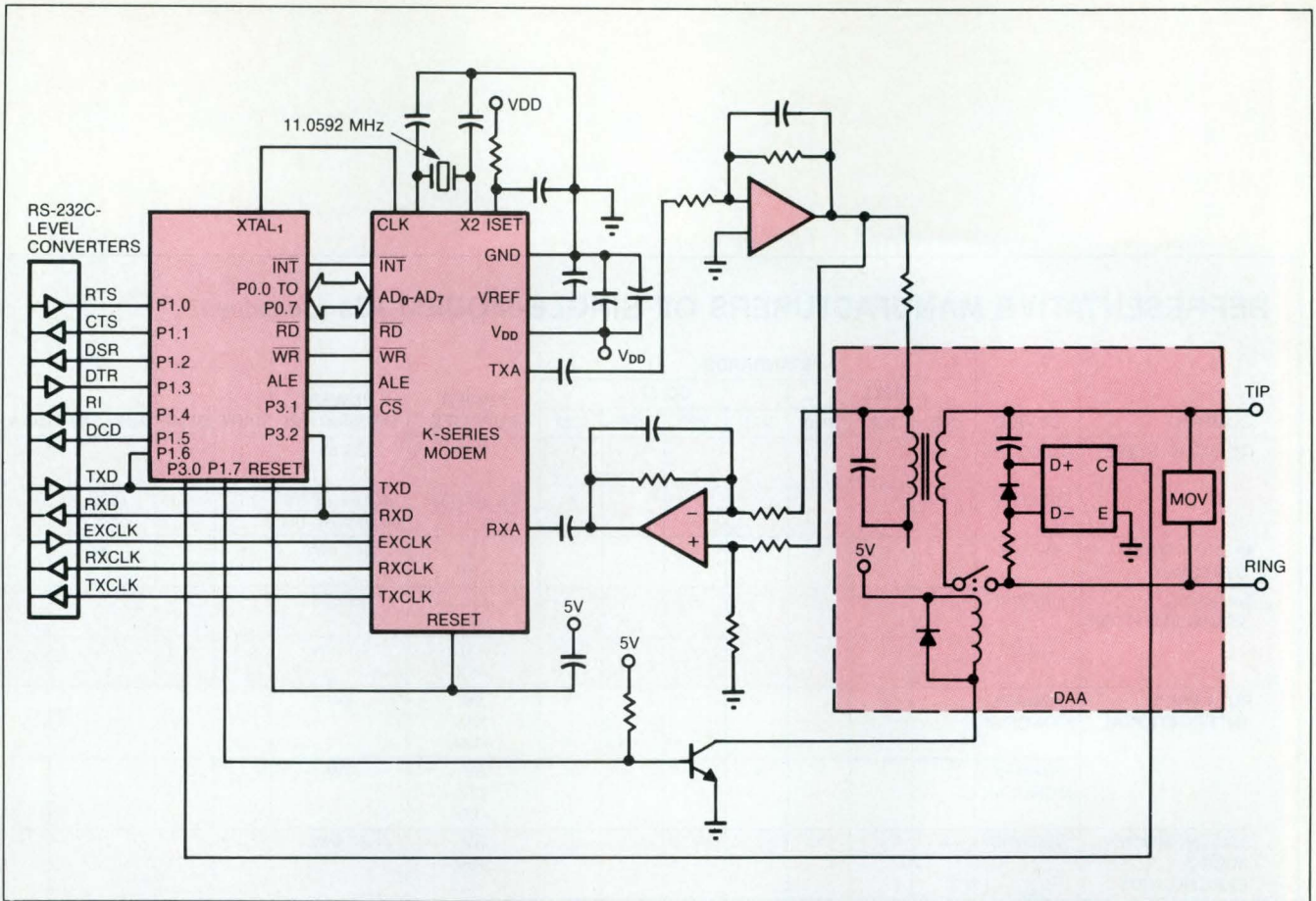

Fig 2—The K Series of single-chip modems from SSI come in packages with identical pinouts. The addition of a controller, a duplexer, and a DAA completes the design.

FILTER TYPES	AGC	CALL-PROGRESS TONE DETECTION	TECHNOLOGY	TEST FEATURES	PACKAGE	COST	OTHER FEATURES
DIGITAL	•	•	NMOS	ALB	28-PIN CERAMIC DIP, PLASTIC DIP, PLCC	\$13.35 (100)	ON-CHIP ADC AND DAC
DIGITAL	•	•	NMOS	ALB	28-PIN PLASTIC DIP, CERAMIC DIP, PLCC	\$12.80 (100)	ON-CHIP ADC AND DAC. 150-BPS BACK CHANNEL. LEASED LINE AND TELEX COMPATIBLE
DIGITAL	•	•	CMOS	ALB DLB	44-PIN PLCC, PLASTIC DIP	\$36 (100)	SELECTABLE ON-CHIP LINE EQUALIZER
DIGITAL	•	•	NMOS	ALB	28-PIN CERAMIC DIP, PLASTIC DIP, PLCC	\$17.60 (100)	150-BPS BACK CHANNEL
SCF	•	•	HYBRID	ALB DLB	2.54×3.74-IN. MODULE	\$245 (100)	FCC REGISTERED
SCF	•	•	HYBRID	ALB DLB	2.54×6.60-IN. MODULE	\$395 (100)	MEMORY-EXPANSION PORT TO STORE 52 PHONE NUMBERS; FCC REGISTERED
SCF	•	•	HYBRID	ALB DLB	2.54×3.74-IN. MODULE	\$179 (100)	FCC REGISTERED
DIGITAL AND SCF	•	•	HYBRID	ALB DLB	2.54×3.74-IN. MODULE	\$390 (100)	FCC REGISTERED
SCF	•	•	HYBRID	ALB DLB	2.54×3.74-IN. MODULE	\$265 (100)	FCC REGISTERED
SCF	•	•	CMOS	ALB	20-PIN CERAMIC DIP, PLASTIC DIP	\$3.46 (100)	
SCF	•	•	CMOS	ALB, DLB EYE PATTERN	28-PIN CERAMIC DIP, PLASTIC DIP	\$11.44 (100)	DEDICATED MODEM CONTROLLER AVAILABLE (XR-2131); COST AS LOOP-DEMODULATOR

Table continued on pg 124

REPRESENTATIVE MANUFACTURERS OF SINGLE-MODEM ICs (Continued)

COMPANY	DEVICE	STANDARDS							POWER SUPPLIES	POWER DISSIPATION	UART	DTMF	DUPLEXER	DAA
		BELL			CCITT									
		103	202	212A	V.21	V.22	V.22BIS	V.23						
GE SOLID STATE	CD22212E	•		•					12V	180 mW		•		
	CD2223E	•						•	4.5 TO 13V	10 mW AT 5V 60 mW AT 12V				
MICRO POWER SYSTEMS	MP8512	•		•	•	•			5V -5V	240 mW	•	•	•	
NATIONAL SEMICONDUCTOR	UA212AT			•					5V -5V	35 mW		•		
	UAV22					•			5V -5V	40 mW		•		
ROCKWELL INTERNATIONAL	R24MFX MONOFAX				•				5V 12V -12V	1W				
	R48MFX MONOFAX				•				5V 12V -12V	1W				
SGS-THOMSON MICRO-ELECTRONICS	TSG7515	•		•		•			5V -5V	50 mW				
SIERRA SEMICONDUCTOR	SC11004	•		•		•			5V -5V	150 mW		•	•	
	SC11006	•		•	•	•	•		5V -5V	175 mW		•	•	
	SC11014	•		•	•	•			5V -5V	150 mW		•	•	
	SC11015	•		•	•	•			5V -5V	150 mW		•	•	
	SC11016	•		•	•	•			5V	70 mW		•	•	
SILICON SYSTEMS	K212	•		•					5V, 12V (2 VERSIONS)	30 mW AT 5V 180 mW AT 12V		•		
	K221				•	•			5V, 12V (2 VERSIONS)	30 mW AT 5V 180 mW AT 12V		•		
	K222	•		•	•	•			5V, 12V (2 VERSIONS)	30 mW AT 5V 180 mW AT 12V		•		
	K224	•		•	•	•	•		5V, 12V (2 VERSIONS)	100 mW AT 5V 360 mW AT 12V		•		
	K322					•		•	5V, 12V (2 VERSIONS)	30 mW AT 5V 180 mW AT 12V		•		
	K324				•	•	•	•	5V, 12V (2 VERSIONS)	120 mW AT 5V		•		
VLSI TECHNOLOGY	VL7C412			•	•	•			5V	70 mW		•	•	
	VL7C312			•	•	•			5V -5V	150 mW		•	•	
	VL7C212			•	•	•			5V -5V	150 mW		•	•	
	VL7224A	•		•	•	•	•		5V -5V	—		•	•	
XECOM	XE1212	•		•	•	•			5V -5V	400 mW	•	•	•	•
	XE1214	•		•	•	•			5V -5V	1W		•	•	•
	XE2400	•		•	•	•	•		5V -5V	1W		•	•	•

NOTES: 1. ALB = ANALOG LOOP BACK; DLB = DIGITAL LOOP BACK.
 2. PLCC = PLASTIC LEADED CHIP CARRIER.
 3. SCF = SWITCHED CAPACITOR FILTER.

FILTER TYPES	AGC	CALL-PROGRESS TONE DETECTION	TECHNOLOGY	TEST FEATURES	PACKAGE	COST	OTHER FEATURES
SCF	•	•	CMOS	ALB DLB	22-PIN DIP, 28-PIN PLCC	\$16.50 (100)	PIN AND SOFTWARE COMPATIBLE WITH SSI'S K221, K222, AND K224 MODEM ICs
SCF			CMOS	INTERNAL LOOP-BACK TEST	16-PIN DIP	\$6.19 (100)	DIGITAL DEMODULATOR
DIGITAL AND SCF	•	•	CMOS	ALB DLB	40-PIN DIP	\$15 (100)	
DIGITAL		•	CMOS	ALB DLB	28-PIN DIP, SMD	\$18 (100)	
DIGITAL		•	CMOS	ALB DLB	28-PIN DIP, PLCC	\$18 (100)	
SCF AND DIGITAL	•	•	CMOS (ANALOG) NMOS (DIGITAL)	EQM (EYE QUALITY MODEM)	64-PIN QUAD-IN-LINE PACKAGE	\$49 (1000)	DSP CHIP CONFORMS TO V.27TER 2400-BPS OPERATION; ADAPTIVE EQUALIZER
SCF AND DIGITAL	•	•	CMOS (ANALOG) NMOS (DIGITAL)	EQM (EYE QUALITY MODEM)	64-PIN QUAD-IN-LINE PACKAGE	\$60 (1000)	CONFORMS TO V.27TER 4800-BPS OPERATION; DSP CHIP
SCF	•	•	CMOS	ALB DLB	28-PIN DIP	\$20 (100)	DIGITAL PLL DEMODULATOR GENERATES 1800-Hz GUARD TONE ONLY
SCF	•	•	CMOS	ALB DLB	24-PIN DIP, 28-PIN PLCC	\$18.20 (100)	OPERATES WITH SC11007/008/017 DEDICATED CONTROLLERS
SCF	•	•	CMOS	ALB DLB	28-PIN DIP, PLCC	\$35 (100)	ADAPTIVE EQUALIZATION AND DECRYPTING DONE IN SC11009/010/011 CONTROLLER
SCF	•	•	CMOS	ALB DLB	24-PIN DIP, 28-PIN PLCC	\$21 (100)	DEDICATED CONTROLLER; (SC11007/008/017)
SCF	•	•	CMOS	ALB DLB	24-PIN DIP, 28-PIN PLCC	\$23 (100)	PROGRAMMABLE GAIN AMPLIFIER, USES DEDICATED CONTROLLER
SCF	•	•	CMOS	ALB DLB	24-PIN DIP, 28-PIN PLCC	\$25.90 (100)	STANDBY POWER MODE; DEDICATED CONTROLLER (SC11027/028)
SCF	•	•	CMOS	ALB, DLB TEST PATTERN	22-PIN DIP, 28-PIN DIP, 28-PIN PLCC	\$21 TO \$24 (100)	COMPROMISE EQUALIZER; PIN COMPATIBLE WITH K SERIES
SCF	•	•	CMOS	ALB DLB	22-PIN DIP, 28-PIN DIP, 28-PIN PLCC	\$24 TO \$25 (100)	PIN COMPATIBLE WITH K SERIES
SCF	•	•	CMOS	ALB DLB	22-PIN DIP, 28-PIN DIP, 28-PIN PLCC	\$29 TO \$34 (100)	PIN COMPATIBLE WITH K SERIES
SCF	•	•	CMOS	ALB DLB	22-PIN DIP, 28-PIN DIP, 28-PIN PLCC	\$65 TO \$70 (100)	COMPROMISE AND ADAPTIVE EQUALIZER COMPATIBLE WITH K SERIES
SCF	•	•	CMOS	ALB DLB	22-PIN DIP, 28-PIN DIP, 28-PIN PLCC		75-BPS BACK CHANNEL COMPATIBLE WITH K SERIES
SCF	•	•	CMOS	ALB DLB	22-PIN DIP, 28-PIN DIP, 28-PIN PLCC		COMPROMISE AND ADAPTIVE EQUALIZERS; COMPATIBLE WITH K SERIES
SCF	•	•	CMOS	ALB DLB	24-PIN DIP, 28-PIN PLCC	\$9 (100,000)	DIRECT REPLACEMENT FOR SIERRA SC11016; COMPROMISE EQUALIZER
SCF	•	•	CMOS	ALB DLB	24-PIN DIP, 28-PIN PLCC	\$9.50 (100,000)	DIRECTLY REPLACES SC11015; PROGRAMMABLE GAIN RECEIVER
SCF	•	•	CMOS	ALB DLB	24-PIN DIP, 28-PIN PLCC	\$9 (100,000)	DIRECTLY REPLACES SC11004 AND SC11014; AUDIO OUTPUT PORT
SCF	•	•	CMOS	ALB DLB	28-PIN DIP, PLCC	\$13 (100,000)	ADAPTIVE EQUALIZATION IS PERFORMED IN DEDICATED CONTROLLER (VL7C235/245)
SCF	•	•	HYBRID	ALB DLB	40-PIN 2.28x1.00x0.50-IN. PACKAGE	\$116 (100)	FCC REGISTERED
SCF	•	•	HYBRID	ALB DLB	40-PIN 2.28x1.00x0.5-IN. PACKAGE	\$116 (100)	FCC REGISTERED
DIGITAL	•	•	HYBRID	ALB DLB	40-PIN 2.75x1.38x0.625-IN. PACKAGE	\$269 (100)	FCC REGISTERED

If you're willing to spend the money on a hybrid module, you'll get an FCC-registered DAA.

tas loop coherently demodulates the phase-encoded data in the receiver. The XR-2130 has call-progress detection, DTMF dialing, and analog, digital (local and remote) loopback test modes. With the addition of another chip (the XR-2100), it can support CCITT V.21 0- to 300-bps operation. The device comes in a 28-pin DIP.

The TSG7515 chip from SGS-Thomson also conforms to Bell 212A and 103 and CCITT V.22 (A, B) modem specifications. The filters for the transmit and receive functions as well as for call-progress detection are built with switched-capacitor filters. The chip generates all of the necessary modulation and answer tones along with the 1800-Hz guard tone for V.22 operation. It does not have a DTMF generator or a 4- to 2-wire hybrid on chip, however, which means that you need additional external components to implement these functions. The

chip uses a digital phase lock loop (PLL) in the quad-PSK demodulator.

Full-duplex, 2400-bps operation is also possible

Single-IC modems are also moving into the 2400-bps marketplace. The CCITT V.22bis specification, which establishes the requirements for full-duplex operation, stipulates that data be encoded into quad bits. This encoded data performs amplitude and phase modulation of the carrier frequency, using QAM, resulting in 16 constellation points. Because this operation requires a complex modulation and demodulation process, the V.22bis specification calls for adaptive equalization to compensate for transmission-line distortions and to reduce intersymbol interference. The SSI K224 modem, discussed previously, performs these functions on a single chip.

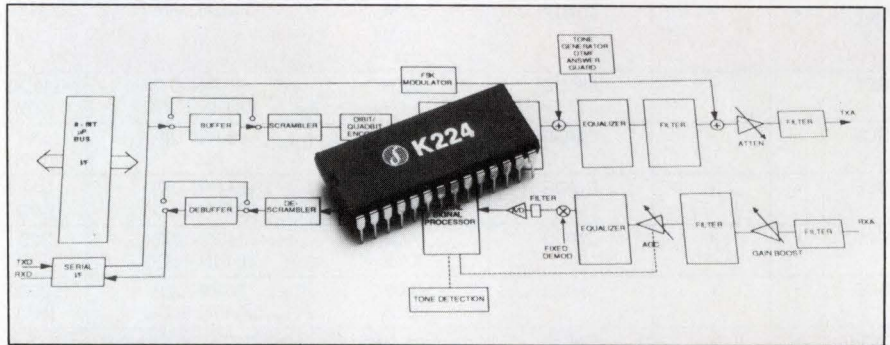

The K224 single-chip modem contains all of the modem functions to operate at 1200 and 2400 bps. This K Series member, available from Silicon Systems, is plug compatible with all other K Series devices.

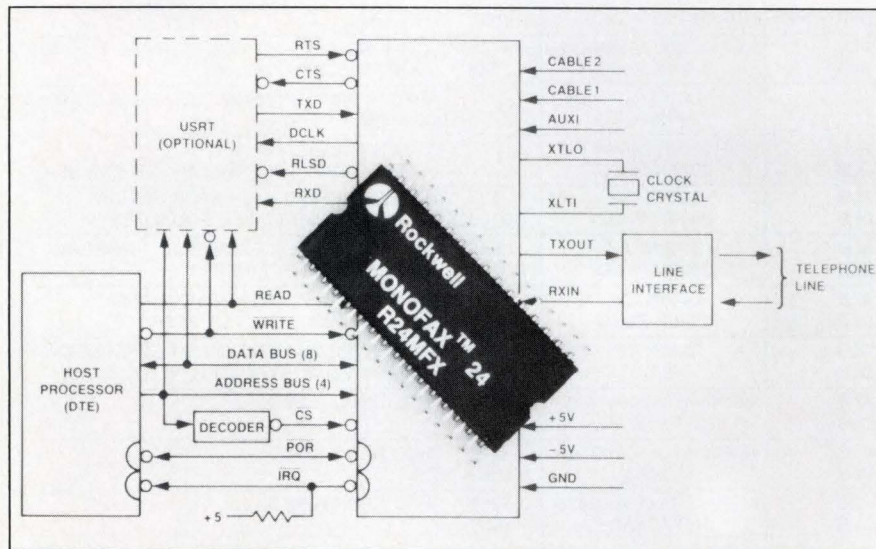

The R24MFX Monofax modem consists of two chips housed in a quad-in-line package. Manufactured by Rockwell, the IC is optimized for compact Group 3 facsimile machines.

MOVE UP TO 2400 BPS WITH EXAR'S MODEM ICs

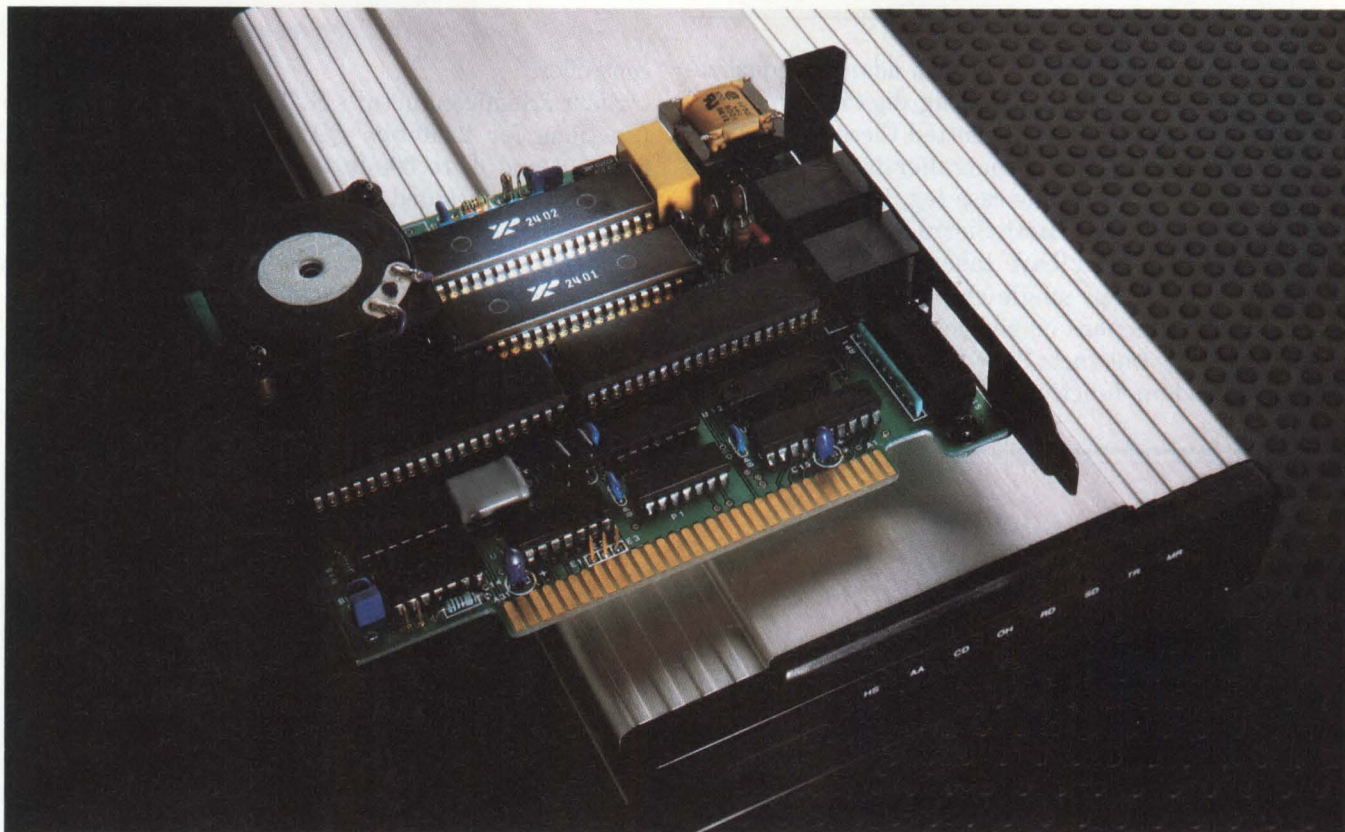

EXAR's full featured V.22 bis chip set is 100% CCITT & Bell compatible

The XR-2401 digital signal processor and the XR-2402 analog front end form the perfect engine to your modem. The chip set was designed to interface directly to such popular microcontrollers as the 8051 and Z8. The XR-2400 chip set features:

- Low power CMOS – 450 mW max
- Two separate TX carrier wave shaping
- On-chip ASYN/SYN buffer with over speed buffer option
- Parallel TXD option for MNP implementation
- Analog loopback
- Local and remote digital loopback
- V.22 bis, V.22, 212A compatible

Flexible architecture allows enhancements

Our modular architecture allows you to differentiate your product from your competitors. Since the XR-2401 & XR-2402 provide the complete modem function, and the command set is implemented separately in the microcontroller, you can easily incorporate your own customized "AT" command set to enhance your modem.

System design support

When you use EXAR's 2400 BPS solution, you are not only getting a versatile solution, but also a decade of modem design expertise. Since introducing the market's first monolithic modem solution EXAR has supported customers with system design. Today, to facilitate your design EXAR has a low cost XR-2400ES evaluation system consisting of:

- A fully tested stand-alone modem
- A system design manual
- A complete "AT" command set with documentation and source code.

And should you require further assistance, our experienced application staff is but a phone call away.

Call EXAR today and find out why we have achieved a reputation for service the world over.

The XR-2401 & XR-2402 are in full production now!

With the XR-2400 chip set in production since last year, you can be confident that you will go to production with the same ICs you designed with. You won't have to worry about the ICs going through any redesigns, or being unable to meet your production commitments.

The XR-2401 & XR-2402 are in production and available from stock TODAY!



Rush me the XR 2400 Datasheet

EDN041488

Name _____ Title _____

Company _____ Dept. _____

Address _____

City _____ State (Country) _____ Zip Code _____

Phone (_____) _____ Ext. _____

Application _____

 **EXAR**

OR Call us at (408) 434-6400

2222 Qume Dr., P.O. Box 49007, San Jose, CA 95161-9007
Tel. (408) 434-6400 FAX (408) 943-8245

Some manufacturers have allotted some modem tasks to a dedicated controller because the modem requires a controller for housekeeping tasks anyway.

Because it is possible to perform adaptive equalization and some modem tasks using digital techniques, certain manufacturers have allotted these functions to an external controller; a controller is necessary for housekeeping tasks, in any case (eg, handshake protocols and mode control). Both Sierra Semiconductor and VLSI Technology Inc have taken this approach. The companies' 1200-bps single-chip modems have all of their modem functions on one chip (including the 4- to 2-wire hybrid), but their 2400-bps products have some of their modem functions handled by the external

controller.

Sierra Semiconductor's SC11006 chip contains the functions for 2400-bps QAM, 1200-bps quad PSK (QPSK), and 0- to 300-bps operation. A 4- to 2-wire hybrid is also included. The chip is compatible with Bell 212A and 103, and CCITT V.21, V.22, and V.22bis standards. The on-chip transmitter includes the data encoder; a quadrature modulator; high-band and low-band filters and compromise equalizers; a programmable attenuator for transmit-level adjustment; and DTMF, guard-tone, and answer-tone generators. The

Glossary of modem terminology

The following is a brief glossary of some specialized modem-terminology phrases.

Analog loop back (ALB)—A diagnostic mode whereby the analog output of the transmitter connects to the analog input of the receiver. This mode allows the local receiver to demodulate the data modulated by the local transceiver.

Answer tone—An answering modem, after automatically answering a call, transmits an answer tone back to the originating modem, which indicates to the originating modem's system that the remote modem has answered the call.

Asynchronous transmission—A data-transmission scheme that handles data without clock synchronization. It consists of a character code comprising a start bit, five to nine data bits, a parity bit, and one or two stop bits.

Back channel—A low-data-rate channel used on half-duplex modems to allow small amounts of data to be received or transmitted in the opposite direction of the main-channel data.

Baud rate—A unit of signaling speed equal to the number of

modulations per second. In FSK modulation, it is equal to the bps rate. In QPSK, it is half the bit rate because the data is encoded in dibits.

Bit rate (bps)—Number of bits transmitted per second.

Data-access arrangement (DAA)—Protective circuitry that the FCC requires so that the user is protected from harsh telephone environments, and so that the network is protected from customer-equipment malfunction.

Digital loop back (DLB)—A diagnostic mode whereby received digital data at a remote modem is connected to the transmit digital input for retransmission back to the originating modem. Because an analog medium, such as the PSTN, is used in the test, both the remote modem and the medium are under scrutiny.

Dual tone multiple frequency (DTMF)—Two distinct telephone signaling tones used for dialing.

Duplexer (4- to 2-wire hybrid)—Circuit that matches the 4-wire modem signal to the 2-wire telephone network.

Full duplex—Simultaneous data transmission by two modems at

the same speed in different directions.

Guard tones—Tones that are specified in some CCITT standards and which must be transmitted when using certain international telephone exchanges.

Half duplex—Data transmission between two modems that takes place in only one direction at a time. The line must be "turned around" to allow data transmission in the opposite direction. In some cases, a back channel is included, which permits a low-data-rate channel in the opposite direction.

Hybrid, 4- to 2-wire—See duplexer.

On/off hook switch—Switch in the DAA that indicates that the customer is connected to the telephone network. When the switch is in its off-hook state, current flows from the telephone central office through the customer's equipment.

Progress tones—Signaling tones that the central telephone office provides to indicate network conditions to the customer.

Some examples are dial tone, ringback tone, and busy signal.

SMARTER THAN THE AVERAGE INTELLIGENT SERIAL I/O CONTROLLER

NEW IV-1624 GETS AN "A"!

Of course you might expect that from a board whose parent was the first and most successful VMEbus Intelligent Serial I/O Controller. Introducing the new IV-1624A 8-Port Intelligent Serial I/O Controller. We've made it smarter and we're proud of it!

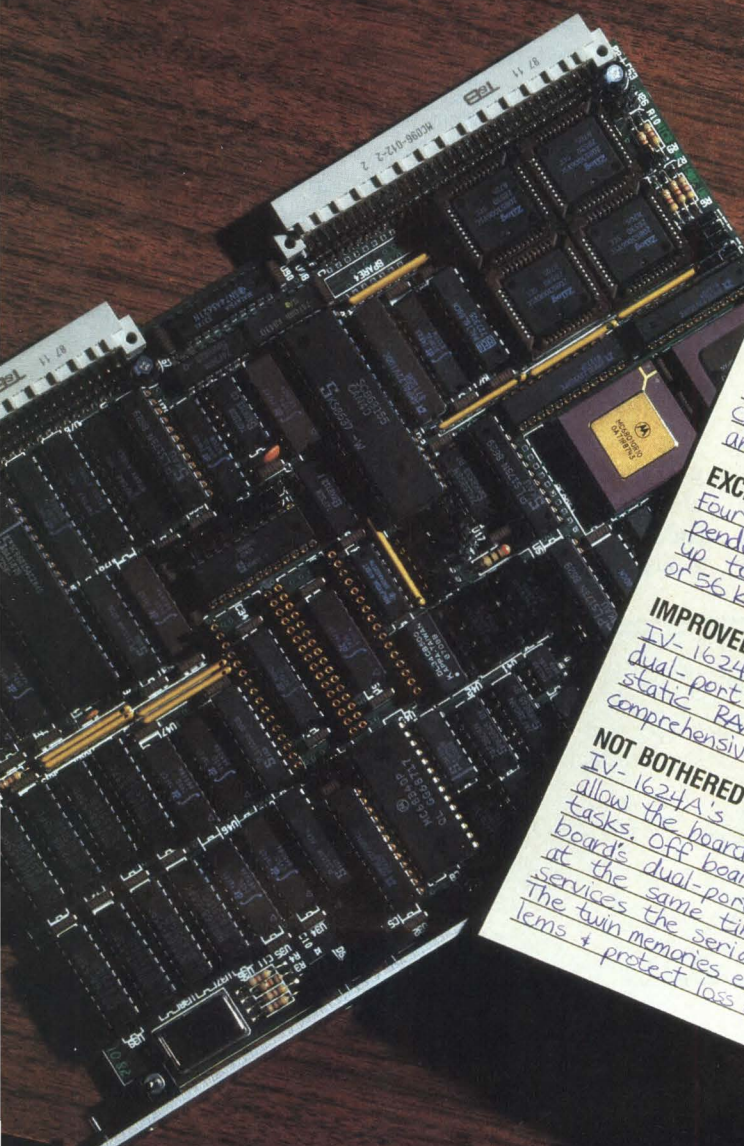

VMEbus REPORT CARD: IV-1624A

SMARTER THAN THE AVERAGE INTELLIGENT I/O BOARD
An on-board optional 68450 DMAC and large local memory give IV-1624A enough processing power to take over I/O handling throughout a system. This frees other processors from protocol packaging and data integrity checking functions. **A**

WORKS AND PLAYS WELL WITH OTHERS
IV-1624A performs extremely well with other processors on the bus. Its Multiprocessing Engine™ features including 32 bit wide dual-port memory mailbox interrupts and rapid strobe deassertion enable fast efficient message and data exchange with other CPU's. These conserve critical bus bandwidth in multiprocessing systems and allow more IV-1624A's to share one bus. **A**

EXCELLENT COMMUNICATION SKILLS
Four Z8530's provide eight channels of independent configurable serial I/O. Data rates up to 1 megabit per second on a single channel or 56 kbaud/channel aggregate are supported. **A**

IMPROVED MEMORY SKILLS
IV-1624A is now available with 1 megabyte of dual-port DRAM in addition to 64 kbytes of fast static RAM. This means room for more comprehensive programs and larger data buffering. **A**

NOT BOTHERED BY INTERRUPTIONS
IV-1624A's twin dual-port memory resources allow the board to handle complex simultaneous tasks. Off board to handle CPU or DMAC at the same time the board's CPU or DMAC services the serial ports via dual-port DRAM. The twin memories eliminate most RAM contention problems + protect loss of data even at high baud rates! **A**

For further information on the New IV-1624A 8-Port Intelligent Serial I/O Controller or on any of IRONICS' Real-Time Multiprocessing Products, contact Ironics Incorporated, 798 Cascadilla Street, Ithaca, NY 14850, Telephone (607) 277-4060 Telex 705-742, FAX 607-272-5787.

Multiprocessing Engine is a trademark of Ironics Incorporated.



If you have to have your own DAA qualified, you should retain the services of a modem consultant.

on-chip receiver has a 64-step programmable-gain amplifier, a Hilbert transformer, a quadrature demodulator, an 8-bit A/D converter, an audio output port, control and status registers, and an 8-bit μ P interface with multiplexed address and data lines. The chip comes in either a 28-pin DIP or PLCC.

The external controller can be either a dedicated controller such as a Sierra SC11009 (for parallel bus applications) or SC11010 (for RS-232C applications) or a general-purpose μ controller such as Intel's 8096. The Sierra dedicated controller contains the complete Hayes AT command set and performs adaptive equalization, carrier phase recovery, data decoding, and descrambling on 8-bit samples from the SC11006 chip. After the samples are processed, the controller writes the data back to the modem chip to perform synchronous-to-asynchronous conversion, if required.

VLSI Technology's VL7C224A 2400-bps modem chip also conforms to CCITT V.22bis as well as CCITT V.22 and V.21 and Bell 212A and 103 standards. And, like its Sierra counterpart, it relies on an external controller to perform adaptive equalization, carrier phase recovery, data decoding, and descrambling. The chip interfaces

with either an 8096 μ controller or one of the company's dedicated controllers such as the VL7C225, 235, or 245, which contain the Hayes AT command set in firmware. The device contains DTMF and guard-tone generators, call-progress detectors, and an on-chip 4- to 2-wire hybrid. It provides analog, digital, and remote digital loopback test features along with a programmable audio output.

To a purist, a hybrid modem may not be a single-IC modem because a hybrid module contains many chips. However, for an OEM designer who needs a single-package solution, the difference may not matter. And, because these modules contain the necessary 4- to 2-wire hybrid and DAA unit, the real estate required to build a complete modem is comparable to that of the single-IC modems described thus far.

The initial cost of a hybrid module is considerably greater than that of a single-IC design, but the inclusion of an FCC-registered DAA can enable you to get your product to market fast. Purchasers of the aforementioned single-IC modems, who have to qualify their own DAAs, would be wise to retain the services of a modem consultant. The time to obtain FCC approval

Manufacturers of single-IC modems

For more information on single-IC modems such as the ones discussed in this article, contact the following manufacturers directly, circle the appropriate numbers on the Information Retrieval Service card, or use EDN's Express Request service.

Advanced Micro Devices Inc
Box 3453
Sunnyvale, CA 94088
(408) 732-2400
TWX 910-339-9280
Circle No 650

Cermetek Microelectronics Inc
1308 Borregas Ave
Sunnyvale, CA 94088
(408) 752-5000
TWX 910-379-6931
Circle No 651

Exar Corp
Box 49007
San Jose, CA 95161
(408) 434-6400
FAX 408-943-8245
Circle No 652

GE Solid State
Rte 202
Somerville, NJ 08876
(201) 685-6575
TWX 710-480-9333
Circle No 653

Micro Power Systems
Box 54965
Santa Clara, CA 95054
(408) 727-5350
TWX 910-338-0154
Circle No 654

National Semiconductor Corp
Box 58090
Santa Clara, CA 95052
(408) 721-5000
TLX 346353
Circle No 655

Rockwell International Corp
Semiconductor Products Div
Box C
Newport Beach, CA 92658
(714) 833-4700
Circle No 656

SGS-Thomson Microelectronics Inc
1310 Electronics Dr
Carrollton, TX 75006
(214) 466-6000
TLX 730643
Circle No 657

Sierra Semiconductor Corp
2075 N Capitol Ave
San Jose, CA 95132
(408) 263-9300
FAX 408-263-3337
Circle No 658

Silicon Systems Inc
14351 Myford Rd
Tustin, CA 92651
(714) 731-7110
TWX 910-595-2809
Circle No 659

VLSI Technology Inc
8375 S River Parkway
Tempe, AZ 85284
(602) 752-6222
FAX 602-752-6000
Circle No 660

Xecom Inc
374 Turquoise St
Milpitas, CA 95035
(408) 945-6640
TLX 325672
Circle No 661

VICOR Component Solutions For Your Power System

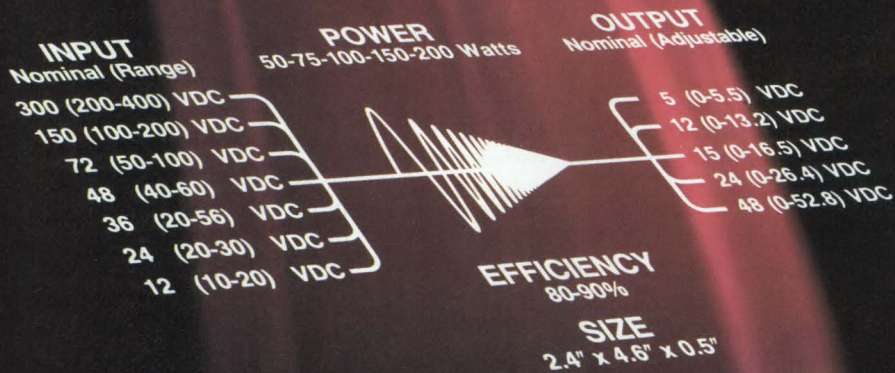

No Room Left For Your Power Supply? Talk To VICOR!

VI-200's deliver as much as 200W from 5.5 In.³

Write for our application note,
"Power Systems Size Reduction with
High Density DC-DC Converters."



Different manufacturers have approached the single-IC-modem market from various directions, and therefore it's difficult to define a single-IC modem.

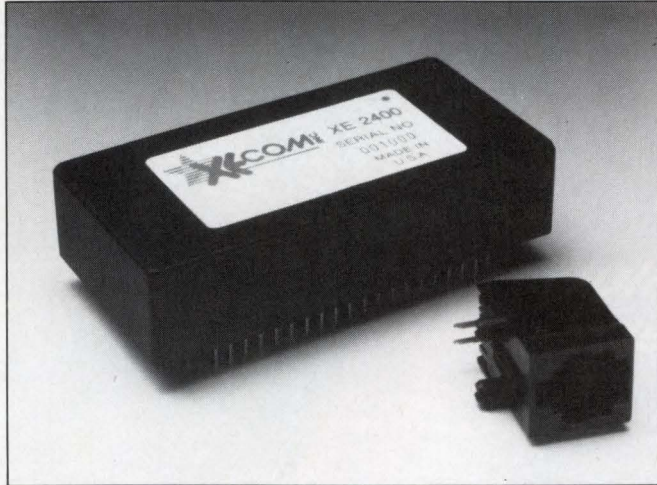

Hybrid modules, such as the XE2400 from Xecom, have built-in 2- to 4-wire hybrids and FCC-registered DAAs. Hybrid modules have the advantage of being quicker to get to market.

is typically 90 days, and, if the FCC rejects your design, you will have to modify it and start all over again—at the end of the queue. A qualified consultant, however, will test the design to FCC specifications and suggest modifications before submitting it to the FCC for approval. The approximate \$2500 fee includes the services of the consultant and FCC charges.

The CH1780 hybrid module from Cermetek conforms to CCITT V.22bis and V.22 and Bell 212A and 103 specifications and therefore operates at 2400, 1200, and 0 to 300 bps, respectively. It measures 2.54×3.74×.75 in. and has 44 pins, which you can directly solder or place in a socket. Like all hybrid modules, the CH1780 contains the 4- to 2-wire hybrid and a built-in FCC Part 68-registered DAA with an FCC registration number and Ringer Equivalence Number (REN). The module responds to the Hayes AT command set, allowing it to answer and initiate calls and execute diagnostic tests. Because the module is configured for serial communications, a UART is required to interface with a host. The host controls the modem by sending serial ASCII command sequences.

Another hybrid module is Xecom's XE2400, which measures 2.75×1.38×.625 in. and has 40 pins. The device conforms to CCITT V.22bis, V.22, and V.21, and Bell 212A and 103 specifications. It uses the Hayes AT command set, interfacing with the host through a serial TTL interface; a series of ASCII commands provides control. The XE2400 supports analog and digital loop-back tests.

Rockwell International chooses to put more than one

chip on a single substrate and call it a single-package modem. The R48MFX Monofax facsimile modem comprises two chips packaged in a 64-pin quad-in-line package. Optimized for use in compact Group 3 facsimile machines, it supports CCITT V.27ter 4800- and 2400-bps half-duplex modes as well as the CCITT V.21 spec for 0- to 300-bps protocol communications. The unit includes adaptive equalization, can diagnostically determine line quality, and has two DTE interfaces (a parallel μ P bus and an RS-232C serial port). It also contains DTMF generators.

Different manufacturers have approached the single-IC-modem market from various directions, and therefore it is difficult to put bounds on the devices to include in a report such as this. All single-IC modems, however—regardless of definition—require a controller. Keeping this in mind, this report has limited its coverage to single-IC modems that have all the modem functions performed by either a single-package device or a single device and a controller. If you have the real estate for an additional IC, however, many manufacturers, such as Intel, Exar, and Gould, sell 2400-bps modems with the modem functions split between two ICs. These chip sets consists of an IC for the analog front-end section followed by an IC that performs the remaining modem tasks. The two chips must then interface with a controller to function as a modem.

EDN

Reference

1. *The Modem and Modem ICs Market*, Electronic Trend Publications, Saratoga, CA, 1987. The reports sells for approximately \$1000.

Article Interest Quotient (Circle One)
High 470 Medium 471 Low 472

Fully featured OEM CCITT V.22 bis (2400 bps) modems... in 12 sq. in.

- Surface-mount manufactured
- Low power
- Standard or custom

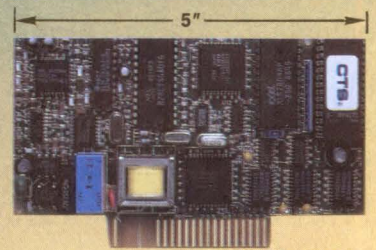
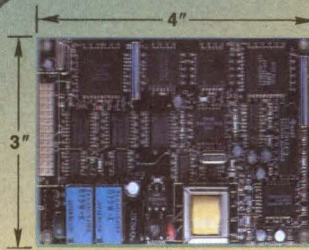
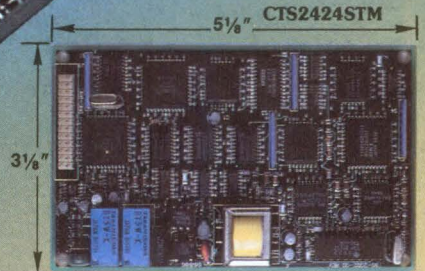
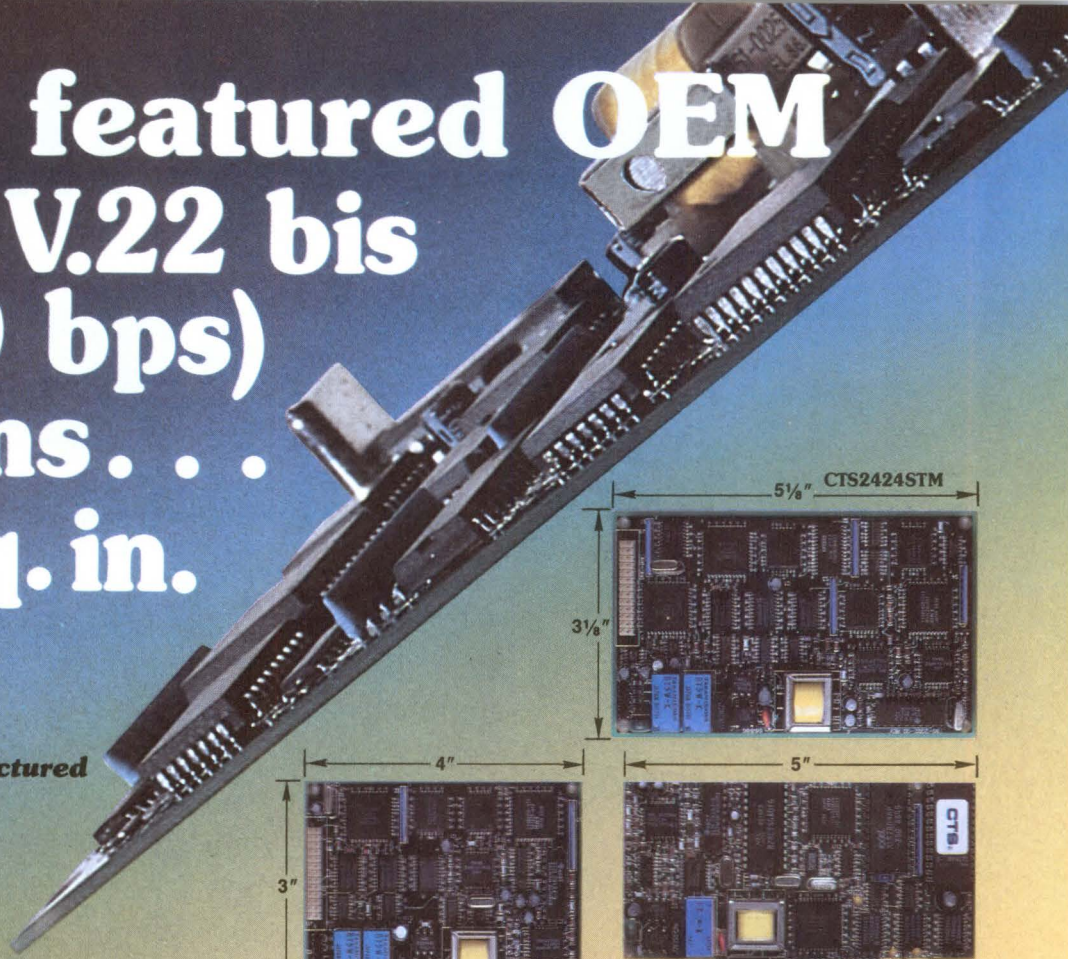

CTS2424STH

CUSTOM DESIGN

Others offer less capability—greater size. CTS offers greater capability—less size. The choice is yours in three advanced, 2400 bps full duplex modems:

CUSTOM DESIGN. First known battery powered modem utilizing surface mount manufacturing technologies for laptop microcomputers □ Occupies less than 13 square inches □ Low power—consumes less than 1 watt.

CTS2424STM. Smallest available standard applications modem with MNP* error correcting Class 4 protocol

□ TTL interfaced □ Compact 16 square inches □ Fully Hayes † command set compatible □ Integral adaptive equalizer in sophisticated CTS C-MOS designed signal processor □ Optional European fallback capabilities of CCITT V.22 A/B, V.23 and V.21 □ Less than \$180.00 each in quantity.

CTS2424STH. Smallest, lowest power standard modem □ Integral adaptive equalizer in advanced CTS C-MOS designed signal processor □ 12 square inches □ Uses less than 1 watt power

□ Incorporates Hayes command set—offers European compatibilities V.22 bis, V.22 A/B, V.23 and V.21 plus guard tone capabilities □ Under \$160.00 each in quantity.

Call toll free today 1-800-328-6104 or write CTS Fabri-Tek, Inc. Datacomm

Products Division, 6900 Shady Oak Road, Eden Prairie, Minnesota 55344 for a copy of our new full color brochure entitled CTS Custom OEM Modems.



CIRCLE NO 71

CTS MEANS RELIABILITY

CTS Fabri-Tek, Inc. □ Datacomm Products Division



Data Pump Custom Designed 2400 Full Duplex Modem.
Circle No. 170

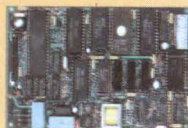

TTL Interfaced 2400 bps Full Duplex Modem for Small Quantity Users.
Circle No. 171

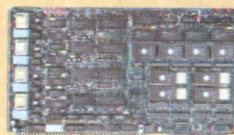

Quadmodem Four 2400 bps Full Duplex Modems on One Board
Circle No. 172

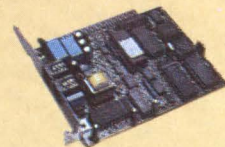

Half-Pak #24 IBM† PC Compatible Half Card 2400 bps Modem
Circle No. 173

New to the Industry Since 1896.

INTRODUCING THE IDEAL

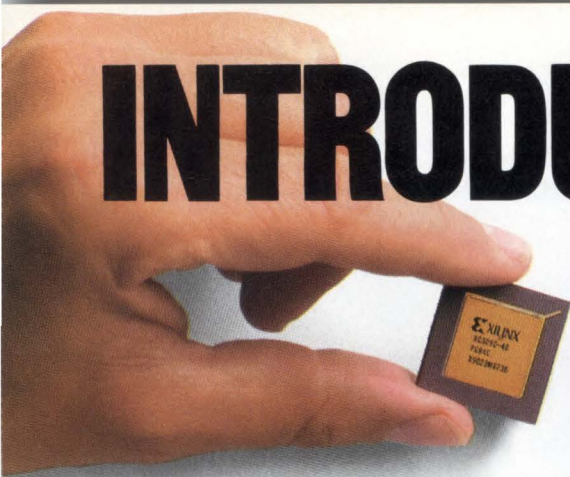

A leader's work is never done.

No sooner do we invent the Programmable Gate Array™ and with it a whole new category of logic devices, than we're already outdoing ourselves.

By adding a brand new, more powerful family of Programmable Gate Arrays, the 3000 series.

What's new and different?

They're faster and denser,

with more gates than anybody ever thought a programmable logic device would ever have.

And, are you ready? Cheaper to use than conventional gate arrays.

Which makes them more ideal than ever.

Xilinx Programmable Gate Arrays have densities up to and including 9000 honest gates. How dense can you get? We aim to keep finding out.

THE PROGRAMMABLE GATE ARRAY, IMPROVED.

The 3000 series has a second generation Logic Cell™ Array architecture that turns a 40 MHz system clock rate.

That's enough speed to run with the highest performance microprocessors you can name.

Of course, our patented



Are the zebra's stripes white-on-black or black-on-white? Should you buy the Programmable Gate Array for its cost-effectiveness, short development cycle, off-the-shelf availability, or its 100% testability? Yes to both questions.

LOGIC DEVICE. AGAIN.

architecture is also responsible for gate counts that range from 1200 in the XC 2064 to 9000 in the XC 3090.

Enough density for just about any logic application you can name.

Plus more flexibility in routing and gate utilization than you'll know what to do with.

THE ONLY LOGIC DEVICE YOU MAY EVER NEED.

Like all Xilinx Programmable Gate Arrays, our 3000 series offers the same advantages you've come to know and love:

Gate array density.
User-programmability with unlimited reprogrammability.

No NRE or inventory risk.

100% tested parts.
Low cost gate array type design tools.

And a development cycle that fits between paychecks.

Our Programmable Gate Arrays also make it simple to choose a logic device.

They simply make every other logic device obsolete.

With their new architecture, you'll have the speed you need, plus the density to get all your logic on one device.

A device with advantages no other technology can match.

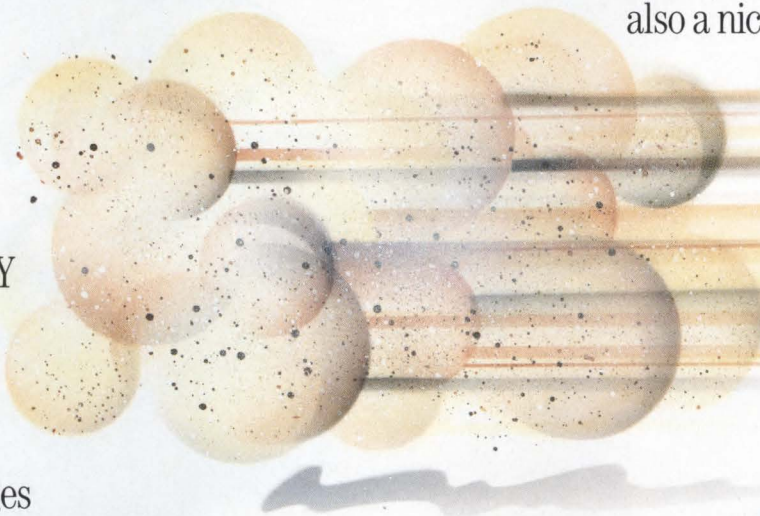

Want to see how fast our new 3000 series is? Want to see it again?

Now stop and ask yourself, "Why should I use anything else?"

Good question, isn't it?

THE PRICE IS RIGHT, TOO.

We've told you about our improved speed.

And our increased density.

But we've saved the best news for last.

Using a Xilinx Programmable Gate Array costs *less* than using a conventional gate array.

So much less it isn't even funny. At least, not to them.

We can prove it, too.

We've prepared a study that lays out the cost comparison data in detail and, needless to say, we'd love to send you a copy. (There's also a nice thick data

book for those of you who are already true believers.)

Just call us toll-free at (800) 255-7778.

In California, (408) 559-7778. Or contact your local Xilinx sales representative or distributor.

The Programmable Gate Array from Xilinx. It's everything you've ever wanted. Again.

 **XILINX**

The Programmable Gate Array CompanySM

Xilinx, Logic Cell Array, XACT and Programmable Gate are trademarks and The Programmable Gate Array Company is a service mark of Xilinx, Inc.

© 1987 Xilinx, Inc., 2069 Hamilton Ave., San Jose, CA 95125, (408) 559-7778.

Put Our DC-DC Converters to the Test

Put any of Vicor's series of DC-DC converters to the test with the Module Evaluation Board.

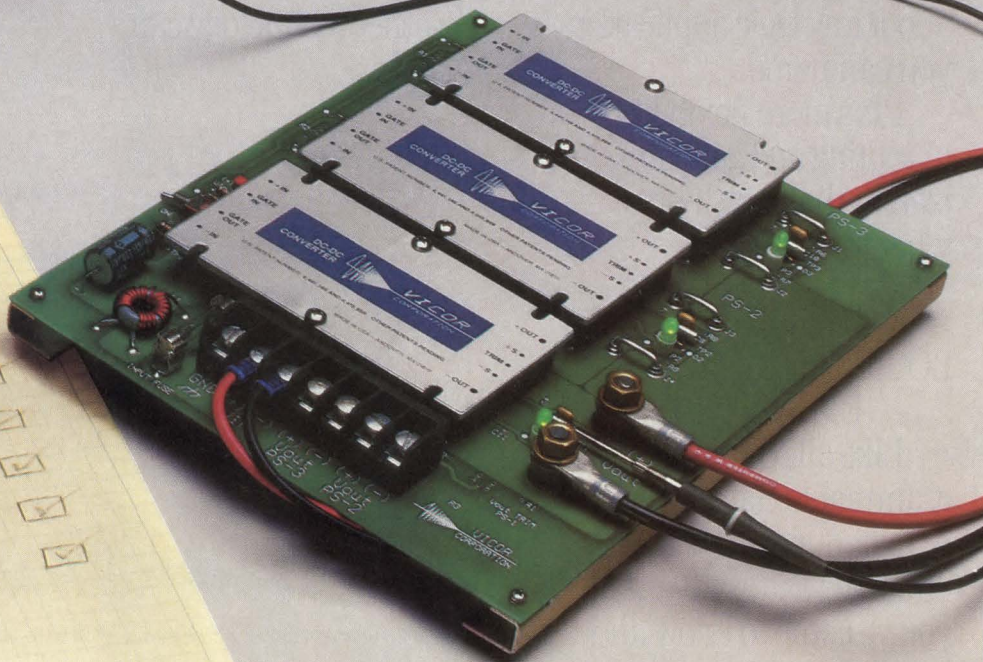
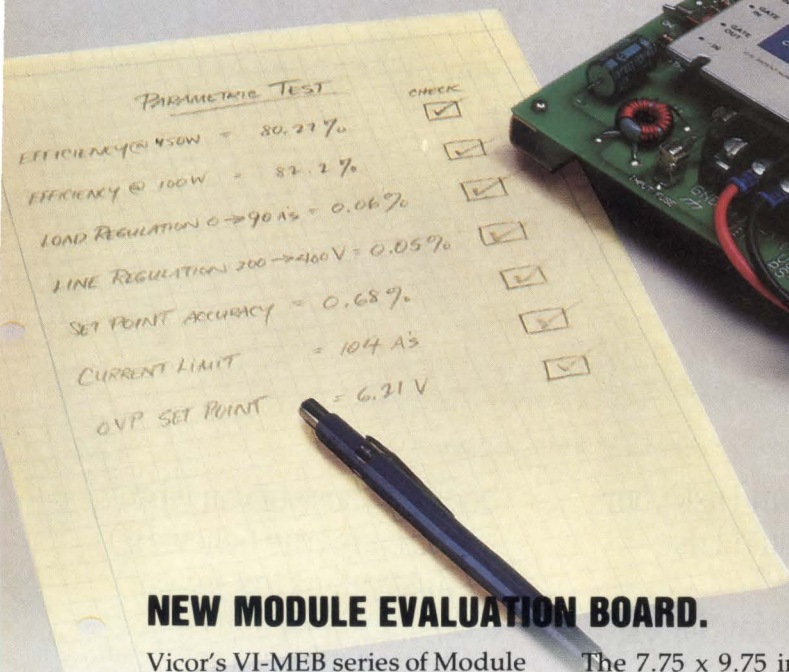
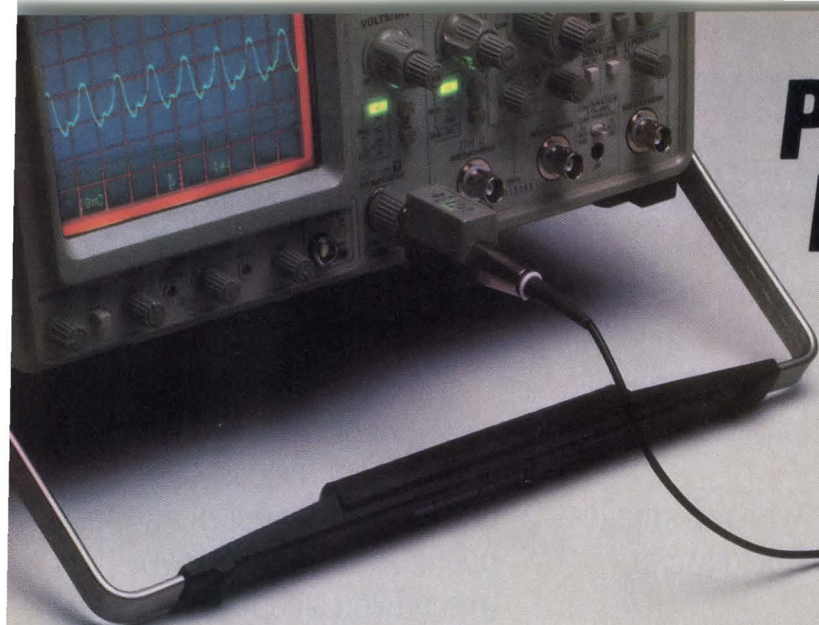

NEW MODULE EVALUATION BOARD.

Vicor's VI-MEB series of Module Evaluation Boards provides a means for rapid and comprehensive evaluation of Vicor converters. The VI-MEB-LV evaluation board is designed to accept modules with input voltages up to 100 VDC. The VI-MEB-HV is designed to accept modules with input voltages of 100 to 400 VDC. Designed to work with all Vicor DC-DC converters, the boards come complete with a barrier terminal strip, output lugs, measurement connections, fuse and detailed user's manual, covering measurement techniques and useful application information.

The 7.75 x 9.75 inch board will accept up to 3 Vicor modules and can be configured as a single, dual or triple output power supply. As a single output supply, the evaluation board will deliver up to 90 amps at 5 volts. Other single, dual and triple output configurations deliver up to 600 watts.

Accurate measurement of output parameters is facilitated by the use of oscilloscope probe receptacles and heavy duty output lugs. Jumper connections provide ease of reconfiguration for evaluations of different types of modules.

Vicor's "component level" megahertz converters allow power systems designers to focus on system solutions instead of circuit details. The benefits: fast, predictable design cycles; predictable field performance; and smaller, simpler, high reliability power assemblies with significantly reduced component count.

Call Vicor today at (617) 470-2900, or write 23 Frontage Road, Andover, MA 01810 for the Module Evaluation Board data sheet and put Vicor modules to the test!



Component Solutions For Your Power System

XICOR RAISES MILITARY DESIGNS TO A HIGHER LEVEL.

E²PROM

Our full military E²PROM line-up gives you one-stop shopping convenience.

Now you can promote your memory-intensive military designs to a higher level of functionality. With Xicor's complete line of military E²PROMs, NOVRAMs and E² potentiometers.

They raise system performance and power economies to a new level. And unlike most memories, Xicor E² devices can be remotely reprogrammed in the field, via telephone link. In the case of our E² potentiometers, they can automatically tune themselves while in service—kind of like an "electronic screwdriver." Plus our high density E²PROM memories are loaded with features like Page Mode, DATA Polling, Toggle Bit and Software Data Protection.

Volume-manufactured in JEDEC-approved pin-outs, Xicor E² devices come in all the popular packaging configurations, including surface mount. And they're backed by Xicor's on-site technical design support. For more details on JAN, DESC Drawing and 883C products, call (408) 432-8888 today, or write: Xicor, Inc., 851 Buckeye Court, Milpitas, CA 95035.

E ² PROM Part No.	Organ.	Page Size (# Bytes)	Access Time (ns)	NOVRAM Part No.	Organ.
X2804AM	512 x 8	N/A	300, 350, 450	X2210M	64 x 4
X2816AM	2048 x 8	N/A	300, 350, 450	X2212M	256 x 4
X2816BM	2048 x 8	16	250, 300	X2004M	512 x 8
X2864AM	8192 x 8	16	250, 300, 350, 450	Serial I/O Part No.	Organ.
X2864BM	8192 x 8	32	120, 150, 180	NOVRAM X2444M	16 x 16
X2864HM	8192 x 8	32	90	E ² PROM X2404M	512 x 8
X28256M	32768 x 8	64	250, 300, 350	E ² PROM X24C16M	2048 x 8
X28C256M	32768 x 8	64	250, 300, 350	E²POT™ Part No.	Max. Resis.
XM28C010M	131072 x 8	64	250, 300	X9103M	10K Ω
				X9503M	50K Ω
				X9104M	100K Ω

E²POT™ digitally controlled potentiometer is a trademark of Xicor, Inc.

Xicor®

MAKES IT MEMORABLE

Supports application interfaces for 3270/3299 & 5250 connectivity.

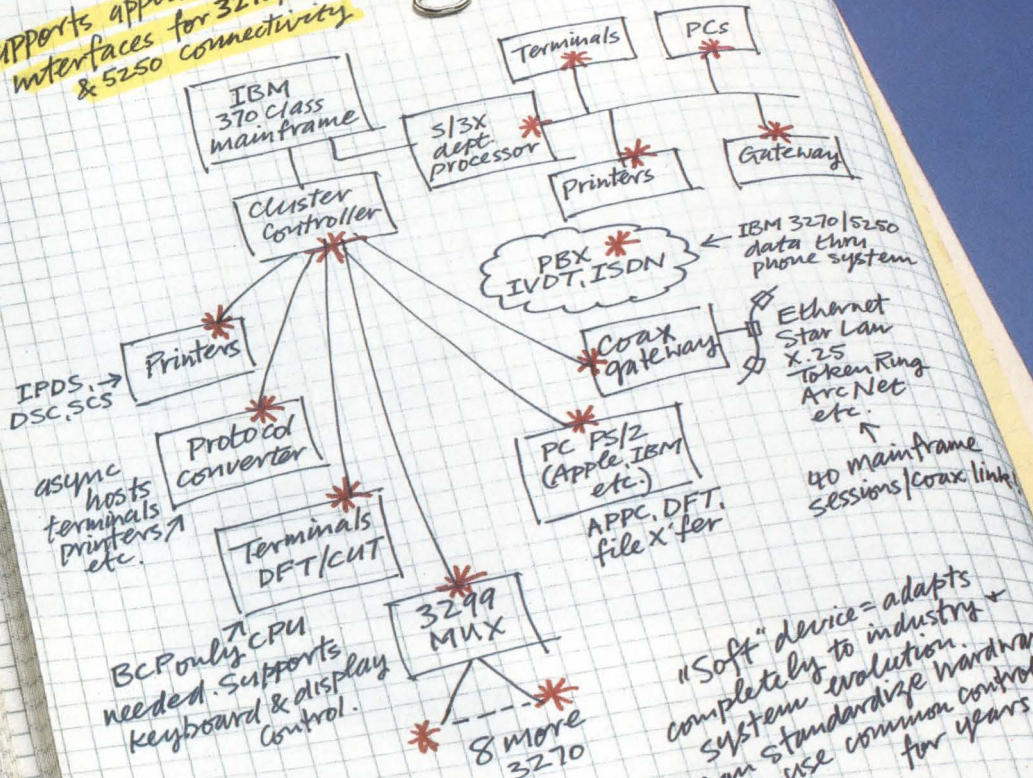

* DP8344 BCP

"Soft" device = adapts completely to industry & system evolution. Can standardize hardware & use common control code for years!

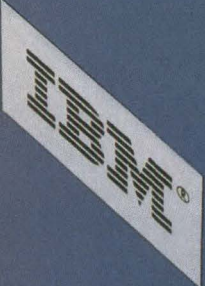

Now anyone can draw on the power of the mainframe with a single chip.

INTRODUCING THE DP8344 – THE EASY, AFFORDABLE WAY TO IBM CONNECTIVITY

At last there's a one-chip solution to processing IBM 3270, 3299 and 5250 communication protocols – the programmable DP8344 Biphase Communications Processor.

The BCP™ is easily integrated into cluster controllers, PCs, terminals and printers, so now anyone can design a plug-compatible interface for IBM mainframe and departmental processors.

You can also use the DP8344 in a PBX or to build a gateway to various local- and wide-area networks.

You can use it in a protocol converter to give inexpensive peripherals access to the power of the mainframe. Or in a PC or IBM PS/2 to provide 3270 or 5250 terminal emulation.

In fact, providing IBM connectivity is now so simple and inexpensive that a host of new applications are being developed. The BCP has been designed in by more than 100 companies – including Hewlett-Packard, Local Data, Pathway Designs, Lee Data, Centronics, and Memorex.

© 1988 National Semiconductor Corporation
BCP is a trademark of National Semiconductor Corporation.
IBM and PS/2 are registered trademarks of International Business Machines Corporation.

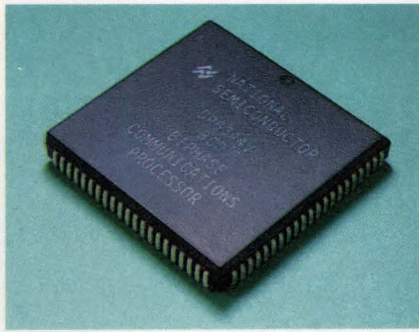

IT GIVES YOU A LOT OF POWER IN A VERY SMALL SPACE

A full system, supporting all three IBM protocols can be implemented in an area not much larger than a credit card.

The BCP integrates an intelligent transceiver and a high-performance CPU on the same low-power CMOS chip.

Powerful enough to operate as the sole system processor, the BCP also incorporates a flexible bus interface with on-chip arbitration logic, enabling communication with other processors.

With a 20-MHz, 50-nanosecond T-state processor, 30 instruction types, full-function ALU, and an instruction-cycle time ranging from 100 to 200 nanoseconds, the DP8344 supports the 3270 protocol using only 20 percent of the CPU bandwidth.

Fast and flexible interrupt and subroutine capabilities, with on-chip stacks, make the remaining bandwidth readily available for other system tasks. In fact, enough power is available to eliminate other system processors entirely.

IT COULDN'T BE MORE FLEXIBLE

The BCP features a software-configurable transceiver that supports not only IBM 3270, 3299 and 5250 protocols but also general eight-bit protocols.

A simple line interface connects the BCP to the communications line. The receiver includes an on-chip analog comparator and provides a TTL-level input for added flexibility.

WE'LL GIVE YOU ALL THE SUPPORT YOU NEED

The DP8344 is backed by a development package that includes a demo/evaluation board with a monitor/debugger program, in-system emulation features, and demonstration software for complete 3270 terminal emulation on an IBM PC.

On the system level, we offer both 3270 and 5250 controller emulators and analysis tools.

Application support is available through a worldwide network of technical support centers.

For more information on the DP8344 BCP – the easy, inexpensive way for you to provide IBM connectivity – please contact your National Sales Engineer.

Or write National Semiconductor, MS 23/200, P.O. Box 58090, Santa Clara, CA 95052-8090.

 **National Semiconductor**

Advanced
Peripherals

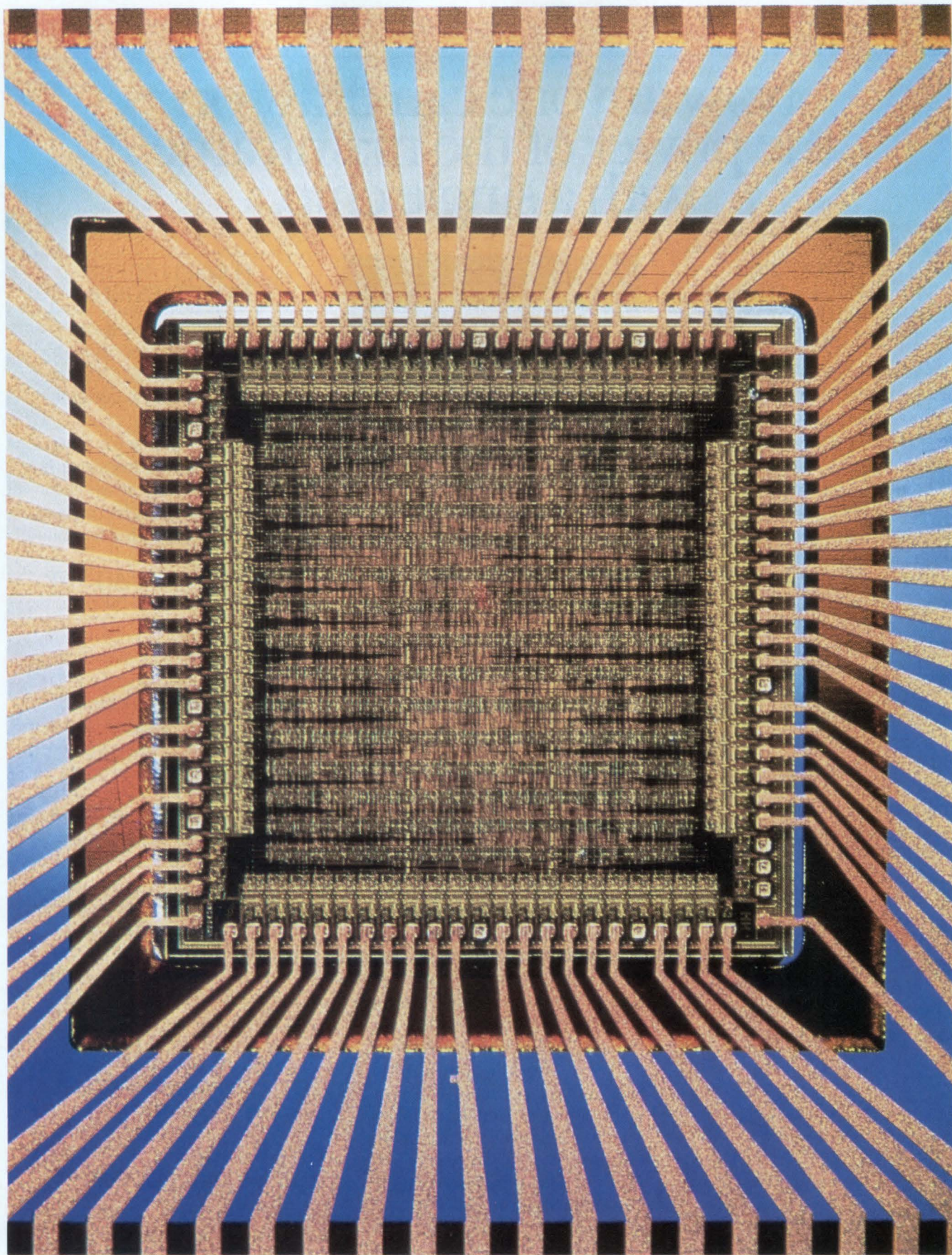

Advanced packaging will play a key role in the creation of devices and systems in the 1990s. This 84-lead IC resides in a National Semiconductor TapePak package and occupies only 0.36 in² of pc-board space. You can use conventional surface-mount techniques to attach the device to a pc board.

New package technology supports soaring IC and system complexity

The ubiquitous DIP and board-and-backplane technologies have dominated electronic packaging for the last 25 years. However, the growing sophistication of devices and systems signals the decline of such packaging schemes and heralds the arrival of more-advanced techniques for systems designed in the 1990s.

Steven H Leibson, *Regional Editor*

Customers and end users expect electronic systems to become smaller, faster, and more powerful every year; such progress is the hallmark of our industry. The relentless increases in semiconductor integration have played—and will continue to play—a large part in this process, but the next decade's system engineers will also rely on advanced packaging techniques to achieve those size, cost, and performance goals.

Although IC densities increased by six orders of magnitude over the last 25 years, packaging and interconnect technology made only modest gains during that same time. Indeed, because device and system packaging presented few problems for the simpler designs and slower signal rates of the past, packaging technology didn't receive the same attention that IC design did, so

it didn't advance in tandem with IC technology. DIPs, for example, went from 14 to only 64 leads, and most engineers continued to use fairly ancient board-and-backplane technologies when designing multicard systems.

These old packaging and interconnection schemes are limiting the speed and complexity of today's advanced systems. Emerging packaging technologies, however, promise to overcome the existing performance barriers by improving electrical characteristics and costs while shrinking board-space requirements. They simply do more with less: They carry higher-frequency signals and handle more interconnections than earlier packaging technologies did, yet use less material.

Packaging issues are now critical to advanced system design, because highly sophisticated electronic systems require increasingly complex interconnection schemes. According to Rent's Rule, an empirical model of system interconnection developed in the 1960s (**Ref 1**), as chips become more and more complex, they require more leads or pins to connect with the rest of a system. Rent's Rule emphasizes something that engineers now take for granted—that soaring IC complexities demand ever-increasing amounts of interconnection circuitry.

Packaging and interconnect lack pizzazz

Unfortunately, many of the most publicized semiconductor projects dedicated to creating these future ICs don't devote the same level of engineering effort to packaging and interconnection issues that they do to

PART FOUR
DECADE
90

**The future of
system design**

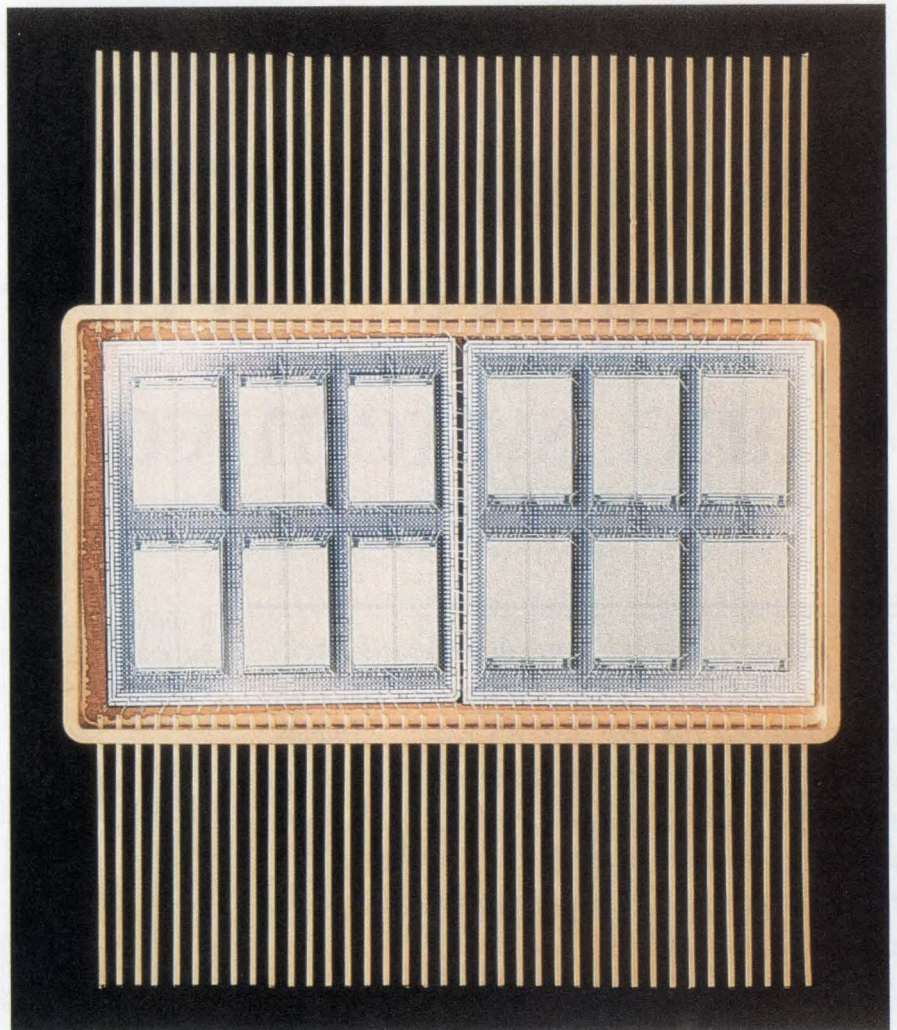

Two silicon circuit boards in a hybrid package hold twelve 32k×8-bit static RAM chips, creating a 3M-bit, 65-nsec, cache-memory module. (Photo courtesy Mosaic Systems Inc)

circuit design. According to Robert E Holmes, chief scientist for the Hybrid Components Operation at Tektronix (Beaverton, OR), major projects such as the US government's VHSIC (very-high-speed IC) and MMIC (monolithic microwave IC) programs and the Sematech consortium (in Austin, TX) put "millions of dollars into semiconductor research, but pennies into packaging." Holmes points out that companies wishing to develop new packaging technologies must conduct some basic research: They need to find new materials that solve existing power-dissipation, TCE (thermal coefficient of expansion), and interconnection problems. Funding for such research has been lacking, he says.

Though packaging may not enjoy the same amount of attention as semiconductors do, it's still making progress. For example, surface-mount technology (SMT) is

currently forcing systems vendors to revamp their manufacturing processes. SMT replaces board stuffing, which is traditionally a manual process, with very high levels of automation. SMT also effects substantial system size reductions and speed increases. The diminutive SMT packages allow system engineers to shrink existing systems or pack more capabilities into an existing box. The shorter lead lengths of these SMT packages permit faster system operating speeds because they exhibit less resistance, capacitance, and inductance. In addition, the 50-mil lead pitch of SMT packages allows for higher lead counts than conventional through-hole DIPs do.

Because SMT manufacturing represents a major departure from traditional production techniques, US companies have been slow to adopt it. According to

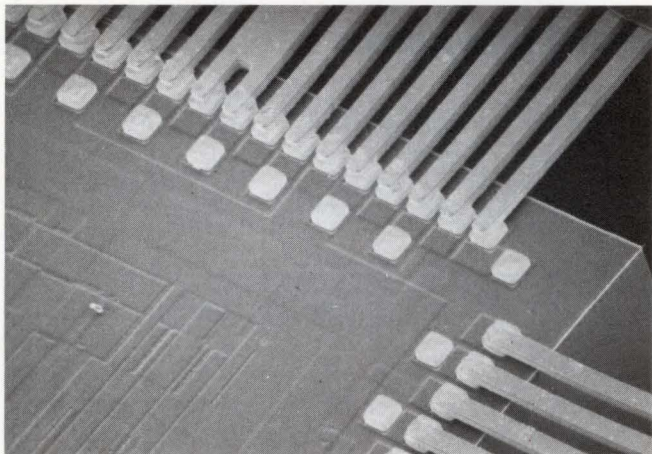

Fig 1—TAB technology allows chip vendors to bring many more signals off an IC with connections that have lower impedance, more ruggedness, and more reliability than conventional wire bonds provide. In addition, TAB can accommodate ICs with closer pad spacing than wire-bond technology allows. (Photo courtesy Motorola Inc)

Diane Taylor and Donn Fischer, authors of the book *Surface Mount Technology: A Strategic Report*, 15% of the electronic equipment built in the US during 1985 incorporated SMT. The book predicts that the figure will grow to only 30% by 1990. For Japan, however, those figures are 30% and 50%, respectively.

Several of the factors slowing the growth of SMT in the US are a general domestic shortage of SMDs, the incomplete availability of popular logic families in SMD packages, the substantial up-front capital needed for SMT manufacturing equipment, and engineers' inexperience with SMT design techniques. Despite those obstacles, the electronics industry will inevitably convert to SMT manufacturing on a worldwide basis during the 1990s, because by automating production, SMT will let companies produce higher-quality products at a lower cost.

Unfortunately, even today's SMT packages can't achieve the high lead counts forecast for the very dense chips of the 1990s. Currently, plastic leaded chip carriers (PLCCs) have no more than 124 leads, a capacity that falls far short of meeting those future needs. Some advanced ASICs available this year already require more than 500 leads. Even the pin-grid array (PGA)—an expensive and space-consuming package—can't accommodate such devices. To meet high lead-count requirements, packaging engineers are refining an existing package technology: tape-automated bonding (TAB).

Military projects have employed TAB as a high-reliability packaging scheme for more than a decade. TAB improves the reliability of an IC's interconnection by eliminating wire bonds and attaching a tape-based lead frame directly to the silicon die instead (**Fig 1**). TAB's lead frames have more strength than individually applied, gold wire bonds.

TAB has the potential to become a low-cost packaging technology because gang-bonding equipment can attach high lead-count dies to TAB lead frames much faster than a wire bonder can stitch wires between a chip and a conventional lead frame. Most current TAB packaging schemes, however, employ relatively expensive multilayer film lead frames of copper and polyimide. They also require you to use special equipment for attaching the TAB package to substrates such as pc boards. Therefore, TAB has remained primarily a military technology.

Nevertheless, National Semiconductor (Santa Clara, CA) now uses TAB to construct a low-cost, commercial IC package. The company was investigating inexpensive, reliable, multichip packaging schemes for dynamic-RAM modules and started experimenting with chip-on-board and chip-on-tape approaches to reduce board-space requirements. As a result of this project, National Semiconductor's engineers developed the

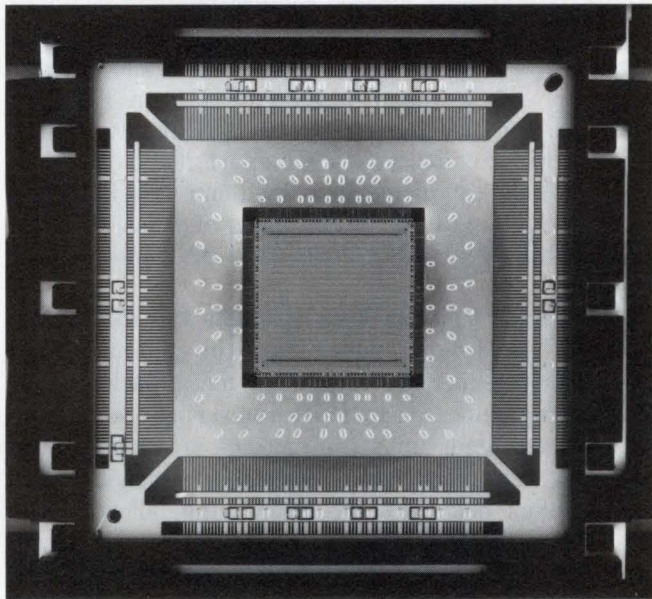

TAB packaging accommodates high lead-count devices such as this 360-lead IC. Currently, TAB handles as many as 500 leads per chip; that figure could reach 1000 during the next decade. (Photo courtesy Motorola Inc)

TABLE 1—WIRE-BOND VS TAB PACKAGING

LEAD TYPE	WIRE-BOND PACKAGING						TAB PACKAGING			
	40-LEAD DIP		44-LEAD PLCC		132-LEAD PQFP		40-LEAD TAPEPAK		132-LEAD TAPEPAK	
	LONG	SHORT	LONG	SHORT	LONG	SHORT	LONG	SHORT	LONG	SHORT
LEAD LENGTH (IN.)	0.99	0.13	0.20	0.15	0.38	0.26	0.12	0.06	0.31	0.23
RESISTANCE (mΩ)	125	123	98	98	102	101	3.6	2.2	11	8.2
INDUCTANCE (nH)	22	3.9	4.6	3.3	10	7.2	2.1	0.8	6.7	5.1
CAPACITANCE (pF)	0.68	0.12	0.12	0.16	0.21	0.15	0.04	0.02	0.11	0.08

NOTES:

PLCC=PLASTIC LEADED CHIP CARRIER
PQFP=PLASTIC QUAD FLAT PACK
INFORMATION COURTESY NATIONAL SEMICONDUCTOR

TapePak, a TAB packaging technology that combines a single-layer, all-copper lead frame with a molded plastic body and guard ring.

TAB drops lead impedances

TapePak improves connectivity to a die by doing more with less—it replaces bond wires with a short lead frame, greatly reducing lead impedances when compared with similar packages based on wire bonds (Table 1). TapePak devices require minimal pc-board space because the molded plastic body is just slightly larger than the die it encloses. National Semiconductor currently offers linear, bipolar devices in TapePak packages, and also plans to put its HPC family of μ Cs, disk-controller chips, and μ P support ICs in TapePak packages. The company has defined four TapePak body styles for ICs with 40 to 360 leads and has obtained JEDEC approval for its 40-, 52-, 68-, and 84-lead designs.

The plastic TapePak body protects the die, unlike military TAB designs, which leave the chip naked and rely on more-expensive ceramic or metal packages for physical ruggedness. TapePak's guard ring protects the IC's delicate leads until the package is attached to a substrate. The ring also delineates a region between the TapePak body and the guard ring, allowing the fine-pitched leads to fan out to test points on 50-mil centers. This feature makes TapePak compatible with existing SMD testers and handlers.

A trim-and-form tool, which attaches to standard pick-and-place machines, allows existing SMT manufacturing equipment to place TapePaks on a board along

with other SMDs. Because of TapePak's finer-pitch leads however, the pick-and-place machine must be equipped with a vision-guided placement head. Just before placement, the trim-and-form tool shears off the guard ring and test points and forms the leads into a gull-wing shape. Then the pick-and-place machine's placement head picks up the prepared device and positions it on the pc board. Standard IR or vapor-phase reflow techniques can then solder all the components, whether they're SMD or TapePak devices, simultaneously.

Even though National Semiconductor has tried to make TapePak compatible with existing SMT manufacturing processes, you must still adapt your particular processes to the new package (which you must often do when introducing new SMDs to a manufacturing line). Tom Puza, assistant superintendent of manufacturing engineering at Delco Electronics Corp (Kokomo, IN), says Delco modified all the stages of its SMT manufacturing process (solder printing, device placement, reflow soldering, and repair) to accommodate TapePak. Because of its favorable experiences with the new package, Delco has added TapePak to its package arsenal along with DIPs, 50-mil SMDs, and flip chips (dies that are directly attached to a substrate). Currently, Delco employs TapePak devices in one of its car radios and will use the packaging scheme for other automotive electronic programs in the future.

National Semiconductor is not the only semiconductor vendor that is considering TAB for commercial IC packaging. Motorola Inc (Phoenix, AZ) has licensed the TapePak technology from National Semiconductor and

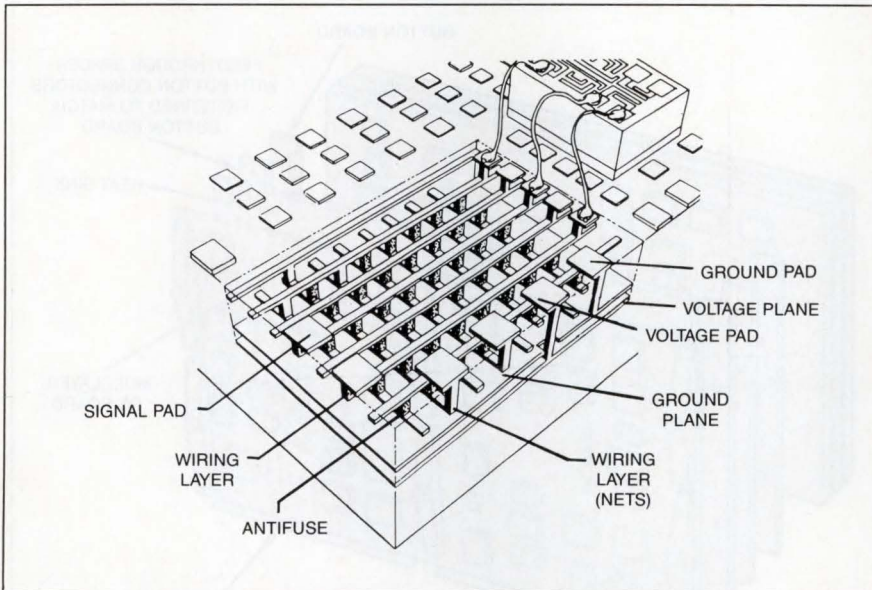

Fig 2—You can create a field-programmable hybrid circuit by using the silicon circuit board (SCB) from Mosaic Systems Inc: You bond naked IC dies to the SCB and make electrical connections to the SCB's signal, voltage, and ground pads with wire bonds. A 20V programming pulse blows an antifuse linking one trace on the SCB's upper wiring layer to a trace on the lower layer, so you can connect the ICs mounted on the SCB.

plans to develop its own family of TapePak ICs. Bud Simmons, manager of assembly concepts and methods engineering at Motorola, says that TAB technology such as TapePak can accommodate 500-lead ICs today; he predicts that the technology could be stretched to 1000-lead ICs in the future.

Multichip modules reduce interconnections

You can also use TAB to build multichip subsystems, because a multilayer TAB lead frame closely resembles a multilayer pc board and has similar capabilities for interconnecting ICs. In fact, some companies have already designed such multichip TAB assemblies for military contracts. For example, Texas Instruments (Dallas, TX) used multichip TAB technology to create a 288k-bit memory module for the VHSIC program. The module incorporates four 8k×9-bit static-memory dies. The TAB leads attached to the individual memory dies allowed the company to test each chip and its chip-to-lead interconnections before installing it in the multichip package.

Under another VHSIC contract, Honeywell (Minneapolis, MN) employed multichip TAB technology to create an 18-chip electro-optical image processor that incorporates two 8000-gate CMOS arrays, twelve 16k×4-bit static RAMs, and four glue chips. The entire processor fits into a small, 84-lead package. The company claims that its multichip TAB approach both reduced the image processor's requirement for pc-board space from 96 to 36 cm² and cut the board's power consump-

tion to a third by lowering the capacitance of the system interconnections.

Honeywell's image processor contradicts Rent's Rule by showing that, at extremely high integration levels, lead counts may not increase with increasing IC complexity. The processor's 84 leads represent a substantial reduction in system-level interconnection when compared with the total number of pads on the chips that comprise the module. You can see similar reductions in the interconnection requirements of memory modules. For example, the 1M-byte SIMM (single-inline memory module) reduces the system-level interconnection requirements of nine 20-lead 1M-bit dynamic RAMs—a total of 180 leads—to a mere 30 pins.

Other vendors are also experimenting with exotic multichip packaging schemes in an effort to reduce interconnection requirements at the board or system level. Mosaic Systems Inc (Fremont, CA) manufactures a user-programmable hybrid substrate that it calls the silicon circuit board (SCB). As with ceramic hybrid modules that have existed for decades, you mount bare silicon dies on the SCB's silicon substrate and use conventional wire bonds to wire the I/O pads from the attached dies to signal lines on the SCB. The SCB contains myriad uncommitted signal lines in a 2-layer matrix and provides a field-programmable method of linking those signal lines: To link them, you blow the amorphous-silicon antifuses that occupy most of the intersections in the signal-layer matrix (Fig 2). The company claims that the SCB, depending on its configu-

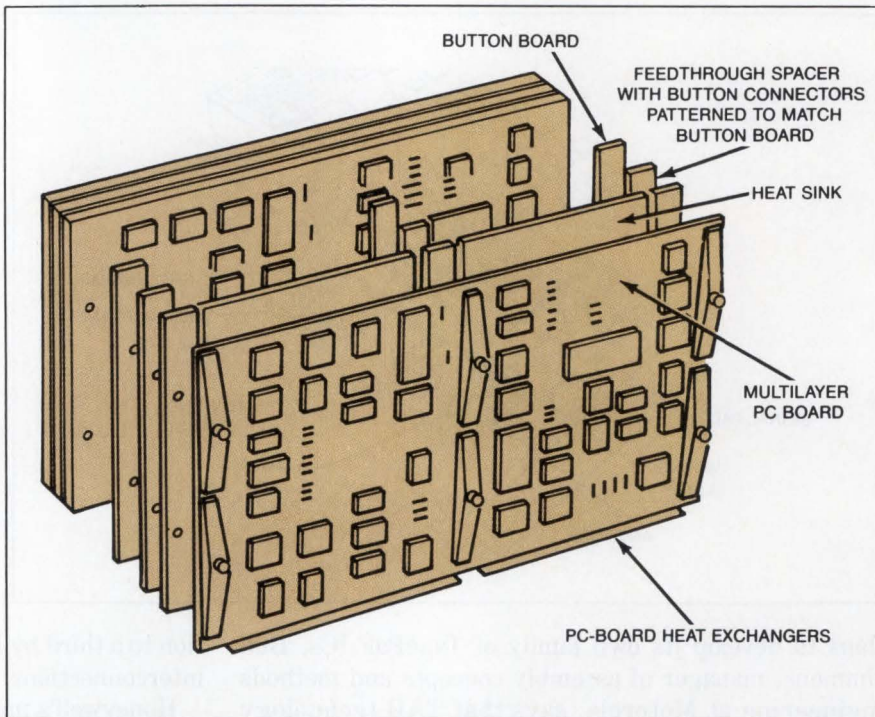

Fig 3—Systems based on the button-board scheme (which TRW developed for the VHSIC program) simply bolt together without a backplane. The button connectors provide interconnections between the system's pc boards, allowing you to place the circuit boards very close together, which minimizes signal-path lengths. (Figure courtesy TRW Quest magazine)

ration, can handle signals with frequencies as high as 200 MHz.

Although a lot of packaging research is directed at device packaging, system packaging must also advance to handle the higher signal frequencies and increased complexity of future electronic systems: Traditional board-and-backplane approaches are reaching their performance limits. Because the conventional backplane topology forces the designer to place all system interconnections at one edge of a pc board, many signals must cover unduly long paths when traveling from one board to another. Long signal paths degrade system performance because they present high capacitive loads to output drivers.

Packaging a system with buttons

New system-packaging schemes are attempting to reduce these long paths. For example, TRW's (Redondo Beach, CA) patented button-connector technology allows signals to jump from board to board at any spot, not just at an edge. The button contact is deceptively simple, resembling nothing more than a miniaturized pad of steel wool. To form a connector, buttons occupy holes etched in a button board made of Photoceram, a material made by Corning Glass (Corning, NY).

You literally bolt a button-board system together,

alternating Photoceram button boards with component-carrying circuit boards and topping the assembly off with reaction (pressure) plates (Fig 3). The buttons touch associated pads on adjacent pc boards. Button-based systems withstand shock and vibration very well because the entire assembly is under tension from the reaction plates. TRW subjected prototype button systems to 30g vibrations for 12 hours while cycling the temperature of the system and observed no connector failures.

Bob Smolley, TRW's VHSIC assistant project manager and the creator of the button connector, says he developed the buttons in response to TRW's system requirements for the VHSIC program. He says that chips operating at bus speeds exceeding 25 MHz simply can't drive the capacitance of conventional backplanes. The 3-dimensional topology of the button board greatly reduces signal-path lengths and capacitances in comparison with those of 2-dimensional backplane systems. Not only does such an approach allow for increased signal speed, but it also reduces system power requirements, because the electrical power required to drive a signal line is directly proportional to the line capacitance. Smolley says that the button connector's ability to extract a signal from any part of a pc board, not just the edge, can also reduce signal routing, which lets you

Analog CAE is More Than SPICE.

It's the ability to predict manufacturing yields, find stressed components, and pick devices from libraries containing over 1,200 simple and complex devices. It gives you software-based instruments that act just like the instruments in your lab—except they make measurements that would be impossible with normal lab equipment.

Analog CAE is now all of this, and more—thanks to the Circuit Design Tool Kit and the popular Analog Workbench™ and PC Workbench™ software. All are designed to work with a variety of CAE and CAD systems, simulators and models (including your own), and remote computers.

Why settle for SPICE alone when you can have a complete set of the most advanced design tools made today? See the latest in analog CAE for yourself: call 1-800-ANALOG-4, ask for a FREE Demo Disk or Video.

CIRCLE NO 76

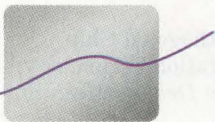

ANALOG
DESIGN
TOOLS

1080 East Arques Avenue
Sunnyvale, CA 94086
408-737-7300 or 1-800-ANALOG-4

© 1987 Analog Design Tools, Inc.
Analog Workbench and PC Workbench are
trademarks of Analog Design Tools.

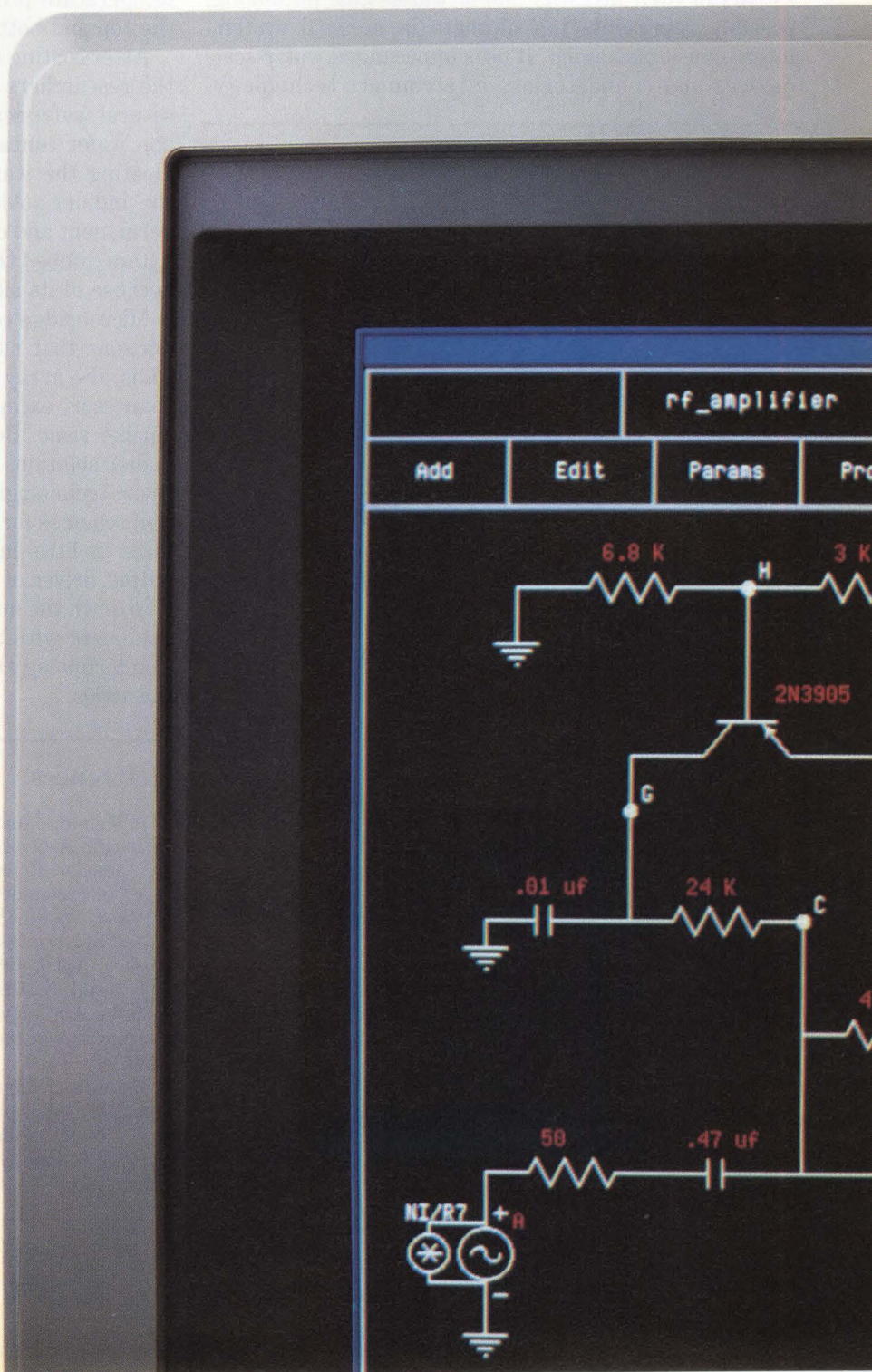
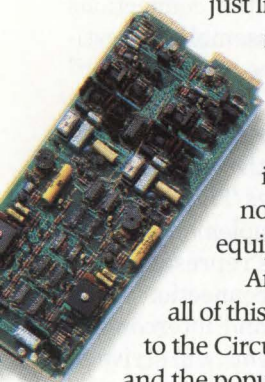

reduce board size by as much as 20%.

A 3-dimensional interconnection scheme, developed by Rome Air Development Center (at Griffiss AFB in NY) and Hughes Research Laboratories (Malibu, CA) as part of their investigation of wafer-scale packaging, possibly represents the ultimate in minimal system-interconnect packaging: It uses unpackaged wafer-scale devices and connectorless interconnect technology.

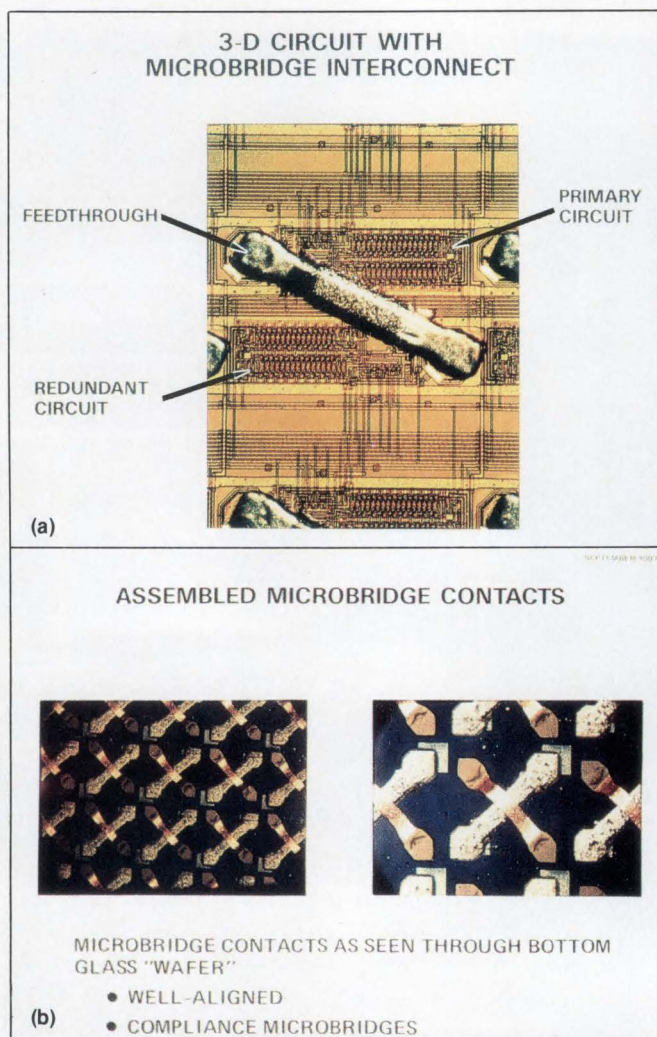

Fig 4—Indium-coated microbridge contacts formed on both sides of a wafer-scale device (a) allowed Rome Air Development Center and Hughes Research Laboratories to build a system by stacking several wafers. The contacts on top and bottom are orthogonal, so contacts on one wafer touch contacts on the adjacent wafer at only one point (b). Applying compression to the stack slightly deflects the microbridge contacts, creating a high normal force and ensuring good physical contact during reflow soldering. After it's cooled, the soldered stack forms a complete, 3-dimensional computer system, dubbed "the coffee-can computer."

Using this approach, engineers plate microbridge contacts on both the top and the bottom of each wafer-scale device (Fig 4). Feedthroughs, formed in the wafers by dissolving aluminum through the silicon with a high-temperature process, link the microbridge contacts on the top and bottom of a wafer.

After coating these microbridges with indium solder, the researchers created a finished system by stacking several wafer-scale devices so that the microbridges of one wafer contacted microbridges of abutting wafers. Heating the wafer stack while compressing it caused the indium solder to reflow, making the connections permanent and creating a completed assembly. Investigators dubbed this structure "the coffee-can computer" because of its size and configuration.

Microbridge connections create an array of interconnections that run vertically through the wafer stack. Thus, the array topologically resembles TRW's button connector, except that the array is implemented on a smaller scale. Both of these techniques represent minimalist solutions to system-level interconnection. Like these technologies, future packaging and interconnection schemes for both devices and systems will strive to place as little interconnection as possible between the output driver of one IC and the input buffer of the next chip down the line. Such approaches will provide design engineers with the dense, high-speed signal-transmission technology they'll need to build complex systems in the 1990s.

EDN

References

1. Meindl, James D, "Chips for Advanced Computing," *Scientific American*, October, 1987, pg 78.
2. Jensen, Ronald J, "Copper/Polyimide Thin Film Multi-layer Interconnections for High Performance Packaging," *Proceedings of ASM's Third Conference on Electronic Packaging: Materials and Processes & Corrosion in Microelectronics*, April, 1987, pg 25.
3. Malhi, S D S, H E Davis, et al, "Orthogonal Chip Mount—A 3D Hybrid Wafer Scale Integration Technology," *Proceedings of the International Electron Devices Meeting*, 1987, pg 104.
4. Ormond, Tom, "Materials and hardware," *EDN*, February 18, 1988, pg 148.
5. Taylor, Diane and Donn Fisher, *Surface Mount Technology: A Strategic Report*, Electronic Trend Publications, Cupertino, CA, 1986.

Article Interest Quotient (Circle One)
High 497 Medium 498 Low 499

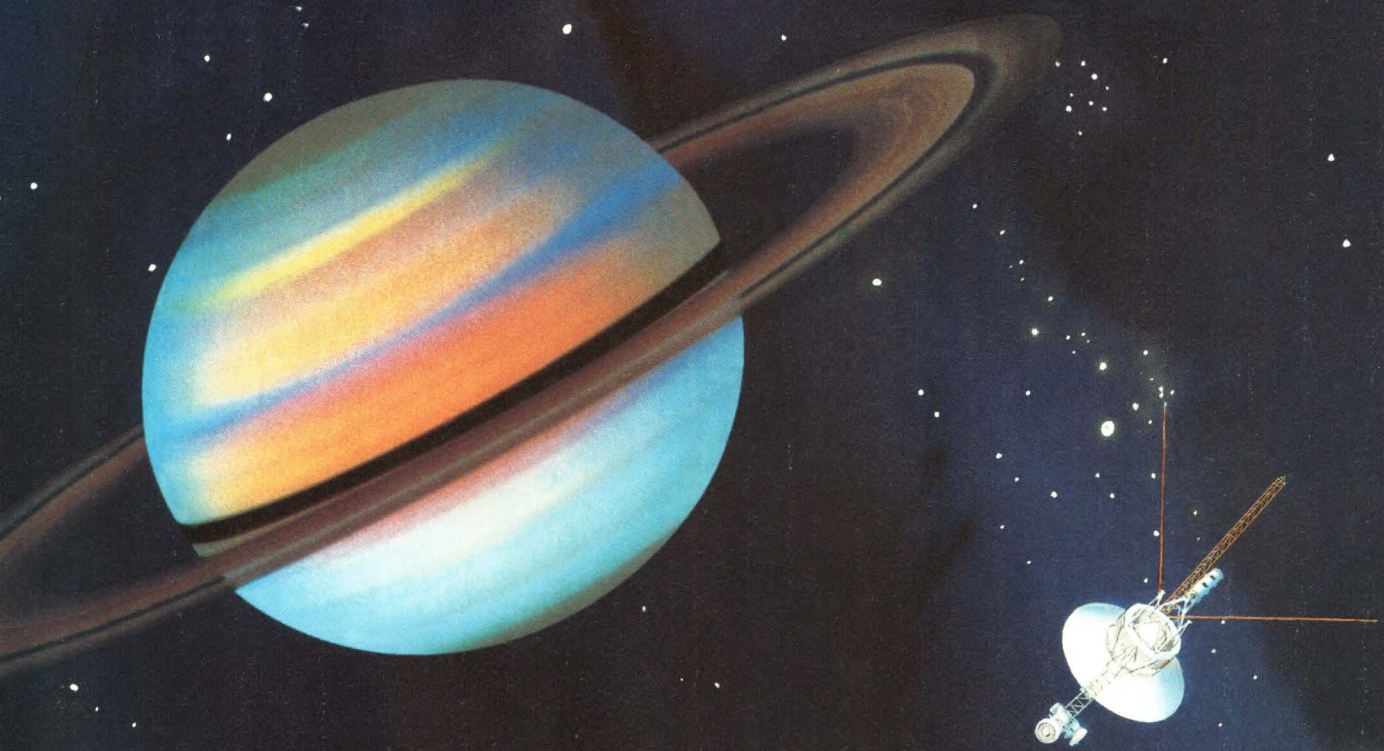

**4,000,000,000
miles from Earth,
and still
on the job.**

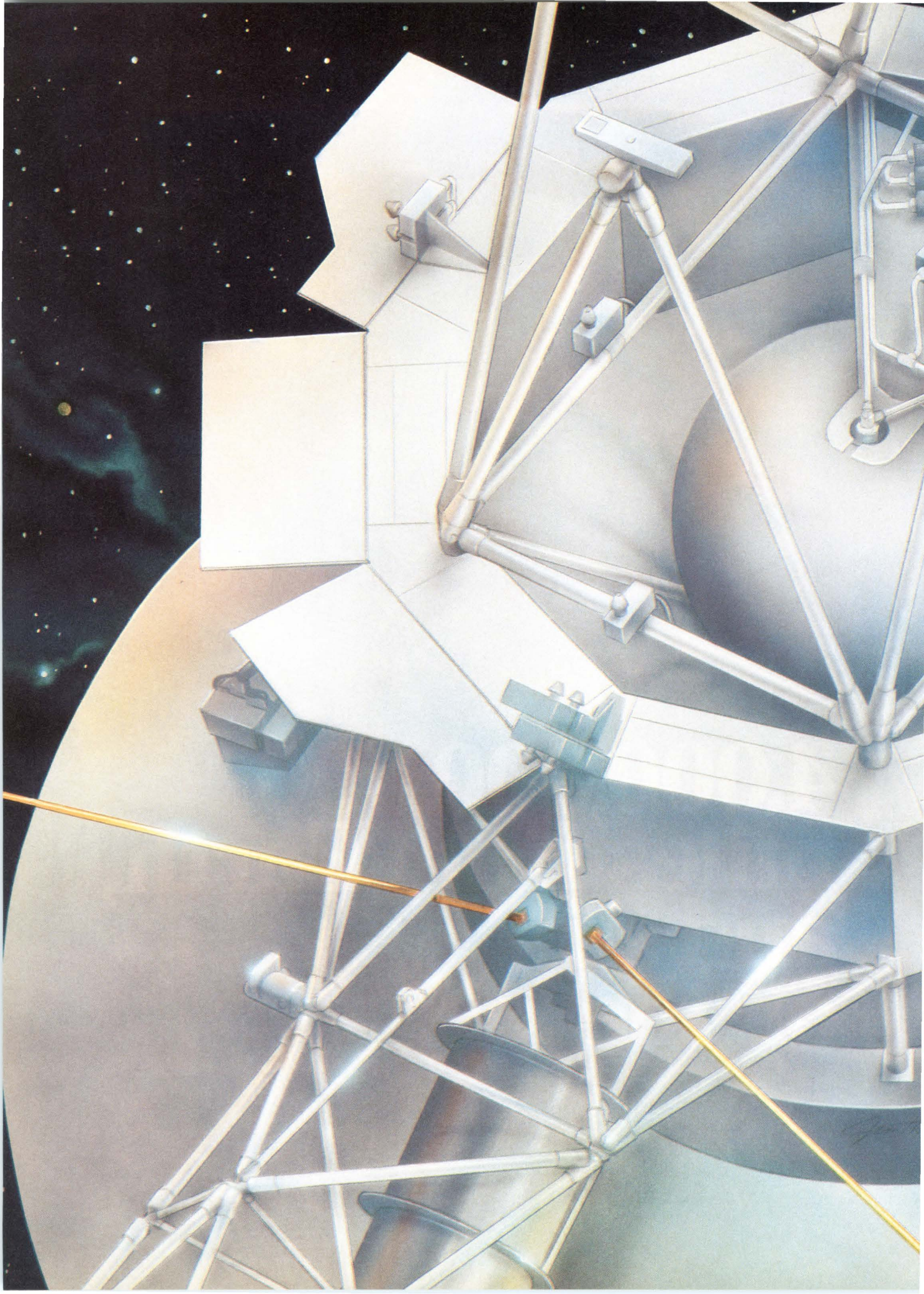



Our ICs have tackled tough jobs for over two decades.

Voyager 1 and 2. The most successful electronic systems ever to leave the Earth — and Harris ICs play an integral role.

Even before these spacecraft passed Saturn in 1980 and 1981, their accomplishments were impressive:

- Discovering the ring system surrounding Jupiter
- Logging the existence of volcanoes on the Jupiter moon Io
- Photographing Saturn's complex ring system
- Recording the many moonlets that surround Saturn

Just last year, Voyager 2 surveyed Uranus and discovered 10 new moons orbiting in its system. Ahead lies an encounter with Neptune in 1989. Beyond that, Voyager 2 will leave the solar system and journey the dark oceans of space, perhaps to meet another solar system, perhaps other beings.

Our bet is that whatever it encounters, Voyager 2 will still be functioning — still taking pictures and sending back data.

For 20 years, our commitment to developing, manufacturing and delivering the best ICs in the business has earned us a place in the highest-reliability space programs:

- **GOES:** HM-65162 16K RAM
- **Voyager 1 and 2:** HA-2500 and HA-2600 op amps
- **Viking 1 and 2:** HA-2520 and HA-2600 op amps
- **IUS:** HI-562A converters; HI-507A multiplexers
- **Magellan:** HM-6516 RAMs
- **Intelsat:** HA-2700 op amps
- **Mariner, Skylab, Shuttle** and nearly 100 similar programs.

To those who dreamed of exploring space and to those who achieved it: we salute you and look forward to teaming up with you in the future.

Discover more. In U.S. phone 1-800-4-HARRIS, Ext. 1800 for info and samples. In Canada, 1-800-344-2444, Ext. 1800.

IN SPACE-READY ICs,
THE NAME IS
HARRIS

Harris Semiconductor: Analog - CMOS Digital
Gallium Arsenide - Semicustom - Custom



©1987, Harris Corporation

CIRCLE NO 78

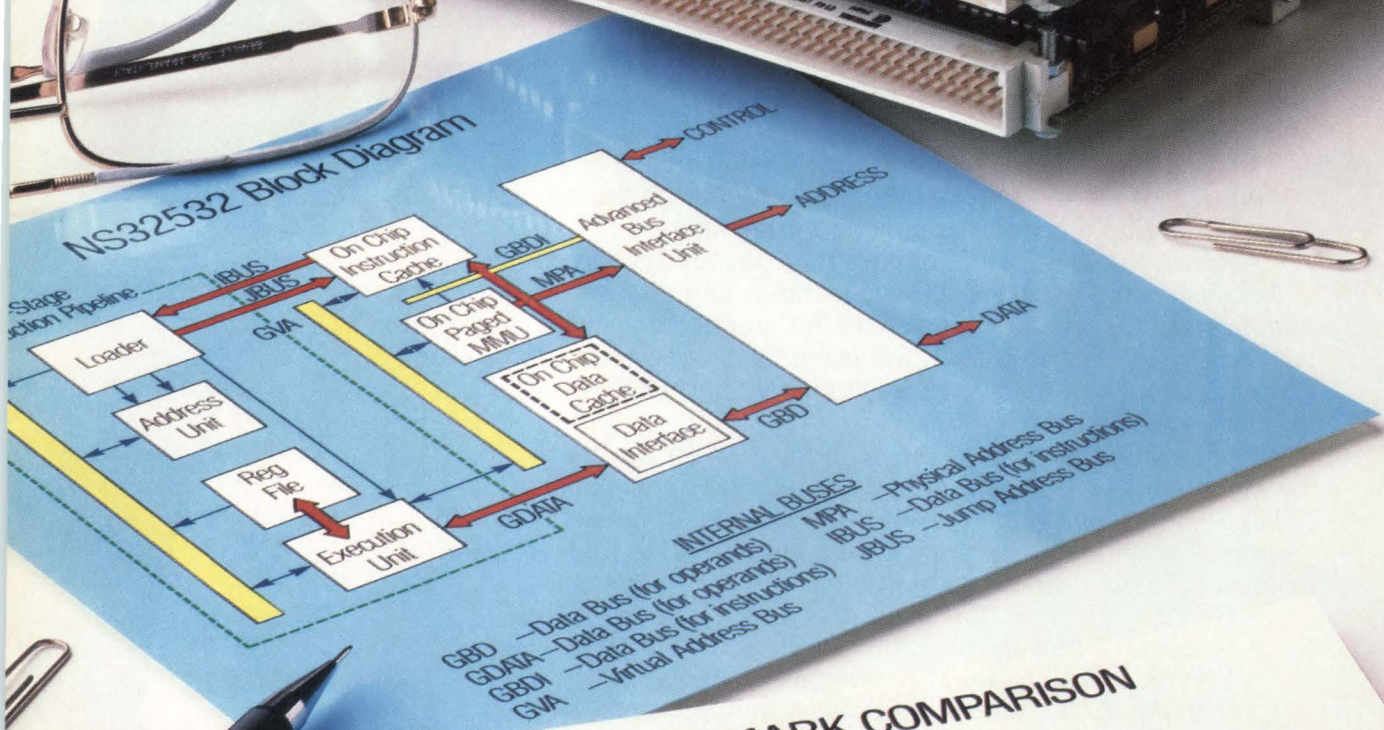
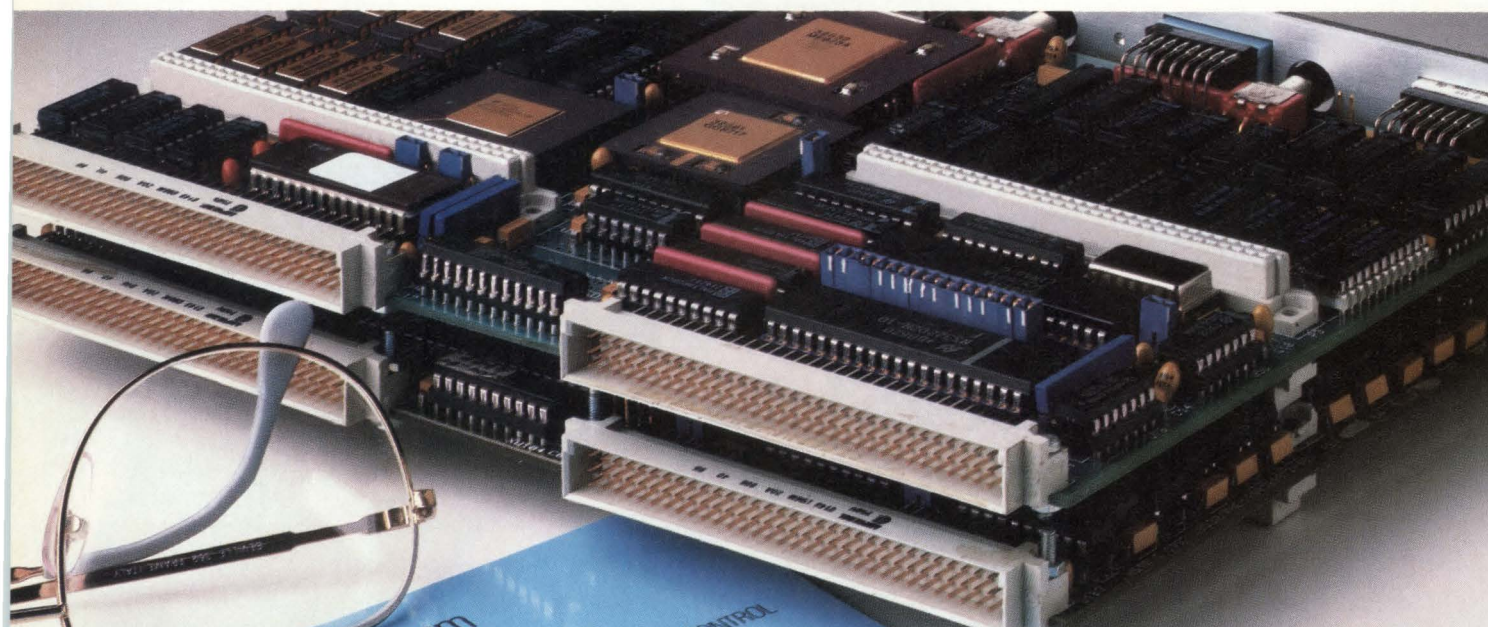

DHRYSTONE BENCHMARK COMPARISON

Dhrystone Version 1.1

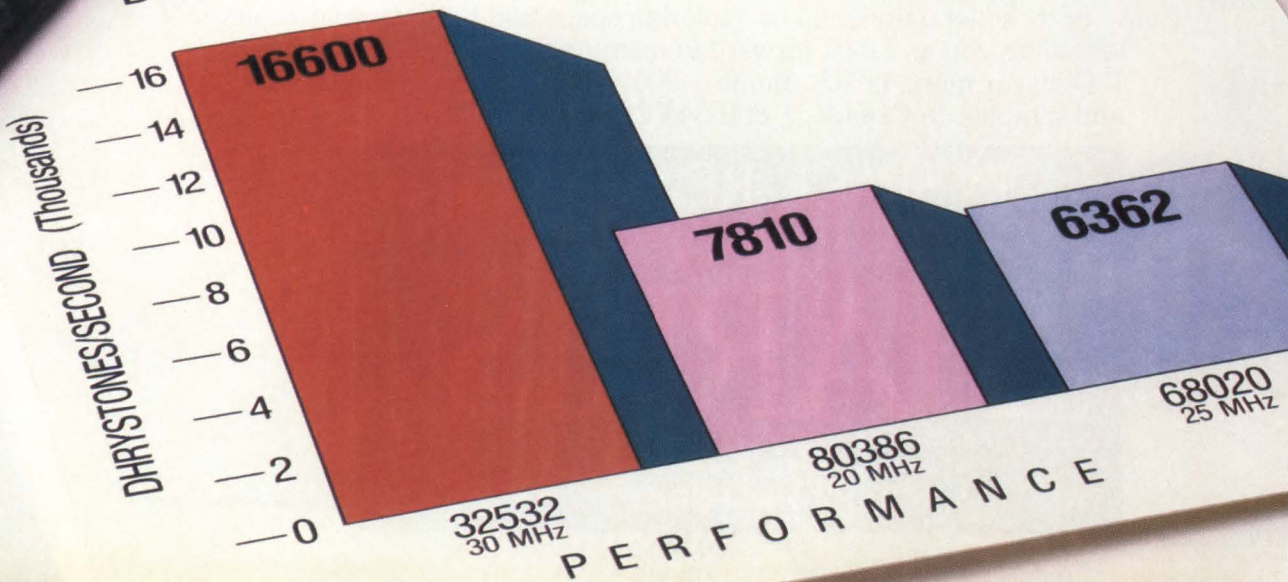

The NS32532: Real-world performance for real-world applications.

NS32532 SEMINARS
Discover 32-BIT technology solutions
featuring the NS32532!
For dates and locations, call
1-800-227-6058

At National, we believe that a high-performance 32-bit microprocessor should be worked with, not around.

That's why the NS32532 offers you some of the highest performance specs in the industry.

Yet it's performance you can use. Because the NS32532 was created for real-world designers working on real-world systems to meet real-world needs.

PERFORMANCE YOU CAN COUNT ON

The NS32532 is capable of delivering 15 MIPS peak performance, 8-10 MIPS sustained, at 30 MHz.

Not "no-ops" MIPS. Not benchmarking MIPS. Not RISC MIPS. But genuine VAX® 11/780 MIPS.

You're looking at 16,600 Dhrystones per second.

Not to mention high integer performance and high floating-point performance. With a range of FPU solutions that deliver up to 8 million double-precision Whetstones per second.

Below: NS32532 chip

*Left: VME532 evaluation board; NS32532 block diagram; competitive performance comparison**

* Sources:
NS32532 — August 1987 Performance Evaluation Tests
80386 — "The 80386: A High-Performance Workstation
Microprocessor," Intel Corp., June 1, 1986

68020 — SUN 3/20 @ 25 MHz, as published
by Sun Microsystems



The NS32532

- 8-10 MIPS sustained, 15 MIPS peak
- 20-, 25-, and 30-MHz devices
- On-chip 1,024-byte 2-way set associative physical data cache
- On-chip 512-byte direct mapped physical instruction cache
- Hardware cache invalidate for high-performance cache coherency
- On-chip demand-paged memory management including 64-entry fully associative Translation Lookaside Buffer
- 4-stage instruction pipeline including instruction prefetch and branch prediction
- 2-clock basic READ/WRITE cycle
- 1-clock burst-mode transfers
- Unique bit-manipulation and string-handling instructions
- Highly symmetrical and orthogonal instruction set producing compact code
- Extremely fast context switch (3.6 μ s) and interrupt service (1.3 μ s)
- Fabricated in M²CMOS
- 370,000 transistor sites
- SAMPLES AVAILABLE NOW

SUPER-MINI PERFORMANCE ON A CHIP

The NS32532 achieves its superior performance because it integrates key systems functions on a single piece of silicon.

Only the NS32532 incorporates on-chip data and instruction caches, demand-paged virtual memory management, and a 4-stage instruction pipeline. With instruction prefetches and branch prediction. Plus a hardware cache invalidate mechanism that ensures cache coherency.

Series 32000 is a registered trademark of National Semiconductor Corp.
VAX is a registered trademark of Digital Equipment Corp.
UNIX is a registered trademark of AT&T Bell Labs
VRTX is a registered trademark of Hunter & Ready Corp.
© 1987 National Semiconductor Corp.

SCALABLE PERFORMANCE

The NS32532 is one of seven CPUs based on the same 32-bit architecture. With the same orthogonal, highly symmetrical instruction set.

Which means you can migrate your design throughout the entire performance range without having to re-engineer your software at any level. And you can build consistently competitive systems without resorting to some "more innovative" architecture that leaves you and your software investment in the lurch.

PERFORMANCE THAT'S READY FOR YOU TODAY

We've already begun sampling silicon. We've already ported UNIX® System V.3 and VRTX®. And we've already produced a board-level implementation — a fully integrated, fully populated, plug-and-go VME-compatible native environment... available now for evaluation. So are nearly 150 other members of the Series 32000® family, including coprocessors, peripherals, development tools and optimizing compilers.

To talk about putting our performance into practice in your application, call our Application Engineers toll free: 800/538-1866, ext. 532 or 800/672-1811, ext. 532 (within California).

 **National
Semiconductor**

Tin or select gold

Standard or low-profile versions

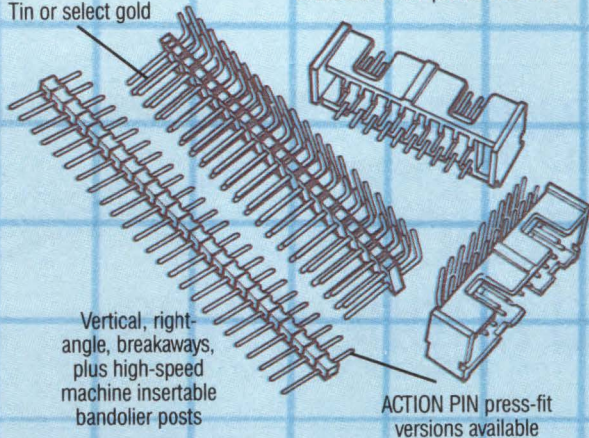

Beryllium-copper or phosphor bronze, depending on required tensile properties

Anti-overstress stops

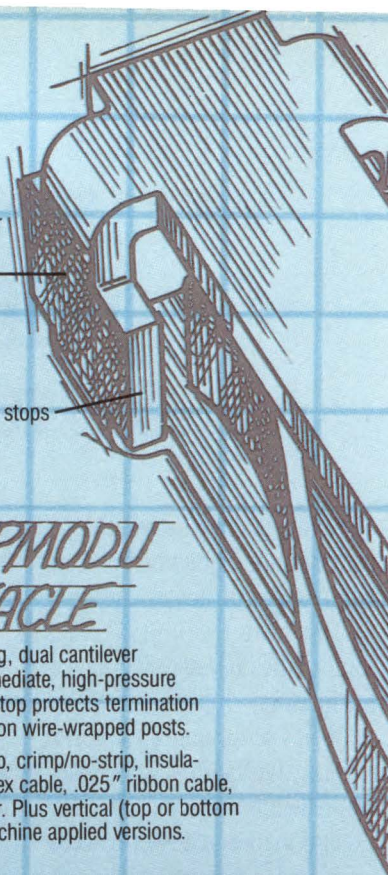

POSTS, HEADERS & RECEPTACLES

Posts .025" square or round, range of materials, platings. Headers and housings 94V-0 material, with board standoffs. Shielded versions for our Shielded MT series. Complete selection on .100" x .100" or .050" x .100" centers.

THE AMPMODU RECEPTACLE

Rigid rectangular housing, dual cantilever beams. Standard, intermediate, high-pressure versions available. Post stop protects termination and limits mating depth on wire-wrapped posts.

Termination styles: crimp, crimp/no-strip, insulation displacement, flat flex cable, .025" ribbon cable, solder tab, card extender. Plus vertical (top or bottom entry) and horizontal machine applied versions.

Vertical board-mount receptacles in top or bottom entry styles, single and double row, in .265", .340", and .700" profile versions. Low profile versions are end stackable.

Horizontal receptacles in single and double row versions, in a variety of styles.

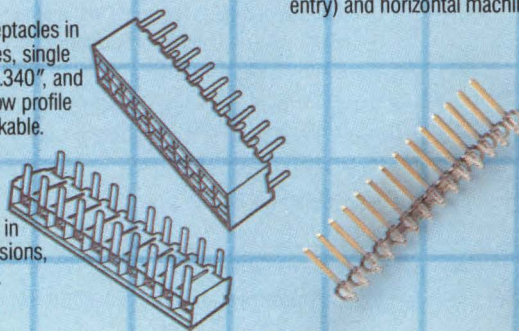

The system,

This is the heart of the system: the AMPMODU receptacle.

Simple. Reliable. And for 20 years the foundation of the world's most popular interconnection family.

But to keep our AMPMODU family popular, another kind of system is required—one that responds to

people, and meets such needs as product availability, or the simple desire for more information.

Test our reflexes.

Our real job is to be the kind of company you want to do business with.

So we take availability seriously, and make AMP products available the way *you* need them. From worldwide manufacturing and stocking to our nationwide network of AMP Autho-

rized Distributors, we offer the source that suits you.

You sometimes need parts in a rush. We've done something about that, too. We've taken our popular industry standard products—including modular AMPMODU connectors—and stocked up, nationwide.

Your Immediate Shipment Catalog is ready.

For thousands of products from switches to sockets, terminals to coax, and more, our Industry Standard Products Catalog is almost as good

Plating selection includes 15 or 30 microinches of gold in contact area

Mass termination of preloaded contacts reduces error, speeds production

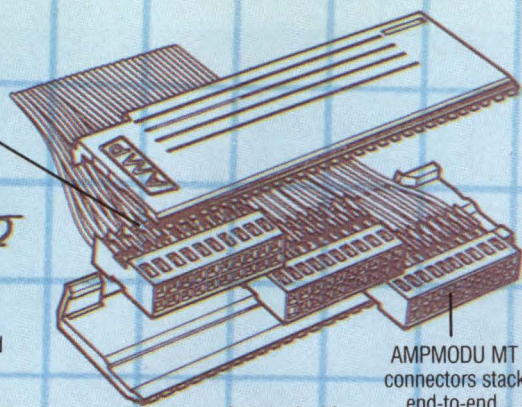

AMPMODU MT connectors stack end-to-end, lock together with shallow covers

WIRE-TO-BOARD

AMPMODU MOD IV, MT, Shielded MT, MTE, and System 50 connector series all offer wire-to-board applications, and cover discrete wire, ribbon cable, jacketed cable, FFC, .025" ribbon. Centerlines: .050", .100", .125", .150" Shielded receptacles and RF gasketed headers block RFI.

Polarized and latching versions available

Discrete wire, jacketed cable, bonded ribbon cable

Redundant contact.

Wide entry, wide misalignment tolerance

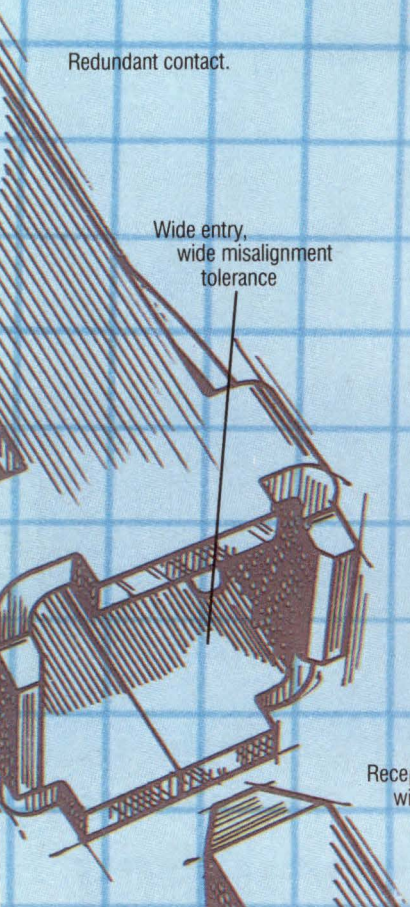

WIRE-TO-WIRE

The AMPMODU MTE Interconnection System provides modular wire-to-board and wire-to-wire capability. Receptacle and pin contacts use redundant insulation displacement termination. Assemblies gang into shrouds with polarization, latching, and panel mount features.

Receptacle half mates with AMPMODU headers

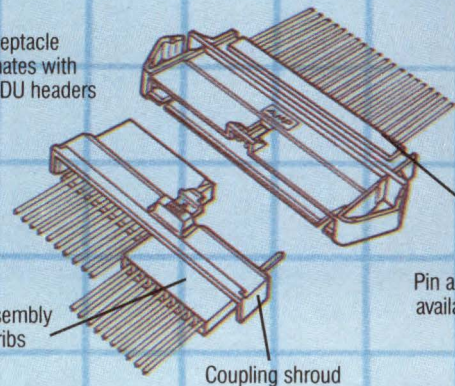

Preloaded contacts simplify termination

Receptacle assembly with guide ribs

Coupling shroud

Pin and receptacle assemblies available with polarization and latching features

exposed.

as a warehouse around the corner. And you can get your copy just by calling our Information Center and asking for it.

One number to call.

We've consolidated our information systems into a single toll-free number, with hours to cover the business day, coast to coast.

Call us. We can supply product literature. Answer technical questions about any of our catalog products. Guide you to the closest AMP Authorized Distributor.

Any question we can't answer, any problem we can't solve on the spot, will get priority attention. It doesn't matter if your concern is a big one or a little one. Your business matters to us.

For the name and location of your nearest AMP Authorized Distributor, call the toll-free number.

We want to be your supplier.

AMP Interconnecting ideas

1-800-522-6752



We've been delivering high accuracy multifunction calibrators for 2 years ... others are still making promises!

While others have been promising, we've been delivering. While others have been dealing in 'futures', we've been providing solutions.

The Datron Instruments 4700 series of high accuracy multifunction calibrators is a reality and can give your laboratory these levels of performance now, with no delivery hassle:

DCV - 10nV to 1kV, 90 day accuracy to 2.5ppm.

ACV - 100nV to 1kV, 10Hz to 1MHz, 90 day accuracy to 80ppm.

Integral 1kV range to 33kHz — no need for an add-on unit to get a usable 1kV range!

Autocal — traceable electronic calibration.

Plus — Resistance, DCI and ACI Functions with IEEE-488.

And those are just the specifications for the 4707 Multifunction Standard. The versatile 4700 and 4705 models also provide superior value and performance levels specifically suited to your application needs.

Remember, you can't calibrate with a promise.

For more information or to arrange a real-time demo or evaluation of a real calibrator contact:

United States:

San Diego, Cal. (619) 565-9234

Clearwater, Fl. (813) 797-1792

Beech Grove, Ind. (317) 787-3915

Suffern, N.Y. (914) 357-5544

United Kingdom:

Norwich (0603) 404824

See us at Electro Booth Nos. 322 and 324

CIRCLE NO 164



High-resolution LCD panels change demands on driver electronics

Today's LCD technology places new requirements on driver electronics—higher speed, more outputs, higher driving voltage, and lower power consumption. IC manufacturers are meeting these demands with devices that bring flat-panel LCDs one step closer to CRT performance.

Carl Fenger and Kurt Muhlemann,
Philips/Faselec

The resolution, response-time, size, and viewing-angle limitations inherent in LCD technology have made it difficult for flat-panel-display manufacturers to seriously challenge the CRT applications base. Now, however, super-twisted nematic (STN) LCD technology is overcoming these performance limitations. The new technology is changing the demands on driver electronics, but driver-IC manufacturers are keeping pace with the progress in LCDs, and the IC vendors' offerings can help you economically integrate LCD panels into your designs.

A way to increase refresh rates

Until recently, most LCDs employed a 90°-twist (twisted-nematic, or TN) technology (see **box**, "A review of LCD technology"). In flat-panel applications, you address a dot matrix of LCD pixels in a row-and-column fashion. An activation voltage scans the rows

sequentially while pixel information is applied to the column drivers. At any given time, a pixel should be in either an optical on or off state.

Optimally, the LCD molecules should be in a fully twisted state when not subjected to an electric field and fully aligned when the field is present. These fully twisted and aligned states are easy to achieve for small displays, for which you can use direct-drive techniques.

Drive schemes for large displays, however, typically apply a time-multiplexed voltage waveform to activate (or deactivate) a pixel once every picture frame. Because a typical TN LCD has a relatively gradual voltage-transition region between its on and off states, the time-multiplexed drive voltage has an rms value that's not as low as the level required for full twist of the molecules but that's not as high as the level needed for full molecule alignment. The resulting intermediate states that the LCD assumes cause pixels to appear dark as the viewing angle increases. Therefore, conventional TN displays typically allow no more than 1:100 multiplexing and limit contrast ratio to 3:1 over a 15° viewing angle.

STN technology yields twist angles greater than 90° and provides a better solution for high-information-density LCDs. Most major LCD manufacturers are now developing this STN technology. With the increased twist angle, the overall liquid-crystal structure assumes a more unstable configuration—the minimum on-voltage and maximum off-voltage levels are extremely close. With a more sharply defined on/off boundary, it's possible to increase multiplex rates without degrading contrast ratio and viewing angle.

Fig 1 illustrates voltage/contrast curves for TN- and

A typical TN LCD has a relatively gradual voltage-transition region between its on and off states, which causes pixels to appear dark as the viewing angle increases.

STN-type LCDs. Curve steepness increases with increasing twist angles until it reaches a critical point at about 270° , where it has a maximum slope. At this critical point, a small change in the value of rms driving voltage produces the largest change in the tilt angle of the LCD molecules and thereby significantly changes display brightness.

Manufacturers can optimize this super-twist LCD even further by introducing active materials that ensure that the crystal has a homogeneous response. They can also introduce a pre-tilt angle to enhance the display response. This latter feature causes the super-twisted LCD to operate in a super-twisted birefringence-effect (SBE) mode that provides optimum performance when the front and rear polarizers are offset approximately 30° and 60° , respectively, from the on-axis position.

STN-type devices with twist angles of 180° to 270° (SBE) are available today for applications that require high contrast and wide viewing angles. High-performance super-twist LCDs can produce a good 7:1 contrast ratio over a 45° viewing cone. And if you operate the displays in the transmissive mode, you can use STN-type panels for high-quality computer projection. In such applications, you can operate a reflectorless LCD as an overhead projector by using a strong back light, focusing lens, and screen.

Drive electronics need to change

On the flip side, STN LCD technology places new requirements on the drive electronics. Higher-resolution displays and increased multiplex rates mandate the

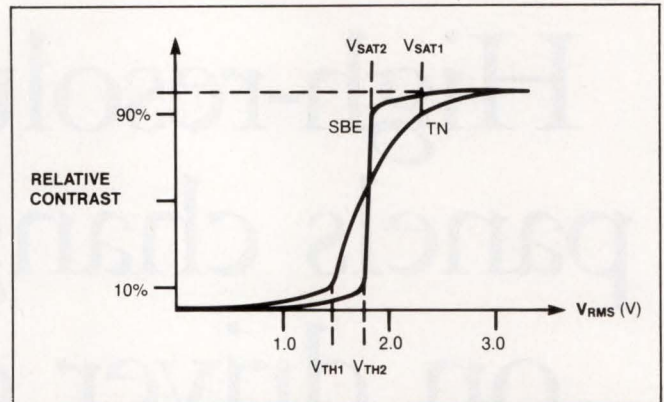

Fig 1—Because STN-type LCDs have a sharply defined on/off voltage boundary, a small change in the value of rms driving voltage produces a large change in the display's relative contrast.

need for higher drive voltages and geometrically higher data-transfer rates. In addition, there's a relationship between multiplexing-signal drive voltage and the multiplexing rate. Fortunately, some of today's driver ICs, like the PCF 2201, let you take full advantage of STN technology. A row or column driver specifically designed for flat-panel STN LCD applications, the PCF 2201, can typically operate in systems with multiplexing rates ranging from 1:32 to 1:256.

A typical flat-panel LCD system contains an LCD dot matrix of 640 columns by 400 rows divided into two half screens of 640×200 pixels (Fig 2). The top and bottom column drivers control display data on the corresponding half screens. The row drivers provide the periodic strobe signals. These signals scan through each half-screen in conjunction with the multiplexed data gener-

Solving interconnect-density problems

As Fig 2 on pg 160 illustrates, flat-panel LCD modules require a very large number of interconnections from IC to glass. Every row and column driver requires 80 connections to the display. To ensure cost-effectiveness, the interconnection process must be automated. Tape automated bonding (TAB)—a packaging scheme developed for surface-mounting applications—helps satisfy this requirement.

In the TAB scheme, small bumps of gold are galvanically grown on the bonding pads of the IC die. These bumps are then bonded to the inner leads on a 3-layer, 35-mm tape that consists of a polyimide base, adhesive, and conducting layers. These inner leads continue in a single plane to outer-lead connections.

TAB reliably satisfies low-profile, high-interconnect-density

applications. The process provides high bond strength, sealed bonding pads, and flexible interconnections that maximize resistance to vibration, contamination, and thermal mismatch. In addition, TAB minimizes pad-to-pad space requirements—an aspect that is particularly attractive for high pin-count devices such as flat-panel drivers.

A review of LCD technology

LCD technology uses a class of organic materials whose optical properties change in the presence of an electric field. These materials are called nematic liquid crystals because their rod-shaped molecules, while grouped in an ordered structure, have a liquid-like freedom of movement.

A typical LCD consists of a layer of liquid-crystal material sandwiched between two glass plates. The inside surfaces of the glass are treated so as to induce the rod-shaped molecules in the liquid-crystal material to line up horizontally in a crystalline structure. The overall shape of the liquid crystal is a helix structure twisting between one glass plate and the other. The molecules meeting the glass surface determine the angle of twist—a parameter that has a critical effect on display performance.

This liquid-crystal helix can rotate the polarization plane of

light passing through it by an amount equal to the degree of twist. For a 90° twist, light entering the structure leaves with its polarization plane rotated 90°. You can break this structure down by introducing an electric field perpendicular to the glass. Such a field overrides the tendency of the molecules to form a helix; the molecules rotate to a vertically aligned position and lose their optical-modification properties. Light now passes through with the polarization unchanged. When you remove the field, the molecules return to their helical structure.

LCDs can operate in several modes. With two light-polarizing filters (90° out of phase) glued on the face and rear glass plates of the assembly, the LCD operates in either a light-absorbing or light-reflecting mode, depending on the absence or presence of an applied electric field.

In one scheme, light enters the face polarizer, and one component is filtered immediately. With no electric field present, the remaining component of polarized light rotates by 90°. The modified light component passes through the rear polarizer, reflects, and passes back out of the display in the reverse process—the display appears light.

Apply an electric field and the display operates in a light-absorbing mode. As before, the face polarizer immediately removes a component from incident light. This time, however, the liquid-crystal molecules are no longer in their helical structure, and light passes through with no polarization modification. Without this added twist, the rear polarizer absorbs the remaining, impinging light component, and the display appears dark.

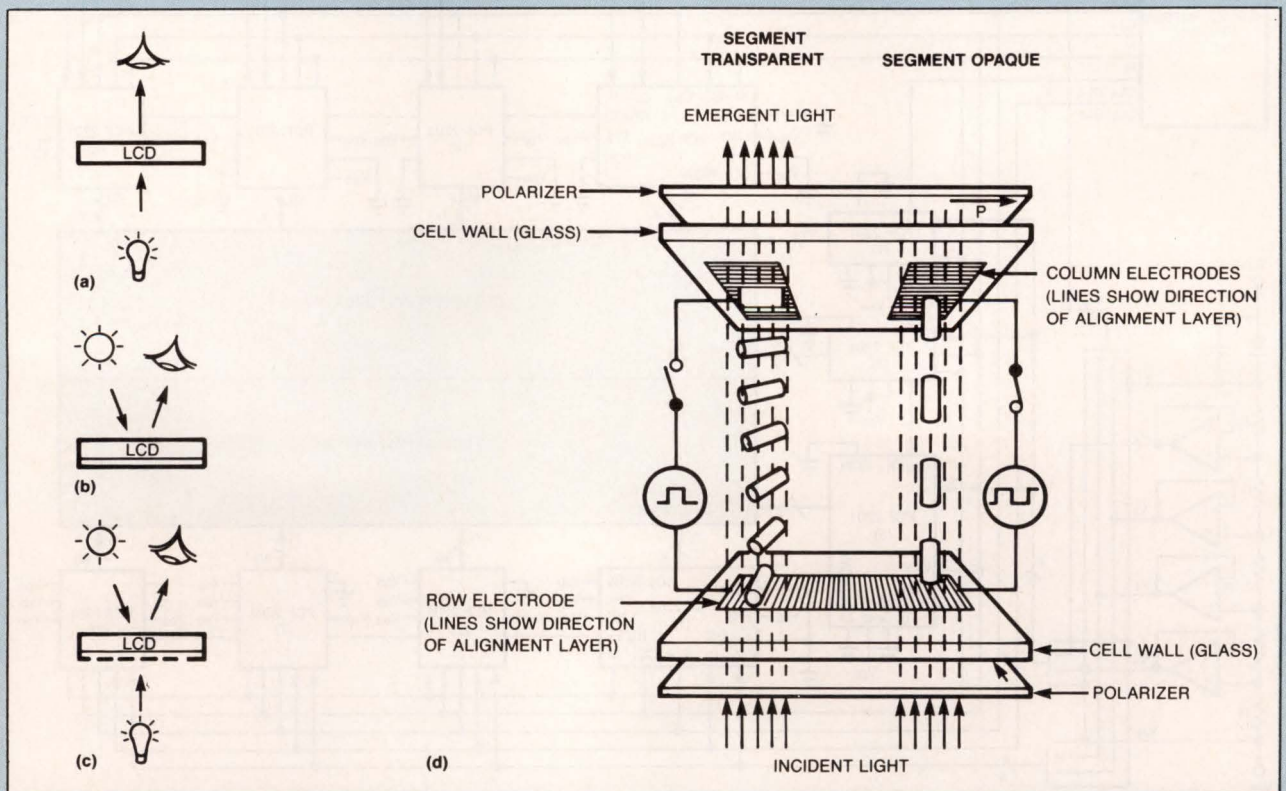

LCDs can operate in a transmissive mode (a), which requires a back light, in a reflective mode (b), which relies on ambient light, or in a transreflective mode (c), which combines features of the other two modes. A typical LCD (d) consists of a layer of liquid-crystal material sandwiched between two glass plates. Shown is the 90°-twist, or TN, version; typical STN LCDs employ a 270° twist.

STN-type devices with twist angles of 180 to 270° are available today for applications that require high contrast and wide viewing angles.

ated by the column drivers. In essence, this 640×400-pixel display is two 640×200-pixel displays that are each driven in a 1:200 multiplexed mode. The control electronics sequentially writes to each row and activates it with a pulse from the appropriate row driver.

This activating pulse (minus the corresponding column voltage) is applied to each pixel once every screen frame. The rms value of the resulting waveform turns a pixel either on or off. The PCF 2201 has a total of 80 driver outputs for either row or column operation (plus one output for margin control). Thus, the display in Fig 2 requires a total of 21 drivers—16 for the columns and five for row control. A display controller coordinates the column and row drivers. It loads the column drivers (both upper and lower) with display information at the refresh rate and provides a row pulse once every screen frame, which propagates through all row drivers. The controller also interfaces with the display RAM, which

receives its bit-mapped display data from the host system.

The display bus consists of a 4-bit data bus, which carries the display data from the graphics controller to the column drivers in 4-bit segments. Typically, you have to refresh an LCD at a rate in excess of 30 Hz to avoid flicker problems. For a 640×200-pixel panel with a refresh rate of 50 Hz, you'll need a data rate of 6.4M bps. This rate is well within the 16M-bps data-loading rate of the PCF 2201.

In Fig 2, the PCF 2201 connects one of six fundamental multiplexing voltages to the 80 driver outputs one row at a time in accordance with the required pixel states. These voltages are actually two sets of dual-component voltages plus a common maximum and minimum (ground) voltage. Alternating voltage sets are applied every other frame. Each set is an inverse version of the other (reflected about the voltage scale's

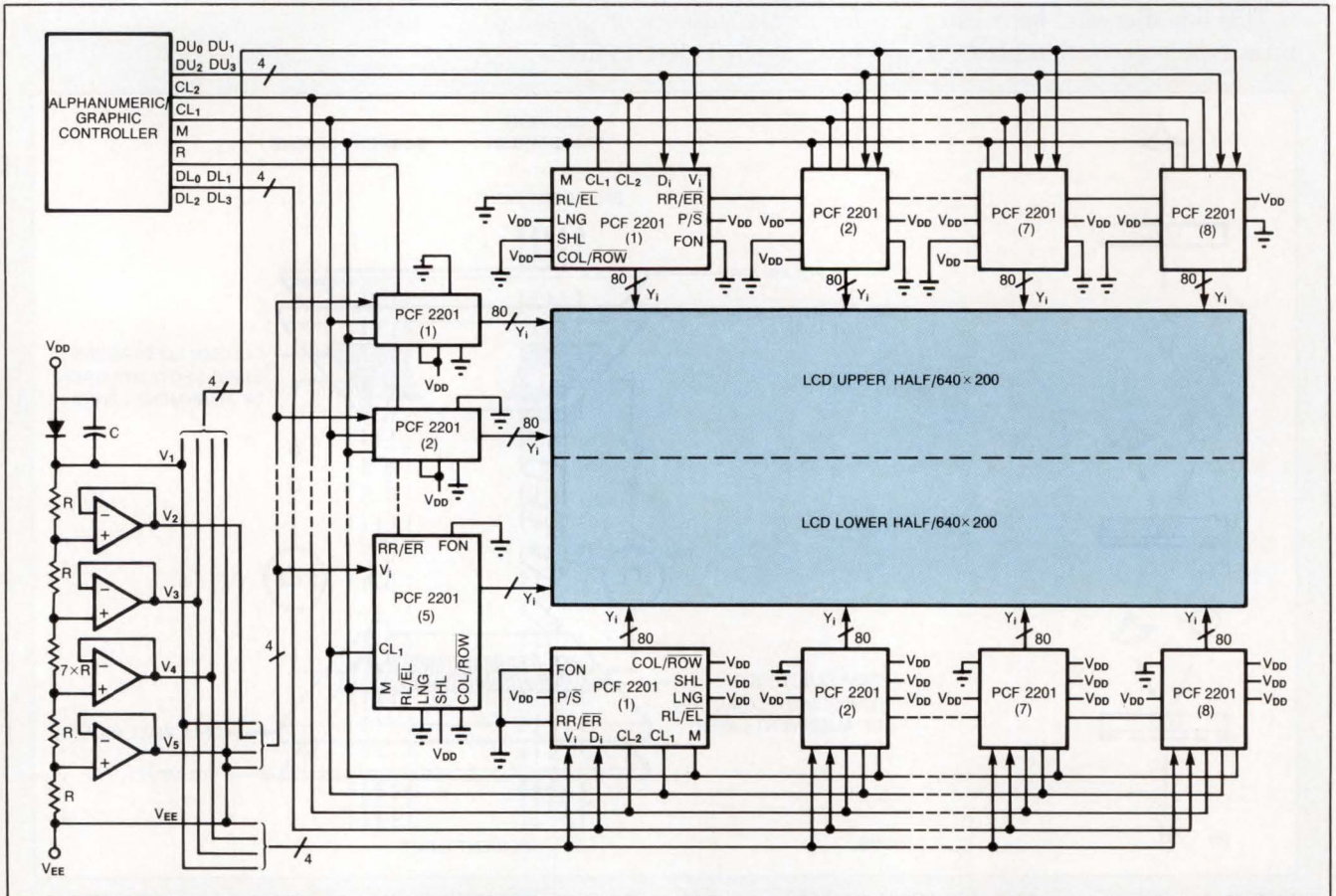
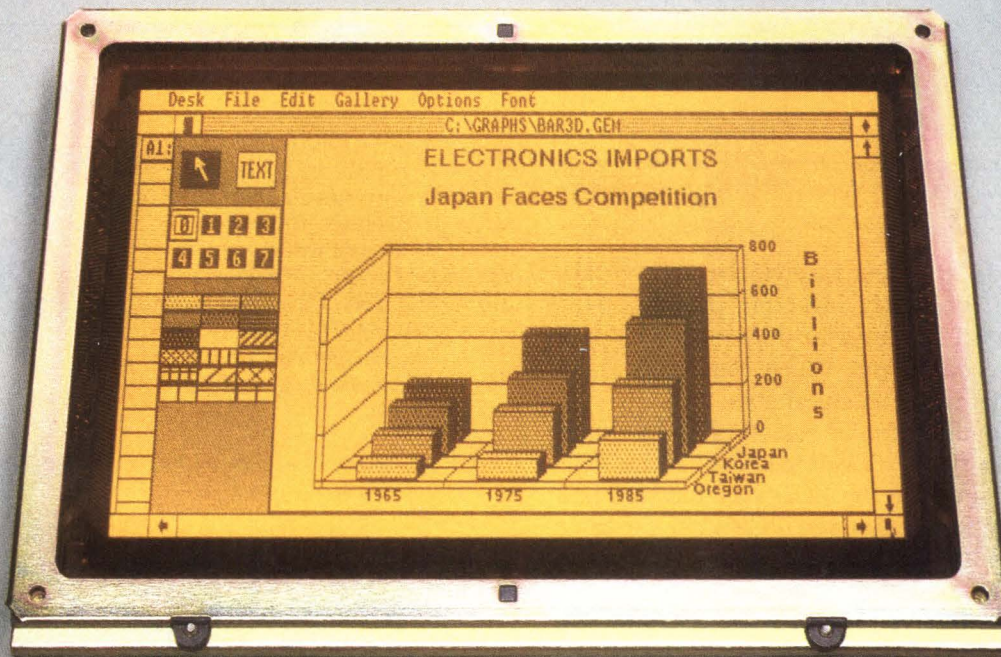

Fig 2—A typical flat-panel LCD system contains a dot matrix of 640 columns by 400 rows divided into two half screens of 640×200 pixels. The top and bottom column drivers control display data on the corresponding half screens while the row drivers provide the periodic strobe signals.

Display technology is often the last thing you specify.



And the first thing your customer sees.



LCD display and Planar EL display photographed under identical ambient lighting conditions.

From a customer's viewpoint, there's only one real window into your product.

The display.

If it's inferior, your product is judged inferior. No matter how good it really is.

For flat panel displays, there's a simple, yet elegant solution. Planar's electroluminescent (EL) display. Why is EL the preferred display technology? Better viewing angle. Better brightness. Better contrast.

It adds up to superior performance.

So contact us today. Choose the flat panel display that surpasses all others from everyone's point of view.

For a brochure, please phone either 503-690-1100 or 503-690-1102, or write to

PLANAR SYSTEMS, INC.
1400 N.W. Compton Drive
Beaverton, Oregon 97006.

PLANAR

Take care to ensure that the LCD material does not receive a prolonged rms dc component, which could eventually break down the material's chemical structure.

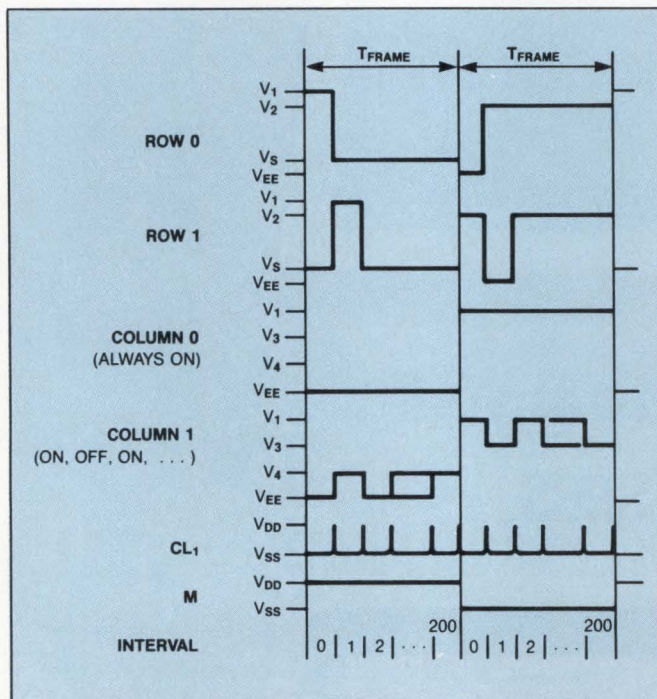

Fig 3—To control two alternate display frames, the drive electronics provides identical voltage-difference signals to the pixels but reverses polarities for the second frame.

midpoint) so the LCD pixels receive the appropriate signal levels with constantly inverting polarity. This ensures that the LCD material does not receive a prolonged rms dc component, which could eventually break down the material's chemical structure.

The external combination of resistors and voltage followers generates these six voltages, which the PCF 2201 then uses to generate the LCD waveforms. Fig 3 shows typical waveforms that the PCF 2201 develops and applies to the appropriate row/column outputs to generate, first, one column with all pixels on, and second, a column with an alternating pattern of on and off pixels. Fig 3 shows the waveforms generated for two alternate frames; the second frame shows the inverse waveforms. The pixels receive identical voltage-difference signals in both cases but with reversed polarity.

Row drivers are in control

As Fig 3 shows, the row drivers generate either an on or off voltage level. In each half display, the rows sequentially activate one at a time. All on segments receive their activating voltage component during the row pulse from their corresponding column driver. The pulse $V_1 - V_{EE}$, occurring once each frame, darkens a specific pixel. CL_1 , the clock governing the refresh rate,

scans a new row and reloads all column drivers with each clock pulse. M is an input signal from the display controller that controls the generation of normal or inverted multiplexed signals.

An explicit mathematical relationship exists between the maximum number of rows and the voltage level required for the highest magnitude multiplexed signal (V_1 in Fig 2). The larger the display, the higher number of rows and thus the the higher the necessary multiplex rate. As multiplex rates increase, the time available to activate or refresh each row decreases, which means you need a higher driving voltage to deliver the required rms voltage. In addition, to calculate the maximum possible multiplexing rate as a function of maximum driver voltage, you need to know the LCD threshold voltage—the voltage required to obtain a 10% contrast on the LCD.

EDN

Authors' biographies

Carl Fenger is an international product manager at Philips/Faselec (Zurich, Switzerland), where he is responsible for the worldwide marketing of CMOS peripherals. Previously, he worked as an applications engineer at the Linear Division of Signetics (Sunnyvale, CA). Carl holds a BSEE degree from the University of California. A classical pianist, Carl also likes to ski, scuba dive, and travel in his spare time.

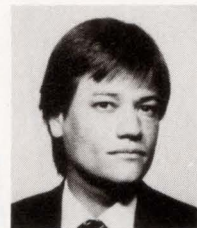

Kurt Muhlemann is design manager for display ICs at Philips/Faselec. In this position, he is responsible for the specification, design, simulation, layout, evaluation, and release of company products. Before joining the company, he was technical manager at the Swiss IC test center in Neuchatel. Kurt received his EE degree and his PhD for multiple processor operating systems from the Swiss Federal Institute of Technology in Zurich. In his spare time, Kurt enjoys cross-country and downhill skiing, photography, literature, and music.

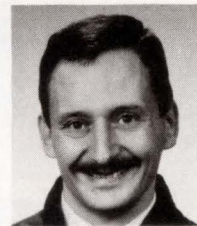

Article Interest Quotient (Circle One)
High 485 Medium 486 Low 487

This year, you'll
hear a lot of claims
that "systems"
design automation
has arrived.

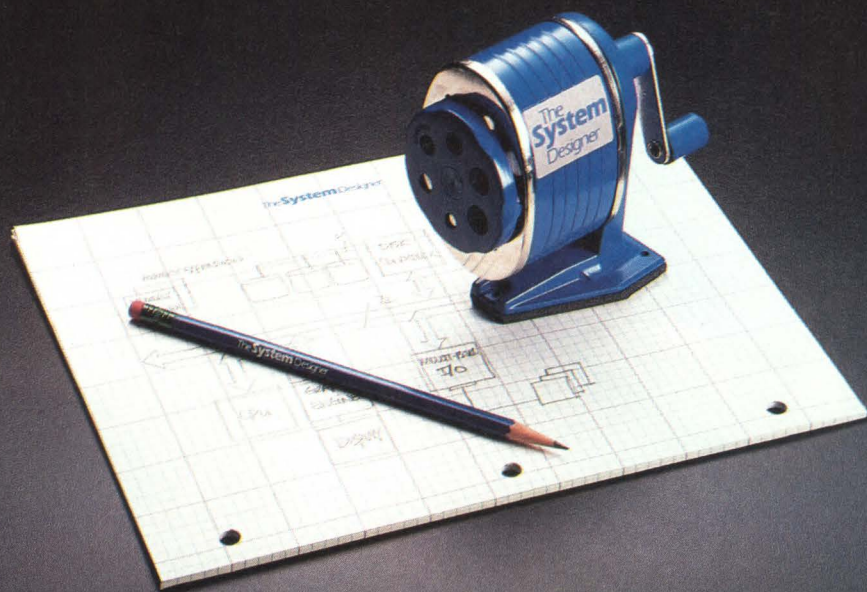

At Mentor Graphics, we And so do our customers.

Skeptical about "systems" electronic design automation?

You should be. Because in many cases, it's a triumph of form over content. Look behind the facade of so-called "systems" design automation tools, and you'll find little substance, if any.

Buy into this kind of systems design methodology and you're participating in a very costly experiment. With highly uncertain results.

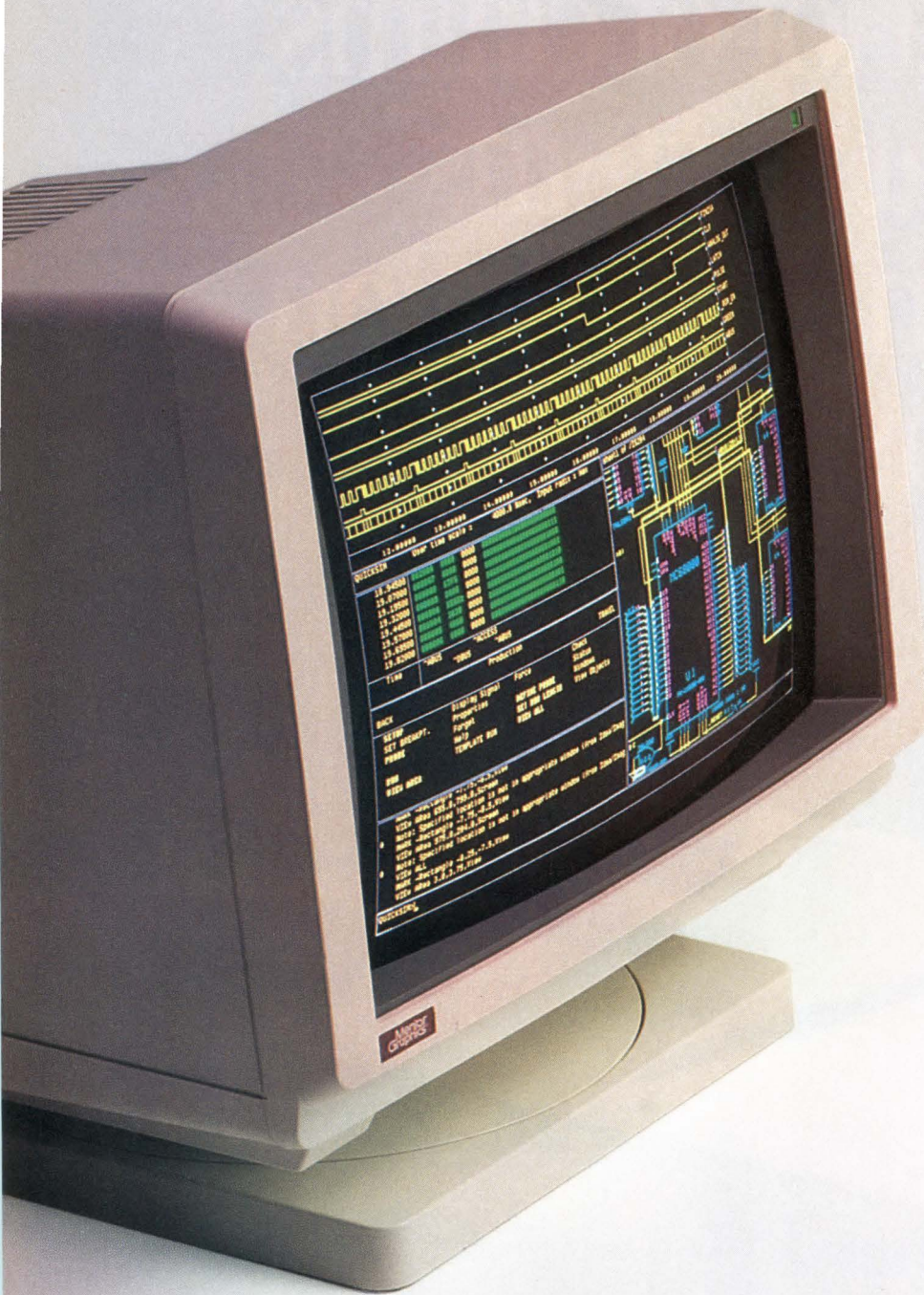

know better.

They preach. We practice.

There's only one practical yardstick for evaluating a systems design solution. And that's how many successful products it has produced.

Apply this measure and the field narrows dramatically. Essentially, down to a single vendor.

Mentor Graphics.

For over five years, our customers have been turning out sophisticated board products with our EDA tool set. Repeatedly. Like Sequent Computer Systems which in 1987 designed and simulated a 32-bit processor board with over 175 chips, including three ASICs, on Mentor Graphics workstations. From design start to diagnostic firmware verification and fabrication prototype in just seven months.

Test their claims.

Many "systems" design automation vendors have a tendency to bypass the obvious and dwell on the esoteric. And for good reason. Most have gaping holes in their product offering. Some interesting (and essential) questions that you should ask vendors:

Does your tool set have a common database and user interface? Does it extend from design definition through to PCB layout and output to manufacturing?

Do you have more ASIC libraries supported on your workstation than any other EDA vendor? Can you include ASICs in board simulations?

This 32-bit processor board was designed and simulated on Mentor Graphics workstations by Sequent for its multi-processor Symmetry computer system. It contains over 175 IC components including 80386 processors, a 14,000-gate standard cell and two 10,000-gate arrays. By simulating at the board level, Sequent was able to bypass breadboarding and proceed directly to fabrication prototype.

Are your tools capable of managing over 1000-page product documentation projects from start to finish?

Have you integrated mechanical packaging and analysis into the electronic design and layout process?

Anything less than a perfect score is a total loss. And a perfect score does not mean just a check in every box. Each item must be backed with the production-proven performance only Mentor Graphics can provide.

Experience makes the difference.

When we speak about systems design automation, we speak from experience. We have the largest customer base in the electronic design automation industry. And with good reason. Some 70% are repeat customers who are gaining genuine value from our products and expanding their competitive advantage.

Our long-term partnership with these customers allows us to contin-

ually refine our tools in a very pragmatic and innovative manner. With Mentor Graphics, you get productivity instead of speculation.

To be continued.

So much for the present. We're already developing new systems EDA tools that will extend to every dimension of electronic product development. From high-level systems descriptions to CASE. It's what our customers expect. It's what we'll deliver.

It's all part of a vision unique to Mentor Graphics, the leader in electronic design automation. Let us show you where this vision can take you.

Call us toll-free for an overview brochure and the number of your nearest sales office.

Phone 1-800-547-7390
(in Oregon call 284-7357).

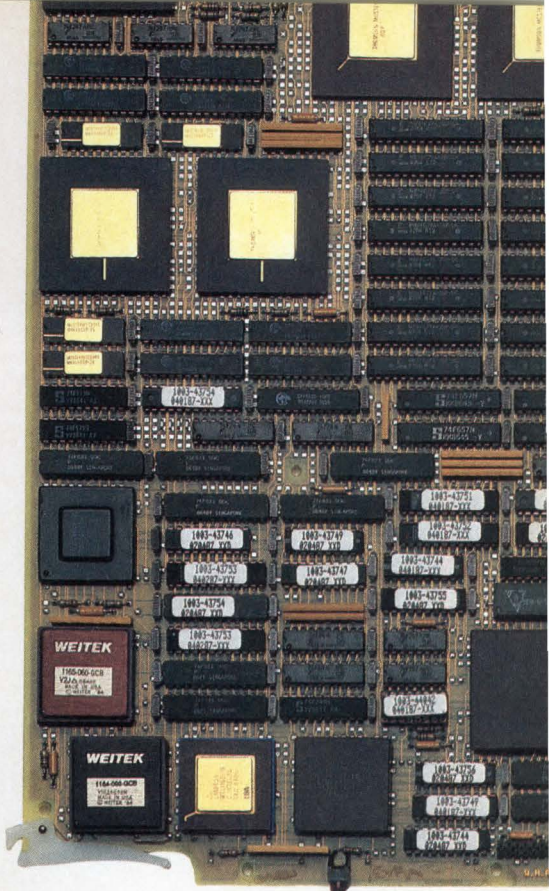

CIRCLE NO 83

**Mentor
Graphics®**

Your ideas. Our Experience.



Only HP can put real teeth into faster

Test development and execution speed. We know they're your top priorities. HP BASIC,* combined with our range of controllers and instrumentation, is the answer. Even if you're running on MS™ DOS or the UNIX™ operating system. And of course, it's all backed by HP's measurement expertise, and the product reliability you've come to count on from an industry leader.

HP BASIC: Optimized for instrument control.

It's no secret that a critical element of automated instrument control is fast development time. That's where HP BASIC really shines. With power, versatility and ease of use. We invite you to find a better instrument control language.

A few examples:

- Fast program development with interactive editing, syntax checking and the ability to search and replace

strings, or move blocks of code easily.

- Optimized for I/O with advanced constructs to simplify otherwise complex tasks. Interrupts, high speed data transfers, automatic data formatting and branching on events can all be handled easily. Since HP BASIC was designed for instrument control, these capabilities are integral, not tacked on as an afterthought.

- Structured programming lets you make your program modular with independent subprograms which can be re-used in other applications. Constructs like CASE statements, IF-THEN-ELSE, WHILE, REPEAT-UNTIL and LOOP are useful for rapid program development and invaluable for program maintenance.

- Powerful computation lets you take advantage of a full range of matrix manipulations such as multiplication, inversion and scalar operations. HP's complex number implementa-

tion allows for powerful arithmetic operations.

- Graphic capabilities are simple to program, yet powerful. One program statement can draw axes or grids, a second will plot your data, a third will label your plot and a fourth will provide a permanent copy.

HP Controllers: The right horsepower for the job.

Hewlett-Packard provides a wide range of instrument controllers and operating systems to meet your performance needs, allowing you to choose the most cost effective controller for your job.

Just look:

- Personal computers; the HP BASIC Language Processor allows you to use HP BASIC on the world's most prevalent operating system, MS DOS. It's available for the HP VECTRA or the IBM PC-AT.

*we never stop
asking*

"What if..."

test development.

- Dedicated controllers up to 4 MIPS, HP's Series 300 controllers provide a dedicated, high performance system for maximum I/O throughput.
- HP-UX workstations. HP BASIC will also be available for use in the Series

**Trim more time:
Deal with the pros.**

Our sales, service and support team can get your test up and running when time is of the essence. With over 500 instruments, HP is the recognized industry leader in test and measurement.

**Call HP for
a free video.
1-800-752-0900,
Dept 215R**



300 HP-UX environment. Our implementation combines the ease-of-use and performance of HP BASIC with the full networking, multitasking and windowing capabilities of the UNIX operating system.

No matter the controller demand, HP makes it in the optimum package.

Ask for our free videotape on HP BASIC or a brochure on HP instrument controllers. Learn how Hewlett-Packard can help you cut test development time significantly. More questions? Contact your local HP rep listed in the white pages.

© 1988 Hewlett-Packard Co. EI 15814/EDN

**hp HEWLETT
PACKARD**

CIRCLE NO 84

ONCE YOU'VE SEEN FUJITSU'S AC PLASMA DISPLAY, YOU'LL TAKE A DIM VIEW OF ANYTHING ELSE.

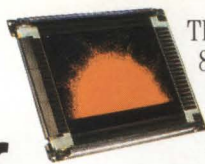

The only way our bright new 8050 display looks anything like the others is through a pair of sunglasses.

That's because the 8050 is without a doubt the brightest, most readable display in its class.

It's the first 10-inch, AC-memory, flat panel display to deliver 640 x 400 resolution with an extraordinary 44 foot-lamberts of brightness. Along with a contrast ratio of greater than 20:1. All in a package just over one inch thick.

In fact, the only thing more impressive than these numbers is looking at the display yourself. Then you'll really appreciate its exclusive solid black background. And the brightness and flicker-free clarity of text and graphics.

And what's truly amazing is that you'll get this remarkable performance under some of the worst possible conditions. Like bright sunlight. And viewing angles up to 120 degrees.

So if your application calls for the clearest images with maximum contrast, call us today at **1-800-556-1234, Ext. 238**. Inside California call, **1-800-441-2345, Ext. 238**. Or write Fujitsu Component of America, Inc., 3330 Scott Boulevard, Santa Clara, CA 95054-3197.

We'll brighten your day.

CIRCLE NO 85

Visit us at Electro
Booth Nos. 1135, 1137 and 1139



FUJITSU
COMPONENT OF AMERICA, INC.

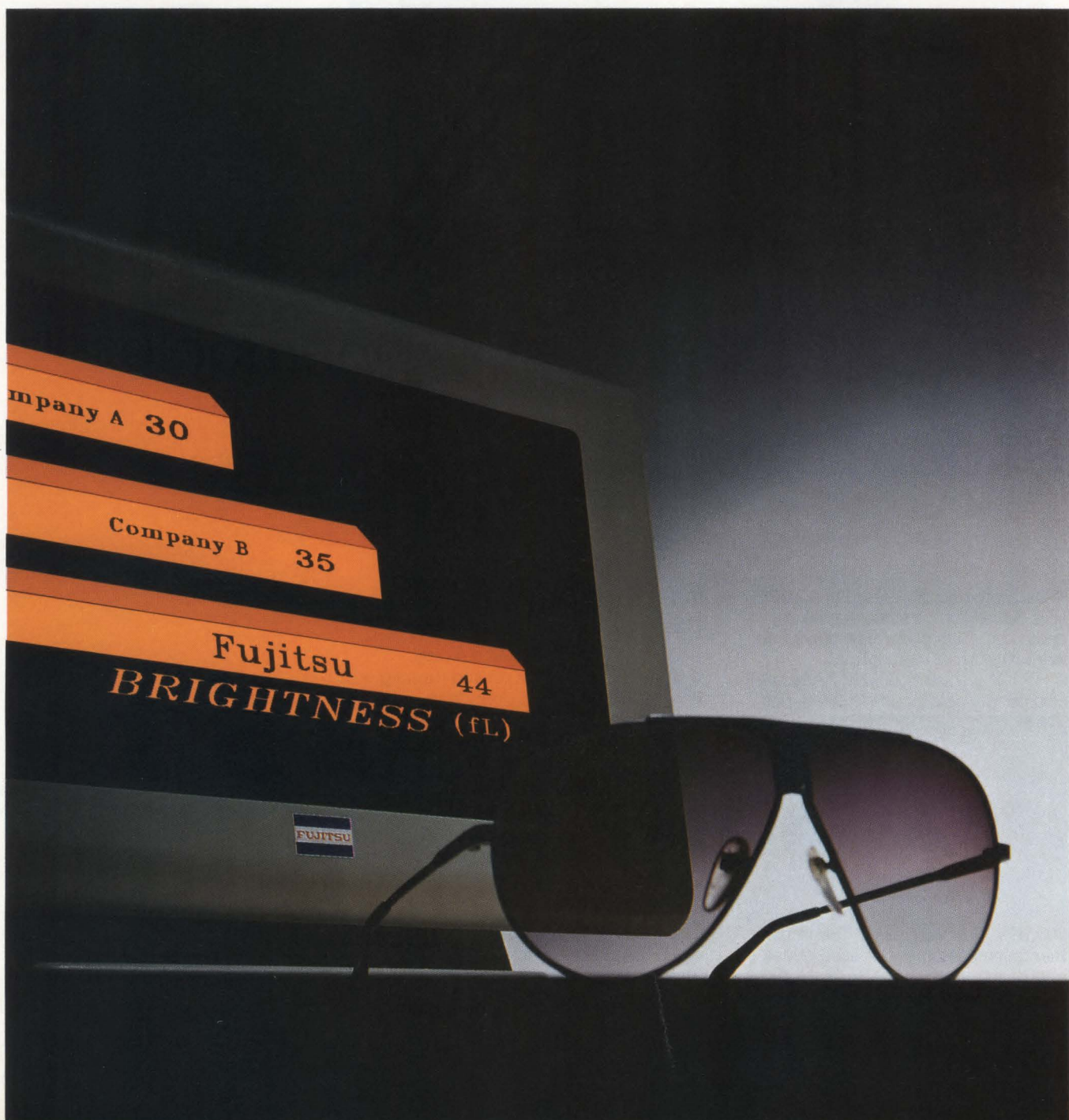

Spice extensions dynamically model thermal properties

Thermal mismanagement can destroy high-power components and can ruin the accuracy of tightly specified analog circuits. By performing dynamic thermal analysis with an extension of Spice, the venerable electrical-circuit modeling tool, you can avoid temperature-related problems.

Eric Filseth, *Analog Design Tools*, and Mike Jachowski, *Precision Monolithics Inc*

You can extend Spice to create models that accurately depict thermal effects on analog designs—effects that range from destructive thermal runaway to inaccuracies in data-conversion circuits having resolution of 12 bits or more.

Historically, EEs have treated thermal design as a black art. Engineers have applied rules of thumb—not rigorous analysis—and circuit-simulation programs haven't been of much help. Most such programs have only rudimentary thermal-analysis capabilities. Spice is typical; it allows you to specify an ambient temperature, but it does not account for real-time effects of device-to-device coupling. So, unmodified, Spice forces you to construct circuits to find out how they will behave—just what a simulator is supposed to avoid. Spice does let you insert dependent voltage and current

sources, however, and you can use that capability to build models of transient thermal phenomena.

Although temperature changes affect the accuracy of both MOS and bipolar circuits, catastrophic effects are more likely in bipolar circuits. In bipolar junction transistors (BJTs), increasing temperature raises h_{FE} , lowers V_{BE} , and as a consequence, raises the collector current (I_C). As a result, in some circuits, the BJTs' power dissipation increases with increasing temperature—which can cause a further increase in temperature and still higher dissipation. This situation is characteristic of positive thermal feedback. In MOSFETs, drain-to-source resistance increases with increasing

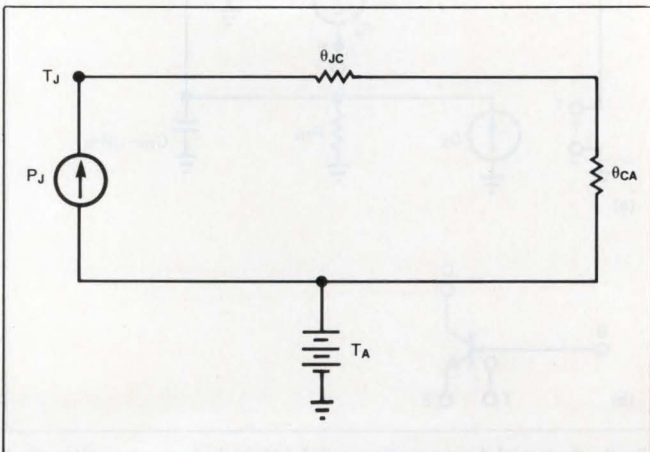

Fig 1—A static thermal model of a bipolar junction transistor includes a power source, two thermal resistances, and the ambient temperature.

Because of incorrectly estimated thermal feedback, chips can suffer destructive thermal runaway under supposedly benign conditions.

temperature, thus reducing drain current I_D and causing lower dissipation. This situation is characteristic of negative thermal feedback. MOSFETs tend to be thermally self-stabilizing; they are much less subject to thermal runaway than are BJTs. Therefore, this article focuses on bipolar circuits.

Ref 1 includes a good description of the most commonly used electrothermal model (ETM) for integrated circuits. The model forms an analogy between thermal systems and electric circuits: Power corresponds to current, temperature to voltage, and thermal resistance to ohmic resistance. If you choose the units correctly, Ohm's and Kirchhoff's laws apply. You can model heat sources (for instance, resistors and pn junctions) as current sources; temperature (modeled as voltage) is the dependent variable.

Fig 1 shows a simple ETM for a BJT. This model describes a discrete device or the power output stage of an IC—the part of the circuit that controls the case temperature. The thermal resistance is divided into two components: θ_{JC} , the junction-to-case thermal resist-

ance, and θ_{CA} , the case-to-ambient-air thermal resistance. The two are frequently combined as θ_{JA} , the junction-to-ambient-air thermal resistance.

Start with a static electrothermal model

Suppose that the power dissipated in the junction of the **Fig 1** model is 100 mW and that the ambient temperature is 25°C. If the thermal resistances are 45°C/W from junction to case and 55°C/W from case to ambient, the junction temperature is

$$T_j = 25^\circ\text{C} + 0.1\text{W}(45 + 55)^\circ\text{C/W} = 35^\circ\text{C}.$$

The 10°C rise occurs within milliseconds after you apply power; it is great enough to measurably affect the device's performance. But the model includes no energy-storage elements (capacitors, for example), so it does not describe the dynamic effects.

The ETM is a framework that quantifies the sources and flows of heat energy in a circuit. To use a circuit-analysis tool, such as Spice, to analyze dynamic thermal phenomena, you must be able to link device behavior to junction temperature. The ETM and Spice's dependent voltage and current sources form the basis for the link. At first, however, it looks as though there is no easy way to use the link, because Spice contains no provision for calculating instantaneous junction temperatures. However, it isn't hard to link the ETM's electrical analogy into Spice.

When forming a Spice thermal model, you must make some assumptions. In reality, thermal effects and thermal resistances are nonlinear. However, linear approximations that apply over limited temperature ranges are quite accurate. For example, you can approximate the temperature-dependent change in the potential of a transistor's base-to-emitter junction as $-2.2 \text{ mV}/^\circ\text{C}$. An easy way to model the impact of this effect is to add a voltage-controlled voltage source in series with the transistor's base or emitter. The controlling quantity is the voltage drop produced by an imaginary current proportional to the transistor's instantaneous dissipation flowing through a pair of resistors that represent the device's θ_{JC} and θ_{CA} .

Fig 2a shows the complete model. Voltage-controlled voltage source S_1 and current-controlled voltage source S_2 generate voltages proportional to the collector-to-emitter voltage and to the collector current, respectively, of the transistor Q_1 . The sources apply those voltages to a multiplier whose output voltage is proportional to the transistor's power dissipation. This

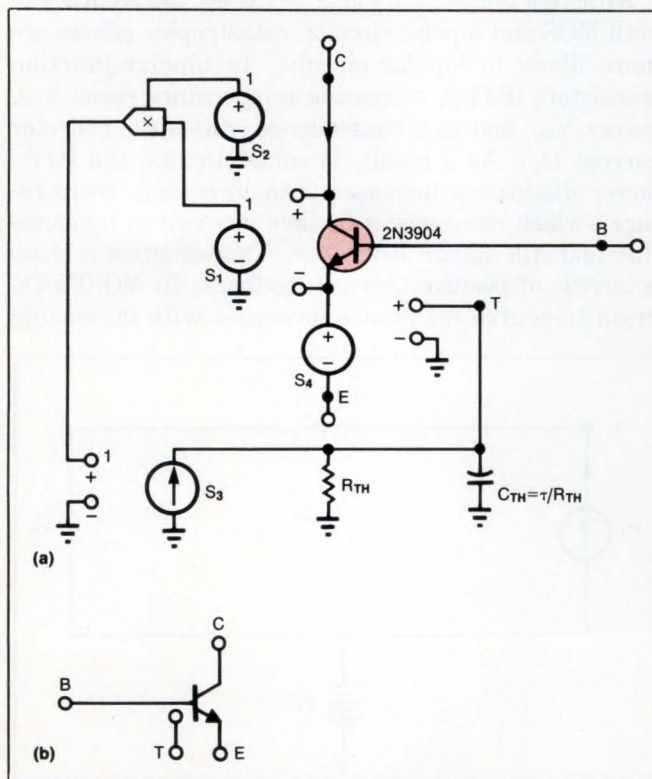

Fig 2—A complete dynamic model (a) includes a capacitor that simulates thermal mass. You can represent the entire model as a transistor with an extra node (b) and use the synthesized device in complex circuits.

voltage controls current source S_3 , whose output flows in resistor R_{TH} and capacitor C_{TH} to develop a voltage that controls voltage source S_4 , which is in series with Q_1 's emitter. In this model, R_{TH} is proportional to $\theta_{JC} + \theta_{CA}$. C_{TH} simulates thermal mass; because of its presence, the modeled junction temperature behaves like its real counterpart—it cannot change instantaneously. You determine the capacitor's value empirically, by measuring the thermal time constant and dividing it by the thermal resistance: that is, $C_{TH} = \tau/R_{TH}$.

What Spice doesn't know won't hurt it

As far as Spice is concerned, Q_1 is still operating at the same temperature as the rest of the circuit, but the additions shown in **Fig 2a** create a subcircuit that behaves like a transistor subject to self heating. In **Fig 2b**, this subcircuit has been compiled into a macro and given its own symbol, which includes an extra node, labeled T. That node allows you to model coupling among devices.

Fig 3a shows a common structure—a push-pull output stage using 2N3904 and 2N3906 transistors whose maximum safe continuous power dissipation without a heat sink is about 350 mW at an ambient-air temperature of 25°C. In this example, all devices are discrete, and there is no thermal coupling among them. R_{TH} , which, in this case, models θ_{JC} , is 125 °C/W, a typical value for small-geometry plastic-cased devices. τ is 1 msec. The use of θ_{JC} rather than θ_{JA} assumes that, for

the short period modeled by the simulation, the devices' case temperatures remain constant. That assumption, incidentally, supports the absence of coupling among devices.

Because the goal is a dynamic thermal analysis, a 30V step applied to the power-supply terminals is used to model the effect of powering up with $\pm 15V$ supplies. If you make $R_E = 10\Omega$, the no-load quiescent current through the transistors is slightly greater than 10 mA. **Fig 3b** shows a family of plots generated by the Analog Workbench (see **box**, "Focus on your circuit, not your simulator").

These plots represent the buildup of current after application of power with several different values of R_E . The lowest curve represents $R_E = 10\Omega$. In the top curve, $R_E = 0\Omega$, and within milliseconds after power is applied, the transistors are dissipating several watts, a destructive condition. In fact, if $R_E = 0\Omega$, within a few milliseconds, the temperature becomes so high that the 2.2-mV/°C model probably no longer applies. Nevertheless, the thermal runaway is clearly shown: Destruction of the transistors is not instantaneous; it occurs over a period of milliseconds as the result of positive thermal feedback—accurately modeled by the Spice extensions.

The circuit of **Fig 4a** illustrates how the Spice extensions handle thermal coupling between devices. Q_1 and Q_2 form a current mirror in the gain stage of a wide-band hybrid operational amplifier. To achieve wide bandwidth and the largest possible signal swing, a

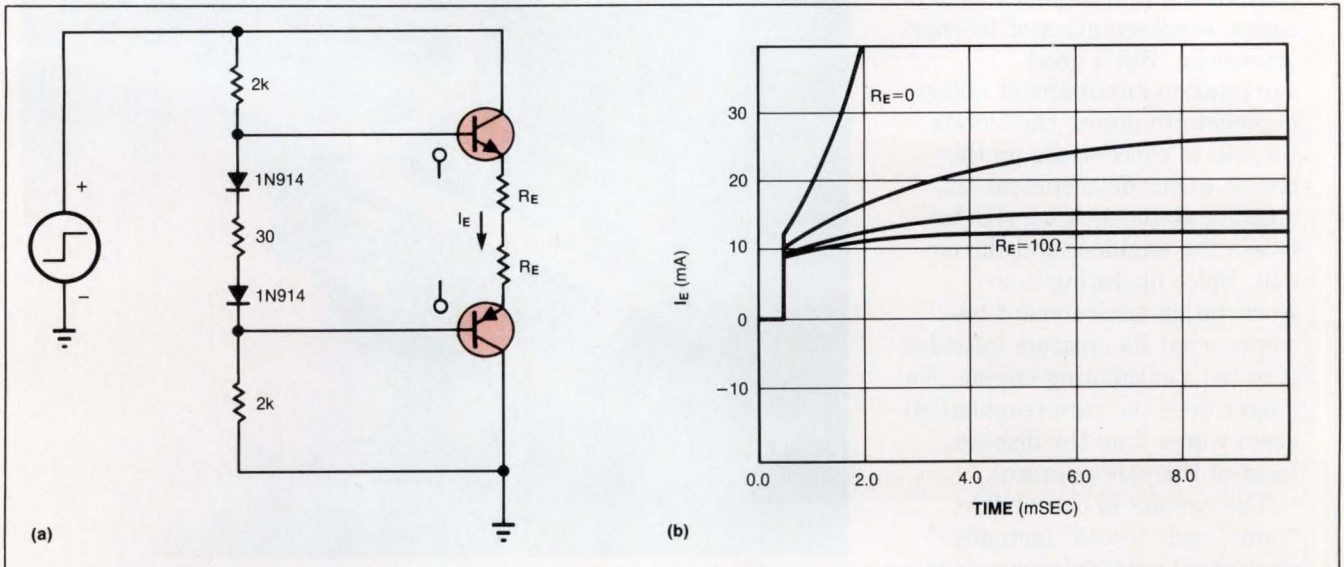

Fig 3—If you make the degeneration resistance in the complementary output stage (a) too small, the circuit will destroy itself, as the upper curve of the current-vs-time graph (b) illustrates.

When you design analog circuits having resolution of 12 bits or more, you must maintain a constant vigil, lest thermal effects wreck your circuits' accuracy.

2-transistor mirror is used, rather than a more complex structure. The mirror's accuracy depends on both the electrical and thermal matching of the devices. Q_1 is connected as a diode; the voltage across it is approximately 0.7V, a value that varies little. Q_2 is a common-emitter stage whose V_{CE} makes large swings. The currents through Q_1 and Q_2 are constant and—ideally—virtually equal. Because of its large and variable V_{CE} , Q_2 's dissipation varies over a wide range. R_{JJ} represents

the thermal resistance between Q_1 and Q_2 . Without good thermal coupling between the devices, Q_2 's higher dissipation will make its temperature higher than Q_1 's and spoil the transistor-to-transistor match.

Suppose you connect the amplifier to produce a noninverting gain of 100 and apply a 100-mV step to the input. As with the earlier push-pull-output-stage example, assume that, for the period modeled by the simulation, the amplifier's case temperature remains con-

Focus on your circuit, not your simulator

As every engineer who has used stand-alone Spice can attest, simulation tools have traditionally dragged designers away from their circuits and into performing the mechanical operations necessary to comply with the simulator's requirements. Building net lists and numbering nodes is so tedious and so different from circuit design that many engineers will do whatever they can to avoid using a stand-alone simulator.

Computer-aided circuit-simulation tools, of which Spice is the best known, offer distinct improvements in areas such as accurate representation of IC characteristics. But a good workstation environment allows engineers to ignore the simulator and to concentrate on the circuit under development. Instead of acting as a barrier between the engineer and the circuit, Spice operating in a workstation environment becomes what its creators intended it to be: a calculating engine. No longer does the cure (simulation) seem worse than the disease (seat-of-the-pants design).

The circuits in this article, "built" and "tested" (actually simulated) with Spice running under the Analog Workbench de-

sign environment from Analog Design Tools, demonstrate modern CAE tools' capabilities.

To create the circuits, the authors used the Workbench's Cir-

cuit Editor and the dynamic thermal model of a 2N3904 transistor contained in the Workbench's general device library. The devices contained in the li-



An interactive windowing environment allows designers who use Analog Design Tools' Analog Workbench to experiment with circuit models on a variety of workstations.

stant. (In the hybrid circuit, however, thermal coupling among devices is important.) Under these conditions, the pertinent thermal resistances are θ_{JC} , which equals $70^\circ\text{C}/\text{W}$, and θ_{JJ} (corresponding to R_{JJ} in Fig 4a), the effect of whose value you will model in successive simulation runs.

If $\theta_{JJ}=3^\circ\text{C}/\text{W}$, you obtain the almost perfectly square response shown in Fig 4b. You can't achieve response this good if you use discrete transistors for Q_1 and

Q_2 —even discrete chips mounted close together on a ceramic substrate, because with discrete transistors θ_{JJ} will be more than an order of magnitude higher than $3^\circ\text{C}/\text{W}$. To achieve the nearly perfect response illustrated, you need to use a monolithic transistor pair, such as PMI's MAT-01. In such devices, $\theta_{JJ}\approx 0.5^\circ\text{C}/\text{W}$, nearly an order of magnitude *better* than the coupling that produces the square response.

If $\theta_{JJ}=45^\circ\text{C}/\text{W}$, a more realistic value for discrete

library, more than 1400 at this writing, are documented in a device data book; data includes maximum operating conditions, thermal characteristics, and the plots of characteristic curves. This information can easily be compared to that in real device data books.

Not wanting to complicate their circuit design with all the detail in the schematic of this transistor, the authors used the Workbench to transform the circuit into a macro and to design a custom symbol for it.

It takes time to build a test setup in the lab. You can tweak a breadboard endlessly and still not learn all you need to know. For example, when the authors set up one amplifier circuit for lab tests, they had to set the gain extremely high—close to the open-loop gain of the op amp. The high gain made it difficult to keep the offset from running the output into the rail. Manual zeroing of the offset was necessary. Because the offset error changed with the room temperature, it took a half an hour and a good bit of tweaking to get it right.

Using stand-alone Spice to set up a circuit for testing would have been equally time consum-

ing, because entering (and altering) circuit characteristics can require a lot of programming. Whether at the lab bench or using a stand-alone simulator, designers spend an inordinate amount of time on activities only marginally related to designing a circuit and verifying its performance. Using the Analog Workbench, they can accomplish a delicate offset tweak in a few minutes, simply by typing in a new value for an offset generator inserted into the circuit.

Advanced CAE tools also make it possible to simulate measurements that would be difficult on a breadboard. You can attach "probes" to any point on an integrated circuit, not just to the inputs and outputs. So measuring the parasitic signals inside the chip, as was done with the thermally coupled npn transistors, is done by attaching the probe with the mouse, calling up the parametric plotter, and running the analysis. The Workbench displays the results immediately, and tweak adjustments take a few seconds.

Simulated test instruments, such as the oscilloscope used to determine the settling of the amplifier in this article, are also included in advanced CAE tools.

Other bench instruments include multichannel function generators, frequency sweepers, multichannel network analyzers, dc multimeters, and spectrum analyzers. The CRT displays controls that function like the knobs on real test instruments.

In addition to the parametric plotter used in this example, computer-based Monte Carlo and sensitivity/worst-case tools provide in-depth analyses quickly and reliably. Stress-analysis tools can also be used to identify overstressed components. Good conceptual design is as much a visual as a cerebral exercise, and the smoke icons that identify stressed components in the Analog Workbench's smoke alarm function as a powerful visual indicator of areas that need further attention.

In a sense, the advancement of CAE tools is evidenced by the fact that they are now rooted in the methods engineers have used for years. As a result, an engineer's intuition and knowledge are leveraged by an environment that supports time-tested creative engineering methods while providing the number-crunching and analysis functions best accomplished by a computer.

Historically, EEs have treated thermal design as a black art.

chips on a ceramic substrate, you obtain the response shown in the lower curve of Fig 4b. Initially, the transistors are matched, but soon after the voltage step, Q_2 's increased dissipation begins to raise its temperature above that of Q_1 . Eventually, the devices reach thermal equilibrium, but their temperatures are no longer equal. As long as the voltage step persists, Q_1 will be hotter than Q_2 . The thermal transient, as seen at the amplifier output, takes 1 msec to settle to within 25 mV of final value (approximately 0.6 LSB in an 8-bit system with a 10V full-scale range) and a full second to settle to within 1.2 mV of final value (0.5 LSB in a 12-bit, 10V-full-scale system). Clearly, the discrete current mirror, with its long thermal tail, is not well suited for use in an amplifier preceding even a moderately accurate ADC in a high-speed system.

If two supposedly identical BJTs operated under identical conditions exhibit a differential base-to-emitter junction potential (that is, $V_{BE1} - V_{BE2}$) equal to V_{OS} , the temperature coefficient of the differential voltage will be V_{OS}/T (in $V/^\circ C$), where T is expressed in degrees Kelvin. So, in theory, a bipolar-input operational amplifier that exhibits a V_{OS} of 1 mV will exhibit a dV_{OS}/dT of $3.33 \mu V/^\circ C$ at $23^\circ C$ ($300^\circ K$). Many modern low-drift monolithic operational amplifiers contain input circuits that reduce initial offset, so they do not perform as the preceding analysis might lead you to expect. This circuit sophistication can complicate the job of modeling an op amp's offset-voltage drift vs temperature.

Nonetheless, you can use the modeling techniques described here in conjunction with an op amp's maximum offset-voltage-drift spec to predict an error band

Automate thermal-resistance measurements

Thermal resistance, θ , is a consequence of mechanical—not electrical—properties of all semiconductor devices. Two factors exert a major influence on θ : die size and package characteristics. You can predict the thermal resistance of a new device with good accuracy by using the

value previously determined for a chip of similar size mounted in a similar package. Extrapolations usually work, too. For example, if an op amp in an 8-pin ceramic DIP has a θ_{JC} of $10^\circ C/W$, a voltage reference with half the chip area in an 8-pin ceramic DIP will have a θ_{JC}

of approximately $20^\circ C/W$.

Predicting θ_{JA} is even easier. For most plastic- and ceramic-cased ICs, θ_{CA} is the dominant term in θ_{JA} . θ_{CA} for such devices is mainly a function of package size. Mini-DIP packages with eight leads exhibit roughly twice the θ_{CA} of 16-pin DIPs.

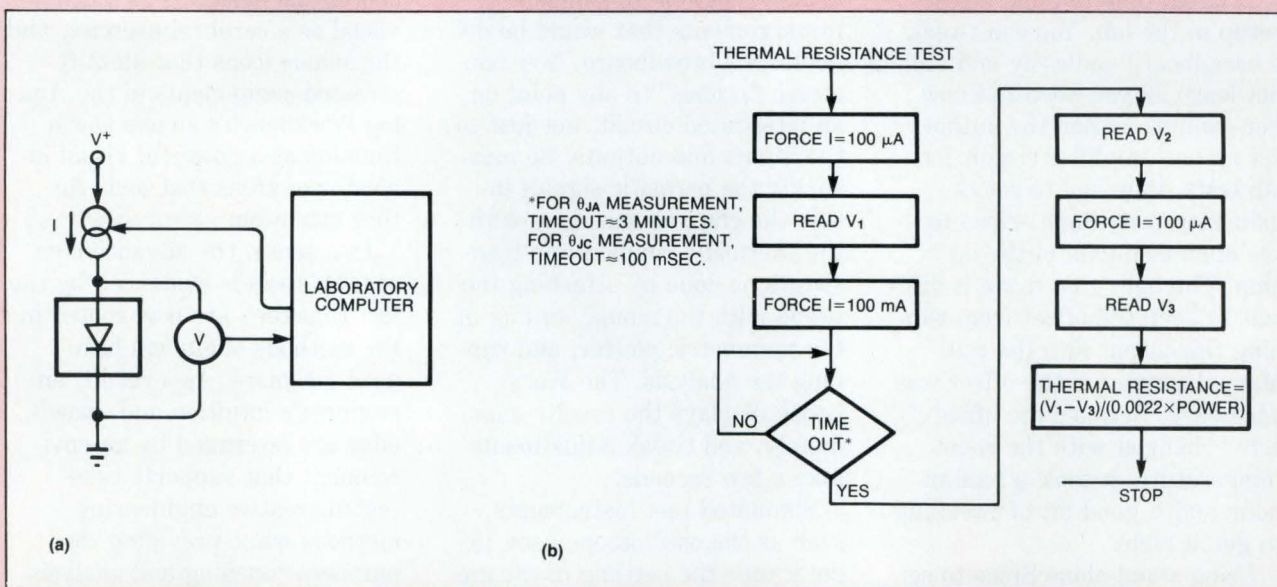

Fig A—A laboratory data-acquisition system (a) simplifies measurement of a device's thermal resistance. The flow chart (b) shows the steps required.

surrounding the device's output voltage. Four factors can influence a monolithic op amp's offset voltage by affecting its junction temperature: quiescent dissipation, signal-induced dissipation, ambient temperature, and heat sinking. Of these factors, the most easily understood is ambient temperature. There is a one-to-one correspondence between ambient- and junction-temperature changes.

Heat sinking is fairly easy to understand. It affects a device's junction temperature by affecting θ_{JA} . With a heat sink attached to its case, a device's junction-to-ambient-air thermal resistance consists of three elements in series instead of the two discussed earlier:

$$\theta_{JA} = \theta_{JC} + \theta_{CS} + \theta_{SA},$$

where θ_{CS} is case-to-heat-sink thermal resistance and θ_{SA} is heat-sink-to-ambient-air thermal resistance. Because $\theta_{CS} + \theta_{SA} < \theta_{CA}$, the junction-temperature rise above ambient temperature is reduced by attaching a heat sink to the device's case.

Air velocity can affect circuit performance

Remember, too, that with or without a heat sink, the velocity of the air moving past a device affects its case-to-ambient-air thermal resistance, and hence its junction temperature. An old story provides a good illustration of the effect of varying air velocity on T_J : A low-level signal amplifier breadboard was suspected of oscillating at an amplitude equivalent to about 15 μV p-p referred to its input with a frequency of about 0.5 Hz. Eventually, the designer traced the oscillation to

Although such predictions are useful, they frequently fail to provide information needed to forecast errors in analog ICs. A computer-based laboratory data-acquisition system can enable you to make thermal resistance measurements on ICs and discrete components rapidly and with relative ease. However, hybrid circuits can present a special challenge; they can contain chips whose temperature you want to measure but that are inaccessible from the package's pins.

Fig A shows a typical setup and flow chart for measuring θ . A current source forces current into the DUT (device under test). The voltmeter reading multiplied by the source current equals the power dissipated. The computer is handy not only for data analysis but also for controlling the current source. The test takes advantage of a component present in all semiconductors—the pn junction. Bipolar integrated circuits (except die-

lectrically isolated devices) contain pn parasitic junctions between the power-supply terminals. When measuring the temperature of an IC, these parasitic junctions are the best available thermometers. MOS devices contain them, too.

The basic idea is to measure the diode's forward voltage cold, then deliver a known amount of power to the chip and measure the forward voltage hot. If you deliver the same current to the diode whenever you measure its forward voltage, you can determine the junction-temperature rise from the $-2.2\text{-mV}/^\circ\text{C}$ temperature coefficient. A measurement current of 100 μA is a good choice; it won't heat the diode excessively, nor will it create significant voltage drops across resistances (of bonding wires, for example) in series with the diode. You calculate θ as temperature rise divided by power.

For θ_{JA} measurements, a heating power of 100 mW is ade-

quate. The DUT should be exposed to still air with nothing touching the case. No breezes should be allowed to provide cooling. Heating must continue until the device reaches thermal equilibrium; it is not unreasonable to allow two to four minutes. The speed of the data-acquisition system comes in very handy at this point. It is important to check the junction temperature within about a millisecond after removing the heating power—before the DUT can cool down.

In contrast, the procedure for θ_{JC} measurements is quicker. You have to apply power only long enough for the chip to warm up; you must remove power before the chip warms the package. Because θ_{JC} is much lower than θ_{JA} , you may need to dissipate more power (200 to 400 mW) to achieve a significant temperature rise. If the package temperature remains constant, the chip temperature rise divided by the applied power represents θ_{JC} .

Spice forces you to construct circuits to find out how they will behave—just what a simulator is supposed to avoid.

Model thermal effects on Rs and Cs in ICs

Fig A shows a model for an integrated resistor whose room-temperature resistance is R_0 :

$$R = R_0(1 + \alpha \times 10^{-6} \Delta T),$$

where α is a temperature coefficient expressed in ppm/°C and ΔT is a temperature change in °C. The temperature effects are modeled by a voltage source in series with the resistor. The source's value is derived in the

equations at the bottom of Fig A. The model is a little more complex than the transistor's thermal model because the source voltage depends on both the voltage drop across R_0 and the ΔT .

Fig B shows a model for a junction capacitor:

$$I = C(dV/dt) \\ = C_0(dV/dt) + (\alpha \times 10^{-6} \Delta T)dV/dt.$$

A current source, whose value depends on the rate of change of voltage across C_0 , models the temperature dependence. Note that, although the capacitor is affected by the chip temperature, it dissipates no energy and is not, itself, a heat source.

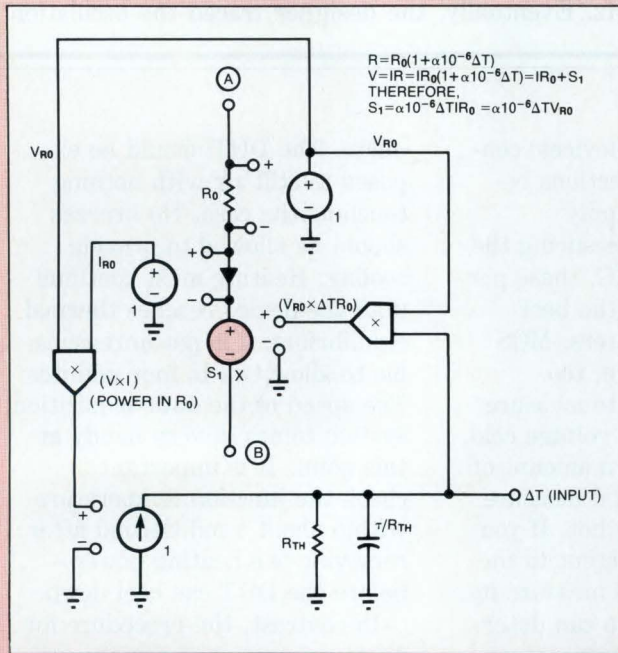

Fig A—This model of an integrated resistor uses a voltage-controlled voltage source to model the effects of temperature.

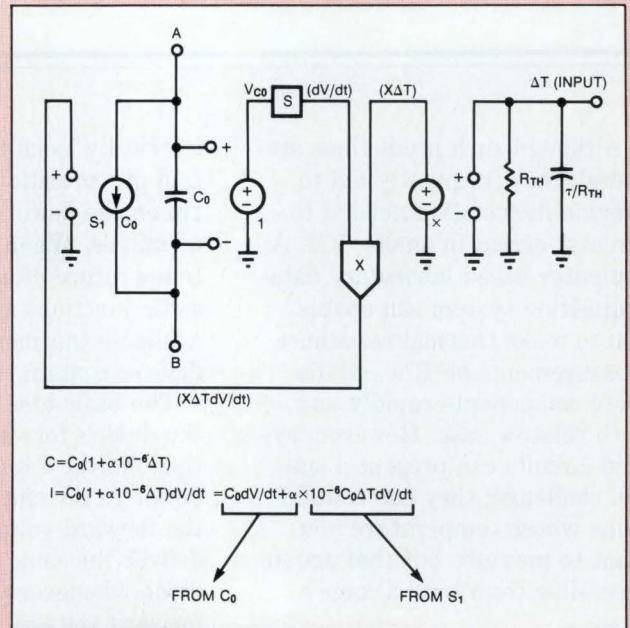

Fig B—You can model the effects of varying temperature on an integrated capacitor by shunting the capacitor with a voltage-controlled current source.

an oscillating electric fan on a lab bench many feet away. Whenever the air stream from the fan swept over the breadboard, it lowered the θ_{JA} of the input device, and hence lowered its T_J . Because of the amplifier's nonzero dV_{OS}/dT , the amplifier converted the fan's motion into a varying output voltage.

A device's quiescent dissipation goes from zero to some nonzero value when you apply power. The preceding statement might seem trivial, but it implies the significance of the methods IC manufacturers use to test and trim their parts. Low-initial-offset op amps

often undergo a trimming operation as part of the manufacturing process. Usually, this operation is performed at high speed on automatic test equipment. Often, it is impractical to allow enough time for the devices to reach normal operating temperature before trimming them. A vendor who trims an op amp before its temperature stabilizes must know what the amplifier's offset *would have been* had he allowed sufficient stabilization time. If the internal trims null the offset before the device warms up fully, the additional offset (that is, the difference between the nulled offset and the

Introducing OrCAD Verification and Simulation Tools

Logic Simulation

IS ONLY **\$995**

Easy to use menu driven commands speed and simplify design verification.

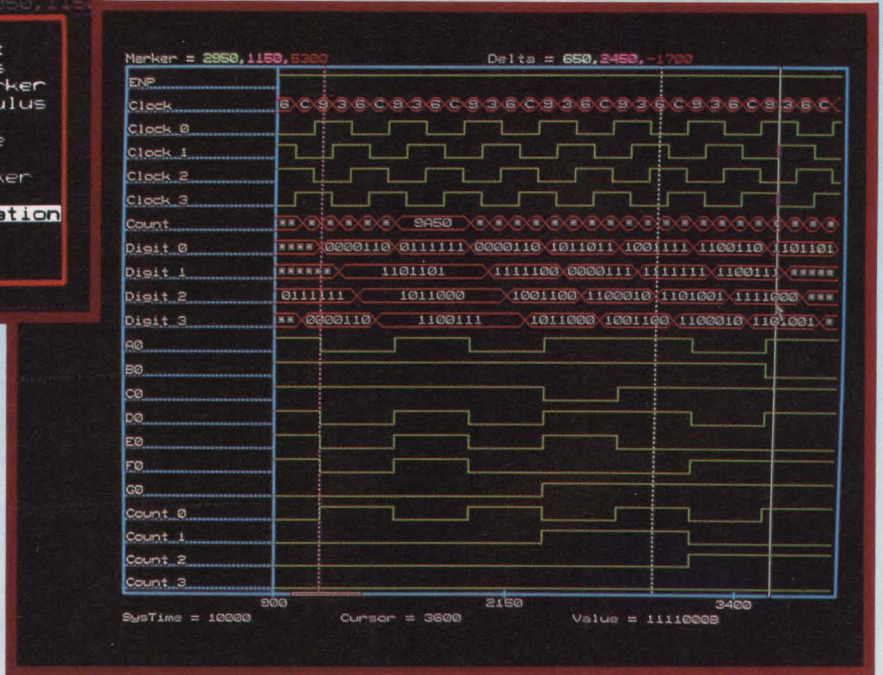

OrCAD / VST The Next Logical Step

Introducing OrCAD / VST, a full featured verification and simulation tool that is designed to place the performance of an expensive workstation on your PC.

OrCAD / VST is integrated with the popular OrCAD /SDT schematic capture package, with easy-to-use menus and powerful keyboard macros. Your valuable time is used to simulate designs without investing the time, money and resources to built prototypes.

With unsurpassed performance on a PC, you'll discover that nothing comes close to OrCAD's features and price. Benchmark the specifications for yourself. We guarantee satisfaction, or your money back!

- Event driven, 12-state functional simulator
- Exceeds 10,000 events/sec. on an 8 MHz AT without additional hardware
- Over 14,000 gate capacity

- Logic analyzer display format. Virtual screen displays 50 channels
- 10 breakpoints can be set as AND/OR condition of up to 16 signals
- User selectable minimum and maximum delays
- Input stimulus is easily defined with an integrated pop-up editor
- Includes component models of TTL, ECL, CMOS, Memory devices, and easy to use utility for creating custom models

- Of course, OrCAD's excellent support: technical staff to answer questions, 1 year of free product updates, and a trained sales and support network

Call or write today for our **FREE Demo Disk and brochure.**



1049 S.W. Baseline St. Suite 500
Hillsboro, Oregon 97123
(503) 640-5007

- | | | |
|--|--|--|
| 1. WA, OR, MT, ID, AK
Seltech, Inc.
206-746-7970 | 6. NE, KS, IA, MO
Walker Engineering, Inc.
913-888-0089 | 11. FL
High Tech Support
813-920-7564 |
| 2. N. CA, Reno NV
Elcor Associates, Inc.
408-980-8868 | 7. TX, OK, AR, LA
Abcor, Inc.
713-486-9251 | 12. DE, VA, MD, DC
MGM Visuals
703-352-3919 |
| 3. So. CA
Advanced Digital Group
714-897-0319 | 8. MI, E. WI, IL
Cad Design Systems, Inc.
312-882-0114 | 13. MS, AL, GA
Electro-Cadd
404-446-7523 |
| 4. Las Vegas, NV, UT, AZ,
NM, CO
Tusar Corporation
602-998-3688 | 9. IN, OH, KY, WV, W. PA
Frank J. Campisano, Inc.
513-574-7111 | 14. E. PA, NJ, NY
Beta Lambda, Inc.
201-446-1100 |
| 5. ND, SD, MN, W. WI
Comstrand, Inc.
612-788-9234 | 10. TN, NC, SC
Tingen Technical Sales
919-878-4440 | 15. CT, RI, MA, VT, NH, ME
DGA Associates, Inc.
617-935-3001 |

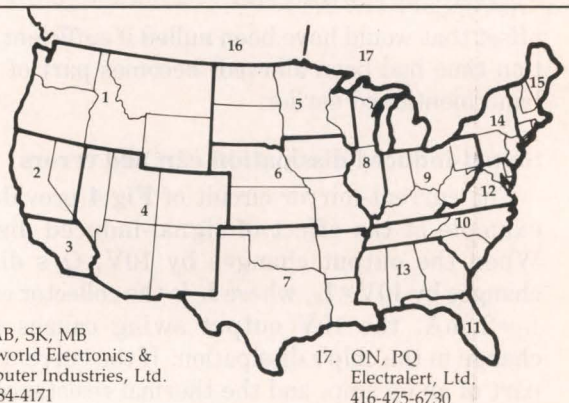

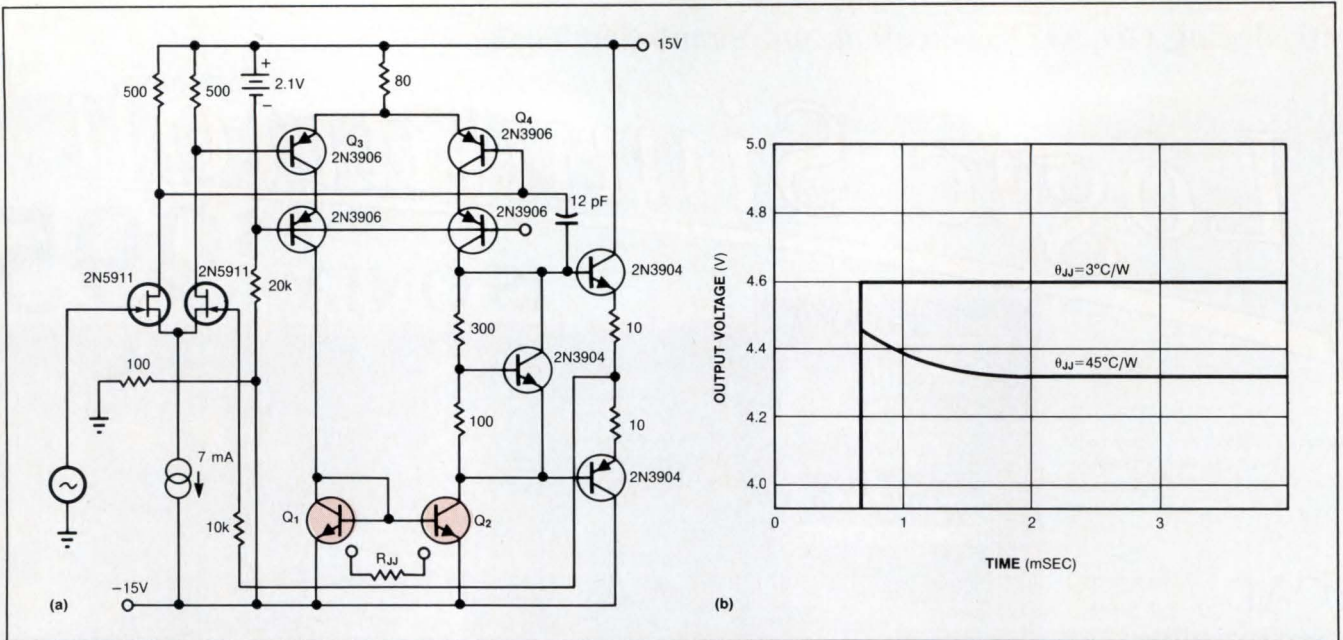

Fig 4—If you use discrete transistors to build the current mirror consisting of Q_1 and Q_2 (a), signal-induced dissipation causes the amplifier output to exhibit a long tail, as indicated by the lower curve of the voltage-vs-time graph (b).

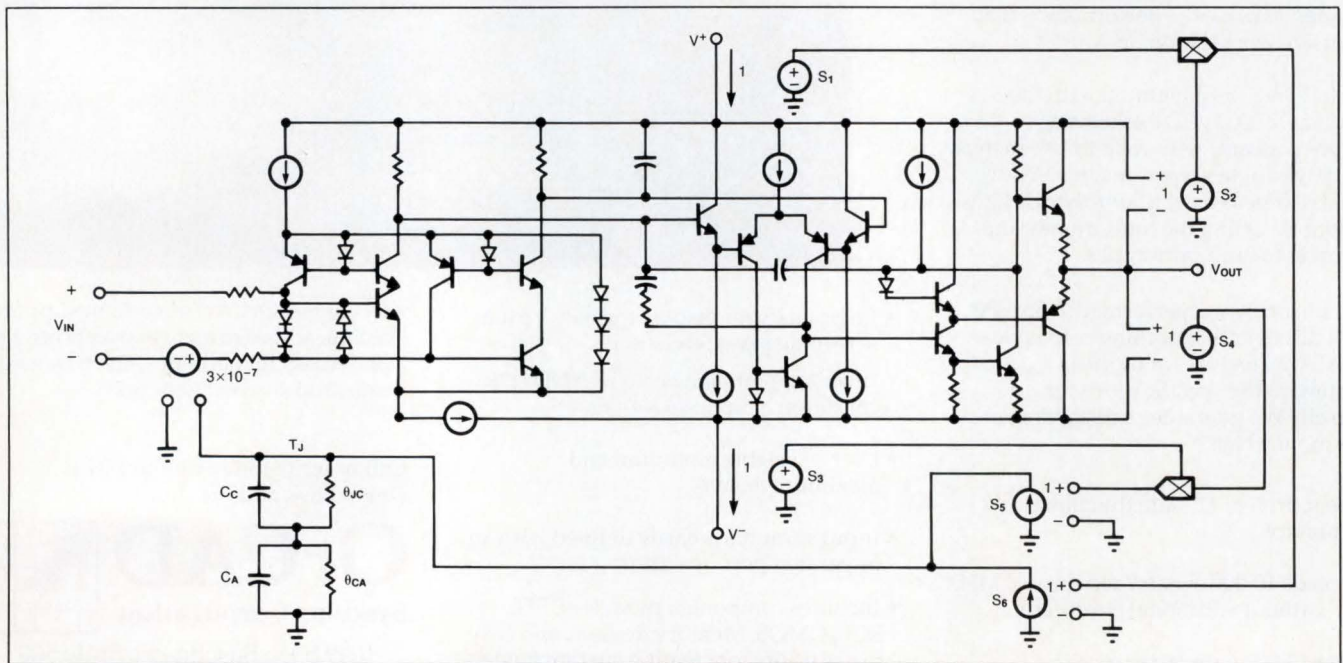

Fig 5—Close examination of the simplified schematic of PMI's OP-77 indicates the similarity between the techniques used for thermal modeling of ICs and discrete devices.

offset that would have been nulled if sufficient stabilization time had been allowed) becomes part of the error band mentioned earlier.

Signal-induced dissipation can add errors

The current-mirror circuit of Fig 4 provides a good example of the effect of signal-induced dissipation. When the output changes by 10V, Q_2 's dissipation changes by $10V \times I_C$, where I_C is the collector current. If $I_C = 2$ mA, the 10V output swing causes a 20-mW change in the chip's dissipation. If the current mirror is part of an op amp, and the thermal resistances are not absolutely identical from Q_2 to both transistors of the

input differential pair that governs the amplifier's V_{OS} , the signal-induced dissipation will warm one side of the differential pair more than the other. The temperature difference, which takes milliseconds to develop, will cause V_{OS} to change because of the -2.2 -mV/°C temperature coefficient of V_{BE} . If you can determine the thermal resistance from Q_2 to each input transistor, the Spice extensions can model the effect, and the effect becomes part of the device's error band.

Fig 5, a simplified schematic of PMI's OP-77 precision op amp, illustrates that to model the effects of an IC's internal power dissipation, you can use the same techniques you use to model the effects of internal dissipa-

1988 ANALOG APPLICATIONS SEMINAR

by Precision Monolithics Inc.

Oakland, California 4/19
Tampa, Florida 4/19
Waterbury, Connecticut 4/20
Melbourne, Florida 4/20
South Boston, Massachusetts 4/21
Orlando, Florida 4/21
North Boston, Massachusetts 4/22
Fort Lauderdale, Florida 4/22
Houston, Texas 4/26
Austin, Texas 4/27
Orange County, California 4/27
Fort Worth, Texas 4/28
San Diego, California 4/28
Dallas, Texas 4/29
San Jose, California 4/29
San Fernando Valley, California 5/3
Los Angeles, California 5/4
Tucson, Arizona 5/5
Phoenix, Arizona 5/6
Minneapolis, Minnesota 5/10
Milwaukee, Wisconsin 5/11
Madison, Wisconsin 5/12
Chicago, Illinois 5/13
Baltimore, Maryland 5/17
Philadelphia, Pennsylvania 5/18
North New Jersey 5/19
Long Island, New York 5/20
Indianapolis, Indiana 5/24
Fort Wayne, Indiana 5/25
Detroit, Michigan 5/26
Grand Rapids, Michigan 5/27
Toronto, Canada 6/1
Pittsburgh, Pennsylvania 6/2
Buffalo, New York 6/3
Cleveland, Ohio 6/7
Columbus, Ohio 6/8
Dayton, Ohio 6/9
St. Louis, Missouri 6/10
Huntsville, Alabama 6/14
Knoxville, Tennessee 6/15
Seattle, Washington 6/16
Raleigh, North Carolina 6/16
Portland, Oregon 6/17
Atlanta, Georgia 6/17
Denver, Colorado 6/21
Colorado Springs, Colorado 6/22
Albuquerque, New Mexico 6/23
Salt Lake City, Utah 6/24
Syracuse, New York 6/28
Montreal, Canada 6/29
Ottawa, Canada 6/30

This *free* 3-hour all new technical seminar discusses the latest in high performance analog components and design techniques.

Seminar Topics Include:

Precision Transducer Signal Conditioning

Using High-Speed/Wideband Op Amps

Computer Simulation of Analog Circuits

Higher Speed, Higher Resolution Data Converters

Advanced Data Communication Techniques

Complete course notes and new product samples will be distributed. All seminars start promptly at 8:30 a.m. To reserve your place, call 800-843-1515 now!

ORANGE COUNTY: (714) 637-6902, LOS ANGELES: (818) 886-6881, MILPITAS: (408) 942-8060,
DALLAS: (214) 341-1742, CHICAGO: (312) 250-0808, ATLANTA: (404) 263-7995,
PHILADELPHIA: (215) 675-7600, BOSTON: (617) 794-0026

EDN April 14, 1988



The precision solution.

tion in a discrete transistor. The schematic shows a controlled voltage source with a scale factor equal to the device's specified voltage-offset temperature coefficient in series with the input. The outputs of two controlled current sources, S_5 and S_6 , flow through the series combination of a pair of RC networks to provide the input source's control voltage. A multiplier, which computes the product $I^-(V_{OUT}-V^-)$, drives S_5 ; a second multiplier, which computes the product $I^+(V^+-V_{OUT})$, drives S_6 . V^+ and V^- are the supply voltages; I^+ and I^- are the corresponding supply currents.

The RC networks represent the junction-to-case and the case-to-ambient-air time constants; in typical ICs their values are 0.5 to 5 sec and 30 to 120 sec, respectively. Because the internal time constant is only $\frac{1}{6}$ to $\frac{1}{240}$ as large as the external one, and because θ_{CA} is much greater than θ_{JC} , you can often safely use only θ_{JA} and its associated time constant, which are nearly the same as θ_{CA} and its time constant. Fig 6 shows how the OP-77's offset voltage changes as the device warms up. The exponential decay of the offset change reveals θ_{JA} 's time constant.

For best results, play by the rules

The following precautions can help you avoid thermal errors in high-accuracy analog systems:

- Use amplifiers specified to have low voltage-offset temperature coefficients.
- Use the lowest practical supply voltages to minimize internal dissipation.
- Avoid using precise high-gain amplifiers to directly drive even medium-power loads. Interpose separately packaged devices as buffers between critical gain blocks and loads.
- Remember to include the load imposed by feedback networks when calculating an amplifier's dissipation.
- Locate high-dissipation components as far as possible from temperature-sensitive components.
- Select devices in packages that have low thermal resistance. Ceramic packages, although more expensive, have lower θ_{JC} than do plastic packages.
- Use heat sinks where appropriate. Although this caveat doesn't apply to digital systems, if you are building low-level analog circuits, and you have a choice between using heat sinks or fans, you will probably be happier with heat sinks.

In 8-bit systems, these precautions may appear to represent overkill, but they reduce time spent in debugging and troubleshooting subtle problems. In so doing,

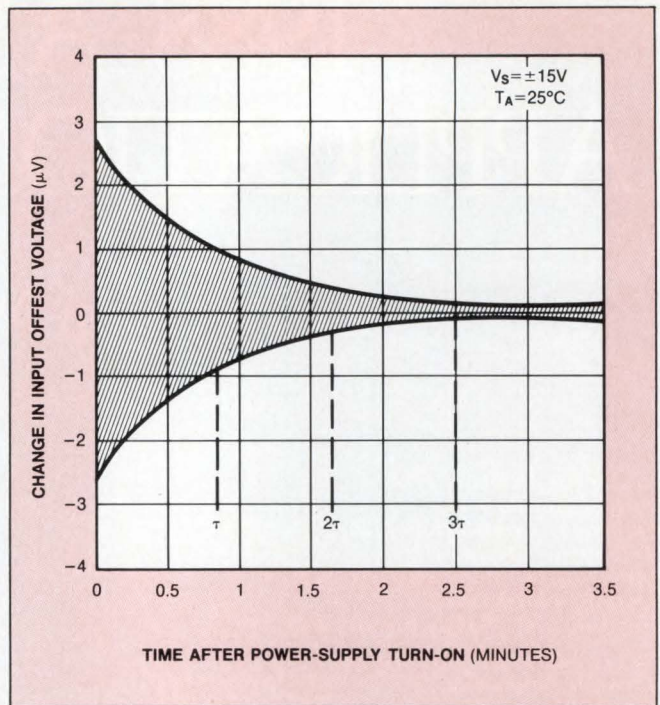

Fig 6—The offset voltage of a precision op amp (PMI's OP-77) changes as the device warms up. The curves indicate a junction-to-ambient thermal time constant of about 50 sec.

they can pay for themselves. In systems whose resolution is 12 to 16 bits or more, these precautions are mandatory.

EDN

Reference

1. Hamilton, Douglas, and Howard, WG, *Basic Integrated Circuit Engineering*, McGraw-Hill, New York, 1975.

Authors' biographies

Eric Filseth is consulting for Analog Design Tools (Sunnyvale, CA) while he completes the requirements for an MBA at UCLA. He holds a BSEE from Stanford University and was previously employed at National Semiconductor Corp. Eric is a member of the IEEE.

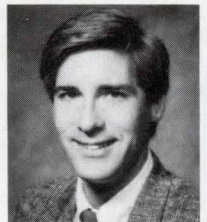

Mike Jachowski is a senior applications engineer at Precision Monolithics Inc (Santa Clara, CA). He has worked at PMI for two years; he previously worked at National Semiconductor Corp and XO Industries. Mike holds a BSEE from the University of Colorado at Boulder and is a co-inventor on one patent. In his spare time, Mike skis and works on building a new home.

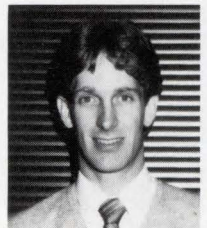

Article Interest Quotient (Circle One)
High 479 Medium 480 Low 481

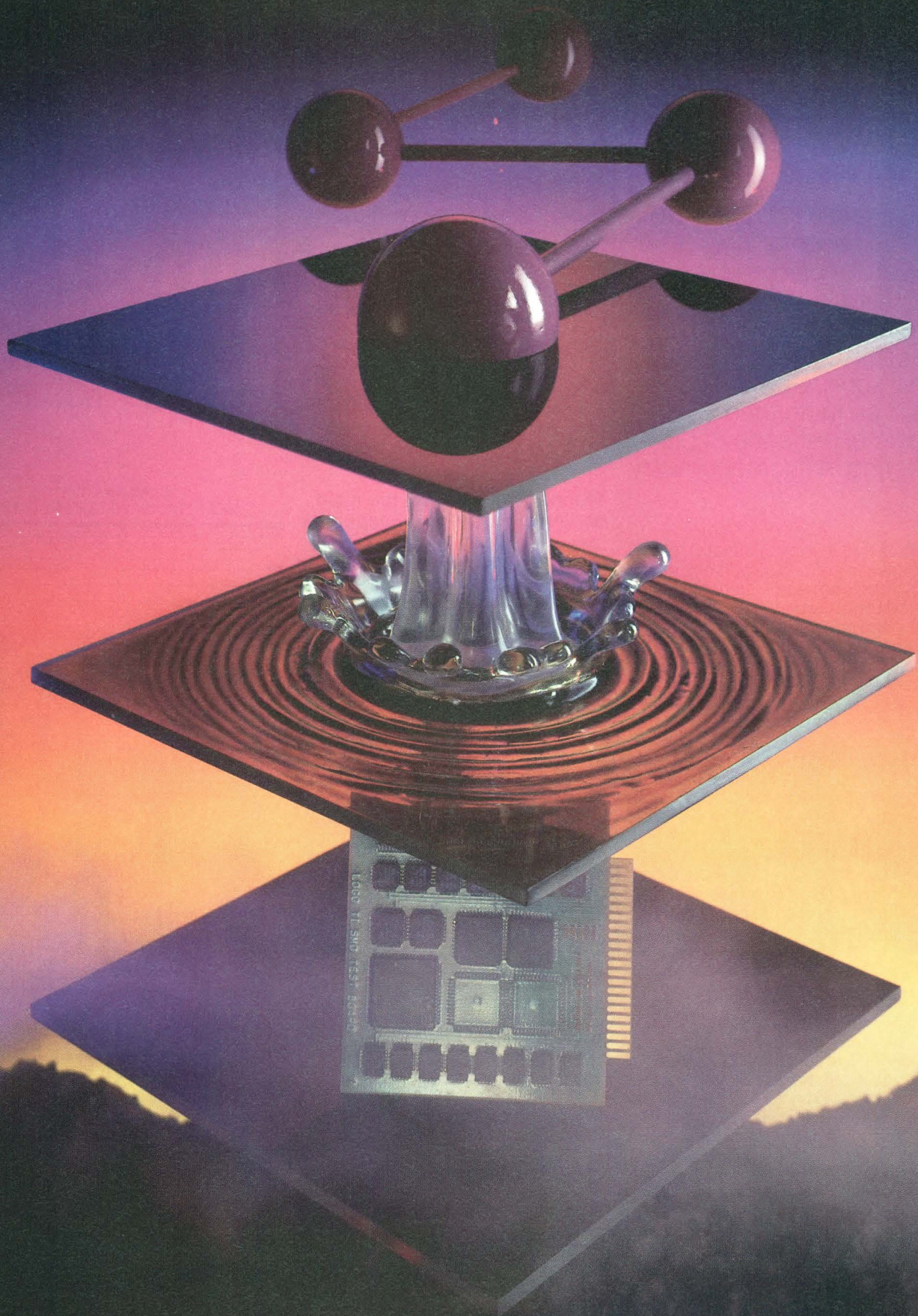

**Discover
Fluoronics Resources**

Fluorinert™ Liquids—products that power Fluoronics Resources

*Fluoronics Resources:

An exclusive 3M combination of innovative products backed by research and development, manufacturing expertise, technical data and service assistance built on more than 35 years' experience of pioneering in fluorochemistry.

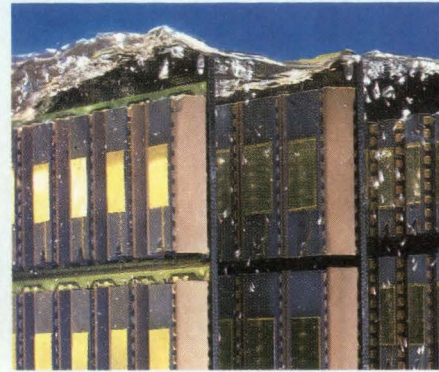

3M has had a whole generation of experience in the development, manufacture and refinement of perfluorinated liquids. We first introduced these versatile liquids to electronics design, testing and production professionals in the fifties. Since then, Fluorinert Liquids have become the mainstays in electronic cooling, high reliability testing and vapor phase soldering.

Fluorinert Liquids, used as a direct contact heat transfer medium, offer a range of physical properties that make them particularly suitable for electronic uses. They are non-polar and exhibit no solvent action. They are colorless, low in toxicity, non-flammable and offer exceptionally high dielectric strength plus thermal and chemical stability. Most important, they have almost no chemical reactivity and they evaporate without leaving a residue on parts.

Buy the numbers

Our FC™ numbers — FC-40, FC-70, FC-77, etc. — are used to identify Fluorinert Liquids that offer certain physical characteristics to meet specific application needs. These FC numbers are solely 3M designations for various fluorochemical products.

Fluorinert Liquids are being used cost-effectively in cooling, high reliability testing and vapor phase soldering operations. When you are interested in applying these versatile liquids in your own production, 3M can provide an abundance of technical information and support.

Technical assistance: the main benefit of Fluoronics Resources

3M offers prompt assistance to help you solve many production and testing problems. We provide comprehensive technical recommendations for specific fluids. We consult with you on the proper application equipment and help you evaluate production methods and results. Our service bulletins bring you up to date on the most recent advances in vapor phase soldering and high reliability testing. Ask us about 3M's audiovisual materials and on-site application training seminars.

Discover Fluorinert™ Liquids' heat transfer capability

What are your needs? A precise degree of temperature control? Fast, uniform heat transfer? High dielectric strength? Fluorinert Liquids offer the broad range of physical characteristics required in most applications.

Fluorinert Liquids are an effective direct contact heat transfer medium whether used in a liquid or vapor state. Their unique properties enable you to use them in contact with sensitive components and substrates.

Major differences between the various products in the Fluorinert Liquids family can be seen in their boiling points. These can range from 56°C to 253°C. Should you need products with intermediate boiling temperatures, the 3M staff will work with you to fashion a product especially for your needs. It's an example of how 3M's Fluoronics Resources provide you with "customized" service to solve special problems.

COMPARATIVE HEAT TRANSFER COEFFICIENTS

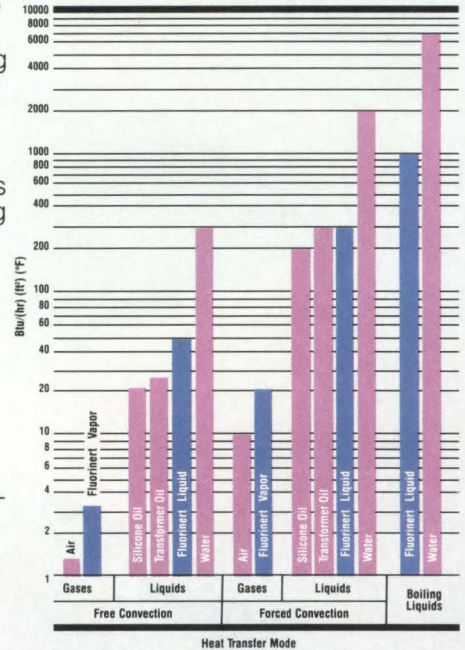

Fluorinert™ Liquids achieve accurate high reliability testing

It's a small world you work in. Where time ticks in nanoseconds and dimension is measured in Angstrom units. And as circuitry becomes more complex, a greater demand is placed on testing capability — not only in speed, but in higher reliability and accuracy.

Fluorinert Liquids meet those requirements by providing a controlled temperature environment and a high degree of electrical protection. They offer maximum compatibility between

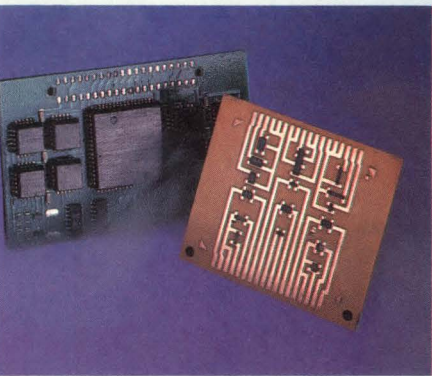

the heat transfer medium and the device under test. Fluorinert Liquids reduce testing costs by reducing testing time substantially. They do this by rapidly reaching test temperature and providing precise and uniform temperature control. You'll minimize the number of faulty units by detecting defects before they become rejects.

These liquids provide cost-effective tests such as gross leak, thermal shock, liquid burn-in, ceramic crack detection, electrical environmental, temperature calibration and failure analysis/short detection.

Fluorinert Liquids are specified in the MIL-STD's for thermal shock and gross leak testing.

THERMAL SHOCK TEST CONDITIONS

Military Standard 883-1011			Military Approved Fluorinert Liquids	
Test Condition	Hot Test Step 1	Cold Test Step 2	Hot Test Step 1	Cold Test Step 2
A	100°C	-0°C	Water, FC-40	Water, FC-40, FC-77
B	125°C	-55°C	FC-40, FC-70, FC-5311	FC-77
C	150°C	-65°C	FC-40, FC-70, FC-5311	FC-77
D	200°C	-65°C	FC-70, FC-5311	FC-77
E	150°C	-195°C	FC-40, FC-70, FC-5311	Liq, N ₂
F	200°C	-195°C	FC-70, FC-5311	Liq, N ₂

GROSS LEAK TEST CONDITIONS

Military Standards	Military Approved Fluorinert Liquids		
	Indicator Fluids	Detector Fluids	Absorption Fluids
MIL-STD 883-1014	FC-40, FC-43	FC-72, FC-84	Do not apply
MIL-STD 750-1071	FC-40, FC-43	FC-72, FC-84	FC-43, FC-75, FC-77
MIL-STD 202-112	FC-40, FC-43	FC-72, FC-84	Do not apply

Discover higher yields in vapor phase soldering

Fluorinert Liquids have been the industry's fluid of choice since the vapor phase reflow soldering (VPS) process was introduced in 1975. There are a number of good reasons for this universal acceptance. VPS with Fluorinert Liquids produces highly reliable solder joints. The system reduces reject rates, increases production, and lowers production costs. With Fluorinert Liquids, you can be assured that your products will never be exposed to a temperature higher than the selected liquid's boiling point. (See above)

You'll avoid those problems usually associated with other systems — shadowing, uneven heating, and overheating. The liquids are non-flammable. Their low surface tension helps them evaporate quickly from the work pieces without leaving a residue.

VPS with Fluorinert Liquids is especially suited for boards with high mass or complex geometries. The liquid vapors completely surround the assembly and penetrate remote recesses to heat all surfaces evenly. The vapors are 15 to 20 times heavier than air so they can be contained easily within the work area. The system offers an oxygen-free, non-corrosive environment to minimize rejects from oxidation contamination.

Some typical applications using Fluorinert Liquids in VPS include surface mounted leaded or leadless components, through-hole leads and wire-wrap pins, lead frame attachment, reflow of electroplated solder or tin and miscellaneous metal joining.

VPS SELECTION GUIDE

Fluorinert Liquid	Boiling Point	Typical Solders
FC-43	174°C/345°F	70 Sn/18 Pb/12 In 100 In 58 Sn/42 In 58 Bi/42 Sn
FC-70, FC-5311 FC-5312	215°C/419°F	63 Sn/37 Pb 60 Sn/40 Pb 62 Sn/36 Pb/2 Ag
FC-71	253°C/487°F	100 Sn 95 Sn/5 Ag 60 Pb/40 Sn

Discover the unique cooling benefits of Fluorinert™ Liquids

As the package size decreases, your need for more efficient heat dissipation increases in proportion. 3M Fluorinert Liquids are very efficient as a direct contact heat transfer medium, with the added advantage of having the high dielectric characteristics needed to meet stringent demands of the diversified electronics industry. We offer 11 liquids with boiling points that range from 56°C to 253°C.

These stable liquids allow you to maximize power density and miniaturize your package. Yet they reduce failure rates and increase reliability.

Fluorinert Liquids are used in such demanding applications as:

- Radar transmitters • Power supplies
- High voltage transformers • Lasers
- Radar klystrons • Computer modules
- Computer memories • Fuel cells

Typical properties of Fluorinert Liquids used in cooling are:

Fluorinert Liquid FC-77 (English Units)	Liquid		Vapor
	Room Temp. (77°F)	Boiling Point (207°F)	Boiling Point 207°F @/ATM
Density lb./ft ³	111	100	0.85
Thermal Conductivity Btu/(hr) (ft ²) (°F/ft)	0.037	0.033	0.008
Specific Heat Btu/(lb.) (°F)	0.25	0.28	0.23
Viscosity c.p.	1.42	0.46	0.02
Coefficient of Thermal Expansion ft ³ /(ft ³) (°F)	0.0008	0.0009	0.0015

Discover heating/curing with Fluorinert™ Liquids

Because they maintain their vapor temperature with absolute precision, Fluorinert Liquids can be used in many heating and/or curing operations. They serve as heat transfer media in solder mask and polymer thick film applications and for polymer processing. The non-corrosive vapors will not support oxidation. Ideal where solvent flash-off is a problem.

Discover Fluoronics Resources

3M presents a unique short course in the use of Fluorinert™ Liquids for the electronics industry.

3M is now offering a series of Applied Fluoronics™ tapes demonstrating how Fluorinert Liquids are used in a number of applications. See first hand how these remarkable products can improve overall electronic production.

Three cassettes are available:

1. "Applied Fluoronics: High Reliability Testing"
2. "Applied Fluoronics: Vapor Phase Soldering"
3. "Applied Fluoronics: Direct Contact Cooling"

These informative VHS format tapes are available to qualified personnel in the electronics industry. Specify which cassette(s) you would like to view.

Write on your company letterhead, describing your general interest. Mail to: Fluoronics Resources, Industrial Chemical Products Division/3M, Building 223-65E-04, 3M Center, St. Paul, MN 55144-1000.

For technical information or assistance on High Reliability Testing and Cooling, call 612/733-6282; for Vapor Condensation/Heating assistance, call 612/733-7424.

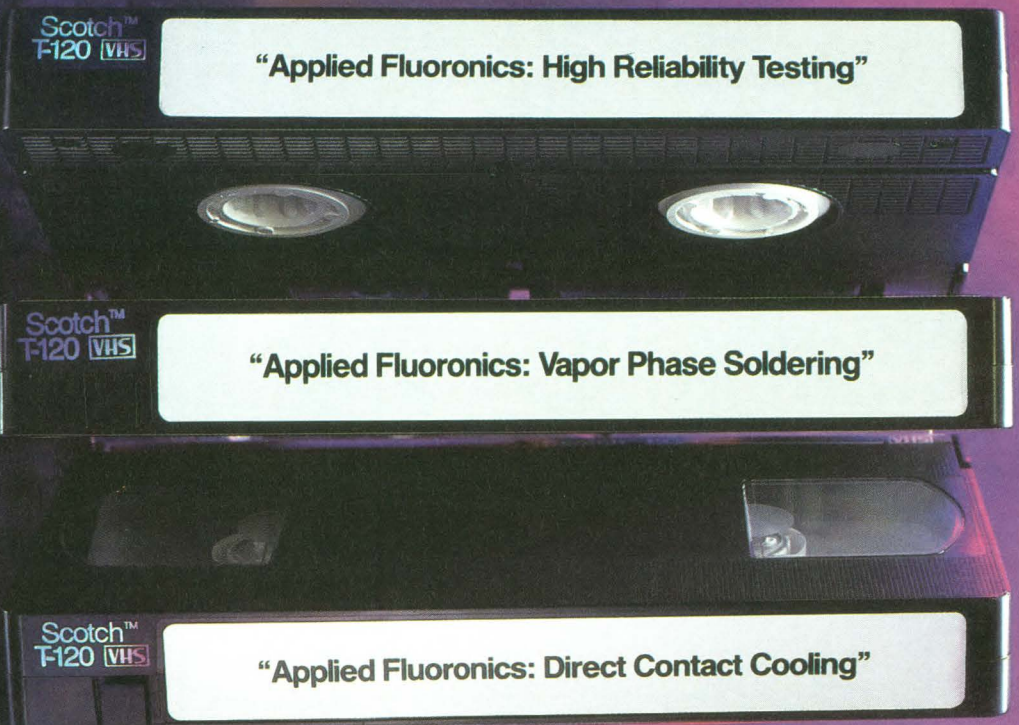

ELIMINATING FIRE RISK WITH PAPER!

Metallized plastic film capacitors

Rifa metallized paper capacitors

Without a capacitor, the power supplies or household appliances that you manufacture could cause radio frequency interference. With an unsafe capacitor, they could catch fire.

On average, such a cap has to take more than ten transient attacks a day. Consequently, the self-healing ability is decisive for a long life. But as the number of self-healings increases, so does the risk of breakdowns and short-circuits.

The ability to withstand high voltage transients is measured by a test called First self-healing. This is defined as a voltage drop of 5 V, and is executed periodically at the Rifa Laboratories in Kalmar, Sweden. For years, the outcome of this test has always been the same: 95% of metallized plastic film caps start self-healing at voltages lower than 3 kV; of

metallized paper caps made by Rifa, less than five percent.

This test is regarded as a realistic way to quantify the risk of short-circuits. To that, add another aspect. The type of damage that can occur in a plastic cap, resulting in the winding melting or glowing, is a far greater fire hazard than a similar occurrence would be in a paper type cap.

QUALITY IN OUR BOOK

In our book, QUALITY means meeting your customer's performance requirements, and he certainly doesn't expect your product to catch fire or cause interference with radio frequencies, does he?

When your quality reputation depends on quality capacitors.

RIFA
capacitors

USA: RIFA Inc
403 International Parkway, Suite 501
RICHARDSON, TEXAS 75081
Tel +1 214 480 8300 • Telefax 1 214 680 1059

CIRCLE NO 88



Rifa capacitors are made to meet the needs of practical applications, not just to come up to a standard.

So if you want all your products to perform faultlessly in any country, which capacitor do you choose?

To start with, send for our free brochure "Why Meeting Standards is Not Enough".

Please send the coupon to: RIFA AB
Box 945, S-391 29 Kalmar, Sweden

Please, send me my copy of your new brochure "Why meeting standards is not enough".

Name _____

Company _____

Address _____

Country _____

EDN041488

Please meet us at Electro Show Booth No. 225



MOTOROLA

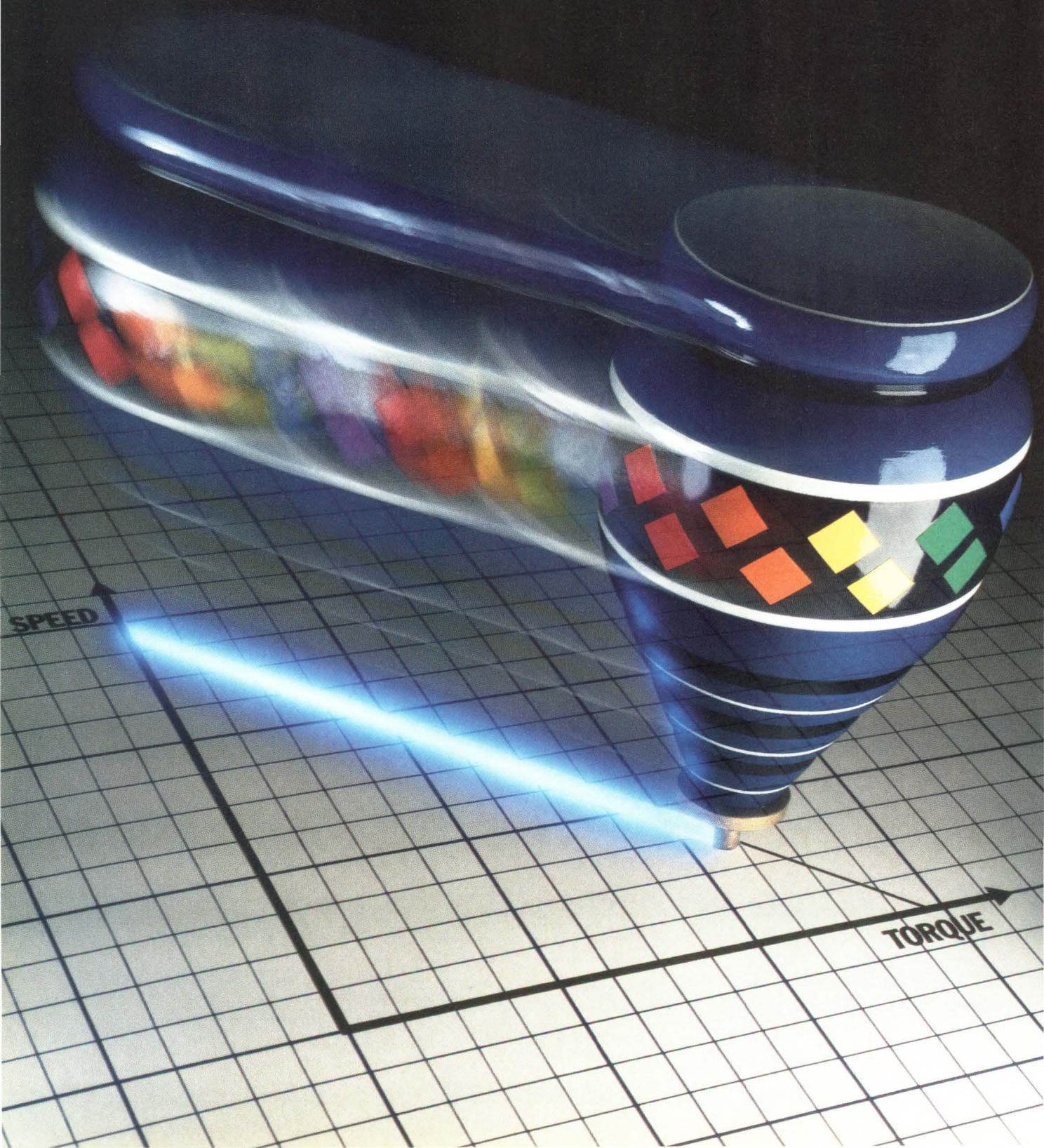

Top torque for brushless motors.

TMOS™ SenseFETs, two linear ICs produce perfect brushless motor torque at any time.

DC brushless motors accelerate instantly, run up to 100,000 rpm, are quiet, 90% or more efficient, reliable, safe, compact and often self-governing.

And they can provide precise, unwavering, linear output torque at any point from here to there, regardless of load or operating condition.

All because of state-of-the-art semiconductors like our SenseFET™ power transistors and linear motor controller and adapter ICs. They're smooth, silent and efficient. They replace the spit, bounce, screech, scratch, drag and doubt of brushes. And they add leading-edge economy, performance and simplicity to brushless motor control designs.

For perfect torque under pressure.

Start something exciting with an intelligent IC. MC33034.

The MC33034 has a mission—providing you with everything you need to implement a full-featured, open- or closed-loop, three- or four-phase motor control system.

Offering a high degree of ruggedness, it incorporates a rotor position decoder for proper commutation sequencing, a temperature-compensated reference capable of supplying sensor power, a frequency-programmable sawtooth oscillator, a fully-accessible error amplifier for speed/servo applications, a pulse width modulator comparator, three open-collector top drivers and three high-current totem pole bottom drivers ideally suited for driving power MOSFETs.

The MC33034 supplies power to Hall or rotor position sensors in brushless motors.

It's fully protected with cycle-by-cycle current limiting with a selectable, time delayed latched shutdown mode, internal thermal shutdown, undervoltage lockout, sensor open and short detection plus a fault output for interface to MPU systems.

Use it as the economical, all-in-one, main brain in open-loop speed control, forward or reverse direction, run enable and dynamic braking circuitry.

MC33039P. Solid-state tach for precise digital detection.

The MC33039P is the perfect substitute for costly closed-loop magnetic or optical tachometers to sense position and rpm.

Just 60¢, 1K-up, it detects each input transition for improved low-speed motor operation and can be powered directly from the MC33034.

Three input buffers, each with hysteresis for noise immunity, three digital edge detectors, a programmable monostable and an internal shunt regulator enhance

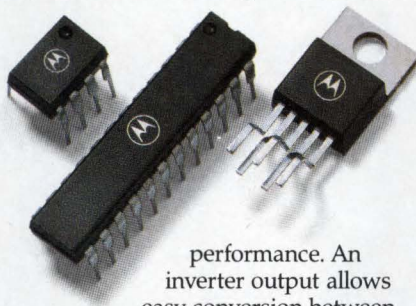

performance. An inverter output allows easy conversion between 60°/300° and 120°/240° sensor phasing conventions.

Drive brushless directly with fast, rugged, lossless SenseFETs.

Brushless motor drives are tough on powerFETs when freewheeling current is run through the drain-source diode and rapidly commutated by an opposite half bridge. But not with the MTP40N06M.

Its fourth-generation TMOS technology handles this potentially destructive stress up to full-rated current and breakdown voltage in nanoseconds. In other words, the 40 amp MTP40N06M is so rugged, commutating SOA and discrete diodes often needed in motor bridges can be forgotten.

It's also lossless, using a patented current-sensing technique that elimi-

nates power loss normally associated with power-hungry sense resistors.

And the device's sense terminals are easily OR'd together to feed a common sense input such as the MC33034's, making a clean and simple lower half bridge design.

Pull it together with all three.

An MC33034, an MC33039 and three MTP40N06Ms are yours free with the coupon... plus applications-oriented data sheets to help you put top spin on your new motor control design.

See it in action at IMAGINOLOGY.

The electronic adventure of the year is coming your way with the latest, hands-on semiconductor technologies, end products and seminars, including brushless motor control: Boston, April 4-6; San Jose, May 2-4; Dallas, June 22-24. Contact your Motorola representative.

One-on-one design-in help.

Call toll-free any weekday, 8:00 a.m.

1-800-521-6274

to 4:30 p.m., M.S.T.
Or write Motorola Semiconductor Products, Inc., P.O. Box 20912, Phoenix, AZ 85036.

We're
on your
design-in
team.



MOTOROLA

To: Motorola Semiconductor Products, Inc.
P.O. Box 20912, Phoenix, AZ 85036
Please send me a free Motorola Brushless Motor Control Design Kit.

355EDN041488

Name _____

Title _____

Company _____

Address _____

City _____ State _____ Zip _____

Call me (_____) _____



Annie Oakley/The Bettman Archive Inc.



One of the precise hand-held instruments that didn't need one of our cable assemblies.

Annie never missed. Well, almost never. As long as she was ahead of second best, the room for error was there.

Not so in the critical engineering of micro-miniature cable and connector solutions at Precision Interconnect. Tolerances are getting tighter, desired sizes smaller, and development time shorter.

Working with exact electrical requirements, plus challenging mechanical parameters,

we design and produce extremely reliable, long flex-life cable, with conductors terminated to standard connectors or active devices, and with protective flex-strain reliefs. These complete interconnect systems, usually using 30 AWG and smaller conductors, provide the critical link in hand-held applications on test and measurement equipment and medical diagnostic devices.

Our expertise, increasing with each unique problem we solve, ensures that reliability is designed in, built in, and tested. So we're right on target. Every time.



**PRECISION
INTERCONNECT**

16640 S.W. 72nd Avenue, Portland, OR 97224
(503) 620-9400

Offices in San Francisco, Boston,
Wilmington and Düsseldorf

High frequency probe provides matched impedance and matched time delay for a Tektronix logic analyzer.

CIRCLE NO 89

Equivalent circuits model subtle traits of advanced CMOS ICs

Subtle characteristics of an advanced CMOS logic IC's transistors, packaging, bypass capacitor, and load combine to affect the output waveshape. Some of the subtleties are inherent in the IC, but some are under your control. Learning to distinguish among these effects helps you differentiate device types and test and apply the ICs.

Charles Dike, *Signetics Corp*

You can model the outputs of advanced CMOS logic (ACL) as linear LRC networks and gain valuable information about the ICs' ground-bounce and overshoot characteristics. Using these networks, you can also evaluate and improve the test fixtures for the devices. This article compares two quad AND-gate devices: a Fairchild 74AC08 (date code 8619), which has corner-pin connections for V_{CC} and ground; and a Signetics 74AC11008 (date code 8639), which has center-pin V_{CC} and ground connections.

The test setup used to produce the waveform displays for the examples in the text uses a Hewlett-Packard Model HP-54110D digital oscilloscope equipped with 54003-61617 10:1 probes. The displays were produced by routing a screen dump to a plotter.

Switching all outputs together into a standard test load (50 pF in parallel with 500 Ω) produced the t_{PHL} and t_{PLH} waveforms in Fig 1 at the output farthest from the ground pin. This output typically exhibits the highest overshoot of any output. Notice that the outputs ring after switching, and that the ringing is a damped sinusoid in all cases. For both devices, the ringing frequency for the low-to-high transition is slightly lower than that obtained for the high-to-low transition.

Notice also that the center-pin 74AC11008 has less overshoot, its ringing damps out faster, and its ringing frequency—approximately 160 MHz—is higher than that of the 74AC08 (110 MHz). Relating overshoot, damping, and ringing frequency is the key to understanding the differences between the 74AC and 74AC11 families.

Equivalent circuits

Fig 2 models a 2-output ACL device and its test load. Bond wires from the leads of the package connect to the device's silicon die. Each of these leads and bond wires has some amount of inductance. Leads near the end of a DIP have more inductance than leads near the center of the DIP. When the outputs are in a low state, the PMOS transistors appear as an open circuit, and the turned-on NMOS transistors exhibit $\sim 8\Omega$ on-resistance. When the outputs assume a high state, the transistor states are reversed.

A single output in the low state appears in Fig 3a, where L_{OUTPUT} represents the output-lead inductance and L_{GND} represents the ground-lead inductance. The

Specifications for the magnitude of overshoot are incomplete without the ringing frequency.

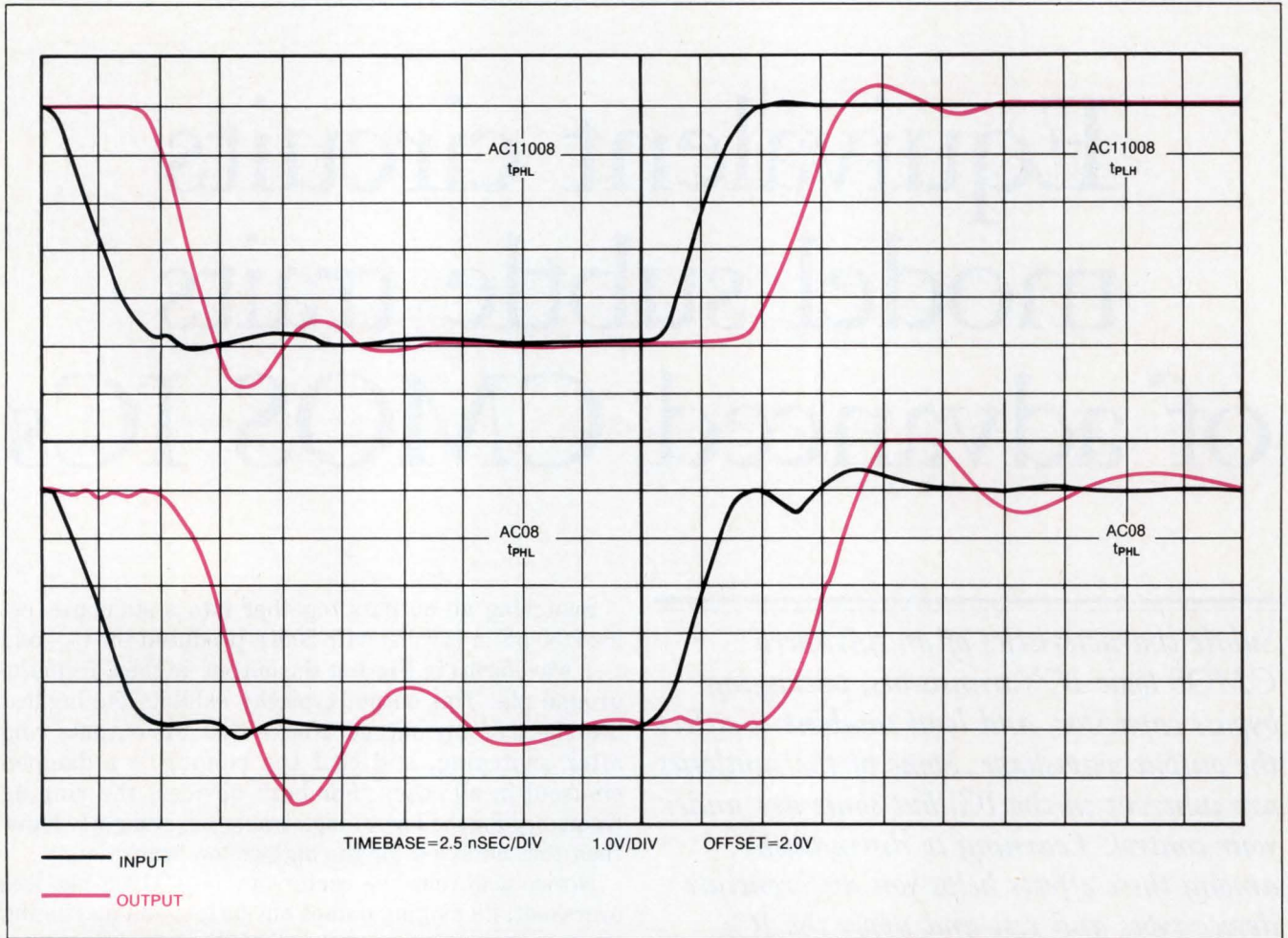

Fig 1—Switching all outputs together into a 50-pF/500Ω load produced these waveforms at the output farthest from the ground pin (HP 54110 digital scope). Notice that the outputs ring after switching, and that the ringing is a damped sinusoid in all cases. The ringing frequency for the low-to-high transitions is slightly lower than for the high-to-low transitions. The AC08 waveforms show some distortions because of reflections or a noisy ground.

frequency of oscillation of the center-ground and corner-ground circuits is the same, and calculations show that frequency to be about 205 MHz.

You can convert the circuits of Fig 3a to the circuit in Fig 3b and write the low-state transfer function as

$$\frac{V_{OUT}}{V_{IN}} = \frac{\frac{1}{LC}}{s^2 + \left(\frac{R_1}{L} + \frac{1}{R_2 C}\right)s + \frac{R_1 + R_2}{R_2 LC}} \quad (1)$$

The form of this equation is the classical

$$\frac{\omega_n^2}{s^2 + 2\zeta\omega_n s + \omega_n^2} \quad (2)$$

where zeta is the damping factor, and ω_N is the natural oscillation frequency. If $R_2 \gg R_1$, then

$$\zeta \approx \frac{R_1}{2} \sqrt{\frac{C}{L}} \approx \frac{R_1 C \omega_n}{2} \text{ and } \omega_n \approx \frac{1}{\sqrt{LC}} \quad (3)$$

The inverse Laplace transform is

$$V = \frac{R_2 \omega_n}{(R_1 + R_2) \sqrt{1 - \zeta^2}} e^{-\zeta \omega_n t} \sin(\omega_n \sqrt{1 - \zeta^2} t + \Theta) \quad (4)$$

This formula describes an exponentially decaying sinusoid—the waveforms of Fig 1.

The simple circuits of Fig 3 do not, however, explain all of the devices' behavioral traits. Because all outputs

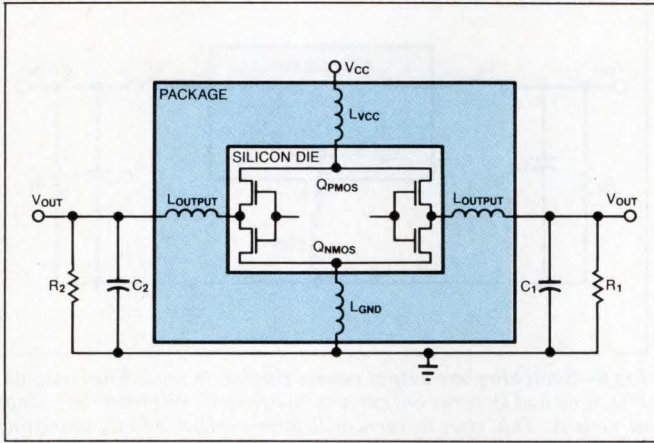

Fig 2—This ACL-device model has two outputs and a test load. Each of the device's leads and bond wires has some amount of inductance. Leads near the end of a DIP have more inductance than leads near the center of the DIP.

in the low state share a common ground inductance, you cannot model them as independent circuits. **Fig 4a** depicts two outputs on a part that has a center-pin ground. The two 8Ω resistors represent the on-resistance of the transistors.

Fig 4b is the Thevenin equivalent of the first circuit. Calculations show that its ringing frequency is about 190 MHz. By extension, **Fig 4c** shows the equivalent circuits for the two quad AND-gate devices. The quad center-ground device rings at about 168 MHz, and the corner-ground device rings at about 110 MHz. Note that as the number of outputs increases, the frequency of oscillation and the total inductance in the circuit decrease.

The high-state circuit is similar to the low-state circuit, but exhibits some interesting differences. **Fig 5a** shows a single high-state tank circuit. C_1 is the bypass capacitor between V_{CC} and ground. **Fig 5b** shows the tank circuit's Thevenin equivalent. This circuit has more inductance than the circuit in **Fig 3** because of the bypass capacitor's inductance (L_{BY}). This added inductance causes the ringing frequency of the low-to-high transition to be lower than that of the high-to-low transition.

The high-state transfer function for this circuit is

$$\frac{V_{OUT}}{V_{IN}} = \quad (5)$$

$$\frac{R_2 C_1 s}{(R_2 L C_1 C_2) s^3 + (L C_1 + R_1 R_2 C_1 C_2) s^2 + (R_2 C_1 + R_2 C_2 + R_1 C_1) s + 1},$$

but because in this case

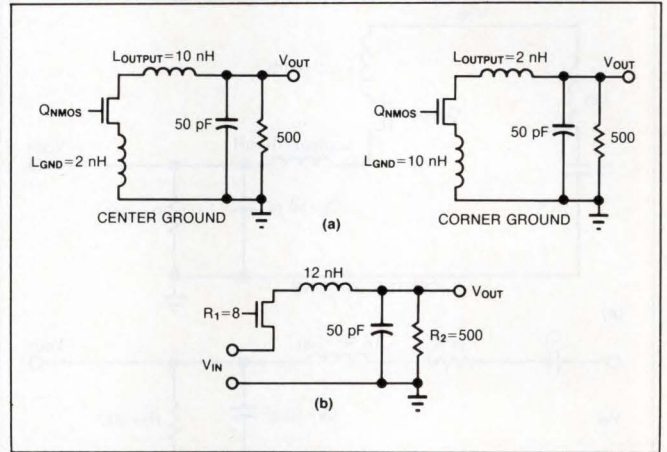

Fig 3—Equivalent circuits for center-ground and corner-ground ICs show that the equivalent series inductance is the same for both package styles. For single-section operation, therefore, the frequency of oscillation is the same for both.

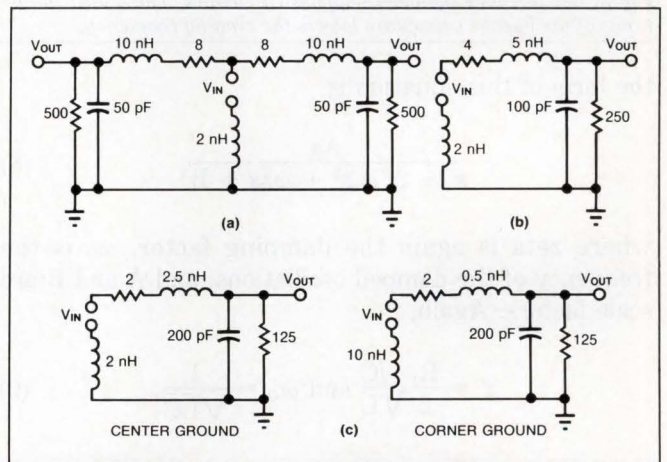

Fig 4—The simple circuits of **Fig 3** do not explain all of the devices' characteristics. Because all outputs in the low state share a common ground inductance, you cannot model them as independent circuits. In **a**, you see two outputs on a part that has a center-pin ground. The two 8Ω resistors represent the on-resistance of the transistors; **b** is the Thevenin equivalent of the circuit in **a**. Finally, **c** shows the equivalent circuits for quad AND-gate devices.

$$LC_1 \ll R_1 R_2 C_1 C_2 \text{ and } R_2 C_2 \ll R_2 C_1 + R_1 C_1$$

$$\frac{V_{OUT}}{V_{IN}} \approx \frac{R_2 s}{(R_2 L C_2) s^3 + R_1 R_2 C_2 s^2 + (R_2 + R_1) s + \frac{1}{C_1}} \quad (6)$$

or

$$\frac{V_{OUT}}{V_{IN}} \approx \frac{\frac{s}{L C_2}}{s^3 + \left(\frac{R_1}{L}\right) s^2 + \left(\frac{R_2 + R_1}{R_2 L C_2}\right) s + \frac{1}{R_2 L C_2 C_1}}, \quad (7)$$

Relating overshoot, damping, and ringing frequency is the key to understanding the differences between the 74AC and 74AC11 families.

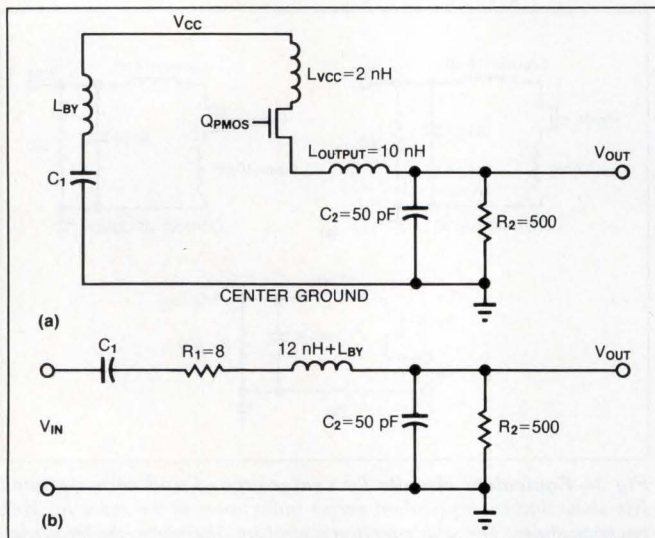

Fig 5—The high-state circuit is similar to the low-state circuit of Fig 3, but includes the device-bypass capacitors. The added inductance of the bypass capacitors lowers the ringing frequency.

the form of this equation is

$$\frac{As}{s^3 + 2\zeta\omega_0s^2 + \omega_0^2s + B} \quad (8)$$

where zeta is again the damping factor, ω_0 is the frequency of the damped oscillations, and A and B are scale factors. Again,

$$\zeta \approx \frac{R_1}{2} \sqrt{\frac{C}{L}} \text{ and } \omega_0 \approx \frac{1}{\sqrt{LC}} \quad (9)$$

From the preceding math, you can see that the bypass capacitor does not significantly affect either the frequency of oscillation or the damping, provided that it's much larger than the load capacitance. However, the inductance of this capacitor can add considerably to the overall loop inductance.

For a center-pin configuration, the V_{CC} and ground pins are 300 mils apart for any size DIP. On a corner-pin part, the V_{CC} and ground pins are a minimum of 670 mils apart for a 14-pin DIP. Although you might expect a ground plane to eliminate the greater lead inductance of a capacitor that must span the corner-pin device's larger spacing, in fact, the ground plane has inductance between any two points. Eq 1 makes it clear that minimizing inductance increases damping and reduces ringing amplitude.

All outputs on a part are interdependent. This interdependency causes ringing in unswitched outputs. In

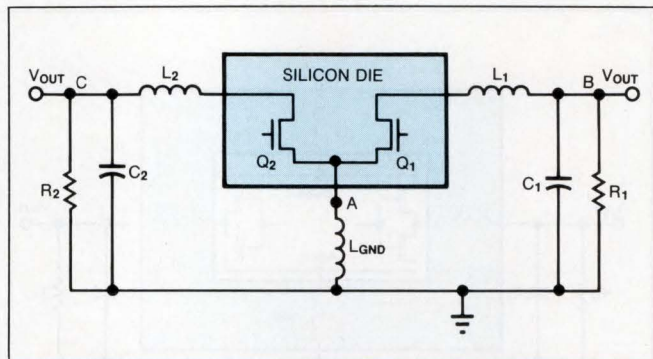

Fig 6—Switching one output causes ringing in unswitched outputs. If Q_2 is on and Q_1 turns on, current flow from C_1 will raise the voltage at node A. This rise, in turn, will force current into C_2 , initiating ringing.

Fig 6, assume that Q_1 has just turned on and that node B is still at 5V. Also, assume that Q_2 has been on for some time, so that node C is at 0V. Q_2 drives the unswitched output.

As current begins to flow from C_1 (at node B) through L_1 , Q_1 , and L_{GND} , node A's voltage begins to rise and node B's begins to drop. The rise in node A's voltage causes current to flow from node A through Q_2 and L_2 into C_2 . The voltage at node C then rises above ground.

As the voltage at node B drops, the rate of change of current through Q_1 stops increasing and begins to decrease. This decrease causes the voltage at node A to reverse polarity and begin to draw current from C_2 . Because node A goes negative with respect to ground, nodes C and B will follow. Eventually, the rate of change of current reverses yet again, and this cycle continues until the circuit resistances dissipate all the energy stored in the inductors and capacitors.

Ground bounce

When more outputs switch in parallel with Q_1 , the rate of change of current increases and the voltage at node A rises, and this rise causes the voltage at node C to rise. The outcome is that more energy is stored in storage elements, causing the overshoots to be higher and the system to ring longer. How can the overshoot be reduced? One way to make L_{GND} as small as possible is to use the center-pinout configuration.

Fig 7 displays the worst-case ringing at the unswitched output that occurs when all other outputs are switching high to low.

In addition to the mechanism described in the preceding section, another mechanism contributes to overshoot in unswitched outputs. That mechanism is mutual inductance. In **Fig 6**, mutual inductance between L_1 and

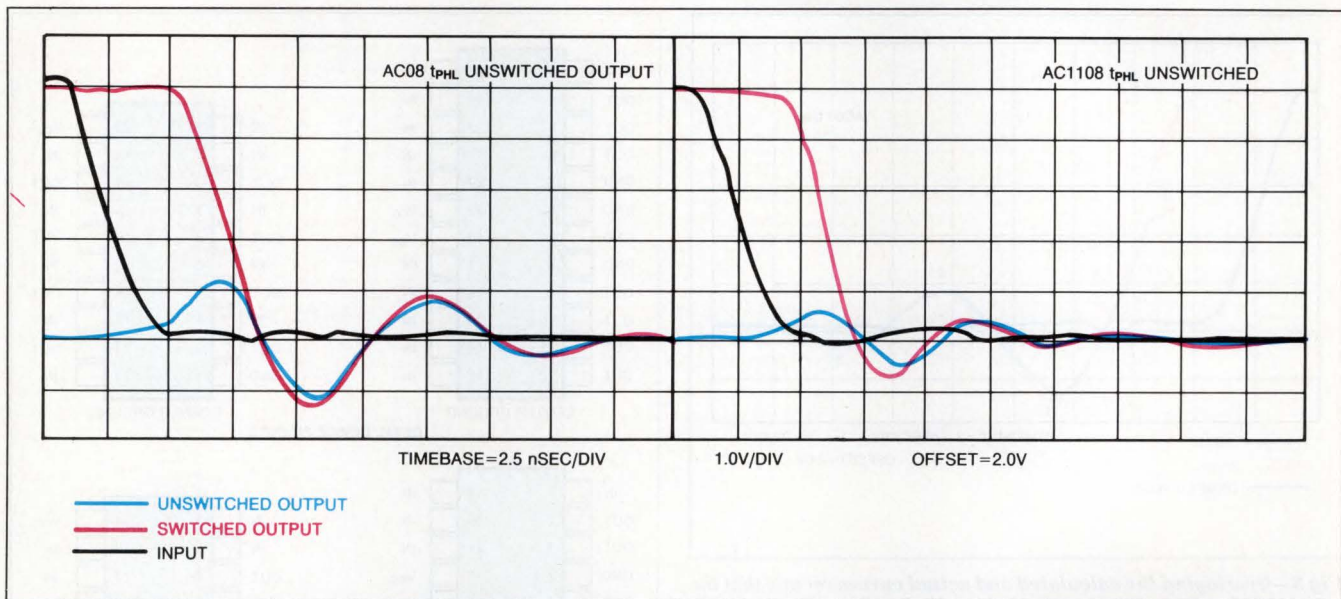

Fig 7—Switching all other outputs high to low produces the worst-case unswitched-output ringing. Observe that the initial bounce is lower for the AC11008 than for the AC08.

L_2 couples energy from one inductor to the other during the transition. This coupling affects the overshoot. The magnitude of the effect depends on the proximity of L_1 to L_2 , and the polarity of the effect depends on the relative direction of the change of current through the output pins. The unswitched output will be affected most if it is adjacent to a switched output that has a high current slew rate.

In real applications, additional factors complicate the simple models in Figs 2 to 6. For example, the simple models assume that all output-pin inductances are the same. In fact, the output-pin inductances for a 16-pin DIP can vary from ~ 3 to ~ 10 nH.

As long as all outputs switch simultaneously and in the same direction and end up in the same state (either low or high), then they will ring at nearly the same frequency—each output rings at a frequency within $\sim 10\%$ of the highest frequency. This frequency is the package's ringing frequency. However, because each output pin's inductance is different, each one stores a different amount of energy. This difference causes the outputs that have the largest inductances to ring to higher amplitudes.

Another complication occurs when one or more outputs remain high while the rest switch to a low state. For a short interval, an output in transition has both its lower and upper output transistors turned on simultaneously. This condition causes a current to pass through the V_{CC} inductance, both transistors, and the

ground inductance.

Because the V_{CC} inductance stores this energy, it must be dissipated in a tank circuit similar to the circuit in Fig 5, and ringing occurs on the unswitched high output because of a high-to-low transition. Again, the switched-output circuit is similar to the circuit in Fig 3. These circuits have no common elements (except mutual inductance), so they can ring at different frequencies. These frequencies depend, in a complex manner, on which outputs remain high and which outputs switch. And they usually will be higher than the package-determined ringing frequency. (Although the examples have dealt with outputs switching high-to-low, the same logic applies to low-to-high transitions.)

Compare measurements and models

Whatever the cause of the ringing, any ringing-output waveform should display an essentially pure, exponentially damped sinusoidal shape. This shape should be independent of the ringing frequency, but the damping should increase with the ringing frequency. Fig 8 overlays calculated and measured curves. Note that the initial peak of the model does not reach the initial voltage of the measured data. This discrepancy arises because the formulas rely on a constant-resistance model for the transistor. This model can be far from accurate when the voltage across the transistor exceeds a couple of volts or when the transistor is turning on. In actual practice, both situations apply.

Because all outputs in the low state share a common ground inductance, you cannot model them as independent circuits.

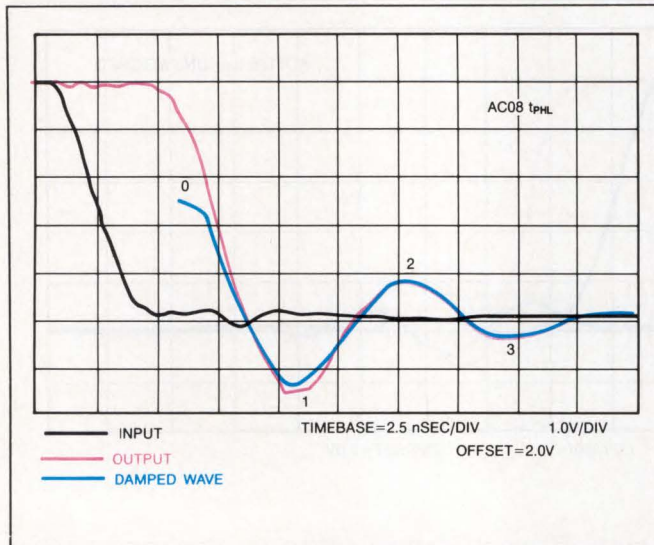

Fig 8—Overlaying the calculated and actual curves reveals that the initial peak of the model's prediction does not reach the initial voltage of the measured data. This discrepancy arises because the formulas rely on a constant-resistance model for the transistor.

These situations do not last long (until V_{OUT} reaches about 2.5V) before the circuit approximates the constant-resistance model.

The formula for zeta (Eq 1) states that for a fixed capacitance, increasing the resistance or reducing the inductance will increase the damping factor. This increase, in turn, reduces the overshoot. Zeta has a greater sensitivity to changes in R_1 than it has to changes in L . However, because ACL outputs must maintain a V_{OL} of 0.5V over a wide range of temperatures and power-supply voltages while sinking 24 mA, device designers fix the individual transistor resistance (at room temperature and $V_{CC}=5V$) at about 8Ω .

For the center-pin quad-AND device in a DIP, our target zeta result is

$$\zeta = \frac{8}{2(4)} \sqrt{\frac{0.2}{4.1}} = 0.221, \quad (10)$$

for approximately 49% overshoot. The 4.1-nH value is from Table 1. The 4 in the denominator represents four outputs. For the corner-pin package, zeta equals 0.150 (for ~62% overshoot). A side benefit of reducing the inductance is that the edge rates increase. This increase, in turn, yields somewhat shorter propagation delays.

Another way to reduce overshoot is to slow down the turn-on of the transistor and the edge rate. This slow-

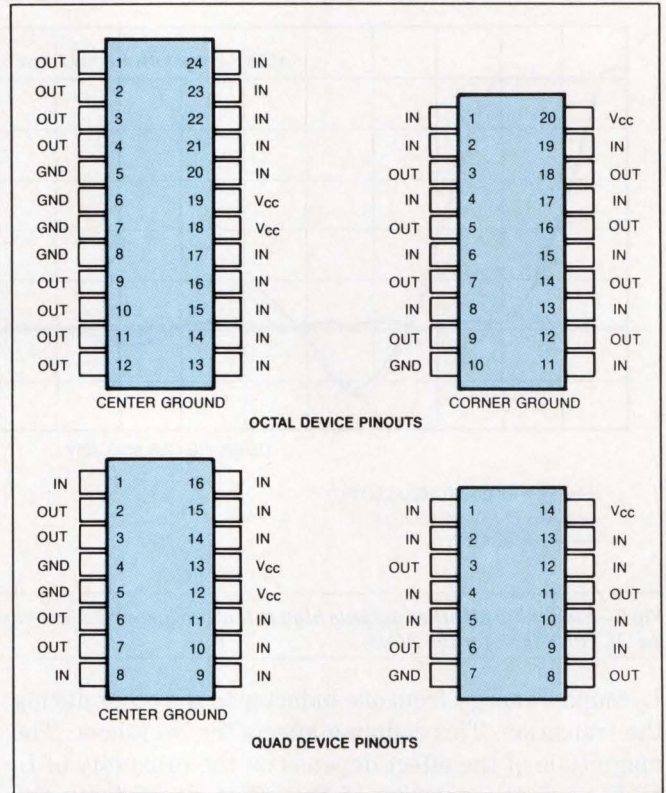

Fig 9—These pinouts are used to obtain the inductances in Table 1. The packages shown reflect the industry-standard pinouts for octal and quad logic families.

TABLE 1—PACKAGE LOOP INDUCTANCE

	OCTAL DIP 300 MIL	QUAD DIP 300 MIL	OCTAL SO 300 MIL	QUAD SO 300 MIL	QUAD SO 150 MIL
CORNER	13.1 nH	8.9 nH	8.2 nH	6.4 nH	4.1 nH
CENTER	4.4 nH	4.1 nH	2.8 nH	3.0 nH	2.1 nH

down, in turn, lengthens the propagation delay. All producers of ACL use this approach to control overshoot when simultaneous-switching problems arise; however, products that have reduced inductance can employ this approach more effectively.

At low temperatures, the overshoot will increase for two basic reasons. First, the resistance of the turned-on transistor is lower, thereby causing zeta to decrease. Second, the signal at the gate of the transistor switches more rapidly, thereby causing the transistor to turn on faster. The ringing frequency over temperature, however, will remain the same except for small variations caused by changing damping considerations.

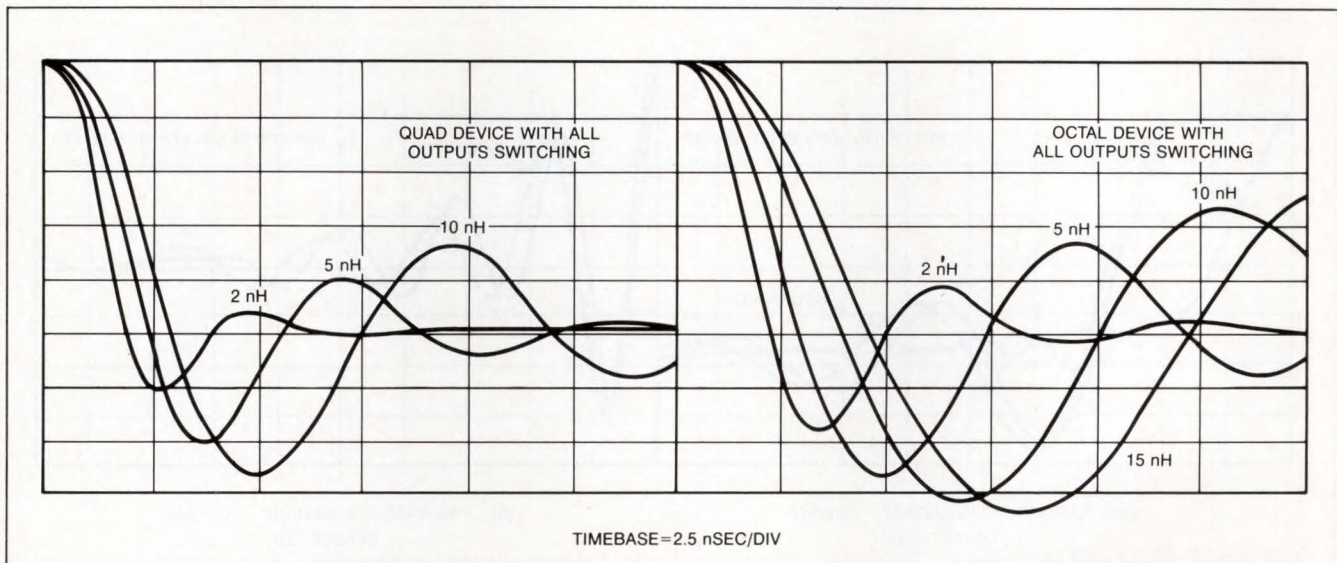

Fig 10—Quad and octal devices exhibit differing inductances. These inductance differences translate to variations in the ringing frequencies.

The primary problem in testing products is that the characteristics of both the device under test (DUT) and the test fixture (including the measurement system) influence the measurements taken. Armed with the results of the simple models given here and keeping in mind the additional complicating factors, you will be able to separate the DUT's performance from artifacts introduced by the test fixture.

To correlate information obtained from differing test fixtures, you must be able to somehow compensate for their differences. **Table 1** shows the inductances derived from simulations of various packages on an idealized test fixture that has 50-pF capacitors on each output. The idealized setup has no parasitic capacitances, a zero-resistance current path (except for the 500Ω resistor in each load and the transistors' on-resistances), and no spurious inductive coupling. **Fig 9** shows the pinouts used to obtain the inductances given in **Table 1**.

The output pins that have the lowest individual output-lead inductance will ring at the idealized package ringing frequency, whereas those that have the highest inductance will tend to ring at about a 10% lower frequency. **Table 2** shows that the center-pin configuration can ring at about a 50% higher frequency than the corner-pin configuration; consequently, the center-pin part will have less overshoot, which will damp out faster than will the overshoot for the corner-pin part. Measurements taken on octal DIP parts have shown that the idealized package ringing frequency,

TABLE 2—IDEAL PACKAGE RINGING FREQUENCY

	OCTAL DIP 300 MIL	QUAD DIP 300 MIL	OCTAL SO 300 MIL	QUAD SO 300 MIL	QUAD SO 150 MIL
CORNER	70 MHZ	119 MHZ	88 MHZ	140 MHZ	176 MHZ
CENTER	120 MHZ	176 MHZ	150 MHZ	205 MHZ	246 MHZ

based on the simple model, is optimistic. The center-pin octal part rings at about 100 MHz, and the corner-pin octal part rings at about 50 MHz.

Less-than-optimal tests

Several things contribute to the existence of less-than-optimal conditions on a test fixture—some you can address, others you cannot. The ringing frequency and waveshape considerations combine to provide a tool that will allow you to improve your test fixture and to correlate your measurements with measurements made on other test fixtures.

Many test fixtures are universal designs in which the load is located some distance from the device under test. This distance allows you to modify the load by using shorting strips, and to adapt the test fixture to a variety of package widths. This adaptability provides a reasonable way to minimize incoming-inspection costs if you recognize the tradeoffs. Because the load is not as close as it could be to the device under test, inductance

All outputs on a part are interdependent. This interdependency causes ringing in unswitched outputs.

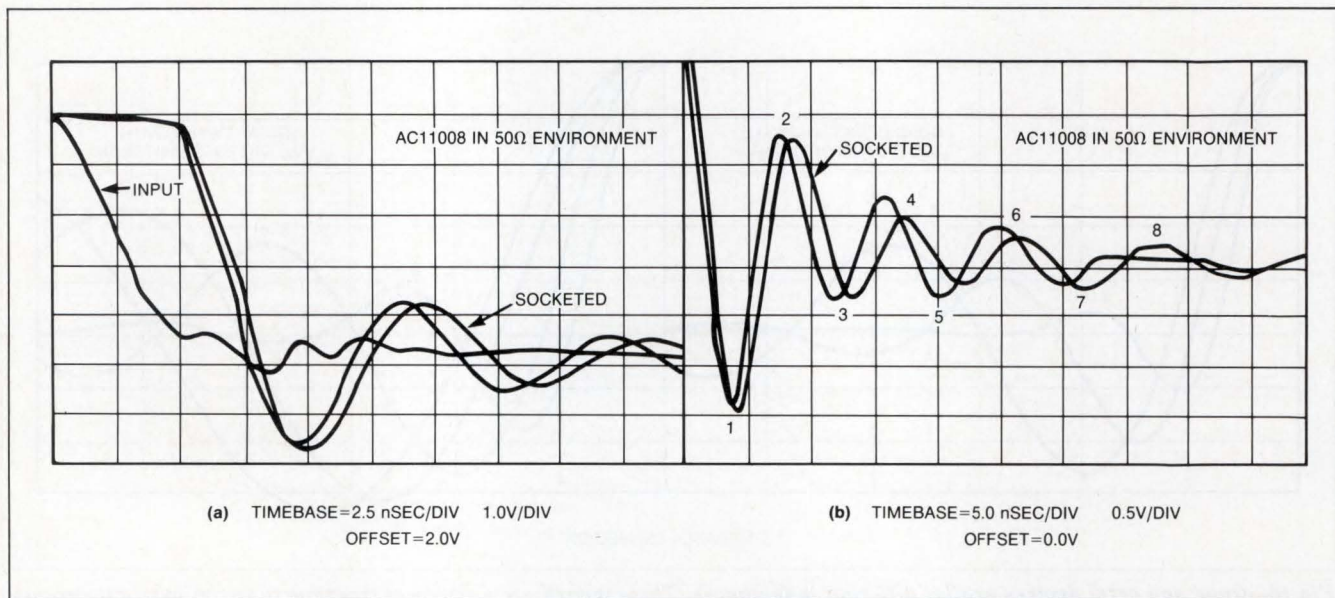

Fig 11—Adding a socket to a test setup alters device waveforms adversely. Propagation time and overshoot increase, and the ringing frequency decreases.

increases. **Fig 10** shows the ringing waveforms of a quad device and an octal device that have different inductances.

A quick review of **Fig 8** shows that the quad device's 10-nH waveform (~110 MHz) in **Fig 10** is an excellent representation of the ringing of the 74AC08, and the quad device's 5-nH waveform (~150 MHz) matches reasonably well with that of the 74AC11008. The 74AC11008 deviates from the model's prediction because it has an on-resistance of 6.5Ω—instead of 8Ω—per transistor. The package ringing frequency of the 74AC11008 is 160 MHz instead of 150 MHz.

Specifications for the magnitude of overshoot are incomplete without the ringing frequency. The following formula shows the relationship between damping and the percent of overshoot (PO):

$$PO = 100 \exp\left(\frac{-\zeta \pi}{\sqrt{1 - \zeta^2}}\right). \quad (11)$$

But, of course, damping is also a function of frequency. The formula describes the percentage by which point 1 of **Fig 8** overshoots the ground when falling from point 0; unfortunately for correlation purposes, as the frequency of oscillation increases, point 0 tends to fall. The amount point 0 falls is a function of the output-circuit design—a factor beyond your control.

Fig 11a demonstrates the effects of changing inductance on an AC11008 measured on a 50Ω-impedance

test fixture. To increase inductance, a low-profile socket was added to the test fixture. Immediately obvious are the ~250-psec increase in the propagation time and the lower ringing frequency of the socketed device. The amplitude of the first overshoot is greater than that of the unsocketed device. This result also meets our expectations.

But, you might ask, where is the exponential decay? Because the frequency is ~120 MHz, the inductance must be ~8.8 nH. This inductance, in turn, fixes zeta at ~0.122 ($R=6.5\Omega$), a figure that indicates the overshoot should be near 65%. But from point 1 to point 2 of **Fig 10b**, the overshoot is nearly 85%. This amount of overshoot is not physically possible from the device alone, and demonstrates a test-fixture problem. Something related to the test fixture is causing either the effective ground to shift, or the overshoot's amplitude to be distorted. At any rate, the overshoot measurements are not reliable.

Further investigation of **Fig 11b's** extended waveform shows that points 3 and 6 have the same height, and point 8 is missing on the unsocketed device—a sign of more signal corruption by the test fixture. Test fixtures that have a large amount of distributed capacitance develop spurious, contaminating tank circuits whose responses beat against the output signals in a complex manner. The differences between the two signals—not far removed in frequency—in **Fig 11** demonstrate this effect. To ensure signal integrity, you

WE'LL SHOW YOU WHAT NO ONE HAS EVER SEEN BEFORE

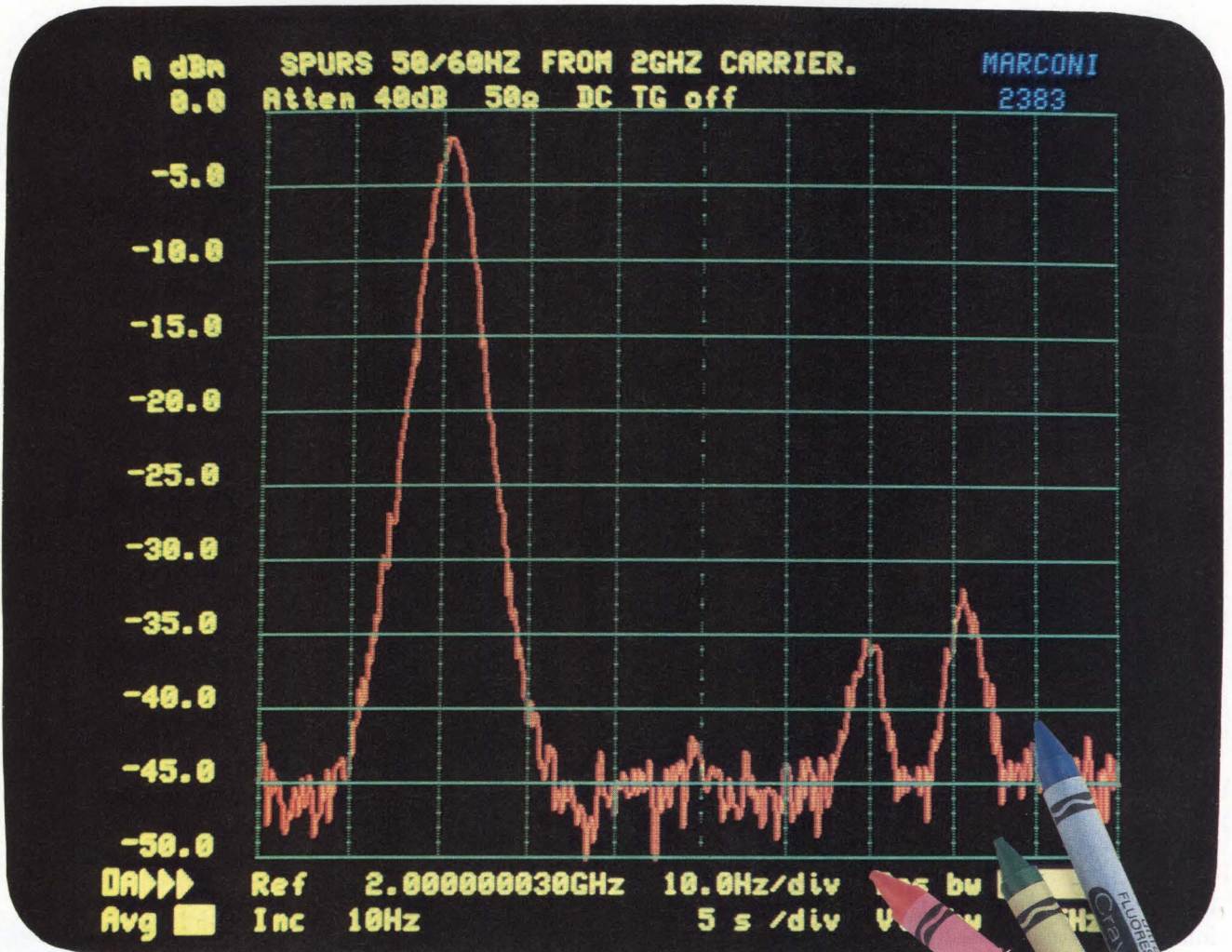

AND WE'LL COLOR IT, TOO!

With A 3 Hz Filter That Provides A New Industry Standard Of Resolution For Close-In Performance...

The user friendly Marconi Model 2383, 100 Hz to 4.2 GHz Spectrum Analyzer with built-in tracking generator establishes a new standard of high accuracy, resolution and stability of measurements. The automatic self calibration routine provides exceptional RF level accuracy of ± 1.5 dB at 4.2 GHz from

+ 27 dBm to -130 dBm. Close-in performance is unmatched with a 3 Hz filter and 1 Hz frequency resolution.



4.2 GHz Spectrum Analyzer—Model 2383

See us at ELECTRO Booths 2509 and 2511

With numerous high performance display functions, dynamic trace, limits memory, RGB drive, GPIB, plus limits masking. The 2383 is at your command for demanding spectral analysis requirements.

For a demonstration or details contact: Marconi Instruments, 3 Pearl Ct., Allendale, NJ 07401.
• (800) 233-2955 • (201) 934-9050
• In Canada (514) 341-7630

Marconi
Instruments



One way to make the DIP's lead inductance as small as possible is to use the center-pinout configuration.

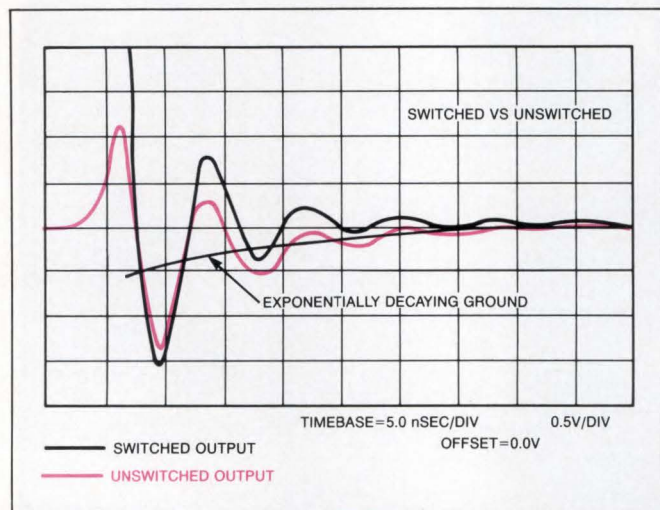

Fig 12—A miscalibrated high-impedance probe can also distort output waveforms—in this case, it introduces an exponentially decaying ground reference.

must reduce distributed capacitance in the load until the output of the device under test rings in a damped sinusoidal pattern.

In addition to frequency considerations, you should address distortions arising from reflections or a noisy ground. These distortions are more likely to occur on a test fixture that has higher inductances. Distortions can show up in even the best corner-pin packages. The AC08 waveforms in Fig 1 show some distortions on the sinusoidal waveform because of this problem.

Further test-fixture clues

You can gain further insight into the effectiveness of your measurement system by comparing a switched output to an unswitched output. When an output switches from high to low, the induced ringing should be centered about the ground. Any offset from ground indicates a problem in the measurement system. This problem could be a simple dc offset, an exponential-curve distortion (arising from improperly calibrated test probes), superimposed noise from the test-equipment power supplies, or perhaps other problems.

Although it is beyond the scope of this article to address these problems, a simple calibration aid can determine whether any of these problems exist. Simply switching three outputs of an AC11008 high to low, for example, while holding one low, will uncover the problem. Because the unswitched output has no dc component, it rings about ground when the switched outputs change. But the switched outputs change their dc component drastically, and can cause an offset from

ground that decays exponentially toward ground. This effect is probably the problem in Fig 11, where the 50Ω environment is excessively capacitive, as well as in Fig 12, where a high-impedance probe is excessively inductive.

Figure of merit

Any system that produces a clean, exponentially damped sinusoidal output waveform that oscillates about ground when all the outputs are simultaneously switched high to low should produce problem-free output waveforms under any conditions. The oscillation-characteristics data you collect for the outputs of an ACL device will prove useful for determining how optimal a test fixture is for other product families—for instance, bipolar devices. A test fixture optimized for ACL-family devices is also optimized for high-speed bipolar devices.

EDN

Acknowledgment

This article is based on a study of ACL output characteristics completed by Edward A (Ted) Burton and the author. A package-modeling program written by Dr Robert C Burton calculated the inductances. The author could not have written this article without their contributions.

Author's biography

Charles E Dike is a senior design engineer for Sigmetics Corp in Orem, UT. He has been with his present employer for 10 years. He obtained a BSEE and MSEE at Brigham Young University. In his spare time he enjoys reading and skiing.

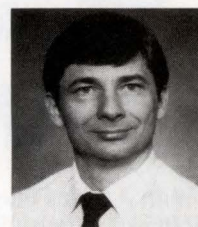

Article Interest Quotient (Circle One)
High 482 Medium 483 Low 484

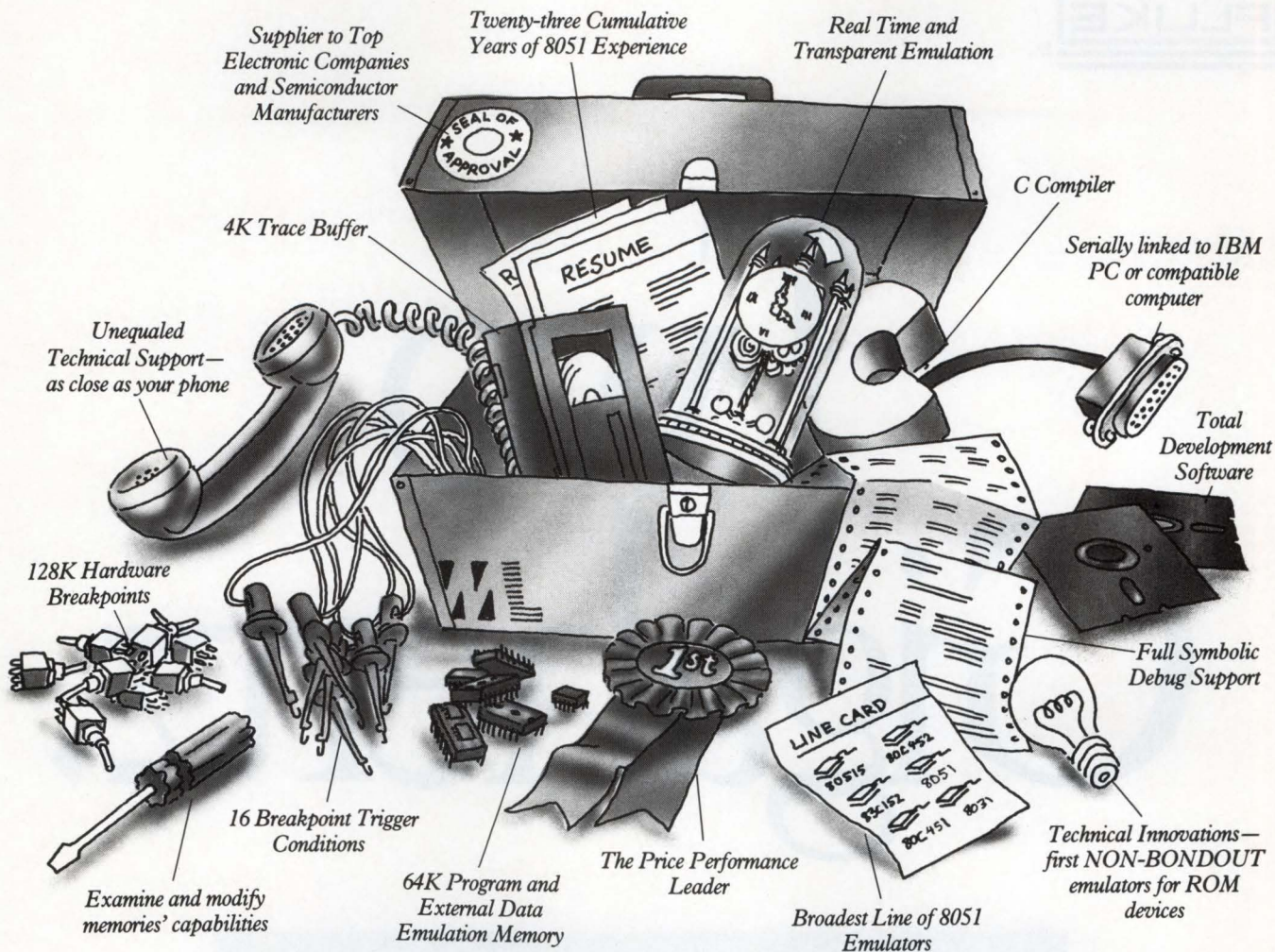

THE 8051 TOOLBOX.

PC-HOSTED EMULATORS AND SUPPORT FROM \$1495.*

Want the right tools for your 8051-family job? You'll find them inside MetaLink's 8051 toolbox: complete In-Circuit Emulation hardware, software and thoughtware. A toolbox that lets you plug your PC into MetaLink's cost-effective, high-performance 8051 family of development tools.

Why get your toolbox from MetaLink™? We understand just how to get the best design performance from your application—and to meet engineering budgets and quality standards.

Call MetaLink for your demo diskette to evaluate the capabilities of our MetaICE™ units. Or, for qualified customers, we offer a free, 10-day trial.

MetaICE		MicroICE
-80515	-80512	-8031
-83C152	-80532	-8032
-80C451	-80C552	-8344
-8044	-80C652	-80252
-80C452	-83C451	-80154
-80535	-83C751	-8052

FOR FREE 8051 FAMILY POCKET REFERENCE GUIDE:



MetaLink
Corporation

MetaLink Corporation
P.O. Box 1329, Chandler, AZ 85244-1329
(602) 926-0797 or (800) METAICE
IBM and PC are trademarks of International Business Machines Corp.

* Price is U.S. list



Two Gigahertz.



Fluke 6062A Signal Generator.

\$10,750.

Sure, for out-of-band testing, the HP 8642B is an excellent 2GHz signal generator. But for many other applications, the Fluke 6062A may fit your needs just as well. At nearly 1/3 the price.

Choosing the right 2GHz programmable RF signal generator doesn't have to be a painful decision. You have two good choices... at two very different prices.

For off-channel testing, where spectral purity is critical, the \$31,500 HP 8642B is a good choice, despite the bite it takes from your budget.

But for many applications, Fluke has a painless alternative: The 6062A 2GHz Signal Generator. At nearly one-third the price, it may be the best signal generator for your application, not to mention your budget.

Where pulse modulation performance is important, the 6062A simply leaves the HP 8642B behind. With a rise/fall time of 15ns and on/off ratio of 80dB at all frequencies, the 6062A has what it takes to meet your most demanding system requirements.

And when you need both repeatability and confidence in your measurements, the 6062A holds steady with level



PHILIPS

Two Gigahurts.

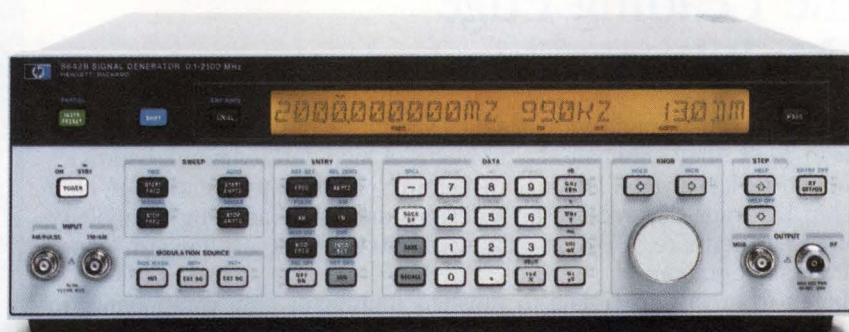

Hewlett-Packard 8642B Signal Generator.

\$31,500.

accuracy and linearity performance that is simply outstanding.

Of course, the 6062A is reliable and easy to use. And we stand behind it with the best service and support in the test and measurement business.

The 6062A is just one of a family of Fluke RF signal generators, designed and built to give you the maximum value for the investment.

Circle No. 223 for information only

Challenge the 6062A's performance in your application. Call us toll-free at **1-800-44-FLUKE** and arrange for a demonstration. Then you decide. At a savings of \$20,750, you'll feel no pain.

Fluke 6062A
 100kHz to 2,100MHz
 +16dBm maximum output level
 +/- 1dB level accuracy
 -60dBc spurious < 1GHz
 AM, FM 0M and pulse modulation

John Fluke Mfg. Co., Inc., P.O. Box C9090, M/S 250C, Everett, WA 98206 U.S.; (206) 356-5400. Canada: (416) 890-7600. Europe: (The Netherlands) 040-4580455. Other countries: (206) 347-6100. ©1988 John Fluke Mfg. Co., Inc. All rights reserved. HP and Hewlett-Packard are trademarks of Hewlett-Packard Co. All prices are manufacturers' U.S. list. Specifications and prices subject to change without notice. Ad no. 0281-F6062.



Circle No. 92 for demo request 201

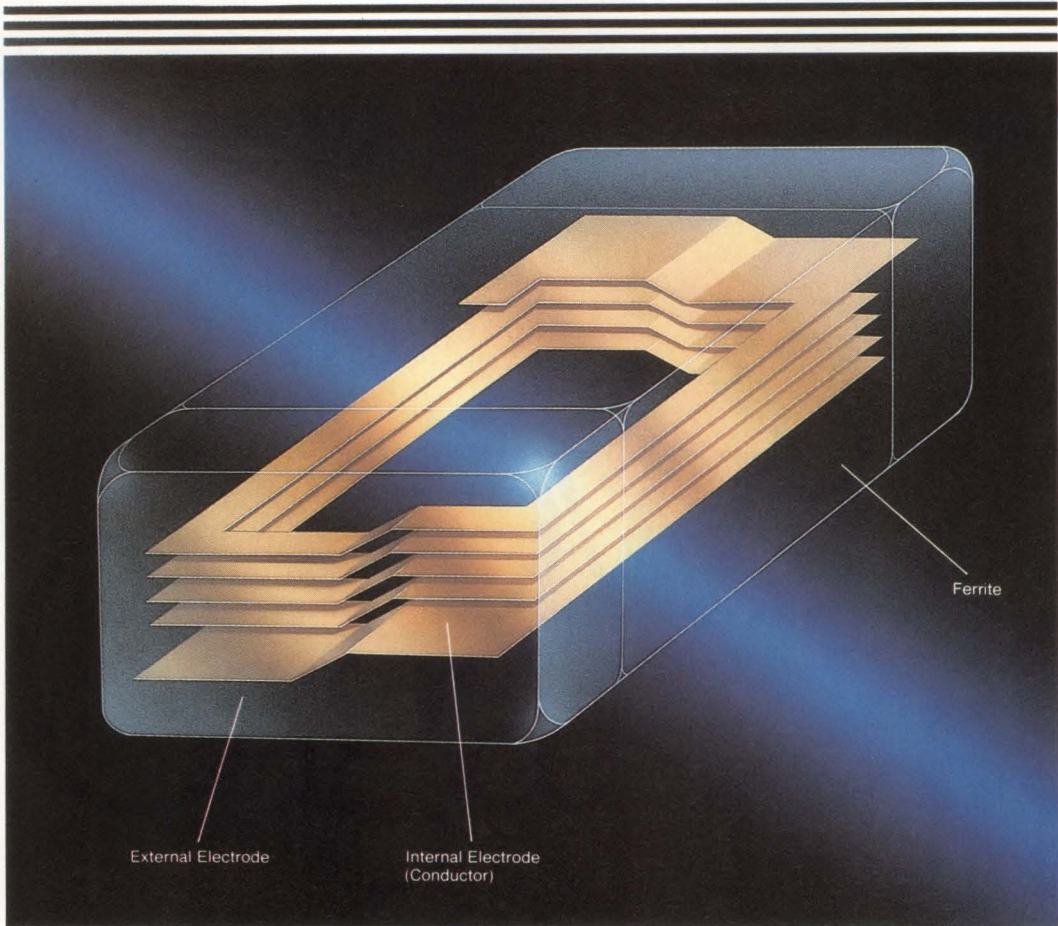

TDK Multilayer and Integration Technology Stands at the Leading Edge with TDK Multilayer Chip Inductors.

For the first time ever, inductors can be made without actual winding. Consider TDK Multilayer Chip Inductors. Thanks to TDK, they eliminate the problems of high density circuit boards.

Multilayer surface mount devices from TDK include ceramic chip capacitor networks, chip band pass filters and chip LC traps that require both designs and manufacturing technology of a sophisticated nature. Furthermore, TDK is making significant progress toward "super multilayer" and high circuits integration.

TDK technology ranges from raw materials to finished multilayer chip components to automatic mounting equipment, namely, our Avimount series. We strive to meet the requirements of the industry for high quality, high performance chip components. And we're striving to achieve total surface mount technology from start to finish.

When it comes to SMT, come to TDK.

See our Surface Mount Devices and other fine Products at Electro/88, Boston, May 10-12, TDK Booth No. 1065.



TDK Surface Mount Technology - At Your Service.



TDK CORPORATION OF AMERICA HEAD OFFICE 1600 Feehanville Drive, Mount Prospect, IL 60056, U.S.A. Phone: (312) 803-6100 CHICAGO REGIONAL OFFICE Phone: (312) 803-6100 INDIANAPOLIS REGIONAL OFFICE Phone: (317) 872-0370 NEW YORK REGIONAL OFFICE Phone: (516) 625-0100 LOS ANGELES REGIONAL OFFICE Phone: (213) 539-6631 DETROIT DISTRICT OFFICE Phone: (313) 353-9393 NEW JERSEY DISTRICT OFFICE Phone: (201) 736-0023 HUNTSVILLE DISTRICT OFFICE Phone: (205) 539-4551 GREENSBORO DISTRICT OFFICE Phone: (919) 292-0012 DALLAS DISTRICT OFFICE Phone: (214) 506-9800 SAN FRANCISCO DISTRICT OFFICE Phone: (408) 437-9585 TDK CORPORATION, TOKYO, JAPAN.

Simplifying High Density Placement TDK Surface Mount Devices

Multilayer Ceramic Chip Capacitor C1608 (CC0603) C: 0.5 - 22,000pF C2012 (CC0805) C: 0.5 - 100,000pF C3216 (CC1206) C: 0.5 - 220,000pF C3225 (CC1210) C: 750 - 470,000pF C4532 (CC1812) C: 2,400pF - 1µF C5650 (CC2220) C: 5,100pF - 1.5µF	Leadless Inductor (Wound Chip Inductor) NL322522 L: 0.01 - 220µH NL453232 L: 1.0 - 1,000µH NL565050 L: 1,200 - 10,000µH NLF453232 L: 1.0 - 1,000µH (Shielded Inductor)
Multilayer Chip Capacitor Network MCN7575 TC: CH. 1 - 100pF (10 capacitors) SL. 10 - 1,000pF (10 capacitors) Class II. 100 - 470,000pF (10 capacitors)	Leadless LC Trap (Wound Chip LC Trap) NLT4532 F: 630kHz - 13MHz Tolerance: ±2% Attenuation: 20dB min.
Multilayer Ceramic Chip Capacitor (High Frequency, Low Loss) FC1414 C: 0.5 - 3,300pF FC2828 C: 0.5 - 22,000pF FR1414 C: 0.5 - 3,300pF FR2828 C: 0.5 - 22,000pF	Leadless EMI Filter (Wound Chip EMI Filter) NLL4532 C: 33pF - 100,000pF L: 1µH - 220µH
Multilayer Chip Inductor MLF2012 L: 0.047 - 33µH MLF3216 L: 0.047 - 33µH MLF3225 L: 39 - 220µH	Ferrite Chip Bead CB201209 Z ₀ : 7, 10, 11Ω CB321611 Z ₀ : 19, 26, 31Ω CB322513 Z ₀ : 31, 52, 60Ω CB453215 Z ₀ : 70, 120, 125Ω
Multilayer Chip LC Trap MXT4532 F: to ±2%	NTC Chip Thermistor NTC CS3216 R typical: 1.0 - 150kΩ at 25°C Temp. Range: -25 to +85°C
Multilayer Chip IFT MIA4532 F: 455, 459, 464kHz MIF4532 F: 10.7MHz	SM Active Delay Line FDL Delay time: 20 - 75 nsec.
Multilayer Chip Transformer MTT4532 L: 10 - 200µH	SM Transformer/Inductor EE5 ER9.5 EE12 ER11 T2 ER14.5 A variety of characteristics are available. Please specify when ordering.
Multilayer Chip LC Filter MXF4532H HPF (Tuner) MXF4532B BPF (FM radio) MXB5050B BPF (VCR) MXB5050L LPF (VCR) MXB5050D Delay Line (VCR) A variety of characteristics are available. Please specify when ordering.	SM Step-up Inductor (Piezoelectric Buzzer) OL3.3 x 1.6 OL3.3 x 2.1 Inductance values are representative, please specify value when ordering.



PHILIPS

1988 Catalog

Test & Measurement
Instrumentation

Solutions for
Research &
Development,
Manufacturing,
Calibration
and Service.

Brace your shelf.

The new Fluke catalog is about to hit your desk, carrying the entire Fluke and Philips lineup of test and measurement gear. Twice as many pages, and twice as many T&M products.

All backed by Fluke's ironclad support. Call your local sales office, or 1-800-44-FLUKE to get a copy. Then brace yourself — and your shelf — for the full weight of our global alliance.



10 Good Reasons to Get NEC's FREE Gate Array Gateway Kit

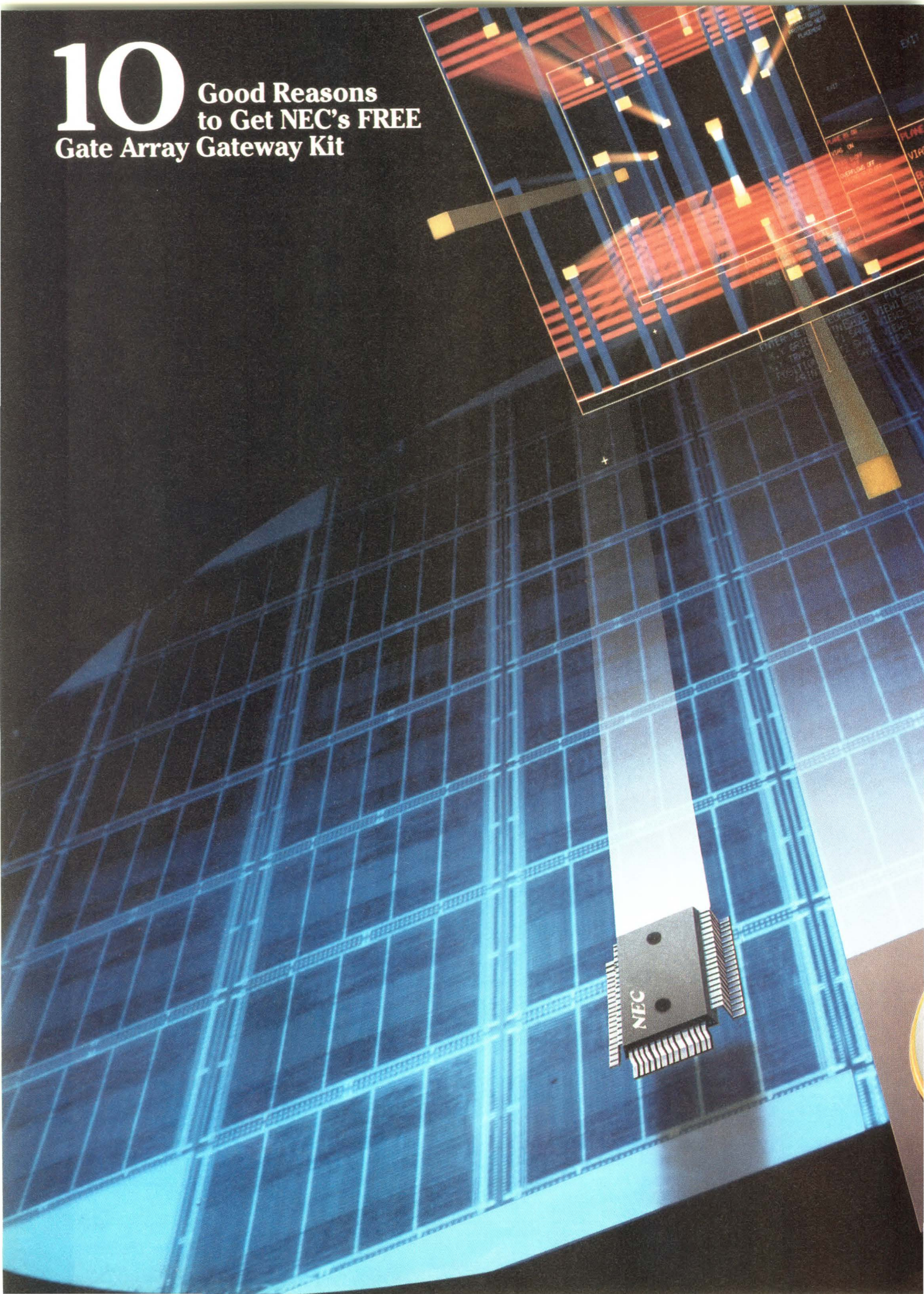

NEC's FREE Design Kit is Your Gate Array Gateway to

1. CMOS, BiCMOS, and ECL technologies.
2. Valid, Sun, Mentor, Daisy, Tektronix/CAE, HP 9000, FutureNet, Calma TEGAS V, and HILO compatibility.
3. A powerful block library with more than 170 macros, including analog, peripheral, and megamacro functions.
4. Cell utilization rates of 95% over a range of 800 to 45,000 gates.
5. Better than 95% first-time success with engineering prototypes.
6. The most experienced manufacturing capability.
7. The widest choice of through-hole and surface-mount packages.
8. The most effective way to lower your system costs.
9. Local design support with local FAEs and design centers backed by a satellite network of computers for worldwide communications services.
10. The easiest translation of your ideas into silicon.

NEC Electronics Inc.

401 Ellis Street, P.O. Box 7241
Mountain View, CA 94039

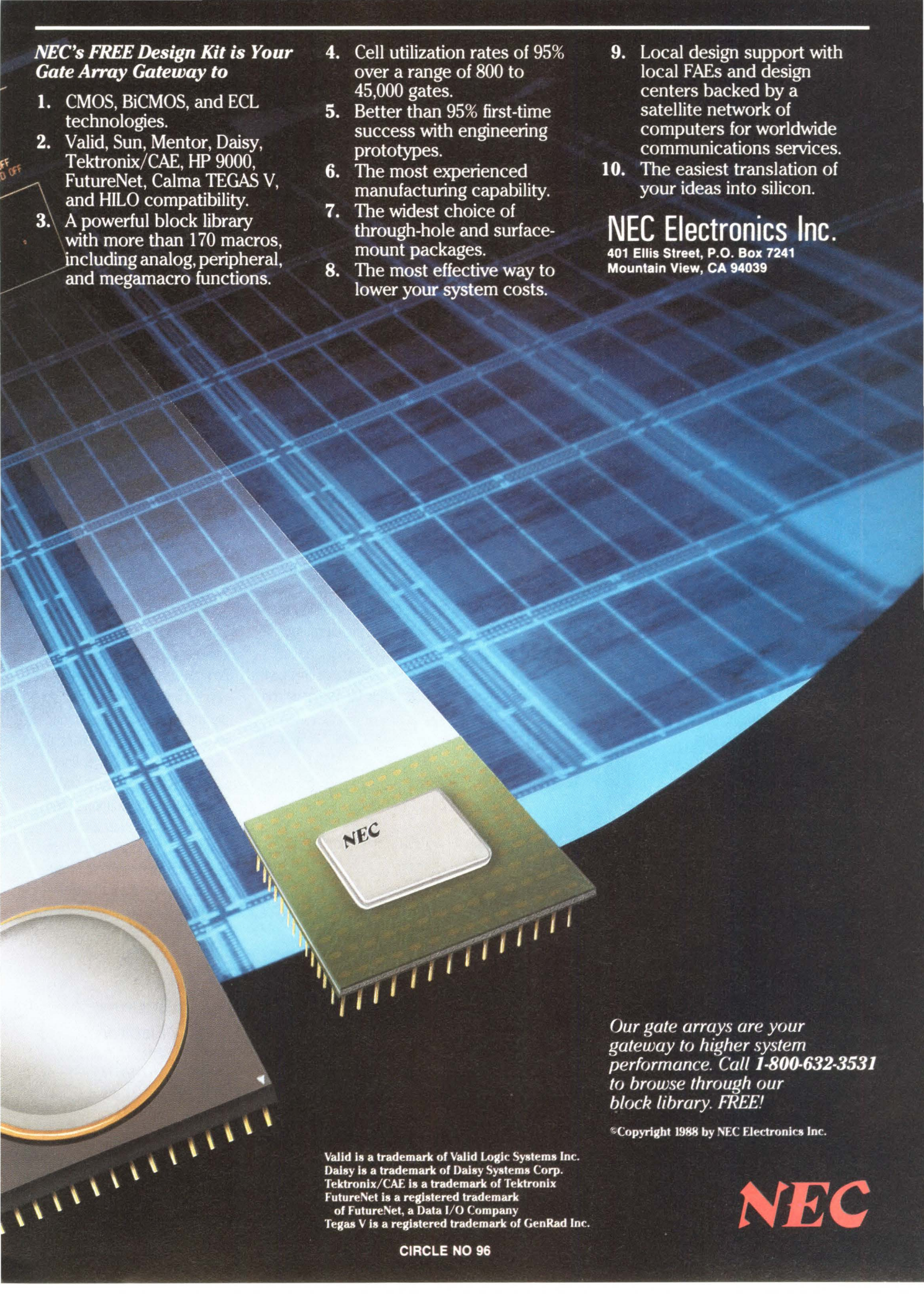

*Our gate arrays are your gateway to higher system performance. Call **1-800-632-3531** to browse through our block library. **FREE!***

©Copyright 1988 by NEC Electronics Inc.

Valid is a trademark of Valid Logic Systems Inc.
Daisy is a trademark of Daisy Systems Corp.
Tektronix/CAE is a trademark of Tektronix
FutureNet is a registered trademark of FutureNet, a Data I/O Company
Tegas V is a registered trademark of GenRad Inc.

NEC

Eliminate the noise from your design.

A MUST FOR IC BOARD DESIGN

The problem of constructing IC boards free from electro-magnetic interference is one you can easily solve with Tokin EMC Filters.

But if you wait until you've started designing the board, it's already too late; it's something you need to consider *before* you begin. The Tokin EMC Chip Filters above are a good example. By including them in the IC design from the start, the designer can create an IC board that enables the end user to enjoy the full, unrestricted potential of the board's performance. That's why more



and more companies are using Tokin EMC components in a mushrooming range of electronic products throughout the world every day.

AN ANSWER FOR YOUR EVERY DIGITAL NEED

Digital electronics are changing the shape of the world we live in, in more ways than one. And

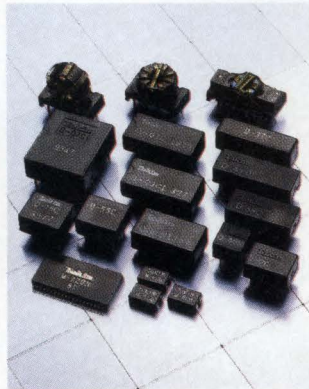

Specifications (EMC Chip Filters)

Model	Circuit	Frequency Range (MHz)	Impedance (Ω)	Rated Current (mA)
M608	1 circuit; Common-mode	5-200	≥ 300 (at 100MHz)	100
M614	1 circuit; Common-mode	5-100	≥ 700 (at 50MHz)	100
M620	1 circuit; Common-mode	5-50	$\geq 1,000$ (at 30MHz)	100
M720N	20 circuits; Normal-mode	50-300	≥ 50 (at 200MHz)	50

to deal with EMI, the normal- and common-mode noise that attacks data communications terminals and digital equipment, Tokin has come to the rescue with an incomparable lineup of EMC data line filters that deliver

Specifications (DIP Noise Filters)

Model	Circuit	Rated Current per Line (mA)
D-03C/ D-03C1	8 circuits; Common-mode	100
D-05N1	8 circuits; Normal-mode	100
D-07C1	8 circuits; Common-mode	300
D-08C2	4 circuits; Common-mode	2,300
D-08C2A	4 circuits; Common-mode	500
D-16C	4 circuits; Common-mode	100
D-20C	8 circuits; Common-mode	500
D-40C	3 circuits; Common-mode	300
D-42C	5 circuits; Common-mode	300
D-45C	8 circuits; Common-mode	300
D-47C	10 circuits; Common-mode	300
D-55C	5 circuits; Common-mode	300
D-58C	8 circuits; Common-mode	300

clear, accurate data transmission. From easy-to-mount EMC Chip Filters for normal- and common-mode noise absorption, to DIP Noise Filters for high impedance over a wide frequency range.

A HALF-CENTURY OF CLEAR COMMUNICATION

Tokin stands for reliability you can count on, and all Tokin EMC components are backed by 50 years of intense work in developing and manufacturing communications and electronics materials and devices. From power line filters to noise simulators and other measuring equipment and facilities, Tokin offers a vast selection of products and services to provide unprecedented communication clarity. Call us for details.

Please see us at



Electronic Show and Convention
May 10-12/Boston, Massachusetts

#2711/2713

Tokin

Tokin Corporation

Head Office: Hazama Bldg., 5-8, Ni-chrome, Kita-Aoyama, Minato-ku, Tokyo 107, Japan Tel: Tokyo (03) 402-6166 Fax: Tokyo (03) 497-9756
Telex: 02422695 TOKIN J

Tokin America Inc.

155 Nicholson Lane, San Jose, California 95134, U.S.A. Tel: 408-432-8020 Fax: 408-434-0375
Chicago Branch: Presidents Plaza 1, Suite 200N, 8600 W. Bryn Mawr, Chicago, IL 60631 Tel: 312-380-0030 Fax: 312-693-8334

München Liaison Office

Elisabethstraße 21, 8000 München 40, Bundesrepublik Deutschland Tel: (089) 271 75 22 Fax: (089) 271 75 67 Telex: 5 24 537 tokin d

You can reach our agents by phone: London 01-837 2701; Paris 1-45 34 75 35; Milan (0331) 678.058; Munich (089) 5164-0; Seoul (02) 777-5767; Taipei (02) 7311425; Hong Kong 3-315769; Singapore 747-8668

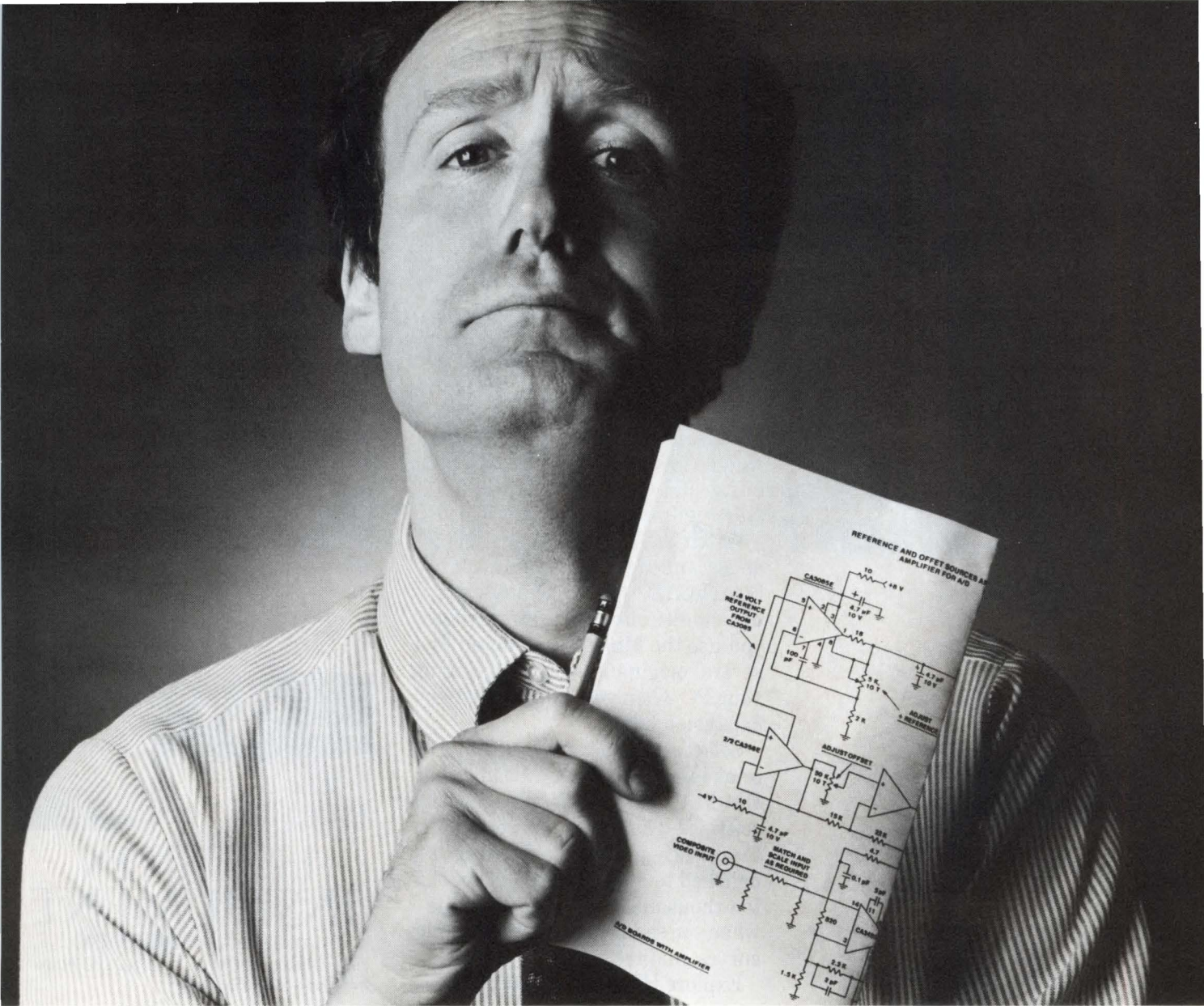

IF YOU'RE A DEMANDING, PICKY, IMPATIENT PERFECTIONIST, WE'VE GOT THE BOOKS FOR YOU.

The tougher you are as a customer, the happier you'll be with us. Start with our products. Because we design, manufacture and stock one of the most extensive lines in the industry, chances are you'll find exactly what you need in either or both catalogs. And if you don't, we'll design circuitry or customize a package to your exact specifications. So, stock or custom, there's no need to look any further than Allen Avionics.

Then there's reliability. Every single component we deliver has been individually tested and is guaranteed to be within the electrical and physical parameters specified. Regarding price and delivery... we're competitive on every item and lower on many. More important, whether it's a product in stock, a custom order or a prototype, you'll have it when you need it, and that's a promise.

If your standards are a little too high for other suppliers, send for our Delay Line and/or Filter catalog, or better yet, give us a call. We handle tough problems for tough customers. With ease.



ALLEN AVIONICS, INC.

224 East Second Street, Mineola, NY 11501
516-248-8080 • FAX: 516-747-5481



MOVE UP TO A NEW LINE

FROM HOUSTON INSTRUMENT

Prepare to be impressed. Meet the new line of high-performance plotters from Houston Instrument.™ HI's sleek new DMP-60 series is designed to impress even the most demanding CAD professional.

Discover unprecedented flexibility—blended with ultra-fine resolution, speed, and software compatibility. Benefit from HI's rigorous standards for quality, reliability, and service. All at prices starting from \$4,695.*

Watch the DMP-60 series double as a scanner with HI's unique SCAN-CAD™ option. Quickly produce multicolored drawings when you use the Multi-Pen adaptor. Plot several originals—without tying up your PC when you add HI's buffer expansion board.

Select media as small as 8½"×11" or as large as 36"×48". Load either DM/PL™ or HP-GL 758X-compatible software. Then watch as your plotter quickly produces a drawing polished to a precise resolution of 5 ten-thousandths of an inch. Smile when you see smoothly formed circles, curves, and lettering.

Explore HI's host of support

programs including an overnight plotter-replacement service. And then relax, knowing that HI's new plotters rest on 27 years of engineering excellence.

Move up. To a fine, new line. From Houston Instrument. Begin by calling 1-800-444-3425 or 512-835-0900 or writing Houston Instrument, 8500 Cameron Road, Austin, TX 78753.

**U.S. suggested retail price.*

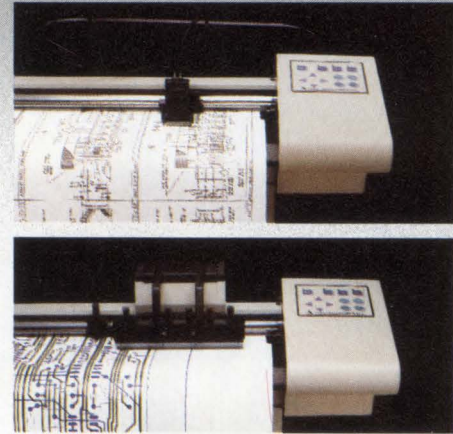

HOUSTON INSTRUMENT

A DIVISION OF **AMETEK**

Houston Instrument, SCAN-CAD, and DM/PL are trademarks of AMETEK, Inc.



Dynamic testing describes behavior of high-frequency ADCs

Conventional dc testing cannot fully describe the behavior of high-speed ADC systems—particularly when the input frequency approaches one-half the sampling rate. Using improved dynamic-testing methods, you can accurately characterize the performance of an A/D converter that is operating near its theoretical limits.

Eric D Blom, *Sipex Corp*

High-speed A/D-conversion systems require dynamic testing to quantify their performance. Conventional dc testing is incapable of providing useful information relative to the performance of an A/D system at high frequencies. The problem becomes particularly acute when the components of the input signal approach, or exceed, one-half the sampling frequency. Even when dynamic specifications are provided, they are not always useful—manufacturers have not standardized on the tests or methods used, partly because many tests are necessary only for certain applications. Moreover, most dynamic specifications don't tell the whole story about the types of degradation that arise when you push input power bandwidths to the limit. The dynamic-testing system described here uncovers the actual performance of some common flash converters. The results of the tests yield specifications that more fully

describe the actual behavior of a digitizer operating near its theoretical speed limit.

The thrust of technology has made available A/D converters that are capable of very high sampling rates. These high rates make possible the multiplexing of an ever-increasing number of channels at a given effective sampling rate, or, alternatively, the digitizing of wide-band single channels at higher sampling rates. In either case, the use of high-speed A/D converters is often disappointing unless you fully understand their dynamic specifications.

In general, you should consider the dc specifications of a converter's linearity as the best-case limit on its dynamic performance. You can normalize the most useful dynamic specifications into numbers that are measurable with dc tests; in these cases, you can compare the degradation at a specific (high) frequency to the best-case-dc, or low-frequency, numbers. Unfortunately, only the best flash converters degrade gradually and gracefully in performance as you increase the large-amplitude input-signal frequency. If the input signal contains appreciable power at frequencies near the Nyquist limit, a careful study of the converter's dynamic specifications and an understanding of the converter's architecture are necessary to predict the type of degradation you will encounter.

When sampling a high-slew-rate signal, many flash converters exhibit a phenomenon known as spurious codes. Consider the flash architecture of Fig 1, where the input signal couples directly to all 255 comparators. Each comparator exhibits a propagation delay, which is the time between the application of voltage overdrive at

Many flash converters exhibit a phenomenon known as spurious codes when sampling a signal that has a high slew rate.

the input and the change of state at the output. A classic synchronization problem arises when the comparator-bank output is sampled while the output is changing state. This problem is compounded if the propagation times through the comparators are not exactly equal.

Assume comparator 128 of Fig 1 has a t_{pd} (total propagation delay) that's 60 psec faster than that of comparators 127 and 126. When a fast-slewing input signal is present at the input, the output of comparator 128 will show a logic One for a period as long as 60 psec before the other two comparators switch to logic One. If the comparators' outputs are sampled (latched) during this time, then the normal thermometer-code output of these latches (all Ones continuing to a certain comparator, then all Zeros above that comparator) will show a double bubble. The bubble will appear for the full 60 psec if the input slew rate is infinite. The bubble will not appear at all if the input signal requires 60 psec to slew from the comparator voltage at 126 to the comparator voltage at 128.

The encoding circuit will assign this illegal input to some output code—a correct code if sufficient redundancy exists in the encoder logic, or some other code determined by the don't-care state used in the Boolean-

logic minimization of the encoder design. Early converters often mapped these illegal inputs to code 255, resulting in an output code of 255 for an input somewhere near mid-scale.

In the general case, in which the converter is digitizing an input of unknown phase or timing, spurious codes caused by this slew-related phenomenon arise in a random fashion. The converter will generate a spurious code only if the latch command occurs during the 60-psec double bubble. Thus, the probability of a spurious code's occurrence is related to how often the comparators are sampled during this time window; the probability is the ratio of the time duration of the bubble to the period of the sampling clock. A sample/hold synchronizer, or an input multiplexer that's timed to slew near this sampling point, can actually increase the probability of error occurrence.

Early attempts to quantify this spurious-code phenomenon led one manufacturer of CMOS flash converters to include a *sparkle* specification. When viewing digitized video, this phenomenon shows up as a sporadic, bright-white dot in the reconstructed image. The sparkle spec guaranteed how few white dots appeared per frame of video.

The general problem seems to have only two practical

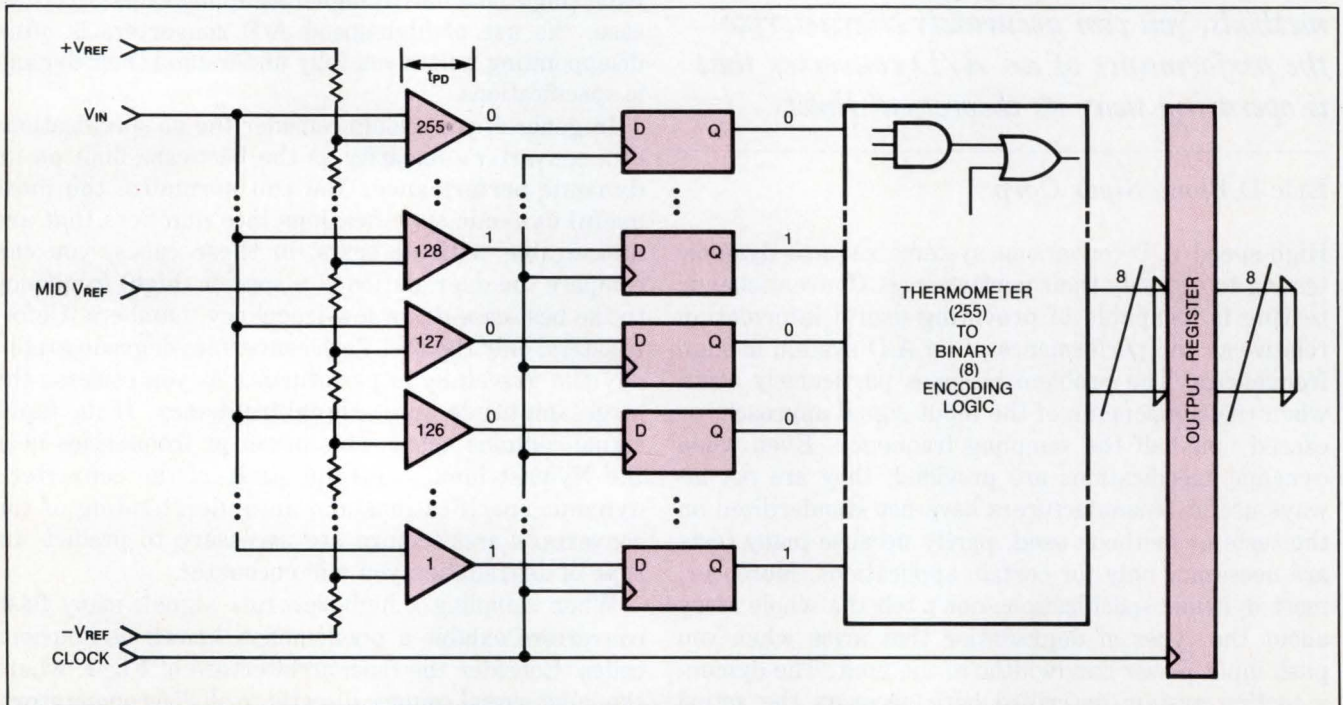

Fig 1—"Bubbles" appear in thermometer-code lines at high input slew rates, because of mismatches in the propagation delays of the individual comparators.

solutions. The first is the use of a sample/hold circuit before the flash converter, with the transition from sample-to-hold timed such that the comparator outputs are stable when they are latched. This configuration is the analog equivalent of adding a synchronizer before latching an asynchronous input. A second solution counts on the degree of comparator-delay matching within the flash converter. If the matching is good enough to prevent double bubbles for input slew rates lower than some value, then you can simply limit the slew rate to the required value and no spurious codes will appear.

Don't let power bandwidth confuse you

The modern power-bandwidth specification is a measure of the described slew-rate phenomenon. Power bandwidth is a misleading term—it is not the -3-dB frequency of an amplifier—the actual quantity that should be limited is the input signal's slew rate, especially near the time when the comparator outputs are latched. The term power bandwidth comes from the normal method of testing for spurious codes. In this method, you apply a full-scale sine wave of known frequency to the converter, and then examine the resulting codes for *spuriousness*.

Spurious codes exist at frequencies above a certain value, and the power bandwidth is defined as the frequency just below that value. The sine wave is

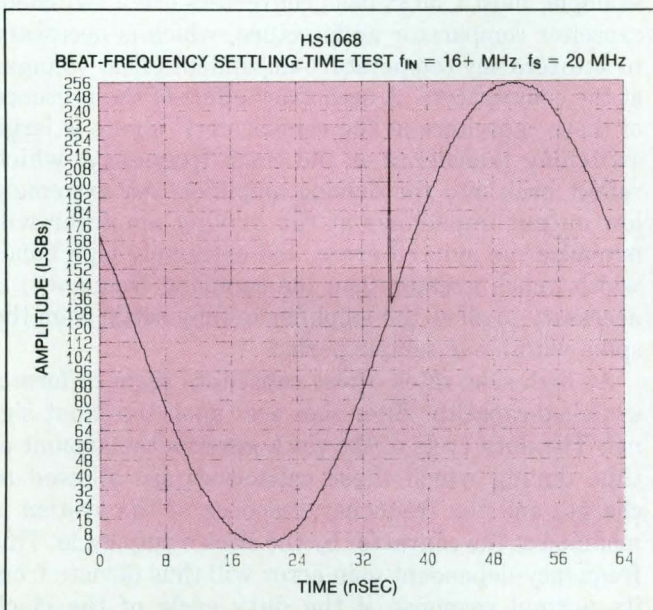

Fig 2—This classic example of a spurious-code spike is the result of exceeding the slew-rate capability of the converter.

actually defining a maximum slew rate (2π times the peak amplitude times the frequency) in volts/sec. A low-frequency multiplexed system can violate this slew-rate limit if the multiplexer must switch between adjacent signals of low and high voltage. A power-bandwidth specification of less than one-half the sampling rate indicates that the system performance will degrade before the theoretical, Nyquist-limit input frequency is reached. **Fig 2** shows a classic example of this type of spurious code.

Practical testing for this type of spuriousness is easy, although the number of points required for a specific confidence level is often large. Designers commonly use FFT testing to infer the relative dynamic accuracy of a converter from its signal-to-(noise + distortion) ratio.

TABLE 1—SIGNAL-TO-NOISE RATIO VS FREQUENCY

F _{IN} (MHZ)	10 FFT TESTS			CODE SIZE (LSBs)	
	SNR (dB)	VARIANCE (dB)	EFFECTIVE BITS	MINIMUM CODE	MAXIMUM CODE
TDC1048-BASED SUBSYSTEMS (HS1068)					
1.005	47.56	0.0097	7.60	0.65	1.41
2.005	46.35	0.0098	7.41	0.64	1.36
4.005	43.36	0.0228	6.91	0.49	1.46
8.005	40.57	0.0226	6.45	0.30	1.70
12.005*	37.41	0.0057	5.92	0.20	1.99
16.005	28.55	3.592	4.45	0.17	2.20
CA3318D-BASED SUBSYSTEM (BREADBOARD)					
1.005	37.47	0.0008	5.93	0.27	1.76
2.005*	38.34	0.0006	6.07	0.09	2.25
4.005	35.34	0.0025	5.58	1 MISSING	2.60
8.005	29.77	0.0072	4.65	1 MISSING	2.59
12.005	23.16	2.199	3.55	2 MISSING	3.42
MC10319-BASED SUBSYSTEM (SP1070)					
1.005	47.46	0.0059	7.59	0.59	1.54
2.005	46.33	0.0075	7.40	0.56	1.51
4.005*	42.67	0.0026	6.80	0.38	1.97
8.005	34.05	0.0062	5.36	0.01	3.40
12.005	29.04	0.0021	4.53	3 MISSING	4.66
16.005	25.62	0.0058	3.96	8 MISSING	7.54

*SHOWS THE POWER BANDWIDTH FREQUENCY

FFT testing is commonly used to infer the dynamic relative accuracy of a converter from its signal-to-(noise+distortion) ratio.

You can also express this ratio in units of ideal effective bits. A single spurious code will affect the spectrum by raising the wideband-noise floor, as in the case of the flat spectrum of an impulse. If you run a large number of signal-to-noise-ratio (SNR) tests, you can compute the variance in their readings. Some variance in SNRs is normal, because of the random phase of the sine wave's start and end points within the sampled-data buffer.

If the variance is larger than the random variance, you can assume that a spurious code exists. The magnitude of the variance (a large variance implies a large impulse error) provides an indication of its severity without requiring a spuriousness test for each code sampled. The tester used by the author's company uses 4k-point buffers and a Von Hann window to compute the SNRs. A Von Hann window is a \cos^2 function that forces the FFT to more closely approximate an ideal Fourier transform. The variance caused by random buffer-start points for 10 buffers is typically less than 0.1 dB. When the variance exceeds 0.1 dB, the tester declares a spurious code. Note that a large variance implies an error that occurs randomly. At extremely high slew rates, spurious codes may exist near almost every sine-wave zero crossing. The variance can be small in this situation, but the SNR measurements degrade rapidly and thus flag this type of error. **Table 1** shows the SNR, variance, and effective bits at different full-scale-input frequencies, all sampled at 20M samples/sec.

You can use a sampling-scope test, a variation of the beat-frequency test, to graphically plot the waveform—including any spurious codes—produced by the converter. At the author's company, this test is used to measure amplifier settling times, as it results in no quantitative information about spuriousness. A frequency synthesizer of good short-term stability serves to generate an input square wave. The converter is run at full speed, here 20 MHz, and a 4k-point buffer stores the information. Software is used to decimate the input file to produce a single beat-frequency cycle. Typical parameters used are: $f_{IN}=2.004883$ MHz, a decimation factor of 10, and $f_S=20$ MHz.

Decimation by 10 results in a single cycle of 409 points and an effective sample resolution of 1.22 nsec/point. At $f_{IN}=4+$ MHz, a resolution of 0.6 nsec/point is possible. **Fig 3** plots the results obtained from digitizing an input square wave that exhibits 1.2-nsec rise and fall times. Note that the input amplifier, which has typical rise and fall times of 18 to 20 nsec, is pushed into

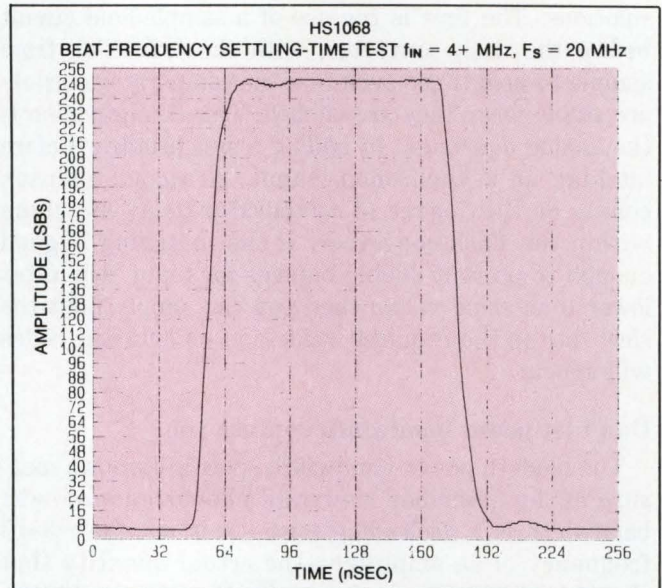

Fig 3—A settling-time plot uses a sampling-scope test. This plot for the HS1068-based subsystem uses a variation of the beat-frequency test.

slew-rate limiting; thus the slew rate at the flash converter is significantly lower.

Flash converters vary in performance

Other flash-converter architectures are in use, and their performance degrades in a different manner. For example, most CMOS flash converters use a switched-capacitor comparator architecture, which is necessary to autozero any temperature-dependent offset voltages at the comparators. A secondary effect of the presence of these capacitors at the comparators' inputs is large switching transients at the clock frequency, which reflect back into the driving amplifier. An extremely low output impedance at the driving amplifier will minimize the induced error, and extremely high bandwidth (much greater than the sampling frequency) is necessary to allow the amplifier to fully settle from the spike within one sample period.

At high slew rates, these capacitors seem to form a switched-capacitor filter that acts upon the input signal. The duty cycle of the clock governs the amount of time during which these capacitors are allowed to charge, and the frequency response of the system is modified at the converter by the clock's duty cycle. This frequency-dependent gain error will thus deviate from its normal response if the duty cycle of the clock changes with time or temperature.

The input amplifier acts as the current source that

charges these capacitors. The resulting capacitor voltage is equal to $I_{OUT} \times C$, multiplied by the time duration of the sampling portion of the clock period. The voltage transferred to each comparator is thus a function of the capacitor's value. Any variation in capacitance at each comparator will affect the width of each code, leading to aberrations in differential linearity.

How well this architecture works near Nyquist frequencies depends on the ability of the input amplifier to

damp the switching spikes induced by the load (that is, the converter itself). Fig 4 plots the output codes, shows them in histogram form, then takes their ratio to the ideal number of occurrences to generate the differential-linearity error. The tests in this example make no claim to fairness, as this converter is now specified at 15M samples/sec and has a power-bandwidth specification of only 5 MHz. Waveforms taken at 10+ MHz f_{IN} rarely show the classic spurious code, as experienced

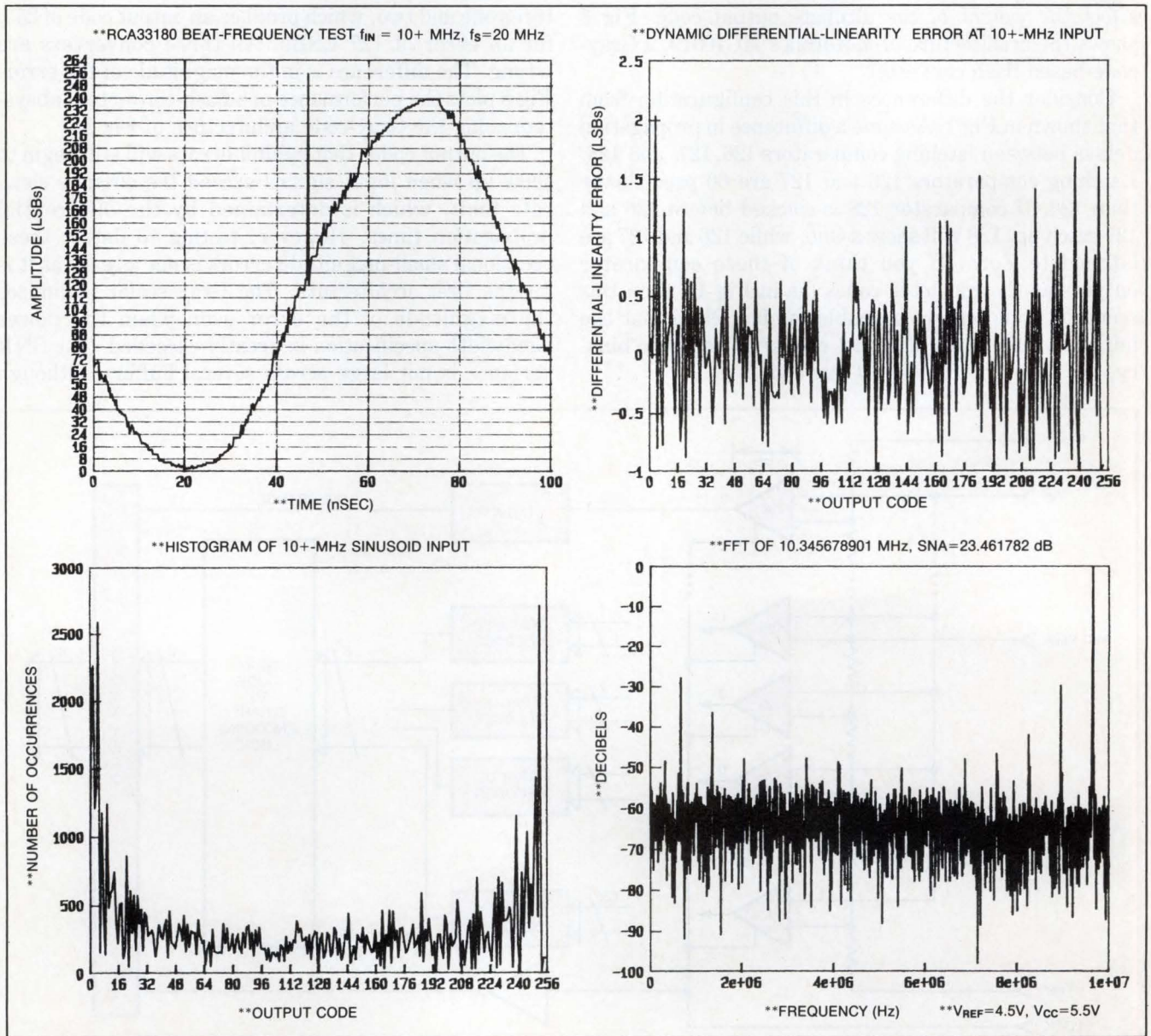

Fig 4—Spurious codes and differential-linearity degradation result when you drive a CMOS-processed flash A/D converter at frequencies beyond its capabilities.

You can use a sampling-scope test to graphically plot the waveform that an A/D converter produces, including any spurious codes.

with the architecture discussed earlier. However, the histogram and dynamic-differential-linearity plot tell another story. The code widths vary erratically, and many codes do not exist at all.

A third flash architecture has the ability to limit the occurrence of spurious codes. This architecture merges a Gray-scale encoder into the comparator and latch-array sections, which then drive Gray-to-binary encoder logic. The practical advantage of using the Gray code stems from the minimal way the most likely errors affect the weight of the ultimate output code. Fig 5 shows the architecture of Motorola's MC10319, a Gray-code-based flash converter.

Consider the differences in this configuration from that shown in Fig 1. Assume a difference in propagation delays between latching comparators 126, 127, and 128. Latching comparators 126 and 127 are 60 psec slower than 128. If comparator 128 is clocked before 126 and 127 catch up, 128 will show a One, while 126 and 127 are latched to Zero. If you think of these comparator outputs as thermometer codes (as in Fig 1), then this scenario would create a double bubble. Note that the initial encoding logic does not convert directly to binary, but to an intermediate Gray code.

Each comparator error will cause a corresponding error in one position of the Gray code. All Ones from the first to the 128th comparator would have resulted in a Gray-code representation described by the bit-pattern $C0_{16}$. The two comparator errors, however, will produce a Gray code described by $C3_{16}$, caused by erroneous inputs to the Gray LSB decoder and the Gray D_2 decoder. The resulting binary output code will be 82_{16} , or 130_{10} . This output code would be in error by $130 - 128$, or 2 LSBs. Contrast this result with architectures one and two, which produce an output code of 255, for an error of 127 LSBs. All three converters are wrong. The difference is in the magnitude of the error. Fig 6 plots the performance of a flash-converter subsystem using the Gray-code architecture of Fig 5.

The output codes that exhibit errors will still begin to show up when input signals exceed the circuit's slew-rate limit, which is determined by the differential propagation times. However, testing to detect these occasional small-magnitude errors is not as easy as it is for the first architecture. The Gray scaler minimizes the magnitude of the error even when the power bandwidth specification is greatly exceeded. The SNR variance is not large across several buffers, although

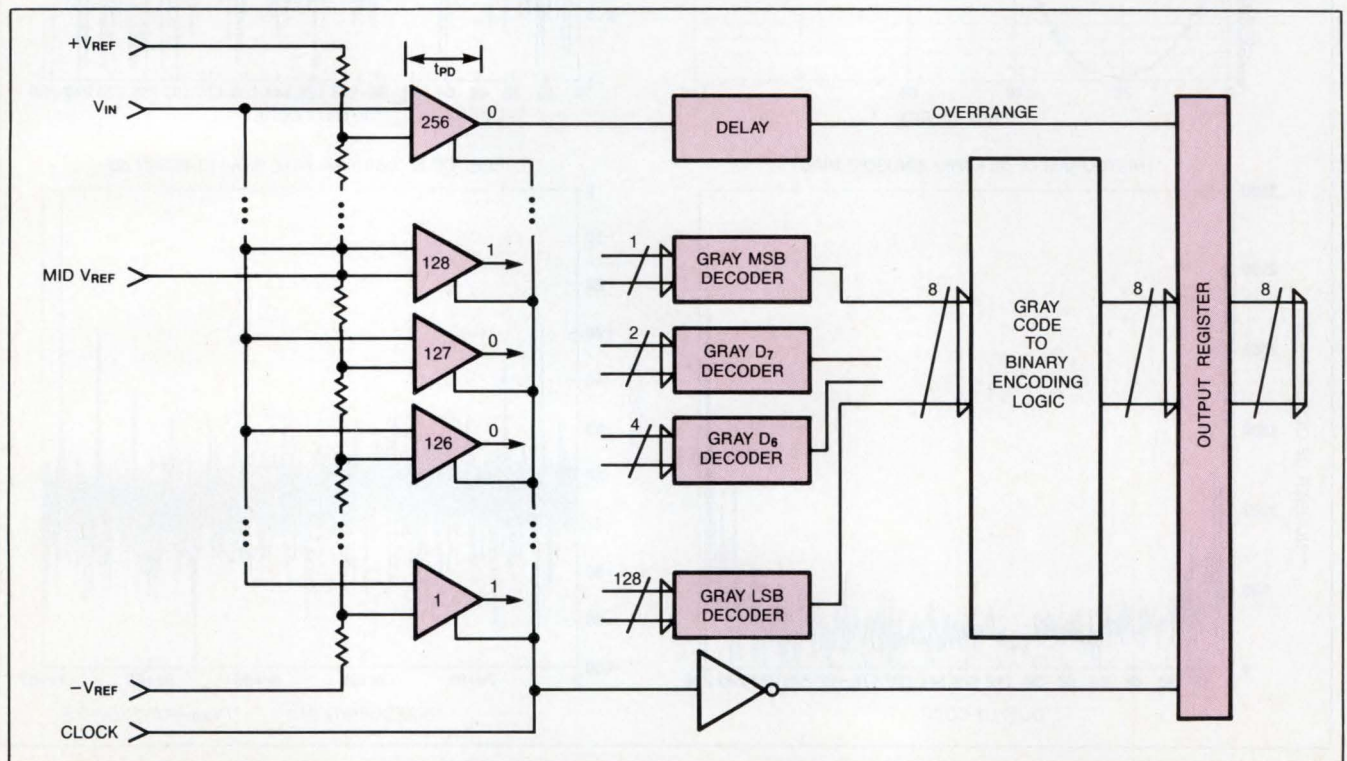

Fig 5—Equivalent "bubbles" at high slew rates cause only minimal output-code errors in a Gray-code-based flash converter.

the SNR will degrade significantly because of the equivalent wideband noise (see **Table 1**). Differentiating the amount of degradation caused by slew-rate-induced errors from that caused by converter noise, crosstalk, and integral nonlinearity in the amplifier is not a straightforward problem. The problem, then, is how to specify an equivalent no-spurious-codes power bandwidth for converters that use different architectures.

One solution is evident from the examination of the histograms of output codes for full-scale sine waves of increasing frequency. Although Gray-scale flash converters do not exhibit spurious codes as easily identifiable random events, the evidence of slew-rate-related problems is clear in the code widths portrayed in the histograms. When these histograms are normalized to show dynamic differential-linearity error, this dynamic error can be directly compared to differential-linearity

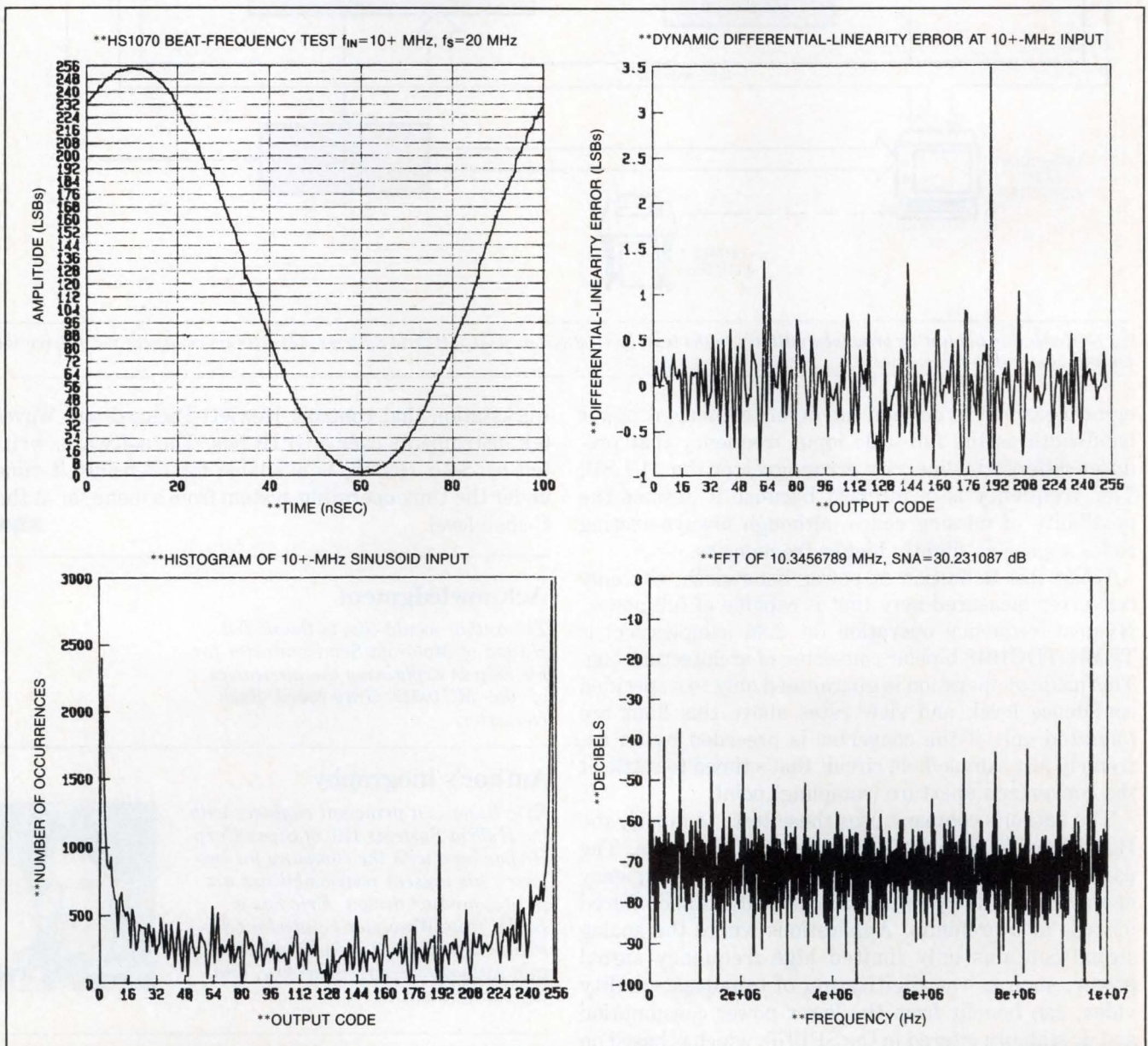

Fig 6—These plots from a Gray-scaled flash converter show no classical spurious codes. Slew-rate-induced problems appear as missing or widened codes.

Most CMOS converters use switched-capacitor comparators, which can reflect switching transients at the clock frequency into the driving amplifier.

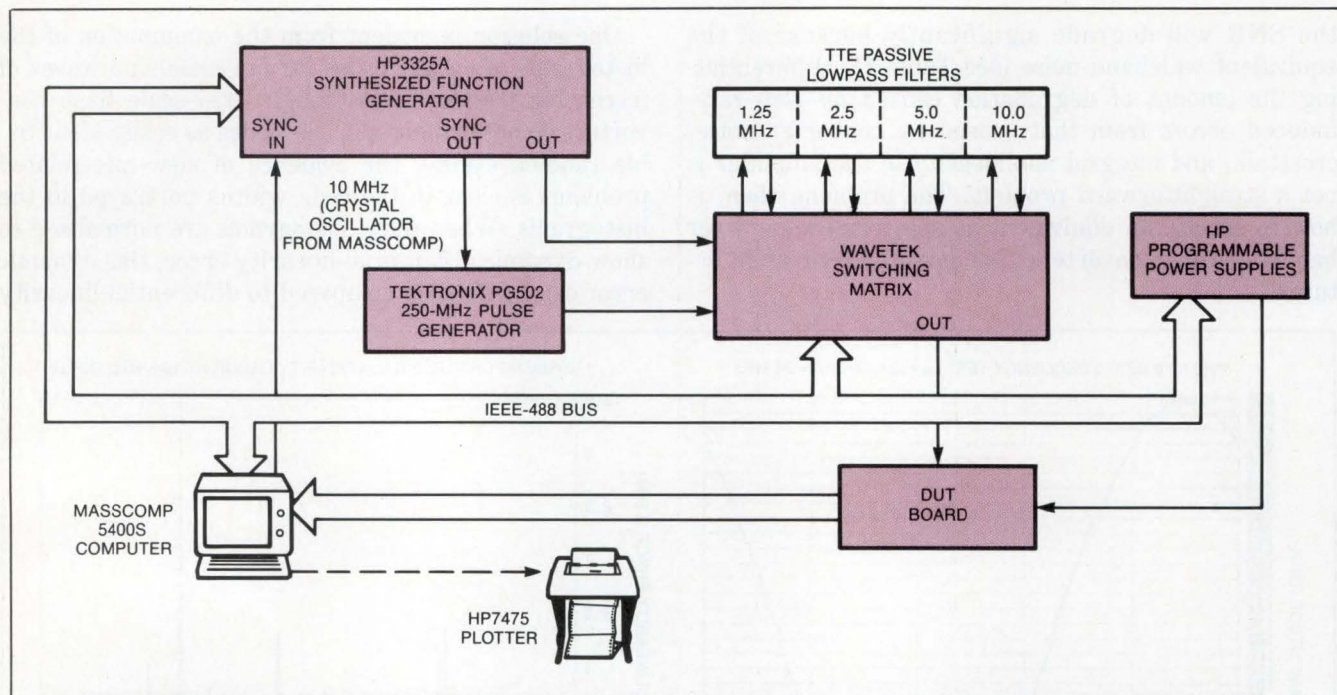

Fig 7—Reflecting the testing principles outlined in the text, this test system used at Hybrid Systems measures spuriousness and differential nonlinearity at high frequencies.

error measured at dc. You can define equivalent power bandwidth as the full-scale input frequency that produces differential-linearity errors greater than 1 LSB. This frequency is of interest because it defines the possibility of missing codes, although always-missing codes appear at slightly higher frequencies.

Using this definition of power bandwidth, the only converter measured here that is capable of full-power, Nyquist-frequency operation (at 20M samples/sec) is TRW's TDC1048 bipolar converter of architecture one. This mode of operation is guaranteed only to a specified confidence level, and slew rates above this limit are tolerated only if the converter is preceded by an extremely fast sample/hold circuit that's timed to settle at the converter's aperture (sampling) point.

The author's company uses these tests to qualify the HS1068 self-contained flash-conversion system. The parts that are capable of full-power, Nyquist-frequency operation over temperature are graded out and offered for sale at a premium. Applications where the analog signal contains only limited high-frequency signal power, such as the digitization of broadcast-quality video, can benefit from the lower power consumption and dc stability offered in the SP1070, which is based on Motorola's MC10319 flash converter.

The test system itself (Fig 7) consists of a MassComp

workstation that controls Hewlett-Packard and Wave-tek instruments over a GPIB bus. The software, written by Seth Hollub, is available for licensing; it runs under the Unix operating system from a menu, or at the C-shell level.

EDN

Acknowledgment

The author would like to thank Ted Hanna of Motorola Semiconductor for his help in explaining the intricacies of the MC10319 Gray-coded flash converter.

Author's biography

Eric Blom is a principal engineer with the Hybrid Systems Div of SipeX Corp. He has been with the company for two years; his present responsibilities are in new-product design. Eric has a BSEE from Worcester Polytechnic Institute. His hobbies include windsurfing, sailboat racing, ice hockey, and jug band music.

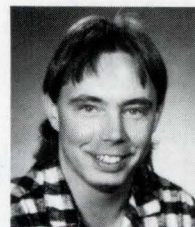

Article Interest Quotient (Circle One)
High 488 Medium 489 Low 490

POWER!

The sea, perhaps the singular most constant force in nature's storehouse of power. Through eons the sea's unyielding power has held man in awe. At Sorensen, we too, are unyielding when it comes to quality and design in our comprehensive line of power sources that range from laboratory/industrial power supplies and digital-to-analog interface units to modular switching power supplies.

For example, our QRD, XT and SRL series power supplies offer a dependable source for fast, smooth, clean DC power.

The QRD series is ideal for bench and lab test environments. It incorporates a linear pass design which provides high performance and high speed programming features.

The XT series provides unmatched flexibility with over 30 standard models and more than 1,500 user-specified configurations. It is the choice for portable applications requiring linear performance. The XT family is available in single, dual triple and quad configurations.

The SRL series offers unsurpassed performance at high power ranges and incorporates all the benefits of a linear series pass design with preregulation

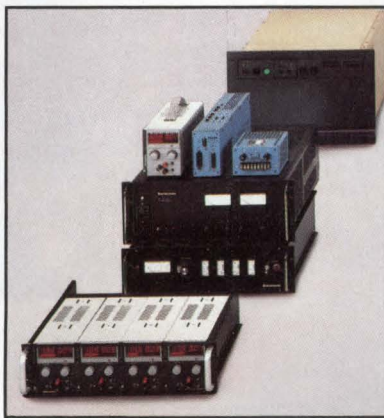

and efficient, economical packages up to 2100 watts at 1--10 Vdc to 0--60 Vdc.

At Sorensen, we produce a full line of off-the-shelf and semi-custom, as well as custom power supply assemblies. With over 400 different instruments from which to choose, you can be sure of finding the unit that will meet your particular needs.

Sorensen

A Raytheon Company

5555 N. Elston Ave.
Chicago, IL 60630

All Sorensen power instruments are designed and built to last. That's why we back them with our Five Year limited parts warranty. No other manufacturer can match Sorensen's experience and reputation in power supplies, earned over the past 44 years.

If you're interested in high quality power supplies, contact us at (312) 775-0843 or fill out the coupon and return to us.

Please have a representative contact me.

Please send me your latest full line catalog.

Name _____

Company _____

Title _____

Address _____

City/State/Zip _____

Telephone () _____

Mail to: Marketing Communications Dept.

Sorensen Company

5555 N. Elston Avenue

Chicago, IL 60630

EDN 4-14-88

Simpson® Professional Series

★ Quality and Reliability ★

The **Professional Series** of test instruments are characterized by the uncompromising quality and exceptional reliability that are synonymous with Simpson. The commitment to satisfy the needs of the professional began over 50 years ago with the world famous Simpson 260® and continues with the introduction of the **Professional Series**.

CLASSIC SIMPSON → THE PROFESSIONAL SERIES

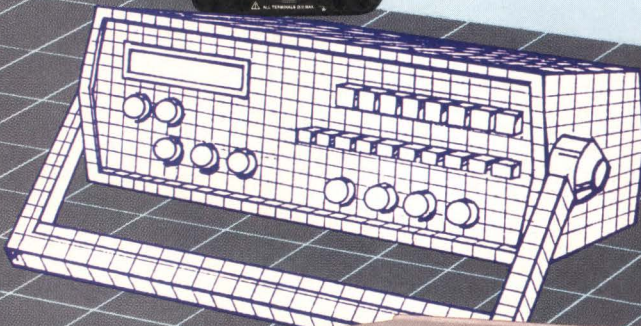

SWEEP/FUNCTION GENERATORS

5 MHz Model 421
5 MHz with 6-Digit Display . Model 422

Features

- .05 Hz to 5 MHz in 7 ranges
- Linear and Log Sweeps
- Sine, Square and Triangle Waveforms
- Selectable Start/Stop Sweep Frequencies
- Internal/External Reading Frequency Counter — Model 422

UNIVERSAL FREQUENCY COUNTERS

200 MHz Model 712
520 MHz Model 713

Features

- Period
- Frequency Ratio
- Time Interval
- 0.56" 8-Digit Orange LED Display
- Adjustable Triggering
- Totalize

Model 712 \$525.00
Model 713 \$675.00
Model 421 \$535.00
Model 422 \$650.00

For information on:
712/713 circle **176**

421/422 circle **177**



SIMPSON ELECTRIC COMPANY

853 Dundee Avenue, Elgin, Illinois 60120-3090
(312) 697-2260 • Telex 72-2416 • FAX (312) 697-2272

A CHIPPEWA NATION TRIBAL ENTERPRISE



If this is how you see LEDs, the ad is over.

The popular myth goes something like this: "An LED, is an LED, is an LED." Or: "If you've seen one, you've seen them all." And of course: "LEDs? They're commodity products." Notions we at Dialight, steadfastly reject. And once you're familiar with our products, you'll know why.

Take our Circuit Board Indicators. Single or multiple discretes aligned in a sturdy plastic housing, complete with their own current limiting resistor. The entire assembly polarity-keyed to guarantee correct insertion.

Each unit is 100% tested—ready to insert for wave soldering. No leads to bend, trim, or break. No time wasted fumbling with discretes.

Dialight pioneered the concept more than fifteen years ago to satisfy the OEM need for fast and reliable circuit board installation of LEDs. And we've been perfecting it ever since. Developing hundreds of standard and custom designs. A heritage of technological advance you can see in our new super-bright gallium aluminum arsenide units.

All meticulously engineered with the understanding that the failure of a "jelly bean product" can cost thousands in end-user downtime, and who-knows-what in customer loyalty.

The same understanding might bring you to call 201-223-9400, or write Dialight Company, 1913 Atlantic Ave., Manasquan, NJ 08736, and ask for our catalog or a product sample. At the very least, it's brought you to the real end of our ad.

See us at Electro '88 Boston May 10-12 Booths 1342-48

DIALIGHT COMPANY A Division of
North American Philips

DIALIGHT · KULKA · HHSMITH

Engineering is the only commodity we sell.



*“A CASE for SUN
in Computer-Aided
Engineering”*



It's a first! CASE Technology now offers its new Vanguard CAE Design System, a comprehensive set of electronic design applications for the system level designer—PCB and ASIC—on the SUN 3 family of engineering workstations. The system includes schematic capture, logic and fault simulation, circuit simulation, and PCB design capabilities.

The full-featured Vanguard system and the SUN 3 workstation represents one of the best values available for a high performance CAE design system. Using Ethernet TCP/IP and NFS, SUN 3 engineering workstations and personal computers can be networked together to create a completely integrated engineering environment.

CASE promotes its flexibility as a front-end CAE design tool for users

concerned with integration of existing tools and as a facility solution for those interested in a single source for all of their CAE needs.

With more than 3000 installed systems worldwide, CASE Technology has developed a solid reputation as a premier supplier of professional CAE design tools. If you haven't seen what CASE has to offer, then now is the time.

CASE Technology Inc., 2141 Landings Drive,
Mountain View, California 94043
Phone (415)962-1440; Telex 506513;
FAX (415)962-1466.

**CASE
TECHNOLOGY**

DESIGN IDEAS

EDITED BY CHARLES H SMALL

Signal-powered switch connects devices

James Dean
National Research Council,
Ottawa, Ontario, Canada

Fig 1's switch can selectively connect a terminal, personal computer, or any other originating device (DTE) to one of four receivers such as modems and printers. Using a thumbwheel switch, you select which device you want to connect. The circuit handles data rates to 19.2k baud without any signal degradation or crosstalk.

Four Maxim DG509A dual 4-channel multiplexers switch the eight critical RS-232C lines. The Maxim multiplexers suit this application because they consume only 20 μ A typ, handle ± 18 V signals, exhibit only 130 Ω on-resistance typ, and have input protection.

The unit doesn't require an external power supply because it gets its power from the RS-232C ready lines (DTE pins 4 and 20, DCE pins 5, 6, and 8); the S17661 converter provides the negative supply. The Schottky power diodes in the dual-diode MBR2045CT packages ensure that the switch draws its power from whichever connected device has the highest output voltage at its RS-232C connector. The low forward-voltage drop of these diodes guarantees that the internal-protection diodes of the switch ICs do not conduct. The circuit's V^+ supply is merely one Schottky-diode drop below the highest signal potential.

EDN

To Vote For This Design, Circle No 750

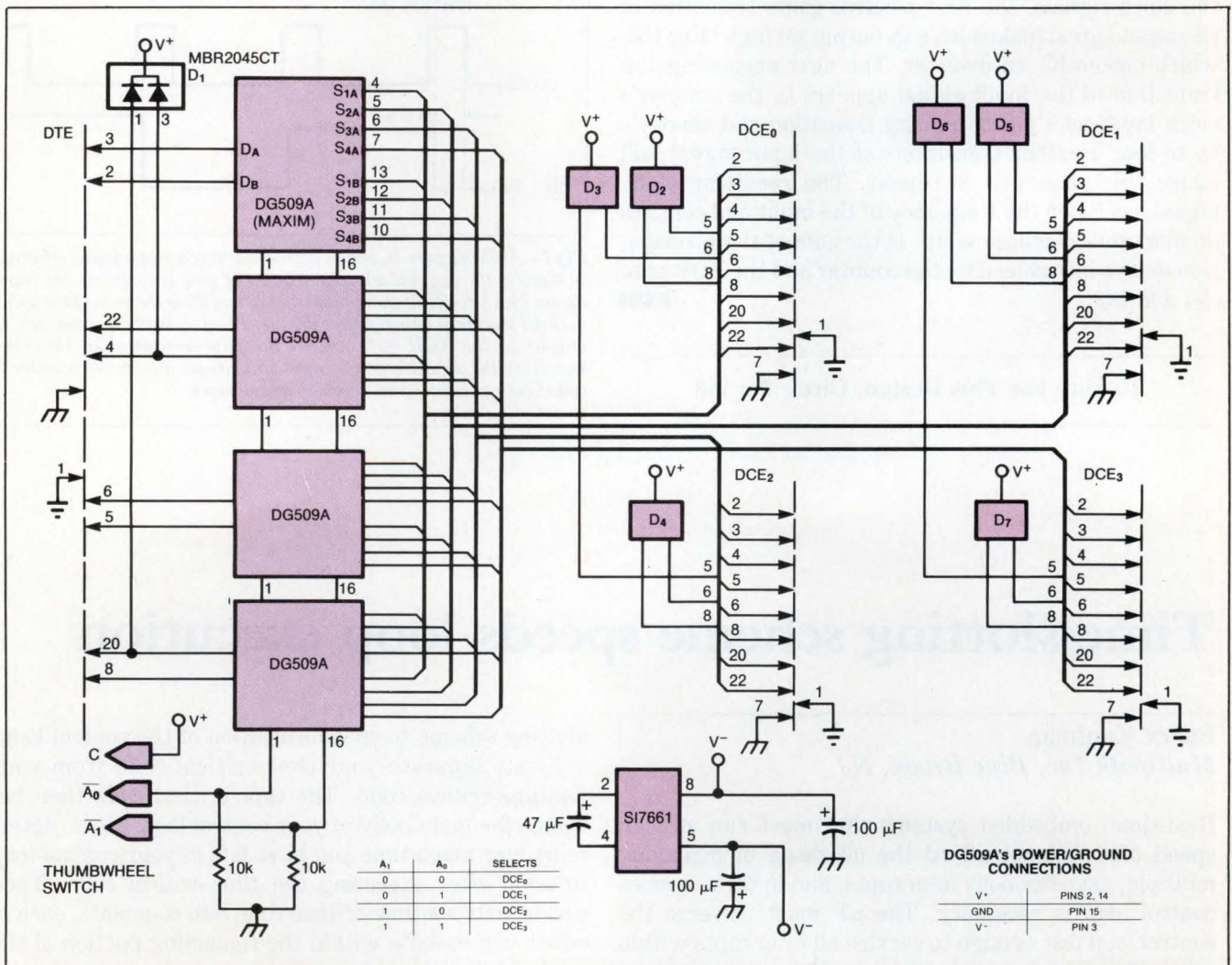

Fig 1—This signal-powered selector uses analog switches to connect one of four RS-232C devices to a terminal or personal computer.

XOR gate doubles counting frequency

Andrew Gorajek
Adelaide Microelectronics Centre, Technology
Park, The Levels, South Australia

Suitable for noisy industrial environments and requiring no passive components, the frequency doubler in Fig 1 inserts an XOR gate into the first stage of a digital counter. The circuit works with virtually any counter and XOR gate. An XOR gate, in series with the counter's clock input, works as a digitally controlled inverter. The gate gets its control signal from the counter's first-stage output, Q_0 .

After resetting, output Q_0 is low and the MC14070B XOR gate, IC₁, acts as a noninverting buffer. Because the MC14518 counter, IC₂, counts on the rising edges of the clock signals, the first positive-going transition of the input signal makes IC₂'s Q_0 output go high (Fig 1b), which makes IC₁ an inverter. The next negative-going transition of the input signal appears to the counter's clock input as a positive-going transition and changes Q_0 to low. Further transitions of the input signal will cause this sequence to repeat. The resulting clock signal has twice the frequency of the input and consists of short pulses whose width is the sum of the propagation delays introduced by the counter and the XOR gate (t_{P1} and t_{P2}).

EDN

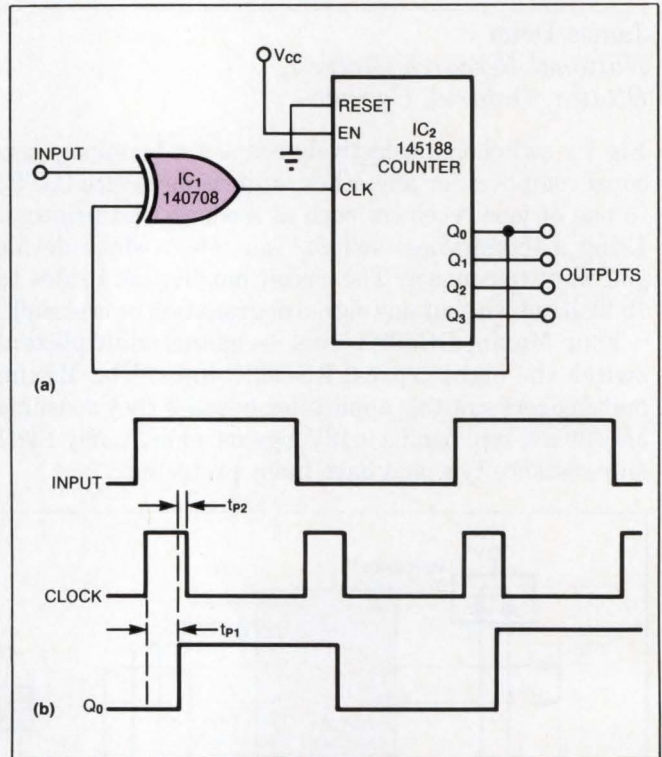

Fig 1—An XOR gate in series with a counter's clock input effectively doubles the input-clock rate. The XOR gate transforms the input signal into a series of short pulses whose width is the sum of the gate's and the counter's propagation delays. Feeding back the counter's Q_0 output to the XOR gate makes the gate a controlled inverter. Inverting the negative-going input transitions allows the counter to count both positive- and negative-going edges.

To Vote For This Design, Circle No 748

Time-slotting scheme speeds loop execution

Barry Kaufman
Multipath Inc, Pine Brook, NJ

Real-time, embedded systems that must run at high speed often cannot afford the overhead of managing multiple, asynchronous interrupts, and in these cases a control loop is necessary. The μ P must traverse the control loop fast enough to service all interrupts within a specified time interval, however. If your control-loop program is too long, you can employ a simple time-

slotting scheme to speed execution of the control loop.

First, separate your time-critical code from your nontime-critical code. The time-critical code then becomes the main body of your control loop. Next, determine how much time you have left in your control-loop interval after executing the time-critical code. Then divide your nontime-critical code into segments, each of which can execute within the remaining portion of the control-loop interval.

In Listing 1, a selector mechanism inserted at the



value-packed
filters from **\$9.95**

dc to 3GHz

- less than 1dB insertion loss over entire passband
- greater than 40dB stopband rejection
- 5 section, 30dB per octave roll-off
- VSWR less than 1.7 (typ)
- over 100 models, immediate delivery
- meets MIL-STD-202
- rugged hermetically sealed package (0.4 x 0.8 x 0.4 in.)
- BNC, Type N, SMA available

finding new ways ...
 setting higher standards

Mini-Circuits

A Division of Scientific Components Corporation
 P.O. Box 350166, Brooklyn, New York 11235-0003 (718) 934-4500
 Fax (718) 332-4661 Domestic and International Telexes: 6852844 or 620156

LOW PASS	Model	*LP-	10.7	21.4	30	50	70	100	150	200	300	450	550	600	750	850	1000
Min. Pass Band (MHz) DC to			10.7	22	32	48	60	98	140	190	270	400	520	580	700	780	900
Max, 20dB Stop Frequency (MHz)			19	32	47	70	90	147	210	290	410	580	750	840	1000	1100	1340

Prices (ea.): P \$9.95 (6-49), B \$24.95 (1-49), N \$27.95 (1-49), S \$26.95 (1-49)

HIGH PASS	Model	*HP-	50	100	150	200	250	300	400	500	600	700	800	900	1000
Pass Band (MHz)	start, max.		41	90	133	185	225	290	395	500	600	700	780	910	1000
	end, min.		200	400	600	800	1200	1200	1600	1600	1600	1800	2000	2100	2200
Min. 20dB Stop Frequency (MHz)			26	55	95	116	150	190	290	365	460	520	570	660	720

Prices (ea.): P \$12.95 (6-49), B \$27.95 (1-49), N \$30.95 (1-49), S \$29.95 (1-49)

*Prefix P for pins, B for BNC, N for Type N, S for SMA [example: PLP-10.7](#)

DESIGN IDEAS

end of the time-critical code successively runs one segment of nontime-critical code during each pass through the control loop. The code initializes a time-slot index prior to entering the endless control loop. The index-control routine located at the bottom of the loop increments the index (or resets it to 1 after reaching the maximum count). Each nontime-critical routine runs only if its time-slot identification number equals the index. Although this example uses a RAM location for the index, you can employ an unused μ P register.

Alternatively, you can use an even simpler scheme in

which the main control loop jumps directly to the start of a particular nontime-critical segment based on an address found in a variable. Each segment, as it runs, then overwrites this variable's contents with the starting address of the next segment in the round-robin chain of nontime-critical segments. This scheme eliminates the overhead of maintaining the index and bypassing unselected nontime-critical routines.

To Vote For This Design, Circle No 746

LISTING 1—TIME-SLOTTING SCHEME FOR Z80 PROGRAM

```
; EXAMPLE OF TIME SLOTTING TO INCREASE SPEED
;
; ***** INITIALIZATION *****
;
INDEX:   EQU   ADDR       ; addr = RAM address of the index.
;
;         LD A,1          ; load accumulator with 1.
;         LD (INDEX),A    ; put it in RAM address "INDEX".
;
;
; START:                ; Top of the endless loop.
;
; ***** TIME CRITICAL CODE *****
;
;                               ; This section of the loop is
;                               ; for your time critical code.
;                               ; The code is not time slotted.
;                               ; It will run on every pass
;                               ; through the loop.
;
; ***** NON TIME CRITICAL CODE *****
;
;
; T SLOT1:  LD A, (INDEX)   ; Load RAM index into accumulator.
;           CP 1           ; compare with time slot id. #1
;           JP NZ, T SLOT2 ; (could be 1 - 4 for this example).
;                               ; jump to next routine if this is
;                               ; not slot #1.
;
;                               ; This section of the loop is for
;                               ; your non time critical code
;                               ; that runs in time slot #1.
;
; T SLOT2:                ; Same as above but for next time slot.
;
; ***** INDEX CONTROL CODE NEAR BOTTOM OF LOOP *****
;
;           LD HL, INDEX   ; HL points to index address in RAM.
;           LD A, 4        ; Load acc. with highest time slot #.
;           CP (HL)        ; Is index at highest #?
;           JP Z, RESIND   ; Jump if yes.
;           INC (HL)       ; Otherwise increment the index
;           JP FINISH     ; and go to bottom of the loop.
;
; RESIND:   LD A, 1        ; load accumulator with 1.
;           LD (HL), A     ; and reset the index in RAM.
;
;
; FINISH:   JP START      ; Loop again but with new index #.
```

Chopper Amplifiers Complement a DC Accurate Low-Pass Filter

Nello Sevastopoulos

Monolithic switched-capacitor low-pass filters, although they offer precise frequency responses, cannot usually be used for DC accurate applications because of their prohibitive DC offsets and poor gain linearity. The LTC1062, however, is quite different from currently available low-pass switched-capacitor filters because it uses an external (R, C) to isolate the IC from the input-signal DC path and to provide antialiasing for incoming signals larger than half its clock frequency. The LTC1062 is ideal when used in conjunction with high performance chopper-stabilized op amps.

The LTC1050 is an ultra low offset, low noise chopper with the sampling capacitors internal. It can remove residual clock noise without adding further DC error. Also, the internal capacitor minimizes board area.

Figure 1 shows a low cost, 7th order DC accurate, 10Hz low-pass filter where amplitude and phase response closely ap-

proximates a Bessel filter. The required clock frequency is 2kHz, thus yielding a clock to cutoff frequency ratio of 200:1.

The LTC1050 is configured as unity gain 2nd order low-pass filter which center frequency is $(1.2\pi R'C') = 1.72 \times f_{CUT-OFF} = 17.2\text{Hz}$ and $Q = 0.5$. Figure 2 shows the amplitude response of the filter, and Figure 3 shows a well behaved transient response for which Bessel filters are famous. The power supplies used were $\pm 8\text{V}$ to provide a total DC input common-mode range of $\pm 6\text{V}$. The measured wideband noise was $52\mu\text{Vrms}$. The clock, and R, C values of Figure 1 can be easily modified to provide a 7th order Butterworth 10Hz filter, such as: $f_{CLK} = 1\text{kHz}$, $R = 26.7\text{k}$, $C = 1\mu\text{F}$, $R' = 165\text{k}$, $C1 = 0.2\mu\text{F}$ and $C2 = 0.047\mu\text{F}$. The diode at LTC1062 pin 3 should be used to protect the device from incoming signals above the power supplies.

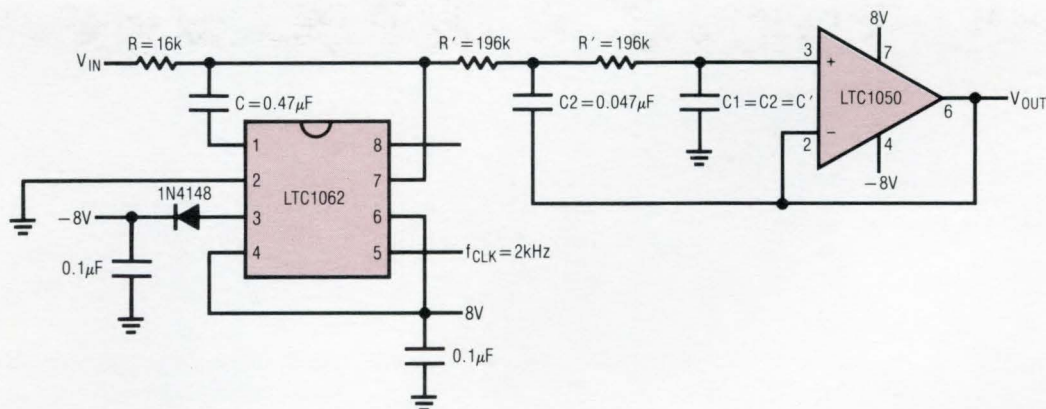

Figure 1. Combining the LTC1050 Chopper Op Amp with the LTC1062 to Provide a 10Hz, DC Accurate Low-Pass Bessel Filter

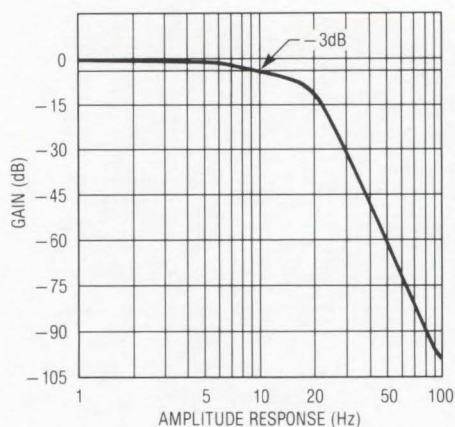

Figure 2. Amplitude Response of Figure 1, Providing a Close Approximation to a Bessel Filter

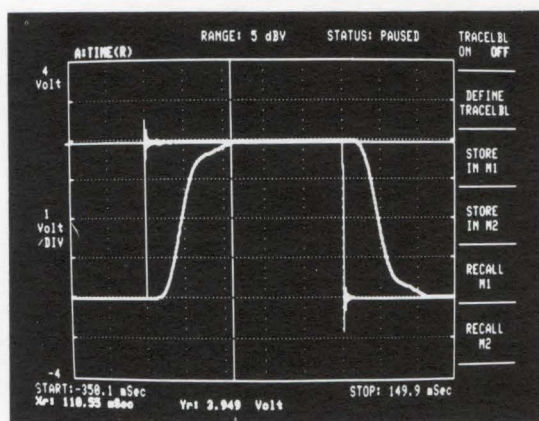

Figure 3. Transient Response of the Bessel Low-Pass Filter of Figure 1

In Figure 4, an external (R1, R2, C1) network is used at the input-output of the internal buffer of the LTC1062 (pins 7 and 8), to provide an additional 2 pole, $Q = 0.707$, high-pass filter. The filter output at pin 8 is bandpass, Figure 5, whereas the DC accurate Butterworth low-pass filter is still available at the output of the LTC1050. This circuit allows the user to separate the DC and AC components of an incoming signal, V_{IN} . Here, the LTC1050 buffers the low-pass filter section of the overall bandpass filter. For a $Q = 0.707$, the design equation for the high-pass sections are straightforward: set $R2 = 2R1$;

and then the high-pass cutoff frequency is, $f_c = (0.707 / 2\pi R1 C1)$. The circuit in Figure 4 can be easily operated with a single supply, because resistor R2 and capacitor(s) C1 of the high-pass section, also DC bias pin 7 at mid supplies independently of the DC input voltage. If only a single supply is available, simply bias the bottom side of R2 at half supply.

For Filter literature call 800-637-5545. For help with an application call (408) 432-1900, Ext. 361.

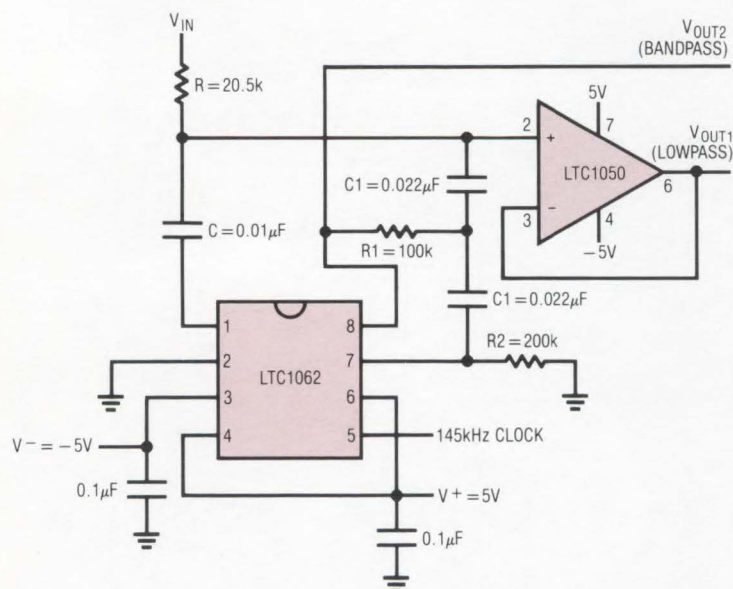

Figure 4. A Bandpass, DC Accurate Lowpass Filter Combination used to Extract the AC Information from a DC + AC Input Signal

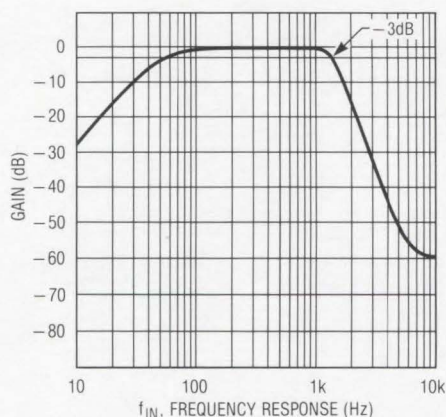

Figure 5. Frequency Response of the Bandpass Filter Output, V_{OUT2} , of Figure 4

Algorithm determines highest priority task

S Murugesan
ISRO Satellite Centre, Bangalore, India

The fastest real-time systems often use hardware priority encoders, but you can replace such special-purpose hardware with a software routine based on the successive-refinement algorithm in Fig 1's flowchart. The algorithm works with an 8-bit word; each of the word's asserted bits represents a prioritized task, T_P , needing attention. The most significant bit corresponds to the highest priority task, the least significant bit to the lowest. The algorithm zeros in on the highest priority asserted bit regardless of how many lower-priority bits are asserted.

This algorithm is much faster than the usual shift-

and-test method of finding the highest priority asserted bit. Instead, it performs a series of tests and branches based on the value of the 8-bit word. Either high-level languages or assembly-level code can handle the simple comparisons and branches, and you can easily extend the algorithm to handle more than eight tasks. Simply use as many 8-bit words as necessary to accommodate the number of tasks you must prioritize. Before using the algorithm, test the bytes in descending order of priority to determine which is the most significant nonzero byte, and then submit that byte to the algorithm.

EDN

To Vote For This Design, Circle No 749

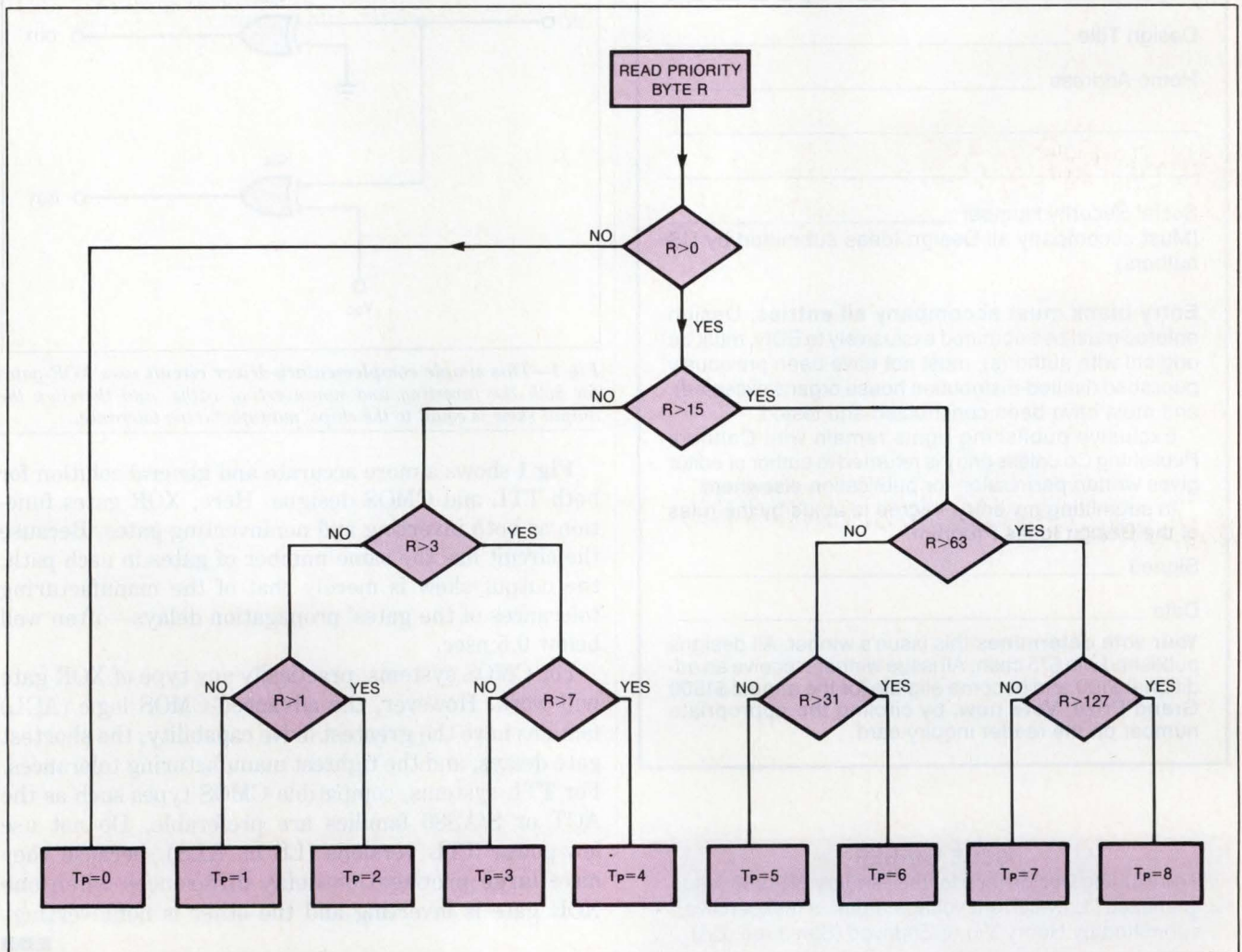

Fig 1—This easily encoded, successive-refinement algorithm homes in on the most significant asserted bit in an 8-bit word. Each asserted bit represents a prioritized task (T_P) requesting attention. This algorithm is faster than conventional shift-and-test methods.

Design Entry Blank

\$75 Cash Award for all entries selected by editors. An additional **\$100 Cash Award** for the winning design of each issue, determined by vote of readers. Additional **\$1500 Cash Award** for annual Grand Prize Design, selected among biweekly winners by vote of editors.

To: Design Ideas Editor, EDN Magazine
Cahners Publishing Co
275 Washington St, Newton, MA 02158

I hereby submit my Design Ideas entry.

Name _____

Title _____ Phone _____

Company _____

Division (if any) _____

Street _____

City _____ State _____ Zip _____

Design Title _____

Home Address _____

Social Security Number _____
(Must accompany all Design Ideas submitted by US authors)

Entry blank must accompany all entries. Design entered must be submitted exclusively to EDN, must be original with author(s), must not have been previously published (limited-distribution house organs excepted), and must have been constructed and tested.

Exclusive publishing rights remain with Cahners Publishing Co unless entry is returned to author or editor gives written permission for publication elsewhere.

In submitting my entry, I agree to abide by the rules of the Design Ideas Program.

Signed _____

Date _____

Your vote determines this issue's winner. All designs published win \$75 cash. All issue winners receive an additional \$100 and become eligible for the annual \$1500 Grand Prize. **Vote now**, by circling the appropriate number on the reader inquiry card.

ISSUE WINNER

The winning Design Idea for the January 21, 1988, issue is entitled "Low-current voltage tripler is inexpensive," submitted by Henry Yio of Endevco (San Juan, CA)

XOR gates generate complementary signals

Kálmán L J Molnár

Consultant, München, West Germany

Some applications, such as driving 3-state buffers for data multiplexers or for biphasic clocks in high-speed systems, require complementary signals having a small time skew and nearly simultaneous transitions. An earlier Design Idea ("Transmission gate improves clock driver," EDN, November 12, 1987, pg 287) uses a transmission gate to equalize the path delays. Although this scheme results in an output skew of less than one-half of a gate delay, it works only for CMOS designs.

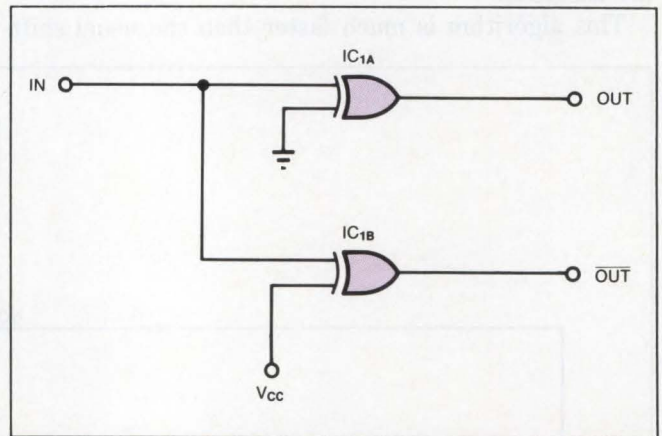

Fig 1—This simple complementary-driver circuit uses XOR gates for both the inverting and noninverting paths, and therefore the output skew is equal to the chips' manufacturing tolerance.

Fig 1 shows a more accurate and general solution for both TTL and CMOS designs. Here, XOR gates function as both inverting and noninverting gates. Because the circuit has the same number of gates in each path, the output skew is merely that of the manufacturing tolerances of the gates' propagation delays—often well below 0.5 nsec.

For CMOS systems, practically any type of XOR gate will work. However, the advanced-CMOS logic (ACL) families have the greatest drive capability, the shortest gate delays, and the tightest manufacturing tolerances. For TTL systems, compatible CMOS types such as the ACT or S/AS86 families are preferable. Do not use low-power TTL versions (LS or ALS), because they have large propagation-delay differences when one XOR gate is inverting and the other is noninverting.

EDN

To Vote For This Design, Circle No 747

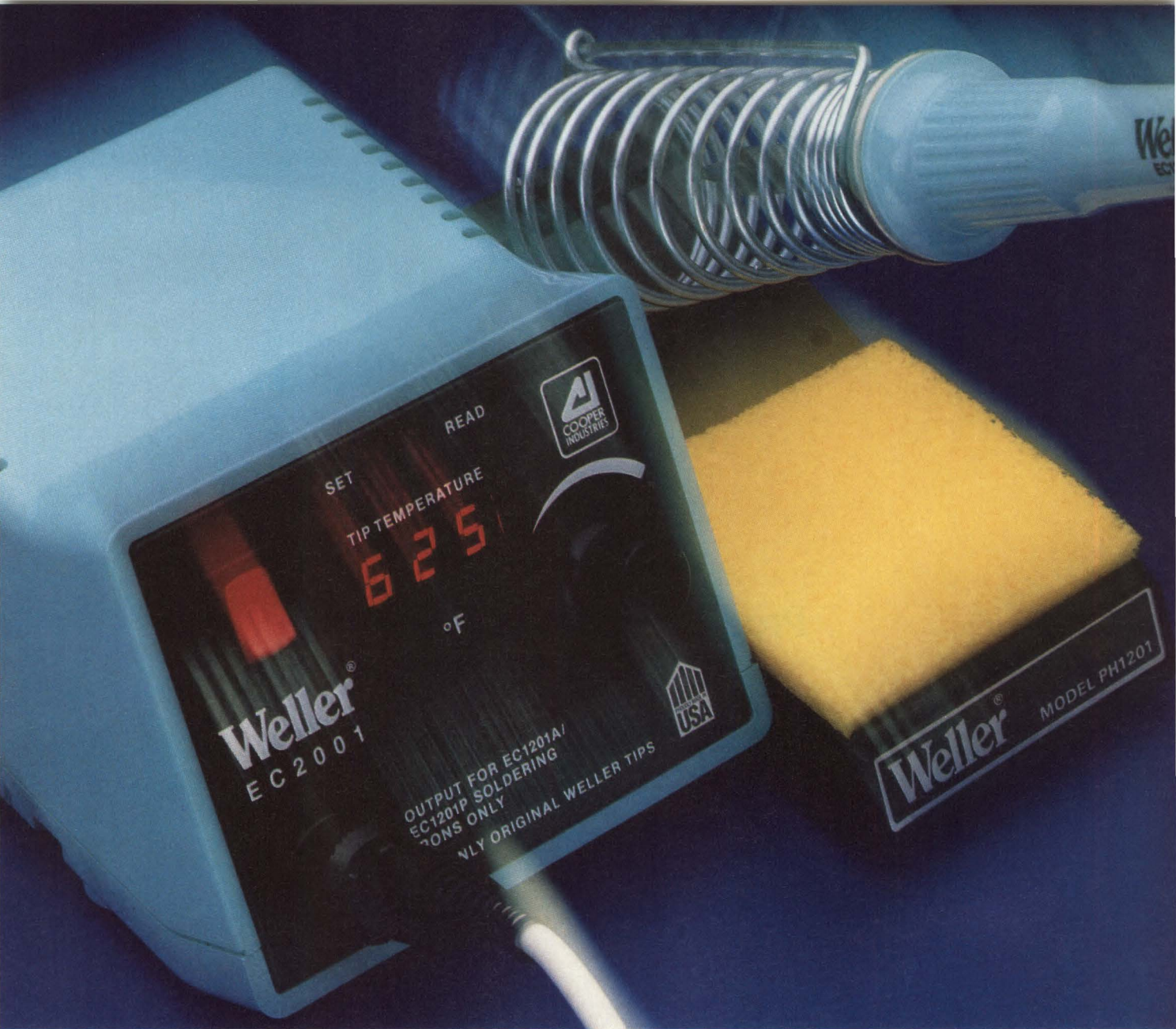

WE ALWAYS KEEP AHEAD OF OUR REPUTATION.

Keeping up with the needs of today's electronics is no simple task, but over the years we've got ourselves quite a name for being the front runner in soldering technology.

The investment in research and development continues to produce stations and irons that make your

work more accurate, more efficient and easier too.

Although building a reputation is not easy, if you take a close look at the quality of Weller® soldering equipment, you'll see just how far ahead we are.

Weller®. How reputations are made.

CooperTools

The difference between work and workmanship.

BREWER-TITCHENER™ CAMPBELL® COVERT® CRESCENT® LUFKIN® MERRILL NICHOLSON® PLUMB® H.K.PORTER™ TURNER® WELLER® WIRE-WRAP® WISS® XCELITE®

CooperTools PO Box 728 Apex NC, 27502 USA Tel (919) 362-7510 Telex 579497

A division of Cooper Industries

BERTAN

The New Era in High Voltage

Series 225 IEEE-488

Programmable High Voltage Power Supply

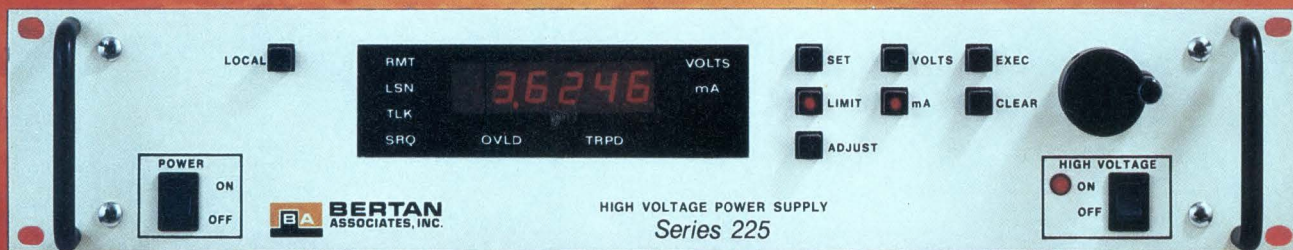

BERTAN introduces Series 225 — an innovation that brings together years of experience in precision high voltage and digital processing. The result is an extremely versatile system offering high voltage control and monitoring through a built-in IEEE-488 interface, front panel or remote analog input. Series 225 provides highly accurate user programmable output setting and reporting capabilities. This unit also offers user-selectable overload protection. Series 225 is ideally suited for system or laboratory applications.

Integrated IEEE-488 Interface
Programmable Operating Modes
0.001% Regulation
0.1% Setting & Monitor Accuracy
Low Ripple & Noise
Diagnostic Self-Testing
Load Protective Circuitry
Laboratory & System Applications

MODEL	HV OUTPUT
225-01R	0 to \pm 1kV @ 30mA DC
225-03R	0 to \pm 3kV @ 10mA DC
225-05R	0 to \pm 5kV @ 5mA DC

Call your local representative or BERTAN'S Application Engineering Department for more information on Series 225. Inquiries about custom designs or OEM requirements are also invited. Ask for latest catalog featuring full lines of precision high voltage power supplies, instrumentation and accessories for X-Ray, CRT, ATE, Medical, Laboratory, Nuclear, E-Beam, Electro-Optical, Analytical and semi-conductor applications.



BERTAN ASSOCIATES, Inc.

The Leader in High Voltage for Two Decades

121 New South Road, Hicksville, NY 11801
(516) 433-3110 • TWX 510-221-2144

MOVING AIR IS EASY

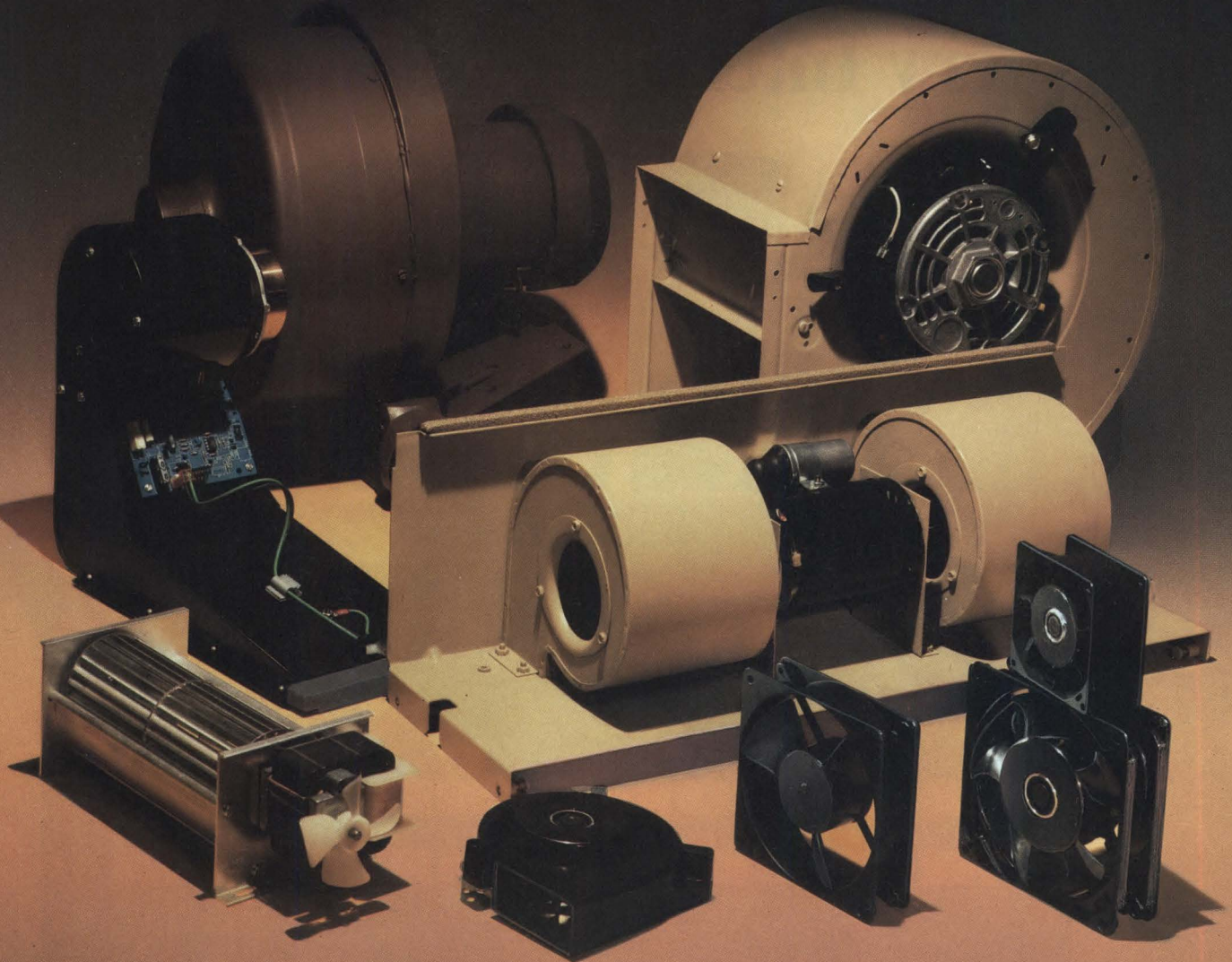

CONTROLLING IT TAKES AN EXPERT

With the TORIN line of blowers, FASCO specializes in creating solutions to air-moving problems. Over 50 years of experience has established our reputation for leadership in custom blower design. Applications include cooling for electronic, business machine, aerospace and military products.

Our design expertise covers single, dual and multi-stage centrifugal blowers, transverse-flow blowers, mixed-flow blowers, cabinet blowers, tube and vane-axial fans. We provide country-wide factory sales coverage, in-house availability of electric motors and cost-effective production capabilities.

Call on us when your air-moving requirements exceed the ordinary. Our product line is limited only by your imagination.



FASCO INDUSTRIES, INC.
MOTOR DIVISION HEADQUARTERS
500 Chesterfield Center
Suite 200
St. Louis, MO 63017
(314) 532-3505/Telex: 44-7455
Telecopy: (314) 532-9306

V.I.P.TM means Very Interesting Possibilities

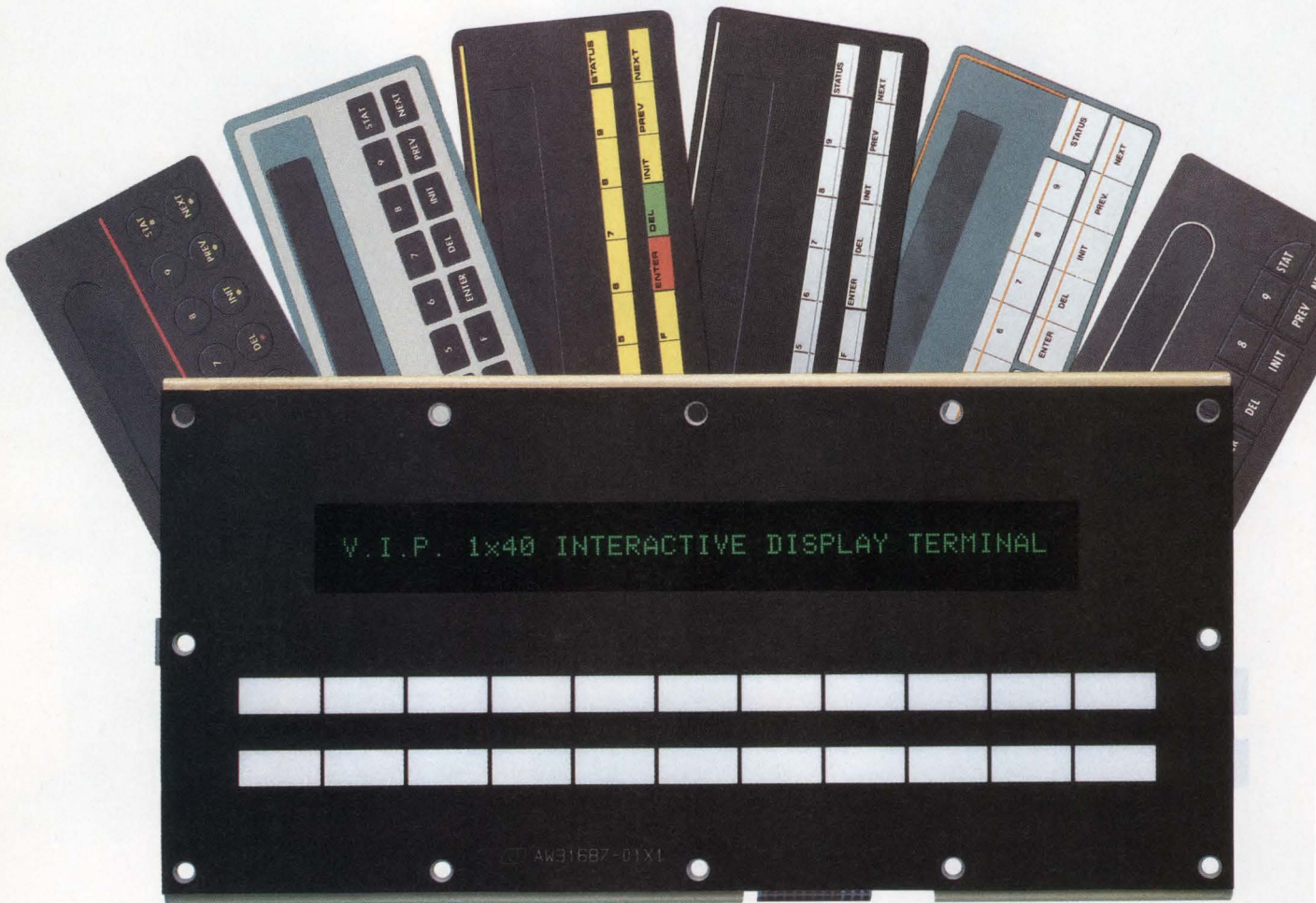

Maybe you're under some very intense pressure because you need to design a very important product and it has to have a very impressive (front) panel. You've suffered from vacillation, indecision, and procrastination. So now it's time to consider **V.I.P.TM**

V.I.P. is an integrated display/keyboard system. It's a virtually ideal product for applications that require a "mini-terminal" with an operator interface. Because the "slide-in" switch legends can be easily customized by the user to suit his or her needs, **V.I.P.** provides some very interesting possibilities.

But that's not all. Just look at the variety of invaluable pheatures (sorry):

- Operates from a single +5VDC power supply.
- RS-232 interface
- Easily seals to the front panel of your equipment for operation in dirty or wet environments.
- Custom artwork/legends are optional.

So if you need a versatile, intelligent product to enhance your front panel, give us a call at **IEE** where you're always treated like a very important person.



INDUSTRIAL ELECTRONIC ENGINEERS, INC.
Industrial Products Division
7740 Lemona Ave., Van Nuys, CA 91409-9234
Tel.: (818) 787-0311, Ext. 418 • Telex: 4720693 IEE IF
FAX: (818) 901-9046 (G2/G3)

Circle No. 107 for immediate application

Circle No. 108 for reference material



Panasonic® 100 MHz oscilloscopes. Your choice for reliability and mobility.



VP-5610P. The little scope that goes a long way.

How many features can you pack into the smallest 100MHz auto-ranging scope on the market? More than enough to go from field...to factory...to lab...with ease.

In fact, the VP-5610P gives you many of the most valued features of a bench scope. Its impressive list includes three independent channels, microprocessor control, an optional GP-IB interface, digital readout and either AC or optional DC operation. It handles dual X-Y operations and offers solid state switching that's virtually impervious to moisture and contact noise.

What's more, combining a bench and field scope into a single package with a competitive price makes it the one you can't afford to do without.



VP-5740P. Our smartest combination analog/digital oscilloscope ever.

The VP-5740P is so smart, it thinks for itself. It can run a program of up to 1000 steps and get your measurements automatically. It can read high-speed transient signals using its 100MHz sampling clock and three 10 kiloword memories. And it provides functions like flash conversion and 100 megasamples per division to keep work moving.

As for smart design, the VP-5740P features a full 7" display to view accumu-

lated and memory waveforms or related digital information. A GP-IB interface is built in. So are a host of calculating functions which include not only addition, subtraction, multiplication and division but advanced functions such as integration, differentiation, square and square root.

Also, when used as a nonstorage scope, the VP-5740P delivers a 100 MHz dual trace plus delayed sweep.

Panasonic scopes are the choice for reliability — and mobility. And that's where today's smart money's going.

For more information or a demonstration, contact your local Panasonic representative, or: Panasonic Industrial Company, Instrumentation Dept./MSD, Two Panasonic Way, Secaucus, NJ 07094. (201) 392-4050.

Panasonic Industrial Company

NEW

500 to 1600 WATT POWER SUPPLIES

NEW 1600W MULTI

The industry's SMALLEST 1600W Multi output package. ACDC's JFM Series features unlimited flexibility of output voltage & current combinations.

Any combination you choose will be delivered in 2 weeks.

NEW 1000W & 800W MULTI'S

Don't compromise on output voltage. ACDC's REV 1000/800W Series has the output combination your design requires.

And you can have it in 2 weeks!

NOT NEW 1500W, 1000W, 750W SINGLES

High performance, competitive pricing and 2 week delivery have made this the most popular "slot" supply in the industry. Unequivocably.

WATTS	SINGLE	MULTI UP TO 5 OUTPUTS
1600		NEW
1500		
1000		
800		
750		
500		

1600w 1500w 1000w 800w 750w 500w 400w 300w 220w 175w 135w 70w 40w 15w

ACDC's POWER OFFERING

NEW FEATURES

- IEEE 587 input surge protection
- Current mode control
- Single wire paralleling
- On-board EMI filter (FCC Docket 20780, Class A and VDE 0871, Class A)
- Largest offering of standard options
- Active preload
- Dynamic soft-start
- International safety certifications

NOT NEW

Building quality, reliable power supplies that meet specifications, is not new at ACDC Electronics. We've been doing that for over 30 years.

HIGH POWER COVERAGE

No one else offers such extensive coverage in high power. Check the chart below to solve your 500-1600W power requirements.

PROVEN

Our power supplies have been PROVEN and PROVEN. Our NEW power supplies are based on these PROVEN designs.

Need more proof? Call for a DEMO TODAY. (619) 439-4200

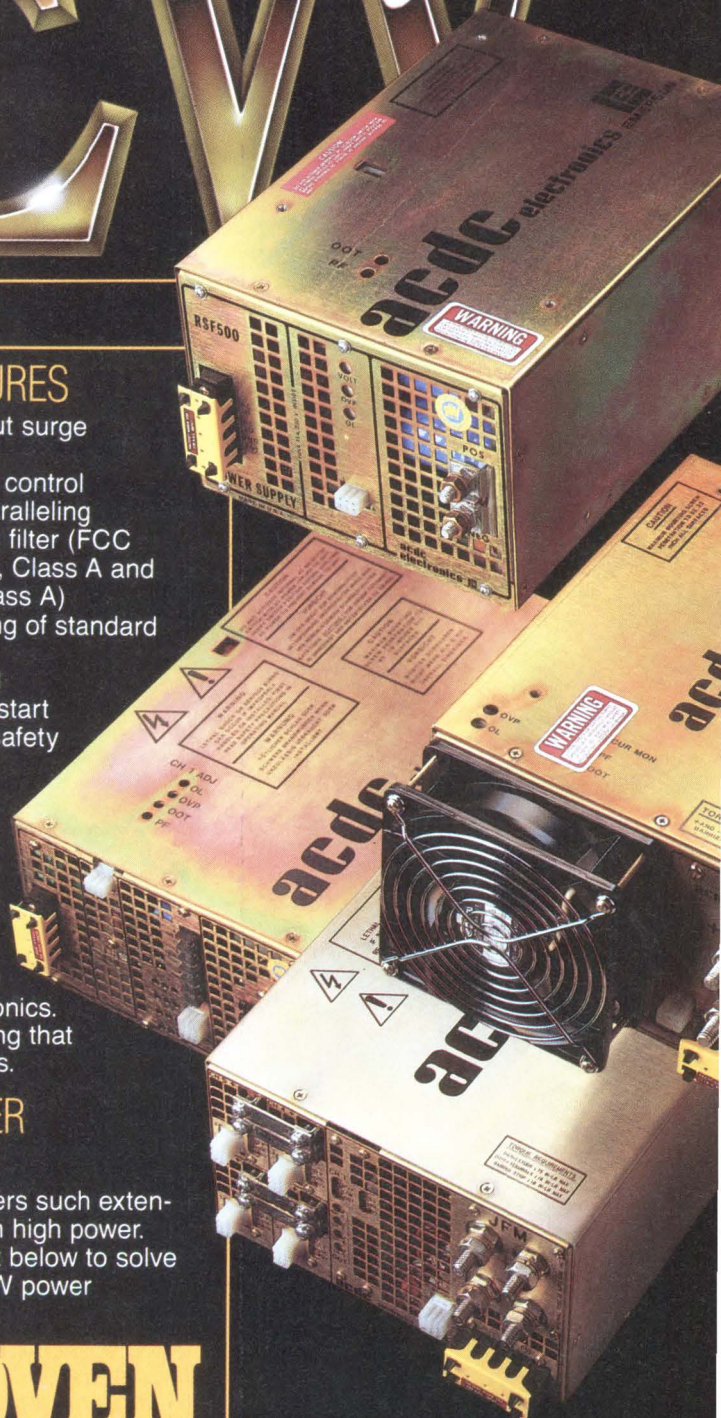

401 Jones Road, Oceanside, CA 92054
TEL: 619/757-1880. TLX: 350227. FAX: 619/439-424

acdc
electronics

Switch with Liton

20-1,000W-Meets FCC, UL, CSA, TUV and VDE standards

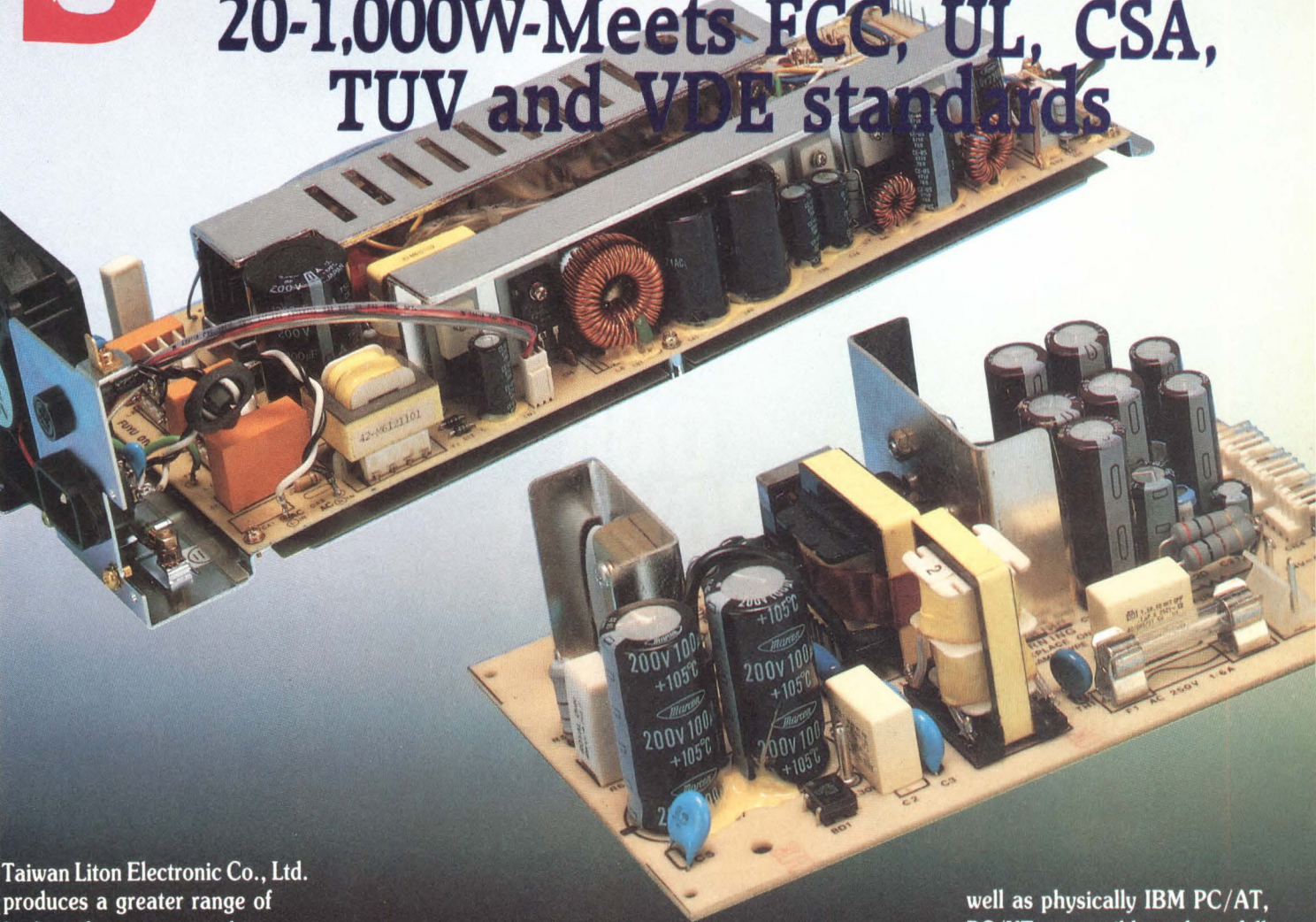

Taiwan Liton Electronic Co., Ltd. produces a greater range of high-performance switching power supplies than most any other manufacturer anywhere: 20-1,000W. By customizing cost-saving standard models with an alternative component or two, available SPS configurations run into the thousands. Design and production fully meets FCC class "B", UL, CSA TUV and VDE standards. Applications include PCs and workstations, telecommunications equipment, as well as OA equipment like facsimile machines, copiers and printers. PC models are electrically as

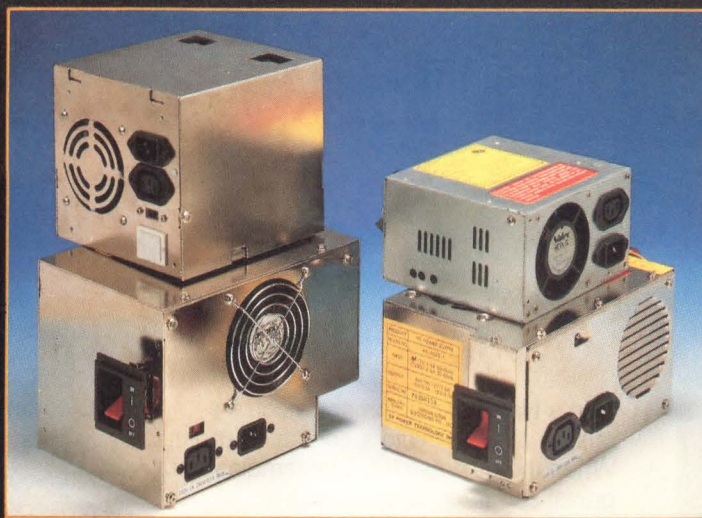

well as physically IBM PC/AT, PC/XT compatible and are full-power rated and wired for hard-disk or tape drives, as well as other peripherals. We've built our reputation with top-quality components. With gigantic facilities and modern equipment, we design and manufacture computer and communications products which meet the highest international quality control and performance standards. Our R&D customizes a standard model or generates a 100% original design in a lead time worth switching for!

Taiwan Liton Electronic Co., Ltd.

12th Fl., 25 Tunhwa S. Rd., Taipei, Taiwan, ROC

Tel: (02) 771-4321/8 Fax: 886-2-751-1962 Tlx: 24514/20211 TWLITON

*IBM PC/AT and PC/XT are trademarks of the International Business Machines Corp.

CIRCLE NO 111

OUR POWER SUPPLY SURVIVED.



In a Navy test, a Tomahawk cruise missile exploded into a concrete building. When the dust settled, little remained but gravel and fragments of casing.

And the Abbott model C28D0.8 you see here.

Its aluminum baseplate and an adjustment cap were ripped off in the blast. But reconnected on a workbench, the

unit still provided a steady .8 amp of DC current — just as it was designed to.

Abbott Transistor Laboratories, Inc.
2721 South La Cienega Blvd.,
Los Angeles, CA 90034. (213) 936-8185

When reliability is imperative®

abbott
MILITARY POWER SUPPLIES



NEW PRODUCTS

INTEGRATED CIRCUITS

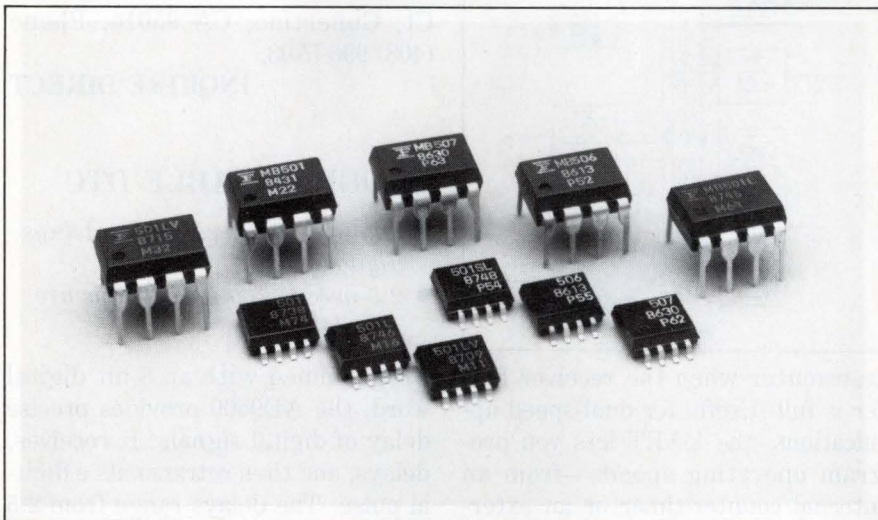

ECL PRESCALERS

- Include low-power versions
- Accept input frequencies to 1 GHz

The MB501 family encompasses four types of ECL prescalers. The standard version consumes 30 mA at 5V. The 501L and 501SL consume 10 and 5 mA, respectively. The 501LV is a low-voltage device that operates from a 3V supply and consumes 12 mA. The prescalers divide the input

frequency by a modulus of 64 or 128. A pulse-swallow feature allows the prescalers to implement a modulus of 65 or 129. All members of the MB501 family have output levels of 1.6V p-p, except for the MB501LV version, which produces 1.1V p-p. The devices come in flatpacks or in 8-pin DIPs. \$3 to \$7 (1000).

Fujitsu Microelectronics Inc., 3320 Scott Blvd, Santa Clara, CA 95054. Phone (408) 562-1000.

Circle No 351

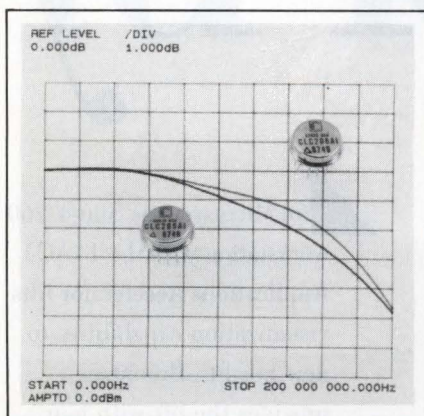

OP AMPS

- Provide bandwidths to 180 MHz
- Feature slew rates of 2400 and 3400V/μsec

The CLC205 and CLC206 wideband op amps use current feedback to

achieve their high speed. The CLC205 provides a small-signal (-3 dB) bandwidth of 170 MHz, a rise time of 2.2 nsec, a settling time (to 0.1%) of 22 nsec, and a slew rate of 2400V/μsec. The device can supply 50 mA of output current. The CLC206 has a small-signal bandwidth of 180 MHz, a rise time of 2 nsec, a settling time of 19 nsec, and a slew rate of 3400V/μsec. The IC can supply 100 mA of output current. Both devices come in versions for the industrial and military temperature ranges. Military-grade versions, \$56; industrial-grade versions, \$138 (100).

Comlinear Corp., 4800 Wheaton Dr, Fort Collins, CO 80525. Phone (303) 226-0500.

Circle No 352

24-PIN PAL ICs

- Feature high-speed operation
- Come in combinatorial and registered output types

PAL20R8-12 programmable array logic (PAL) ICs provide 12-nsec propagation delays, making them some 20% faster than competing 24-pin PAL devices, including the vendor's own line of 15-nsec devices. The ICs come in a variety of types with combinatorial and registered outputs. The PAL20L8-12 has eight combinatorial outputs; the PAL20R8-12 has eight registered outputs; the PAL20R6-12 has two combinatorial and six registered outputs; and the PAL20R4-12 has four combinatorial and four registered outputs. You can obtain the devices in plastic or ceramic 24-pin SkinnyDIPs, and in 28-pin PLCCs. PAL20R8-12, in a DIP, \$15.85 (100).

Advanced Micro Devices, 901 Thompson Pl, Box 3453, Sunnyvale, CA 94088. Phone (408) 732-2400.

Circle No 353

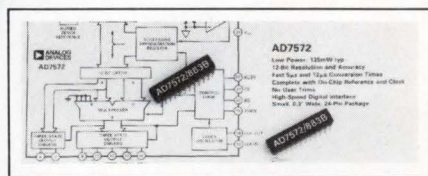

HIGH-SPEED ADC

- Provides 12-bit resolution
- Features 5-μsec conversion time

The AD7572 12-bit A/D converter is processed to MIL-STD-883B rev C and offers a 5-μsec max conversion time. It features single-chip construction and provides an SMD (standard military drawing) that simplifies device selection and qualification. Its maximum integral nonlinearity is ± 0.5 LSB, and its maximum differential nonlinearity equals ± 1 LSB. The device provides a power dissipation of 135 mW typ

and includes an on-chip reference and an oscillator-clock. You can obtain it in a 24-pin ceramic DIP or in a 28-terminal PLCC. From \$135.50 (100).

Analog Devices, Literature Center, 70 Shawmut Rd, Canton, MA 02021. Phone (617) 935-5565. TWX 710-394-6577.

Circle No 354

CMOS UART

- Pin compatible with SCC2691
- Programmable operating speeds

The IM26C91 UART, a pin-for-pin replacement for the SCC2691, has 1.5- μ m CMOS fabrication that permits monolithic construction and 300-mil-wide packaging. A feature unique to the device is its ability to eliminate overrun errors, according to the vendor. A 4-level FIFO on the front end has a handshaking capability that disables a remote UART

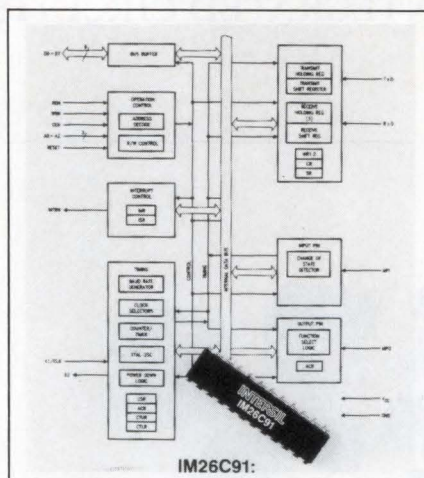

transmitter when the receiver buffer is full. Useful for dual-speed applications, the UART lets you program operating speeds—from an internal counter/timer or an external 1 \times or 16 \times clock—in 18 fixed baud rates ranging from 50k to 38.4k baud. The μ P- and TTL-compatible device is a registered UART that provides full-duplex operation and operates from a 5V supply. It

comes in a 24-pin plastic DIP or a 28-pin surface-mount PLCC. \$5.45 (100).

GE Solid State, 10600 Ridgeview Ct, Cupertino, CA 95014. Phone (408) 996-5703.

INQUIRE DIRECT

PROGRAMMABLE DTC

- Digital-to-time converter delays digital pulses
- 2.5-nsec to 100- μ sec delays are possible

Programmed with an 8-bit digital word, the AD9500 provides precise delay of digital signals. It receives, delays, and then retransmits a digital pulse. The delays range from 2.5 nsec to 100 μ sec with resolution to 10 psec. The device includes an 8-bit DAC, a differential analog-input stage, a timing control circuit, an output drive stage, and a voltage reference on a single monolithic

Color by

Sun Microsystems' Sun-4/260 workstation with the TAAC-1 Applications Accelerator lifts visualization capabilities to new heights. Brooktree provides the lift with four Bt458 RAMDACs small enough to fit on a single board. The result: Amazing detail in both pseudo and true color.

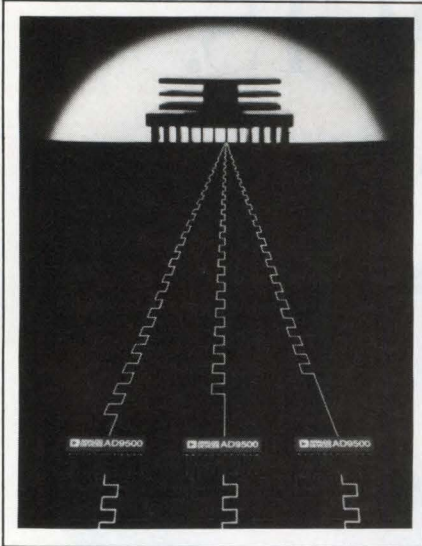

6-BIT ATTENUATOR

- Selectable attenuation range of 0 to 15.75 dB
- Useful to 40 MHz

The CDG4460J 6-bit, digitally controlled attenuator can operate at analog frequencies as high as 40 MHz. It's a hybrid circuit that contains three CMOS/DMOS ICs and 11 laser-trimmed resistors mounted on a thick-film ceramic substrate. The hybrid package can fit on 1 in² of a pc board. It has an attenuation range of 0 to 15.75 dB, selectable in increments of 0.25 dB. Designed for 75Ω systems, the device provides constant resistance for both the input and output regardless of the attenuator setting. An onboard data latch lets you set predetermined attenuation levels or to recall settings from memory. You can use the CDG4460J in in-circuit attenuators for equipment operating in the frequency range of 10.7 to 30 MHz. \$39.50.

chip. It operates from 5 and -5.2V supplies. Depending on package options and the temperature grade, \$16 to \$40 (100).

Analog Devices, Literature Center, 70 Shawmut Rd, Canton, MA 02021. Phone (919) 668-9511. TWX 710-394-6577.

Circle No 356

Topaz Semiconductor, 1971 N Capitol Ave, San Jose, CA 95132. Phone (408) 942-9100. TWX 910-338-0025.

Circle No 357

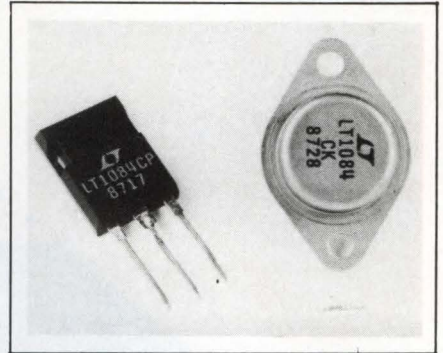

VOLTAGE REGULATOR

- 5A adjustable, 3-terminal type
- 1.5V max dropout

The LT1084 voltage regulator is pin compatible with existing 3-terminal regulators such as the LM138, but the LT1084's maximum dropout of

Brooktree®



Brooktree Bt458. Triple 8-bit color RAMDAC. Available in speeds from 80 MHz to 125 MHz.

Sun Microsystems' Sun-4/260 Workstation with TAAC-1. Provides pseudo color (8 bit) and true color (24 bit), with a choice of 256 colors or 16.8 million colors.



Brooktree Corporation,
9950 Barnes Canyon Road,
San Diego, California 92121
1-800-VIDEO IC.

© Copyright Brooktree Corporation 1988.

NOW YOU CAN DRIVE OUR SUBCOMPACTS.

Seagate's family of 3½" hard disc drives.



As computers grow smaller, the demand for high-quality drives grows larger. But if you're looking for 3½" drives for your small computer systems, you don't have a lot to choose from.

Except at Seagate.

We offer six 3½" drives with 21, 32 and 48 MB formatted capacities. You also have a choice of interfaces: SCSI or ST412 with RLL or MFM encoding. All with 28 msec access time.

Our 3½" drives use Seagate's field-proven, proprietary stepper motors to achieve fast access times normally found only with more expensive voice coil actuators.

Seagate's 3½" drives are not only fast — they're power savers, using as little as 8 watts.

And for added data integrity, the drives feature autopark with a balanced positioner.

All of Seagate's 3½" drives are built with the precision and quality that have made us the world's leading independent manufacturer of 5¼" full-height and half-height hard disc drives.

Only Seagate has the worldwide, high-volume manufacturing efficiency to meet the growing demand for 3½" drives.

When you're ready to go for a little drive, give us a call. 800-468-DISC.



 **Seagate**

The first name in disc drives.

INTEGRATED CIRCUITS

1.5V is approximately 50% lower. During manufacturing the device is trimmed to adjust the reference-voltage accuracy to 1%. It has on-chip protection against short circuits and shuts down if the temperature exceeds 165°C. The typical line regulation is 0.015% and the load regulation is 0.1%. The device is available in TO-3 metal cans and TO-247 plastic packages. TO-247, \$5 (100).

Linear Technology Corp, 1630 McCarthy Blvd, Milpitas, CA 95035. Phone (408) 432-1900.

Circle No 358

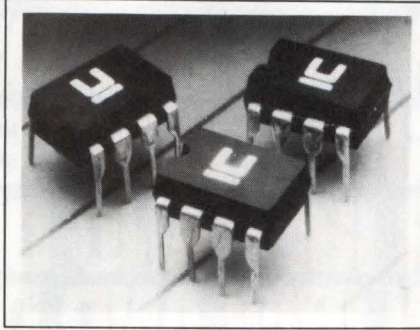

DUAL FET DRIVER

- Operates at high speed
- Features TTL compatibility

The UC3709 power driver provides fast turn-on and turn-off for the capacitive gates of power MOSFETs. Manufactured in a high-speed Schottky process, the device features totem-pole outputs that can source or sink drive currents to 1.5A with minimal cross-conduction current spikes. It is TTL compatible at the input and has an output stage that can swing over a 30V range. Additional features include thermal-shutdown protection and under-voltage lockout. The device comes in either an 8-pin ceramic DIP or an 8-pin plastic minidip. \$1.89 (100).

Unitrode Integrated Circuits, 7 Continental Blvd, Merrimack, NH 03054. Phone (603) 424-2410.

Circle No 360

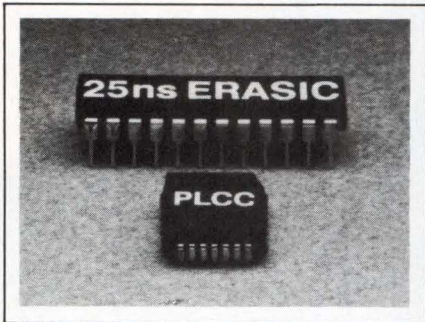

EEPLD

- High-density CMOS
- 25-nsec speed

The XL78C800-25 Erasic (electrically reprogrammable ASIC) has a 10-nsec I/O delay and a 15-nsec internal delay for signals routed through internal feedback levels. It is pin compatible with many PAL-type PLDs, but draws less current (45 mA max vs 180 mA for bipolar PLDs). The device is configured as an uncommitted plane of NOR gates with 10 user-configurable macro-cells, each with a JK flip-flop. You can configure 42 levels of internal logic without going off chip, thus allowing the integration of complete systems into a 24-pin package. The Erasic is available in three speed versions: XL78C800-25, \$17; XL78C800-35, \$12; XL78C800-45, \$9.25 (100).

Exel Microelectronics Inc, 2150 Commerce Dr, San Jose, CA 95131. Phone (408) 432-0500. TLX 171339.

Circle No 359

QUAD OP AMP

- 8V/μsec slew rate
- 6.5-MHz gain bandwidth

The OP-471GP quad op amp features a slew rate of 8V/μsec and a gain-bandwidth product of 6.5 MHz. It has a 1-mV typ input-offset voltage and 1.8 mV max. The open-loop gain exceeds 300,000, and the input bias current is 60 nA max, thus minimizing dc error caused by source resistance. The device's common-mode rejection is 95 dB, and its power-supply rejection ratio is 5.6 μV/V max. It conforms to the industry-standard quad pinout and is specified over the commercial temperature range. \$5.50 (100).

Precision Monolithics Inc, Box

Text continued on pg 252

VECTOR
ELECTRONIC COMPANY

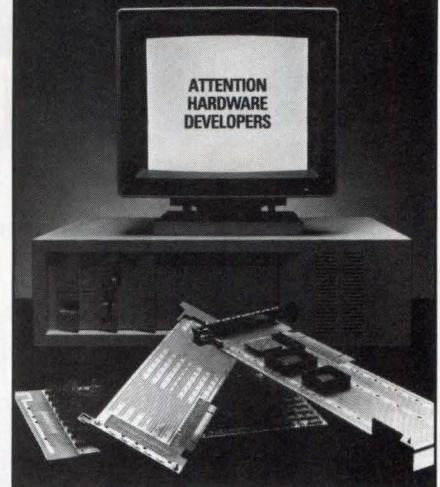

WHAT'S NEW FOR THE IBM PS/2

Wire wrap **VECTORBORD®**

High speed prototyping boards

for manual or semi-automatic

assembly. Solderable versions

also. Both with impedance

matched extenders.

See us at Electro, Booth No. 1409

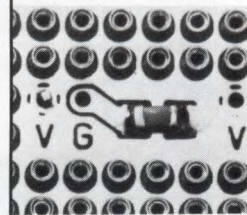

- USES SMD CAPS AND SOCKET PINS
- Opposing v/g planes reduce crosstalk.
- Connectors, brackets, and accessories.
- Available for all PS/2 Models and IBM-PC, XT, & AT.

Vectorbord plus™
For IBM PS/2

Call or send for brochure.

VECTOR ELECTRONIC COMPANY
12460 Gladstone Avenue
Sylmar, CA 91342
818/365-9661 FAX 818/365-5718

800/426-4652 in CA
800/423-5659 Outside CA

124

TEK 4200 SERIES TERMINALS

**WHY TEK BUILDS A
BETTER GRAPHICS TERMINAL
FOR IBM AND DEC
THAN IBM AND DEC.**

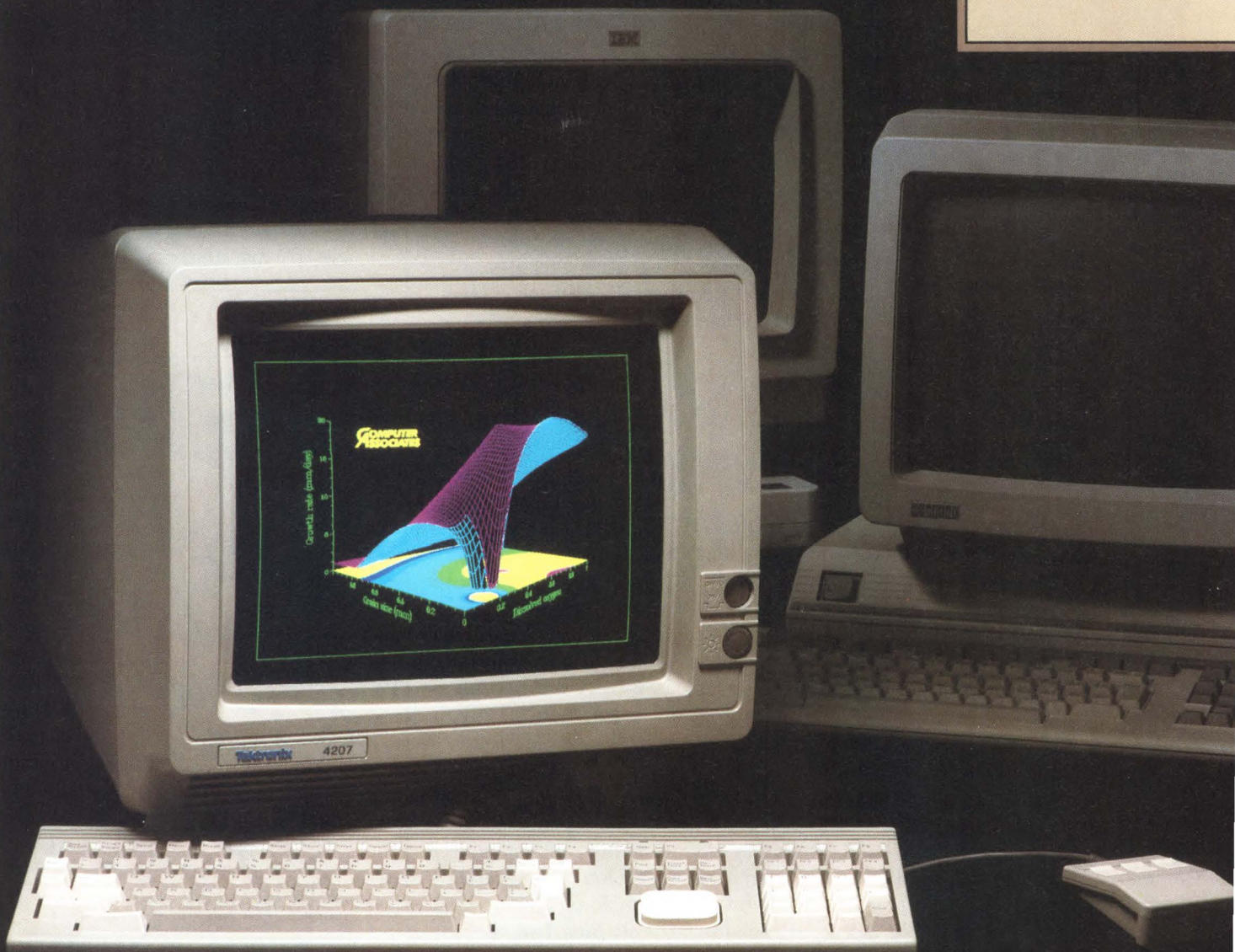

The terminals of most main-frame builders are little more than slaves to the host. But Tek's 4200 Series gives you local manipulation, powerful graphics, and the option to use any host you choose.

Only the 4200 Series offers up to 1.5 MB of memory, with the local capabilities that let you use your host most efficiently.

Only the 4200 Series offers dual connection to both IBM and DEC and other ASCII hosts. You can work with up to six databases concurrently.

Only the 4200 Series delivers

interactive true zoom and pan with the other superb graphic and alphanumeric features made famous by Tektronix.

Tek Software and peripheral compatibility is without equal in the graphics industry.

The 4200 Series is supported by more than 175 world-class software vendors offering a full range of solutions for MIS, manufacturing and engineering.

To bring your applications to life, you can use the 4200-compatible 4690 Family of color printers. Or other popular monochrome and color output

devices.

4200 Series are immediately available from authorized distributors or by contacting your local Tektronix representative.

For information:

call 1-800-225-5434.

In Oregon, 1-235-7202.

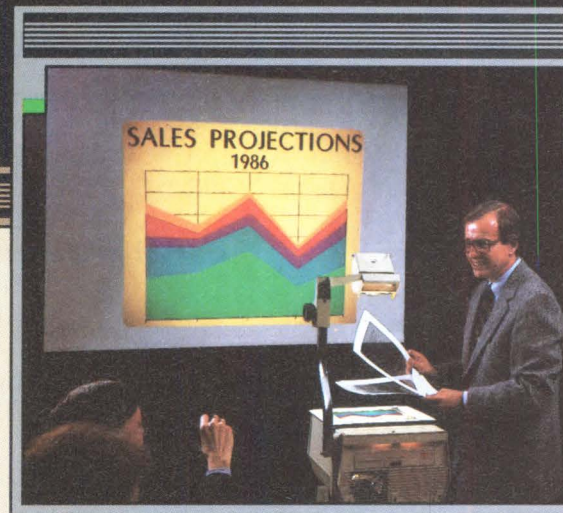

Comparison of Graphics Terminals

	TEK	DEC	IBM
DEC Host Compatible	Yes	Yes	No
IBM Host Compatible	Yes	No	Yes
Multiple Active Sessions	Yes	Yes	No
Tek 4010-4100 Command Set	Yes	No	No
Segments	Yes	No	No
True Zoom and Pan	Yes	No	No
IBM GDDM (Graphical Data Display Manager) Support	Yes	No	Yes
Graphics Addressability of 4096 x 4096	Yes	No	No
VT200 Alphanumerics	Yes	Yes	No
Background Hardcopy	Yes	No	No
Separate Graphics and Alphanumeric Regions	Yes	No	Yes

INTEGRATED CIRCUITS

58020, Santa Clara, CA 95052.
Phone (408) 727-9222. TLX
713719541.

Circle No 361

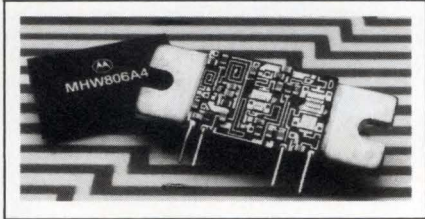

RF MODULE

- For cellular radios
- Minimum output power of 6W

The MHW806A comes in four versions that cover the cellular frequency spectrum from 806 to 950 MHz. All versions have a minimum output power of 6W and feature stable performance in output power over a 35-dB range. The module operates from a 12.5V supply and has input

and output impedances of 50Ω. The four versions are specified according to bandwidth and gain. MHW806A1, \$32; MHW806A2, \$36.50; MHW806A3, \$39; MHW806A4, \$43. (100).

Motorola Inc, Technical Information Center, Box 52073, Phoenix, AZ 85074. Phone (512) 928-6705.

Circle No 362

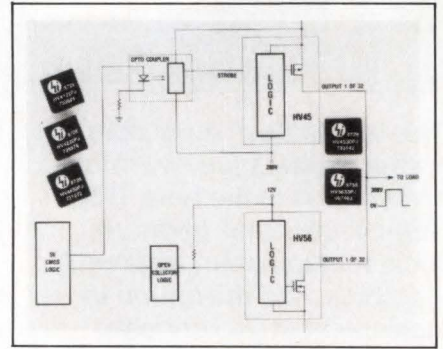

HV DRIVERS

- Provide 32 open-drain outputs
- Complement N-channel devices for symmetrical driving

You can use the HV41, 42, 45, and 46 P-channel drivers to complement the HV51, 52, 55, and 56 N-channel drivers in flat panel displays that require a symmetrical drive scheme. The devices are also suited for use in printers that require active pullup and pulldown functions to 300V. The HV41 and its reverse-

shift complement, the HV42, have 32 open-drain, 225V, P-channel outputs, each of which can source 80 mA. The outputs are controlled by a 4-MHz shift register that has output-enable and all-on functions. The HV45 and its reverse-shift complement, the HV46, have 32 open-drain, 300V, P-channel outputs, each of which can source 60 mA. The outputs are controlled by a 4-MHz shift register that possesses latches, polarity control, and blanking control. The blanking control creates an all-off condition without affecting

FUJI NOVEL

Your Best Choice with Worldwide Reputation.



PRODUCTS LIST

- Lithium batteries
- Silver oxide button cells
- Alkaline button cells
- Alkaline batteries
- Zinc chloride batteries
- Zinc carbon batteries
- NI-CD rechargeable batteries etc.

FDK
Fuji Electrochemical Co., Ltd.
Tokyo, Japan

FDK AMERICA, INC.
17326 Edwards Road, A-130, Cerritos, California
90701, U.S.A.
Phone 213-404-1770 Telex 18-1998 (FEC CALIF LA)
Fax. 213-404-2850

BREAK T H R O U G H

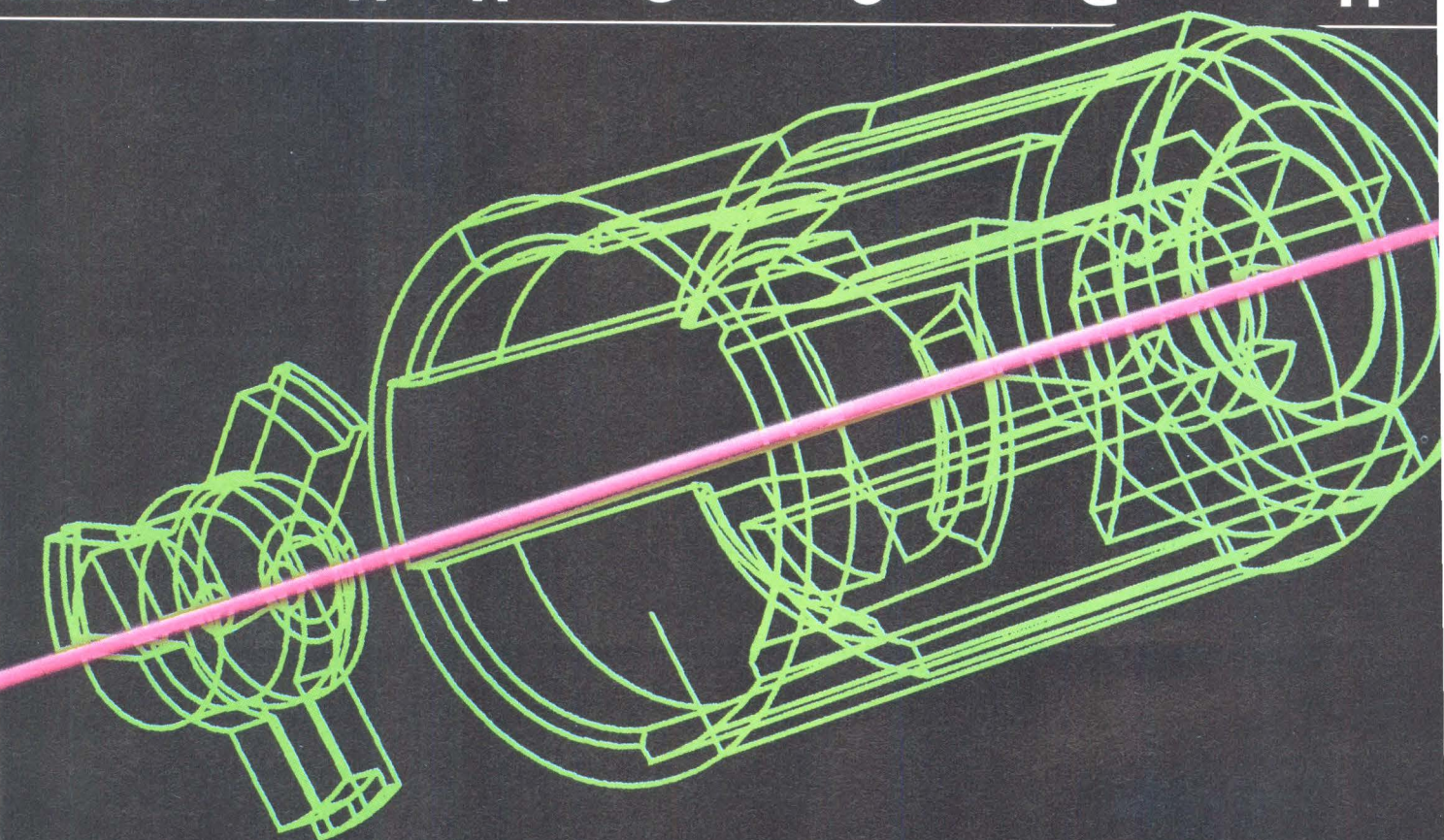

New microlasers are expanding and refining laser applications through advanced diode-pumped, solid-state technology.

Amoco Laser Company's microlaser technology represents a quantum leap forward for laser light sources. Finally, a low noise, highly efficient, compact laser is available with operating voltage and lifetime characteristics that make microlasers a practical solution for many applications.

Consider the following line of infrared microlasers. They are available for immediate shipment for a wide range of uses in testing and inspection, optical alignment, materials characterizations, metrology, process monitoring,

spectroscopy, micromachining, and microsurgery.

Product	Wavelength	Power
ALC1064-50	1064nm	50mw
ALC1064-150	1064nm	150mw
ALC1320-25	1320nm	25mw
ALC1320-75	1320nm	75mw

All of the above lasers have a diffraction limited, TEM₀₀ mode and are offered with linear or random polarization. A line of precision collimators is also available.

Want to learn more?

Write for our videotape which more thoroughly explains Amoco's microlaser and its uses.

Amoco Laser Company, 1809 Mill St., Naperville, IL 60540, or phone: 312-369-4190.

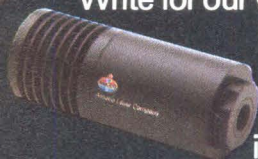

Amoco Laser Company
CIRCLE NO 118

CONFIGURE-YOUR-OWN
MIL SPEC • HIGH RELIABILITY
POWER SUPPLIES



A HIGHER LEVEL OF PERFORMANCE

INTRODUCING EL 2000 SERIES

Complete AC to DC and DC to DC multi output systems.

MORE BENEFITS

Save Space: Completely protected AC-DC systems with rugged high density packaging to 8 watts/in³.

Less Heat: Efficiencies to over 80% with next generation circuitry.

Higher Reliability: MTBF to 500,000 hours with conservative design criteria including NAVMAT guidelines.

MORE CHOICES

- Up to 8 DC outputs to 500 watts.
- 1 ϕ , 3 ϕ and DC inputs.
- -55°C to +85°C operation.
- Mil-Std-704A-D, 1399 and 1275 input surge and spike protection.
- Meets many provisions of Mil-Std-810D, Mil-E-5400 and Mil-E-16400.

Call or write for our new EL 2000 Catalog today!



ARNOLD MAGNETICS CORPORATION

4000 Via Pescador, Camarillo, California 93010-5049
Phone: (805) 484-4221 • TWX 910-343-6468 • FAX: (805) 484-4113

the shift-register or latch data. The polarity control inverts the data from the latch or the blanking control. You can order the devices in 44-pin PLCCs or in hermetic 44-pin ceramic packages. From \$6.34 (1000).

Supertex Inc, 1225 Bordeaux Dr, Sunnyvale, CA 94088. Phone (408) 744-0100. TWX 910-339-9388.

Circle No 363

PARITY ICs

- 16-bit parity at throughput rates to 30 MHz
- Cascadable for greater word lengths

The PC74HC7080 and PC74HCT7080 parity generator/checker ICs provide a single-chip solution to generating parity for 16-bit data words. The HC version has CMOS-compatible inputs and outputs and operates from a supply voltage of 2 to 6V; the HCT version has TTL-compatible inputs and outputs and operates from a supply voltage of 4.5 to 5.5V. Both devices have a typical propagation delay of 33 nsec, allowing you to use them in systems that operate at 30 MHz. For longer word lengths you can cascade the devices—two devices can generate 32-bit parity at 20 MHz. They provide an even or odd parity output that can be active high or active low. Operating from a 5V supply into a 50-pF load at 20 MHz, the devices consume an active power of approximately 17 mW. Their quiescent supply current is 8 μ A. Both ICs have an operating temperature range of -40 to +125°C and are available in 20-pin DIPs or small-outline packages. Approximately Gld 5.25 (100).

Philips, Components Div, Box 523, 5600 AM Eindhoven, Netherlands. Phone (040) 757189. TLX 51573.

Circle No 364

Signetics Corp, 811 E Arques Ave, Sunnyvale, CA 94088. Phone (408) 991-4571.

Circle No 365

VOLTAGE TRIPLER

- Lets you power CMOS logic from an alkaline-cell battery
- Has a fully regulated, programmable output voltage

By employing charge-pump techniques, the SL6670 provides voltage tripling without the use of external inductors or transformers. It fea-

tures a fully regulated output and is programmable via an external resistor, allowing it to maintain a constant output voltage over a variety of input and load conditions. The device runs off supply voltages as low as 0.95V. You can program the device's output voltage in the range of 0.9 to 8V; it can achieve voltage conversion efficiencies of 99%.



LLS electroluminescent (EL) lamps offer the designer a surface illumination alternative far superior to incandescent or other conventional light sources. And, whereas other makes of EL lamps may offer some of our product features, comparative tests prove that for long life, brightness, uniform light diffusion, color stability, resistance to moisture, heat, vibration and shock, no other EL lamps can match ours.

Thin, flexible and lightweight—Many shapes, sizes and colors

These rugged, solid-state EL lamps provide cool, uniform light across the entire lamp surface, eliminating the need for sockets, bulbs, diffusers and reflectors. Power consumption is small due to low current demand. A thin profile (.032") permits high density packaging; and with IC-style leads available, lamps are compatible with PCBs. Although stocked in rectangular shapes for immediate delivery, we can design EL lamps in a variety of custom shapes and sizes including complex forms with

multiple holes and cutouts. Available with pressure-sensitive adhesive on front or rear surfaces.

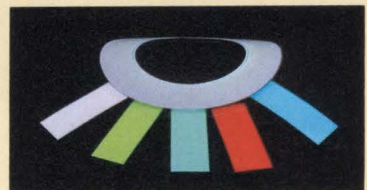

If you'd like a copy of our brochure, or have questions regarding EL applications, just call, write or TWX the LLS Marketing Department.



**LOCTITE
LUMINESCENT
SYSTEMS INC.**

SETTING THE STANDARD
A SUBSIDIARY OF LOCTITE CORP.

Tel. (603) 448-3444 TWX 710-366-0607
Etna Rd., Lebanon, NH 03766

IEEE-Z

IOtech has the widest selection of *easy-to-use* interfaces & software for IEEE 488 (GPIB/HPIB) systems.

- Instrument & plotter controllers (internal & external) for PCs, PS/2s, & Macintosh

- Converters from IEEE to RS-232/422, digital I/O, modem, real-time clock, SCSI, & analog I/O

- IEEE bus extenders via RS-422 or fiber-optics

- 512K IEEE data buffers & expanders

- Software for IEEE control from languages & Lotus 1-2-3®

- Menu-driven graphics & analysis software

- 30 day money-back guarantee

- 2 year warranty

- Call for your **FREE Technical Guide**



IOtech...the choice is easy

IOtech

(216) 439-4091 Telex 6502820864 Fax (216) 439-4093

25971 Cannon Road • Cleveland, Ohio 44146

London (0734) 86-12-87 • Paris (1) 34810178 • Zurich (01) 821 944
 Milan 02-4120360 • Linköping 013 11 01 40 • Amsterdam 01830-35333
 Sidney (2) 452 3831 • Munich, and other European, North African, and Middle East countries not listed (089) 710020.

Build Electronic Products That Don't Fail From Surge & ESD.



Can be configured to meet ANSI/IEEE, IEC, UL, CCITT and other standards.

Built-in SurgeSense™ permits voltage measurement at the EUT.

SAFE, reliable high voltage switching.

Test your product's vulnerability to surge with one of our Series 1000 surge generators.

0° to 360° phase control.

Remote controllable.

Innovative Bi-Wave™ pulses are real world and quantifiable.

Integral AC line coupler/back filter with Automatic Intensity Compensation, AIC™

Model 587-PLUS™ Surge Generator, \$25,010*

For product and applications literature on surge and ESD hardening, call (617) 658-0880.



KeyTek®

KeyTek Instrument Corporation, 260 Fordham Road
 Wilmington, MA 01887, Phone: (617) 658-0880
 TELEX: 951389 FAX: (617) 657-4803

*USA price list

CIRCLE NO 124

STANDARD AND CUSTOM OPTICAL SWITCHES

100 STANDARD VARIATIONS

- Direct Honeywell and TRW replacements.
- Analog, TTL, DTL, and CMOS interface
- Pin or Wire leads.
- Complete CUSTOM Capabilities.
- Dock-To-Stock certified.
- Statistical Process manufacturing Control.
- Prompt and Courteous customer service.

For over 20 years HEI has designed and built optical switches and assemblies to the strictest of specifications

CALL FOR OUR NEW CATALOG 612-443-2500

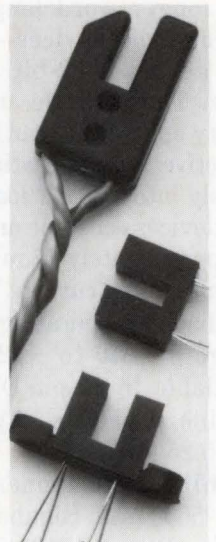

HEI inc.

Optoelectronics Division

P.O. Box 5000 1495 Steiger Lake Lane
 Victoria, MN 55386

CIRCLE NO 125

Other features of the device include a programmable oscillator to control the switching frequency, and a battery-low flag output. You can obtain samples enclosed in a 14-pin small-outline, surface-mount package for £2.02 (1000).

Plessey Semiconductors Ltd, Cheney Manor, Swindon, Wiltshire SN2 2QW, UK. Phone (0793) 36251. TLX 449637.

Circle No 366

Plessey Semiconductors, 9 Parker, Irvine, CA 92718. Phone (714) 472-0303.

Circle No 367

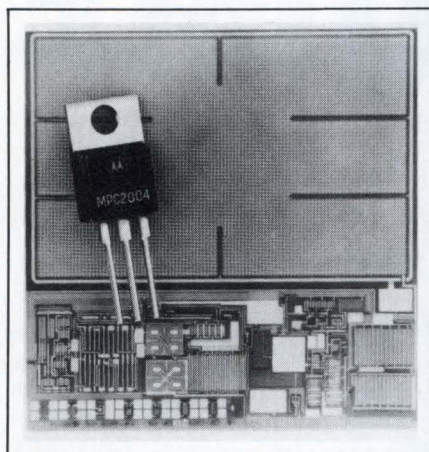

SMARTMOS CIRCUITS

- Provide overvoltage and over-temperature protection
- For 5, 12, and 15V power buses

The MPC2004, 2005, 2011, 2012, 2014, and 2015 comprise a family of six protection circuits rated at 7.5 and 15A and split into three voltage groups of 5, 12, and 15V. Combining CMOS logic with a silicon controlled rectifier (SCR), these SmartMOS devices provide overvoltage and overtemperature protection for sensitive systems by crowbarbing the power bus if voltage or temperature exceeds a preset level. The devices feature a pin that allows you to increase the trip voltage or vary the transient response. Because of low dissipation in the off state, the junction temperature of each device essentially equals the case temperature of the TO-220

package. The 7.5A MPC2004 (5V), 2011 (12V), and 2014 (15V) cost \$1.45; the 15A 2005 (5V), 2012 (12V), and 2015 (15V) cost \$1.75 (100).

Motorola Inc, Technical Info Ctr, Box 52073, Phoenix, AZ 85072. Phone (512) 928-6705. Delivery, stock to eight weeks ARO.

Circle No 368

REGULATING PWMs

- Low-drift 5V bandgap reference
- Double-pulse suppression logic

The SG1526B/2526B/3526B Series PWMs offer improved performance over the industry-standard SG1526 Series. Pin-compatible with the SG1526, the SG1526B provides a bandgap reference circuit for im-

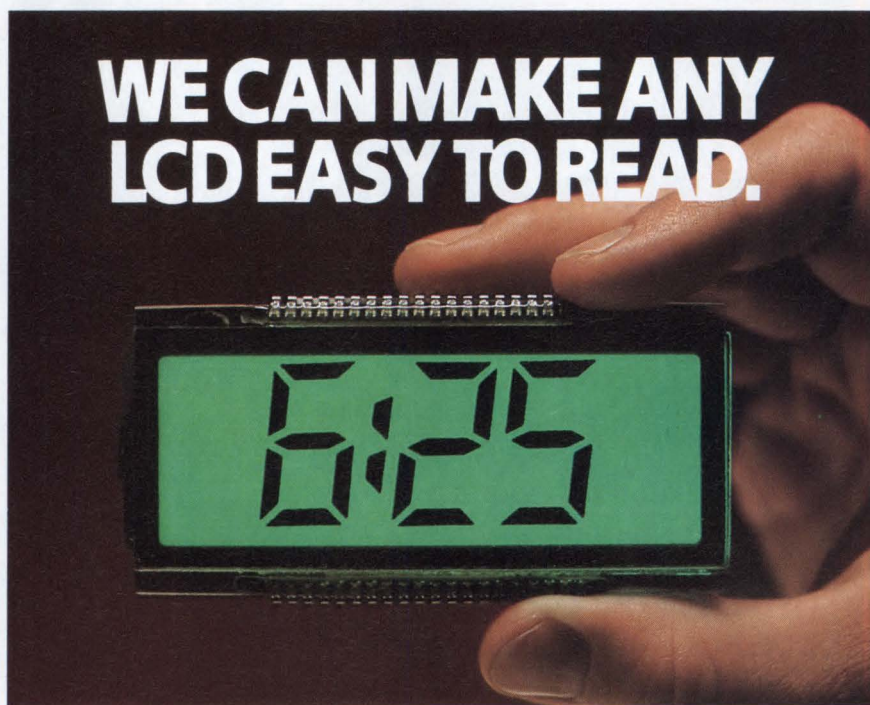

Our thin, flexible electroluminescent lamps dramatically improve LCD readout by providing higher contrast and better visibility. A thin profile (.032") allows high density packaging, and pressure-sensitive adhesive can be supplied on front or rear surfaces for rapid assembly.

Uniform, cool light source in many shapes, sizes and colors
Our backlighting ELs emit even illumination across the entire lamp surface. They also eliminate the need for sockets, bulbs, diffusers or reflectors. Lamps are usually supplied in rectangular shapes, but we can create many custom shapes and sizes including complex forms with multiple holes and cutouts. With IC-style leads, lamps are compatible with PCB assembly. Eight standard colors are available and custom colors can be created.

If you'd like more information relating to LCD applications, just call, write or TWX the LLS Marketing Department.

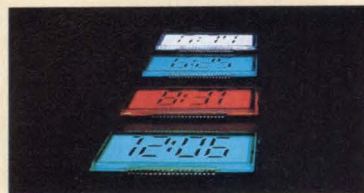

LOCTITE LUMINESCENT SYSTEMS INC.
SETTING THE STANDARD
A SUBSIDIARY OF LOCTITE CORP.

Tel. (603) 448-3444 TWX 710-366-0607
Etna Rd., Lebanon, NH 03766

Switching Times

 **TELEDYNE RELAYS**
Innovations In Switching Technology

© 1988 Teledyne Relays

MAGLATCH NOW CMOS COMPATIBLE

Maglatch Low Power and Indestructible Memory Ideal For Aircraft and Space

Teledyne Relays has introduced a new CMOS compatible Centigrad[®] version of its popular TO-5 Maglatch relay. This 122C relay is set with a short pulse of coil voltage and retains its state until it is reset, even if the system power fails or is shut off. Since no holding power is required, the 122C is also ideal where power is at a premium. A power FET driver in each input enables direct relay interfacing with CMOS and most other logic families. In addition, its small footprint is well-suited to the newest high-density printed circuit boards. For RF switching applications, the in-

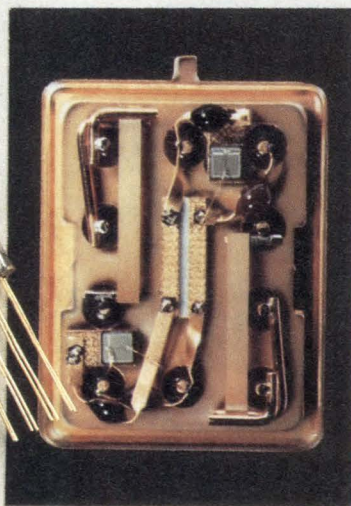

herently low intercontact capacitance of the 122C provides high isolation and low insertion loss up through 1GHz. The 122C is built to meet the requirements of established reliability mil specs MIL-R-28776 and can be screened to P level. Teledyne's non-latching CMOS compatible relays introduced earlier are already QPL approved to MIL-R-28776/7 and /8.

2 Amp TO-5 Relay In Squib Firing Application

The new 2 amp version of Teledyne's proven TO-5 relay is finding new uses, including squib firing applications. The 212 Series TO-5 relay combines the small package—only .390 inches high—and the time-tested Teledyne reliability which are required for squib firing and other military applications. The 212 Series TO-5 relay is also ideal for controlling small motor loads, lamp loads, and capacitive loads, where current surge at turn-on and turn-off run as high as 2 amps. An innovative proprietary contact system, called TELESIMUM[™] makes the higher power level possible and also gives the 212 Series a resistive load rating up to 2 amperes for 100,000 operations.

Teledyne Solid State Introduces New ATE Relay

New C66 Solid State Relay was developed for use in automotive diagnostic test equipment, but other applications are emerging. When this device is turned off it has an extraordinarily low leakage (50 nanoamps). The hermetically sealed units are only 0.458" square and 0.190" high and have current ratings of from ± 0.3 amp at ± 380 volts to ± 1 amp at ± 200 volts. They are available from Teledyne Solid State now.

For More Information

Teledyne Relays, 12525 Daphne Ave., Hawthorne, California 90250 • (213) 777-0077/**European Headquarters: W. Germany:** Abraham Lincoln Strasse 38-42, 6200 Wiesbaden/**Belgium:** 181 Chaussee de la Hulpe, 1170 Brussels/**U.K.:** The Harlequin Centre, Southall Lane, Southall, Middlesex, UB2 5NH/**Japan:** Taikoh No. 3 Building, 2-10-7 Shibuya, Shibuya-Ku, Tokyo 150/**France:** 85-87 Rue Anatole-France, 92300 Levallois-Perret.

Teledyne Supplies Hi-Rel Space Programs

Teledyne's dedication to reliability has made its TO-5 relay the choice of virtually every space program in the Free World. Expanded NASA and Military use of Teledyne's TO-5 for space applications

reliability is vertical integration. All piece parts are produced, and critical manufacturing processes are controlled in-house. Teledyne's dedicated "Blue Traveler" hi-rel production line provides

utilizing 2-micron small particle cleaning prior to hermetic sealing. All hi-rel TO-5s must pass rigorous functional and environmental screening tests to assure "spaceworthiness." An asynchronous miss test

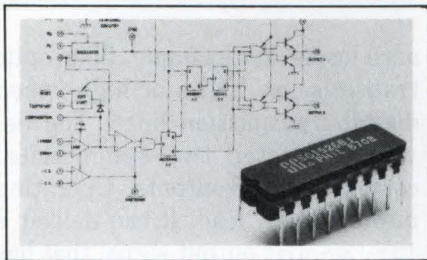

proved regulation and drift characteristics, and an improved double-pulse suppression logic for higher-speed operation. It also features an improved undervoltage lockout circuit and an output driver that features a shoot-through current of <math><100\text{ mA}</math>. A tighter tolerance on soft-start time, programmable deadtime, digital current limiting, and faster rise and fall times provide further enhancements. The series operates from a supply voltage of 8 to 35V and is designed for single-ended or push-pull switching regulators. It provides individual types specified for commercial, industrial, or military temperature ranges. The SG3526BN in a plastic package, \$2.80 (100).

Silicon General, 11861 Western Ave, Garden Grove, CA 92641. Phone (714) 898-8121. TWX 910-596-1804.

Circle No 369

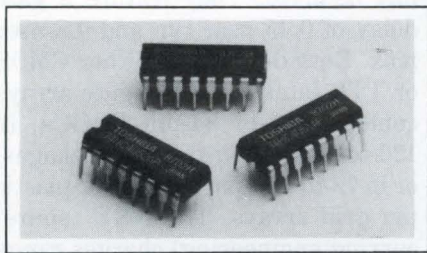

ANALOG MULTIPLEXERS

- Have 4-nsec propagation delay
- Feature 4- μA current drain

Members of the TC74HC4051AP line of analog multiplexers, which draw 4 μA of current and feature a 4-nsec typ propagation delay, operate at higher speeds than do members of the original 74HC logic family. The devices meet or exceed JEDEC Standard 7A requirements.

The 8-channel 4051, the dual 4-channel 4052, and the triple 2-channel 4053 versions are pin- and function-compatible with 4051, 4052, and 4053B parts. Housed in 16-pin DIPs, the devices cost \$0.96 (100).

Toshiba America, 2692 Dow Ave, Tustin, CA 92680. Phone (714) 832-6300.

Circle No 370

CLOCK DRIVER

- Drives capacitive loads
- Slew rate of 2V/nsec into a 100-pF load

Capable of high-speed switching into capacitive loads, the SP9010 CCD clock driver can drive the clock inputs of CCD delay lines. You can also use it to drive other low-imped-

GIVE US .085" FOR AN ILLUMINATED PANEL NO ONE CAN MATCH.

At only .085" thick, our new fiber-glass electroluminescent panels are designed to replace lightplates and traditional metal plates that may not presently be illuminated. Our thin .085" panels weigh 40% less than a typical .220" plexiglass panel, and with an expansion coefficient equal to aluminum, the lamps are ideal for surface-mount applications.

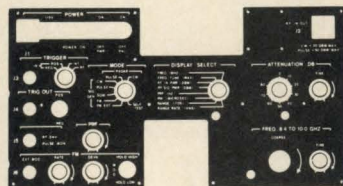

LLS electroluminescent panel

As the pioneer developers of EL lamps, as well as the process of encapsulation, we have combined the uniform, cool surface illumination of EL with the strength of fiberglass to create a new standard for panels.

Durability and long life luminescence

LLS EL lamps eliminate the need for sockets, bulbs, diffusers or reflectors, and add no heat to the assembly. This, together with their long life and availability in many colors, make them the intelligent choice for panel illumination – far superior to LEDs or incandescent bulbs. We create panels (including standard .220" plexiglass) in almost any shape and size, as well as complex designs with multiple holes and cutouts. Lamps can be filtered to comply to ANVIS or other military specifications, or to your design requirements.

If you'd like a copy of our brochure, or have questions regarding panel applications, just call, write or TWX the LLS Marketing Department.



LOCTITE LUMINESCENT SYSTEMS INC.

SETTING THE STANDARD
A SUBSIDIARY OF LOCTITE CORP.

Tel. (603) 448-3444 TWX 710-366-0607
Etna Rd., Lebanon, NH 03766

CIRCLE NO 122

NEW SONY/TEK
CURVE TRACERS

SINGLE SETUP. MULTIPLE MEASUREMENTS.

Test sequencing at your fingertip. Push one button to choose among sixteen measurement setups and sixteen curve comparisons you store onboard in the new 370 and 371 curve tracers. Build those setups with the easy-to-use, 576-like front panel, or program them over the GPIB.

RANGE	370	371
Max Peak Voltage	2000V	3000V
Peak Current Pulsed	20A	>400A
Max Peak Power	220W	3000W
Price	\$17325	\$19950

Push-button hardcopy too. Get X-Y plotter hardcopy without tying up your system, and without using a controller or camera. For example, you can use the Tek HC-100

plain paper plotter, priced at only \$775.

All from Tektronix. With either the 370 or 371, you get the durability and dependability of the Tek 576. You also get the Tektronix commitment to quality, service, and support. To learn more, contact your local Tek representative, or call 1-800-835-9433, ext. 170.

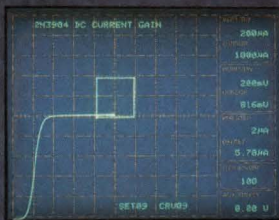
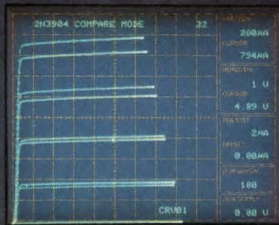
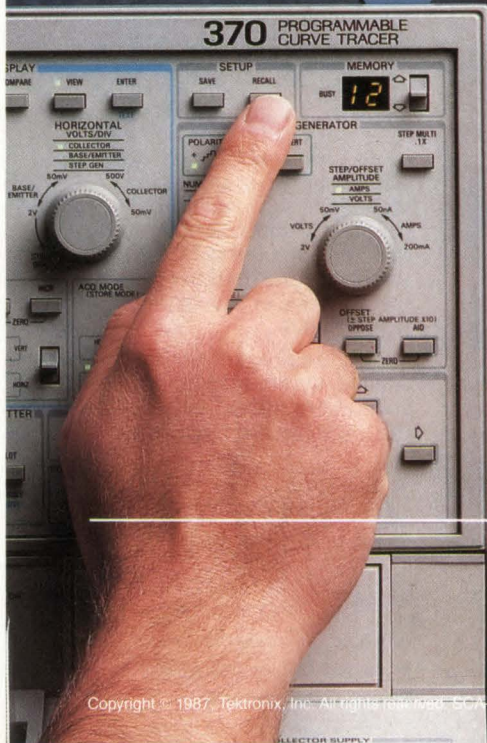

Tektronix
COMMITTED TO EXCELLENCE

Copyright © 1987, Tektronix, Inc. All rights reserved. 501-833

INTEGRATED CIRCUITS

ance loads—for example, fiber-optic transmission LEDs or high-speed digital transmission lines. The device generates two symmetrical complementary outputs. Operating into a 100-pF load, it can deliver a 12V, 25-MHz output signal that has a slew rate of 2V/nsec. The device's inputs are CMOS and TTL compatible and incorporate OR gates that allow you to generate continuous or burst-mode clocks. £2.99 (1000).

Plessey Semiconductors Ltd., Cheney Manor, Swindon, Wiltshire SN2 2QW, UK. Phone (0793) 36251. TLX 449637.

Circle No 371

Plessey Semiconductors, 9 Parker, Irvine, CA 92718. Phone (714) 472-0303. TLX 701464.

Circle No 372

GATE ARRAYS

- 6000- and 10,000-gate devices
- Provide 0.8-nsec max gate delay

The 6000-gate μ PD67060 and the 10,000-gate μ PD67101 feature the same internal cell structure and block library as the vendor's first-generation, 600-to-3000-gate BiCMOS devices, but use only a single output buffer to provide 24 mA of drive. They feature a gate delay of 0.45 nsec typ and 0.8 nsec max. Both devices use either CMOS or TTL interfaces. The gate arrays come in 68- or 84-pin PLCCs, in 120-to-160-pin plastic flat packages, or in 72-to-280-pin ceramic or plastic pin grid arrays. The NRE (nonrecurring engineering) charges range from \$45,000 to \$65,000 and cover costs through the prototype stage. The unit prices for the devices equal roughly \$0.002 per gate.

NEC Electronics Inc., Box 7241, Mountain View, CA 94039. Phone (415) 960-6000. TWX 910-379-6985.

Circle No 373

TANTALUM CHIPS: KEMET® Is The Source.

105
35K

105
35K

105
35K

105
35K

105
35K

105
35K

105
35K

105
35K

• **Convenient packaging** — 7-inch and 13-inch reels (per EIA RS-481A) deliver up to 9,000 pieces each.

• **Easy identification** — Permanently laser-marked with capacitance, voltage and vendor logo.

• **Orientation guides** — Beveled edge and polarity stripe on anode end.

• **Precision molded** — Smooth surface for vacuum pick-up, part after part.

• **Symmetrical terminals** — Rectangular terminals for superior soldering; no "wheelies" or "tombstones."

• **Compliant terminations** — Terminals flex to relieve stress during thermal cycling.

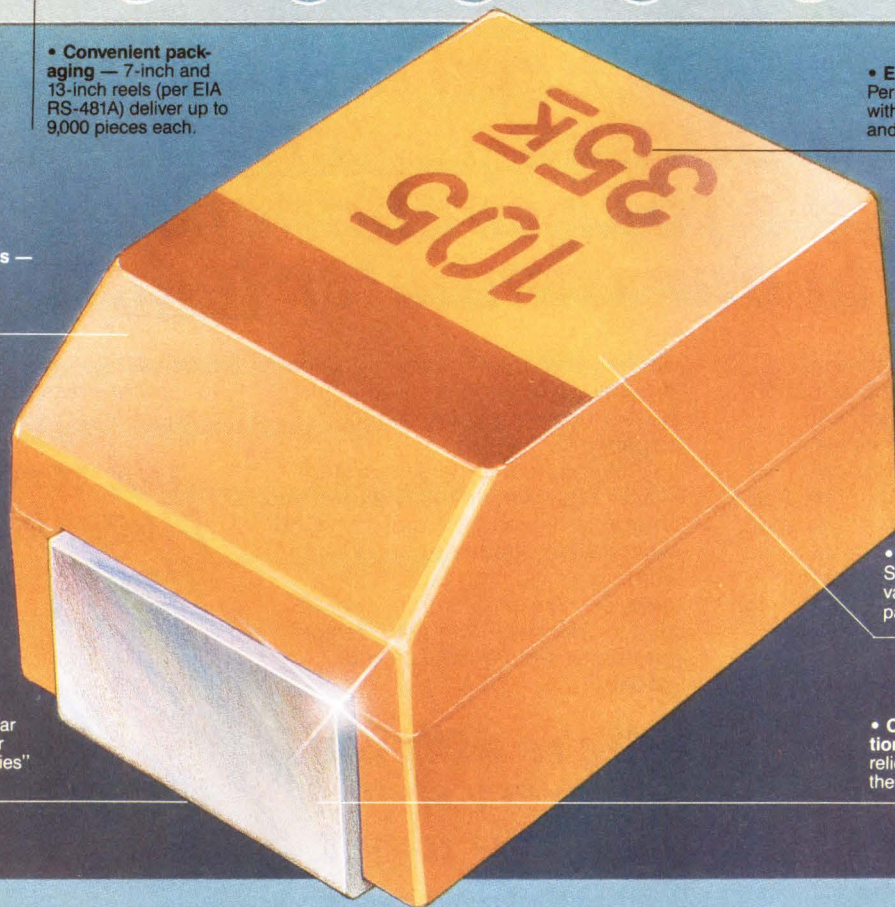

High-Production T491 Molded Chip Design: Positive Placement. Simpler Soldering.

Take a close look at the unique, production-boosting features of the T491 Series surface mount capacitor from KEMET. It's an excitingly different molded tantalum chip design that can increase your production efficiency as it boosts your product reliability:

- **Greater yield** — Designed for high-speed, automatic placement and high-integrity connections.
- **Compatible with all solder reflow methods** — Withstands 260°C for 10 seconds.
- **Meets EIA standards** — Meets or exceeds all IECQ specifications, including QC 300801/US0001.
- **Wide selection** — Capacitances from 0.10 μF to 68.0 μF , and working voltages from 6 to 50 VDC; in case sizes A through D.

They're built to KEMET's unexcelled quality standards with delivery to meet your needs.

For ordering assistance, ask your local KEMET sales office for a T491 Molded Tantalum Chip specification sheet. You'll find it's easy to do business with KEMET!

Sales Offices and Distributors Worldwide
In U.S.A.: (803) 963-6348; Telex 57-0496.
In Europe: 41-22-396512; Telex 845-911302.
In Asia: 852-372-31211; Telex 780-45162.

CIRCLE NO 131



KEMET® *Electronics Corporation*

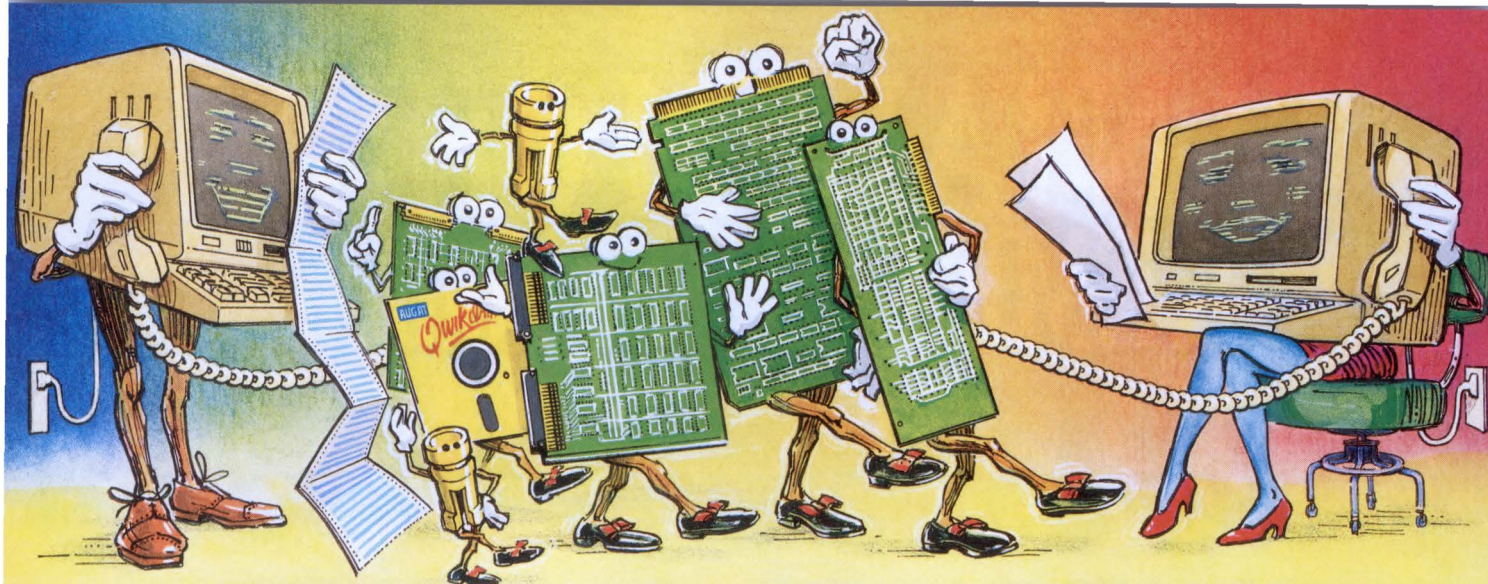

When you need a multilayer solution yesterday, have your computer talk to our computer today.

From design concept through prototype to full-scale production, our highly skilled design and fabrication professionals are committed to your program. Because of this commitment, Augat has continually met and exceeded the ever increasing needs of servicing the military, computer, telecommunications and other high technology market segments.

Design concept to fabrication

When "time to market" pressures become critical, our computerized data transfer capabilities and one-on-one engineering support make it easy to translate design concepts into finished board products quickly. Our design facilities include Scicards® system software for PWB layout,

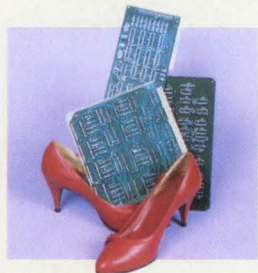

Gerber photoplotters for precision artwork generation, and other vital post-processing and interface capabilities.

This total computer-integrated manufacturing capability allows you to input schematics from your CAE workstation directly to our VAX® computers via mag tape, floppy disc, or modem. *Just think about that — implementing your design can be as simple as dialing a phone!*

We're with you every step of the way

A major part of Augat's total vertical integration is our board fabrication capability. With precision artwork generated by our experienced staff of PC design engineers, coupled with our 30 years of board-level interconnection experience, top quality multilayer boards are guaranteed. The complete process, from imaging to testing, is achieved by our UL and MIL-P-55110D approved fabrication

facilities. For even greater "product to market pressures", a quickturn fabrication service is available.

Add zero-profile pluggability with Holtite® Contacts



By investing just pennies per plated-thru hole, spec in Holtite® contacts and increase your assembly throughput and yields. Augat's patented and proven Holtite® contacts are solderless, zero-profile, automatically insertable and available in a wide choice of options. Ask for the complete Holtite® story and specs.

New!
Multilayer & Holtite
Literature
Available



AUGAT® INTERCONNECTION SYSTEMS

40 Perry Avenue, P.O. Box 1037, Attleboro, MA 02703
(617)222-2202 FAX (617)226-5257 TWX 710-391-0644

VAX is a registered trademark of Digital Equipment Corporation
SCICARDS is a registered trademark of Scientific Calculations, Inc.

NEW PRODUCTS

COMPONENTS & POWER SUPPLIES

CONNECTORS

- *Minimize pc-board real-estate requirements*
- *Feature 94V-0 flammability rating*

Mini-Edge pc-board connectors have 0.35-in. profiles and 0.050-in. center-to-center pin spacings. Each of the connectors features 26 contacts arranged in two 13-position rows and gold-over-nickel plating on

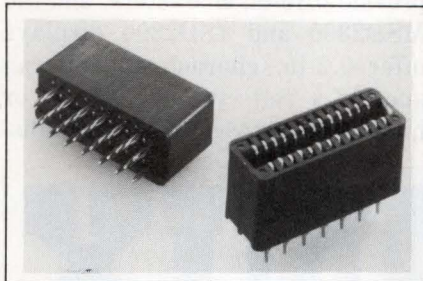

the card-edge contact areas; the individually replaceable beryllium-copper contacts apply continuous

normal force to 0.022-in. plated-through holes and are arranged in pairs to accommodate double-sided pc boards. The connectors' 94V-0-rated polyester housings resist the high temperatures of flow soldering. Their molded-in standoffs facilitate cleaning processes. \$5.83 (1000). Delivery, four to six weeks ARO.

Amp Inc, Box 3608, Harrisburg, PA 17105. Phone (717) 564-0100.

Circle No 376



KEYPAD

- *Compatible with all PC- and MS-DOS machines*
- *Interfaces with an RS-232C port*

Although the 22-position Touchstone 3 numeric keypad was designed especially for laptop computers, it will work with larger portables and desktop PCs as well. In fact, you can read its standard ASCII character codes into any RS-232C port. The unit comes with RAM-resident software that lets you use the keypad and main key-

board simultaneously. The keypad layout conforms to standard calculator arrangements and includes math keys, cursors, page controls, backspace, enter, escape, and function keys as well as the 10 numeric keys. The CMOS circuitry runs on power from the serial port. The low-profile keypad features full-travel keyswitches that have tactile feedback. \$129.95.

Touchstone Technology Inc, Box 24954, Rochester, NY 14624. Phone (716) 235-8358.

Circle No 375

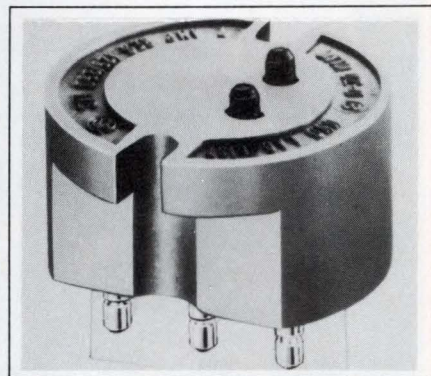

ROTARY SWITCHES

- *Handle 7A loads*
- *Come with silver, gold-flashed silver, or gold contacts*

U3-018 subminiature rotary switches feature dual snap-action contact configurations. The contacts have a 25-m Ω max contact resistance and handle dry circuit to 7A loads. The switches come with silver, gold-flashed silver, or gold contacts. The termination options include 0.58-in. quick-connect, single- and double-turret, wire-wrap, and pc-board type terminals. The switches measure 0.562 \times 0.365 in. and are UL listed and CSA certified. \$5.40 (1000). Delivery, four to six weeks ARO.

Otto Controls, 2 E Main St, Carpentersville, IL 60110. Phone (312) 428-7171.

Circle No 377

DISPLAYS

- Feature a -55 to $+100^{\circ}\text{C}$ operating range
- Provide 0.15- or 0.2-in. character heights

MSD2000/2300 and ISD2000/2300 4-character, 5×7 dot-matrix displays feature CMOS circuitry for low power consumption. Suited to mili-

tary and industrial environments, they are housed in hermetically sealed 12-pin DIPs and operate over a -55 to $+100^{\circ}\text{C}$ range. The MSD2000 and ISD2000 displays provide 0.15-in. characters, and the MSD2300 and ISD2300 displays offer 0.2-in. characters. You can specify a red, yellow, green, or high-efficiency red LED. Each dis-

play package includes two CMOS shift registers (7 bits per character) with built-in row drivers. The registers drive 28 rows, letting users define customized fonts. You can easily cascade the packages in either the X or Y direction to develop multiple character displays. You can also obtain yellow, green, or high-efficiency red, 0.2-in.-character displays that are viewable in direct sunlight. \$58 to \$196 (100).

Siemens Components Inc, Optoelectronics Div, 19000 Homestead Rd, Cupertino, CA 95014. Phone (408) 257-7910.

Circle No 378

TUSONIX

If you're looking for a reliable source for EMI Filters and Custom Filter Assemblies . . .



**Tusonix, as a QPL source,
is proud of its JIT performance**

Miniature EMI/RFI ceramic filters and filter capacitors attenuate most frequency ranges in a wide variety of QPL approved styles. Most are available from stock in production quantities, ready for immediate shipment.

When it comes to custom packaging EMI/RFI feed-thru filters and/or filter capacitors, Tusonix offers a complete in-house custom assembly capability. Every assembly is 100% tested in Tusonix' quality assurance laboratories. The result is a reliable, economic assembly that satisfies your unique needs.

So let Tusonix supply your filter requirements in discrete filters and assemblies. Write for literature TODAY . . . or please call us at:
Phone: 602-744-0400

TUSONIX

P.O. Box 37144, Tucson, AZ 85740-7144
Phone: 602-744-0400 Telex: (RCA) 299-640
FAX: 602-744-6155

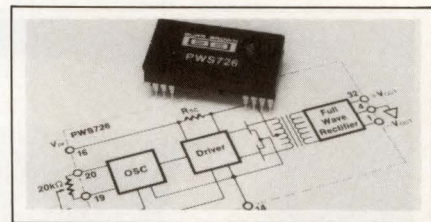

DC/DC CONVERTER

- Has current-sensing protection against thermal damage
- Lets you synchronize as many as eight converters

The PWS726 dc/dc converter features an oscillator, a driver circuit, dc switches, a transformer, internal filter capacitors, and a rectifier housed in a 32-pin DIP. It supplies ± 7 to $\pm 18\text{V}$ dc outputs at ± 40 mA. Galvanic input/output isolation is 100% tested at 800V dc and guaranteed to 2500V rms continuous, 3500V rms momentary. Other features include a $1.2 \mu\text{A}$ leakage current and a 9-pF leakage capacitance. A separate synchronous connection lets you frequency-synchronize as many as eight converters, while an Enable input provides flexible control over outputs for power conversion and sequencing. To protect the switches and prevent high inrush currents during the turn on, a soft-start/driver design ensures that the oscillator is fully operational before either MOSFET driver turns on. Input current sens-

IGBTs. The ^{latest} comparisons.

Compare Power

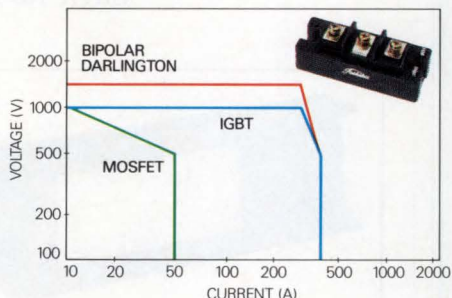

Compare Speed

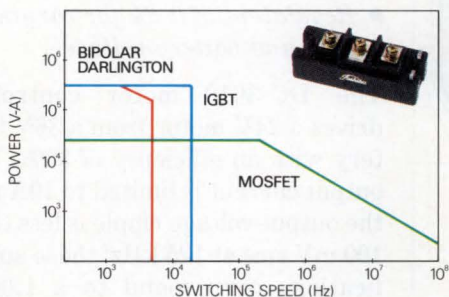

The choice is now obvious when you require both power and switching speed in your power systems. Insulated Gate Bipolar Transistors (IGBTs) offer both.

Similar to Bipolar, IGBTs have high conductivity with faster switching speeds ($t_f = 0.5\mu S$ typ). And like MOSFETS, IGBTs have high input impedance/high speed with lower on-resistance (as low as $8m\Omega$).

So now, for applications like low-noise inverters and servo-motor drives, there really isn't any reason to compromise. The solution you've been looking for is available: IGBT. The performance combination that doesn't make you give up one thing to get another.

Leading the way, again, this time with the broadest line of IGBTs anywhere in the world. Toshiba.

POWER AND SPEED. Send me more information on Toshiba IGBT Modules, including comparison data and product catalog.

Name/Title _____ EDN041488
 Company _____
 Address _____
 Telephone _____

Compare Selection

TOSHIBA AMERICA, INC.

Semiconductor Products Division

2692 Dow Avenue, Tustin, CA 92680

REGIONAL OFFICES: Western 714-832-6300;

Central 312-945-1500; Northeast 617-272-4352;

Southeast 404-368-0203



IGBT (Insulated Gate Bipolar Transistor) Selection Guide												
CONNECTION		MAXIMUM RATINGS										
CIRCUIT	SYMBOL	V_{CES} (V)	COLLECTOR CURRENT I_c (A)									
			8	15	25	50	75	100	150	200	300	400
1 IN 1	GT*	500		GT15H101*	GT25H101*							
		1000	GT8N101*	GT15N101*								
	BS	500		MG15H1BS1	MG25H1BS1	MG50H1BS1	MG75H1BS1	MG100H1BS1				
		1000		MG15N1BS1	MG25N1BS1	MG50N1BS1	MG75N1BS1					
	1200 UNDER DEVELOPMENT											
	US	US	500									MG300H1US1
1000										MG200N1US1	MG300N1US1	
1200			UNDER DEVELOPMENT									
2 IN 1	YS (CS)	500			MG25H2YS1	MG50H2YS1	MG75H2YS1	MG100H2YS1	MG150H2YS1	MG200H2YS1		
		1000		MG15N2YS1	MG25N2YS1	MG50N2YS1	MG75N2YS1	MG100N2YS1	MG150N2YS1			
		1200	UNDER DEVELOPMENT									
6 IN 1	ES	500		MG15H6ES1								
		1000		MG15N6ES1								
		1200	UNDER DEVELOPMENT									

* TO-3P PACKAGE ■ = UNDER DEVELOPMENT

Custom quick rotaries.

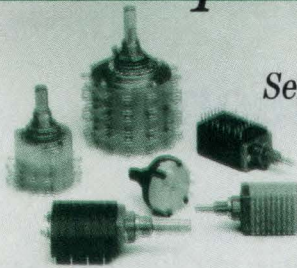

Send us your specs and we'll prove it — *free.*

Our rotary switches' unique modular design means we can respond fast to your needs at a price you'll like...while giving you a circuit configuration that really works in your design.

Because our switches are enclosed, you don't have to worry about dust, dirt or moisture. Damaging solder flow or wicking is locked out, and lifetime lubrication is sealed in.

And because our manufacturing facility is vertically integrated, we

carefully control quality as well as response time during every step of our production process.

If you need rotary switches that are custom quick at a reasonable cost, let us supply you a FREE sample and quotation for your specific application.

Just contact your local Electro-switch representative, authorized distributor or the factory direct at P.O. Box 41129, 2510 North Blvd., Raleigh, NC 27604. Phone: (919) 833-0707. Fax: (919) 833-8016.

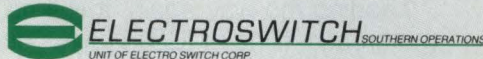

CIRCLE NO 132

INDUSTRIAL-GRADE DATA COMMUNICATIONS MODEMS

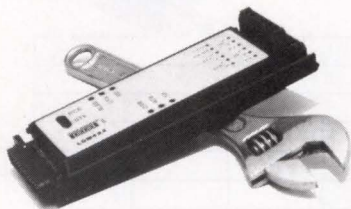

When you need Ruggedness,
Higher Performance, and
Lower Costs!

Unit quantity prices
from \$73.00. Quantity
discounts available.

Now you can have high-quality, high-performance industrial-grade communications modems at some of the lowest prices in the industry.

These rugged devices greatly extend communications distances, eliminate electrical noise and ground loops, and protect the host equipment from transient voltages.

Various models feature:

- Data rates to 5MBaud
- Distances to 3.5km at 19.2kBaud; 12 miles at 1.2kBaud
- Signal or system power source
- Dual or multipoint capabilities
- High isolation and surge protection
- RS-232/422 conversion
- Compact industrial package
- Fiber-optic models available.

For complete details, and a copy of our new 12-page Industrial Modem Brochure, contact your Burr-Brown sales representative or call 602/746-1111, Burr-Brown Corp., P.O. Box 11400, Tucson, AZ 85734.



Improving Data
Communications Productivity

CIRCLE NO 133

COMPONENTS & POWER SUPPLIES

ing protects both the converter and the load from possible thermal damage by limiting the output fault currents. \$27.70 (100).

Burr-Brown Corp., Box 11400, Tucson, AZ 85734. Phone (602) 746-1111. TWX 910-952-1111.

Circle No 379

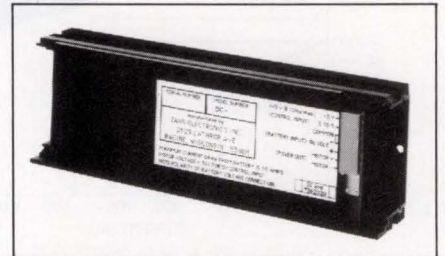

MOTOR CONTROLLER

- Features 93% efficiency
- Regulation of 0.2% for varying load and battery voltage

The DC-3610 motor controller drives a 24V motor from a 36V battery with an efficiency of 93%. The output current is limited to 10A and the output voltage ripple is less than 100 mV rms at 125 kHz; these specifications correspond to a 1.0001 form factor. A 0 to 5V input controls the voltage to the motor. A 5V regulated supply is available for use with potentiometer or op-amp control applications. The regulation specs at 0.2% max for varying load and battery voltage. \$195.

Zahn Electronics Inc., 2629 Lathrop Ave, Racine, WI 53405. Phone (414) 634-4300.

Circle No 380

POWER MOSFETS

- Handle 11A currents
- Feature 170W max power dissipation

The 500V IRFP448 and IRF448 power MOSFETs come in plastic and hermetic TO-3 packages, respectively. The IRFP448 has a 0.6Ω on-resistance, an 11A continuous current rating, a 44A pulsed drain current, a 170W max power dissipation, a ±20V gate-to-source voltage,



WE'RE FIRST...

IN COMPONENTS FOR COMMUNICATIONS

Innovation in electronic components is the first step to innovation in communications systems. And, Murata Erie leads the way with extensive research and development programs that are producing spectacular breakthroughs in new components for communications. The result!...vastly smaller systems size, better performance and superior reliability.

Many of these innovative components for communications are the result of Murata Erie's renowned reputation and experience in the application of ceramic technology to electronics. This expertise in ceramics dominates the continual

evolution of new and more dependable components, such as ceramic capacitors, resistor networks, potentiometers, inductors,

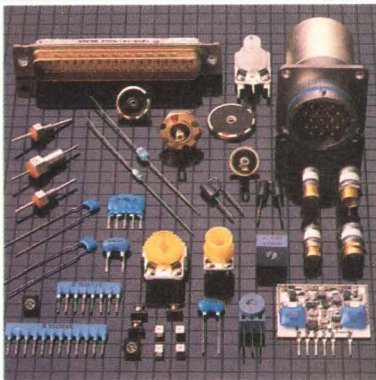

trimming capacitors, ceramic resonators, dielectric resonators, crystals, EMI/RFI filters, filter connectors, hybrid integrated circuits... with more being added every day.

We can put these resources to work today in your applications for audio systems + data transmission + telecommunications + microwaves + networking, to name a few.

Find out more about Murata Erie's components for communications. Write to Murata Erie North America, Inc., 2200 Lake Park Drive, Smyrna, Georgia 30080 or call 404-436-1300.

muRata **ERIE**

MURATA ERIE NORTH AMERICA, INC.

COMPONENTS & POWER SUPPLIES

a 3.5 V/nsec dv/dt, and a 0.73°C/W thermal resistance. Respective figures for the IRF448 are 0.6Ω, 9.6A, 38A, 130W, 3.5V/nsec, and 0.94°C/W. IRFP448, \$6.69 (1000); IRF-448, \$8.38. Delivery, nine weeks ARO.

International Rectifier, 233 Kansas St, El Segundo, CA 90245. Phone (213) 607-8899.

Circle No 381

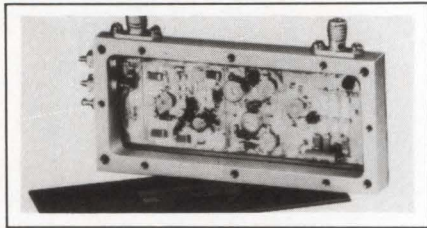

IF LIMITER

- Operates at 450 MHz with a 100-MHz p-p bandwidth
- Exhibits rapid limiting action at -15-dBm input levels

The Model ICDT450 hybrid limiter/discriminator operates at 450 MHz with a p-p bandwidth of 100 MHz. It features a linearity of more than 6% over a linear bandwidth of 70 MHz. The unit is designed for 0-dBm inputs, but exhibits rapid limiting action at -15-dBm input levels. It provides at least 0.02V/MHz video output into a 93Ω load. Its input

impedance specs at 50Ω, and the video baseband equals 25 MHz. With a rise time of 20 nsec, the unit is suitable for both CW and high-speed pulsed inputs. The unit draws 100 mA max from ±12V dc supplies. It is also available for operation at ±15V dc. \$1350. Delivery, 90 days ARO.

RHG Electronics Laboratory Inc, 161 E Industry Ct, Deer Park, NY 11729. Phone (516) 242-1100. TWX 510-242-1222.

Circle No 382

LED INDICATOR

- Available in red, green, amber, and yellow
- Specs 400-mcd luminous intensity

The Series 70 LED panel indicator features a mesh screen that suppresses RFI at frequencies ranging as high as 2 GHz. It's available in red, green, amber, and yellow. The indicator also has an anodized aluminum sleeve with a mounting surface that's designed for sure grounding contact. Fresnel lenses are available in flat or domed shapes in colors including tinted, smoked, or white for maximum on/off contrast. Additional specifications include a 400-mcd luminous intensity and an oper-

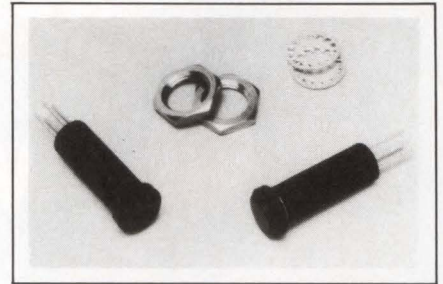

ating voltage in the 5V dc to 120V ac range. \$18 (1000). Delivery, stock to five weeks.

Data Display Products, Box 91072, Los Angeles, CA 90009. Phone (800) 421-6815; in CA, (213) 640-0442. TLX 664690.

Circle No 383

POWER MOSFETs

- Feature drain-to-source rating of 500V
- Have 2100-pF input capacitance

The APT5025AN features a 500V drain-to-source voltage, a ±30V max gate-to-source voltage, an 18A continuous drain current, and a 72A pulsed drain current. Its power dissipation equals 180W at 25°C, and its operating range spans -55 to +150°C. The APT4525AN has a 450V drain-to-source voltage; all of its other specs match those of the 5025AN. The input capacitance for both devices equals 2100 pF. You

Would you hesitate to save US \$ 150,000?



VARTA Ni-Cd button cells, if used instead of cylindricals, may decrease your production costs remarkably. For instance, if you produce 100,000 real-time clock devices per year using VARTA button cells with less than 300 mAh you will save at least US\$ 150,000.

Let us prove that to you! Also check these other advantages: Small Dimensions, Low Self-Discharge,

Rugged Construction, High Charging Efficiency and Good Load Performance. Using VARTA Ni-Cd button cells gives the benefits of superior energy, better design and lower costs to your product.

Order your test samples now!



VARTA Batterie AG · Am Leineufer 51 · D-3000 Hannover 21 · W-Germany
VARTA Batteries Inc. · 300 Executive Boulevard · Elmsford · N.Y. 10523-1202 · USA
VARTA Batteries Pte. Ltd. · P.O.Box 55 · Bedok North Post Office · Singapore 9146

CIRCLE NO 135

VARTA

The world's largest battery only manufacturer

HOURS

75004

MINIMUM DEMONSTRATED MTBF

Better Power System Mileage... A Standard from NCR

NCR standard switching power systems are designed for the long haul — with *demonstrated* MTBF in excess of 75,000 hours!

That remarkable reliability figure applies to the entire NCR switcher line, from 100 to 500 watts with one to four outputs. Safety and EMI performance meet UL, FCC, CSA and TUV (VDE) standards.

NCR standards also include power-fail signal, over-voltage protection, over-current protection and other performance safeguards.

And, if NCR's standard switchers don't fit your requirement precisely, ask about our impressive custom and semi-custom power system capability.

75,000 hours MTBF, full safety/EMI certification, on-line performance safeguards and custom or semi-custom design capability — add them up and they mean lowest cost of ownership. That makes NCR your best buy for power switchers.

For more information contact NCR Power Systems, 3200 Lake Emma Road, Lake Mary, FL 32746-3393. Telephone 800/327-7612, in FL 407/323-9250

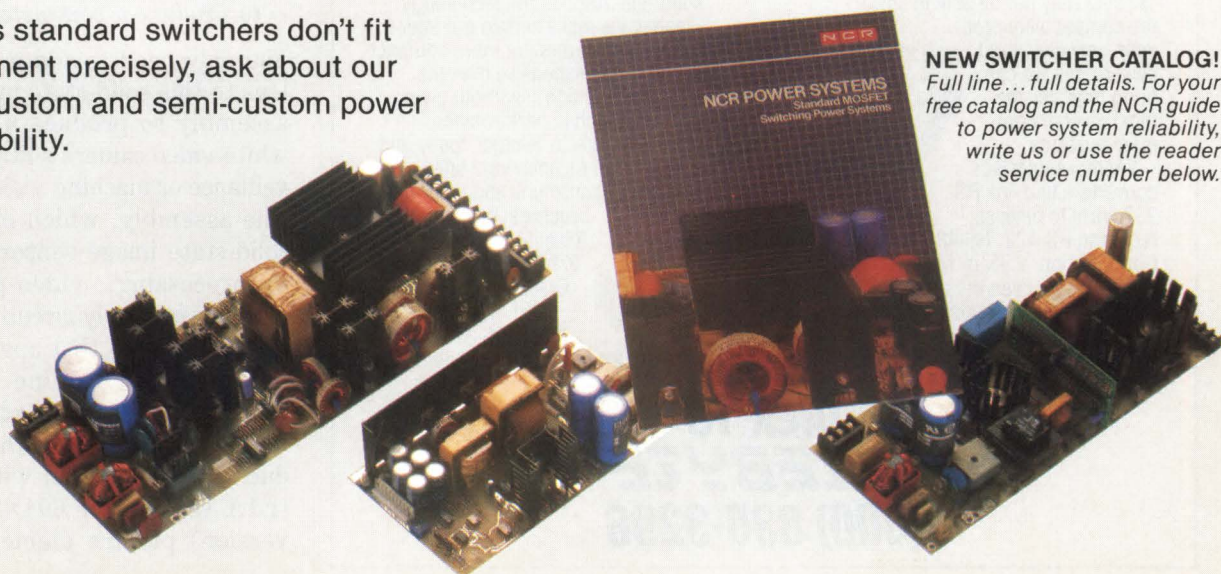

NEW SWITCHER CATALOG!
Full line... full details. For your free catalog and the NCR guide to power system reliability, write us or use the reader service number below.

can obtain each device in a TO-3 package or in die form. Military versions, tested in accordance with MIL-S-19500, are available. APT-5025AN, \$22 (1000); APT4525AN, \$19.80.

Advanced Power Technology, 405 SW Columbia St, Bend, OR 97702. Phone (503) 382-8028.

Circle No 384

POWER SUPPLY

- Operates nonderated to 70°C
- Meets CSA, FCC, and MIL-STD-810C standards

The Tron Series open-frame switching supply provides 31W of power in a 70°C operating environment without derating. It delivers 5V at 2.2A, 12V at 1.5A, and -12V at 100 mA.

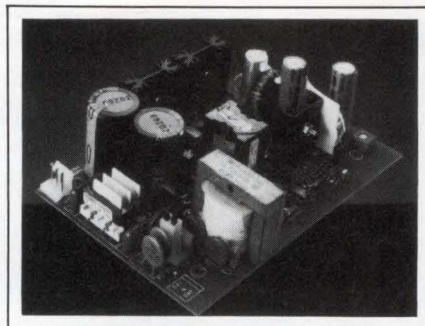

Its switching frequency equals 100 kHz, and its efficiency specs at 75%. The regulation figures range from ± 0.25 to $\pm 0.75\%$ for line and ± 1 to 3% for load. The supply is UL recognized and meets CSA, FCC, and MIL-STD-810C (vibration and shock) standards. \$80. Delivery, stock to eight weeks ARO.

Wells-Gardner Electronics Corp, 2701 N Kildare Ave, Chicago, IL 60639. Phone (312) 252-8220. TLX 253286.

Circle No 385



TELEBYTE INTERFACE CONVERTERS SOLVE ALMOST ANY COMPATIBILITY PROBLEM.

Telebyte may not be able to solve the compatibility problems between world powers, but we can bring together the most diverse computer systems.

We make interface converters that link RS-232 ports to devices requiring RS-422, RS-485, Current Loop, V.35, or MIL-STD-188-114. Even the new EIA-530 spec. We supply stand-alone or rackmounted versions.

No one offers a wider range of

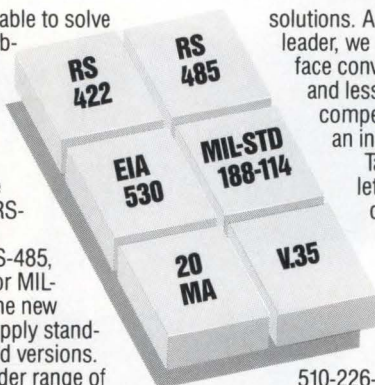

solutions. And, as the technology leader, we make certain our interface converters are more compact and less expensive than the competition's, without giving an inch in performance.

Talk to Telebyte today and let us open your lines of communication. For our brochure, call or write: Telebyte Technology, Inc., 270 East Pulaski Road, Greenlawn, NY 11740. (516) 423-3232. (516) 385-8080. TWX:

510-226-0449 FAX: (516) 385-8184

**TALK TO
TELEBYTE
(800) 835-3298**

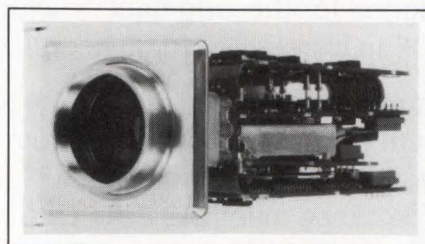

CAMERA ASSEMBLY

- Produces a 525- or 625-line video output
- Requires only a lens and chassis to produce a complete camera

You only need to add a chassis and lens to this solid-state image sensor assembly to produce a black-and-white video camera suitable for surveillance or machine-vision systems. The assembly, which includes the solid-state image sensor and drive, preprocessing, video-processing, and power-supply circuitry, is available in versions that operate to 525-line EIA or 625-line CCIR TV standards. When operating in the noninterlaced mode, the unit produces a video signal with 610x244 (EIA version) or 604x294 (CCIR version) picture elements. When

THE NEW POWER IN RECHARGEABLE BATTERY TECHNOLOGY.

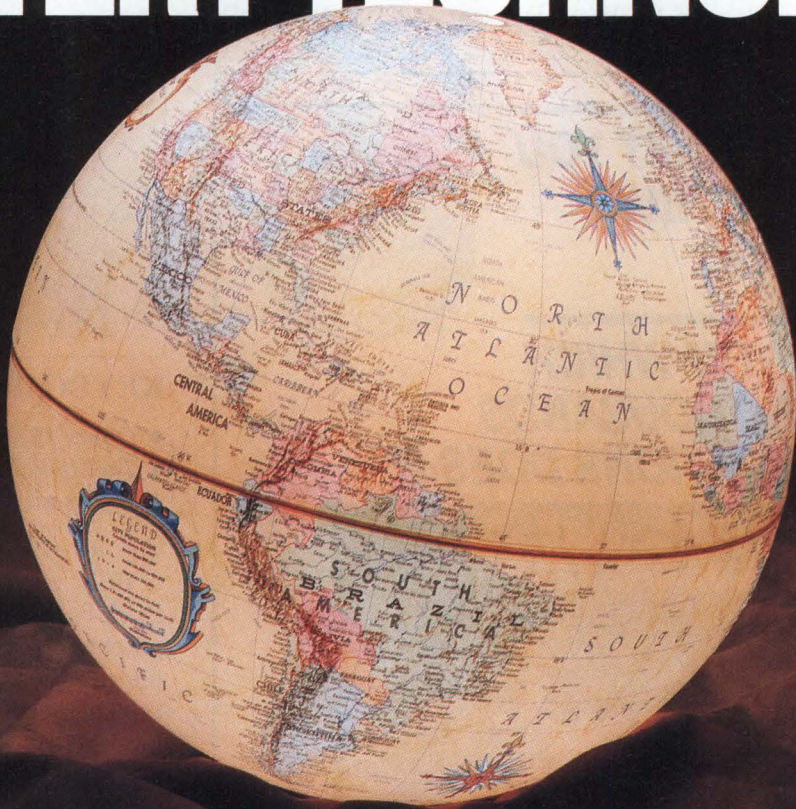

Gates Energy Products has purchased GE's Battery Business Department, making us the world's largest source of sealed rechargeable batteries.

What does this mean to you?

That Gates is dedicated to providing you with the best rechargeable batteries in the world.

Gates now has the technology and resources to offer the largest selection of rechargeable batteries including nickel cadmium, nickel hydrogen and sealed lead batteries—from .065Ah to 300Ah.

Leading the technological advancements at Gates is our new GEMAX™ Series of nickel cadmium cells. These cells are providing more run time and maximizing power delivery in all product applications by incorporating higher capacities and lower internal resistance.

As a result of GEMAX technology, Gates now offers the world's highest capacity, production-volume Sub C cell at 1.4Ah (1-hour rate). And more advancements are on the way.

Our commitment to supply batteries tailored to your specific applications is

yet another aspect of our determination to make sure that Gates batteries are superior.

No other rechargeable battery company in the world is taking such dramatic steps to perfect and expand their rechargeable battery products as the new Gates. It's time you discovered the difference.

For more information worldwide, contact one of the Gates Regional Sales Offices listed below.



WESTERN U.S.
4063 Birch St. #130
Newport Beach,
CA 92660
(714) 852-9033

CENTRAL U.S.
2860 S. River Rd.
Suite 401
Des Plaines, IL 60018
(312) 827-9130

EASTERN U.S.
1 Prestige Dr.
Meriden, CT 06450
(203) 238-6840

SOUTHERN U.S.
1835 Savoy Dr.
Suite 200
Atlanta, GA 30341
(404) 458-8755

PACIFIC AND ASIAN
3706 A, Shun Tak Centre
200 Connaught Rd. Central
Hong Kong
011-852-5-403073

EUROPE
Units 12/13
Loomer Rd. Industrial Estate
Chesterton
Newcastle-under-Lyme
Staffs. ST5 7LB, Great Britain
011-44-782-566525

©1987 Gates Energy Products, Inc.

operating in the interlaced mode, the unit produces 610×488 (EIA) or 604×588 (CCIR) picture elements. Other selectable functions include compensation for gamma predistortion, automatic or computer-controlled gain, automatic iris control, and internal or external clock synchronization. The image sensor works in ambient light as low as 1

lux and still generates a useable picture at 0.5 lux. The signal-to-noise ratio is 46 dB, and the video bandwidth is 5.8 MHz for -6-dB gain. The output is a 1V p-p composite video signal. The assembly accepts standard C-mount lenses. The power consumption is a maximum of 165 mA from a single 12V supply. From DM 600 and DM 1300 (OEM

qty).

Philips, Components Div, Box 523, 5600 AM Eindhoven, The Netherlands. Phone (040) 757189. TLX 51573.

Circle No 386

Amperex Sales Corp, Providence Turnpike, Slatersville, RI 02876. Phone (401) 762-9000.

Circle No 387

YOU TELL US WHAT YOU NEED YOUR LITHIUM BATTERY TO DO.



WE'LL TELL YOU WHICH ONE OF OUR THOUSANDS OF CONFIGURATIONS DOES IT.

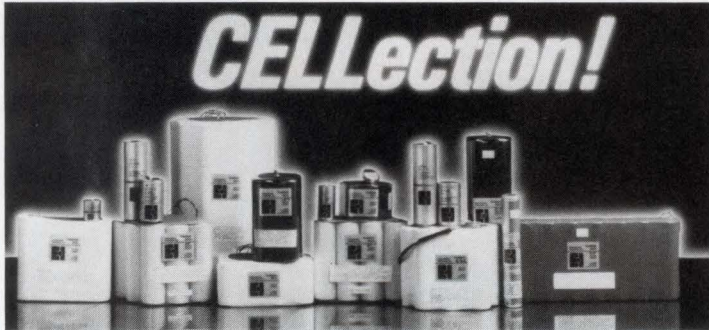

THE CELLECTION™ PROCESS WE'VE DEvised IS SO SIMPLE, YOU'LL WONDER WHY OTHER PEOPLE HAVEN'T DONE IT TOO.

Call or write for your CELlection Starter Kit. Our technical specialists will contact you to address your specific requirements.

A variety of lithium-based cell chemistries is available to meet the needs of specific applications. A broad range of sizes, terminations and pack configurations is available.



DIVISION OF WILSON GREATBATCH LTD.
10,000 WEHRLER DRIVE
CLARENCE, NEW YORK 14031
(716) 759-2828 TELEEX: 91-386
FAX: (716) 759-8579



KEYBOARD

- Offers IBM compatibility
- Tactile keyswitches for fast typing speed

The 101-position KB-5161 keyboard is fully compatible with the IBM PC/XT, PC/AT, PS/2, and 386 computers. Each mechanical keyswitch features a tactile design for fast typing speed. All key caps are double injection molded with identifying alphanumeric characters molded in place for long life. The keyboard features a large L-shaped enter key, and double-wide backspace, shift, and caps-lock keys. The keyboard comes in a gray dust cover and operates from ±5V supplies. The full 101-key layout is on screen when you use the unit with IBM diagnostics. \$89.

Chicony America Inc, 1641 W Collins Ave, Orange, CA 92667. Phone (714) 771-6151.

Circle No 388

DC/DC CONVERTERS

- Designed for VME Bus applications
- Offer single and dual outputs ranging from 2 to 48V

VMEC Series dc/dc converters are designed for VME Bus applications. They are available in 40 and 80W

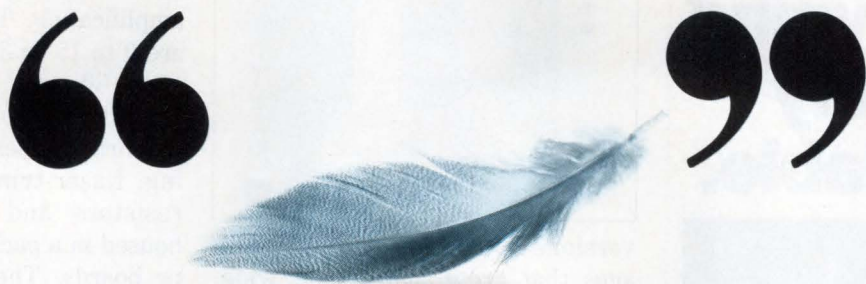

THE SOUND OF A SEIKO THERMAL PRINTER.

If you need a printer that's very, very quiet, here's something to shout about. The DPU-411 from Seiko Instruments. It's so quiet, you'll forget it's there. So you can work while it does.

And thanks to its small size and rechargeable battery back-up, it's completely portable. In fact, at a featherweight 2.2 pounds, you can take it wherever you need a small, ultra-quiet printer.

With both RS232C and Centronics 8-bit parallel interfaces standard, the DPU-411 will fit easily into your system. And you can print either a standard 40 column or condensed 80 column line.

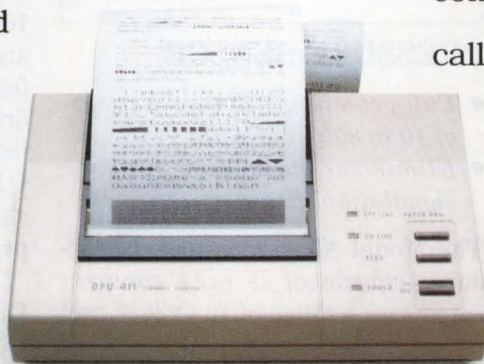

Of course, like all Seiko printers, it's manufactured for a long life.

What's more, the only maintenance you'll ever need to perform is putting in new paper. Which means it won't create any noise from people yelling about messy ribbons or upkeep.

It won't cause any noise when you get the bill, either. Because the DPU-411 is very competitively priced.

To help keep your office quiet, call Seiko today at (213) 517-7770. And ask about the thermal printer that's quiet, portable and affordable.

SEIKO I 
Seiko Instruments USA

2990 West Lomita Blvd., Torrance, CA 90505
(213) 517-7770 • FAX: (213) 517-7792

CIRCLE NO 141

Now in-house prototyping is truly affordable.

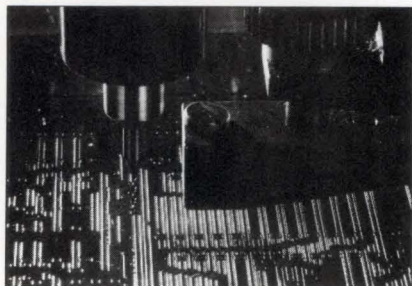

Mills and drills circuits in minutes.

There's no reason to waste time and money sending out for prototype circuit boards any longer. With the new BoardMaker, you can make your own prototypes in your own lab directly from your PCB CAD—as fast as you need them.

No delays or rush charges.

BoardMaker engraves single and double-sided boards, forming conductor lines as small as 5 mil. (There is a throughplate option too.)

A 2" x 3" board with medium density, for example, takes about 15 minutes. So you can save a week or more at every level of design development. You also save the money spent on outside sources, along with costly charges for rush service that can't compare with BoardMaker speed.

No chemicals.

BoardMaker is totally mechanical. There are no chemicals, no fumes, and no toxicity problems.

At \$5,000, pays for itself fast.

BoardMaker is revolutionary because it costs one-sixth the price of first generation prototype machines—and literally pays for itself after about a dozen boards. For more information, call (415) 883-1717 or use the reader card.



20A Pamaron Way
Novato, CA 94948

CIRCLE NO 140

COMPONENTS & POWER SUPPLIES

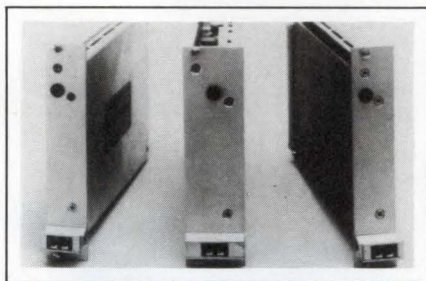

versions housed in 3U-high packages that are 1 and 1.4 in. wide, respectively. Models are available with single and dual outputs ranging from 2 to 48V dc. The temperature coefficient measures 0.02%/°C, the switching frequency equals 125 kHz, and the ripple and noise spec at 1% or 50 mV, whichever is greater. Standard features include isolated outputs, EMI filtering, remote sensing, and overvoltage and overload protection. The line regulation equals ±0.1%, and the load regulation equals ±0.2%. 40W version, \$127; 80W version, \$169.

Power Pac Inc, Box 777, Norwalk, CT 06856. Phone (203) 866-4484.

Circle No 390



PRESSURE SENSOR

- Fully compensated over a range of 10 to 85°C
- Eliminates the need for further signal amplification

The Model XT silicon-based pressure transducer is fully compensated over a range of 10 to 85°C and is calibrated to an accuracy of ±0.25%. Operating from 5V dc excitation, the transducer provides an

output of 0.5 to 4.5V dc, which eliminates the need for further signal amplification. The pressure ranges are 0 to 15 or 30 psia, and 0 to 7.5, 15, or 30- psig. A piezoresistive element diffused onto an etched silicon diaphragm does the pressure sensing. Laser-trimmed compensation resistors and an amplifier are housed in a package that mounts on pc boards. The transducer has an operating range of -40 to +125°C. \$24 (OEM qty).

Data Instruments Inc, 100 Discovery Way, Acton, MA 01720. Phone (617) 264-9550. TLX 200081

Circle No 391



OPTICAL ENCODER

- Provides resolutions to 1800 cycles
- Features TTL/CMOS-compatible outputs

Model 84C optical incremental encoder provides resolutions to 1800 cycles and features a quadrature output plus an index marker pulse. Its operating frequency ranges to 100 kHz, and its outputs are TTL and CMOS compatible. Its standard features include a differential line driver and operating voltages ranging to 24V. The encoder cover meets UL 94V-0 requirements and the shielded cable is UL and CSA approved. \$73 (100).

Litton Systems Inc, Encoder Div, 20745 Nordhoff St, Chatsworth, CA 91311. Phone (818) 341-6161.

Circle No 392

Ultra-Speed Memory:

CAPTURE 640 MB IN 3.2 SECONDS

Cluster units to 80 GB

From Dataram: high-speed data acquisition and management for signal/image processing, logic analysis, AI, other advanced applications.

- FAST: 200 MB/sec bidirectional
- FLEXIBLE: up to 8 I/O ports
- ADAPTABLE: interfaces for VAX, MicroVAX, Gould, Star, Numerix, VME, and others
- EXPANDABLE: 8-640 MB/unit

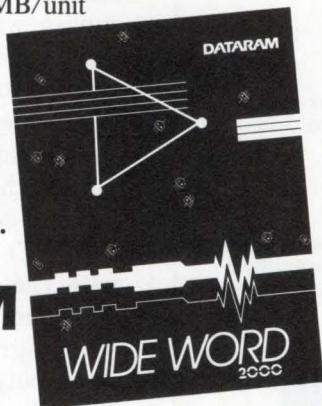

FOR BROCHURE:
Circle the Reader Response
Number, or contact us
directly for fastest response.

DATARAM

Dataram Corporation
P.O. Box 7528
Princeton, NJ 08543-7528
609-799-0071 • 800-822-0071

CIRCLE NO 142

RAF hands you a choice line of handles and ferrules ... just in time.

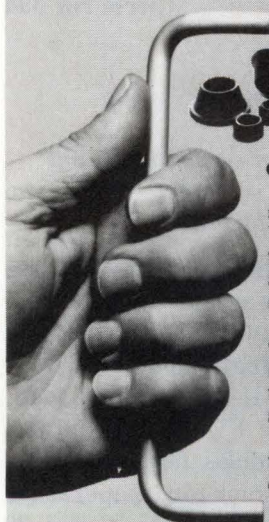

Give your cabinets a distinctive high-tech look with our handsome assortment of round, oval and round-offset handles and matching ferrules. Precision-made and dimensionally accurate, they are available in a wide variety of sizes, materials and finishes.

With more than 35,000 items in stock, all orders get prompt attention. Your order can be filled and shipped the same day — *just in time delivery* arranged to suit your future requirements.

For the high quality you need, when you need it, you can depend on RAF's more than 50 years of manufacturing experience and reliable service.

Call or write today for our fully illustrated catalog, or additional information on specific products.



FREE designer's catalog

RAF

Electronic Hardware, Inc.
95 Silvermine Road • Seymour, CT 06483
(203) 888-2133 • FAX (203) 888-9860

CIRCLE NO 144

EDN April 14, 1988

Manufacturing

CMS has the manufacturing flexibility to meet your low or high volume production requirements for quality custom Molded-On® cable assemblies. CMS order processing is designed to deliver 100% on time shipments. Our 40 years of experience help you meet the challenges of today's dock to stock and JIT requirements. Call or write Component Manufacturing Service, Inc.; One Component Park, West Bridgewater, MA 02379. Tel. (617) 580-0111.

CMS is the Molded-On® connector company.

CIRCLE NO 143

V SERIES SWITCHING POWER SUPPLIES Engineered and Manufactured by Perfectionists!

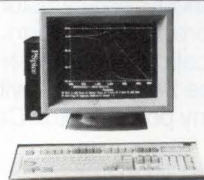

Simulations by SPICE

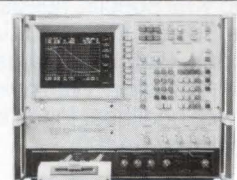

Stability by HP/VENABLE

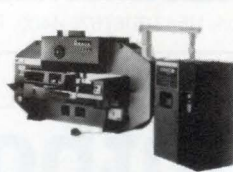

Sheet Metal by AMADA



Auto Insert by UNIVERSAL



Testing by ZEHNTTEL

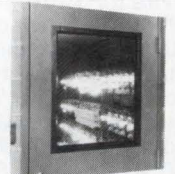

Burn In by CENTIGRADE



Service by PHILLIPS

Call Toll Free 1-800-523-2332



PO BOX 1369 ■ WISSAHICKON AVENUE NORTH WALES, PA 19454
PHONE 215-699-9261 FAX 510-661-6061

See us at Electro '88 at Booths 406-408

CIRCLE NO 145

275

IF YOU STILL THINK YOU NEED LONG LEAD TIMES AND HEAVY PREMIUMS FOR CUSTOMIZED LINE CONDITIONERS, THINK AGAIN!



DISPLEX DELIVERS IN A FRACTION OF THE TIME! AT A FRACTION OF THE COST!

What's our secret? Two things. One, CAE/CAD to speed up the design and specification process. Two, a complete line of pre-engineered, pretested off-the-shelf modules that can be assembled quickly in any configuration—with any combination of features and options.

Engineered to eliminate line noise, spikes and surges, they're easily tailored to your specific needs—without costly "customization" delays. Features include: Magnetic circuit breaker protection. Field replaceable surge suppressors. Full status indication. High inrush current and brownout protection. With noise-free zero current switching, they can operate with nonlinear loads and any power factor. Call or write for details: (516) 671-4400.

DISPLEX, INC. Subsidiary of North Hills Electronics
1 Alexander Place, Glen Cove, New York 11542 (516) 671-4400. TELEX: 46-6886

CIRCLE NO 146

Be An Author!

When you write for EDN, you earn professional recognition. And you earn \$75 per published magazine page.

EDN publishes how-to design application information that is read by more than 137,000 electronics engineers and engineering managers worldwide. That's an audience that could belong to you.

If you have an appropriate article idea, please phone Rick Nelson, Managing Editor, at (617) 964-3030, or send a proposal and outline to him at 275 Washington Street, Newton, MA 02158-1630. For a FREE EDN Writer's Guide—which includes tips on how to write for EDN and other technical publications—please circle number 800 on the Information Retrieval Service Card.

EDN First in Readership among Design Engineers
and Engineering Managers in Electronics

COMPONENTS & POWER SUPPLIES

ISOLATOR

- Suitable for driving power MOS-FETs
- Provides 370V input-to-output isolation

The VB300 is suitable for isolating the gate-control voltage of power MOSFET transistors. To activate the output, you drive the device's differential inputs with antiphase square waves. Inside the device, these square waves are capacitively coupled to the output and rectified to provide a dc output voltage that is approximately 1.5V lower in amplitude than the input signal. The input-to-output isolation is rated at 370V. The inputs are compatible with CMOS logic and withstand a maximum signal amplitude of 20V. An integral resistor across the device's output discharges the output when the ac input signal is removed. \$0.68 (1000).

SGS-Thomson Microelectronics, Via C Olivetti 2, 20041 Agrate Brianza, Italy. Phone (039) 65551. TLX 330131.

Circle No 393

SGS-Thomson Microelectronics, 1000 E Bell Rd, Phoenix, AZ 85022. Phone (602) 867-6100. TLX 249976.

Circle No 394

LED MODULES

- Available in single-mode and multimode versions
- Operate at 1300 nm

These edge-emitting LEDs operate at a nominal wavelength of 1300 nm and are available in FU-41SEL and FU-42SEL single-mode, and FU-31EL and FU-32EL multimode, versions. The FU-42SEL and the FU-32EL modules feature a thermoelectric cooler for temperature stabilization and couple 10 and 30 μ W into single-mode and multimode fiber, respectively. The FU-41SEL and FU-31EL modules do not have a thermoelectric cooler, and their re-

SLIC ICs.

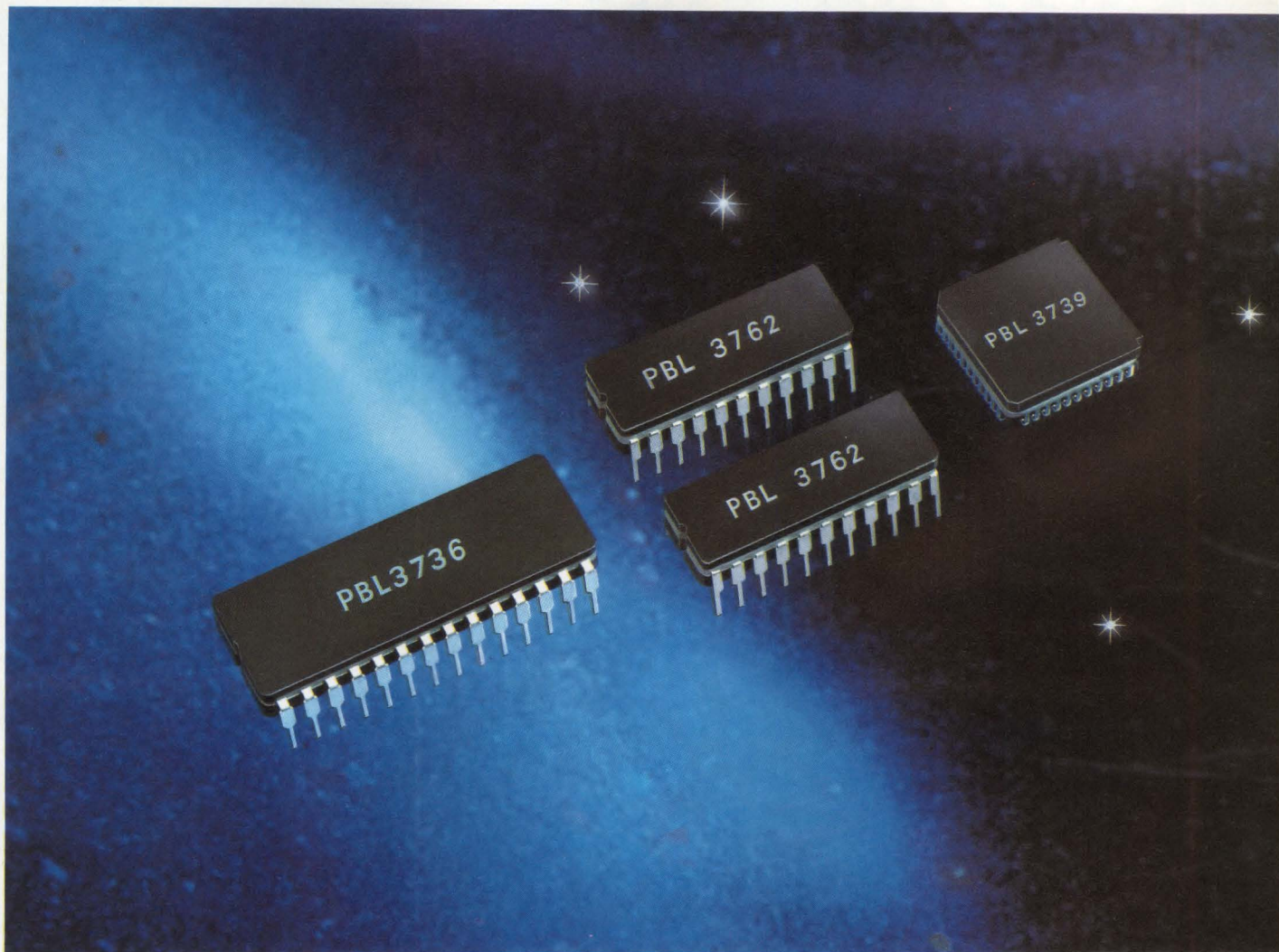

Choose RIFA for the world's leading family of Subscriber Line Interface Circuits. First in the field with monolithic SLIC production, we now offer the widest selection, to suit every application.

Many of our industry-standard devices are now second-sourced; our leadership in bipolar production techniques guarantees space-age reliability.

PBL 3736.

Originally designed for Central Office use, also recommended for high-quality PABX applications. Full-line interfacing in compact CERDIP package. On-board voltage switching regulator cuts power dissipation and the need for special heat sinking. Features include polarity reversal and a digital interface for efficient operating parameter control.

PBL 3762.

High-performance, resistive-feed SLIC designed for PABX. Excellent longitudinal-to-metallic balance, 63dB min, 70dB typical, meets FCC requirements easily. Special -40°C version for outdoor use, eg in Subscriber Loop Carrier Systems.

PBL 3739.

Special version of PBL 3736 designed for very high density PABX line cards. Built-in switching voltage regulation, very low heat dissipation, in 44-pin J-lead Quad CERPAC for surface mounting.

Call up RIFA and discover the fullest set of data, longest experience and genuine design partnership.

We're in the lead

RIFA Inc.

403 International Pkwy
Richardson, TX 75085-3904
Telephone (214) 480-8300
Telefax (214) 680-1059

ERICSSON 

RIFA is a member of the Ericsson Group

CADSTAR™ — THE NEWEST PLAYER ON THE REDAC SOFTWARE TEAM.



TEAM UP WITH A STAR IN PC-BASED PCB CAD.

Gear up for winning play in PCB CAD with new CADSTAR *Design and Layout Software*. At last, one PC-based system can handle the multitude of PCB designs that cross your desk . . . from dual in-line designs to multilayer, double-sided surface-mount designs. And CADSTAR is compatible with its Redac software teammates, assuring you a game plan for future growth.

CADSTAR brings into play powerful features such as automatic component placement, automatic gate and pin swapping, dynamic rubber banding and automatic routing. They enable you to get your designs to the

market faster and with complete manufacturability.

What's more, CADSTAR is backed by the leading player in PCB CAD with over 20 years of experience in the field. From the PC-based systems to the engineering workstation-based Visula system, Racal-Redac supports every level of electronic design automation.

Team up with the winner! Also ask about our low-cost CADSTAR interactive package. Call for a demonstration.



CADSTAR™

RACAL-REDAC

238 Littleton Road
Post Office Box 365
Westford, MA 01886-9984
Telephone: (617) 692-4900

COMPONENTS & POWER SUPPLIES

spective outputs into single-mode and multimode fiber are 6 and 20 μ W. \$460 to \$690 (10).

Mitsubishi Electronics America Inc, Semiconductor Div, 1050 E Arques Ave, Sunnyvale, CA 94086. Phone (408) 730-5900.

Circle No 395

RESISTOR

- Features resistance TC matching to ± 5 ppm/ $^{\circ}$ C
- Offers standard tolerance of 1%

The Type WW silicone-coated wirewound power resistor features centerless ground-ceramic cores for optimum heat distribution and dissipation, and an all-welded construction that meets or exceeds MIL-R-26. The device is available in power ratings ranging from 0.4 to 12W at 25 $^{\circ}$ C. Its standard resistance values range from 0.1 Ω to 200 k Ω , and its standard tolerance equals 1%. Special features available on request

include flame-resistant construction, resistance network packages designed for individual customer requirements, and TC matching and tracking to ± 5 ppm/ $^{\circ}$ C. The operating frequency range spans dc to 30 MHz. The resistors are available in bulk or tape-and-reel packaging. \$0.25 to \$0.85 (1000). Delivery, 12 weeks ARO.

Allen-Bradley, Electronic Components Div, 1414 Allen-Bradley Dr, El Paso, TX 79936. Phone (800) 592-4888; in TX, (800) 292-4888.

Circle No 396

PROTOTYPING BOARD

- Provides a way to evaluate high-speed GaAs devices
- Accommodates speeds to 5 GHz

The MD12BRD 4-layer universal prototyping board provides an easy way to evaluate high-speed GaAs logic devices. It has nine sites for

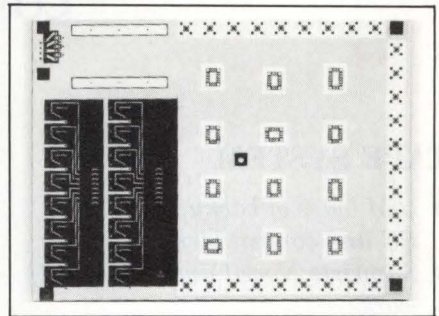

16-pin flatpack ICs and three sites for 20-pin flatpack ICs, and provides easy access to power-supply and RF interconnections. The board is designed for applications reaching impedance levels as high as 50 Ω and clock speeds as high as 5 GHz. It comes with application and assembly information, as well as a list of recommended capacitors, termination resistors, heat sinks, and RF interconnections. \$100.

California Eastern Laboratories Inc, 3260 Jay St, Santa Clara, CA 95054. Phone (408) 988-3500.

Circle No 397

PACESETTER PRODUCTIVITY

100 MHz TEK 2246A/2245A

Smart scopes, perfect setup! Tek sets the new, fast pace \$1795/\$2395 for frequent measurements with automatic front panel setup. Nonvolatile memory for up to 20 front-panel setups (2246A). Time and voltage cursors. Exclusive SmartCursors™ track waveform changes for voltage measurements. All backed by Tek's 3-year warranty.

NEW

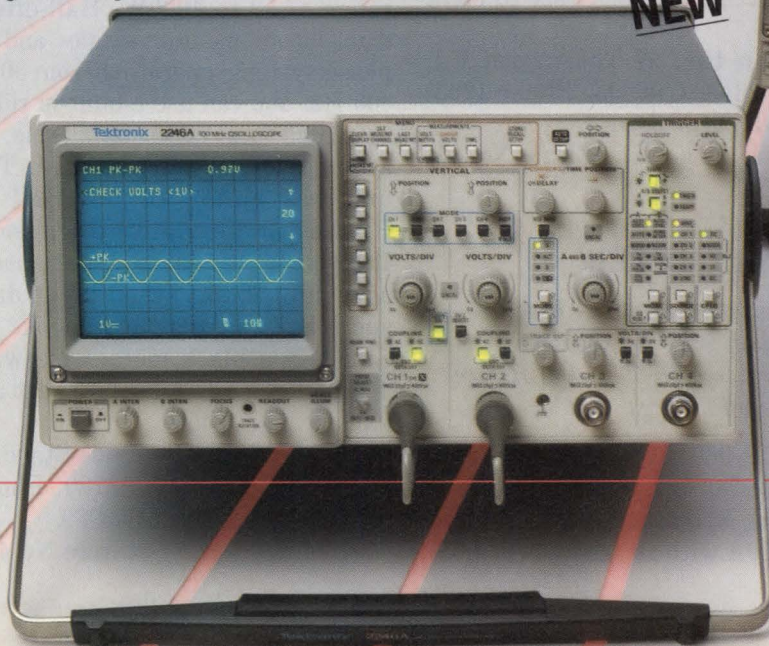

Call Tek direct
for PaceSetter specs!
1-800-426-2200

Prices subject to change without notice.

Copyright ©1988, Tektronix, Inc. All rights reserved. TTA 906-A

Tektronix
COMMITTED TO EXCELLENCE
CIRCLE NO 149

NEW PRODUCTS

COMPUTERS & PERIPHERALS

TAPE SYSTEM

- 40M bytes of backup for IBM PC and compatibles
- Supports Novell and 3COM networks

According to the vendor, the Jumbo 40M-byte tape backup system for the IBM PC, PC/XT, PC/AT, PS/2, and compatible computers can store 10M bytes of data for an IBM PC/AT within five to six minutes. The menu-oriented software is DOS compatible and supports Novell and 3COM networks. File tagging and unattended backup are standard features. An Advanced Reed-Solomon error corrector delivers a bit error rate of 1×10^{-14} . The unit has 5 ICs, and an autocalibration feature adjusts for cartridge-to-cartridge

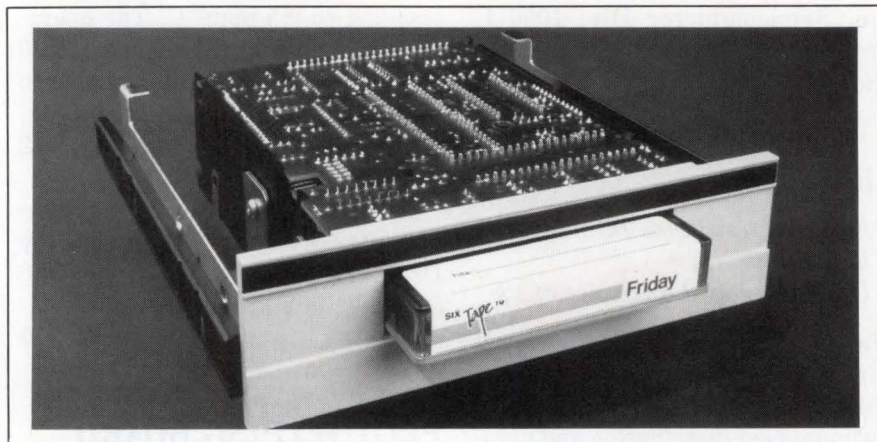

variations so that no further adjustment is required for the life of the drive. It interfaces with the floppy controller and samples the data-transfer rate to automatically set the drive to the fastest available speed. A mounting kit adapts the

drive to the PS/2 internal 3½-in. drive slot. \$300.

Colorado Memory Systems Inc., 800 S Taft Ave, Loveland, CO 80537. Phone (303) 669-8000. TWX 910-930-9021.

Circle No 400



HANDHELD COMPUTER

- Operates over a -25 to $+55^{\circ}\text{C}$ range
- Runs the CPM operating system and has two RS-232C ports

Configured for ruggedized applications, the Microscribe Challenger handheld computer is waterproof and operates over a -25 to $+55^{\circ}\text{C}$ range. It comes with two RS-232C ports, 128k bytes (expandable to 320k bytes) of memory, an 8-line \times 40-character LCD display, and a 48-key membrane-type keyboard. Nickel cadmium batteries act as the device's power supply and typically provide 40 hours of life. The firmware includes a CPM operating sys-

tem and an extended basic interpreter. The optional software, supplied on a 360k-byte IBM disk, allows file transfers between the unit and an IBM PC or a compatible computer. Also available is optional barcode software for data collection. You can buy the unit with a built-in CCITT V.21 modem that runs at 300 baud. The computer measures $8.4 \times 6.4 \times 1.5$ in. and weighs 3.9 lbs. From \$2280. Delivery, six to eight weeks.

Amlan Inc., 97 Thornwood Rd, Stamford, CT 06903. Phone (203) 322-1913. TLX 643647.

Circle No 401

AC WATTMETER

- Measures 0.5 to 20A in 120 through 230V ac systems
- Operates with 50 to 400 Hz single- and 3-phase systems

The DP-960 AC wattmeter measures power in 120 through 230V ac systems; it measures current from 0.5 to 20A with an accuracy of 0.5%,



giving it a power-measurement range of 50 to 4000W. Hall-effect transducers monitor single- and 3-phase systems operating from 50 to 400 Hz. You can use a built-in relay to switch local or visual alarms, or as a thermostatic controller. The unit has either an RS-232C or RS-422 port for data transmission. It is compatible with software packages supporting serial-input data such as LabTech Notebook. It comes in a black metal case with 4½-digit red LED displays that are 0.56 in. high. \$450.

Acculex Inc., 440 Myles Standish Blvd, Taunton, MA 02780. Phone (617) 880-3660. TLX 503989.

Circle No 402

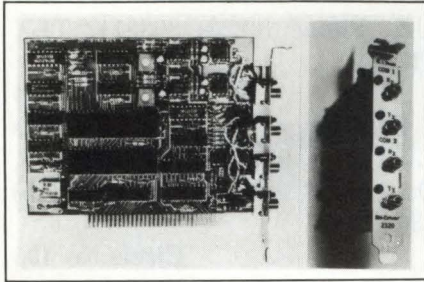

BIT DRIVERS

- *Asynchronous optical links for the IBM PC*
- *Optical links can be as long as 15,000 ft*

The Models 2320 I and II bit drivers are board products for the IBM PC, PC/XT, PC/AT, or compatible computers. Model 2320 I offers one full-duplex RS-232C channel, and Model 2320 II offers two RS-232C channels of asynchronous communications over fiber-optic links. The optical links are as long as 10,000 ft with an option of 15,000 ft. Each port can operate independently with data

rates as high as 19.2k bps. The primary channel operates as a COM I port addressed at 3F8. The alternate channel operates as a COM II port addressed at 2F8. Two SMA connectors or 1 AMP Optimate fiber-optic receptacle/channel serve as transmission line interfaces. Optical power into a 50- μ m-core optical fiber is 2 μ W at a wavelength of 880 nm. The board comes with diagnostic software. Model 2320 I, \$490; Model 2320 II, \$690.

SI Tech, Box 609, Geneva, IL 60134. Phone (312) 232-8640.

Circle No 403

DISPLAY SYSTEMS

- *Display 16 colors from a palette of 4096 colors*
- *Interface to the IBM PC/AT and PS/2 computers*

Xcellerator 1600 Series color graphics-display systems provide a dis-

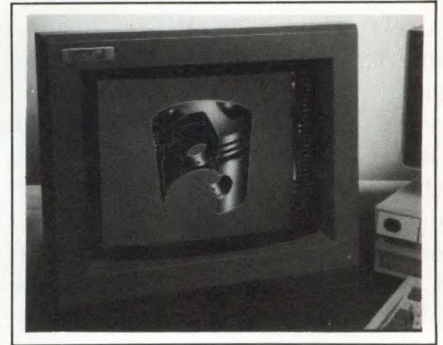

play resolution of 1600x1200 pixels and are compatible with both IBM PC/AT and IBM PS/2 computer architectures. They feature a 20-in. diagonal display and incorporate the Texas Instrument 34010 32-bit graphics system processor to achieve continuous vector-drawing speeds in excess of 80,000 vectors/sec, and 8x16-pixel character generation at 25,000 cps. You can operate the display system in two modes. The first mode displays 16 colors from a palette of 4096 colors, at a display resolution of 1600x1200

PACESETTER PERFORMANCE

100 MHz TEK 2236/2235

100 MHz scope, counter, timer, DMM — just \$2795

The ultra-versatile Tek 2236 makes measuring everything from frequency, period and width to delay time and Δ time push-button easy — in addition to CRT display, you get digital readout display accurate to 0.001% and beyond. PaceSetter performance on a modest budget? Look at the 100 MHz, dual-trace Tek 2235 with the best of the basics — just \$1575!

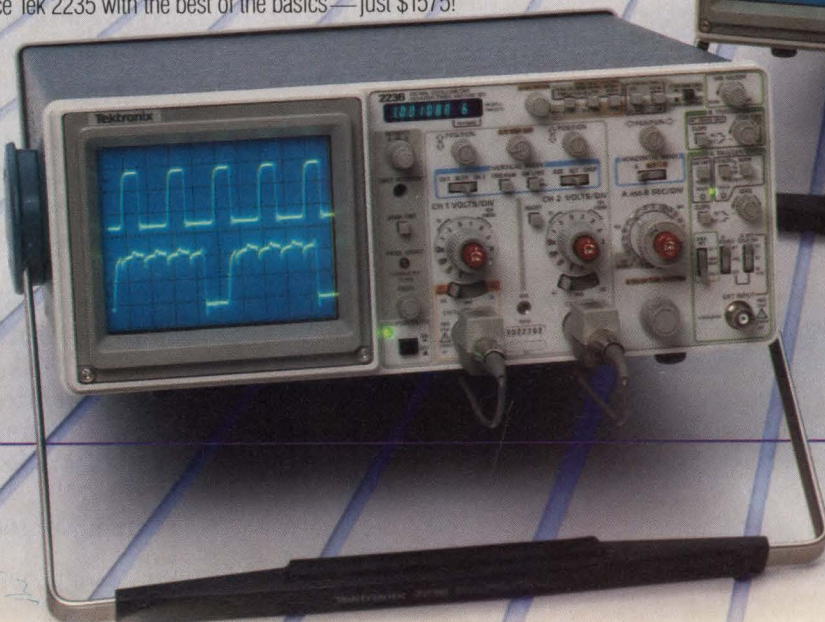
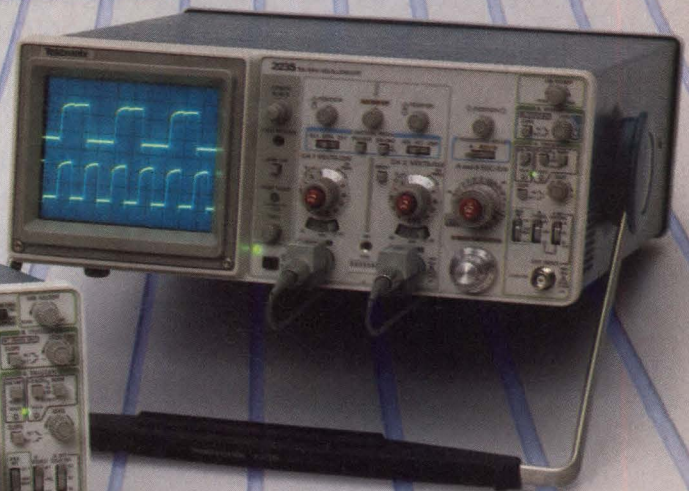

Call Tek direct
for PaceSetter specs!
1-800-426-2200

Prices subject to change without notice.

Copyright ©1988, Tektronix, Inc. All rights reserved. TTA 906-B

Tektronix
COMMITTED TO EXCELLENCE

CIRCLE NO 150

pixels. This mode utilizes a non-interlaced scan with a 60-Hz frame rate, a 75-kHz horizontal line rate, and a pixel clock frequency of 160 MHz. The second mode emulates the vendor's original Xcellerator display system, displaying 256 colors from a palette of 16.7M colors, at a display resolution of 1024x768 pixels. In its standard configura-

tion, the unit includes 1M byte of display-list RAM, but you can upgrade this to as much as 8M bytes. It connects to an IBM PC or compatible via a 2m cable and either a PC/AT-bus- or a Micro-bus-compatible interface card. Around £5500.

Cambridge Computer Graphics Ltd, Graphics House, Convent Dr, Waterbeach, Cambridge CB5 9QT,

UK. Phone (0223) 863311. TLX 817274.

Circle No 404

Cambridge Computer Graphics Ltd (USA), 6114 Lasalle, Suite 435, Oakland, CA 94611. Phone (415) 530-4148.

Circle No 405

PHILIPS PUTS THE HIGH IN HIGH FREQUENCY SMD's.

When you have higher aspirations in high frequency design, specify Philips surface-mounted broad band and RF transistors. They represent the highest technology with f_T up to 7.5 GHZ. And deliver the highest performance.

SOT-23, SOT-89, dual emitter transistors and dual gate MOS FETS in SOT-143 packages. Plus a complete line of PNP complements to industry standard NPN devices.

Raise your expectations. Call today for a complete brochure: (401) 232-0500. Amperex, George Washington Highway, Smithfield RI 02917

In Canada: Philips Electronics Ltd., 601 Milner Ave. Scarborough, Ontario M1B 1M8, (416) 292-5161.

PHILIPS: THE SOURCE FOR ALL YOUR SMD NEEDS.

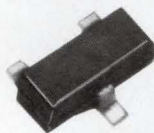

Amperex[®]
A NORTH AMERICAN PHILIPS COMPANY



See us at Electro Booth Nos. 1356-1358

CIRCLE NO 152

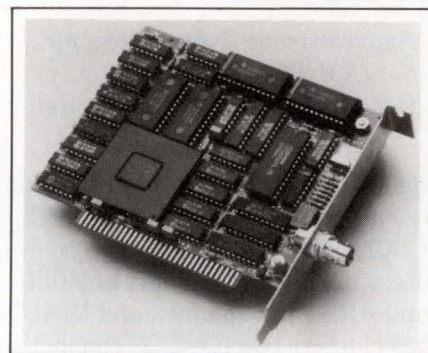

ADAPTER CARD

- Communicates with an IBM 3274 or 3174
- Uses any one of three IBM SNA protocols

The AdaptCoax is a multiprotocol communications adapter board for the IBM PC, PC/XT, PC/AT, and compatible computers. It provides a PC-to-host communications link to an IBM 3274 or 3174 cluster controller attached with coaxial cable, using any one of three IBM System Network Architecture (SNA) protocols: 3270; Logical Unit 6.2 Advanced Program-to-Program Communications (LU6.2/APPC); and 3770 Remote Job Entry (3770/RJE). You can switch between protocols by running different communications software. The unit takes advantage of the distributed-function terminal (DFT) feature of the 3274/3174 computers to achieve multiprotocol communications. The software runs under PC-DOS 2.0 or later versions, and requires at least 256k bytes of memory. Board, \$595; software products, from \$285 to \$785.

Network Software Associates Inc, 22982 Mill Creek, Laguna Hills, CA 92653. Phone (714) 768-4013.

Circle No 406

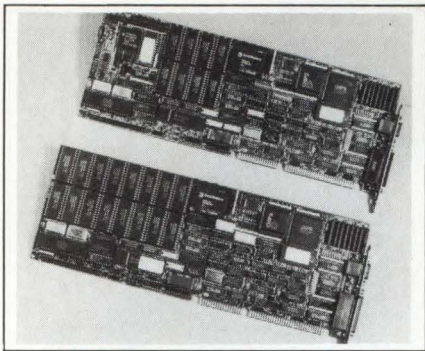

PC-BOARD SERIES

- Integrate multiple functions on a single board
- Each board plugs into an IBM PC/AT connector

The MC Series boards are designed for industrial applications for IBM PC/AT- and 80386-compatible computers. They integrate video and disk controllers, CMOS static RAM, EPROM storage, and parallel and serial communications ports on a single board. The video outputs conform to IBM CGA- and EGA-com-

patible and Hercules monochrome-compatible standards. You can currently choose between two boards in the series: The MC-01 contains a SCSI hard-disk controller and 256k bytes of CMOS static RAM or 512k bytes of EPROM; the MC-02 contains 512k bytes of CMOS static RAM or 1M byte of EPROM. Both boards feature lithium batteries for backup in case of power failure. MC-01, from \$650 (100).

Texas Microsystems Inc, 10618 Rockley Rd, Houston, TX 77099. Phone (713) 933-8050.

Circle No 407

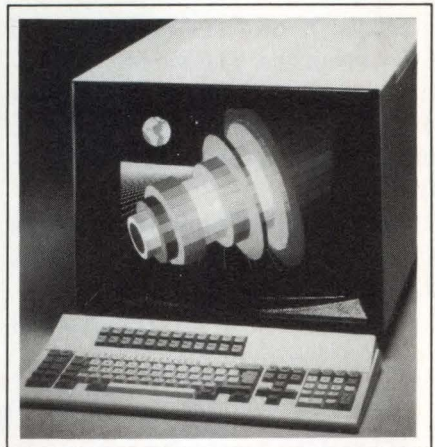

patible computer with a 19-in. Vari-Sync color monitor, can function as a stand-alone terminal or as a remote information display. The standard configuration contains an 80286 μ P, running at 8 MHz or 10 MHz; it also includes 1M byte of RAM, two serial ports, one parallel port, a real-time clock, and an IBM PC/AT-style keyboard. The vendor's EGA board, which is really two EGA cards, permits screen

DISPLAY SYSTEM

- Combines IBM PC/AT computer with 19-in. monitor
- Monitor operates with scan frequencies of 21 kHz to 33 kHz

The Cebra 286 display system, which combines an IBM PC/AT or a

PACESETTER PRICE

50 MHz TEK 2210/2225

Best-of-class performance at

\$995/\$2195 Get the PaceSetter start in digital storage with Tek's NEW 50 MHz 2210. Featuring 20 MS/s per channel digitizing, 4K record length per channel plus familiar, full-bandwidth analog operation for just \$2195. And for pure and simple analog performance with unmatched economy, look at the popular, 2-channel Tek 2225 — just \$995!

NEW 2210
20 MS/s per channel



Call Tek direct
for PaceSetter specs!
1-800-426-2200

Prices subject to change without notice.
Copyright ©1988, Tektronix, Inc. All rights reserved. TTA 906-C

CIRCLE NO 151

Tektronix
COMMITTED TO EXCELLENCE

overlays; it provides resolutions of 640x480 pixels. The Vari-Sync monitor operates with scan frequencies of 21 kHz to 33 kHz. With a 13-in. monitor, \$3600; with a 19-in. monitor, \$4000.

Colorgraphic Communications Corp., Box 80448, Atlanta, GA 30366. Phone (404) 455-3921.

Circle No 408

CAMAC BOARD

- Links the IEEE-583 bus to DEC computers
- Crates can be located as far as 50 ft from the host

The CC-DR11 interface board for the CAMAC IEEE-583 instrument bus handles data transfers to DEC computers. It can transfer parallel

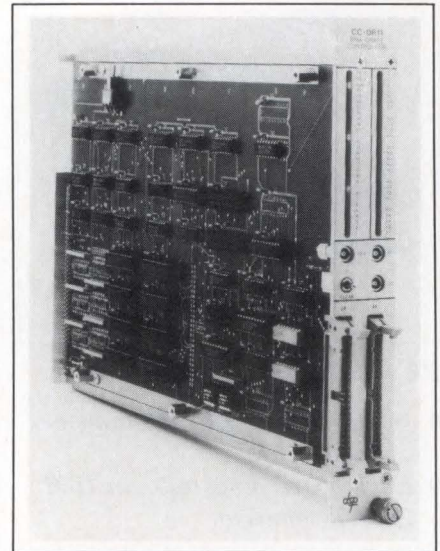

data at rates as high as 1M words/sec. Based on the DEC DR11 standard, the board provides an interface to the DEC Q Bus, Unibus, and Bibus host computers, using DRV-11WA, DR-11W, and DR32B-W DMA interface boards, respectively. A built-in data display simplifies system maintenance and program development. The board can handle both programmed-I/O and DMA mode transfers. Each DR11 interface can address as many as eight crates located as far as 50 ft from the host. The board can also provide a DR11-type interface for other host computers. A CAMVMS software-driver package supports the board when it's using the VMS operating system. \$2500. Delivery, six weeks ARO.

DSP Technology Inc., 48500 Kato Rd, Fremont, CA 94538. Phone (415) 657-7555. TLX 283608.

Circle No 409

Programmable Anti-Alias Filters for Critical A/D Prefiltering

848P8E Series are Elliptic lowpass filters providing extremely sharp roll-off for A/D prefiltering.

Features:

- 8 pole, 6 zero elliptic lowpass filters
- Digitally programmable corner frequency
- Shape factor of 1.77 at 80db
- 8 bit (256:1) tuning ratio
- Internally latched control lines to store frequency selection data
- Ideal for single or multi-channel applications
- Plug in, ready to use, fully finished filter modules
- Five frequency ranges to 51.2kHz

Other Filter Products Available:

- Linear phase • Programmable
- Fixed frequency • Instrumentation
- Custom designs

For more information about how Frequency Devices can meet your most critical filtering requirements, call our applications engineers at **(617) 374-0761.**

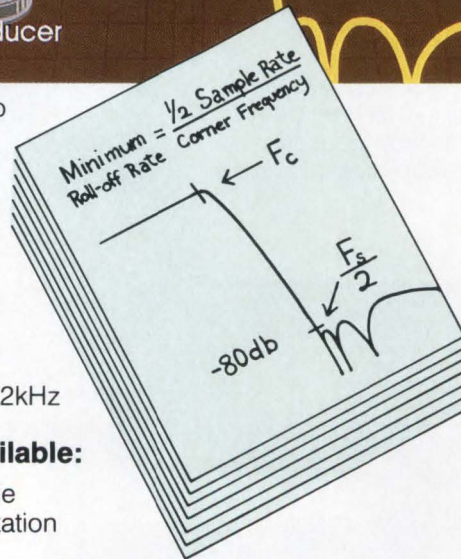
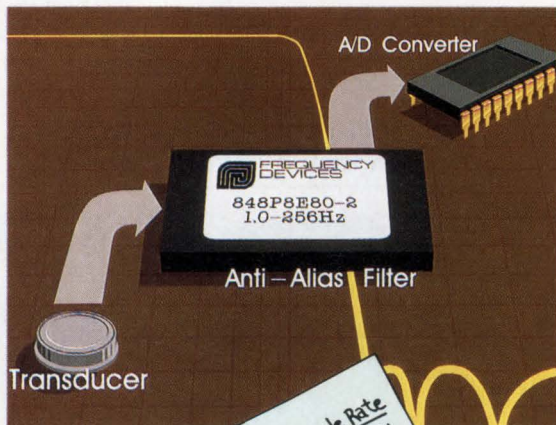

FREQUENCY DEVICES™

25 Locust Street
Haverhill, MA 01830
(617) 374-0761

MULTIFUNCTION CARD

- Provides VME Bus systems with I/O and memory functions
- Housed on a single Eurocard

The VMFB single-Eurocard VME Bus board provides you with various system and I/O functions. The board includes a 68562 IC to provide two serial I/O ports and a 16-bit timer counter; a 68230 IC that provides 16 parallel I/O lines and a

The FPS Tube. BURLE INDUSTRIES.

TWO NEW NAMES FOR HIGH PERFORMANCE.

Compact and lightweight, the BURLE FPS vidicon gives you a low power, high performance camera tube for your most demanding applications. Now you can specify the 1-inch ruggedized, electrostatic deflected FPS tube in silicon or sulfide. These vidicons and other tubes are now supplied by BURLE, formerly the RCA New Products Division. BURLE is today's foremost name in silicon target processing, with a 45-year tradition of technological quality and leadership. Responsive, innovative, and service-oriented, BURLE stands ready to help with your project requirements. Just phone 1-800-722-TUBE. Or, write BURLE Tube Products, 1000 New Holland Avenue, Lancaster, PA 17601-5688.

CIRCLE NO 154

BURLE

TUBE PRODUCTS

formerly

RCA

**Tube
Operations**

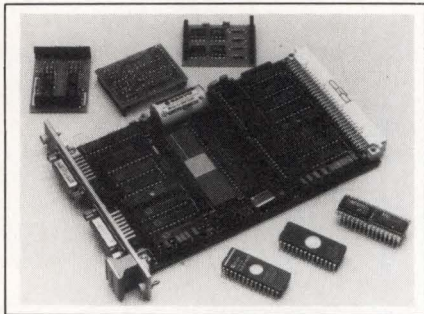

24-bit timer; and an ICM7170 battery-backed, real-time clock/calendar. The board also has space for 64k or 256k bytes of battery-backed static RAM or ROM, and it includes system wake-up and sleep functions, and a hardware watchdog timer. Its VME Bus slave interface includes five programmable VME Bus interrupt levels, short and standard address-mode access to the board's I/O facilities, and standard address-mode access to its memory. DM 890 (OEM qty).

Pep Modular Computers GmbH,
Am Klosterwald 4, 8950 Kauf-

beuren, West Germany. Phone (08341) 81001. TLX 541233.

Circle No 410

Pep Modular Computers Inc,
Carnegie Office Park, 600 N Bell Ave, Pittsburgh, PA 15106. Phone (412) 279-6661. TLX 6711521.

Circle No 411

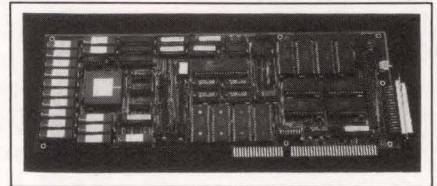

accessible without wait states, allowing the board to achieve a continuous throughput of 8 MIPS. You can also install as much as 8k×24 bits of boot EPROM. In addition to the 16-bit, 2.66M-byte/sec interface to the computer's IBM PC/AT bus, the board has two auxiliary 16-bit input ports and two auxiliary output ports to transfer data to or from the board. All the ports incorporate 1k×16-bit FIFO buffers that allow them to sustain a continuous data transfer rate of 8M bytes/sec or burst-mode I/O transfers at rates as high as 70M bytes/sec. The board also has two RS-232C I/O ports. The optional piggyback boards provide A/D and D/A converters for analog inputs and outputs. The support

ADD-IN PROCESSOR

- Provides IBM PC/AT with a dedicated DSP processor
- Suits real-time DSP and process control applications

The DSPB 2100 add-in board for IBM PC/AT and compatible computers provides the processing power of an Analog Devices' ADSP-2100 digital signal processor. It has a 16k×24-bit RAM for application programs, a 16k×24-bit data RAM in the program-memory space, and a 16k×16-bit data RAM in the data-memory space. All the RAMs are



ARIES[®]
ELECTRONICS, INC.

P.O. Box 130
Frenchtown, NJ 08825
Telephone (201) 996-6841
Telex 6974615
FAX 201-996-3891

Headers, Sockets, Jumpers, DIP Switches, .025 Sq. Stix, etc.

SINGLE ROW COLLET PIN SOCKETS

For mounting odd centered components, jumpers, etc.

PIN-LINE 90° VERTISOCKETS[®] SERIES 0517

- Pins on .100 centers (end-to-end buttable).
- 2 to 25 positions.
- Breakable to any desired number of positions.

Both Pin Line Vertisockets and Pin Line Sockets are breakable to any desired no. of positions.

PIN-LINE SOCKETS SERIES 0513 (Solder tail) or 0503 (Wire Wrap)

- Pins on .100 centers (end-to-end or side-by-side buttable).
- 2 to 25 positions.
- Solder tail or wire wrap pin lengths.
- Breakable to any desired number of positions.

See EEM Vol. C, pgs. 1185-1190

CIRCLE NO 155

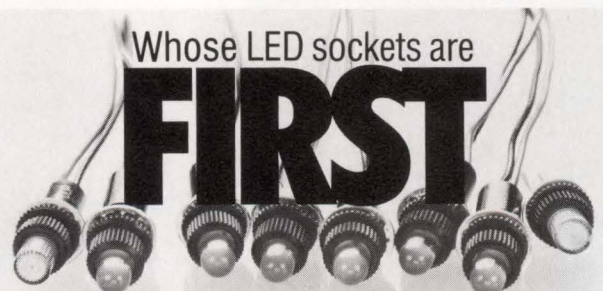

Whose LED sockets are **FIRST** with wire leads & built-in resistors?

Data Display Products is your best answer for heavy-duty LED sockets.

Our industry leading PS200W series allows a selection of operating voltages. Its flexible wire leads are a standard 6-inch length, 16 to 24 AWG gauges, or special orders available. They're a versatile design or replacement product that should rate first on your list.

Make the brilliant choice. Call Data Display, the world leader in high-efficiency LED panel lamps. TOLL-FREE (800) 421-6815. Within California, call (213) 640-0442.

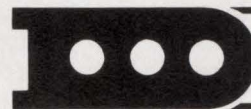

**DATA
DISPLAY
PRODUCTS**

P.O. Box 91072, Los Angeles, CA 90009
(213) 640-0442, TELEX 664-690, FAX 213-640-7639

INTERNATIONAL REPS: Argentina YEL SRL, PH: 541 46 2211, TLX: 390 18605 - Australia Ampec, PH: 6893522, TLX: 790 127136 AMPEC, FAX: 612 6335448 - Belgium/Holland Klaasing Eic, PH: 01620 81600, TLX: 844 54598 KLBDNL, FAX: 0162056500 - Denmark Radio Parts, PH: 01 333311, TLX: 855 19613 RPARTDK - France A Jahnicen, PH: 387 59 09, TLX: 842290714, FAX: 011311-4387-3319 - Israel R.C.M. Computers, PH: 03 476225, TLX: 922 341390 IL, FAX: 011-972-491942 - Italy Microdata, PH: 0187 988182, TLX: 8432 70270 - South Africa Liberty Elec., PH: 52 7637/8/9, TLX: 960 867325A SA - Spain Beltrun, PH: 6942511, TLX: 831 23911 PCOE - United Kingdom Mari Intl, PH: 0229 52430, TLX: 851 65100 MARLG, FAX: 0229 55155 - West Germany/Austria Kuhn GmbH, PH: 06235 5662, TLX: 841 464766 KUJHND, FAX: 0623581955

CIRCLE NO 156

Memories that last.

Our data storage products seem to last forever.

They average 30,000 hours mean-time between failures. For years of trouble-free performance.

A record few others can match.

You Can Expect the Best.

We've been designing disk drives for over 20 years. And no one does more to guarantee quality.

For example, we spend millions in R&D, and manufacture our own components, with quality controls at every stage. And we're leading the industry with interface standards.

That's why you can count on Fujitsu America for the quality and reliability you demand.

So choose from our complete line of storage products. You'll find 1/2" cartridge tape drives. Streaming and start/stop tape drives. 3 1/2" and 5 1/4" flexible drives. Write-once optical disk drives. 3 1/2" to our famous "Eagle" 10 1/2" Winchester. And parallel transfer disk drives.

No Other Company Does More.

We service here. Deliver from here. And our manufacturing complex in Oregon has been operating for a full year, matching the rigorous



quality standards of Japan's disk drive operations.

So make a commitment to quality. Buy the most reliable storage products available. Call today. (800) 626-4686. Or write Fujitsu America, Computer Products Group, 3055 Orchard Drive, San Jose, CA. 95134-2017.

You'll find lasting memories.

A COMPANY WITH CHARACTER AND DRIVE



FUJITSU AMERICA
Computer Products Group

material includes software for program development and simulation, and for communication between the DSPB 2100 and the IBM PC/AT. DM 9950.

CMS GmbH, Einsteinstrasse 61-63, 7505 Ettlingen, West Germany. Phone (07243) 31001.

Circle No 412

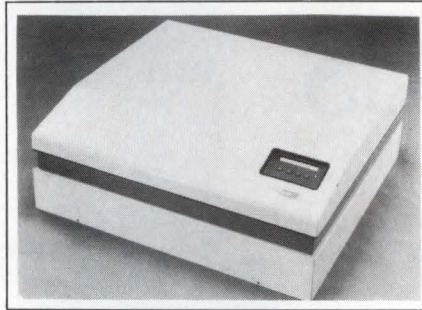

PHOTOPLOTTER

- Accuracy of 0.025 mm for 300×400-mm plot area
- Suitable for desktop use

Suitable for use with PC-based pc-board CAD systems, the P15 horizontal flatbed photoplotter is a desktop plotter with a plotting surface of 300×400 mm. Its positional accuracy and repeatability on the plotting surface is ±0.025 mm. The plotter has a simple optical head that provides 32 fixed symbols, each driven by a separate LED light source. The head can expose a maximum of 500 pads/minute and draw at 25 mm/sec. Interfaced to a host computer via a 300- to 9.6k-baud RS-232C interface, the plotter accepts RS-274 format (Gerber) graphics codes. You can operate the plotter in normal lighting conditions except when you insert or remove the photographic film. The P15 measures 730×675×265 mm and weighs approximately 70 kg. It operates from 110 to 220V, 50 to 60 Hz, single-phase ac line supplies. Sw Fr 35,000.

EIE Electronic Industrial Equipment SA, 15 rue Eugene-Marziano, 1211 Geneva 24, Switzerland. Phone (022) 423260. TLX 429484.

Circle No 414

I/O CONTROLLER

- Uses a 68020 μ P to control 16 serial ports
- Device drivers support Unix and OS-9 operating systems

The PME SIO-4 is an intelligent serial communications controller for

More quality switching components from P&B

Circuit Breakers

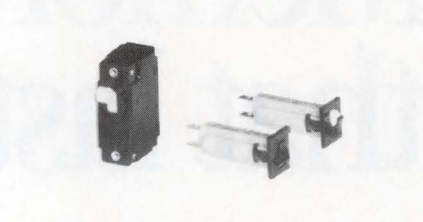

P&B circuit breakers provide the quality you need at a price you can afford. Both thermal and magnetic types are available, and many are UL recognized as supplementary protectors and CSA certified as appliance component protectors.

CIRCLE NO 158

General Purpose Relays

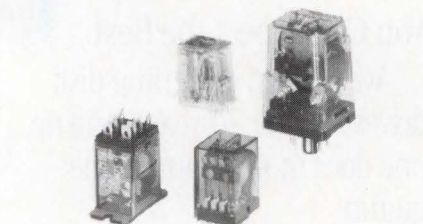

One of the broadest lines of general purpose relays in the industry is offered by P&B. Open and enclosed styles are available with various contact materials, contact arrangements, termination styles and coil voltages.

CIRCLE NO 159

Time Delay Relays



P&B time delay relays combine precision, solid state timing circuits with our proven electromechanical relays. A wide selection of timing functions, timing ranges, degrees of precision and package styles permits you to select a unit with just the features you need.

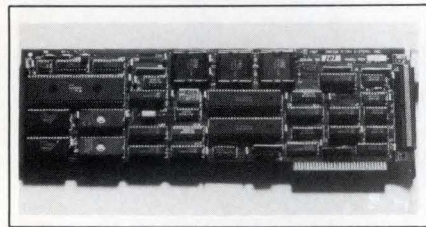

MOTION CONTROLLER

- Can control as many as 6 axes for IBM PC, PC/XT, or PC/AT
- Controls motor drives that accept digital commands

Occupying a single slot in an IBM PC, PC/XT, PC/AT, or a compatible computer, the PCX intelligent motion controller controls stepping, linear, or servo motors that accept digital step and direction commands. It delivers pulse rates as high as 524,000 steps/sec and has a position range of 134M pulses for each axis that is being controlled; therefore, it can control high-resolution motor drives having as many as 50,000 steps/revolution. Different configurations control 2, 4, or 6 axes independently or synchronized for coordinated moves. The board has independent inputs for limit-switch commands and home-sensor signals for each axis. The data and commands are put into ASCII command strings. Each axis has a separate queue that lets the host download a command sequence and proceed with other tasks while the board manages the motion process. 2-axes version, \$995.

Oregon Micro Systems Inc., 14273 NW Science Park Dr, Portland, OR 97229. Phone (503) 644-4999.

Circle No 413

Make your move to P&B for high quality, board mount relays.

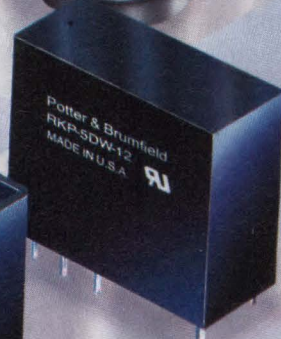
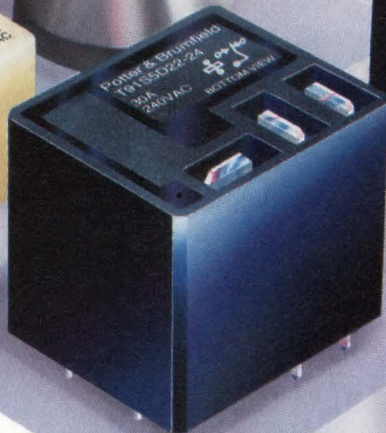

Cost Effective 1mA – 30A Switching

For applications ranging from consumer goods to industrial controls, P&B relays have the features you need for 1 milliamp through 30 amp switching on your printed circuit board. These cost effective relays meet requirements established by international regulatory agencies. Many models are available from stock, and they're all built to the same exacting specifications that have made P&B relays the standard of the industry.

10A, SPDT Switching

T70 relays are low-cost, SPDT units offering silver or silver-cadmium oxide contacts for loads from 1 milliamp through 10 amps. Available with an immersion cleanable, sealed case.

4,000V Isolation

RK series relays feature 8 mm coil-to-contact spacing for 4,000 volt isolation. SPDT models switch loads to 20 amps, and DPDT models switch up to 5 amps. Both sealed and unsealed versions are offered.

30A Workhorse

T90 relays have SPDT contacts of silver-cadmium oxide for 30 amp loads or silver for loads up to 15 amps. Available as an open relay or sealed for immersion cleaning. A snap-on dust cover is offered for open models.

Quick Connects, Too

T91 relays feature the same ratings as T90 relays and provide both quick connects and printed circuit terminals for load connections. Sealed and dust cover versions are available. Optional case provides flanges for panel mounting and quick connects for all connections.

Find Out More

Contact us today for details on P&B printed circuit board relays. Call toll-free 1-800-255-2550 for the name of your nearest P&B distributor or sales representative. Potter & Brumfield, A Siemens Company, 200 South Richland Creek Drive, Princeton, Indiana 47671-0001.

Regional Sales:

Braintree, MA, (617) 848-6550; Mission Viejo, CA, (714) 582-1231; Princeton, IN, (812) 386-2130; Bristol, England, (0454) 616263.

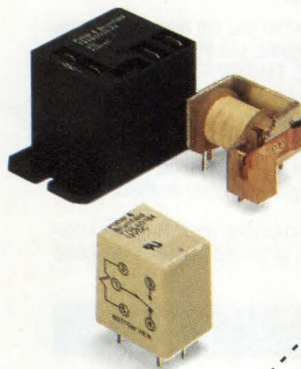

Potter & Brumfield A Siemens Company

Please send more information about P&B printed circuit board relays.

Name _____ Title _____
 Firm _____
 Address _____
 City _____ State _____ Zip _____
 Phone _____

Potter & Brumfield Inc., 200 S. Richland Creek Dr.,
 Princeton, IN 47671-0001

CIRCLE NO 160

EDN041488

the VME Bus. A 16-MHz onboard 68020 μ P offloads I/O processing overhead from the main CPU. The board contains 1M-byte min of RAM, which is dual ported to the 68020 and the VME Bus. The unit controls 16 RS-232C asynchronous channels at baud rates as high as 38.4k baud. You can configure each port for connection to either a ter-

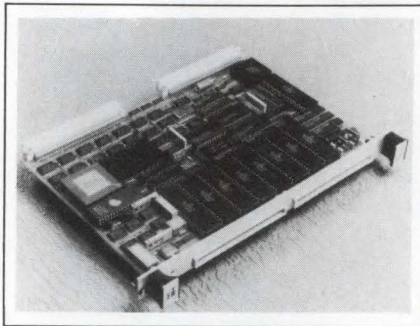

minal or modem. Two additional channels handle synchronous or asynchronous transfers. The unit's self-test and boot facilities reside in 128k bytes of EPROM. The Lines firmware supplied with the board handles character buffering and interrupt processing for the 16 asynchronous channels. It also manages the queues, input block assembly, and flow control. Device drivers are available for the Unix and OS-9 operating systems. \$2695.

Plessey Microsystems, 1 Blue Hill Plaza, Pearl River, NY 10965. Phone (800) 368-2738; in NY, (914) 735-4661.

Circle No 415

Nicolet Digital Oscilloscope Users:

CUT THE CORD

The only thing better than a Nicolet Digital Oscilloscope hooked to an IBM PC/XT/AT or compatible is a Nicolet and PC that aren't connected at all.

Cut the cord with VU-POINT software. Use the scope wherever it is needed without bringing along your PC. Store your data on the 2090 or 4094 scope's disk drive.

Later, when you are ready to examine your signals, put the Nicolet disk into your PC. VU-POINT will read the disks, graph the data, manipulate it (filters, FFT, etc.) and generate printer/plotter hardcopy. VU-POINT has a rich assortment of processing tools for scientific and engineering data analysis.

Ready to cut the cord? For more information, or to order, call 619-453-0060.



VU-POINT

S-CUBED  P.O. Box 1620
La Jolla, CA 92038

CIRCLE NO 161



VIDEO SYSTEM

- Sends color video pictures over telephone lines
- IBM PC-family computer board does video compression

The PC Image Phone, a system color still-frame video phone, stores and retrieves color video pictures and transmits them over telephone lines. You can use the device with an IBM PC, PC/XT, PC/AT, or compatible computers. A compression algorithm lets you transmit color pictures in 5 to 15 sec, when you use a 9600-baud mode. The system includes a 40M-byte hard disk that can store 2000 color stills with TV resolution. The system also includes a PC/AT-compatible computer with a keyboard, a dual-purpose RGB/NTSC monitor, a video-compression and frame-capture board, a color camera, custom operating software,



SILVAR-LISCO Performance Redefined.

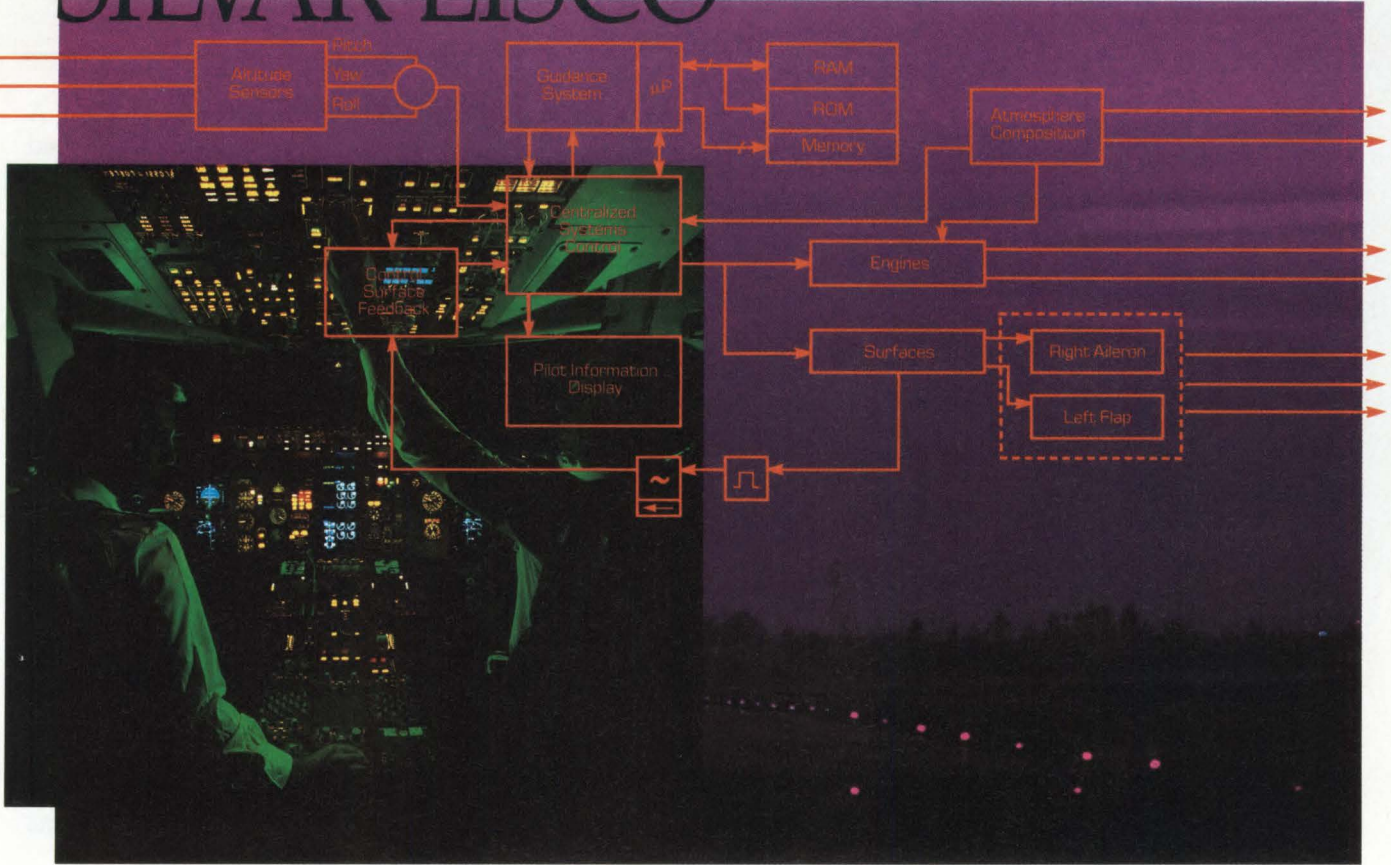

For complex designs, HELIX™ is the "what if" simulator!

When designing large systems, printed circuit boards or VLSI/VHSIC chips, simulation becomes an invaluable aid. Logic, switch level and circuit simulators are excellent tools for validating design implementations. Silvar-Lisco's Helix Behavioral Simulator takes you one giant step further. In addition to design validation, system architects now can optimize the design itself through analysis of various implementation alternatives.

With Helix you can define and test your system concepts first. If the concept works, you move down to the register level. Then the gate level. Multi-level throughout. If it doesn't work, you can rethink the concept and probe Helix with additional design alternatives. In the end, you will get the best design. The first time.

Helix is a vital component of Silvar-Lisco's Architectural Design Series. Incorporating

design capture, simulation and design libraries, the Architectural Design Series gives you the competitive edge.

Be a design winner! Contact Silvar-Lisco today!

SILVAR-LISCO OFFICES

Corporate Headquarters
1080 Marsh Rd.
Menlo Park, CA 94025
TEL: (415) 324-0700
WATS: 1 (800) 624-9978
TWX: 910-373-2056
FAX: (415) 327-0142.

European Headquarters
Leuven, Belgium
TEL: 32-16-200016
TWX: 221218
FAX: 32-16-236076

Far East
Nihon Silvar-Lisco
Tokyo, Japan
TEL: 81-3-449-5831
FAX: 81-3-449-4040



Architectural Design Series

SILVAR-LISCO

CAE Software products for electronic design.

Shielded rooms with a roomful of benefits.

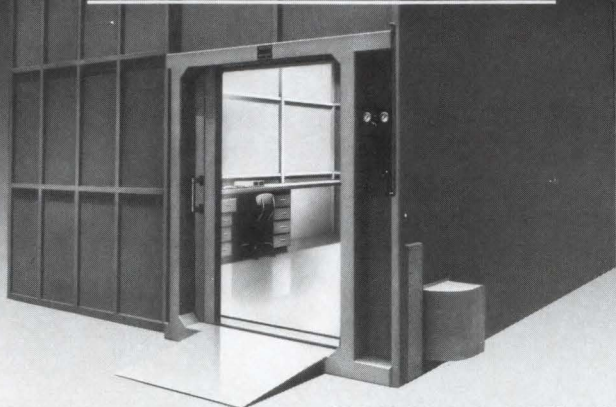

LECTROSHIELD® Clamp-Together Rooms — Shielding Effectiveness to 100 dB+.

- 1.0 KHz to 10 GHz attenuation for MIL-STD-285, NSA 65-6, FCC and VDE testing, MIL-STD-461/2/3, etc.

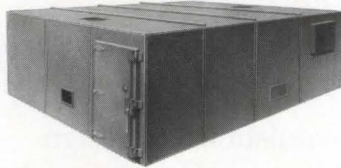

- Prefabricated, modular.
- 48 standard room sizes... 8' x 8' to 24' x 48' (interior), standard interior heights to 8', 10' and 12', plus custom sizes.
- Easily assembled and dismantled.
- High reliability electrical and structural.
- Meets stringent building and safety codes, including Seismic Code Zone IV.

All-Welded Rooms — Shielding Effective- ness to 120 dB- 140 dB+.

- Meets TEMPEST and other secure requirements.
- Ideal for EMP hardening.
- Free standing; total structural and seam integrity.
- Patented sliding doors exceed MIL-STD-285 and NSA 65-5.
- MIG welding throughout.
- TEMPEST shielded security vaults.
- Standard and customized sizes.
- Maximum fire protection.
- Complete design and turn-key facilities.

Plus... shielded anechoic chambers, chambers for Nuclear Magnetic Resonance (NMR) imaging systems, and a complete line of RFI/EMI filters and filter panels.

LMI has the shielding solution for you. Write or call the LMI Application Engineering Department.



Nationwide representatives

LECTROMAGNETICS, INC., 6056 West Jefferson Blvd., Los Angeles, CA 90016
(213) 870-9383, Toll Free (800) 325-9814-U.S.A. • (800) 325-9815-CA

CIRCLE NO 163

DID YOU KNOW?

EDN serves
electronic engineers and
engineering managers in more than
100 countries worldwide.

EDN

COMPUTERS & PERIPHERALS

a 9600-baud modem, and a mouse. A video printer, a write once/read many storage unit, a speaker phone, and a copy stand are optional. Complete system, \$12,995; video compression board, \$1995.

StarSignal Inc., 1210 S Bascom Ave, Suite 221, San Jose, CA 95128. Phone (408) 294-9604.

Circle No 416

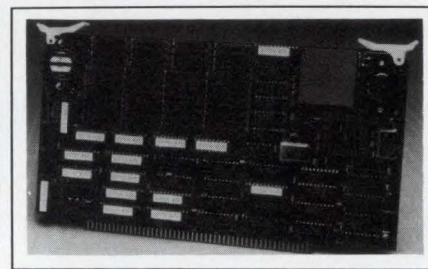

SATELLITE BOARD

- For the S-100 Bus uses the 80386 μP
- You can install seven satellite boards in a system

The MI386S, a 80386-based satellite board for the S-100 Bus, runs at 16 MHz. You can install as many as seven boards in a system, permitting multiple use. Each board communicates with the host only. The satellite board has 1M byte of 32-bit-wide dynamic RAM. The RAM is dual ported to the 80386 and host processor and has a 100-nsec access time. Compatible host CPUs include the vendor's M1286 and Compupro's 8085/8088 and 80286. The software is compatible with Concurrent DOS, including CDOS 3.2, 4.1, and 5.0. The software has a default feature that is set to the host or to the satellite board running the fewest tasks. You can set a program file to run on a selected processor by modifying a file header. \$2667.

Macrotech International Corp., 21018 Osborne St, Building 5, Canoga Park, CA 91304. Phone (818) 700-1501. TWX 910-997-0653.

Circle No 417

On April 5th, Intel made a major announcement about advanced 32-bit embedded control technology.

On April 12th, we'll explain it.

Intel unveiled three advanced embedded control technologies, two 32-bit embedded processors, and a radically new memory product line on April 5th.

On April 12th, seminars begin worldwide to show how to design significantly more powerful 32-bit systems that provide unparalleled price performance. The fully supported 80376 and 80960 families of embedded processors, and the breakthrough flash memory technology will be discussed in detail.

These free seminars will include lectures, comprehensive demonstrations, printed materials and a good lunch.

You're invited.

Call (800) 548-4725 for details, or to secure a spot.

And call now, as seating is limited, and we have a lot of explaining to do.



Alabama	Huntsville	4/29/88	Maryland	Baltimore	4/26/88	Pennsylvania	Philadelphia	4/12/88
Arizona	Tempe	4/18/88	Massachusetts	Boston	4/15/88		Pittsburgh	5/18/88
California	Anaheim	4/22/88	Michigan	Detroit	4/25/88	Texas	Austin	4/21/88
	Los Angeles	4/20/88	Minnesota	Minneapolis	4/14/88		Dallas	4/19/88
	San Diego	4/21/88	Missouri	St. Louis	5/19/88		Fort Worth	4/18/88
	Santa Clara	5/4/88	New Jersey	Kenilworth	5/13/88		Houston	4/20/88
	Van Nuys	4/19/88	New York	Binghamton	5/11/88	Virginia	Charlottesville	4/28/88
Colorado	Denver	5/3/88		Long Island	4/13/88		Tysons Corner	4/27/88
Connecticut	Stratford	4/14/88		Rochester	5/10/88	Washington	Bellevue	5/5/88
Florida	Ft. Lauderdale	4/28/88		Tarrytown	5/12/88	Wisconsin	Milwaukee	4/13/88
	Orlando	4/26/88	North Carolina	Charlotte	5/4/88	Canada	Montreal	5/24/88
Georgia	Atlanta	4/25/88		Raleigh	5/3/88		Ottawa, Ontario	5/25/88
Illinois	Chicago	4/12/88	Ohio	Cleveland	5/19/88		Toronto	5/20/88
Indiana	Indianapolis	5/17/88		Dayton	5/17/88		Vancouver, BC	5/6/88
Kansas	Kansas City	5/18/88	Oregon	Portland	5/6/88			

NEW PRODUCTS

CAE & SOFTWARE DEVELOPMENT TOOLS

CALCULATOR SOFTWARE

- Pop-up calculator simulates HP-16C programmers' tool
- Lets you print or save simulated HP-16C program tapes

XACT-16C is a RAM-resident, pop-up calculator that you can call from within other programs and that simulates the HP-16C handheld programmable calculator. It runs on the IBM PC, PS/2, and compatibles. The calculator features decimal, octal, hex, binary, and floating-point modes with any word size from 2 to 64 bits. It provides advanced algebraic, logical, base-conversion, and bit-manipulation functions not found in other calculators. The calculator is fully programmable and generates a simulated paper tape that you can "stamp" with messages, print, or save to a

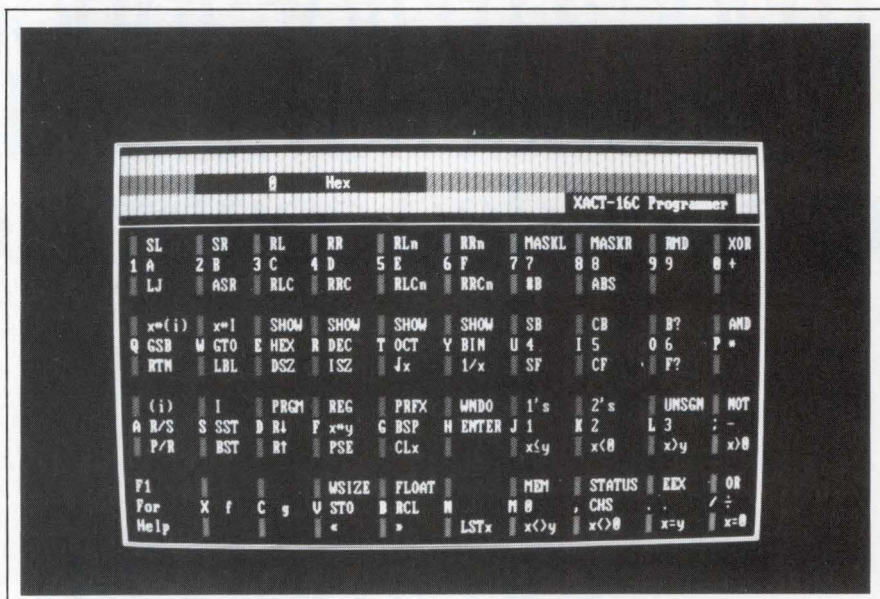

disk file. The calculator also provides on-line help in the form of menus and a table of ASCII codes. \$49.95.

CalcTech Inc, 13629 Bellevue-Redmond Rd, Suite 202, Bellevue, WA 98005. Phone (206) 643-1682.

Circle No 420

GRAPHICS TOOL KIT

- Helps you program graphics for PCs that use the TI34010 chip
- Allows calls from Pascal and C programs

The RGDI Developer's Kit consists of the vendor's advanced graphics controller, which is based on the 32-bit TI34010 graphics coprocessor chip; a programmer's technical reference manual; a TI34010 user's guide; and development software and utilities. You can program the TI34010 chip in one of three ways: through the use of high-level drawing primitives that allow you to call them from applications written in C or Pascal, by building new primitives written in the TI34010 assembly language, and by writing custom programs entirely in the TI34010 assembly language. For this purpose, the tool kit includes an assembler, a linker, a simulator, a debugger, and utility programs. The graphics programs that you de-

velop will run on an IBM PC or compatible equipped with the vendor's Rendition I graphics controller board. If you need EGA compatibility, the vendor can supply an optional Rendition EGA (REGA) plug-in module. Developer's Kit, \$695; REGA, \$169.

Renaissance GRX Inc, 2265 116th Ave NE, Bellevue, WA 98004. Phone (206) 454-8086.

Circle No 421

C COMPILER FOR MAC

- Provides source-level compatibility with MPW
- Works with 68020 and 68881 math coprocessor

Release 3.6 of Aztec C makes the compiler fully compatible with the Macintosh II and with all other Apple machines and interfaces, including Apple's Macintosh Programmer's Workshop (MPW). The

compiler allows you to make full use of the 68020 CPU and 68881 math coprocessor; the package includes a library of floating-point math routines for the 68881, as well as a library of IEEE floating-point routines. Enhancements bring the compiler into closer conformity with the ANSI draft standard for C by allowing you to use new extensions such as bit fields, structure passing, and *enum*, which lets you define new data types. Version 3.6 allows you to create code segments of virtually unlimited size. The package works with third-part debuggers such as MACsbug, MACnosy, and TMON, and it includes a profiler that identifies performance bottlenecks. You can obtain the package in three upgradeable configurations: C' Prime, \$75; Professional, \$199; and Developer, \$299.

Manx Software Systems Inc, 1 Industrial Way, Eatontown, NJ 07724. Phone (201) 542-2121.

Circle No 422

MICRO-LOGIC II.™

The CAE tool with a 10,000-gate digital simulator for your PC.

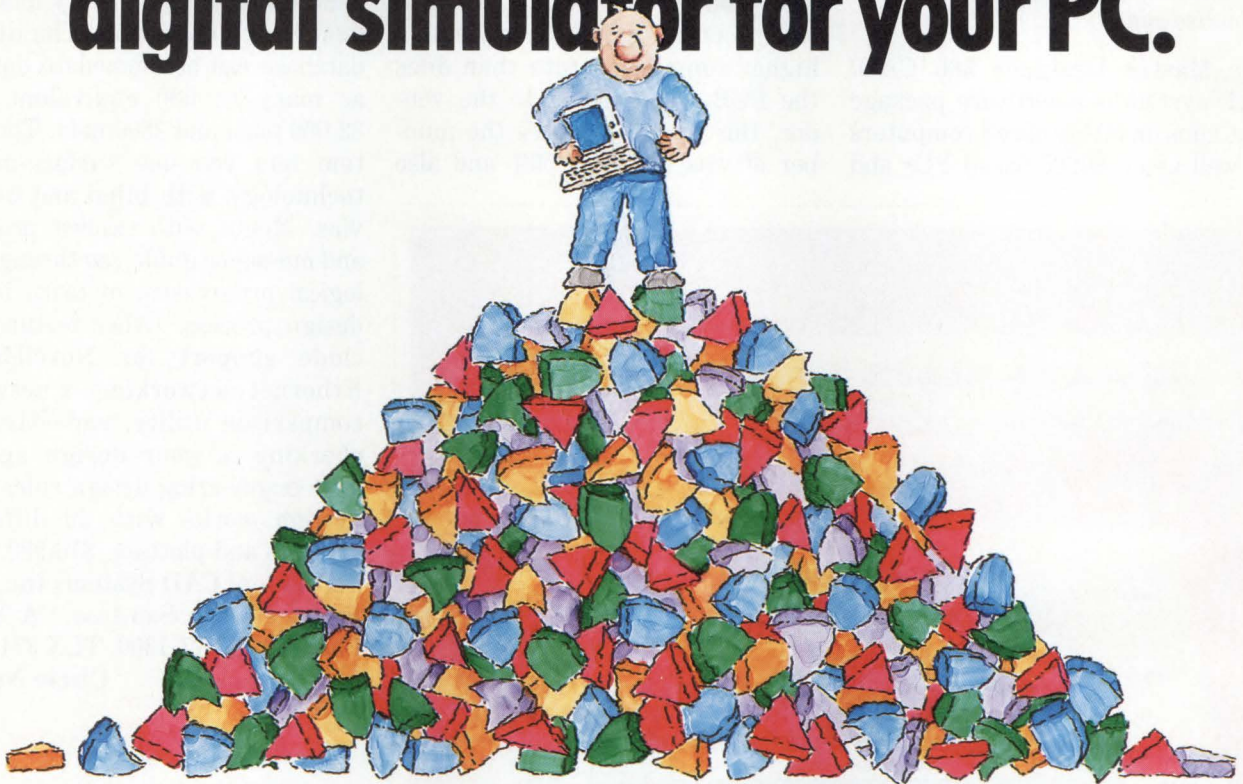

Spectrum Software's MICRO-LOGIC II® puts you on top of the most complex logic design problems. With a powerful total capacity of 10,000 gates, MICRO-LOGIC II helps engineers tackle tough design and simulation problems right at their PCs.

MICRO-LOGIC II, which is based on our original MICRO-LOGIC software, is a field-proven, second-generation program. It has a high-speed event-driven simulator which is significantly faster than the earlier version.

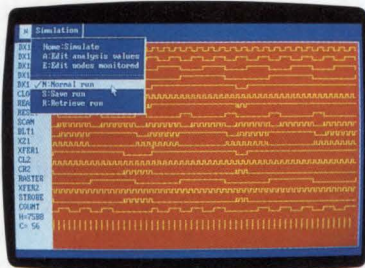

Timing Simulator

The program provides you with a top-notch interactive drawing and analysis environment. You can create logic diagrams of up to 64 pages with ease. The software features a sophisticated schematic editor with pan and zoom capabilities.

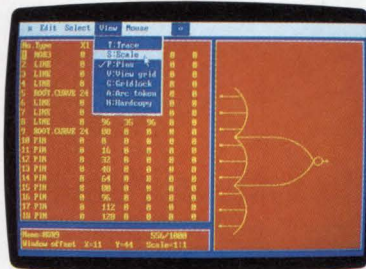

Shape Editor

A 200-type library of standard parts is at your fingertips. And for a new high in flexibility, a built-in shape editor lets you create unique or custom shapes.

MICRO-LOGIC II is available for the IBM® PC. It is CGA, EGA, and Hercules® compatible and costs only \$895 complete. An evaluation version is available for \$100. Call or write today for our free brochure and demo disk. We'd like to put you in touch with a top digital solution.

- Total capacity of 10,000 gates
- Integrated schematic editor
- Fast assembly language routines
- Standard parts library of 200 types
- Event-driven timing simulator

- Built-in shape editor
- Multiple delay models
- Printer and plotter hard copy

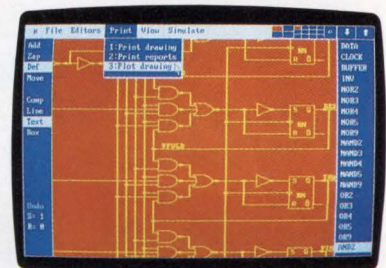

Schematic Editor

spectrum

1021 S. Wolfe Road, Dept. E
Sunnyvale, CA 94087
(408) 738-4387

MICRO-LOGIC II is a registered trademark of Spectrum Software.
Hercules is a registered trademark of Hercules Computer Technology
IBM is a registered trademark of International Business Machines, Inc.

CAE SYSTEM

- Provides multilayer routing and ECO processing option
- Supports SMT with blind and buried vias

The Master Designer 386 CAD/CAE system is a software package that runs on 80386-based computers as well as on 80286-based PCs and

compatible computers. The system handles board designs two to three times as large as does its predecessor, the PCB-3, and it runs faster as well. The system includes a multilayer routing feature that yields a higher completion rate than does the PCB-3. According to the vendor, this feature reduces the number of vias by 30 to 50% and also

reduces the number of unconnected subnets. An ECO (engineering change order) processing feature provides both forward annotation of logic changes and history-independent back annotation. The design database can accommodate data on as many as 500 equivalent ICs, 32,000 pins, and 2500 nets. The system lets you use surface-mount technology with blind and buried vias. Menus with explicit prompts and messages guide you through the logical progression of tasks in the design process. Other features include support for Novell/3Com Ethernet networking, a network-comparison utility, and extensive checking of your design against your engineering design rules. The system works with 60 different printers and plotters. \$16,980.

Personal CAD Systems Inc., 1290 Parkmoor Ave, San Jose, CA 95126. Phone (408) 971-1300. TLX 3717199.

Circle No 423

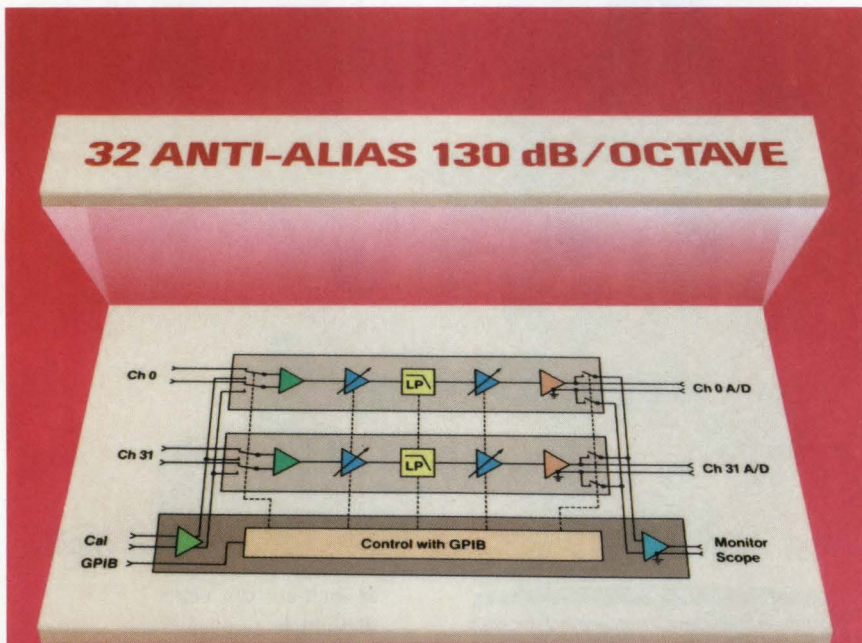

**32 anti-alias
filter channels,
130 dB/octave.
1 Hz to 204.7 kHz.
1° phase match.
Pre and post gain.
Differential input.
Calibration input.
Output monitor.
All in 7"
mainframe.**

Only With System Friendly

Just one of hundreds of programmable hardware building block configurations possible with our operating system. Just one of hundreds of exclusive possibilities that make Precision 6000 truly System Friendly now and easy to update in the future. Call (607) 277-3550 for brochure. Or write.



PRECISION FILTERS, INC.

240 Cherry Street, Ithaca, New York 14850

LINKER FOR 80386

- Links object modules intended for ROM-resident software
- Accepts object files from many 16- and 32-bit compilers

The LinkLoc software package combined linker and locator utility accepts relocatable object modules from assemblers or compilers and produces executable image files that you can download to a target system or to a PROM programmer. Switches allow you to control the attributes and sizes of segments, as well as the starting locations of programs. The utility automatically constructs LDTs (local descriptor tables) and GDTs (global descriptor tables), which are required by programs that run in protected mode on an 80286 or 80386. The utility can also produce a symbol table for use by a symbolic debugger or by an in-circuit emulator. The linker accepts object files in OMF-86 format, which is employed by the majority

CAE & SOFTWARE DEVELOPMENT TOOLS

of 8086 and 80286 compilers; it will also accept files in the vendor's Easy OMF-386 format. Command-line switches let you specify the format of the output file; you can select Intel and Motorola hex formats, Intel Absolute 8086 and Bootloadable OMF-286/386 formats, and MS-DOS .EXE format. IBM PC version, \$395; Sun and Apollo versions, from \$750; VAX/VMS and VAX/Ultrix versions, from \$1495.

Phar Lap Software Inc, 60 Aberdeen Ave, Cambridge, MA 02138. Phone (617) 661-1510.

Circle No 424

OPTICAL DISK SERVER

- Lets you connect a PC to any of 11 different optical drives
- Allows the optical disk to operate like a hard-disk drive

OS-DOS is an operating-system extension that provides an intelligent optical-drive file system and an appropriate interface to MS-DOS or PC-DOS. OS-DOS 3.0 is for single-user systems; OS-DOS 4.0 allows the optical drive to act as a file-server on a network. Both versions provide 20-character file names, 65,000 subdirectories, and an unlimited number of files; an individual file can be as large as 2G bytes. OS-DOS is transparent to application programs and allows you to use all MS-DOS system commands; you can truncate, delete, update, or add files on a write-once optical disk. Version 4.0 allows Novell network users to address optical drives transparently as part of the network. The optical drives can be 5¼-, 8-, or 12-in. drives from any of 11 manufacturers. OS-DOS 3.0, 5¼- and 8-in. drives, \$937; 12-in. drives, \$1875. OS-DOS 4.0 network software, 5¼- and 8-in. drives, \$1250; 12-in. drives, \$2500.

Optical Storage Solutions Inc, 1130 D Burnett Ave, Concord, CA 94520. Phone (415) 825-3441.

Circle No 425

SIMULATOR

- Lets you simulate nonlinear systems such as servos
- Uses HALO graphics system for portability

The CCAP-SIM "authoring" program accepts input consisting of a model of a feedback control system that you've previously defined with

the aid of the vendor's CCAP analysis program. The authoring program then writes source code that, when compiled and linked with other precompiled modules, results in a program that simulates a specific control system. Both the authoring program and the resulting simulation program are interactive and allow you to change parameter

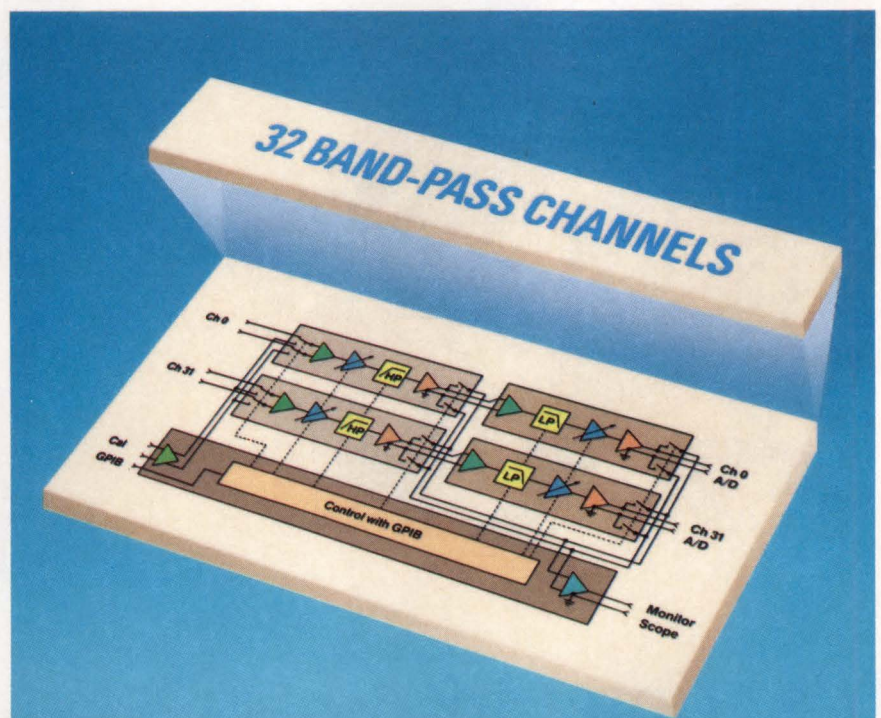

**32 band-pass
filter channels.
80 dB/octave.
1 Hz to 25.5 kHz.
1° phase match.
Pre and post gain.
Differential input.
Calibration input.
Signal monitor.
All in 7"
mainframe.**

Only With System Friendly

Just one of hundreds of programmable hardware building block configurations possible with our operating system. Just one of hundreds of exclusive possibilities that make Precision 6000 truly System Friendly now and easy to update in the future. Call (607) 277-3550 for brochure. Or write.



PRECISION FILTERS, INC.

240 Cherry Street, Ithaca, New York 14850

GOODBYE WORKSTATION

HELLO PADS-PCB

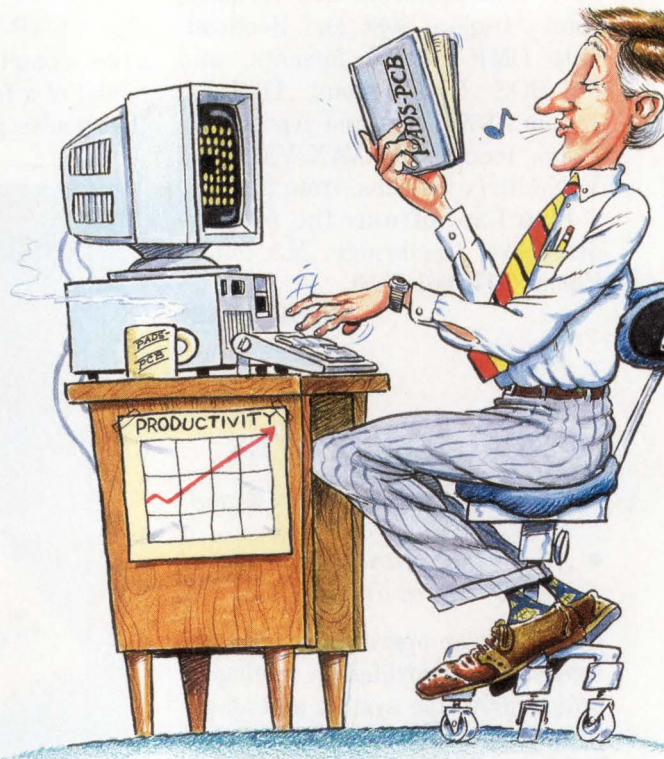

It's time to say goodbye

to expensive engineering workstation based CAD systems. Why should management tie up \$100,000.00 or more in a workstation when the same (and often better) performance is obtained with PADS-PCB, a PC based CAD system?

PADS-PCB is a high performance printed circuit board design software that offers a degree of functionality a designer could expect only from an expensive engineering workstation.

Powerful auto/interactive features are a part of what makes PADS-PCB the best selling CAD system on the market:

- 1 mil database-32"x32" board size-30 layers
- Large circuit capabilities: In excess of 400 equivalent 14 pin IC's
- Automatic and interactive component placement aids
- Automatic and interactive track routing
- Automatic design rule checking
- Superior Surface Mounted Device capability
- One, two, and three track capability between IC Pins
- Superb analog design capability
- Inputs from Futurinet, Orcad, Schema, PADS-CAE and others

- 100% routing with PADS-Super-Router, the only rip-up and reroute router on a personal computer

CAD Software asks you to try its Evaluation Package, priced at only \$50.00, so you can see for yourself how PADS-PCB puts an end to those workstation blues. Call our Sales Hotline today at **(800) 255-7814;** in Massachusetts **(617) 486-9521.**



119 Russell Street
P.O. Box 1142
Littleton, MA 01460

CAD
Software, Inc

CIRCLE NO 101

CAE & SOFTWARE

values dynamically. To run the program, you need an IBM PC/XT, PC/AT, PS/2, or compatible machine equipped with a math coprocessor and at least 512k bytes of RAM, a hard disk, a parallel printer port, a graphics display adapter, and DOS 2.1 or later. \$800.

Lewis Engineering Software,
Box 55-BV, Andover, MA 01810.
Phone (617) 975-5509.

Circle No 426

AI TOOL

- Lets you call routines written in Ada and C
- Lets you watch areas of memory while debugging

VAX OPS5 is a tool for developing expert systems and other AI application software. Version 2.2 allows you to call external routines written in VAX C or VAX Ada from within VAX OPS5 programs. Using the interface features, you can integrate expert systems written in VAX OPS5 with other programs written in VAX Basic and VAX Bliss-32. A watch feature allows you to watch specific areas of memory while debugging, so that you have greater control over the debugging process. Further, Version 2.2 will run on any host in the VAX family of computers, starting with the VAXstation 2000. The license fee depends on the host configuration and number of users, starting at \$1575 for the VAXstation 2000.

Digital Equipment Corp, 146
Main St, Maynard, MA 01754.
Phone (800) 344-4825; in MA, (617)
870-3234.

Circle No 427

FORMAT CONVERTER

- Translates data to and from digital-signal formats
- Lets you acquire binary data from acquisition hardware

The HEM Universal Translator runs on the IBM PC and compati-

DOING PART OF THE JOB IS NOT ENOUGH Integrated CADdy Does It All!

Schematic capture: Dynamic symbol call-up... automatic naming/numbering
... rubberbanded connections
... edge-of-sheet and bus symbols... expandable library.

Component data base: Defines/manages data flow between schematic and PC Board. Automatic features—file naming, multi-sheet management, BOM, netlist, back-annotation, layer management, project archiving.

PCB Layout: Components dynamically positioned with rotate or mirror (for SMD)... auto-ratsnest... pin/gate/component name swapping... component dragging with connections... ground planes with fill/hatching...

user-defined pads, vias, trace width, automatic artwork generator... output to major pen plotters and Gerber... optional Excellon.

CADdy Autorouter: Options—Standard or High-performance.

Full-featured Drafting: Mechanical auto-dimensioning with tolerancing, construction aids, calculators... and more.

Polished **Technical Documentation**

For additional information call:
CADdy CORPORATION, 3 Crossroads of
Commerce, Rolling Meadows, IL 60008
Toll-free: 1-800-CADDY11 (In Illinois:
1-312-394-7755)

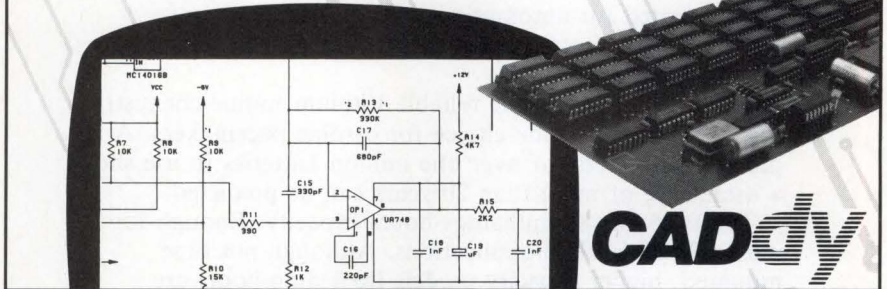

CIRCLE NO 178

THINK LOGIC — — — — SWITCH LOGIC — — — —

MOXIE THERMAL SENSORS . . .

STABLE, RELIABLE, REPEATABLE

This solid state thermal switch is designed for the fast response time needed to protect sensitive electronic components.

Sharp Transition
High Noise Immunity
TCR -200%/°C
Fixed Hysteresis
No Mechanical Contacts
C MOS Compatible
TO-18 Package or Die Chip
Mounting Lug, Lead Wire Optional
Switching Temps: 50,57,60,65,75 & 85°C.
Samples Available Upon Request.

Applications: Power Transistor Protectors; Switching power supplies; Battery chargers; Smoke & fire detectors; Telecom equipment; Dual speed fan control; U.P.S.; Fan failure warning; etc...

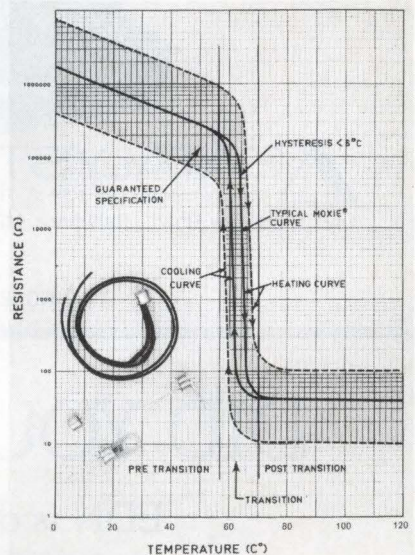

For More Information, Contact:
CANADIAN THERMOSTATS & CONTROL DEVICES LTD.
8415 Mountain Sights Avenue, Montreal, Quebec H4P 2B8
TEL: (514) 739-3274 FAX: (514) 739-2902



CAN THERM

CIRCLE NO 179

THE BATTERY FOR AUTOMATED PRODUCTION IS NOW IN PRODUCTION

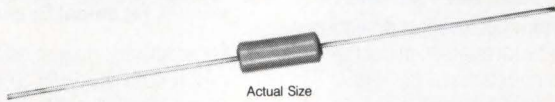

It's called the B-35 mPowerCell™. A CMOS backup battery that you can handle just like any other component. It is tape mounted for automatic insertion. It can be wave soldered. And, it withstands all normal flux cleaning and board drying procedures.

The B-35 has the same reliable Lithium-Iodine chemistry that is the number one choice for cardiac pacemakers. A performance study of over one million batteries in use shows a useful life of more than 20 years can be predicted.

The B-35 has 35 milliamps-hours capacity. Enough for most CMOS backup applications. Although not tape mounted, higher capacity models (to 1 amp-hour) are available with all the other production advantages of the B-35.

For more information, call (301) 296-7000, ext. 304.

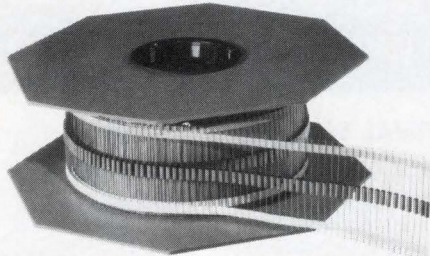

CATALYST RESEARCH
A DIVISION OF MINE SAFETY APPLIANCES COMPANY
1421 Clarkview Road Baltimore, MD 21209-9987 (301) 296-7000 ext 304

CIRCLE NO 180

DID YOU KNOW?

EDN is distributed
at every major
electronics/computer show in the
U.S., France, and Germany.

EDN

CAE & SOFTWARE

bles and translates data to and from digital-signal formats such as ASCII, floating-point, Intel and Motorola hexadecimal, and binary. The format converter lets you use data-analysis packages such as the vendor's Snap-Calc and Snap-FFT even if your data was acquired with instrumentation that employed a format incompatible with your analysis package's format. The translator will create headers used by the vendor's analysis software and will either strip out or pass on headers created by other acquisition packages. If part of a multiple, HEM-package order, \$150; otherwise, \$195.

HEM Data Corp, 17025 Crescent Dr, Southfield, MI 48076. Phone (313) 559-5607.

Circle No 428

CADD FOR MAC

- Lets you use as many as 256 colors
- Lets you group objects together as components

Generic CADD Level 1 has been redesigned to follow the standard Macintosh interface so that it works like other graphics programs for the Macintosh. You can edit multiple drawings simultaneously in different windows, and you can cut and paste objects between different windows in Level 1 or between Level 1 and other programs that use the standard Pict format. You can use as many as 256 colors, layers, and line types; you can move, copy, erase, or rotate objects that you have drawn on the screen. You can group objects together to form components, and you can save these components for repeated use. This package provides Macintosh users with the same drawing capabilities that earlier versions provided to IBM PC users. \$49.95.

Generic Software Inc, 8763 148th Ave NE, Redmond, WA 98052. Phone (206) 885-5307.

Circle No 429

IN THE WORLD OF DC FILM CAPACITORS, MALLORY TECHNOLOGY LEADS THE WAY.

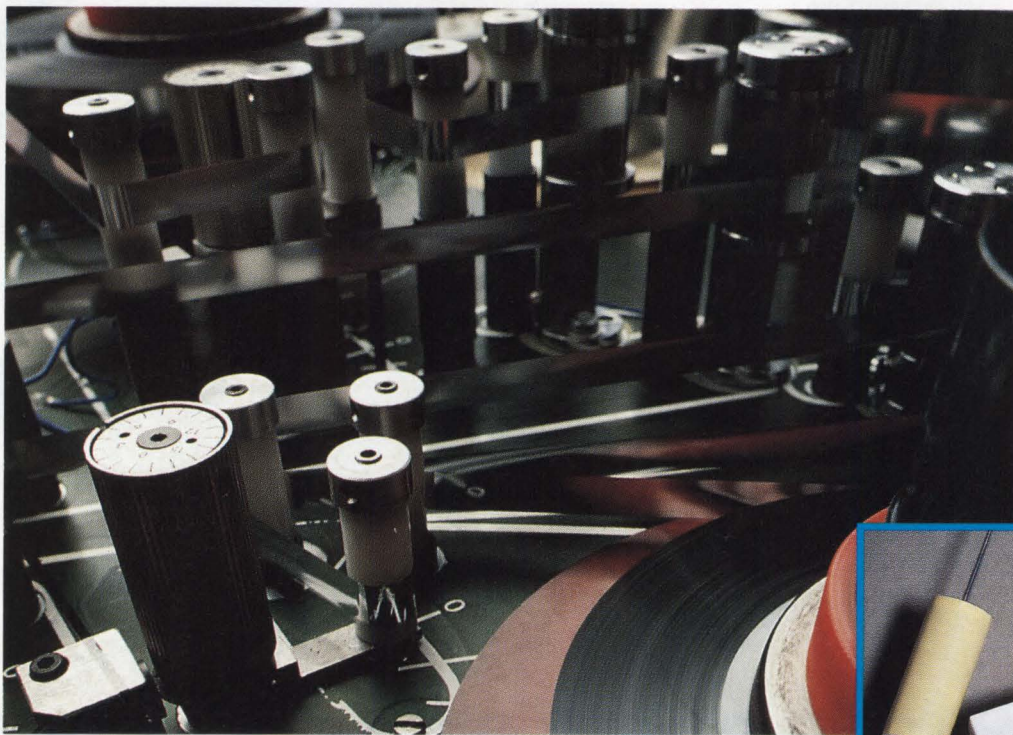

Automated high-speed winding
operation for DC Film capacitors.

Utilizing the world's finest design technology and high-speed automation equipment, Mallory has become the largest domestic producer of DC Film capacitors.

Mallory offers a wide range of dielectric materials including polyester, polypropylene and polystyrene. And with the additional choice of film-foil or metallized electrodes,

Mallory can provide the most cost-effective match for your application requirements.

With Mallory, the world of DC Film technology and service is at your

fingertips.

For more information, contact your nearest distributor or call Mallory today.

Mallory Capacitor.
Stronger Than Ever.

Mallory Capacitor Company
3029 E. Washington Street
Indianapolis, Indiana 46201
Telephone: (317) 636-5353

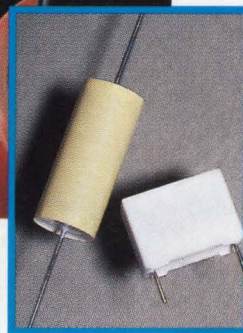

MALLORY

ELECTRICAL/ELECTRONIC GROUP

EMHART

FEATURES

- Ultrahigh Speed: Current Settling to 1LSB in 35ns**
- 12-Bit Integral and Differential Linearity Guaranteed Over Temperature**
- 10.24mA Full-Scale Output Suitable for Video Applications**
- High Stability Buried Zener Reference on Chip**
- 0.3" "Skinny DIP" Packaging**
- Variable Threshold Allows TTL and CMOS Interface**

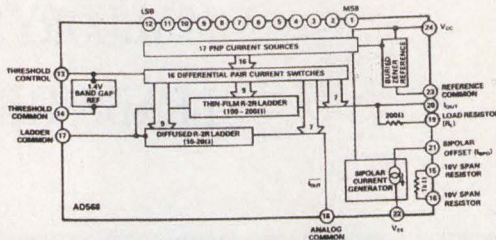

AD568 Functional Block Diagram

PRODUCT DESCRIPTION

The AD568 is an ultrahigh-speed, 12-bit digital-to-analog converter (DAC) settling to 0.025% in 35ns. The monolithic device is fabricated using Analog Devices' Complementary Bipolar (CB) Process. This is a proprietary process featuring high-speed NPN and PNP devices on the same chip without the use of dielectric isolation or multichip hybrid techniques. The high speed of the AD568 is maintained by keeping impedance levels low enough to minimize the effects of parasitic circuit capacitances.

Laser wafer trimming insures full 12-bit linearity. All grades of the AD568 are guaranteed monotonic over their full operating temperature range. The low linearity error allows the AD568 to be used in high-speed applications requiring real 12-bit performance. There is no longer any compromise between speed and accuracy in those applications that require both.

The DAC consists of 16 current sources configured to deliver a 10.24mA full-scale current output or a 1.024V FS unbuffered voltage output. Multiple matched current sources and thin-film ladder techniques are combined to produce bit weighting. Additionally, a 10.24V FS buffered output may be generated using an onboard 1kΩ span resistor with an external op amp. Bipolar ranges are accomplished by pin strapping.

PRODUCT HIGHLIGHTS

1. The ultrafast settling time of the AD568 allows leading edge performance in waveform generation, graphics display and high-speed A/D conversion applications.
2. Full 12-bit accuracy is provided in a monolithic converter.
3. Pin strapping provides a variety of voltage and current output ranges for application versatility. Tight control of the absolute output current reduces trim requirements in externally scaled applications.
4. Matched on-chip resistors can be used for precision scaling in high-speed A/D conversion circuits.
5. The digital inputs are compatible with TTL and +5V CMOS logic families.
6. Skinny DIP (0.3") packaging minimizes board space requirements and eases layout considerations.

THE SPEED RECORD FOR REAL 12-BIT DAC PERFORMANCE IS SET ON THIS PAGE.



If your high-speed DAC applications are often plagued by a loss of accuracy, we'd like to direct you to our AD568.

With a settling time of only 35ns to $\pm 0.025\%$, no other monolithic DAC is faster. And it combines this speed with unmatched $\pm 1/4$ LSB integral nonlinearity, as well as guaranteed monotonicity over the entire operating temperature range, for real 12-bit performance.

This unique combination of speed and accuracy allows you to delve into new application areas like high-speed/high-resolution A/D converters, vector graphic displays, and direct digital frequency synthesizers.

For design versatility, the AD568 offers a variety of user-programmable voltage and current outputs. And all

this comes in a skinny 0.3" CERDIP package, which conserves board space and allows for auto-insertion.

The AD568 delivers an unmatched level of performance with prices starting at only \$35 in 100s. Now you could spend almost twice that for other high-speed monolithics, and still not get the same level of accuracy as the AD568. And while some hybrids might come close in performance to the AD568, they also cost twice as much.

To find out how the AD568 can help set speed records for your designs, call Applications Engineering at (617) 935-5565, Ext. 2628 or 2629.

Or write to Analog Devices, P.O. Box 9106, Norwood, MA 02062-9106.



Analog Devices, Inc., One Technology Way, P.O. Box 9106, Norwood, MA 02062-9106; Headquarters: (617) 329-4700; California: (714) 641-9391, (619) 268-4621, (408) 559-2037; Colorado: (303) 590-9952; Maryland: (301) 992-1994; Ohio: (614) 764-8795; Pennsylvania: (215) 643-7790; Texas: (214) 231-5094; Washington: (206) 251-9550; Austria: (222) 885504; Belgium: (3) 237 1672; Denmark: (2) 845800; France: (1) 4687-34-11; Holland: (1620) 81500; Israel: (052) 28995; Italy: (2) 6883831, (2) 6883832, (2) 6883833; Japan: (3) 263-6826; Sweden: (8) 282740; Switzerland: (22) 31 57 60; United Kingdom: (932) 232222; West Germany: (89) 570050

CAE & SOFTWARE DEVELOPMENT TOOLS

CAE FOR WINDOWS

- *Simultaneous access to multiple sheets of a drawing*
- *Checks for violations of design rules*

ICO-CAP is a schematic-capture software package that works with Microsoft's Windows graphics manager and runs on IBM PCs and compatibles. The number of levels in the design hierarchy is limited only by the amount of memory available; you can create very large drawings that extend over many sheets. The package provides simultaneous access to a sheet and a symbol, or to many sheets, or to two different magnifications of the same sheet. The program generates a netlist as a background task during the drawing session—no compilation is necessary. The program performs extensive checking for violation of your design rules and provides on-line help via menus. You can direct output to laser printers, dot-matrix printers, and pen plotters. \$695.

IC Options Inc., 970 University Ave, Los Gatos, CA 95030. Phone (408) 395-6680.

Circle No 430

ANALYZER

- *Lets you evaluate thermal aspects of pc-board designs*
- *Accepts positional data from popular CAD/CAE systems*

The Thermal software package runs on IBM PCs and compatibles or on VAX workstations. With the aid of the vendor's RAMCAD interface, the program accepts positional data from popular CAD/CAE systems and lets you evaluate component layout, use of cooling fins, air temperature, airflow rate and direction, and other thermal aspects of your design. Menus and on-line help facilities guide you through the steps involved in acquiring the data and initiating the analysis. The program identifies components that violate the temperature constraints of your

specifications; it provides easily interpreted results that will help you predict the thermal characteristics of your board and that you can use to modify your board design and improve your board's reliability and maintainability. You can create additional data for the parts library that comes with the package. IBM PC-based systems, from \$3500; VAX-based systems, from \$8000.

Systems Effectiveness Associates Inc., 20 Vernon St, Norwood, MA 02062. Phone (617) 762-9252.

Circle No 431

SCIENCE TOOLS

- *Provide C functions that you can call from Turbo C*
- *Offer a set of C functions that you can call from Microsoft C*

The Science and Engineering Tools package consists of a set of C functions for general statistics, multiple regression, curve fitting, integration, FFTs, differential and simultaneous equations, matrix math, complex math, and special functions. The manual describes the form, purpose, and parameters of every function. Sample programs show you how to use the libraries of analysis and graphics functions. The vendor offers these source-code routines in two versions: one that operates with Borland International's Turbo C, and the other with Microsoft C. Both versions are available on either 3.5-in. or 5.25-in. diskettes. \$74.95.

Quinn-Curtis, 49 Highland Ave, Needham, MA 02194. Phone (617) 444-7721.

Circle No 432

DSP SOFTWARE

- *Lets you display multiple files simultaneously*
- *Provides basic and advanced DSP functions*

Data Master is a signal-processing software package that runs on IBM

High-Performance IEEE-488 Solutions



for your IBM PS/2

COMPARE THESE BENEFITS

- Runs on Personal System/2 models 50, 60, and 80 (Micro Channel™)
- Most extensive software library – program in the language of your choice
- Highest performance available – up to 1M bytes/sec data transfer rate using NI Turbo488™ gate array
- ON SRQ interrupt response
- Applications Monitor – real-time error checking and program tracing with pop-up windows
- Best price/performance
- FREE technical support with toll free telephone service
- 30-day money back guarantee
- 2-year warranty



NATIONAL INSTRUMENTS™

The Leader in IEEE-488

12109 Technology Blvd.
Austin, Texas • 78727-6204

CALL FOR FREE CATALOG
800/531-4742 • 512/250-9119

CIRCLE NO 183

PCs and compatibles. The package combines graphics routines, data-sampling routines, test-data-generation routines, complex-data math routines, DSP (digital signal processing) utilities, and a pipe facility that allows one utility to take its input from the output of another. The package provides a console window for user interaction and a graphics window for the display of data. You can adjust the size and placement of each window and the degree by which it overlaps the other. The DSP utilities include fundamental operations such as forward and inverse FFT routines, convolution, correlation, and filter design and implementation. You can perform multistage transformations by combining the DSP operations with the math functions in data pipes. The package lets you integrate custom routines with the utilities and lets you use a wide variety of data-acquisition hardware and

additional analysis software. To run the package, your IBM PC or compatible needs at least 256k bytes of RAM, two floppy-disk drives, and MS-DOS 2.0 or higher; a hard disk and math coprocessor will improve performance. You can use Hercules monochrome graphics and IBM EGA, VGA, or compatible graphics. The package supports most popular dot-matrix printers and the HP LaserJet printer. \$115.

Durham Technical Images, Box 72, Durham, NH 03824. Phone (603) 868-7203.

Circle No 433

μP SIMULATORS

- Let you simulate boards with as many as 10,000 gates
- Chip models run on an IBM PC or compatible

The Susie software simulator runs on the IBM PC and compatibles,

and provides behavioral models of 8-bit μPs and microcontrollers. The models are written in 8088 assembly language to ensure acceptable execution speed. The parts library supplied with the package includes all TTL, ECL, and CMOS chips, so that you can simulate pc boards that have as many as 10,000 gates in addition to the processor chip. You can simulate programmable logic devices at the system level by loading their JEDEC fuse maps. The processor models include specialized test patterns for testing basic processor operations. Models of the 8051, Z80, and M68HC11 processor are in development. You can currently obtain a package containing models of an 8-chip processor family that includes the 8035, 8039, 8048, and others. \$1495.

Aldec, 3525 Old Conejo Rd, Suite 111, Newbury Park, CA 91320. Phone (805) 499-6867.

Circle No 434



**THE SOURCE FOR
INDICATOR LIGHTS**

IDI Industrial Devices, Inc., Edgewater, New Jersey 07020
Telephone: (201) 489-8989

**HOW TO
MAKE
THE
LIGHT
DECISION.
FREE!!**

IDI offers you the largest selection. LED's, Neon Glow Lamps, Relampable and Non-relampable indicator lights. They're all listed in our free catalog. Along with standard variations, money-saving packages, our customizing services and much, much more.

It's the industry's source... make it your source.



Industrial Devices, Inc., Hackensack, NJ 07601
Telephone: (201) 489-8989

It's yours FREE!! For more information, circle **184** on the reader's card.

80C31/51

Microcontrollers

A wide range in record time

- A choice between 4, 8 or 16 Kbytes of ROM, with on-chip RAM from 128 to 256 bytes, all CMOS.
- Operating clock speeds range from zero up to 16 and even 18 MHz!
- The MHS "Quick ROM" service can have customized samples or production parts delivered to your doorstep in just two or three weeks.
- And for ROMless 80C31/C32 parts, delivery worldwide is virtually instantaneous.

With over 7 million units delivered to date, MHS is one of the world's leading - and fastest - microcontroller suppliers.



Ask for a quotation today:

<p>MATRA DESIGN SEMICONDUCTOR 2895 Northwestern Parkway SANTA CLARA, CA 95015, USA. Tel. 408-986 9000, Tx. 299656</p>	<p>MATRA HARRIS SEMICONDUCTEURS BP 309 78054 SAINT-QUENTIN-YVELINES CEDEX FRANCE. Tel. 1-30 60 70 00, Tx. 697 317</p>
--	--

Marconi introduces the only keypad made to give extreme reliability. Under extreme conditions.

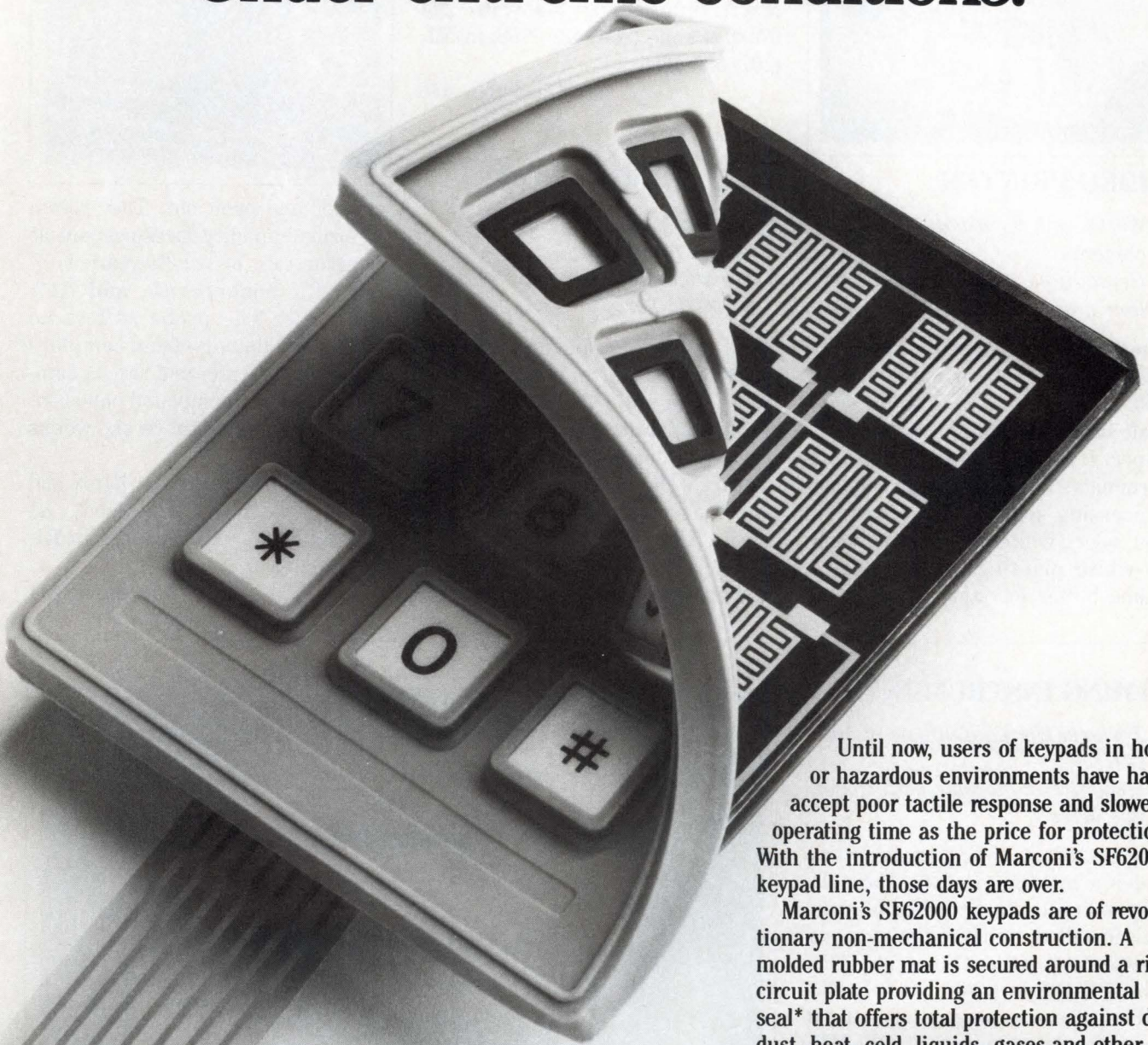

Until now, users of keypads in hostile or hazardous environments have had to accept poor tactile response and slower operating time as the price for protection. With the introduction of Marconi's SF62000 keypad line, those days are over.

Marconi's SF62000 keypads are of revolutionary non-mechanical construction. A molded rubber mat is secured around a rigid circuit plate providing an environmental seal* that offers total protection against dirt, dust, heat, cold, liquids, gases and other hazards of modern industrial, military and medical usage. The new construction accepts data as fast as the operator can hit the keys, with positive tactile "snap action" confirming contact even when the keys are not struck precisely.

The SF62000 line is available in 4, 12, 16 key and QWERTY formats in a variety of mat colors and keytop legends. For complete information, including the availability of samples, write or call today.

*Exceeds BS 5490 (Class IP67) requirements.

See us at EDS Show April 26-28, Booth No. 631

Marconi

Electronics Devices, Inc.
MICROSYSTEMS DIVISION

45 Davids Drive, Hauppauge, NY 11788
516 231-7710, FAX: 516 231-7923

CIRCLE NO 186

NEW PRODUCTS

TEST & MEASUREMENT INSTRUMENTS

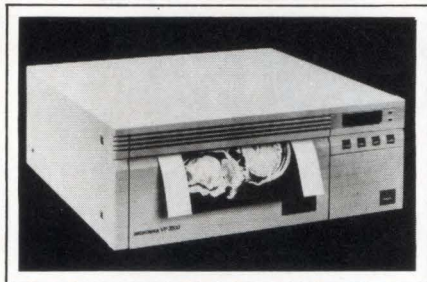

VIDEO PRINTER

- Works with terminals and TV cameras
- Reproduces 300 dots/in. with 64-tone gray scale

The VP-3500 video printer provides 1280×1250 pixels of resolution at 300 dots/in. with a 64-tone gray scale on 8.5-in.-wide, thermal-print paper. It connects to computer CRT terminals, TV cameras, and image-processing systems. The unit lets you select white-on-black or black-on-white printing and includes a frame buffer for storing images to

be printed. Its front panel sports a 32-character LCD display. \$6700.

Seiksha America Inc, 1111 MacArthur Blvd, Mahwah, NJ 07430. Phone (800) 422-7768; in NJ, (201) 529-4655.

Circle No 440



TEMP/RH RECORDER

- Records temperature and humidity for 100 days
- Transfers data to computer via RS-232C port

The Ranger data logger, in combination with the temperature and relative humidity (RH) probe, records temperature and humidity for periods as long as 100 days. The unit captures the data without using paper; after a recording session, you can use the unit's RS-232C port to transfer the captured data to an IBM PC or compatible computer for

analysis and print out. The system performs humidity measurement at an error rate of $< \pm 2\%$ /year; it offers $< 2\%$ nonlinearity, and $< 1\%$ hysteresis. The probe suffers no permanent damage from complete immersion in water and resists damage from sulfur-compound pollution. \$844. Delivery, four to six weeks ARO.

Rustrak Instruments, Rte 2 and Middle Rd, East Greenwich, RI 02818. Phone (800) 332-3202; in RI, (401) 884-6800.

Circle No 441

TIMING INSTRUMENTS

- Perform timing analysis at 500 MHz
- Generate 32-bit-wide patterns at 250 MHz

The T-132 logic timing analyzer provides a maximum of 32 channels. Depending on the number of channels installed, it makes timing measurements at either 250 or 500 MHz. The PG-132 is a 32-channel, 250-MHz pattern generator. The T-116 provides 16 channels of 500-MHz timing analysis and 250-MHz pattern generation. The configuration of the timing analyzers determines their maximum memory depth; they can have 4 to 16k words of memory. The pattern generators offer 4k-word memory depth, but they can generate repetitive patterns of infinite length. An equivalent-time sampling option endows the T-132 with 100-psec resolution for meas-

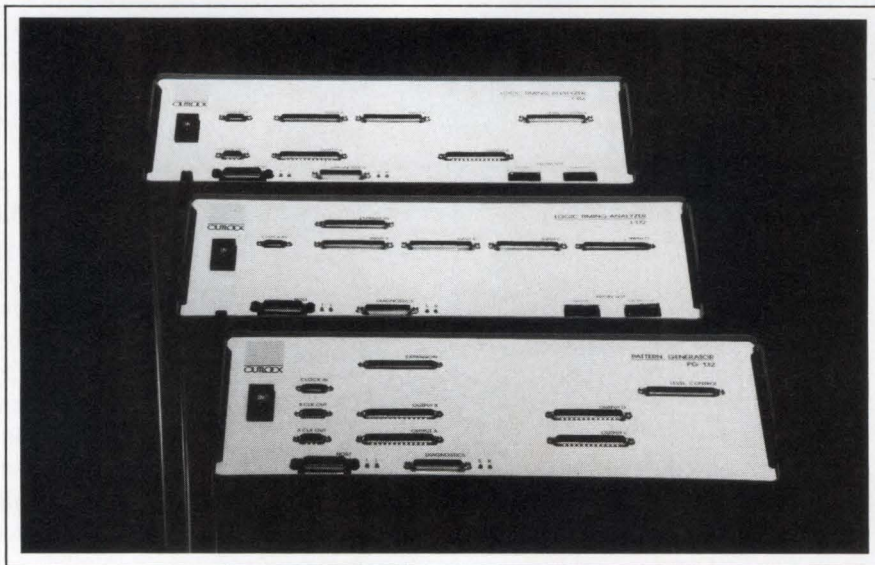

urements on repetitive waveforms. Another T-132 option lets it capture setup and hold-time violations, a capability that is standard on the T-116. You can position the capture window from 4 nsec before to 16 nsec after an external clock's active

edge, and you can make the window width as long as 1.5 nsec, in 200-psec increments. \$14,750 to \$19,750.

Outlook Technology Inc, 200 E Hacienda Ave, Campbell, CA 95008. Phone (408) 374-2990. TLX 350479.

Circle No 442

IF YOU'RE WASTING TIME LOOKING FOR THE BROADEST LINE OF SMD[®] PASSIVES,

CUT IT OUT!



**Mail to: Mepco/Centralab, Inc., Attn: Corp. Advertising
2001 W. Blue Heron Blvd., Riviera Beach, FL 33404.**

Mail this coupon today to request your personal copy of the new Mepco/Centralab Surface-Mount Device Catalog, containing important design, performance and specifying data on America's broadest line of SMD[®] passive components:

- Tantalum and monolithic ceramic chip capacitors
- Aluminum electrolytic capacitors
- Thick-film and precision metal-film resistors
- Power resistors
- High-performance trimmers

Or ask for our valuable data book on leaded resistors and capacitors.

Please send me these specification guides:

- 1987 Surface-Mount Device Catalog
 Resistor/Capacitor Data Book

Name _____
Title _____
Company _____
Dept./Div. _____
Address/MS _____
City _____
State/Zip _____

DN4/14

MEPCO/CENTRALAB
A NORTH AMERICAN PHILIPS COMPANY

THE ACTIVE LEADER IN PASSIVE COMPONENTS

*SMD is a service mark of North American Philips Corporation.

SHARP FLAT PANEL DISPLAYS

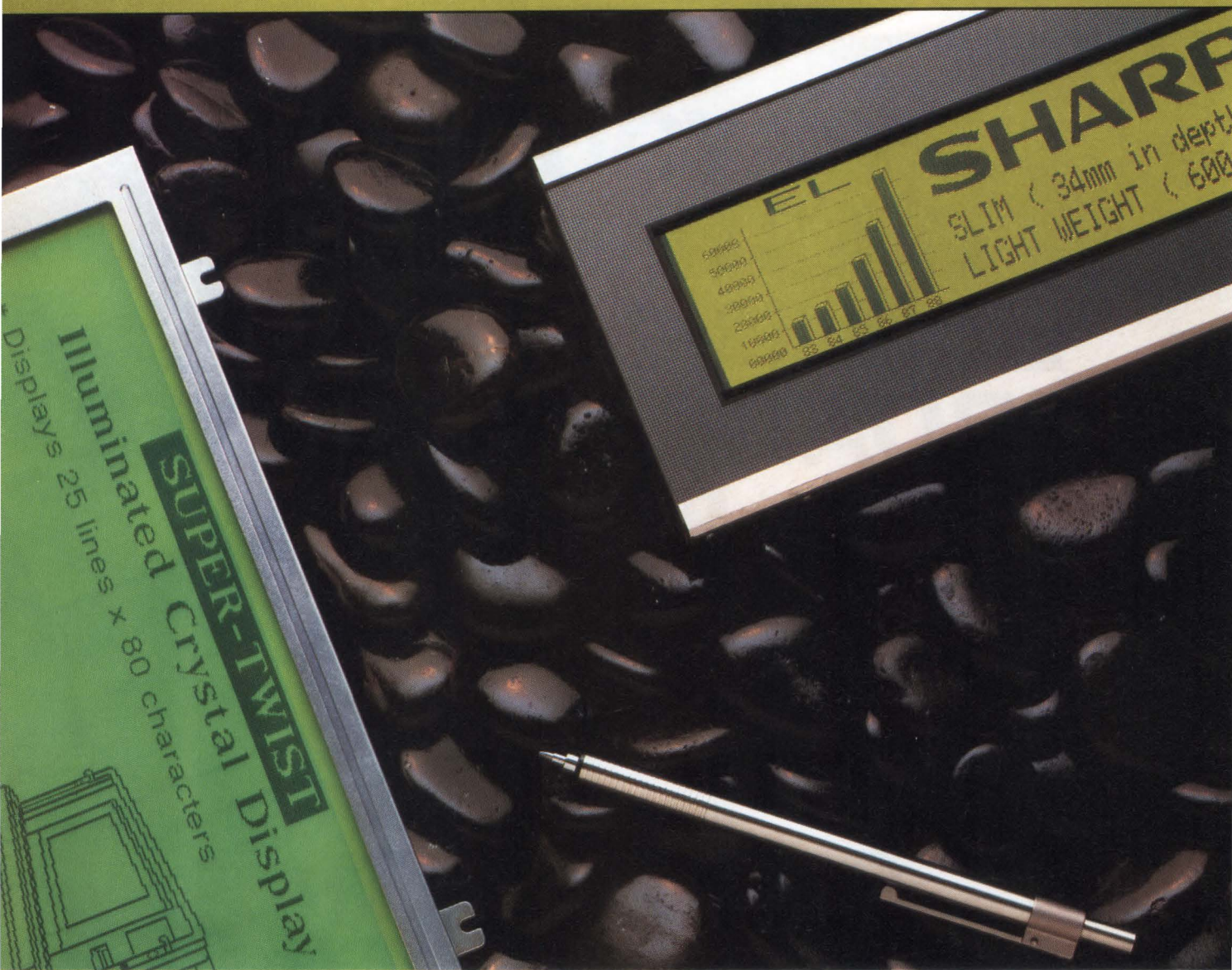

Thin is In.

As any designer will attest, the latest rage in the electronics industry are liquid crystal and electro-luminescent flat panel displays. The reason for their popularity is clear — thin displays mean sleeker, more efficient designs.

Sharp is the recognized leader in LCD and EL flat panel displays.

With over 30 years experience in building the world's clearest, most reliable displays, Sharp is sure to make an LCD to fit your needs.

Of course, the most popular place to order your Sharp displays is Marshall Industries. In fact, Marshall is the only national distributor of Sharp LCDs. But that's the kind of privilege you expect when you have over 30

years experience serving the electronics industry.

When you need a clear display that fits just right, remember the leader in flat panel displays. Sharp. And remember the best place to find them. Marshall.

Because Marshall knows you can never be too sharp or too thin.

Marshall

(*Authorized Locations)

AL Huntsville (205) 881-9235*
AZ Phoenix (602) 496-0290*
 Tucson (602) 790-5687*
CA Irvine (714) 859-5050*
 Los Angeles (818) 407-4100*
 Sacramento (916) 635-9700*
 San Diego (619) 578-9600*

San Francisco (408) 942-4600*
CO Denver (303) 451-8383*
CT Connecticut (203) 265-3822*
FL Ft. Lauderdale (305) 977-4880*
 Orlando (305) 767-8585*
 Tampa (813) 576-1399*
GA Atlanta (404) 923-5750*

IL Chicago (312) 490-0155*
IN Indianapolis (317) 297-0483*
KS Kansas City (913) 492-3121*
 Wichita (316) 264-6333*
MA Boston (617) 658-0810*
MD Maryland (301) 840-9450*
MI Michigan (313) 525-5850*

MN Minneapolis (612) 559-2211*
MO St. Louis (314) 291-4650*
NC Raleigh (919) 878-9882*
NJ N. New Jersey (201) 882-0320*
 Philadelphia (609) 234-9100*
NY Binghamton (607) 798-1611*
 Long Island (516) 273-2424*

Rochester (716) 235-7620*
OH Cleveland (216) 248-1788*
 Dayton (513) 898-4480*
 Westerville (614) 891-7580*
OR Portland (503) 644-5050*
PA Pittsburgh (412) 963-0441*
TX Austin (512) 837-1991*

Brownsville (512) 542-4589
 Dallas (214) 770-0616*
 El Paso (915) 593-0706*
 Houston (713) 895-9200*
 San Antonio (512) 734-5104
UT Salt Lake City (801) 485-15
WA Seattle (206) 747-9100*
WI Wisconsin (414) 797-8400*

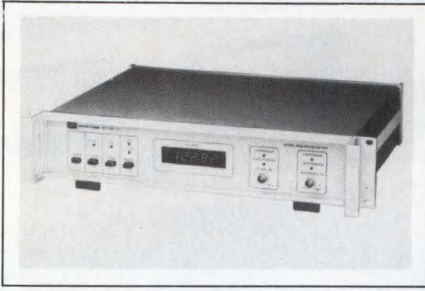

DIGITAL PHASE METER

- Handles 5 Hz to 500 kHz
- Accepts amplitudes from 10 mV to 350V

The Model 6000 autoranging digital phase meter includes an IEEE-488 interface. It accepts signals whose amplitudes range from 10 mV to 350V at frequencies from 5 Hz to 500 kHz, with sine, square, or triangular waveforms. The meter's 5-digit LED display can resolve phase changes as small as 0.01° from -180° to +360°. The meter's accuracy is guaranteed to be better than ±0.05° for sine or square waves.

The rear panel has a connector from which you can obtain an analog voltage that's proportional to the measured quantity (the calibration factor is -10 mV/°). The rack-mountable unit measures 19×3.5×14 in. \$3295.

Clarke-Hess Communication Research Corp., 220 W 19th St, New York, NY 10011. Phone (212) 255-2940.

Circle No 443

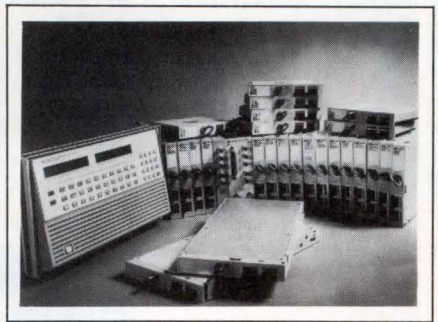

ACQUISITION MODULES

- Compatible with HP 3852A control unit
- Output data at 800k points/sec; input at 100k points/sec

The HP 44700 Series of I/O modules for the HP 3852A data-acquisition and control mainframe now includes four additional modules. One is a dual-channel D/A converter with 16-bit resolution and 14-bit mono-

tonicity. This converter can accept new data at a rate of 800k points/sec. Another module is a 4-channel multiplexer which, for each channel, contains an amplifier whose gain is programmable to values of 1, 10, and 100; a 4-pole, lowpass Bessel filter with 10-kHz cutoff frequency; a track-and-hold circuit; and a peak detector. The other two modules are 4-channel strain-gauge signal conditioners similar to the multiplexer but with separate bridge-excitation capability for each channel. For digitizing dynamic signals, you can capture data on all channels simulta-

Portable EPROM, EEPROM Microprocessor Programmer

The Stag PP39 is a powerful, yet low cost portable programmer suited to all levels of MOS Device Editing and Programming.

- Supports: 24, 28, 32 and 40-pin DIL EPROMs (upto 8M bit capacity); E²PROMs in 24 and 28-pin DIL packages and 28 and 40-pin DIL single chip microcomputers.
- Fast device programming using algorithms such as Intel's 'Quick-Pulse Programming*'; AMD's 'Flashrite' and Texas Instrument's SNAP.
- 512K bit RAM - expandable to 4M bits.
- Device identification by JEDEC standard Electronic Identifiers such as Silicon Signature* and Intelligent Identifier*.
- Comprehensive on-board RAM editor allows fast and easy manipulation of device data.
- Auto recall of 'Last-Used' machine configuration on power-up.
- Ability to save and recall up to 9 complete sets of operating parameters including device type, bit mode, interface configurations and address limits.

Stag Microsystems Inc.

1600 Wyatt Drive
Santa Clara, CA95054
(408) 988-1118 (CA) OR 3 Northern Blvd
Amherst, N.H. 03031
(603) 673-4380



PP39

- Supports many different I/O formats including Inteltec, Tek Hex, Motorola S-Record, Hex ASCII, Binary and others.
- Computer remote control capability is standard.
- Stag's 'StagCom 1' software communications package enables the programmer to be easily interfaced to a PC and used under 'Single-Key Operation' remote control.

* Intelligent Identifier and Quick-Pulse are trademarks of Intel.
* Flashrite is a trademark of AMD.
* Silicon Signature is a trademark of Seeg.
* SNAP is a trademark of Texas Instruments.



Sophisticated systems for the discerning engineer



Series A and B Regulated



Rack Mounting



DC-DC Converters

ACOPIAN

POWER SUPPLY CATALOG 1988



Plug-In



Switching

Miniaturized



Redundant Output Systems



Narrow Profile

New 52-page 1988 catalog

Acopian single, dual and triple output power supplies featured in our new catalog for 1988 are shipped in three days. Included are PC-board-mounting and chassis-mounting mini modules. DC-DC converters. General-purpose modular supplies with outputs to 200 Vdc and current ratings to 32A. Narrow-profile supplies a mere 1.68" thin. Plug-in

supplies. MIL-tested supplies. Unregulated supplies for driving relays and displays. Supplies with broad adjustment ranges. Our rack-mounting power supplies and systems, and redundant output systems are shipped in nine days. The catalog contains complete specs and pricing information. Call or write for your copy.



P.O. Box 638, Easton, PA 18044
Call toll free (800) 523-9478

P.O. Box 2109, Melbourne, FL 32902
Call toll free (800) 327-6817

DC POWER SUPPLIES SHIPPED IN 3 DAYS

CIRCLE NO 190

neously by triggering the multiplexer or the strain-gauge signal conditioners from a data strobe you supply; these modules are ready to accept new data at a 100-kHz rate. \$1500 to \$1900. Delivery, eight weeks ARO.

Hewlett-Packard Co, 1820 Embarcadero Rd, Palo Alto, CA 94303. Phone local office.

Circle No 444

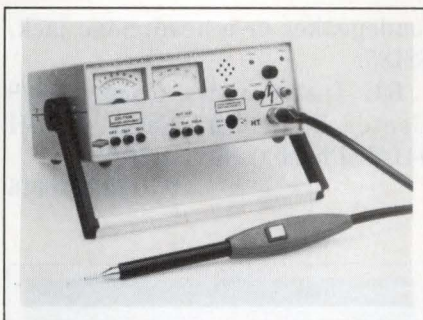

under test, the tester limits discharge energy. You can monitor insulation leakage current on a front-panel-mounted meter that provides 10-nA resolution on its most sensitive range and reads 100 μ A on its highest range. The unit also includes an ionization detector with an active lowpass filter and provides an audible output via an internal

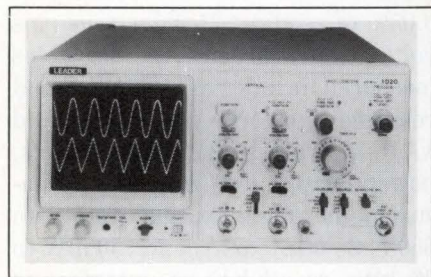

LOW-COST SCOPE

- Maximum sensitivity is 0.5 mV/div
- Bandwidth is 20 MHz

The dual-channel Model 1020 provides all of the oscilloscope functions required in many applications. The instrument has an 8x10-cm viewing area with an illuminated internal graticule, a 20-MHz bandwidth, and maximum sensitivity of 0.5 mV/div. Trigger capabilities include alternate-channel triggering, variable trigger holdoff, TV-sync separation, and line triggering. \$595.

Leader Instruments Corp, 380 Oser Ave, Hauppauge, NY 11788. Phone (800) 645-5104; in NY, (516) 231-6900. TWX 510-227-9669.

Circle No 445

INSULATION TESTER

- Portable unit weighs 9.5 lb
- Performs nondestructive testing to 15 kV

Operating from 110/240V 50- to 400-Hz ac mains or a bolt-on 12V battery pack, the 9.5-lb Model JP15 nondestructive insulation tester provides output voltage adjustable from 0 to 15 kV. To safeguard operating personnel and the equipment

THE 60A IS MORE THAN A LOGIC PROGRAMMER.



NEW. ABEL Design Software supports all of the latest PLDs.

NEW. The 60A is also an EPROM programmer with support for 120 memory devices.

NEW. The 60A now supports nearly 300 of the most popular PLDs.

At \$2495*, the 60A Logic Programmer is a very affordable way to get into logic. This high-quality programmer supports nearly 300 of the most popular PLDs. And its flexible architecture lets you buy only what you need today and upgrade tomorrow.

Now the 60A is more than a dedicated logic programmer. With support for 120 popular EPROMs, it is the most versatile programmer in its price range. To switch from PLDs to EPROMs, simply change adapters.

With the 60A, your PC, and Data I/O's family of compatible software tools, you can build a complete

logic development system right at your desk. ABEL™, the industry-standard logic design software, lets you describe your circuits using any combination of boolean equations, truth tables, or state diagrams. Then add PROMlink™, interface and file management software, to control programming from your PC.

For just \$2495, the 60A gives you logic programming and a lot more.

1-800-247-5700
Dept. 736

DATA I/O

*U.S. price list only.

CIRCLE NO 191

THE LCD PROBLEM SOLVERS

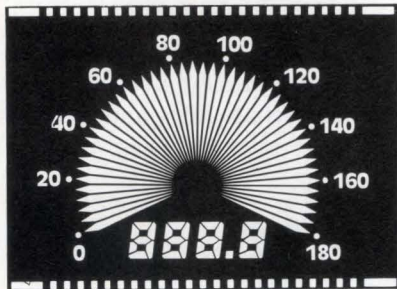

Proven production technology, coupled with our new 20,000 sq. ft., state-of-the-art U.S. plant, assures timely delivery of quality LCDs.

LEADING THE WAY IN DISPLAY TECHNOLOGY

POLYTRONIX, INC.

805 ALPHA DR. • RICHARDSON, TX 75081
214/238-7045 • FAX 214/644-0805

CIRCLE NO 192



Tauber and Gates. Your Power Connection.

Gates Energy cells give you design flexibility, long life and superior performance. Tauber Electronics gives you immediate off-the-shelf delivery. And with our flexible value-added design and production capabilities, you can get custom packs built in any configuration: series or parallel, case or shrink wrap. With Tauber Electronics, you'll get reliable products, engineering assistance and responsive, personal service. Call today and find out more.



TAUBER ELECTRONICS, INC.

4901 Morena Blvd., ste. 314
San Diego, CA 92117 619/274-7242
FAX 619/274-2220; LA 213/416-9000
OC 714/667-0177; N. CA 408/737-9408

CIRCLE NO 193

TEST & MEASUREMENT INSTRUMENTS

loudspeaker or a headphone jack. \$2185.

RE Instruments Corp, 31029 Center Ridge Rd, Westlake, OH 44145. Phone (216) 871-7617.

Circle No 446



DEVELOPMENT SYSTEM

- Supports 80286, 68000, 68010, 68012, and 68020
- Allows memory updates while user program runs

The vendor can configure the SA98 development system to support the 80286, 68000/10/12, or the 68020. Its zero-wait-state emulation allows memory and I/O modifications as well as high-speed data transfers to and from the target system while your program continues to run. The system provides a trace buffer 4k words deep and can use pods that the vendor supplied with earlier in-circuit emulators. The unit, which is compatible with Intel OMF, Tektronix Hex, and Motorola S records, uses a single I/O slot in a PC bus-based host for its parallel interface card. \$7000 to \$16,500.

Sophia Computer Systems Inc, 3337 Kifer Rd, Santa Clara, CA 95051. Phone (408) 733-1571. TLX 853394

Circle No 447

POWER ANALYZER

- 3-channel display includes rms current and voltage
- Also measures seven other quantities

You can use the Model 636 multi-function power analyzer at 50 or 60 Hz. Its 3-channel, 5-digit LED display indicates ac voltage, ac cur-

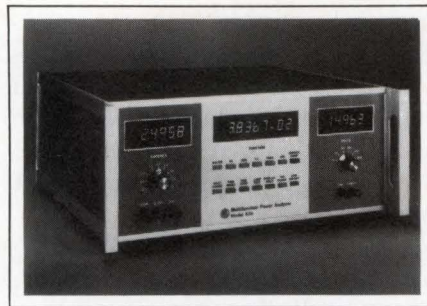

rent, and one other parameter you can select from the front panel. For most measurements, accuracy is 0.05% of reading. Besides true-rms voltage and current, the variables measured include real, complex, and reactive "power" (watts, VA, and VARs), watt-hours, VAR-hours, power factor, and frequency. Measurement ranges extend from 4 to 660V, 25 mA to 55A, and 150 mW to 36 kW. An IEEE-488 interface is optional. \$7500.

Dowty RFL Industries Inc, Powerville Rd, Boonton, NJ 07005. Phone (800) 242-7421; in NJ, (201) 334-3100.

Circle No 448

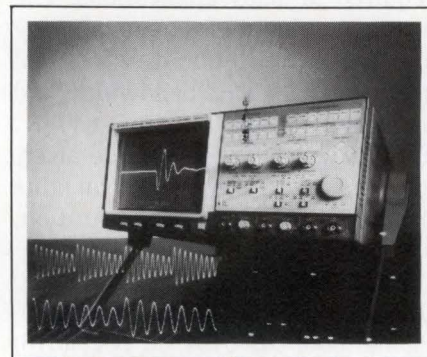

STORAGE SCOPE

- Samples single-shot events at 100M samples/sec
- Features on-screen cursors for trace measurements

The BOS 2-channel digital storage oscilloscope's 100-MHz sampling rate and 10224-word trace memory let you capture single-shot events that last longer than 102 μ sec. For example, you can record and analyze a complete TV video line. Further, you can add, subtract, or multiply the two input channels together,

SMART CHANGE.

CHANGE TO CHOMERICS FOR LOW-COST, COMMERCIAL GRADE EMI GASKETS

We heard you. You've wanted commercial-grade conductive elastomers priced competitively with wire mesh, carbon-loaded silicone, and metal finger stock. You also want them to deflect under low closure force.

They're here. Introducing the CHO-SEAL® 1000 series of low-cost silver-filled elastomers that give you the performance you need—60dB EMI shielding in the 30MHz to 1GHz range.

They're available in a variety of innovative shapes, with attachment time-savers like pressure-sensitive adhesives, mounting clips, and frames for pop-rivets. They can also be produced as custom designs. And of course you get the dust-sealing, acoustic, and cosmetic benefits which elastomers provide.

You get something else, too. Chomerics' years of EMI shielding experience, reputation for quality, and the most reliable products in the industry.

Make the smart change today. Call or write for the facts.

CHOMERICS
a GRACE company

77 Dragon Court, Woburn MA 01888
800-225-1936 (In MA: 617-935-4850)

CHOMERICS EUROPE
First Avenue, Marlow, Bucks, SL7 1YA England
(06284) 6030



SIMPLY THE BEST DEFENSIVE LINE IN THE GAME.

When it comes to depth, diversity, and a proven winning record, no other line of circuit breakers can compare with ours. The Airpax team is your source for fast response and reliable performance in your choice of more styles, configurations and ratings to meet your specific needs.

We've been tackling the toughest applications for more than thirty years. Chalking up milestone victories such as twenty years of uninterrupted MIL-C-39019 approval in Type AP electromagnetic circuit breakers. Blitzing international markets

with the VDE-approved and rail-mount magnetic circuit breakers. Continually striving through innovation to keep you, the Airpax customer, at the forefront of circuit breaker technology.

Draft the best defensive players into your design. Contact Airpax Corporation, Cambridge Division, Woods Road, Cambridge, MD 21613. (301) 228-4600. Telex: 6849138, Fax: (301) 228-8910. A North American Philips Company.

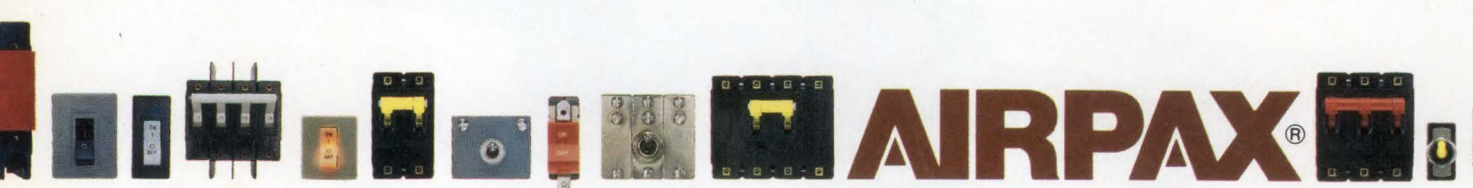
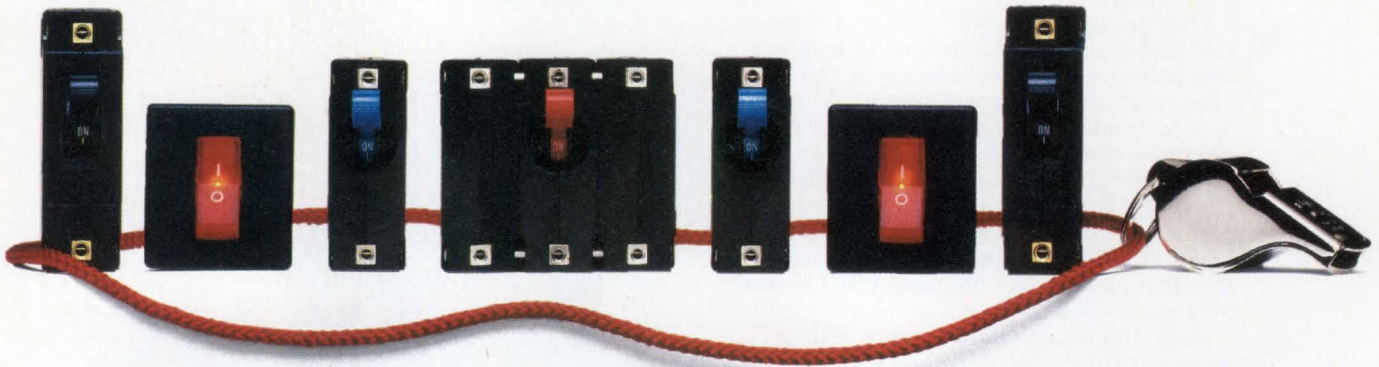

AIRPAX®

CAMBRIDGE DIVISION

CIRCLE NO 195

TEST & MEASUREMENT INSTRUMENTS

and integrate, differentiate, or square them. Besides displaying the traces, the oscilloscope's 7-in. CRT provides two measurement cursors and offers digital readout of the relevant oscilloscope settings. You can use the cursors to perform relative-voltage and time measurements between any two points on the trace, or absolute-voltage measurements and time-difference measurements from the oscilloscope's trigger point. The oscilloscope can display the traces in the dot, linear-interpolation, or sine-interpolation modes. The instrument comes with an IEEE-488 instrument-control interface; you can order it with an option that lets you store a sequence of 10 instrument setups max in the non-volatile memory. You can download captured traces to an IEEE-488-compatible digital plotter or to an XY recorder. Around \$5000.

Rohde & Schwarz GmbH, Muhlendorfstrasse 15, 8000 Munich 80, West Germany. Phone (089) 41290. TLX 523703.

Circle No 449

Rohde & Schwarz, 4425 Nicole Dr, Lanham, MD 20706. TWX 510-223-0414.

Circle No 450

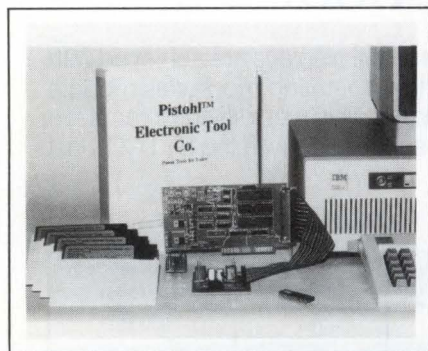

ERASABLE PLD TOOLS

- Generate JEDEC fuse maps from Boolean equations
- Program E^1 and E^2 PLDs

The PET100 product family consists of an erasable-logic assembler, an erasable-logic programmer, and a development system that combines the assembler and programmer.

These tools support parts from Altera, Atmel Cypress, AMI/Gould, ICT, and Monolithic Memories. The assembler accepts Boolean equations and generates JEDEC fuse maps with test vectors. A 50-rule expert system examines the input. When it finds an error, it suggests corrections, automatically invokes a WordStar-like text editor, and posi-

tions your CRT's cursor over the error. The programmer accommodates 20-, 24-, and 40-pin devices with "skinny" and wide footprints. Assembler, \$295; programmer, \$495; development system, \$795.

Pistohl Electronic Tool Co., 22560 Alcalde Rd, Cupertino, CA 95014. Phone (408) 255-2422.

Circle No 451

Your product looks good longer, for less, with Oak rubber keypads.

Finally! Conductive and non-conductive rubber keypads that meet the long life and reliability of conventional switches. Oak's rubber keypads give you:

An **expensive look** for your product at a **lower cost** than other technologies. With **greater durability** than ever before.

Now you can have silicone rubber keypads that perform up to 5 million cycles depending upon stroke, key pressure and snap effect. With a U.L. rating of 94-V0; operating temperatures from -40°C to $+85^{\circ}\text{C}$; resistance to weather, corrosion, bacteria and puncture; and custom color combinations including translucent for backlighting. Think of all the possibilities for **your** product applications!

Ask for our free specification guide.

OAK Switch Systems Inc.

P.O. Box 517
Crystal Lake, IL 60014
Phone 815/459-5000

OAK
Your Partner
in Excellence

CIRCLE NO 196

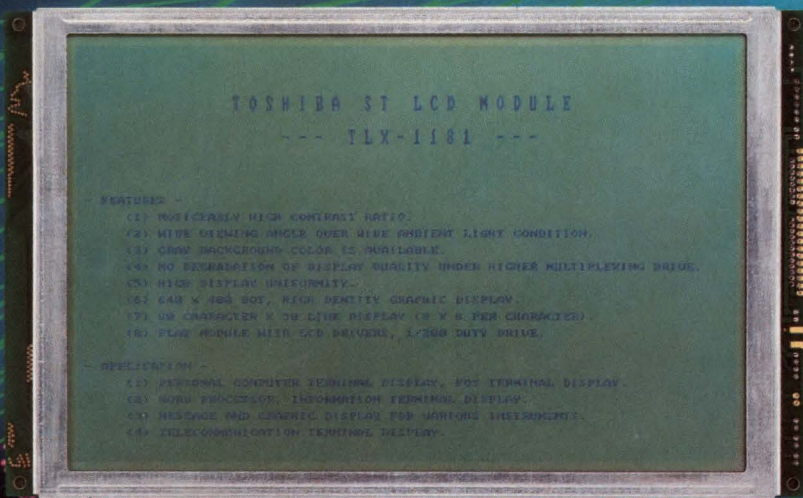

When your eyes need high quality displays, you need the Toshiba ST LCD.

Once again Toshiba has made a breakthrough in display quality. Clear and beautiful displays are achieved with the ST LCD. The LCD for the new age. And for your eyes. Now, by employing a new operating mode, this module provides excellent readability from a viewing angle perpendicular to the LCD panel. This was difficult to achieve with conventional LCDs. The aim was to make our LCD easier on the eyes. We succeeded with the ST LCD. Just another improvement in the man-to-machine interface by Toshiba.

ST LCD Module Specifications

Model name	Number of dots	Duty	Dot pitch (mm)	Outline dimensions (mm)	EL Back Light (Option)	Recommended controller
TLX-1181*	640 × 400	1/200	0.35 × 0.35	276 × 168 × 12	Yes	T7779
TLX-932	640 × 200	1/200	0.375 × 0.375	293 × 97.6 × 14	No	T7779
TLX-561	640 × 200	1/200	0.35 × 0.49	275 × 126 × 14	Yes	T7779
TLX-711A*	240 × 64	1/64	0.53 × 0.53	180 × 65 × 12	Yes	T6963C**
TLX-341AK*	128 × 128	1/64	0.45 × 0.45	93.2 × 86.6 × 12	No	T6963C

*Under development, **Built-in controller

CIRCLE NO 197

In Touch with Tomorrow
TOSHIBA

VISIT US AT ELECTRO/88
BOOTH NO. 2034 - WORLD TRADE CTR.

Toshiba America, Inc., Chicago Office: 1101A Lake Cook Rd., Deerfield, IL 60015 Tel: 312-945-1500 Northwestern Area Office: 2021 The Alameda, Suite 220, San Jose, CA 95126 Tel: 408-244-4070 Eastern Area Office: 67 South Bedford Street, Suite 200W, Burlington, MA 01803 Tel: 617-272-4352, 5548

EDN PRODUCT MART

This advertising is for new and current products.

Please circle Reader Service number
for additional information from manufacturers.

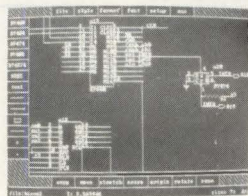

SuperCAD™
Schematic entry
Software for the
IBM® PC &
Compatibles
ONLY
\$99.00

COMPLETE PACKAGE

- ★ Easy-to-use schematic entry program for circuit diagrams, visible on-screen and pulldown menus
- ★ Supports popular graphic standards, mouse and printers
- ★ Powerful editing and drawing commands, including automatic drawing of digital busses
- ★ Extensive digital, analog and discrete parts libraries (Over 1,000 parts!)
- ★ In-depth, readable instruction manual has many examples and illustrations
- ★ Software includes part building, netlisting, design rule checking and bill of materials programs

MENTAL AUTOMATION, INC.

ORDERS/INFORMATION:

Send check or money orders to:

Mental Automation, Inc., Dept. S-9, 5415 136th Place
S.E., Bellevue, WA 98006 or call (206) 641-2141
Visa/MasterCard orders accepted!

CIRCLE NO 325

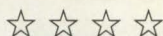

"The Best 8051 Emulator"

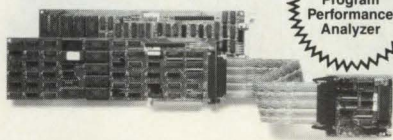

NEW
Program
Performance
Analyzer

8051

PC based emulators for the 8051 family

- 8051, 8751, 8052, 8752, 8031, 8032, 8344, 80C452, 80C152, 80535, 80C451
- PC plug in boards
- Command driven User Interface
- with static windows
- 16 MHz real time emulation
- 128K emulation memory
- 48 bit wide, 16K deep trace buffer with loop counter
- Program performance analyzer
- Powerful Macros with IF-ELSE, REPEAT-WHILE structures
- Single step in PLM-51 and C-51
- Symbolic debugging with in-line assembler and disassembler
- No external boxes
- Execution time counter
- Trace can be viewed during emulation!

PRICES: 32K Emulator for 8031 \$1790, 4K Trace \$1495

CALL OR WRITE FOR FREE DEMO DISK!

Ask about our demo VIDEO!

NOHAU
CORPORATION

51 E. Campbell Ave. #107E, Campbell, CA 95008 (408) 866-1820

CIRCLE NO 326

EMUL51-PC IN EUROPE

SWEDEN, NORWAY, FINLAND

Nohau Elektronik AB tel. 040 92 24 25

GERMANY

iSystem GmbH tel. 08131 1687

FRANCE

Emulations s.a.r.l. tel. 01 69 412 801

DENMARK

Tage Olsen A/S tel. 02 65 81 11

SWITZERLAND

thau Computer AG tel. 01 740 41 05

PORTUGAL

Fatronica lda tel. 01 83 56 70

We are currently seeking representatives in:

Great Britain, Italy, Spain, Holland,
Belgium and Austria

CIRCLE NO 327

ETA setting the
pace for circuit
protection

**MINIATURE
CIRCUIT
BREAKERS**

High Quality...
Low Cost...
Dependable Protection

Overcurrent protector, manual
reset eliminates fuse replacement.
Convenient panel
mounting. Ratings from 0.1 to
10 amp. Trip-free and fool-
proof. PC board and snap-in
mounts available.

For more information please
write or call.



ETA CIRCUIT BREAKERS
7400 N. CRONAME ROAD, CHICAGO IL 60648 • (312) 647-8303

CIRCLE NO 328

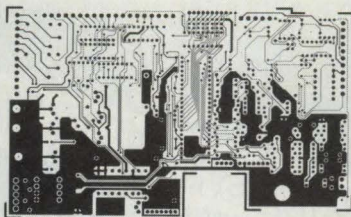

NEW CAD DESIGN SERVICE

Are you a company that wants your printed circuit board to have CAD accuracy? Then try us and see your design become a reality for a price you can afford. We use the Tango PCB™ Design System. Our system will accept ORCAD™ or SCHEMA™ Net lists on 5¼ floppy disk. We use CAE to determine whether your circuit will fit on the size you specify. TANGO PCB is Trademark of Accel Technologies ORCAD is Trademark of Orcad Corporation SCHEMA is Trademark of Omation Inc.

**CAD/
TECH**

11035 Ridge Forest Ct.
St. Louis, MO 63126
(314) 843-1334

CIRCLE NO 329

PAL®/EPLD PROGRAMMER

From
\$689.00



Stand Alone/RS-232 Programs and Verifies
20/24 pin PLDs from MMI, TI, National
Cypress, Lattice, AMD, Altera

PAL is a registered trademark of MMI.

From A Name You Can Trust

LOGICAL DEVICES INC.

1201 N.W. 65th Place
Ft. Lauderdale, FL 33309

1-800-331-7766 (305) 974-0967
Telex 383142 Fax (305) 974-8531

CIRCLE NO 330

To advertise in Product Mart, call Joanne Dorian, 212/463-6415

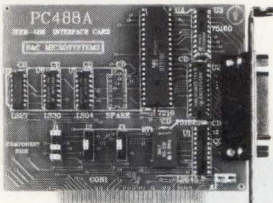

PC488 \$145

LOW COST PC/XT/AT INTERFACE FOR IEEE-488 (GPIB/HPIB)

- INCLUDES INSTALLABLE DOS DEVICE DRIVERS
- 1 OF 6 INTERRUPT LEVELS
- 1 OF 2 DMA CHANNELS
- UP TO 4 BOARDS PER COMPUTER
- CONTROLLER / TALKER / LISTENER
- CUSTOM SOFTWARE SUPPORT AVAILABLE
- COMPATIBLE WITH MOST IEEE488 SOFTWARE PACKAGES FOR THE IBM PC
- QUANTITY DISCOUNTS

VISA MC AMEX Call today for datasheet!!

B&C MICROSYSTEMS

355 West Olive Ave. Sunnyvale, CA 94086
PH: (408)730-5511 FAX: (408)730-5521 TELEX: 984185

CIRCLE NO 331

TTC Low-Profile Plastic Leaded Chip Carrier Socket
Reliable products & Reasonable price!

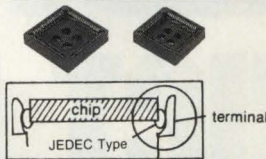

Special design makes the contact stably.
To be a connector manufacturer, we specialize in the following items:

1. PLCCS-44P, 68P, 84P
2. IC Socket (Dual in line)- 6P, 8P, 14P, 16P, 18P, 20P, 24P, 28P, 40P, 34P (4Rows)
3. Slot (Edge Card connector)- 36P, 50P, 62P, 80P, 86P, 98P, 100P.
4. shunt (Mini Jumper)
5. Pin Header: 2P — 40P (Single Row or Double Rows, Straight or Right Angle)

((OEMs are welcome))

TTC Shih Hsin Precision Corp.

No. 2, Lane 75, San Jun Street, Shu-Lin Town, Taipei, Taiwan, R.O.C. Tel: 886-2-6894655, 689-4656
Fax: 886-2-6894657 Telex: 33210 TTCCO

CIRCLE NO 332

S.I. TECH F/O BIT-DRIVERS IBM PC/XT/AT COMPATIBLE with Diagnostic Software

Model 2320 I and II Bit-Drivers are board-level communications products with single or dual RS-232 full duplex channels. They connect and operate inside any IBM PC/XT/AT or similar computer systems, as well as personal computers. No need for RS-232 cables and external modem devices. Plus you'll get diagnostic software to help you bring your fiber optic communications channel on-line. Data rates up to 19.2 Kbps; distance to 15,000 ft. (5 km). Small size, light weight and EMI/RFI problem-free. Status indicators are standard. Volume discounts. For complete Model 2320 specifications, write to:

S.I. TECH

P.O. Box 609, Geneva, IL 60134
Or call: 312/232-8640

CIRCLE NO 333

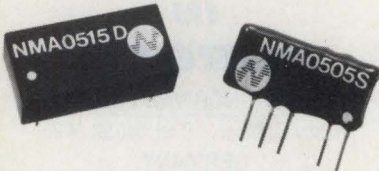

SUB MINIATURE DC-DC CONVERTERS

Small in Size - Low in Price

NEW from NEWPORT!

Save board space and cost with the NEWPORT range of DC-DC converters. The latest surface mount technology offers more power in a smaller package at a lower price.

Inputs: 5V, 12V, 24V and 48V
Outputs: $\pm 5V$, $\pm 12V$, $\pm 15V$ up to 1 Watt
Available in SIP or DIP versions, fully isolated, high efficiency. All components 100% burned-in and triple tested.

SEND FOR DATA SHEET

ALBAN Inc.
2336B Walsh Ave., SANTA CLARA, CA 95051
Tel: (408) 988-3949 FAX: (408) 988-3986

CIRCLE NO 334

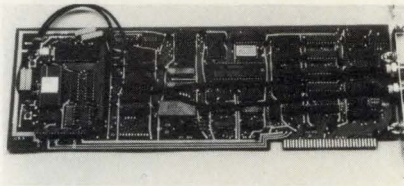

PC BASED DIGITAL SIGNAL PROCESSING AND DATA ACQUISITION

- TMS320C10 based Model 10 - 25 Mhz
- TMS320C25 based Model 25 - 40 Mhz
- Optional 12 Bit, 110 Khz A/D and D/A
- Development Software, including Debugger
- Applications Software: FFTs, Spectral Analysis Program
- Optional Continuous, No Gap sampling to/ from disk at high rates
- Prices start at \$650.

DALANCO SPRY

2900 Connecticut Ave NW Suite 241
Washington, DC 20008
(202) 232-7999

CIRCLE NO 335

A Lot For A Little

Reach 137,000 specifiers of electronics components, equipment, and systems for only \$780.

EDN Product Mart

CIRCLE NO 336

SINGLE CARD DATA ACQUISITION

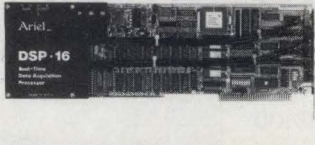

DSP-16 is a single card for the IBM PC or compatibles. Real-time 16 bit data acquisition on 2 input and output channels at up to 50 kHz simultaneously. User programmable TMS32020 or TMS-320C25. 512K or 2 Meg buffer. Concurrent sampling and anti-alias filters. Complete with software for applications and program development, common language interfaces.

Ariel

110 Greene St., NY, NY 10012
Call (212) 925-4155

CIRCLE NO 337



CAE/CAD Integrated Software Package for IBM PC/XT/AT/PS2

Weigh Cost Against Performance

When you balance cost and performance, EE Designer III gives you more features per dollar than any other electronic design software package. You get full-featured PCB layout plus schematic capture, analog/digital circuit simulation, support for EMS memory, 45 degree autorouting, and full postprocessing functions. EE Designer packages start at \$995.

30 day money back guarantee. Full purchase price refunded if not completely satisfied. Call 1-800-553-1177 today to order your package. Bank cards welcome.

VISIONICS CORPORATION 343 Gibraltar Drive
Sunnyvale, CA 94089

CIRCLE NO 338

"D" SIZE PLOTTER

\$2295⁰⁰
RETAIL

\$1695⁰⁰
INTRODUCTORY OFFER

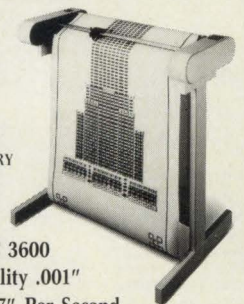

- Model PC 3600
- Repeatability .001"
- Speed at 7" Per Second
- Vacuum Paper Hold Down
- High Resolution Circles: Suitable for PCB Artwork

(415) 490-8380 **ZERICON**
STEVENSON BUSINESS PARK
BOX 1669 • FREMONT, CA 94538

CIRCLE NO 339

To advertise in Product Mart, call Joanne Dorian, 212/463-6415

NEW BOOK Properties of Silicon

This book summarizes the current state of knowledge on the material which forms the basis of modern electronics. Approximately 240 individual reviews; each contributed by a major authority, provide evaluated data and expert comment on information essential for the understanding and effective exploitation of silicon in its various forms. \$350.00



ORDERS TO:
INSPEC Dept./IEEE Service Center
445 Hoes Lane, P.O. Box 1331
Piscataway, NJ 08855-1331
Tel: (201) 562-5554

All Major Credit Cards And Telephone Orders Accepted

CIRCLE NO 340

REED RELAYS & SOLID STATE RELAYS

CONTACT FORM
1A, 2A, 3A,
1B, 1C, 2C

- DIP
- DIP-SML
- DIP-SMJ
- SIP
- VARI-PACK 1
- VARI-PACK 2
- GENERAL TYPE
- MICRO MINI

With more than 5 years experience, we supply the highest quality Reed relays at competitive price. We offer ultra-fast delivery-orders of up to 10,000 pieces are filled in just one day.



Manufacturer

KUAN HSI ELECTRONICS CO., LTD.
P.O. Box 94-150, Taipei, Taiwan, R.O.C.
Tel: 886-2-946-7741, 946-6051
Fax: 886-2-9434304

CIRCLE NO 341

FREE!

TODD'S NEW POWER SUPPLY CATALOG

Introduces Exciting New Switchers

- Specs, Performance, Mechanicals, Pinout, Mounting...
- Application Information
- Triple Outputs from 160 Watts to 750 Watts
- Quad Outputs from 160 Watts to 750 Watts
- Single Outputs from 5V @ 20 A to 48V @ 16 A
- DC-DC Switchers

Circle Bingo Number, call TODD or stop by Electro Booth #1710

TODD
PRODUCTS CORP.

50 Emjay Blvd., Brentwood, New York 11717
1-800-223-TODD, (516) 231-3366

CIRCLE NO 342

we make
innovation
work for you

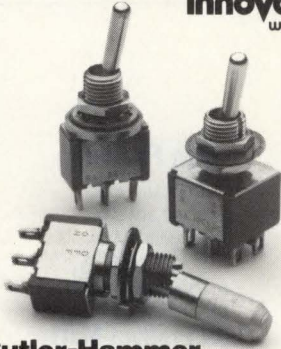

Cutler-Hammer miniature sealed toggles

Qualified to MIL-S-83731

These rugged miniatures are available in 1 and 2-pole configurations, with standard lever or lever lock operation. And they're yours at a miniature price. Technical assistance and customer service are always part of the product. Another innovation from: Eaton Corporation, Aerospace/Commercial Controls Division, 4201 N. 27th St., Milwaukee, WI 53216.

EATON

CIRCLE NO 343

LOW COST BUBBLE MEMORY SYSTEM \$713.00 FOR 720K BYTES

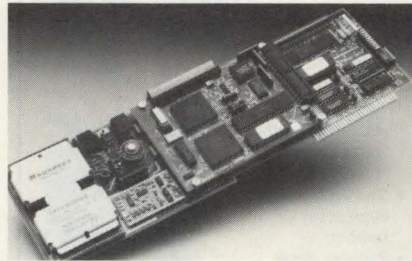

Rugged and reliable bubble memory systems for IBM PC/XT/AT. Master full length PC card includes SCSI host adapter and 720K Bytes of user available, non-volatile storage. Expandable to over 5M Bytes with additional slave cards. Acts like a hard disk under MS-DOS. 30ms access time. Comes complete with manual, drive and 2-year warranty.

Magnesys

1605 Wyatt Dr., Santa Clara, California 95054
Tel: (408) 988-1881 Fax: (408) 988-6165

CIRCLE NO 344

CY525 3rd generation STEPPER MOTOR CONTROLLER

most intelligent controller offers linear ramping, 10,000 steps/sec, unlimited stepping, change rate on the fly, read position on the fly, and much more.

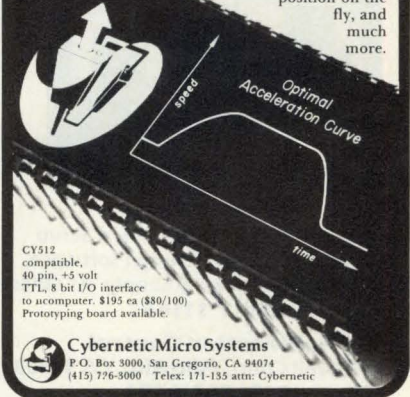

CY512 compatible, 40 pin, +5 volt TTL, 8 bit I/O interface to microcomputer. \$195 ea (\$80/100) Prototyping board available.

Cybernetic Micro Systems
P.O. Box 3090, San Gregorio, CA 94074
(415) 776-3090 Telex: 171-155 attn: Cybernetic

CIRCLE NO 345

6809 Single Board Computer

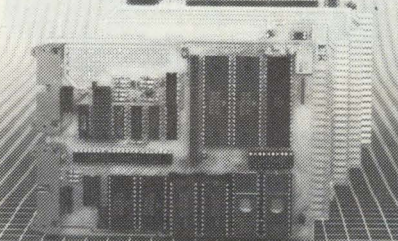

6809 MPU, 2 serial ports, 4 parallel ports, RAM, EPROM, real-time clock, watchdog timer, 44-pin 4.5" x 6.5" PCB
EXPANSION MODULES: RAM, EPROM, CMOS RAM/battery, analog I/O, serial I/O, parallel I/O, counter/timer, IEEE-488, EPROM programmer, floppy disks, cassette, breadboard, keyboard/display.

WINTEK
Wintek Corp.
1801 South Street
Lafayette, IN 47904
800-742-6809

CIRCLE NO 347

Worried About EMI/RFI? USE ELECTRODAG® SHIELDING COATINGS

- Air or Force Dry Formulations.
- UL Recognized for Good Adhesion.
- Line Proven, Easy Application.
- Stable Low Electrical Resistance.
- Choice of Copper, Nickel or Low Cost Silver Conductive Fillers.
- Prototype Service Available.

Acheson

1600 Washington Ave., Port Huron, MI 48060

TOLL FREE 1-800-255-1908

CIRCLE NO 348

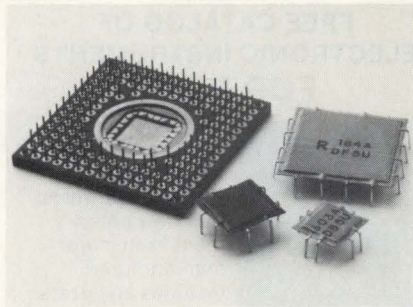

STOP NOISE IN PGA, LCC PACKAGES

PGA MICRO/Q decoupling capacitors provide low-inductance, high-frequency noise decoupling for PGA, LCC packages on complex board layouts. Fit under PGA or LCC sockets use no extra board space. Choose from many pinout configurations. **Rogers Corp.**, 2400 S. Roosevelt St., Tempe, AZ 85282. 602/967-0624.

CIRCLE NO 346

To advertise in Product Mart, call Joanne Dorian, 212/463-6415

IEEE-488

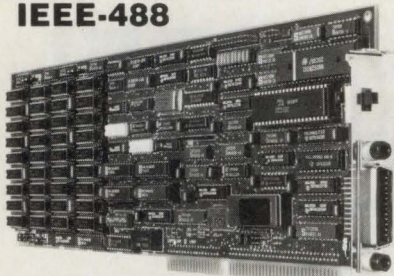

IEEE-488, PARALLEL, and SERIAL PORTS PLUS 4M BYTES of MEMORY

- Control any instrument. RS232 or '488.
- 4Mbytes of extended/expanded memory.
- Software library and memory manager.
- High speed DMA. Risk free guarantee.



Capital Equipment Corp.
99 South Bedford St.
Burlington, MA. 01803

FREE demo disk. Call (617) 273-1818

CIRCLE NO 349

EPROM PROGRAMMER \$349

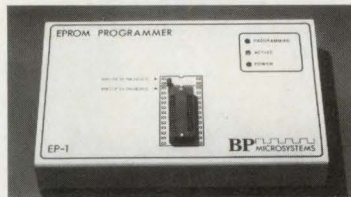

THE EP-1'S A GREAT VALUE & HERE'S WHY:

- READS, PROGRAMS, COPIES OVER 300 EPROMS AND EEPROMS FROM 29 MANUFACTURERS INCLUDING 2716-27513, 2804-28256, 27011
- READS & WRITES INTEL, MOTOROLA, STRAIGHT HEX AND BINARY
- OPTIONAL HEADS PROGRAM INTEL 874X, 8751, 87C51, 8755
- MENU-DRIVEN CHIP SELECTION BY MFG & P/N; NO MODULES
- FAST, SLOW, QUICK PULSE PROGRAMMING ALGORITHMS
- SPLITS FILES BY BASE ADDRESS AND OPERATOR (16&32 BIT)
- ALL INTELLIGENCE IN UNIT; 280 MICROPROCESSOR BASED
- \$ 12.5, 21, 25 VOLT PROGRAMMING FOR CMOS AND -A SUFFIX PARTS
- FREE PC-DOS SOFTWARE
- GOLD TEXTOL ZIF SOCKET
- SAME DAY SHIPMENT
- ONE YEAR WARRANTY
- MONEY-BACK GUARANTEE
- RS232 TO ANY COMPUTER
- 8 BAUD RATES TO 38,400
- GENERATES, CHECKS CHECKSUMS
- TWO FREE FIRMWARE UPDATES
- UV ERASERS FROM \$34.95

CALL TODAY FOR MORE INFORMATION

BP MICROSYSTEMS

800/225-2102 713/461-9430 TELEX 1561477
10681 HADDINGTON #190 HOUSTON, TX 77043

CIRCLE NO 350

CHIP COILS DC-DC CONVERTERS PULSE TRANSFORMERS

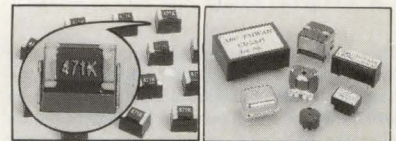

Our Chip Coils is good for your miniaturization & surface mounting. DC-DC Converters, pulse transformers & band pass filters is now complete with excellent functions. We also supply choke coils, power chokes, linearity coils, toroidal coils, pulse transformers, coupling transformers, power transformers and others. Send for details today!



OEM and Agent
Inquiries Invited

ABC TAIWAN ELECTRONICS CORP.

No. 422, Sec. 1, Yang Fu Rd., Yangmei 32627,
Taoyuan, Taiwan, R.O.C.

Tel: (03) 4788088, Telex: 32379 ABCCE

Fax: (03) 4755503

CIRCLE NO 751

Servo Design SIMPLIFIED with PC-Based Kit

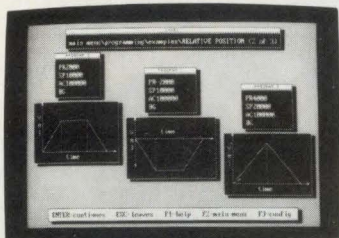

KIT CONTAINS:

- Plug-in Motion Controller
 - Servo Motor
 - Encoder
 - Design Software for PC
 - Power Driver & Supply
 - Cables
- ONLY \$1145**

Galil Motion Control

1054 Elwell Court, Palo Alto, CA 94303

(415) 964-6494

CIRCLE NO 752

SMART CARD EXTENDER EASY ON \$195⁰⁰ — PC/XT \$225⁰⁰ — AT

A smart card extender for PC/XT/AT and compatibles

- Allows card insertion and extraction without power on/off cycles
- Saves time by eliminating DOS re-boots
- Reduces wear and tear on hard disk drives
- Extends host interface for hardware and software development and test
- A single switch controls the connection of all signals to and from the computer bus
- Patent pending

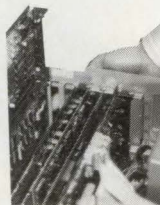

30 DAY NO RISK EVALUATION

APPLIED DATA SYSTEMS

9811 Mallard Dr. Suite 203

Laurel, MD 20708

For more information call **800-541-2003**

CIRCLE NO 753

Join Forces

Combine your larger ads with EDN Product Mart ads for a total marketing program.

◆
EDN Product Mart

CIRCLE NO 754

TIGER POWER 40-350W range of switching power supplies

Model: BM-2150
(Mini Tiger)



Lead Year's main SPSs products are:

- PS/2 models - 386 tower models
- 286/386-type PC/AT models
- Mini Tiger' super compacts
- Cubic Baby AT models
- PC/XT models - OEM are welcome



Visit us at **CeBIT'88 (Hall 6, Booth #G64)** or contact us today for more information on how Lead Year's Tiger Power make your electronics great!

Lead Year Enterprise Co., Ltd.
3F, No. 481, Chung Hsiao E., Rd., Sec. 6,
Taipei, Taiwan, R.O.C.
TIGER POWER P.O. BOX 53-352 Taipei Tel: 886-2-7857858
Tlx: 12862 LEADYEAR Fax: 886-2-7857852

CIRCLE NO 755

DATA ACQUISITION DIRECT TO DISK



SDI Signal to Disk Interface for hours of real-time signal data storage using an IBM PC. Record/playback 2 channels, 16 bits, up to 50kHz per channel. 50 or 250 Mbyte Winchester drives, 800 Mbyte optical. SCSI interface supports up to 7 drives! Advanced graphics-assisted cut & paste editing. Tape recorder simulation. From \$3495.

Ariel Corp.

110 Greene St., NY, NY 10012

Call (212) 925-4155

CIRCLE NO 756

FREE CATALOG OF ELECTRONIC INSTRUMENTS FOR RENT



1987-88 Rental Catalog is available from **Genstar Rental Electronics, Inc.** New equipment from major manufacturers includes analyzers, meters, generators, oscilloscopes, recorders, and more. Rental terms and conditions are included as well as toll free numbers of the U.S. inventory centers.

RENTAL ELECTRONICS, INC.

6307 De Soto Avenue, Ste. J
Woodland Hills, CA 91367
(800) 227-8409
(800) 331-3440 (in CA)

CIRCLE NO 757

To advertise in Product Mart, call Joanne Dorian, 212/463-6415

Only a Specialized Manufacturer Could Provide Versatile and Economic Products



With more than 11 years' experience in this field, we proudly offer you various types of conductive silicone rubber pads, rubber pads with multicolor and screen printing, silicone rubber overlay, rubber pads with screen printing on plastic keytops, O rings, washers, inner caps, tubes, etc., and screen printing flexible circuit boards. Please contact us for more information.

GS GENERAL SILICONES CO., USA
650 W Duarte 305, Arcadia CA 91006, U.S.A.
Tel: (818) 445-6036. Telex: 3716189 GSCUL.
Fax: 818-4456084

CIRCLE NO 758

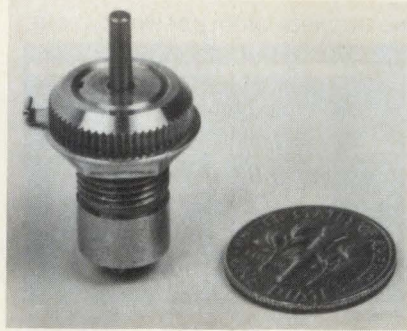

SPACE-SAVING SUBMINIATURE JOYSTICK

The Model 462 subminiature force operated joystick offers high performance in a small package. This two axis proportional control is only 3/8 inch in diameter with a back of panel depth of less than 1/2 inch making it ideal where space is an important factor. It performs positioning and tracking tasks fast and accurately, and provides high resolution, with continuous output and no dead zone.

Measurement Systems, Inc., 121 Water Street, Norwalk, CT 06854 (203) 838-5561.

CIRCLE NO 759

WE PROVIDE SOLUTIONS TO MANY INTERCONNECT PROBLEMS...



- Test Adapters (Socketed LCC/PLCC/PGA)
- Test Clips (Surface Mounted SOIC/PLCC)
- 150 Types of Prototyping Board Adapters
- 125 Types of Programming Socket Converters
- Many Types of Emulator Pod Converters
- PGA/PLCC Extraction/Insertion Tools
- And Much, Much More...



Emulation Technology, inc.

STATE OF THE ART VLSI and SURFACE MOUNT ACCESSORIES
2368-B Walsh Ave. • Bldg. D • Santa Clara, CA 95051
TEL: (408) 982-0660 • FAX: (408) 982-0664

CIRCLE NO 760

SOFTWARE VERSION CONTROL

The **POLYTRON** Version Control System (PVCS) provides precise & flexible configuration management for software development projects on Personal Computers, PC Lans and VAX minicomputers, including:

- Storage and retrieval of multiple revisions of source code.
- Maintenance of separate lines of development using branching.
- Merging of simultaneous changes.
- Modules can be reviewed by their own revision number, system version number, or specified date.
- Efficient disk storage. PVCS uses a very intelligent difference detection technique that minimizes the amount of disk space required to store a new version.

Personal PVCS — Offers most of the power and flexibility of Corporate PVCS. **\$149**

Corporate PVCS — Offers features to maintain source code of very large and complex projects that may involve multiple programmers. **\$395**

Network PVCS — Extends Corporate PVCS to use on networks. File locking and security levels can be tailored for each project. Call (503) 645-1150 for pricing on licenses for more than 5 stations. **\$995**

VAX PVCS — Call for pricing
Requires DOS 2.0 or higher. Compatible with the IBM PC, XT, AT and other MS-DOS PC's. Works with any language.

TO ORDER: VISA/MC 1-800-547-4000.
Dept. EDN Oregon and outside US call (503) 645-1150.
Send checks, P.O.'s to: **POLYTRON** Corporation,
1700 NW 167th Place, Dept. EDN, Beaverton, OR 97006.

CIRCLE NO 761

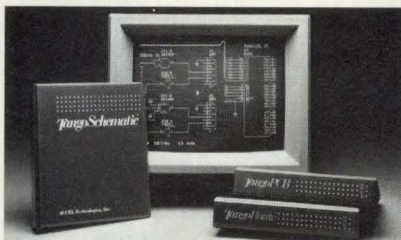

Great Designs Start With Tango-Schematic.™ Just \$495.

Designs quickly come to life with Tango-Schematic's easy-to-use drawing editor and extensive component libraries. Features four line types, four text sizes, repeat and block functions, unique built-in word processor. Includes DRG, BOM, Wire List, Net List outputs and crisp plots, prints, or laserprints. The perfect front end to our popular Tango-PCB and Tango-Route board design systems.

For IBM PC/XT/AT/PS2. Just \$495. Full-function Demo Package: \$10. Order toll-free 800 433-7801. VISA/MC. Thirty-day money back guarantee.

ACCEL Technologies, 7358 Trade St., San Diego, CA 92121
Outside N. S. America contact HST Technology (Australia)
Phone: 61-02-34-8499 FAX: 61-02-23-8771

CIRCLE NO 763



Glide Through PCB Design.

TangoPCB™ Create the toughest board designs with powerful layout software that's a snap to use. Function-rich Tango-PCB supports eight layers, 1 mil grid, OrCAD™ or Schema™ netlist input, print/plot/photoplot output, and more.

TangoRoute™ Get impressive completion rates and remarkable speed with Tango-Route, a four layer, eleven pass autorouter. **Just \$495 each.**

For IBM PC/XT/AT/PS2. Compare features and you'll buy Tango. Or try full-function Demo Package, just \$10. Order toll-free: 800 433-7801. VISA/MC. Thirty-day money back guarantee.

ACCEL Technologies, 7358 Trade St., San Diego, CA 92121

CIRCLE NO 763

RMB741 MULTIBUS ANALOG I/O

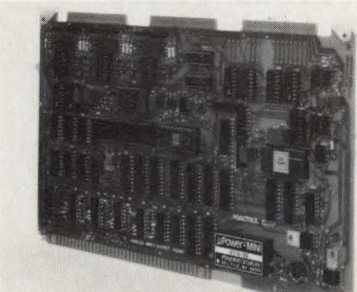

ANALOG I/O. The RMB741 has 12 output channels w. 12 bit resolution which may be connected in 4 different voltage ranges or as current loop outputs. The 32 SE or 16 DI inputs may be connected in 3 different voltage ranges or current loop. The input channels have 12 bit resolution, software programmable gain & sample-hold amplifier. On-board microprocessor has 6 programmable modes & 3 add'l self test modes. Multibus compatible.

ROBOTROL CORP.
16100 Caputo Drive, Morgan Hill, CA 95037
(408) 778-0400

CIRCLE NO 764

IEEE-488 CONTROLLER FOR PS/2

MODELS 50, 60, 80

- GPIB Compatibility
- Control Up to 14 Devices
- Selectable Addressing
- Software Included

1-800-553-1170



478 E. Exchange St., Akron, OH 44304
TEL: (216) 434-3154 FAX: (216) 434-1409
TLX: 5101012726

CIRCLE NO 765

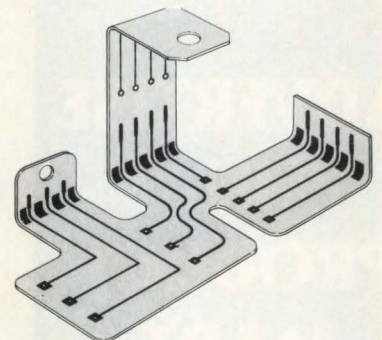

WE'RE BENDING THE RULES FOR CIRCUIT DESIGNERS

BEND/FLEX™, the bendable board material flexible enough to bend into any multi-plane shape. Eliminates stiffeners, flex-hardboard connectors. May reduce cost of two- and three-plane interconnect systems by as much as 30%!

Rogers Corporation. One Technology Dr., Rogers, CT 06263. (203) 774-9605.

CIRCLE NO 766

To advertise in Product Mart, call Joanne Dorian, 212/463-6415

Digital Control
Intro \$200
Digital Filter
Tutor \$450
Kalman Filter
Tutor \$925

Practical hands-on training courses that run on the IBM PC. Ideal alternative to text books, seminars, and university courses. FREE demo disk available.

Engineering Tutorial Software
22338 Lull Street
Canoga Park, CA 91304
(818) 716-0816

CIRCLE NO 776

NO ENGINEER SHOULD BE WITHOUT ONE

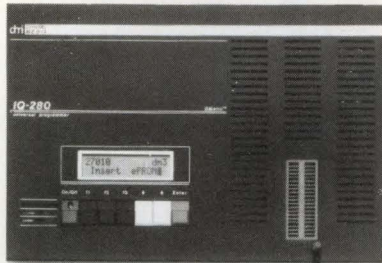

America's most advanced Personal Programmer
The Digital Media IQ-280 can program 40 PIN devices.

The most advanced firmware controlled pin driver system available means you never have to worry about buying another expensive module or PAK again. The IQ Personal Programmer line offers the power and features comparable to many of the \$5,000 programmers, but at a fraction of the costs.

Support for CMOS, NMOS, ECL, Bipolar, PROMs, EPROMs, eEPROMs, PLDs, ePLDs, iFLDs, up to 40 pin DIP packages.

Altera, AMD, Atmel, Cypress, Excel, Fairchild, Fujitsu, GI, Hitachi, Hughes, Intel, Lattice, Mitsubishi, Motorola, National, NEC, MMI, Samsung, Seag, Sierra, Signetics, SMOS, TI, Toshiba, Waterscale and more. ALMOST 1000 DEVICES!

Whatever your need is, Digital Media can help you solve it. And you won't believe how little it costs.

Call (714) 751-1373 to receive a complete product specification package immediately.

CIRCLE NO 777

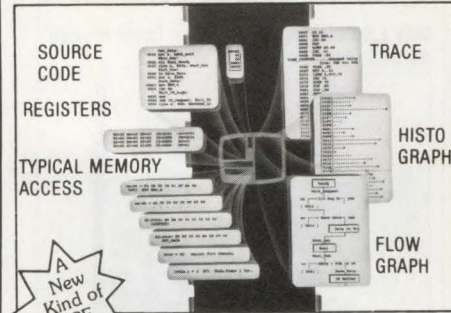

A New Kind of ICE

dICE-51 only \$795

8051 Debugger with In-Circuit-Element

The CY-8051 in-circuit element replaces the 8051 and communicates with your IBM-PC over COM1. The powerful dynamic user interface provides source code and symbolic debugging with easy access to all 8051 spaces. Live keyboard, Global Symbol Monitor, 'C' support. Histogram generated during reduced speed execution. Lowest cost, most powerful 8051 design support. Mil spec and CMOS versions available.



Cybernetic Micro Systems, Inc.
Box 3000 • San Gregorio, CA 94074 • USA
(415) 726-3000 • Telex: 910-350-5842

CIRCLE NO 778

T.Z.T. SUPPLY A FULL RANGE OF CONNECTORS AND SOCKETS

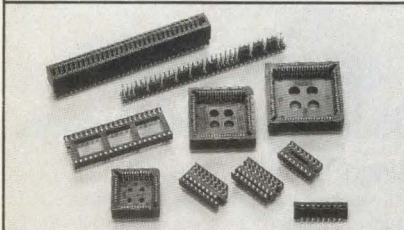

CHIP CARRIER - 44PIN, 68PIN AND 84PIN
EDGE CONNECTOR - BOTH CONTACT TYPE: CANTILEVER CONTACT AND LOOP BELLOWS. LOW PROFILE IC SOCKET, MINI JUMPER, PIN HEADER AND CONNECTOR FOR FLEXIBLE PRINTED CIRCUIT.



TAIWAN ZETATRONIC INDUSTRIAL CO., LTD.

No.333, Hsin Yi Road Lu Chou, Taipei Hsien
Taiwan, R.O.C. Tel: 886-2-2816395-7
Tlx: 33573 ZETACO Fax: 886-2-2832237

CIRCLE NO 779

WINPOINT
A FULL RANGE OF
CONNECTORS & SOCKET

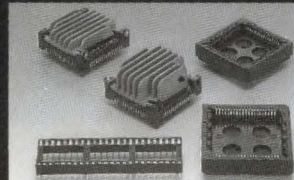

IC SOCKETS-8, 14, 16, 18, 20, 22, 24, 28, 40, 42, 48 contact
LCC SOCKET-68 contact
PLCC SOCKET-28, 32, 44, 52, 68, 84 contact series



Winpoint Electronic Corp.

P.O. Box 89-80, Taipei, Taiwan, R.O.C. Office: No. 47, Chi-Wei St., San Chung City, Taipei, Taiwan, R.O.C.
Tel: (02) 966-0208, 984-0209
Telex: 34227 WINPOINT Fax: 886-2-9838555

CIRCLE NO 780



Schematic and PCB Software

Create and revise schematics and PCBs quickly and simply with **HiWIRE-Plus** and your IBM PC. Use symbols from HiWIRE-Plus's extensive library, modify them, or create your own quickly and painlessly. Netlist, bill-of-materials, and design-checking utilities are included. **HiWIRE-Plus** is \$895 and comes with a thirty-day money-back guarantee.

Wintek Corp.

1801 South St., Lafayette, IN 47904
(800) 742-6809 or (317) 742-8428

CIRCLE NO 781

Fill out this form to advertise in Product Mart.

EDN041488

**ADVERTISE
IN
PRODUCT
MART
AT
LOW COST**

ISSUE(S) REQUESTED _____

RATE:	1x	4x	7x	13x	19x	26x	39x	52x
(Please circle)	\$ 780	750	730	660	640	630	620	595

Company _____

Address _____

City _____ State _____ Zip _____

Telephone _____

Signature _____

AD ENCLOSED

AD TO FOLLOW

Mail to: EDN / 275 Washington Street / Newton, MA 02158-1630

EDN PRODUCT MART appears in every issue — 26x a year!

To advertise in Product Mart, call Joanne Dorian, 212/463-6415

HALF THE FIBER

Only ADC's active couplers cost-effectively offer simultaneous bidirectional transmission over a single optical fiber. These precision-manufactured couplers contain all the optics necessary to cut your fiber costs in half. Available in full-duplex (Model CAF) or half-duplex (Model CAH). Our active unidirectional WDM (Model CAM/CAD) makes wavelength division multiplexing cost effective, too.

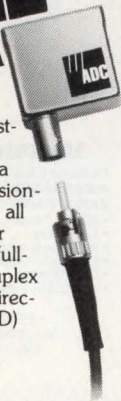

ADC Telecommunications

4900 West 78th Street, Minneapolis, MN 55435
(612) 893-3010

CIRCLE NO 785

ALL THE INFO.

Learn how you can cut your fiber costs with ADC's full-duplex bidirectional CAF coupler. This free application note shows the cost savings you can achieve by installing ADC couplers in place of conventional dual-fiber systems. No cost or obligation.

How to cut your fiber optic costs in half.

ADC Telecommunications

4900 West 78th Street, Minneapolis, MN 55435
(612) 893-3010

CIRCLE NO 786

NEW

CONTROL COMPUTER

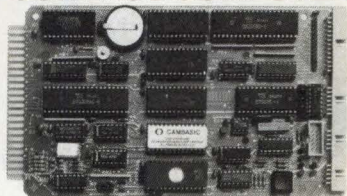

Our Multitasking Industrial Basic runs as fast as BASICA on the IBM PC/AT. It can also handle interrupts, frequency inputs, bit manipulation, datalogging and more. The hardware includes 4 channels of Analog with 12-bit resolution, 32 digital I/O lines, battery-backed calendar clock, keypad and display ports. 2 RS-232C serial ports, 96K RAM, EPROM and EEPROM programmers, autornun mode, low power CMOS circuitry, 8 MHz Z80 CPU. Only 4.5" x 8". Stand-alone or expandable. Low cost optional software turns your IBM PC into a program development workstation. FREE CATALOG describes other models and accessories. Call 303-426-8540 for same day response.

OCTAGON SYSTEMS CORPORATION 6510 W. 91st Ave. Westminster, CO 80030

CIRCLE NO 787

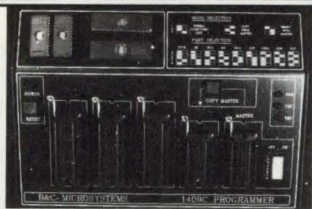

UNIVERSAL E(E)PROM PROGRAMMER \$495 (Kits from \$165)

- No personality modules; Menu driven device selection.
- Built-in Eraser/Timer option (\$50); Conductive foam pad.
- Direct technical support; Full 1 year warranty.
- Stand alone duplication & verify (27XX parts).
- Quick pulse algorithm (27256 under 60 sec).
- 27xx to 1 Mbit; 25xx; 68xx; CMOS; EEPROMS.
- 8741,-2,-4,-8,-8H,-9,-9H,-51,-CS1,-52,-55, 9761 & more.
- IBM-PC, Apple, CPM or Unix driver; Autobaud RS232.
- Offset/split Hex, Binary, Intel & Motorola 8,16,32 bit.
- Manual with complete schematics.

VISA MC AMEX Call today for datasheets !!

B&C MICROSYSTEMS

355 WEST OLIVE AVE. SUNNYVALE, CA 94086
PH: (408) 730-5511 FAX: (408) 730-5521 TELEX: 984185

CIRCLE NO 788

FREE CATALOG AND APPLICATIONS GUIDE

AFFORDABLE ENGINEERING SOFTWARE

PC/MSDOS - Macintosh - CP/M

ACNAP — \$125.00 AC Network Analysis, Component Libraries, Macros, AUTO Execute	LCFIL — \$95.00 LC Filter Design/Analysis/Synthesis
DCNAP — \$95.00 DC Network Analysis, Component Libraries, Macros, AUTO Execute	LSP — \$95.00 Logic Circuit Design/Simulation
SPP — \$125.00 Signal Processing Program Macros, AUTO Execute, Windowing	RIGHTWRITER — \$95.00 Report Proofreader Program, Applies 3000 Rules of English
PLOTPRO — \$72.95 Scientific Graph Printing	PDP — \$95.00 Scientific Plotting Program for Pen Plotters
PCPLOT3 — \$95.00 High Resolution Engineering Graphics Package	TEKCALC — \$95.00 Programmable Scientific Calculator/Statistics/Curve-fitting
LOCIPRO — \$95.00 Root Locus Stability Analysis Multiple, Nested Loops	COMCALC — \$72.95 Communications Budget Calculator and Spreadsheet Program
ACTFIL — \$95.00 Active Filter Design, Analysis, Synthesis	XFER — \$95.00 Transfer Function Analysis and Circuit Synthesis
MICRO-3 — \$125.00 Design & Analyze Microstrip Circuits, Filters, Hybrids, Couplers, Transformers	SPANNER — \$95.00 Integrated Word Processor, HP11C Calculator, and Scientific Graphics

BV Engineering Professional Software (714) 781-0252

2023 Chicago Ave., Suite B-13, Riverside, CA 92507 U.S.A. TELEX-3089864

CIRCLE NO 789

NO WAITING FOR COMPLETE, LOW PRICED, CHIP COMPONENT KITS

CC-1 Capacitor Kit contains 365 pieces, 5 ea. of every 10% value from 1pf to 33µf. CR-1 Resistor Kit contains 1540 pieces; 10 ea. of every 5% value from 10Ω to 10 megΩ. Sizes are 0805 and 1206. Each kit is ONLY \$49.95 and available for Immediate One Day Delivery!

Order by toll-free phone, FAX, or mail. We accept VISA, MC, AMEX, COD orders, or company PO's with approved credit. Call for free detailed brochure.



COMMUNICATIONS SPECIALISTS, INC.
426 West Taft Avenue • Orange, CA 92665-4296
Local (714) 998-3021 • FAX (714) 974-3420

Entire U.S.A. 1-800-854-0547

CIRCLE NO 790

SYNCHRONOUS/ASYNCHRONOUS RS-422, RS-485, RS-232, CURRENT LOOP

SYNCHRONOUS COMMUNICATION

- 1 Mbaud data transfer rate
- DMA facility
- Byte sync, SDLC, HDLC
- RS-422, RS-485, RS-232

ASYNCHRONOUS COMMUNICATION

- Single/dual port option
- Selectable interrupt
- Address selectable
- Current Loop, RS-422, RS-485, RS-232

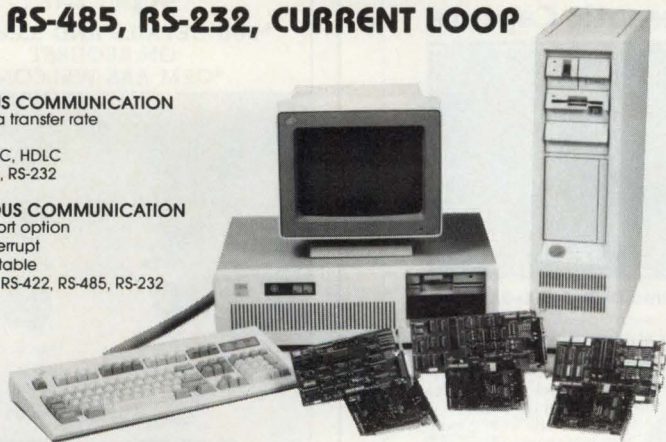

QUA TECH INCORPORATED

Leaders in Communication Technology

TOLL FREE: 1-800-553-1170
478 E. Exchange St. Akron, Ohio 44304
(216)434-3154 TLX:5101012726 FAX:(216)434-1409

CIRCLE NO 792

NEW!!

R2 Virtual Graphic System

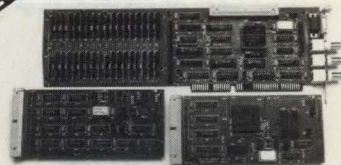

- TMS34010 GSP, XT/AT bus compatible.
- 32 MB total memory space; 512 KB DRAM and 1 MB VRAM on board.
- Open structure GSP bus; allows multiple bus masters.
- Flexible resolution and pixel depth. Window, clipping, or smooth hardware PAN across entire image space.
- Modular video adapters meet various display requirements.
- Optional hardware state machine protects software from piracy.

R2 \$1,995 V2 \$695
V1 \$295 V4 \$395

Maple Tech./RobotGraphics
1120 Stewart Ct. #B, Sunnyvale, CA 94086
(408) 732-0834 FAX: (408) 746-0894

CIRCLE NO 793

To advertise in Product Mart, call Joanne Dorian, 212/463-6415

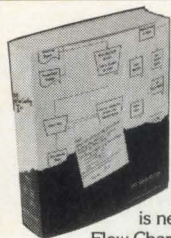

Flow Charting II+ The New Plus for Fast Flowcharting

FLOW CHARTING
is new! It's now

Flow Charting II+, with more speed
+ more functions + more printing options;

- 10 text fonts; 26 shapes; • Line mode can stop at a shape; • Backspace key can erase a line to its origin; • Free text entry anywhere, or select auto-centering; • Vertical or horizontal printing; one chart or multiple charts.

Used by Fairchild, Bechtel and more than 500 other major corporations. Edit quickly and accurately — even major edits — with Flow Charting II+, the Specialist.

See your retail store or call:

PATTON & PATTON

Software Corporation
800/672-3470, ext. 897 California
800/538-8157, ext. 897 National
408/629-5044 International

CIRCLE NO 235

Analog Circuit Simulation

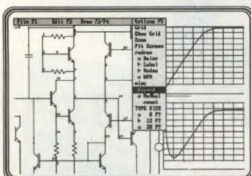

NEW SPICE_NET \$295.00

Make SPICE input files from schematic drawings using pull down menus and a mouse to draw and connect parts. Use an IBM PC with any UC Berkeley compatible SPICE program.

Simulation Programs

■ **IS SPICE, \$95.00.** Performs AC, DC and Transient analysis.

■ **PRE SPICE \$200.00:** Adds Monte Carlo Analysis, Sweeps, Optimization, libraries and algebraic parameter evaluation.

■ **Intu_Scope \$250:** A graphics post processor works like a digital oscilloscope. Easy to use with all the waveform operations you will ever need.

for
**IBM
PC's
from
intusoft**

(213) 833-0710

P.O. Box 6607
San Pedro, CA
90734-6607

CIRCLE NO 236

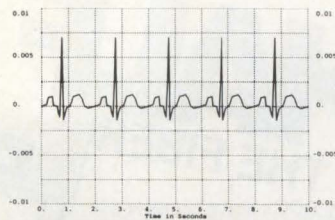

LOW COST ANALOG CIRCUIT ANALYSIS

Introducing a NEW RELEASE of **EC-Ace**, a subset of the powerful **ECA-2** analog circuit simulator. **EC-Ace 2.31** includes all of the basics, with increased graphics, expanded documentation, and a new low price.

- AC, DC, Transient
- Temperature
- Interactive or batch
- Twice as fast as SPICE
- Over 100 nodes
- 525 pg. ECA-2 manual
- Sine, Pulse, PWL, SFFM, and Exponential generators
- User friendly
- Fully supported
- Money back guarantee

EC-Ace 2.31 \$145
ECA-2 2.31 IBM PC/XT/AT/PS-2 \$675
An upgrade from **EC-Ace** to **ECA-2** is available.
Call 313-663-8610 For **FREE DEMO disk**



Tatum Labs, Inc

1478 Mark Twain Court, Ann Arbor, MI 48103

CIRCLE NO 237

SBX MODULES

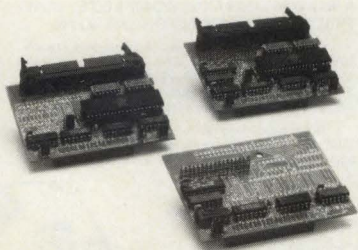

We've upgraded our SBSxSCSI module to support Block-Mode Pseudo-DMA transfers. That means CPUs without DMA can increase transfer speeds by not polling for READY on every byte. We've also added an optional Centronics-compatible printer port (SBSxSCSI/CEN). If you only need the printer port, save money with our low-cost SBSxCEN module. We also offer a Floppy-Disk Controller module (SBSxFDC) that handles 3 1/2", 5 1/4", and 8" drives with SD, DD and HD formats.

Call or write for more information.

Single Board Solutions, Inc.
20045 Stevens Creek Blvd.
Cupertino, CA 95014
(408) 253-0250

CIRCLE NO 238

E & H Field Probes

\$495

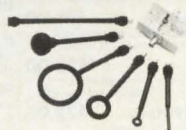

EDN "Readers Choice" (6/25/87)

Makes finding E & H Field emissions easy!

Use with any o-scope or spectrum analyzer. Set includes three H and two E field probes, extension handle, case, documentation, two year warranty. Pre-amp with battery charger, optional. Call, write to order or for brochure.

1-800-253-3761
PO Box 1546 Austin, TX 78767



The Electro-Mechanics Company

CIRCLE NO 239

Want
Attention From
137,000
Engineering
Specifiers?

Place your ad in
EDN Product Mart.

CIRCLE NO 240

PROGRAMMERS FOR IBM PC/XT/AT

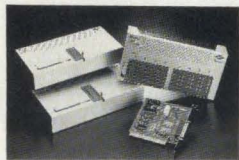

- Select Device with vender name & type number directly
 - Enable user to set up Program Pulse Width, Vpp, Vcc, Over-program Pulse Width & Iteration Counts
 - Capable of set & 8/16/32-bits wide-word programming.
 - Built in Intel Hex, Tektronix Hex, Motorola S, Hexadecimal, JEDEC transmission formats.
 - Suspend to DOS for operation of DOS utilities.
- XP6000** Adapter & cable installs in PC for connecting programmer externally \$ 55
- XP6001** 1-socket 1M-bits EPROMs programmer \$160
- XP6002** 8-socket 1M-bits EPROMs programmer \$375
- XP6003** 1-socket MCS-48 micros programmer \$215
- XP6004** 1-socket MCS-51 micros programmer \$270

2 YEARS GUARANTY + 30 DAYS MONEY BACK WARRANTY

Xender Corporation
2824, KENNEDY BLVD., JERSEY CITY, NJ 07306
TEL: 201-659-2258 Tlx: 910 240 4444 CHAMPION

CIRCLE NO 241

SCHEMA II Schematic Capture

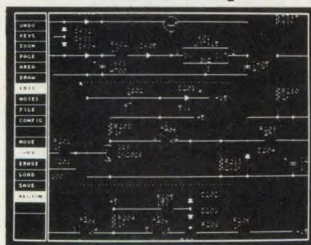

FREE Demo Disk: 1-800-553-9119

SCHEMA's success is the talk of the CAE industry and *thousands* of satisfied SCHEMA owners know why. Incredible speed, ease of use, and power have made SCHEMA a best-selling schematic capture program for engineering professionals the world over.

Now, SCHEMA II is available. SCHEMA II sells for \$495 and supports most common IBM PC/XT/AT configurations. Please call today for a *free* SCHEMA II demo disk.



OMATION

In Texas Call (214) 231-3167

CIRCLE NO 242

ZIPPY SWITCHES

NO: E91274

*FULL DETAILS AND SAMPLES
ON REQUEST
*OEM ARE WELCOME

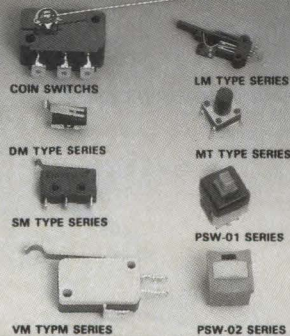

VM TYPM SERIES PSW-02 SERIES

ZIPPY SHIN JIUH CORP.
P.O. Box 10184 SHIN TIEN TAIPEI HSIEN, TAIWAN, R.O.C.
TEL: (02) 9188512-5 TLX: 33418 ZIPPY FAX: 886-2-9155765

CIRCLE NO 243

To advertise in Product Mart, call Joanne Dorian, 212/463-6415

Can time be caught up with?

Yes, if you use a time filter,

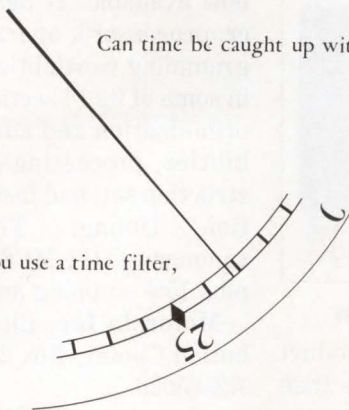

the natural corner-stone in digital correlation - making high resolution and wide delay span easy.

Delay LS-16 is good for more than 100 Ms/s, and it creates a time domain of 16 384 points! It's a new step in pulse stream pattern analysis.

Lilla Fiskaregatan 12
S-22222 Lund, Sweden



Telephone: 46 46 160915
Telex: 32837
Fax: 46 46 128792

CIRCLE NO 198

KEYBOARDS STANDARDS

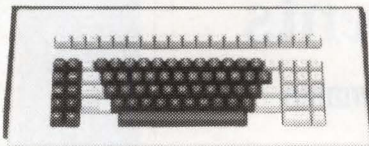

MODEL 8000
19" L x 8" W
Low Profile

- State-of-the-art microprocessor keyboard, 95 keys, including 19 special functions keys
- High reliability performance
- 4-wire serial interface, 300 or 1200 baud
- Unique variable key rollover with phantom key lockout
- High speed operation
- Ergonomic design.

CUSTOMS

GRI builds custom keyboards to your exact specifications and drawings for all types of applications - air traffic control, process control, military, etc. Our lighted keyboards are especially attractive due to their visibility and high reliability. We offer both dry reed and mechanical contact switch technologies.

QUALITY • RELIABILITY • SERVICE

GEORGE RISK INDUSTRIES, INC.

GRI Plaza

Kimball, Nebraska 69145

1-800-445-5218 - Sales

308-235-4645 - Technical



CIRCLE NO 199



Check rising costs

It's arrived - our new all purpose fuseholder system, series 19800.

Yet another innovative result of Wickmann technology. Fuseholders for 5 x 20 mm and 6,3 x 32 mm fuses feature extra solid contact pins, compatibility with existing shock-safe fuseholders, and sealed terminals.

Now everyone can afford superior circuit protection.

Hanover Fair
Open-Air Section,
Stand 26



A mark
of safety

Wickmann-Werke GmbH

Annenstr. 113 · Postbox 2520 · D-5810 Witten 6
Tel. 02302/6620 · Telex 8229 145 wwg d · Fax 02302/6621 11

CIRCLE NO 200

When wire runs where your tools won't reach...

Let us keep you in place

- Strong adhesive mounting system—keeps wire in place without screws or ties.
- Quick lock/release gives instant access to cable bundles.
- High impact material will not creep or deform.
- Choose from 8 sizes—3/16" to 1-1/2" wire bundle capacity.

the wire organizers For more information write today

dek, inc.

3480 Swenson Avenue
St. Charles, IL 60174
Phone: (312) 377-2575

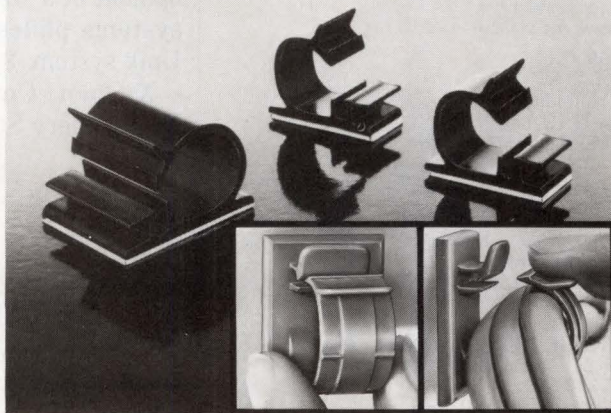

CIRCLE NO 201

New Instruments

μ P-based Programmable E/I dc Calibrator



Model 520/A

The Model 520/A is micro-processor based and is compatible with IEEE-488, (GP-IP).

The height is only 3½ inches, features current mode outputs from 10 nanoamperes (nA) to 110 milliamperes (mA), in 2 ranges, with extraordinary compliance of 100 Vdc. Even with this power, ideal for transducer instrument testing (4-20 and 10-50 mA), the accuracy is $\pm 0.005\%$!

The voltage mode has 3 ranges with outputs from 100 nV to 110 Vdc and optional to 1100 Vdc. Compliance current is 100 mA. The one year accuracy is $\pm 0.002\%$.

All ranges and both modes resolve to 1 ppm. A crowbar zero provides a reference for this essential value.

Availability: 60 days.

Price: \$3,150. 1000V option \$595.

Engineering Contact: **Bob Ross**

Tel: (617) 268-9696

FAX: (617) 268-6754

Programmable Resistance Calibrator

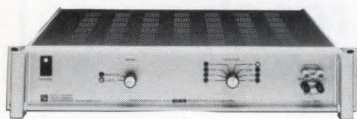

Model 620/A

The Model 620/A is a programmable IEEE-488 resistance calibrator which features eight cardinal resistance points. It eliminates need to switch leads for various ranges. Ideal for use with both non-smart DVM's and DMM's.

Features:

Front Panel Manual Controls

Accuracies 0.002% to 0.0125%

2 or 4 wire connections

True passive resistance

Specifications:

Temp: 0°C to 50°C

Relative Humidity: 70%

Setting: 1 to 10 meg

Accuracies: 0.0125% (at 1) to

0.002% (at 10 meg)

Accuracy: Valid and guaranteed for 12 months

Price: \$1,530

Engineering Contact: **Bob Ross**

Tel: (617) 268-9696

FAX: (617) 268-6754

ELECTRONIC DEVELOPMENT CORP.

11 Hamlin St., Boston, MA 02127

Tel: (617) 268-9696

TLX: 951596 (ELECDEVCO BSN)

CIRCLE NO 202

LITERATURE



Guide to instrumentation

The vendor's 1988/1989 product guide informs you about more than 5000 different models from major manufacturers of electronic test and measurement instruments, data-processing equipment, and telecommunications test devices that you can rent, lease, or buy. The 400-pg reference book contains specifications, descriptions, photos, and other technical data. Included in its listings are analyzers, CAE/CAD equipment, generators, meters, recorders, oscilloscopes, signal modifiers, microcomputers, and general telecommunications test equipment.

US Instrument Rentals, 2988 Campus Dr, San Mateo, CA 94403.

Circle No 525

Handbook covers X/Open system

The *X/Open Portability Guide* sets forth the specifications of the Common Applications Environment (CAE) for compliant systems and software. The CAE comes from the commitment of an independent group of international computer-system vendors to worldwide development of a standards-based, open-systems philosophy based on the Unix system. \$125.

X/Open Company Ltd, 1750 Montgomery St, San Francisco, CA 94111.

INQUIRE DIRECT

Instructions for using the 030

The user's manual for the MC68030, a member of the vendor's MC68000 software-compatible μ P family, is

now available. It describes the microprocessor's operating and programming capabilities. Information in some of its 14 sections covers data organization and addressing capabilities, processing states, the instruction set, and instruction-execution timing. The appendix summarizes the MC68000 family. \$6 plus 15% shipping and handling.

Motorola Inc, Literature Distribution Center, Box 20924, Phoenix, AZ 85036.

INQUIRE DIRECT

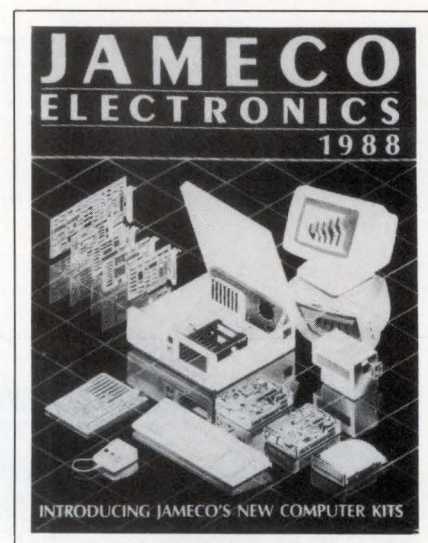

Listing of computer/electronic products

The vendor's 1988 illustrated catalog lists more than 5000 items. The product lines feature a variety of items from computer kits and peripherals to integrated circuits. An 8-pg insert highlights IBM, Apple, Commodore, and Tandy computer peripherals. Also included is a 6-pg insert of pin-out data.

Jameco Electronics, 1355 Shoreway Rd, Belmont, CA 94002.

Circle No 526

Booklet documents board test methods

The 80-pg booklet *HP 3065 Board Test Family* covers three in-circuit and two combinational board test systems. Divided into six sections, it presents an overview of family products; family software; sections

VF Technology... The Bright Decision

Futaba, a world leading manufacturer of vacuum fluorescent displays, offers a wide assortment of *display tubes* in many sizes and formats. Also, Futaba offers *display modules* with all the electronics required to refresh the display and easily interface with the host system.

GRAPHIC DISPLAY

Both front glass phosphor, which provides maximum viewing angle and uniform surface appearance, and conventional back glass phosphor, with optimum brightness and software dimming capabilities, are available. All Futaba graphics modules offer complete drive electronics, bit mapped control with a DC/DC converter. All active components are surface mounted onto a single board.

DOT MATRIX MODULES

Utilizing Futaba's dot matrix displays, a completely intelligent line of "dot modules" is available. Each includes all drive, power supply and microprocessor components surface mounted onto a single board. Surface mounted technology results in higher reliability and allows for a smaller overall package and lower cost. All dot modules require only a 5V DC power source and can accept parallel or 8 possible serial baud rates.

GRAPHIC DISPLAYS/MODULES

Futaba Display	Futaba Module	Pixels (Row X Char.)	Brightness (FT-L)	Module Dimensions (in.)
GP1005B	GP1005B03	128X64	400	7.28X3.35X1.77
GP1006B	GP1006B04	256X64	200	9.84X3.35X1.77
GP1009B	GP1009B03	240X64	200	6.2X2.76X1.57
GP1010B	GP1010B01	176X16	200	7.32X2.16X1.70
GP1002C	GP1002C02	320X240	100*	7.10X6.30X1.60
GP1004B	GP1004B03	640X400	30	9.65X7.28X1.85

*Different Versions Available

DOT MATRIX DISPLAYS/MODULES

Futaba Display	Futaba Module	Char. X Row	Dot Format	Char. Ht. (in.)	Module Dimensions (in.)
20SD01Z	M20SD01	20X1	5X7	0.200	6.3X1.97X.75
20SD42Z	M20SD42	20X1	5X12	0.344	7.1X2.16X.88
40SD02Z	M40SD02	40X1	5X7	0.200	9.45X2.16X.88
40SD42Z	M40SD42	40X1	5X12	0.344	9.45X2.16X.88
202SD03Z	M202SD03	20X2	5X7	0.200	6.7X2.56X.90
402SD04Z	M402SD04	40X2	5X7	0.200	10.43X2.56X.90

MANY OTHER DISPLAYS

NEW MODULES AVAILABLE SOON



FUTABA
Corporation of America
Electronic Components Division

711 E. State Parkway
Schaumburg, IL 60173

Telephone: (312) 884-1612
or (312) 884-1444

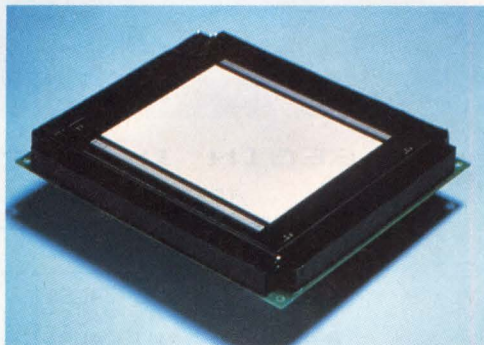
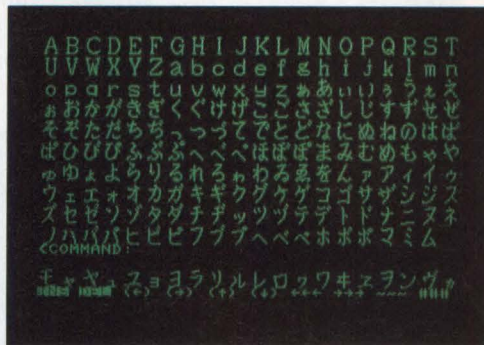
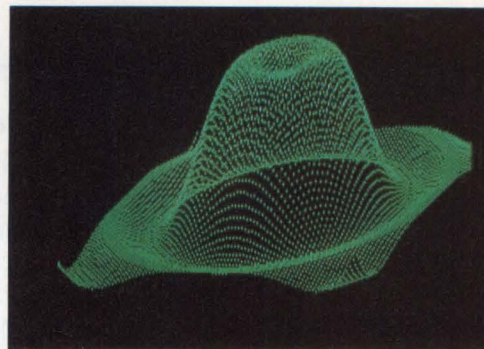

Compact, flat panel graphic displays and modules present clean, sharp images, whether for text or full graphics application.



2 x 40 character (display)

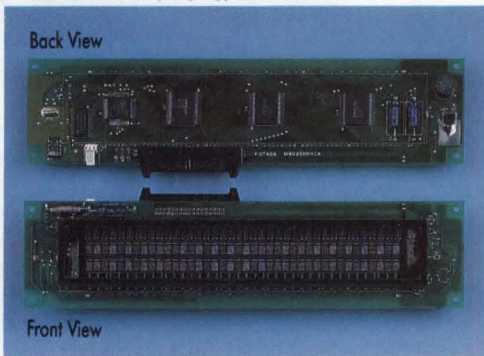

2 x 40 character (module)

Pattern flexibility and pleasing appearance are offered by Futaba in dot displays and modules.



Futaba also offers a complete catalog of alphanumeric, segmented displays.

Futaba supports its products with design engineering and system integration assistance. Call or write today.

on analog, digital, and mixed-signal test methods and specifications; and general information. Within the text, special symbols indicate supplemental characteristics that provide information you can use in applying or appraising a system.

Hewlett-Packard, 1820 Embarcadero Rd, Palo Alto, CA 94303.

Circle No 527

Computer printers displayed

This fold-out brochure illustrates the vendor's full line of computer printers that are suitable for business, scientific, or personal applications. Besides listing the printing speeds, performance capabilities, and special features of each printer type, it presents the options, accessories, and supplies that are avail-

able.

Seikosha America Inc, 1111 MacArthur Blvd, Mahwah, NJ 07430.

Circle No 528

Examine our fine print.

BEGIN IN-CIRCUIT TEST

TEST BOARD P/N 1-110-2349

WINDOW	IC	PIN
10us	U3 74LS11	03 IN
10us	U3 74LS11	13 OUT
09us	U3 74LS11	05 IN
10us	U4 74LS02	12 OUT
09us	U7 74LS06	04 IN
09us		



Fine printing is more than fine print. It is the ability to deliver superior quality hardcopy time after time. And, just as important, the reliability of the company that stands behind its product.

Memodyne has a fine printing solution for every OEM or end user requirement. Ultra-quiet, high speed thermal printers. Consistent, sharp hardcopy output from first line to 4 millionth. With thoughtful innovations like auto last line visibility, self test, intelligent interfaces and more. Plus intelligent engineering response, up front assistance and exceptional turnaround to insure meeting *any* production schedule, in *any* volume.

Examine our fine print in your application. Evaluation units are available to qualified prospects. Memodyne Corporation, 200 Reservoir Street, Needham, MA 02194.

MEMODYNE

A family of fine printers.

TEL: (617) 444-7000 TELEX: 510-600-8774 FAX: (617) 444-7023

Memodyne is a Computer Products company.

CIRCLE NO 204

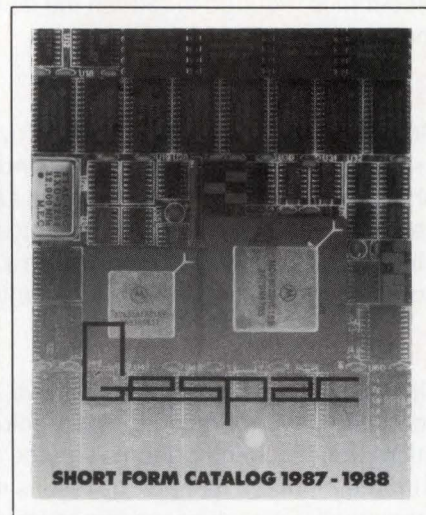

G-64 bus products categorized

The vendor's Short Form Catalog 1987-1988 covers more than 100 board-level products, as well as the complete line of systems and software tools, operating systems, and high-level languages. Special features and suggested applications for the G-64 bus complete the brochure.

Gespac Inc, 50 W Hoover Ave, Mesa, AZ 85202.

Circle No 529

Software system provides manufacturing solutions

Presenting Max, The Production Manager, a microcomputer-based software system for manufacturing control, this 6-pg brochure examines the system's features and advantages. A floppy disk entitled *AutoMax* explains the benefits and features of Max and the microcomputer MRP II, and is available to anyone interested in the vendor's products.

Micro-MRP Inc, Century Plaza I, 1st Floor, 1065 E Hillsdale Blvd, Foster City, CA 94404.

Circle No 530

EDN NEWS

Combining EDN Product News and EDN Career News

EDN NEWS

News of Products, Technology and Careers for Engineers and Engineering Managers

Memory Boost by Mid-1990
IBM predicts a boost in add-in memory.

National Supplies Chips to Open
A 32-bit processor, more than 100K.

Military Gate Arrays
Detailed evaluation offers 100K+ like performance.

Low-Cost Spectrum Analyzer
A 100- and 200-MHz full-system capability.

Reflectometer
Insulate LAN Ports
A new way to boost performance.

EE Education Gets a Boost in New Jersey
New Jersey universities benefit, a half of total.

NEWSBRIEFS

Agreement
Intel, IBM, and AMD announce a new agreement to provide 386 and 486 processors to IBM PC compatibles. Page 2

Display
New video requirements at the end of 1988 will require 1024x768 resolution. IBM and Intel will be the first to offer 1024x768 resolution. Page 2

MIL Standards
20, 30, and 40-pin MIL-STD-883C test methods for 100K and 1Mbit DRAMs. Page 3

Custom Software
General Software Systems has developed a new software package, CALK, for 486 and 386 PCs. Page 3

Design Center
Microelectronics '88 is the largest of its kind in the world. It will be held in San Francisco, California, on May 1-3. Page 3

Price Cuts
Microelectronics '88 is the largest of its kind in the world. It will be held in San Francisco, California, on May 1-3. Page 3

Vendor Capital
A new venture capital firm has been formed to provide financing for high-tech companies. Page 3

INSIDE

PRODUCT FEATURES
Signal Processing Board Gets Upgrade. Page 3

TECHNOLOGY UPDATES
Power MOSFETs. Page 3

DSP Board Fits IBM PC

Power MOSFET Makers Boost Electrical Specs

The Times

HOT NEWS OF PRODUCTS, TECHNOLOGY, AND CAREERS

MM P/REL™

Encoded Rotary Switch

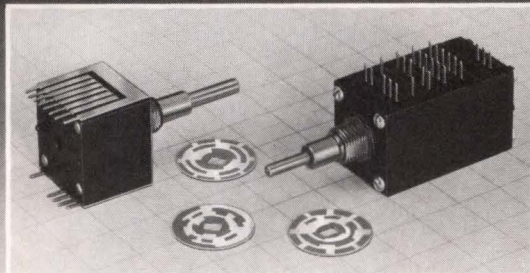

- The leader in digital rotary switching now brings you:
- Just .865" square
 - Enclosed, wave solderable construction
 - Fixed or adjustable stops available
 - 50,000 cycles
 - Programmable to customer truth table
- Call or write for applications assistance.

STANDARD GRIGSBY

920 Rathbone Avenue/P.O. Box 1528 • Aurora, Illinois 60507 USA
312 844-4300 • TWX 910 232-3138

CIRCLE NO 205

5 nsec rise & fall times from the Crystalmaster

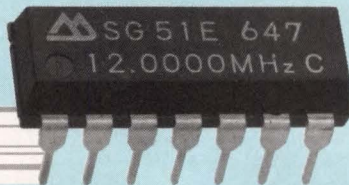

HIGH SPEED, AUTO INSERTABLE, CMOS

PLASTIC DIP OSCILLATOR!

The new EPSON SG-51 Series plastic DIP CMOS crystal oscillator has typical 5 nsec rise and fall times. And it occupies about half the board space of the metal can oscillator it replaces. Both versions of the SG-51, 4-pin and 14-pin, are auto insertable using standard DIP equipment, and the 4-pin fits the same hole pattern as metal can types. With tri-state output, low power consumption, high speed and now 4-pin or 14-pin plastic DIP... the Crystalmaster is first again!

OUTPUT FREQUENCIES

20.0000 MHz	12.0000 MHz	6.1440 MHz	3.0720 MHz
19.6608 MHz	10.0000 MHz	6.0000 MHz	2.5000 MHz
18.4320 MHz	9.8304 MHz	5.0000 MHz	2.4576 MHz
16.0000 MHz	9.2160 MHz	4.9152 MHz	
12.2880 MHz	8.0000 MHz	4.0000 MHz	

SPECIFICATIONS

CMOS Crystal Oscillator SG-51 Series
 Input Voltage: 5V ± 0.5V
 Access Time: 8 nsec MAX, 5 nsec TYP
 Frequency Stability: C = ±100 ppm
 Duty: 40/60 to 60/40% at 1/2V_{DD} or 1.4V level
 Current Consumption: 18mA MAX, 10 mA TYP at 12 MHz
 Output Load: 10 TTL gates

Call us now for detailed information

EPSON®

EPSON AMERICA, INC.
 OEM Division
 Component Sales Department
 3415 Kashiwa St., Torrance, CA 90505

Telephone (213) 534-4500 • TELEX 664277 • FAX (213) 539-6423

Best performance in a supporting role.



And the winner is... Carlingswitch. For any application.

Our full line of innovative switches (full-size and miniature) and high-performance circuit breakers includes some of the biggest stars in the business: Curvette,[®] Curvette SC,[™] Tippette,[®] VisiRocker,[®] Lockette[™] and Rotette[™]...all internationally approvable.

And for behind-the-scenes technology and know-how, Carlingswitch wins again – with CAD/CAM engineering, computerized integrated manufacturing

and Statistical Process Control to maintain rigid standards of quality. Plus, there's the special expertise that only comes with experience... and we've been supporting great ideas since 1920. Let Carlingswitch help make your next production a big hit.

For more information on our full line of top performers, call toll free: 1-800-243-8160. Or write: Carlingswitch, Inc., 60 Johnson Avenue, Plainville, CT 06062-1165. (203) 793-9281. TELEX: 710-425-0034. FAX: (203) 793-9231.

CARLINGSWITCH
INNOVATION BY DESIGN

CIRCLE NO 207

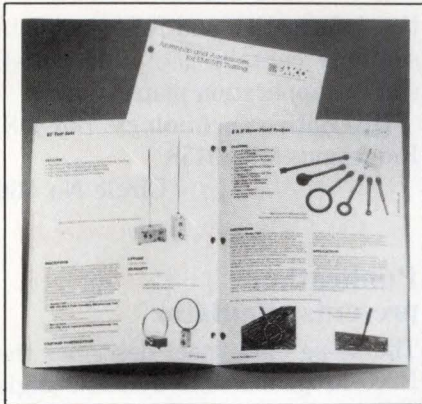

Antennas and accessories

The vendor's 1988 catalog of antennas and accessories for EMI/RFI testing and a 20x30-in. 1988 calendar with a product- and antenna-selection guide on the back are available. In addition to product information, the catalog features FCC and VDE regulations, tables that help you make a selection, and a list of formulas.

EMCO, Box 1546, Austin, TX 78767.

Circle No 531

App note helps you calibrate DP transmitters

Application Bulletin P-80 tells you how to calibrate differential-pressure (DP) transmitters on site, thus eliminating the task of having to remove the DP cells and take them back to the shop for calibration. It also describes three calibration devices and provides illustrations.

Rochester Instrument Systems Inc., Test & Calibration Products, 255 N Union St, Rochester, NY 14605.

Circle No 532

Guide for selecting printer/plotter

The 8-pg brochure *Selecting the right narrow format printer/plotter for your hard copy needs* helps you choose a narrow-format electrostatic or a thermal-transfer printer or plotter, and it describes both monochrome and color devices. The publication considers the advantages of

electrostatic and thermal-transfer plotting for producing narrow-format hard copy. Also included is information about the V-80, Spectrum, and Versacolor plotters. A product table compares the specifications of the three plotters.

Versatec, 2710 Walsh Ave, Santa Clara, CA 95051.

Circle No 533

Guide to multiuser system

The *Multiuser Reference Guide* helps you turn an IBM PC/XT, PC/AT, or a compatible computer into a host/file server for a multiuser system. The publication explains different DOS-compatible, multiuser technologies, such as time-slicing, multiprocessing, and LAN-based solutions. Another section

**BYTEK'S
135 MULTIPROGRAMMER™
WITH 18/12 PROTECTION PLAN**



Model 135-E: **\$995.00***

See us at Electro '88 in Boston Booth 2954

THREE PROGRAMMERS IN ONE:

The 135 is a SET (E)EPROM Programmer, GANG (E)EPROM Duplicator, & UNIVERSAL Device Programmer for Engineering Development, Production, & Field Service Environments. SETS of Devices, 16 & 32-bit wide, can be downloaded into RAM via the RS232 port. As a GANG Duplicator, up to 8 (E)EPROMs can be copied at one time (16 (E)EPROMs optional).

BYTEK'S 18/12 PROTECTION PLAN:

BYTEK is the first to offer an 18-Month WARRANTY & 12-Month FREE Device Support Updates.



BYTEK Corporation
Instrument Systems Division
1021 S. Rogers Circle, Boca Raton, FL 33487
Tel: (407) 994-3520 FAX: (407) 994-3615

* U.S. Price ** Data I/O & PROMlink are Registered Trademarks of Data I/O Corporation. (Some limitations may apply.)

VERSATILITY: BYTEK's 135 programs virtually all 24, 28, & 32-pin (E)EPROMs from 16K to MegaBit Devices.

RAM CAPACITY: With standard 256K X 8 RAM, expandable to 2MByte, the 135 supports more devices than any other production programmer.

FLEXIBILITY: The 135 can easily be expanded to program 40-pin EPROMs, Bipolar PROMs, 40-pin Micros, & PLD/EPLD/GAL/FPLA Devices.

COMPATIBILITY: The 135 is both Date I/O** PROMlink™ & Computer Remote Control compatible.

1-800-523-1565
In Florida: 1-407-994-3520

BYTEK International
511 11th Avenue So., Minneapolis, MN 55415
Tel: (612) 375-9517 FAX: (612) 375-9460
Telex: 4998369 BYTEK

NEW CONNECTORS FAMILY REFERENCE 202.400

Wire insert and tighten on the same plane. Screw, wire and screwdriver are in the same plane when you use the new technology in pluggable connectors by LMI.

Ease of operation (user friendly), low profile and thread protection (.118" O screws) are but a few of the customer benefits.

Now available from stock are male connectors, (open) or closed header ends), 2 to 20 positions, 0.2" (5.08mm) centers, female connectors, 10 Amp, 300 volts.

Please contact us for additional information *free* samples and a visit from one of our experienced Field Sales Engineers.

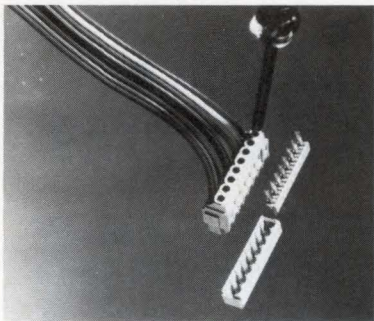

NEW CONNECTOR TYPE 302.432

Less P.C.B. Real Estate Required!

with LMI's new technology, low cost, compact 32 position screw connectors. Other features: new clamping device with screw and wire insertion on the same plane, .118" (3 mm) O screws protecting threads, 0.2" (5.08 mm) centers, 6 Amps, 300 volts.

Please contact us for additional technical data, free samples or to request a visit from a field sales engineer.

Call us today so you may begin to enjoy the benefits of leading edge technology connection.

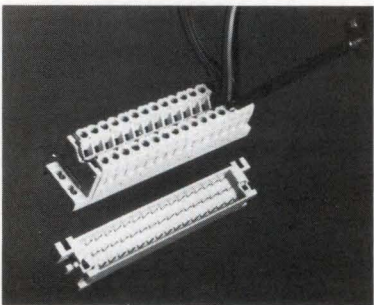

LMI Connectors, Inc.
6290 Sunset Blvd., Ste 1126
Los Angeles, CA 90028
Tel: (213) 463-2295
Fax: (213) 463-4319

See us at Electro Booth 1680

CIRCLE NO 209

LITERATURE

tells you how to convert a personal computer into a multiuser system to use with non-DOS operating systems, such as Xenix, Concurrent DOS, or Pick.

Kimtron Corp, 1709 Junction Ct, Bldg #380, San Jose, CA 95112.

Circle No 534

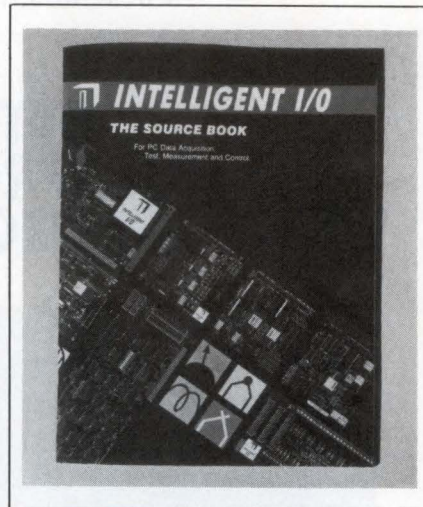

Brochure covers data-acquisition systems

The Source Book, a combination catalog/handbook assists you in configuring customized personal-computer data-acquisition systems. It features carrier boards, instrument modules, termination panels, accessories, and the vendor's software, as well as software from other companies for data-acquisition systems. It also details IQ Paks, the vendor's PC data-acquisition start-up systems. Ordering information, conditions of sale, and an indexed price list complete the publication.

Intelligent I/O, 1141 W Grant Rd, #131, Tucson, AZ 85705.

Circle No 535

System components and reference data categorized

This 80-pg, pocket-sized catalog lists versions of the PC bus, Multi-bus, VME Bus, and Q Bus, as well as computers that are 100% compatible with IBM PCs. It provides descriptions and specifications for each product. Further, the applica-

tion-information and reference-data sections contain useful features, such as application maps.

Diversified Technology, Box 748, Ridgeland, MS 39158.

Circle No 536

Publication presents simulator

The 20-pg data sheet describes the L200 programmable dynamic-angle synchro/resolver simulator. It discusses simulation in detail, as well as the use of built-in instruments, programming, and applications. Specifications, and numerous illustrations and diagrams complete the pamphlet.

Natel Engineering Co Inc, 4550 Runway St, Simi Valley, CA 93063.

Circle No 537

Amperex
A NORTH AVONDALE INDUSTRIES COMPANY

Leadless Chip Carrier Program

Amperex has extensive experience in packaging virtually every kind of active micro-miniature device in its LID and SOT packages. We also extend our services to the packaging and testing of semiconductor chips in Leadless Hermetic Chip Carriers for HIR applications. Everything from basic packaging to fully screened/MIL processing is available.

Amperex will package chips furnished or specified by you, or will procure the chips from one of our approved sources. Packages may also be customer-furnished.

<p>Packages Available</p> <p>Standard JEDEC outlines, Leadless, 18 to 64 pins on 0.140" or 0.100" centers (0.042" standard).</p> <p>Manufacturing</p> <p>Die attach - eutectic Wire bonding - Thermosonic using gold wire. Cover attach - parallel seam welding or brazed seal in pure nitrogen.</p> <p>Electrical Testing</p> <p>Functional and/or parametric depending on device type, using Teradyne, Advantest, and Hewlett Packard equipment.</p>	<p>Quality Conformance Testing</p> <p>SEM Control Gross and Fine Leak Humidity Constant Acceleration Mechanical Shock Vibration Operating Life High Temperature Storage Salt Spray Temperature Cycling Thermal Shock Internal Visual and Mechanical (die shear, bond strength)</p>
---	---

Folder outlines LCC program

This 4-pg pamphlet outlines the vendor's leadless chip-carrier program. It lists the packages available, manufacturing methods, and types of electrical and quality-conformance testing. In addition to the manufacturing flow chart, it provides dimensional drawings for center-line chip carriers and explains the distinguishing features of the LCC types.

Amperex Electronic Corp, Providence Pike, Slatersville, RI 02876.

Circle No 538

Trimmer Capacitors from HF through Microwave.



The World's Broadest Line.

For high quality and ready availability,
phone (516) 746-1385 today.



Sprague-Goodman Electronics, Inc./An Affiliate of the Sprague Electric Company
134 FULTON AVENUE, GARDEN CITY PARK, NY 11040-5395
TEL: 516-746-1385 • TELEX 14-4533 • TWX: 510-600-2415 • FAX: 516-746-1396

CIRCLE NO 210

Cut Costs 50% on Electronic Chassis and Enclosures



Use Steel Wire
construction . . .
one source does it all

- R & D
- prototyping
- in-house tooling
- short runs
- low- or high-vol. production
- in-house finishing
- defect-free performance
- just-in-time delivery

Send for FREE Design Guide

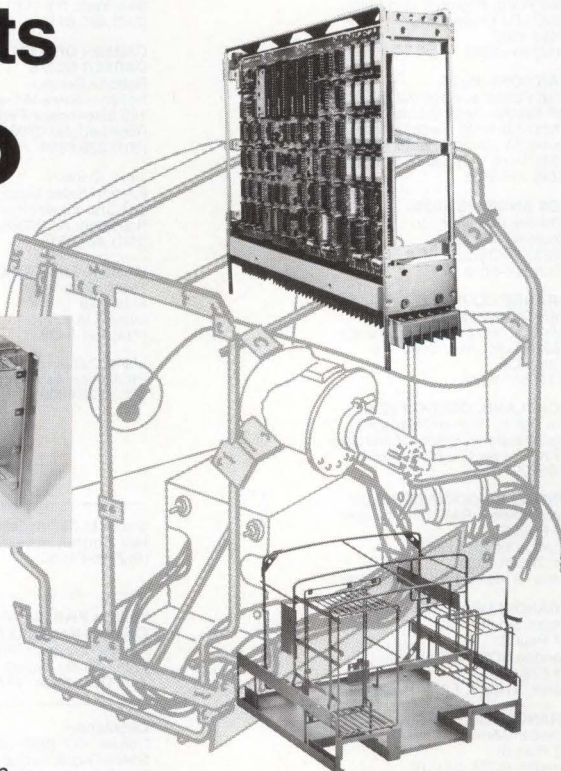

TITCHENER E.H. Titchener & Co.
28 Titchener Place
P.O. Box 1706
Binghamton, NY 13902
Phone 607-772-1161
FAX 607-771-0264

CIRCLE NO 211

Carborundum® noninductive ceramic power resistors solve tough problems.

We make three types of noninductive ceramic resistors that can solve tough resistance problems, save money and space.

Energy Absorption

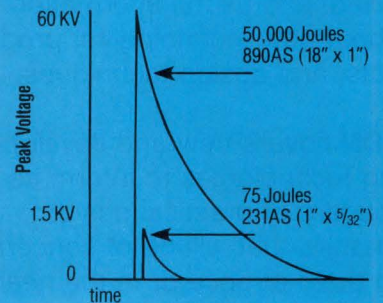

Power Absorption

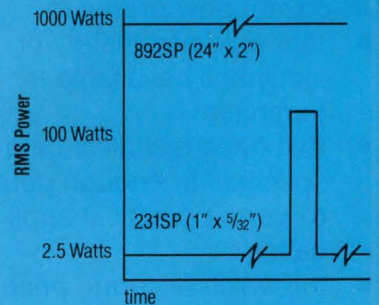

Regardless of the pulse shape, we have the resistor. Our Type SP handles large amounts of power from 60 cycles through VHF. Type AS can absorb huge amounts of energy in millisecond pulses. Type A solves high resistance problems in high voltage situations.

For more information on ceramic power resistors and our broad line of thermistors and varistors, call or write today.

Standard Oil
Engineered Materials Company
Electronic Ceramics Division
P.O. Box 339
Niagara Falls, New York 14302
716 278-2553

STANDARD OIL
ENGINEERED MATERIALS

CARBORUNDUM® ELECTRONIC
COMPONENTS

CIRCLE NO 212

EDN's CHARTER

EDN is written for professionals in the electronics industry who design, or manage the design of, products ranging from circuits to systems.

EDN provides accurate, detailed, and useful information about new technologies, products, and design techniques.

EDN covers new and developing technologies to inform its readers of practical design matters that will be of concern to them at once or in the near future.

EDN covers new products

- that are immediately or imminently available for purchase
- that have technical data specified in enough detail to permit practical application
- for which accurate price information is available.

EDN provides specific "how to" design information that our readers can use immediately. From time to time, EDN's technical editors undertake special "hands-on" projects that demonstrate our commitment to readers' needs for useful information.

EDN is written by engineers for engineers.

EDN

275 Washington St
Newton, MA 02158
(617) 964-3030

F Warren Dickson
Vice President/Publisher
Newton, MA 02158
(617) 964-3030
Telex 940573
Diann Siegel, Assistant

Peter D Coley
VP/Associate Publisher/
Advertising Sales Director
Newton, MA 02158
(617) 964-3030
Ora Dunbar, Assistant/Sales Coordinator

NEW ENGLAND
John Bartlett, Regional Manager
Chris Platt, Regional Manager
199 Wells Ave
Newton, MA 02159
(617) 964-3730

STAMFORD 06904
George Isbell, Regional Manager
8 Stamford Forum, Box 10277
(203) 328-2580

NEW YORK, NY 10011
Daniel J Rowland, Regional Manager
249 West 17th St
New York, NY 10011
(212)463-6419

PHILADELPHIA AREA
Steve Farkas, Regional Manager
487 Devon Park Dr
Suite 206
Wayne, PA 19087
(215) 293-1212

CHICAGO AREA
Clayton Ryder, Regional Manager
Randolph D King, Regional Manager
Cahners Plaza
1350 E Touhy Ave, Box 5080
Des Plaines, IL 60017
(312) 635-8800

DENVER 80206
John Huff, Regional Manager
44 Cook St
(303) 388-4511

DALLAS 75243
Don Ward, Regional Manager
9330 LBJ Freeway
Suite 1060
(214) 644-3683

SAN JOSE 95128
Walt Patstone, Regional Manager
Bill Klanke, Regional Manager
Philip J Branon, Regional Manager
James W Graham, Regional Manager
3031 Tisch Way, Suite 100
(408) 243-8838

LOS ANGELES 90064
Charles J Stillman, Jr
Regional Manager
12233 W Olympic Blvd
(213) 826-5818

**ORANGE COUNTY/
SAN DIEGO 92715**
Jim McErlean, Regional Manager
18818 Teller Ave, Suite 170
Irvine, CA
(714) 851-9422

PORTLAND, OREGON 97221
Pat Dakin, Regional Manager
Walt Patstone, Regional Manager
1750 SW Skyline Blvd, Box 6
(503) 297-3382

UNITED KINGDOM/BENELUX
Jan Dawson, Regional Manager
27 Paul St
London EC2A 4JU UK
44 01-628 7030
Telex: 914911; FAX: 01-628 5984

SCANDINAVIA
Stuart Smith
27 Paul St
London EC2A 4JU UK
01-628 7030
Telex: 914911; FAX: 01-628 5984

FRANCE/ITALY/SPAIN
Alasdair Melville
27 Paul St
London EC2A 4JU UK
01-628 7030
Telex: 914911; FAX: 01-628 5984

WEST GERMANY/SWITZERLAND/AUSTRIA
Wolfgang Richter
Sudring 53
7240 Horb/Neckar
West Germany
49-7451-7828; TX: 765450

ISRAEL
Igal Elan
Elan Marketing Group
13 Haifa St, Box 33439
Tel-Aviv, Israel
Tel: 972-3-268020
TX: 341667

EASTERN BLOC
Uwe Kretzschmar
27 Paul St
London EC2A 4JU UK
01-628 7030
Telex: 914911; FAX: 01-628 5984

FAR EAST
Ed Schrader, General Manager
18818 Teller Ave, Suite 170
Irvine, CA 92715
(714) 851-9422; Telex: 183653

TOKYO 160
Kaoru Hara
Dynaco International Inc
Suite 1003, Sun-Palace Shinjuku
8-12-1 Nishishinjuku, Shinjuku-ku
Tokyo 160, Japan
Tel: (03) 366-8301
Telex: J2322609 DYNACO

TAIWAN
Acteam International
Marketing Corp
6F, No 43, Lane 13
Kwang Fu South Rd
Mailing Box 18-91
Taipei, Taiwan ROC
760-6209 or 760-6210
Telex: 29809
FAX: (02) 7604784

KOREA
BK International
Won Chang Bldg, 3rd Floor 26-3
Yoido-dong, Youngdungpo-ku
Seoul 150, Korea
Tel: 785-6665
Fax: 784-1915
Telex: K32487 BIZKOR

PRODUCT MART
Joanne Dorian, Manager
249 West 17th St
New York, NY 10011
(212) 463-6415

**CAREER OPPORTUNITIES/
CAREER NEWS**
Roberta Renard
National Sales Manager
103 Eisenhower Parkway
Roseland, NJ 07068
(201) 228-8602

Janet O Penn
Eastern Sales Manager
103 Eisenhower Parkway
Roseland, NJ 07068
(201) 228-8610

Western Sales Manager
18818 Teller Ave
Suite 170
Irvine, CA 92715
(714) 851-9422

Maria Cubas
Production Assistant
(201) 228-8608

Susan M Campanella, Advertising/Contracts Coordinator
Nan Coulter, Advertising/Contracts Coordinator
(617) 964-3030

**William Platt, Sr, Vice President, Reed Publishing USA
Cahners Magazine Division**
Terry McDermott, President, Cahners Publishing Co
Frank Sibley, Group Vice President, Electronics/Computers
Tom Dellamaria, VP/Production & Manufacturing

Circulation
Denver, CO: (303) 388-4511
Sherri Gronli, Group Manager
Eric Schmierer, Manager

Reprints of EDN articles are available on a custom printing basis at reasonable prices in quantities of 500 or more. For an exact quote, contact Joanne R Westphal, Cahners Reprint Service, Cahners Plaza, 1350 E Touhy Ave, Box 5080, Des Plaines, IL 60018. Phone (312) 635-8800.

THE FORCE IN ELECTRONIC CIRCUIT DESIGN



4 Day Conference June 13-16, 1988 ▲ 3 Day Exhibition June 14-16, 1988
Bayside Exposition Center, Boston Massachusetts

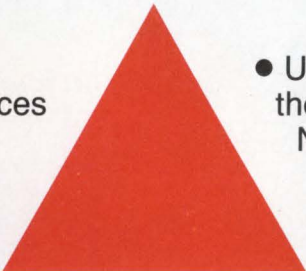

Earth ▲ Water ▲ Air ▲ Fire
Life depends on these invincible forces of nature.

NEPCON East is the Force behind your progress in the fast-changing electronics manufacturing industry. It's a circuit design show, a systems packaging show, a production show, and a test show all in one. Investigate new technology and applications in your engineering specialty and gain knowledge in all phases of the product development cycle.

Featuring:

▲ Over 400 companies displaying and demonstrating equipment, components, materials, devices, and technology for producing electronic products.

● User-oriented Conference covering the latest in Surface Mount Technology, No-Clean Fluxes, Design for Manufacturability, Just-in-Time, Superconductivity, and more—31 sessions in all!

■ Roundtable discussion—"Keeping America Competitive"—free to all registered NEPCON visitors (Tuesday, June 14, 5:00 p.m.)

Register now. SAVE \$15.00!

Complete and mail the Advance Registration Form below for free admission to NEPCON East '88 exhibits. Check the appropriate box to request complete Conference information, or call 312-299-9311.

PHOTOCOPY THIS FORM FOR COLLEAGUES WHO WISH TO ATTEND.

NEPCON East '88 Advance Registration Form

CONFERENCE JUNE 13-16, EXHIBITS JUNE 14-16

COMPLETE AND MAIL TO: Nepcon East '88, P.O. Box 7098, North Suburban, IL 60199-7098

MAILING DEADLINE: May 20, 1988. After May 20, 1988, do not mail. For free admission to exhibits only, bring complete form to a badge typist at the NEPCON registration center. (No one under 18 will be admitted) Separate forms will be available for on-site conference registration.

YOU MUST COMPLETE SECTIONS 1 THRU 5.

PLEASE PRINT IN BLACK INK.

1. General Information (Please print clearly) Mr. Ms. Mrs. Dr.

First Name	M.I.	Last Name
Job Title		
Company		
Division		
Mailing Address	Dept. or Mail Stop	
City	State	Zip
Country		
Telephone	Telex	

2. Job Category (Check only one)

- | | |
|---|---|
| A <input type="checkbox"/> Circuit/System Packaging | F <input type="checkbox"/> Corporate Management |
| B <input type="checkbox"/> Circuit/System Design | G <input type="checkbox"/> Sales |
| C <input type="checkbox"/> Production/Manufacturing | H <input type="checkbox"/> Research/Development |
| D <input type="checkbox"/> Quality Control, Test & Inspection | I <input type="checkbox"/> Other _____ |
| E <input type="checkbox"/> Purchasing | |

3. Business Category (Check only one)

- | | |
|--|---|
| A <input type="checkbox"/> Computers, Peripheral Equipment | H <input type="checkbox"/> Electronic Components and Sub-Assemblies |
| B <input type="checkbox"/> Office or Business Machine | I <input type="checkbox"/> Consumer Electronic Products |
| C <input type="checkbox"/> Communications, Systems/Equipment | J <input type="checkbox"/> Automotive Electronics or Appliances |
| D <input type="checkbox"/> Industrial Electronic Control Systems/Equipment | K <input type="checkbox"/> Independent Research, Test, Design |
| E <input type="checkbox"/> Medical Electronics | L <input type="checkbox"/> Contract Manufacturing |
| F <input type="checkbox"/> Aircraft, Missiles, Space, Military | M <input type="checkbox"/> Other _____ |
| G <input type="checkbox"/> Test and Measurement Equipment, Inst. | |

4. Number of Employees in Your Company (Check only one)

- A 1-99 B 100-499 C 500-999 D 1000-2999 E 3000+

5. I'm interested in the following product categories. (Check all that apply)

- | | |
|---|--|
| A <input type="checkbox"/> PC Design | D <input type="checkbox"/> Circuit Packaging |
| B <input type="checkbox"/> PC Board Fabrication | E <input type="checkbox"/> Inspection and Test |
| C <input type="checkbox"/> Circuit Assembly | |

Please send detailed information on the Nepcon Conference Program.

My company is interested in exhibiting at future NEPCON events.



B1

Expanding the Limits of Eyelet Technology

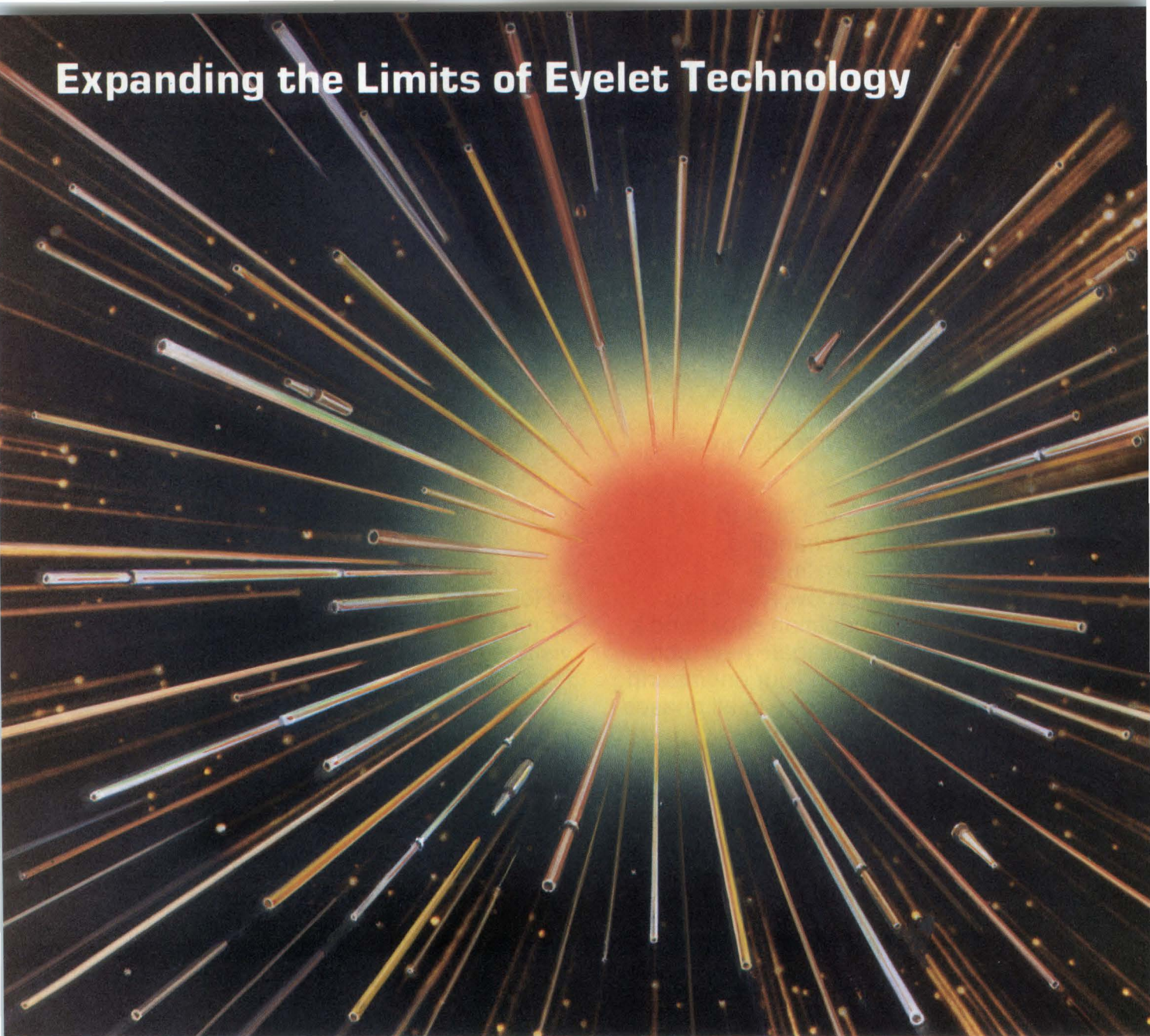

Miniature Deep Drawn Parts Exceed a 40 - 1 Length-to-Diameter Ratio



UTITEC, Inc.

169 Callender Rd., Watertown, CT 06795 • 203/945-0601
In Europe: UTI U.K. 983-404049 • Telex: 869441 UTIUK G

With the achievement of a better than 40 - 1 L/D ratio, Utitec brings you another breakthrough in mass-produced, deep drawn miniature tubular parts. This is one example of the strides being made in materials, production equipment and process technology to bring industry the highest quality, precision miniature parts at cost effective prices.

Parts are made to exacting specifications up to 2-1/2" in length with outside diameters as small as 0.020" from a wide selection of alloys. The added assurance of Manufacturing Resource Planning (MRP) and Statistical Process Control (SPC) is your guarantee of defect-free parts.

Explore your potentials with Utitec. Phone us at your convenience toll free at 1-800-321-6285.

Coaching turns engineers into public-speaking pros

Deborah Asbrand, *Associate Editor*



Bruce Richman is used to speaking before groups. Part of his job as section manager for Gould Semiconductor (Pocatello, ID) is to present monthly status reports to the division's upper management. After eight years of making the presentations, he rarely feels nervous. So when his employer asked him to attend a two-day class on public speaking, Richman thought he'd breeze through the class. He was wrong.

Among the classroom exercises was making a short videotaped presentation. That was the easy part. The hard part, he says, was watching the presentation played back. "I was very stiff; I looked like a stick," Richman sighs. "I wasn't Burt Reynolds."

Although engineering has the reputation of being well suited to individuals who prefer solitude, the demands of many engineering jobs are just the opposite. Not only do engineers need to communicate their ideas to other engineers, but they're also often required to explain projects to upper managers and sales representatives. In addition, many companies like to bring engineers along on sales calls, where they need to speak persuasively, as well as clearly, to potential customers. Many employers encourage engineers to keep a high industry profile by publishing articles in technical magazines and attending conferences.

Yet public-speaking opportunities can strike fear into the hearts of the most talented and confident people. "Fear of

public speaking comes right before fear of death," says Carla Echols of Echols and Pryor, the San Francisco, CA, consulting firm that coached Richman and six other Gould engineers. And even people who are comfortable in speaking before a group can use pointers on organization and presence. To help engineers conquer their anxieties, more companies are enrolling them in classes that soothe nerves, polish delivery, and add panache

"Fear of public speaking comes right before fear of death."



Tim Davis

Carla Echols, Echols & Pryor

More companies are enrolling engineers in classes that soothe nerves, polish delivery, and add panache to a person's speaking style.

to a person's speaking style. Perhaps even more important, engineers report that becoming convincing speakers can help their careers.

Echols identified specific problems with the typical engineering presentation and gave Richman and his colleagues pointers on how to avoid them. For example, the hallmark of any technical presentation is detail, but including too many particulars can mean sudden death for a speech. "As speakers, engineers get lost in the detail," says Echols, and instead of explaining to the audience the major themes of their work, engi-

neers often drown their viewers in slides, transparencies, and handouts. An equally common breed of speaker is the back-turner—the person who turns away from listeners and proceeds to read information on the viewing screen. "That's deadly," says Echols. "There's no need to read slides. The audience is perfectly capable of reading them." Furthermore, she adds, unreadable slides aren't worth including and usually signal a poorly prepared discussion.

Many untrained speakers forget their audience's needs. But keeping listeners in mind helps a speech in two ways. First, when a talk is put together with its audience in mind, the audience is more likely to grasp major points. Second, it relieves some of the pressure the speaker feels. "It's scary looking out at the audience and realizing you're the only one talking," says Echols. A speaker who considers the audience part of the presentation, however, often feels like part of a group effort rather than like a solo performer.

Playing to the house

Learning how to play to an audience, however, is easier said than done. An important step in achieving this ability comes from understanding how others perceive you, and the key tool most speech instructors rely on is the video camera. Watching a tape of yourself giving even a 2-minute talk can be unnerving. It's also eye-opening. Idiosyncracies that go unnoticed during casual conversation become glaring distractions before a group of people. Some people are in the habit of tapping one foot as they speak; others cram their shirt pockets full of pens and pencils, distracting the audience from their material.

Watching their recorded performances with the sound turned off, speech-class students see their flaws only too clearly. Richman, for example, had deliberately adopted a formal, serious mien when he spoke, believing such a persona would make him a more credible speaker. But when he viewed himself on tape, he discovered that he came

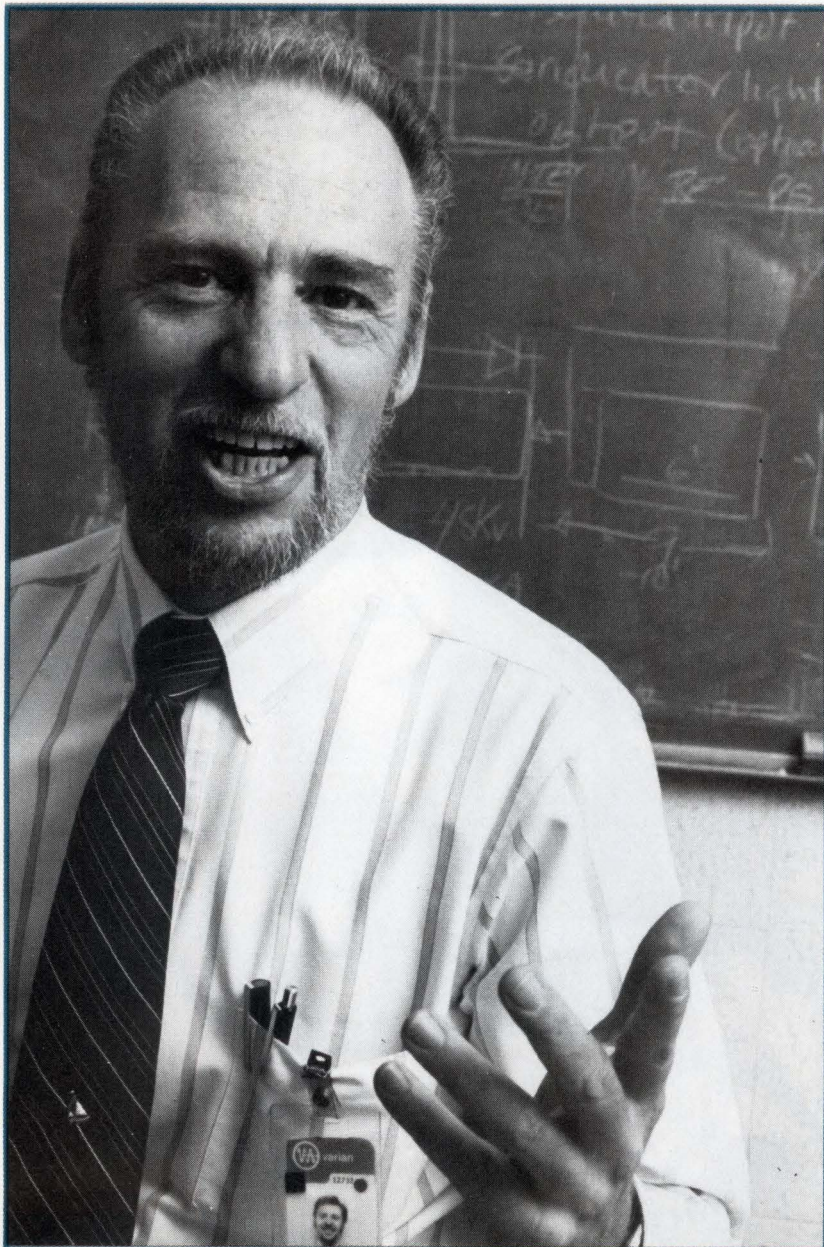

Tim Davis

Saul Gold, Varian Associates

You'll recognize us by the companies we keep.

ALLIED ELECTRONICS INC.

A SUBSIDIARY OF HALL-MARK ELECTRONICS CORP

Avavid
 ACS
 ADDS
 ADI
 Admiral Controls
 Adtech Power
 Advanced Semiconductor
 AIM
 Akro Mills
 Alcoswitch
 Allectron
 Allied
 Alpha
 American Beauty
 AMP - Special Products
 Ampere
 Amperite
 Ampex
 Amphanol
 AND
 Antex
 AP Products
 Argos
 Arrow Hart
 Artisan Electronics
 Atlas Sound
 A.W. Sperry
 Beau Products
 B & K Dynascan
 Bogen
 Bomar
 Bomax
 Bourns
 Brooks Mfg.
 Bud
 Bussman
 C & K/Unimax
 Cambridge
 Capar
 Centralab/Mepco
 C.H. Ellis
 CKE, Inc.
 Clarostat
 Comair Rotron
 Communication Instruments

Condor
 Coors Components, Inc.
 Corcom/Mallory
 Cornell-Dubilier
 Cramer
 CTS Berne
 CTS Metal Products
 Curtis Industries
 Cutler-Hammer
 David Clark
 D.A.T.A. BOOKS
 Dow Key Microwave
 Dremel
 Duracell
 Dynatech
 Eagle-Picher
 Edsyn
 E. F. Johnson
 EG & G Rotron
 Electroguard/Acme
 Electronic Protection Devices
 Electro-Therm
 EMCO
 Entelec
 Epsco
 ETI Systems
 Eveready
 Fanon Courier
 Fans S.
 Flambeau Products
 Fluke
 G.C. Electronics
 General Instrument Lamp Div.
 Gentron
 Global Specialties
 Grayhill/Waldom
 Greenlee
 Guardian Electric
 Hamlin
 Hammond Manufacturing
 Harris Semiconductor
 Harry Davies
 Hearst I.C. Master
 Heli-Tube

H. H. Smith
 Howard Industries
 Howard W. Sams
 Hurst Manufacturing
 ICS
 IDEC
 IEE
 Industrial Devices
 Industrial Timer
 Intermatic
 International Components Corp. (ICC)
 Iwatsu
 Jonard
 Kepro Circuit Systems
 Kester
 Keystone Carbon
 Keystone Electronics
 Klein Tools
 Knight Electronics
 Kulka Smith
 Leader
 Ledu
 Linemaster
 Littlefuse
 Lumberg
 Macromatic
 Magnecraft
 Mallory
 Master Appliance
 Maurey Instruments
 Mechanical Products
 Memcor
 Mepco/Centralab
 Mercer
 Micro Lamps
 Molex/Waldom
 Motorola
 Mueller Electric
 Multiflex Seals
 NEC Information Systems
 Neutrik

Newtone
 Nichicon
 NKK Switches
 Non-Linear
 NTT (National Tel-Tronics)
 OK Machine Tools
 Olympic Wire & Cable
 Omron
 PacTec/LaFrance
 Paladin
 Panamax
 Panasonic Batteries
 Panavise
 Papst/Pamotor
 Pelco
 Perma Power
 Phillips
 Plantronics
 Polycase
 Pomona
 Potter & Brumfield
 Power-Sonic
 Precision Monolithics (PMI)
 Quam Nichols
 Radio Shack
 Raytheon
 RCA
 RCA Tubes
 RCD
 Redington Counters Inc.
 Richardson Electronics
 Richco/Mallory
 Robinson Nugent

Rotron/Comair
 Rotron/EG & G
 Roxter
 Sanyo
 Semiconductor, Inc.
 Shure Brothers
 Shurite
 Siemens
 Sigma Instruments (see Magnecraft)
 Simpson
 Sola
 Soltec/PrimeLine
 Speco
 Sprague (Ico-Rally)
 Stackpole Electronics
 Staco
 Stancor
 Stewart Warner/Hobbs
 Struthers Dunn
 Superior Electric
 Switchcraft
 Sylvania/GTE
 Syrelec
 Talk-A-Phone
 Tapeswitch
 T & B Electronic Group
 T & B Static Control Products
 Tech-Spray
 Telex
 Test Probes
 Texas Instruments
 Thordarson/Meissner
 TIF Instruments

Topward
 Triad
 Triplett
 Triplite
 TRW Connectors
 TRW Motors
 TRW Optoelectronics
 Tyton Corporation
 Ungar
 Universal Data Systems
 Vaco
 Vactec
 Varo
 Vector Electronics
 Veeder-Root
 Viz
 VRN
 Wahl
 Waldom
 Walker/Plantronics
 Weller
 Wood (P & B)
 Xcelite
 Xicor

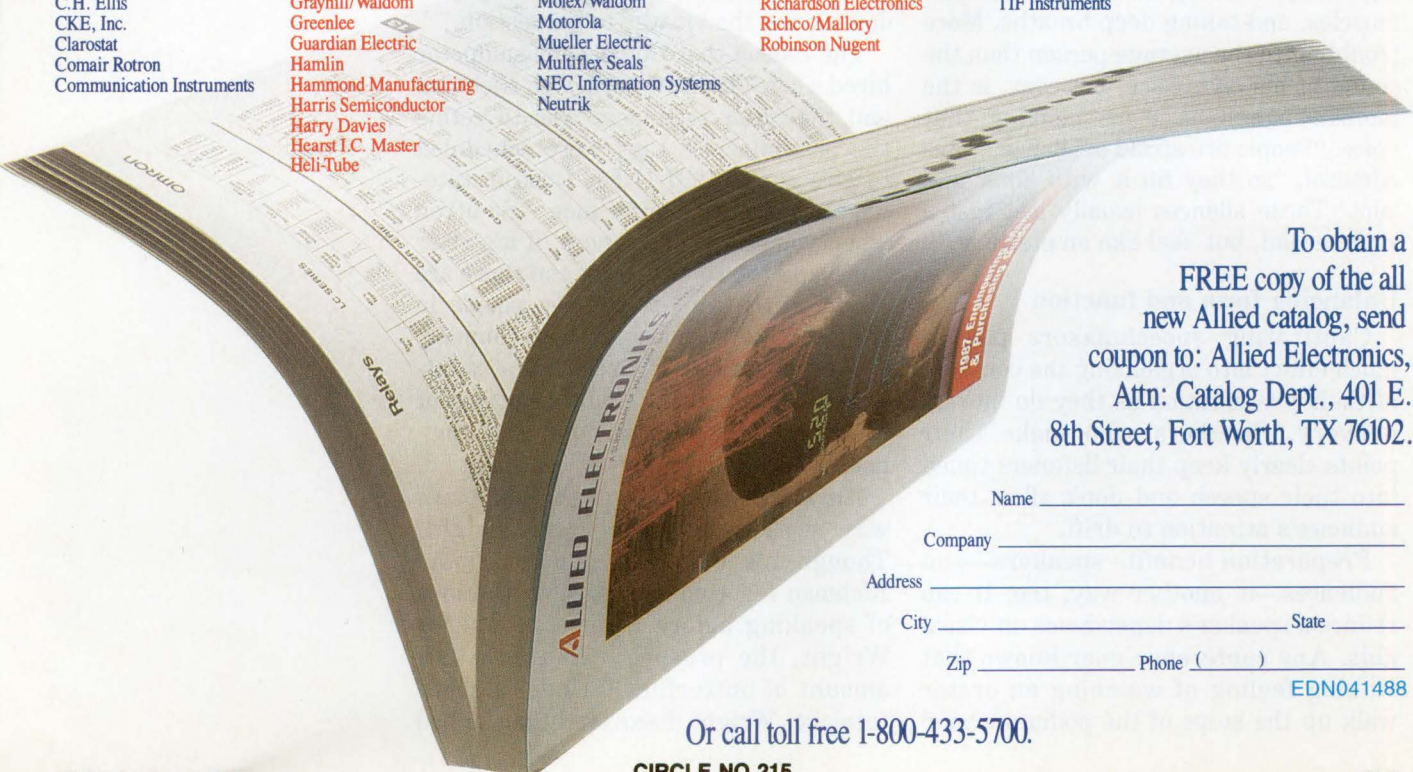

To obtain a
 FREE copy of the all
 new Allied catalog, send
 coupon to: Allied Electronics,
 Attn: Catalog Dept., 401 E.
 8th Street, Fort Worth, TX 76102.

Name _____

Company _____

Address _____

City _____ State _____

Zip _____ Phone (____) _____

EDN041488

Or call toll free 1-800-433-5700.

CIRCLE NO 215

across as wooden, rather than reliable. "I was too strait-laced, too formal," he says. In class he practiced incorporating his natural affability into his planned speech.

Indeed, students in speech classes rehearse not only relaxing but also hand gestures and smiling, as well as making smooth use of a pointer, slide projector, flip chart, or microphone. "Part of the art of speech preparation is the choreography," says Susan Almazol, a senior partner with Communications Training Consultants in Sunnyvale, CA.

Among the most difficult—and important—moves for people to master is eye contact. "You might make contact with 75% of the members of the audience, but you really need to cover 100% so that no members of the audience feel left out," says Saul Gold, who is manager of equipment engineering for Varian Associates Microwave Tube Div (Palo Alto, CA) and a graduate of one of Almazol's classes.

In addition to coordinating physical choreography, speakers need to limber up their vocal cords to prevent the strained voice that indicates a nervous speaker. Students in Echols' classes, for example, repeat the words "king kong" several times. They also practice yawning loudly, relaxing their neck and facial muscles, and taking deep breaths. More troubling to the average person than the sound of his own voice, however, is the moment when he stops hearing that voice. "People are afraid of silence," says Almazol, "so they fill it with 'ums' and 'ahs.' Those silences usually last just a split second, but feel like an eternity."

Balancing form and function

Captivating speechmakers put as much effort into organizing the contents of their presentation as they do into its delivery. Speakers who make their points clearly keep their listeners tuned into their speech and don't allow their audience's attention to drift.

Preparation benefits speakers—and audiences—in another way, too: It can reduce a speaker's dependence on visual aids. Any conference-goer knows that sinking feeling of watching an orator walk up the steps of the podium armed

with cartons of materials to be shown on the screen. "If you walk in with a box of 250 slides and a projector, you just lost half of your audience," says Tim Franey, manufacturing-engineering manager for GTE's Government Systems Corp in Mountain View, CA. Franey estimates he's attended a dozen conferences in his 22 years in engineering.

Though it's often unspoken, engineers' greatest fear about public speaking is that they'll be asked a question to which they don't know the answer. Despite many years of experience in talking in front of groups, Franey still dreaded being asked the unexpected question. An alumni of Almazol's class, he says that organizing the content of his technical presentations left him time to spend on anticipating audience queries. Franey also learned techniques to handle "that fellow in the audience who delights in harassing speakers. I say 'I'm glad you asked that question;' then I turn off the projector and spend a few moments discussing the point with the audience." By turning off the equipment, Franey says, he retains control over the session.

Richman employs a different approach. Speakers don't have to be know-it-alls, he says. "It's okay to say you don't know the answer to a question."

The reason that Gould Semiconductor hired a consultant to work with Richman and the other engineers was to refine the presentations they were scheduled to give at the 1987 IEEE Custom Integrated Circuits Conference. "So often when you go to conferences, if it's after lunch and the room is dark and there are slides on the screen, you see people in the last 10 rows snoozing," says company spokesperson Noelle Greene. Not wanting that fate to befall Gould's contingent of orators, the company put the engineers through two days of coaching.

Among those put through their paces was section manager John Wright. Though his coworker and classmate Richman felt comfortable with the idea of speaking before a large group, for Wright, the prospect "created a fair amount of butterflies." Under Echols' tutelage, Wright discovered that he had

Engineers' greatest fear is that they'll be asked a question to which they don't know the answer.



For transformers that are far out or down to earth, get MagneTek Triad wound up in your ideas.

The right match between application and transformer can make all the difference in the world. So at MagneTek Triad, we make thousands of standard off-the-shelf transformers, power supplies, power conversion and AC/DC designs.

If we don't have a standard unit that's

just right for your application, then we'll custom design a Better Coil transformer to your specific requirements.

Our commitment to you is — and always has been — to provide exactly the right transformer for your particular application. Our innovative engineers and designers, sophisticated manufacturing techniques

and rigorous quality control are all dedicated to that idea.

Get MagneTek Triad wound up in your ideas. For our Transformers, Inductors and Power Supplies catalog, write us at 1124 E. Franklin St., Huntington, IN 46750. Or call (219) 356-7100.

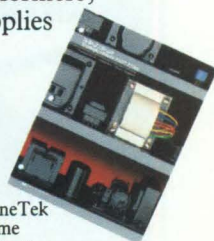

MagneTek
Triad

We're making MagneTek
the new first name
in electrical equipment.

CIRCLE NO 216

"A lot of decisions are made based on a presentation."

the habit—common to inexperienced speakers—of moving too quickly through his material: He finished a 20-minute exercise in her class in 10 minutes. To polish his presentations, he brushed up on eye-contact skills and practiced controlling a slide projector while holding a microphone.

His time slot at the conference—just before lunch on the program's third day—was far from ideal. The schedule gave him two long days to attend other presentations and ponder what his fate would be. "I didn't sleep very well the night before," he admits. Yet when he took the stage before the session's 200 attendees, armed with his notes and 30 slides, he felt relaxed and prepared.

Engineers who make regular presentations say that speech training also helps them to better convey their design needs to management. "A lot of decisions are made based on a presentation," says Richman. "How you present information and the confidence you show as you ask the company president for an-

other \$100,000 for equipment is going to help you a lot."

Such self-assurance can also help their careers. "It can be a real boost to getting your name known," says Gold. "When you sit in the background, it's a lot harder for people to become aware of your importance." Gold says that his willingness to speak before groups has opened opportunities to represent his division at corporate gatherings and gain a higher profile at the company.

The benefits of speech training apply equally to those with Gold's natural aptitude for public speaking and those who cringe at the thought of facing an audience. "You can't learn to be a brilliant speaker," says Echols, "but you can learn to be a well-organized, confident speaker whom the audience will respect for your technical expertise." **EDN**

Article Interest Quotient (Circle One)
High 494 Medium 495 Low 496

HIGH FREQUENCY low cost

The IH-150 is a small, lightweight, accurate non-contact current sensor for measurements up to 150 amps dc or ac peak, from dc to 200 kHz.

These Hall-effect units provide complete isolation, and do not impose a serious load on the measured circuit.

Request complete technical data today.

CURRENT SENSOR

Reads dc to 200 kHz

Features:

- High Frequency
- Reads dc to 200 kHz
- Low Cost
- Mounts on PC Board or Bulkhead
- Made in the U.S.A.

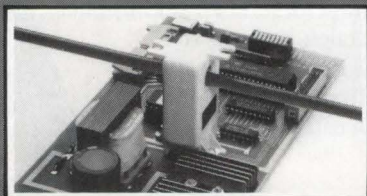

Board-mountable



Bulkhead-mountable



Model IH-150
Non-contact Current Sensor

F.W. BELL

6120 Hanging Moss Rd. Orlando FL 32807
Phone: 407-678-6900 TWX: 810-853-3115
FAX: 407-677-5765



“A career as an EDN editor offers you great variety and flexibility.”

EDN Editor David Shear

Just over a year ago, David Shear held an engineering position much like yours. Today, as an EDN editor, he is extending his engineering experience.

David is enthusiastic about his new career: “I’m acquiring a broader understanding of engineering than was possible as an engineer and the work is more varied. Also, the writing challenges me to translate my knowledge and experience into useful information for our readers.”

He also enjoys the recognition and visibility that come with being an EDN editor. As David says, “I cover developments, breakthroughs, new technologies, and product introductions across the entire spectrum of electronics. I’m at the forefront.”

You too can turn your electrical or electronic engineering background into an exciting opportunity with EDN. All you need are a B.S. in electrical engineering, at least two years of design experience, and an ability to write clearly. Salaries are commensurate with engineering experience.

If you’re interested, please call Toll Free 1-800-521-1127 x733 and ask for Michelle Clarke in Human Resources.

Or send your resume to her at Human Resources Dept., 275 Washington Street, Newton, MA 02158-1630. David Shear is glad he did. You will be too.

EDN

CAREER OPPORTUNITIES

1988 Editorial Calendar and Planning Guide

EDN

Editorial Emphasis

Issue Date	Recruitment Deadline	Editorial Emphasis	EDN News
May 12	Apr. 21	Analog Technology Special Issue, Analog Converters	Closing: Apr. 28 Mailing: May 19
May 26	May 5	CAE, Software, Sensors/Transducers	
June 9	May 19	CAE, Analog ICs, Test & Measurement	Closing: May 29 Mailing: June 16
June 23	June 2	Data Communications, DSP, Components	
July 7	June 14	Product Showcase—Vol. I, Power Sources, Software	Closing: June 23 Mailing: July 14
July 21	June 30	Product Showcase—Vol. II, CAE, Test & Measurement	
Aug. 4	July 14	Sensors & Transducers, Analog ICs, Graphics	Closing: July 21 Mailing: Aug. 11
Aug. 18	July 28	Military Electronics Special Issue, Displays, Military ICs	
Sept. 1	Aug. 11	Instruments, Op Amps, Computers & Peripherals	
Sept. 15	Aug. 25	Data Acquisition, Data Communications, Digital ICs	Closing: Sept. 1 Mailing: Sept. 22
Sept. 29	Sept. 8	DSP, Graphics, Optoelectronics	
Oct. 13	Sept. 22	Test & Measurement Special Issue, Instruments, Computers & Peripherals	Closing: Sept. 29 Mailing: Oct. 20
Oct. 27	Oct. 6	CAE, Computers & Peripherals, Integrated Circuits, Wescon '88 Show Preview	
Nov. 10	Oct. 20	Programmable Logic Devices, Integrated Circuits, Test & Measurements, Wescon '88 Show Issue	Closing: Oct. 27 Mailing: Nov. 17
Nov. 24	Nov. 3	Microprocessor Technology Directory Graphics, CAE	
Dec. 8	Nov. 16	Product Showcase—Vol. I, Power Sources, Software	Closing: Nov. 21 Mailing: Dec. 15
Dec. 22	Dec. 1	Product Showcase—Vol. II, Computers & Peripherals, Test & Measurement	

Call today for information:

East Coast: Janet O. Penn (201) 228-8610

West Coast: (714) 851-9422

National: Roberta Renard (201) 228-8602

Telecommunications by Rockwell

Spanning the spectrum of telecommunications technology...Rockwell International is a major force in the Telecom industry. We are one of the largest suppliers of lightwave systems to the telephone companies...First to provide gigabit lightwave systems, and a leader in next generation lightwave products.

And our product line doesn't stop there. We are a leading supplier of specialized switching systems, including Digital Cross-Connect, and Automatic Call Distribution Systems. We are now pushing advanced technology Telecommunication Systems into the expanding local loop...

Join a committed Telecommunications leader. An industry force...dedicated to success through customer-driven quality products and service. Opportunities are available in Dallas, Texas for the following...

Software Engineers

Involves real-time telecommunications software design. Requires BSCS or MSCS and 3-10 years in software analysis, module design, design, coding, and test of real-time systems, preferably 68000 micro-processor based. Experience in "C" and high-level languages required. Knowledge of event driven code, UNIX*, Computer-Aided Software Engineering (CASE) tools and experience with C++, PASCAL, TCP/IP, SS7 and X.25, Serial I/O, OSI Level II-III, structured (or object-oriented) design/analysis is helpful.

Digital Module Designers

BSEE or MSEE and 3+ years of CMOS, TTL, ECL board design (50-150 MHz) backplanes, cross-talk, signal termination and digital multiplex experience required. Use of daisy/mentor simulation tools necessary along with demonstrated knowledge of module design, production, and manufacturing support. Familiarity with DSI, DS3 and experience in ASIC design and SMT desirable.

High-Speed Analog/ Optics Designers

Requires BSEE or MSEE and 3+ years of wideband analog electronics design experience. Demonstrated module design, production, manufacturing support experience necessary. Familiarity with PIN, APD detectors, laser diodes, hybrid circuitry and experience with AGC, limiting amplifiers, comparators, and transimpedance amplifiers desired. Additional experience with laser diode biasing, power and monitoring, modulation helpful.

Component Applications Engineers

BSEE with 10 years experience or MSEE plus 8 years experience with at least 6 years experience in applications and/or manufacturing of LSI and VLSI devices required. Involves working with ASIC utilized in transmission products including preparing/developing/reviewing test plans and results.

Digital Circuit Designers

Will be responsible for the digital circuit design including RS-232 and 422/423 interfaces. BSEE plus 4-6 years digital circuit design experience including familiarity of asynchronous, synchronous protocols and polling/multi-drop systems essential. Knowledge of single-chip microprocessors, serial I/O devices and microprocessor communications, assembly-language firmware/software necessary.

Mechanical Engineer

Will be responsible for high density electronics and/or packaging design and development. BSEE or BSME required; 6 years commercial telecommunications experience preferred. Proficiency in computer-vision 3D mechanical CAD systems desired. Demonstrated capabilities/experience in the following areas required: SMT and its use in high density packaging, EMI FCC part 15 compliance, forced and natural convection cooling, multilayer backplanes, compliant pin connectors, industry standards for commercial telecom products, human factor design and value engineering design techniques.

Analog Module Designers

BSEE or MSEE and 3+ years in design of digital and analog circuits (1-50 MHz) required. Knowledge of analog control-loop, Phase Lock Loop, op-amp, I.F. and demonstrated module design, production, manufacturing support of products experience essential. Familiarity with DSI, DS3 is desirable.

Telecommunications by Rockwell...it means playing an important role in the future for the many engineers and technical personnel that we employ. Find out how you can get involved. We offer a benefits package that you would expect from a Fortune 25 Company. Send your resume to: **Barbara May, Rockwell International Telecommunications, Dept. 8575, M/S 401-152, P.O. Box 10462, Dallas, Texas 75207.** Permanent Residency Required. Equal Opportunity Employer M/F.



Rockwell International

...where science gets down to business

*UNIX is a trademark of AT&T Bell Labs

Everyone wants engineers who can walk on water.

If you're an engineer who rises above the crowd, Compaq will send you soaring.

Compaq people are innovative and independent. At the same time, they participate as part of a team. This "can do" environment has helped us design the most sophisticated personal computers for business use.

Surface Mount Technology Engineers:

Challenge your surface mount technology experience in design, manufacturing, quality, reliability, and sustaining engineering. You'll have a hand in the process with your BS degree in engineering and two years' experience in a high-volume manufacturing environment.

Sustaining Engineers:

Qualify with a BSEE or BSME plus three years' experience in the following areas: digital and analog component evaluation and failure analysis; electromechanical failure analysis and problem resolution specifying electrical and mechanical component requirements (resistors and capacitors through VLSI and ASICs); SMT components; component supplier interfacing on specifications and quality improvement; disk drives. Experience in INTEL 80286/80386 Assembly language programming is preferred.

Product Quality Assurance Engineers:

Help us maintain the highest user satisfaction ratings through quality assurance management. From statistical process control, to formulating quality assurance procedures, to establishing workmanship standards, the challenge is yours. To qualify, you'll need a

BSEE degree and two years' experience with disk drives, keyboards, power supplies, or printed circuit boards, and failure analysis at the component level.

Diagnostic Test Engineers:

Manage hardware and software diagnostic testing with state-of-the-art automatic test equipment. Your BSEE or MSEE degree should be complemented with at least two years' related experience in designated ATE test fixtures/bed of nails fixtures with a background in power supply testing and transmission line theory as related to fixturing.

Familiarity with Teradyne L200 and Genrad test equipment, "C" and Assembly programming languages, using industry standard architecture and MS-DOS in an 80286/80386/8086 environment is essential.

Component Test Engineers:

You'll ensure quality control through engineering analysis, device characterization, and failure verification of digital and linear devices such as: custom ASICs,

complex microprocessors and peripherals, advanced CMOS logic, static and dynamic memories, and other precision components.

You should have a BSEE and three years' experience in either ATE component test equipment, analog testing, printed circuit boards, component/incircuit boards, or vendor quality inspection and supplier selection.

Vendor Quality Engineers:

Coordinate device qualifications with vendors and purchasing. You'll lead the way conducting tests and evaluating design and redesign peripheral problems to maintain the highest user satisfaction ratings through quality control. You must have at least two years' experience with peripherals and project management, plus a BSIE or BSEE degree.

Cost Reduction Engineers:

Provide innovative solutions to cost reduction problems by creating designs to meet the requirements of established goals. You should have a BS in EE, EET,



We expect a little more.

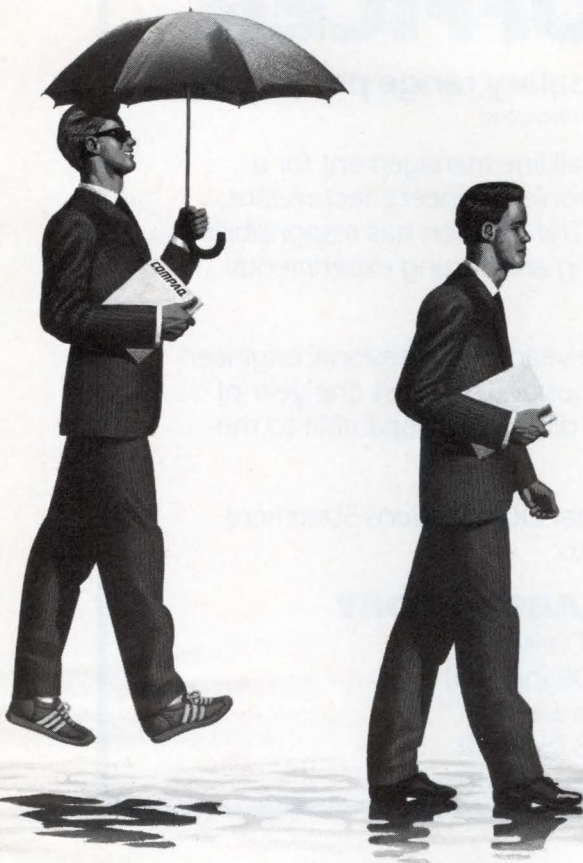

or other related engineering field, with two years' experience in digital systems design. In addition, you should have excellent communication skills and the ability to move multiple projects toward completion.

Packaging Engineers:

Provide direct packaging engineering support for manufacturing operations, as well as product development support through improved packaging designs. Your BS in ME, Packaging Engineering, or equivalent, plus three years' related experience qualifies you for this challenging position. Excellent interpersonal skills are required to develop strong working relationships with outside vendors, contractors and consultants, as well as with multiple internal organizations.

Microprocessor Logic and ASIC Design Engineers:

Challenge your expertise in high-speed logic design and/or microprocessor system design using flow charts and timing diagrams for digital design and detailed design analysis.

Your experience should include vendor libraries, test vector generation, simulation checkout, and TTL emulators for gate/array standard cell design. Familiarity with CAE systems used in logic design, test vector generation, simulation checkout, and documentation is also necessary. You must have five years' related experience plus a BSEE or equivalent degree; an MSEE degree is preferred.

Systems Software Engineers:

Evaluate, design, and develop firmware, operating systems, device drivers, and utility software for PC systems. You'll need a BSCS, BSEE or equivalent degree with four years' related experience in PC software development, 8086/286/386 Assembly/"C" language programming in MS-DOS, OS/2, and/or UNIX/XENIX operating systems.

Systems Architects:

Design new products by investigating and evaluating system compatibility and performance of design alternatives and new technologies. You'll develop hardware

compatibility tests and performance analysis tools.

Qualify with a BSEE, MSEE preferred, and three years' hardware background with a knowledge of microprocessor-based systems software. In addition, experience with CPUs/memory/bus architecture, numeric co-processors, file subsystems, network/communications, graphic subsystems, and state machines is required.

Graphics Display Manager:

Coordinate and manage the definition, development and procurement of display subsystems. You'll provide compatible systems and develop high resolution products for engineering workstations, desktop publishing, and related applications.

You must have a BSEE or BS in Physics; an M.S. is preferred. Eight years' experience in electronics design engineering and management, including five years in design of computer equipment is necessary, as well as the ability to manage technical professionals in an engineering development environment.

Can you walk on water?

Maybe you won't know until you try. Compaq offers competitive salaries, comprehensive benefits and an unequalled work environment. We have a variety of openings for select professionals within the company. If you're interested in one of the above positions—or any other—submit your resume and salary requirements to:

Please specify the position for which you wish to be considered.

Compaq Computer Corporation, Dept. EDN41488-RM, P.O. Box 692000, Houston, Texas 77269-2000. Compaq is an affirmative action employer, m/f/h/v.

COMPAQ

ENGINEERING SERVICES OFFICER

GM-801-15 • \$54,907 TO \$71,377 salary range per annum

(Salary dependent upon qualifications)

Supervisory General Engineer provides overall line management for a Division comprised of: mechanical and electronic engineers; technicians; crafts people; and other support personnel. The Division has responsibility for designing, drafting, fabricating, assembling and testing experimental equipment required by scientific divisions.

Qualifications: Bachelor's degree plus three years of professional engineering experience suitable to the duties of this position. At least one year of this experience must have been at a level of difficulty comparable to the GM-14 level.

Interested applicants should submit a Personal Qualifications Statement (SF-171) or detailed resume by May 6, 1988 to:

NAVAL RESEARCH LABORATORY

Civilian Personnel Division
Attn: Code 1822-23:DE:jp(EDN)
4555 Overlook Avenue, SW
Washington, DC 20375-5000

AN EQUAL OPPORTUNITY EMPLOYER • U.S. CITIZENSHIP REQUIRED

Telecom-
munications

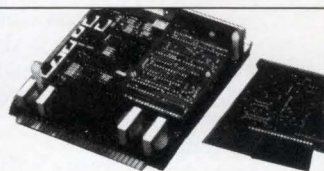

We're heavily involved in the design, manufacture and marketing of top-quality telecommunications products. Join us. Send your resume to Boeing Employment Office, P.O. Box 3707-R53, Seattle, WA 98124. **BOEING**
Equal opportunity employer.

Digital has it now.

Do you want to be challenged?

It would be one thing to keep pace with today's fast-moving computer marketplace. But, at DECwest, we're looking beyond current market needs. Our environment offers cutting-edge technology, creative energy, and aggressive spirit. We're working on highly advanced, quality products that will amaze the industry. Not just a few years from now, but for decades to come.

The challenge is virtually unprecedented. And, it could be yours. So, take a look at DECwest. Then, get ready to take on the future.

Diagnostic Engineer

As a Diagnostic Engineer, you'll be responsible for perfecting our next generation computing system in the following areas:

- Functional unit testing
- Standalone system exercising
- System-directed diagnostic testing
- Device diagnostic testing

Requires 3 years of diagnostic or test experience. Knowledge of assembler and a high-level programming language is required. BSEE with CE experience or MSEE or equivalent degree and experience a must.

File System Extensions

We need experienced individuals interested in working on file system implementation. You'll need experience in one or more of the following:

- Disk and/or tape storage organization techniques and algorithms
- Experience directly manipulating files with OS primitives
- UNIX† or VMS* file systems
- Operating system development
- DBMS access methods internals

UNIX Kernel Experts

You'll need experience in one or more of the following:

- I/O and device support
- Virtual memory systems
- Symmetric multiprocessing
- Threads and lightweight processes
- BSD and/or System V-based systems
- Graphics support and graphics devices

UNIX System Experts

We need UNIX System Experts with experience in one or more of the following:

- Development and use of system call and library interfaces

- Programming and user interface standards (i.e., POSIX, X/Open, SVID, BSD)
- UNIX development tools
- Debuggers, utilities, and user interfaces

For the above three positions you should also have programming experience in high-level languages (in addition to C), a BS or MS in Computer Science, and 5+ years of experience (or equivalent combination of degree and experience). Knowledge of VMS internals is a plus.

Senior Hardware Engineer

You'll need experience in one or more of the following:

- Computer architecture
- Vector processing
- High speed CMOS
- Digital logic design
- I/O systems

You should also have a BS/MS in EE and 3-5+ years' experience. ASIC design and test a plus.

For consideration or more information about the above positions, please send your resume to: **L. Taylor, Manager, Dept. 0414-8820, DECwest Engineering Group, Digital Equipment Corporation, 14475 NE 24th, Bellevue, WA 98007.** Proof of legal right to work in the U.S. is required.

We are an affirmative action employer.

*Trademarks of Digital Equipment Corporation

†Trademark of AT&T

digitalTM



GaAs Career Opportunities

Varian Associates, a Fortune 500 electronics innovator, is expanding the GaAs processing capabilities of our III-V Device Center in Santa Clara, California. Our new lab is devoted to MMICs, HEMTs and state-of-the-art GaAs CCDs built for critical defense applications. We are seeking qualified professionals with GaAs and/or semiconductor experience to support this advanced technology.

Test Manager

You will be responsible for planning, organizing and directing DC and AC testing of CCD wafers and/or packaged devices. Supervising personnel in manufacturing and engineering test area will also be part of your duties, along with managing the test data base, participating in the testing activities and analyzing results. Qualified individuals must have a BSEE/Physics, or equivalent, plus 7 years experience including demonstrated ability to direct a team effort.

Test Engineers

As you play an active role in process control, you will also support DC and AC testing of CCD wafers and/or packaged devices, maintain test data base, and perform extensive analysis. This is a senior position requiring a BSEE, or equivalent, plus 2-4 years automatic test equipment experience. A solid knowledge of electronic circuit theory and physics is a must. Background in semiconductor processing would be helpful.

Reliability Engineers

Support reliability testing and analysis of CCD devices plus direct appropriate tasks for test technicians. You will provide feedback to Fab regarding device performance and support burn-in operation of packaged devices. Qualified individuals must have a BSEE/Physics plus 5-7 years experience in GaAs semiconductor reliability engineering.

Process Engineers

Be responsible for processing engineering in CCD wafer fab covering ion implantation, anneal, and CVD processes. You will set up and analyze process controls in fab and participate in statistical process control methods. We require a BSEE/Physics plus 2-4 years experience with knowledge of ion implantation, rapid thermal processing and plasma CVD processes.

Assume responsibility for process engineering in metallization, CVD and etch. You will direct tasks for fab process technicians and define, plan and execute process development projects. We require BSEE/Physics plus 2-4 years experience with knowledge of thin film deposition and etch equipment, including metallization lift off, alloy, chemical vapor deposition and dry etch processes.

Product Assurance Engineers

Prepare and document audits, inspection procedures and QA flow charts of CCD semiconductor processes/packaging. Perform product assurance duties such as materials review board member, failure analysis, audits and design reviews. We require a BSEE or equivalent plus 2-4 years experience in a semiconductor manufacturing environment. Packaging experience a plus.

Varian offers an excellent salary and benefits package which includes cash profit sharing and a 401(k) retirement savings plan. For immediate consideration, forward your resume including salary history, to Becky Fullerton, Varian Solid State Operations-California, 3251 Olcott St., Santa Clara, CA 95054. We are an equal opportunity employer.

varian 
Innovative People
Making Technology Work

EDN Databank

Professional Profile

Announcing a new placement service for professional engineers!

To help you advance your career, Placement Services, Ltd. has formed the EDN Databank. What is the Databank? It is a computerized system of matching qualified candidates with positions that meet the applicant's professional needs and desires. What are the advantages of this new service?

- It's absolutely free. There are no fees or charges.

- The computer never forgets. When your type of job comes up, it remembers you're qualified.
- Service is nationwide. You'll be considered for openings across the U.S. by PSL and its affiliated offices.
- Your identity is protected. Your resume is carefully screened to be sure it will not be sent to your company or parent organization.

- Your background and career objectives will periodically be reviewed with you by a PSL professional placement person.

We hope you're happy in your current position. At the same time, chances are there is an ideal job you'd prefer if you knew about it.

That's why it makes sense for you to register with the EDN Databank. To do so, just mail the completed form below, along with a copy of your resume, to: Placement Services, Ltd., Inc.

IDENTITY PRESENT OR MOST RECENT EMPLOYER

Name _____ Parent Company _____
Home Address: _____ Your division or subsidiary: _____
City _____ State: _____ Zip: _____ Location (City, State) _____
Home Phone (include area code): _____ Business Phone if O.K. to use: _____

EDUCATION	Major Field	GPA	Year Degree Earned	College or University
Degree (List)				

POSITION DESIRED

EXPERIENCE Present or Most Recent Position

Duties and Accomplishments: _____ Industry of Current Employer: _____
From: _____ To: _____ Title: _____

Reason for Change: _____

PREVIOUS POSITION:

Job Title: _____
Employer: _____ From: _____ To: _____ City: _____ State: _____
Division: _____ Type of Industry: _____ Salary: _____
Duties and Accomplishments: _____

COMPENSATION/PERSONAL INFORMATION

Years Experience	Base Salary	Commission	Bonus	Total Compensation
------------------	-------------	------------	-------	--------------------

I Will Travel _____ Date Available _____
 Light Moderate Heavy

Asking Compensation _____ Min. Compensation _____

I own my home. How long? _____ I rent my home/apt.

Employed Self-Employed Unemployed

Married Single Height _____ Weight _____

Level of Security Clearance _____ U.S. Citizen Non-U.S. Citizen

My identity may be released to: Any employer
 All but present employer

WILL RELOCATE WILL NOT RELOCATE OTHER _____

EDN Databank

A DIVISION OF PLACEMENT SERVICES LTD., INC.
265 S. Main Street, Akron, OH 44308 216/762-0279

*creative thinking
and bold approaches. . .*



Telecommunications Professionals

Be a Part of a Major Telecommunications Corporation Which:

- **EMPLOYS** 150,000 professionals in 110 countries
- **HAS ANNUAL** sales in excess of \$12 Billion
- **HAS AN ANNUAL** R & D budget that exceeds \$1 Billion
- **IS COMPRISED** of more than 240 companies

ALCATEL NETWORK SYSTEMS, Raleigh, N.C., a rapidly growing, very progressive division of parent Alcatel NV, is responsible for the design and development of some of the most advanced, leading-edge, next-generation, telecommunications products. . . products that meet and exceed evolving industry standards.

As a member of our aggressive team you will have access to some of the most advanced technologies such as **CMOS ASICs, ADVANCED CMOS LOGIC, MICROPROCESSORS, SURFACE MOUNT TECHNOLOGY** and **CAD TOOLS**. If you are currently seeking an opportunity to use your specialized talents in an environment that encourages creative thinking and bold approaches, then consider the following opportunities and respond today!

SYSTEM INTEGRATION TEST ENGINEERS

Engineers to develop product testing strategies and procedures and to perform system level testing for design verification during the development phase of next generation software intensive, transmission products. BSEE/BEET/BSCS Degree with 2 or more years of directly applicable experience in system level test procedures development, test execution and fault isolation.

SOFTWARE ENGINEERS

Software for products involves use of real-time operating systems, design of embedded data communications and design of real-time and nonreal-time microprocessor programs and subsequent integration with hardware. Will utilize VAX computer facilities, microprocessor emulation systems and analyzers. Candidate should have 2 years experience in software engineering for telecommunication systems utilizing C, PASCAL and VAX/VMS. BSEE or BSCS degree is required, MS preferred.

LOGIC CIRCUIT DESIGN ENGINEERS

Circuit design and simulation experience using standard CMOS and ECL as well as logic arrays and semi-custom devices. Assignments will be in the areas of New Product Development associated with various types of telecommunication products using digital multiplexing and microprocessor control techniques. Familiarity with LSSGR, TR-TSY-000008, TR-TSY-000057, and TR-TSY-000303 is desirable. BSEE degree, MSEE preferred, with a minimum of 3 years experience in design of telecommunications equipment.

ADVANCED TEST ENGINEER

Responsibilities will include generating test plans, reviewing designs and testability and acting as an interface for the Test Engineering Department. BSEE degree and at least 2 years experience related to printed board assembly testing required. A telecommunications background would be a plus.

ANALOG CIRCUIT DESIGN ENGINEERS

Analog Circuit Design Engineers will utilize skills in designing telephony line circuit using codec and combo (codec and filter) devices and some semi-custom LSI circuits. A thorough understanding of analog transmission and signalling parameters and design considerations for power cross and lightning protection are essential. Both UDLC and IDLC configurations are in development requiring working knowledge of BellCore documents TR-TSY-000057, TR-TSY-000008, TR-TSY-000303 and TR-TSY-000313. BSEE, or MSEE, with minimum of 2 years design experience required. Telephone line circuit design, power converter experience and computer simulation (SPICE) experience beneficial.

ASIC DEVELOPMENT ENGINEERS

Responsible for ASIC development using state of the art standard cell, gate array technology and CAD tools. BSEE Degree required, MSEE preferred with a minimum of 5 years experience, at least 3 of which include ASIC design using CMOS technology, schematic capture and logic simulation tools. One year project lead experience and experience in telecommunications desirable.

MECHANICAL ENGINEERS

ME with strong thermal/stress analysis background required to attack the exciting problems in telecommunications products. Experience in computer modeling and scientific programming desirable. Excellent lab facility available for technology development. Candidate should have MSME Degree, or equivalent, with minimum 3 years experience in computational mechanics.

HARDWARE TEST ENGINEERS

Engineers will participate in the development of functional test facilities and other related test equipment used in the support of various telecommunications products. Telecommunications and/or test development experience is desired. BSEE Degree and 2-4 years related experience, combined with a demonstrated ability in analog and digital circuit design required.

SYSTEM ENGINEERS

Positions are for System Engineers with emphasis on definition and analysis of system level requirements. Position requires knowledge of Telecommunications industry standards and requirements. Ability to analyze industry standards and requirements to define new product requirements is necessary. Capability is needed to communicate and work across multiple disciplines. BSEE or BSCS degree is required; MS preferred with a minimum of 7 years experience in telecommunications.

SENIOR TECHNICAL WRITER

Must demonstrate proven communications skills, both text and graphics. Must also be familiar with TOP5 and other related Bellcore documentation standards. BSEE degree or equivalent with 4-6 years transmission product experience including fiber optics and/or multiplexers.

MARKET RESEARCH ASSOCIATE — NEW PRODUCT DEVELOPMENT GROUP

Position requires strong analytical ability with emphasis on new product definition, market analysis and business planning. Candidate should possess 3 to 5 years telecommunications experience with product engineering, product development, marketing, sales or Product Line Management background. BSEE.

ALCATEL NETWORK SYSTEMS offers an attractive compensation package, full benefits and relocation assistance. Boasting a growing economy, the Raleigh area offers very affordable housing, easy access to major cultural, sporting and recreational facilities and numerous educational opportunities including three major universities and the nationally renowned Research Triangle Park nearby. To apply, please forward a detailed letter and/or resume, including current and desired salary, in strict confidence to: ALCATEL NETWORK SYSTEMS, Staffing Department, 2912 Wake Forest Road, Raleigh, North Carolina 27609. An Equal Opportunity Employer M/F/H/V.

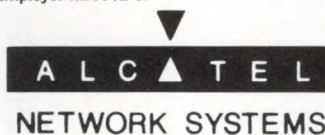

ALCATEL NETWORK SYSTEMS: State-Of-The-Art Technology That's Pushing through New Boundaries

ADVERTISERS INDEX

Abbott Transistor Labs Inc	242	General Silicones	323	Precision Filters Inc	298, 299
ABC—Taiwan Electronics Corp	322	Genstar REI Sales Co	322	Precision Interconnect/ National Electrical Cable	188
ACCEL Technologies Inc	323	George Risk Industries	327	Precision Monolithics Inc	179
ACDC Electronics	240	GE/RCA Solid State	16-17, 114-115	Qua Tech Inc	323, 325
Acheson Colloids Co	321	Gould/AMI	35-44	Quantum Corp	100-101
Acopian Corp	312	Hall-Mark/Allied Electronics	341	Racal-Redac	337
ADC Telecommunications	325	Hardigg Industries Inc*	50	RAF Electronic Hardware Inc	275
Airpax Corp/Cambridge Div	316	Harris Semiconductor Products	149-151	Rifa Inc/Capacitor Div	185
Alban Inc	320	Harting Electronik	108-109	Robot Graphics	325
Allen Avionics	207	HEI Inc	256	Robotrol	323
American Automation	94	Hewlett-Packard Co	60-63, 111-113, 166-167	Rockwell International	116-117
Amoco Laser Co	253	Hitachi America Ltd*	18-19	Rogers Corp	321, 323
AMP	154-155	Houston Instrument	208	RS Cad Tech	319
Amperex Electronic Corp*	51, 282	IEEE Applied Power	238	Samsung Semiconductor	78-79
Analog Design Tools Inc	147	Industrial Devices Inc	306	Saratoga Semiconductor	103
Analog Devices Inc	C2, 304	Instant Board Circuits Corp	274	S-Cubed	292
Apollo Computer	105-107	Intel Corp	295	Seagate Technology	246
Applied Data Systems	322	International Rectifier	C3	Seeq Technology Inc	33
Applied Microsystems Corp	14-15	Intusoft	326	Seiko Thermal Printer	273
Ariel	320, 322	I/O Tech	256	SGS Semiconductor Corp*	84-85
Aries Electronics Inc	288	Ironics	129	Sharp/Marshall Industries	310
Arnold Magnetics Corp	254	Ji-Haw Industrial Co Ltd**	32	Shih Hsin Precision Corp	320
Asem Industrial Spa**	6	John Fluke Manufacturing Co Inc	6, 32, 200-201, 203	SI Tech	320
Atron	70	Kemet Electronics	261	Siemens Corp**	66-67, 200-201
Augat-Interconnection Systems	262	Kepeco Inc	209-214	Silicon Systems Inc	82-83
Bayer AG**	84-85	Key Tronic	90	Siliconix Inc	4
B&C Microsystems	320, 325	KeyTek Instrument Corp	256	Silvar-Lisco	293
Bertan Associates Inc	236	Kindatron Electronics Industrial Co Ltd**	203	Simpson Electric Co	224
Bonar Powertec	94A-D	Kuan Hsi Electronic Co Ltd	321	Single Board Solutions	326
BP Microsystems	322	Leadyear Enterprise Co Ltd	322	Sorensen Co	223
Brooktree Corp	244-245	Lectromagnetics	294	Spectrum Software	297
Burle Industries	287	Linear Technology Corp	231-232	Sprague Electric Co	81
Burndy Corp	92-93	Littelfuse Inc	95	Sprague-Goodman Electronics Inc	335
Burr-Brown Corp	52, 66*, 266	LMI Connectors	334	Stag Microsystems Inc	311
BV Engineering	325	Logical Devices Inc	319	Standard Grigsby Inc	331
Bytek Corp	333	Luminescent Systems Inc	255, 257, 259	Standard Oil	335
CAD Software Inc	300	3M Fluoronics	181-184	Stanford Research Systems Inc	77
Caddy Corp	301	Magnesy	321	TAB Books	45
Calcomp	28-29	Magnetek Triad	343	Taiwan Liton Electronic Co Ltd	241
Canadian Thermostats & Control Devices Ltd	301	Mallory Capacitor Corp	303	Taiwan Zetatronics	324
Capital Equipment Corp	322	Marconi Instruments*	197	Tatum Labs	326
Carlingswitch	332	Marconi Microsystems	307	Tauber Electronics	314
Carroll Touch	91	Mascot Electronic**	252	TDK Corp	202
Case Technology	226	MathSoft Inc	52	Tektronix Inc	8, 10-11, 46-47, 72, 248-251, 279, 281, 283-285
Catalyst Research	302	Matra Harris Semiconducteurs	306	Telebyte Technology Inc	270
Chomerics Inc	315	Maxim Integrated Products	86	Teledyne Relays	258
Communications Specialists Inc	325	Measurement Systems Inc	323	Teledyne Semiconductor	12-13
Component Mfg Service Inc	275	Memodyne Corp	330	Teradyne Inc	30-31
CooperTools*	235	Mental Automation Inc	319	Todd Products Corp	321
CTS Corp	133	Mentor Graphics Corp	163-165	Tokin Corp	206
Cybernetic Micro Systems	321, 324	Mepco/Centralab	309	Topaz Semiconductor	54
Cypress Semiconductor	64	MetaLink Corp	199	Toshiba America Inc	265
Daisy Systems Corp	56-57	Metreiq	327	Toshiba Corp	318
Dalanco Spry	320	Midwest Components	89	TRW/LSI Products Div	23
Data Display Products	288	Mini-Circuits Laboratories	26-27, 229, 356	Tusonix Inc	264
Data I/O Corp	C4, 313	Moorola Semiconductor Products Inc	48-49, 186-187	Utitec Inc	338
Dataram Corp	275	Murat Erie North America Inc	267	Varta Batteries Inc	268
Datron Instruments	156	National Instruments	305	Vector Electronic Co	247
Dek Inc	327	National Semiconductor Corp	138-139, 152-153	Vicor	131, 136
Deltron Inc	275	NCR Microelectronics Div	58-59	Visionics Corp	320
Densitron Corp	34	NCR Power Systems	269	VTC Inc	2
Dialight Components	225	NEC Electronics Inc	204-205	Wavetek San Diego Inc	3
Digital Media Inc	324	Nicolet	75	Wickmann Werke	327
Eaton Corp	321	Nohau Corp	319	Winpoint Electric Corp	324
EH Titchener & Co	335	North Hills Electronics	276	Wintek Corp	321, 324
Electrochem	272	Northwest Instrument Systems	20	Xender Corp	326
Electro-Mechanics	326	NSK Corp	34	Xicor Inc	137
Electronic Development Corp	328	Oak Switch Systems Inc	317	Xilinx	134-135
Electronic Solutions	96	Octagon Systems	325	Zax Corp	102
Electroswitch Corp	266	OKI Semiconductor	68-69	Zericon	320
Emulation Technology Inc	323	Oliver Advanced Engineering Inc	82	Ziatech Corp	1
Engineering Tutorial Software	324	Omaton Inc	53, 326	Zilog Inc	99
Epson America Inc	331	Omron Electronics Inc*	67	Zippy Shin Juih Corp	326
Ericsson	277	OrCAD Systems Corp	177		
E-TA Circuit Breakers	319	Orion Instruments	55		
Exar Corp	125	Panasonic Industrial Co	239		
Fasco Industries	237	Patton & Patton	326		
Frequency Devices	286	Performance Semiconductor Corp	25		
Fuji Electrochemical Co*	252	Philips Elcoma Div**	18-19, 50-51		
Fujitsu Components of America Inc*	168	Philips Test & Measuring Instruments Inc**	235		
Fujitsu Computer Products Group	289	Planar Systems	161		
Fujitsu Limited	168**	Polytron Corp	323		
Futaba Corp of America	329	Polytronix Inc	314		
F W Bell Inc	344	Potter & Brumfield	290-291		
Gali Motion	322				
Gates Energy Products Inc	271				

Recruitment Advertising . 346-353

Boeing
Compaq
Dec West
Naval Research Laboratory
Rockwell-Collins

*Advertiser in US edition

**Advertiser in International edition

This index is provided as an additional service. The publisher does not assume any liability for errors or omissions.

LOOKING AHEAD

EDITED BY CYNTHIA B RETTIG

IC sales should achieve 12% CAGR from 1983 to 1992

According to Integrated Circuit Engineering Corp (Scottsdale, AZ), worldwide sales of integrated circuits should enjoy a 12% compound average growth rate (CAGR) from 1983 through 1992. Worldwide sales of electronic systems in general should experience a 10% CAGR in the same period. The higher growth rate for ICs reflects the steadily increasing use of semiconductors in electronic systems and underscores the connection between a healthy semiconductor industry and the production totals of electronic systems.

In order to avoid double counting and overestimating in its forecast, ICE subtracted the electronic-component figures from the overall production totals, published by various associations, that it used in compiling its study. These components include relays, antennas, disks, all active devices (ICs and discrete circuits), and capacitors and similar devices. In order to remove increases, or decreases, in in-house systems component inventories from aggregate forecasts, ICE also extracted component sales from systems figures.

Although the trend is toward increased production in Asian countries to the ultimate detriment of

American sales, the US still leads in the production of electronic equipment and currently claims 43% of all sales. Moreover, it's crucial to remember that the recent decline in the US share of worldwide electronic equipment sales, when represented in dollars, results largely from exchange-rate fluctuations.

In 1987, worldwide sales of semiconductors, including ICs and dis-

crete devices, were 23% higher than in the previous year, with IC sales growing by 27% and discrete-device sales by 9%. Although 1989 sales will only be 1% greater than those for the preceding year, sales will rebound nicely in 1990, 1991, and 1992, when growth is expected to equal 14%, 13%, and 12%, respectively. These estimates are based on 1987 constant dollars.

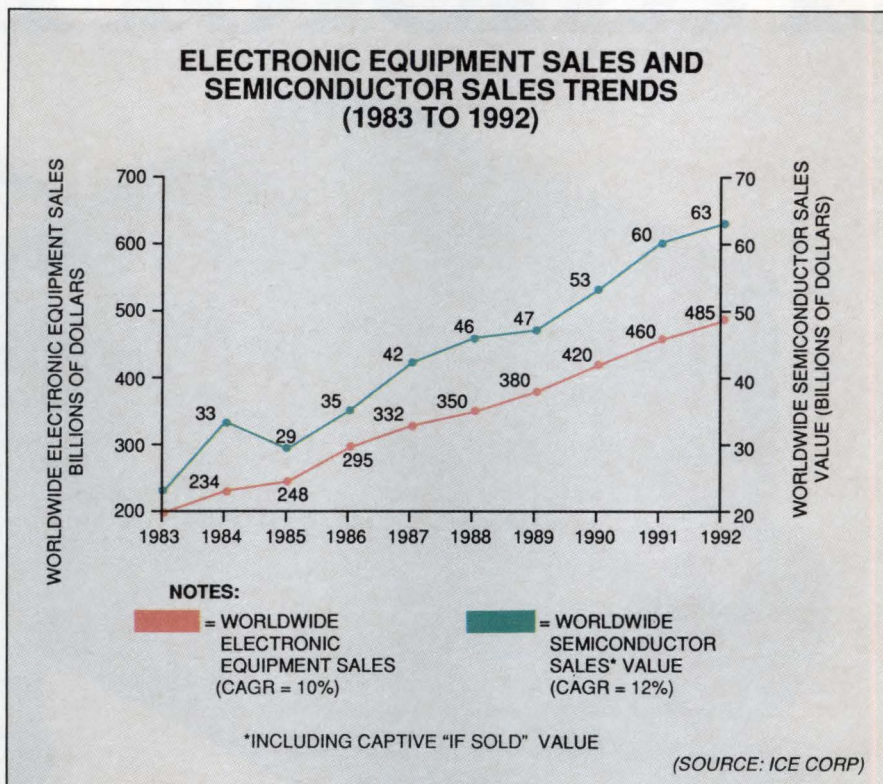

WORLDWIDE MERCHANT SEMICONDUCTOR SALES FORECAST

(MILLIONS OF DOLLARS)

YEAR	IC MERCHANT	% GROWTH OVER PREVIOUS YEAR	DISCRETE MERCHANT	% GROWTH OVER PREVIOUS YEAR	TOTAL MERCHANT SEMI	% GROWTH OVER PREVIOUS YEAR
1987	29,980	27	7,480	9	36,460	+23
1988	32,200	11	7,850	5	40,050	+10
1989	32,200	FLAT	8,150	4	40,350	+1
1990	37,200	16	8,650	6	45,850	+14
1991	42,400	14	9,350	8	51,750	+13
1992	48,000	13	10,000	7	58,000	+12

(SOURCE: ICE CORP)

RF transformers

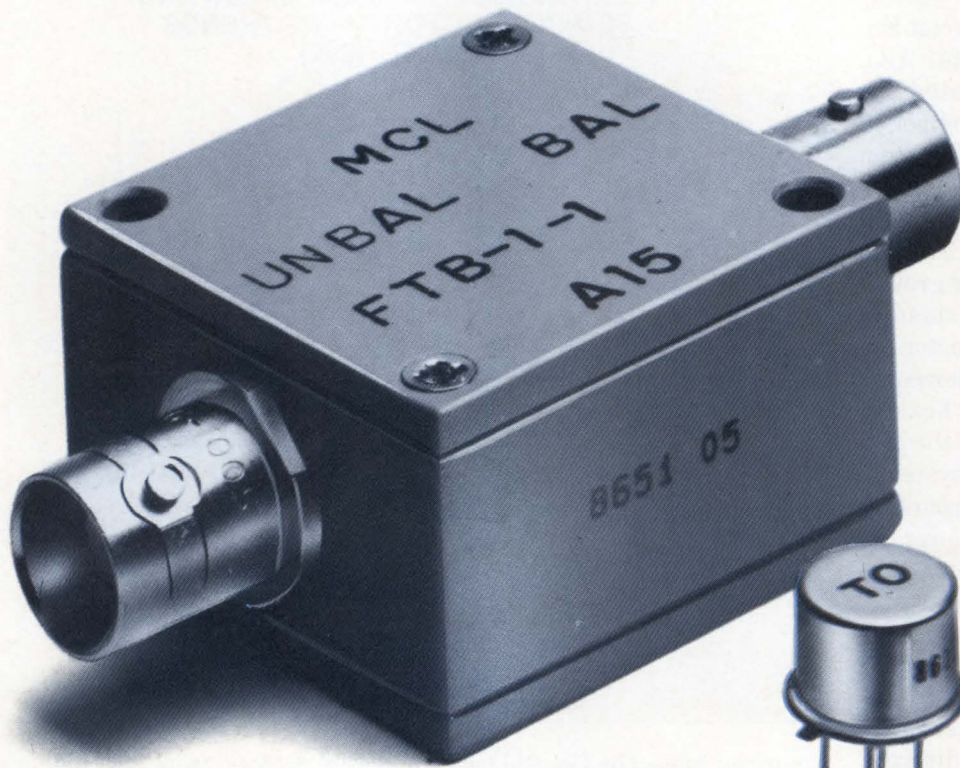

3 KHz-800 MHz
over 50 off-the-shelf models
from \$2⁹⁵

Choose impedance ratios from 1:1 up to 36:1, connector or pin versions (plastic or metal case built to meet MIL-T-21038 and MIL-T-55631 requirements*). Fast risetime and low droop for pulse applications; up to 1000M ohms (insulation resistance) and up to 1000V (dielectric withstanding voltage). Available for immediate delivery with one-year guarantee.

Call or write for 64-page catalog or see our catalog in EBG, EEM, Gold Book or Microwaves Directory.

*units are not OPL listed

finding new ways ...
setting higher standards

 **Mini-Circuits**

A Division of Scientific Components Corporation
P.O. Box 350166, Brooklyn, New York 11235-0003 (718) 934-4500
Domestic and International Telexes: 6852844 or 620156

C71 Rev. A

NOW

**TO-3
Power
in a
Plastic
Package**

TO-3P HEXFET®

Now power supply OEMs can design out TO-3s and TO-3P bipolars and design in large-die TO-3P HEXFET power MOSFETs that offer the economy of TO-220s and the power handling capability of TO-3s.

Consider this. TO-3P HEXFETs meet or exceed TO-3 specs. Thermal resistance is lower than equivalent die sizes in TO-3s. Leads, too, conform to UL and VDE spacing.

TO-3P HEXFETs also offer an isolated mounting hole to simplify installation, cut hardware costs and assembly time.

Best of all, you can expect the same high quality and reliability all HEXFET power MOSFETs guarantee.

Over thirty TO-3P HEXFET part numbers are ready now to upgrade your design.

Voltage ratings range up to 500V, and current up to 41A depending on $R_{ds(on)}$ and die size. For complete data, call (213) 607-8842. Today.

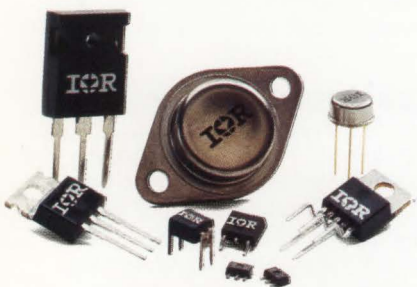
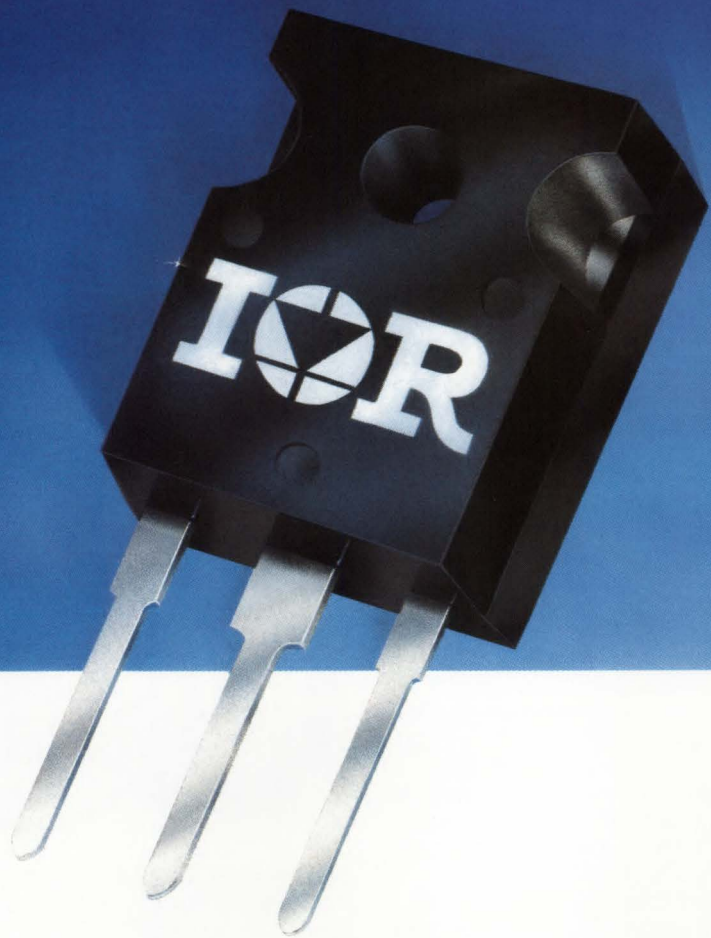

**Most HEXFETs now in stock
for immediate delivery!**

**Number 1 in
power MOSFETs**

**International
IOR Rectifier**

WORLD HEADQUARTERS: 233 KANSAS ST., EL SEGUNDO, CA 90245. U.S.A. (213) 772-2000. TWX 910-348-6291. TELEX 472-0403
EUROPEAN HEADQUARTERS: HURST GREEN, OXTED, SURREY RH8 9BB. ENGLAND TELEPHONE (088 33) 3215/4231. TELEX 95219

**Power MOSFETs • CMOS Power Ics • Commercial/Custom Power Packages • Schottkys
Rectifiers • Thyristors (SCRs) • Diode Bridges • Molded Circuits • Assemblies**

CIRCLE NO 220



THE UNISITE 40 PROGRAMMER: BECAUSE STATE-OF-THE-ART IS A STATE OF CHANGE.

PROGRAMMING TECHNOLOGY THAT SUPPORTS ADVANCED DESIGNS— TODAY AND TOMORROW.

The UniSite™ 40's universal programming technology is the fastest and easiest way to keep up with new devices and packages. Its software-configured pin driver system provides a single site for programming any DIP device up to 40 pins, including PLDs, PROMs, IFLs, FPLAs, EPROMs, EEPROMs and microcontrollers. The same site accommodates the most popular surface-mount packages— PLCCs, LCCs and SOICs.

And now the UniSite 40 is also a gang/set programmer. With the new SetSite™ module, you can program and test as many as eight devices, up to 40 pins each, simultaneously.

INSTANT ACCESS TO NEW DEVICES.

The UniSite 40's universal pin driver



electronics stores device-specific instructions on a 3½" micro diskette. To update your UniSite 40 with the latest device releases, simply load a new master diskette.

FAST, EASY PROGRAMMING. Menu-oriented operation with step-by-step prompts makes programming simple.

Or bypass the menus and zoom directly to specific operations by selecting key commands. Help messages are available whenever you need assistance.

To speed parts selection, the UniSite 40 provides a built-in list of devices. And you can save your most frequently-used programming parameters for instant recall.

DESIGN FREEDOM FOR TOMORROW.

When leading-edge designers use the latest devices in their designs, they need the programming freedom only the UniSite 40 provides. Call Data I/O® today and ask about the UniSite 40. Because state-of-the-art never stops changing.

1-800-247-5700

Dept. 613

DATA I/O

Data I/O Corporation 10525 Willows Road N.E., P.O. Box 97046, Redmond, WA 98073-9746, U.S.A. (206) 881-6444/Telex 15-2167
Data I/O Canada 6725 Airport Road, Suite 302, Mississauga, Ontario L4V 1V2 (416) 678-0761/Telex 06968133
Data I/O Europe World Trade Center, Strawinskylaan 633, 1077 XX Amsterdam, The Netherlands +31(0)20-622966/Telex 16616 DATIO NL
Data I/O Japan Sumitomoseimei Higashishinbashi Bldg., 8F, 2-1-7, Higashi-Shinbashi, Minato-Ku, Tokyo 105, Japan
(03)432-6991/Telex 2522685 DATAIO J

© 1988 Data I/O Corporation

CIRCLE NO 221