

September

Digital Design

The Magazine of Digital Systems

THE GEORGE E. FREEMAN LIBRARY
STATE TECHNICAL INSTITUTE AT MEMPHIS
5985 Macon Cove at Interstate 40
Memphis, Tennessee 38134

Giving Minis Maximum Power: EMU

What Do Logic Analyzers Do?

Debugging Systems In The Field

Computer Memory Technology/Part II

Microprocessor Development Systems



Microcomputers: Just Ask IMSAI.

If you wonder who leads the way in technology, look into IMSAI's list of industry firsts—IMSAI 8048, first complete control computer on a board; IMSAI 65K RAM Board, first to offer four times the memory capacity previously available on one board; IMSAI printers, first with high-speed direct memory access.

If you wonder why IMSAI products have gained the reputation for the standard of excellence in microcomputer systems, check with any one of the more than 10,000 IMSAI owners.

If you wonder who offers the broadest line of hardware, software, and peripherals, visit any one of the more than 275 IMSAI dealers around the world.

If you wonder how microcomputing can fit your specific needs, ask IMSAI. Because when it comes to microcomputers, we have the answers.

An IMSAI Product to Answer Every Microcomputing Need:

Let's start with our product line. In all, IMSAI offers more than 120 high quality, completely integrated systems, components, peripherals and software. Here's just a sampling:

Single Board Central Processors:

- MPU-A (8080 based)—Industry standard.
- MPU-B (8085 based)—50% faster 8080.
- 8048—Programmable control computer.

Interfaces:

- Video I/O—24x80 CRT. Edit & data entry.
- Serial I/O—2 port I/O, all std. protocols.
- Parallel I/O—4 & 6 port TTL level I/O.
- Multiple I/O—2 cassette, 2 parallel, 1 serial & 1 control I/O.
- DMA—For floppies & line printers.

Peripherals:

- Printers—44/80/132 col. 30 cps-300 lpm.
- Video displays—Large assortment.
- Tape Drive—9 track. 800 bpi. 25 ips.
- Floppy Disks—Single/double density.

Memory Expansion Boards:

- 4K RAM—Programmable memory protect.
- 16/32/65K RAM—16K paging option for virtual memory addressing.
- Intelligent Memory Mgr.—Handles up to 1 megabyte.

Self-Contained Systems:

- VDP-80—Computer/terminal/mass storage unit. Assembled & tested.
- PCS-80—Integrated component system.

Software:

- DOS—Enhanced CP/M.
- BASIC—Interactive or compiler with scientific and/or commercial features.

- FORTRAN IV—Level 2 ANSI compiler.
- Self-contained Systems:
 - SCS 1 & 2/TCOS—Assembler/line editor/debugger.
 - 4 & 8K BASIC—Optional cassette support.

Compare IMSAI. You'll realize that ours is the most complete product line available. Whatever your needs, you can get them from one source. IMSAI.

A wide selection of components is only the beginning. IMSAI offers much more. Just ask.

Answers For Businessmen:

Announcing IMSAI's VDP-80. This totally self-contained unit includes a megabyte of disk memory via floppy disk, 32K computer memory (expandable to 256K), 12" CRT and 62 pad main keyboard with 10 pad numeric keyboard. Several printer options available.

If you want speed and accuracy in high volume work such as word processing, or business data collection and analysis, the VDP-80 is your cost effective answer.

Answers For The Personal User & Educators:

Introducing IMSAI's new PCS-80 System, the fully integrated microcomputer component system, configurable to your exact needs. The basic system consists of our Intelligent Keyboard and the PCS-80 which houses an 8085 based CPU, 16K of RAM, intelligent ROM monitor, serial I/O port, 24x80 CRT, with an extra 7 slots in the chassis for expansion.

System component options include single or dual mini and standard floppy disks. The choice is yours, configure the system as you like.

IMSAI has answers for the educator, too. Take the basic PCS-80, add 8K of PROM, 4K of RAM and our self-contained 8K BASIC software, and you have a complete operating system your entire department can use to teach anything from elementary programming to advanced computer science.

Require a bit less sophistication? Use our Intelligent Breadboard system for learning, designing and building microcomputer assemblies.

Rather do it from scratch? Start with our single board MPU-B central processor, the heart of the PCS-80 System. It has a 1K ROM monitor, 256 bytes of RAM and serial and parallel I/O.

Since the MPU-B is 8085 based, you can run all programs previously developed for the 8080. 50% faster. Without requiring faster memory.

Answers For Industry:

IMSAI products provide the expandability and flexibility manufacturers demand for microcomputing applications.

We offer rack mountable components for the standard 19" RETMA racks, powerful MPU boards, I/O and memory boards for easy system expansion and configuration, and a broad line of peripherals and subsystems fully integrated and ready to go to work.

IMSAI has what you need to make tomorrow's design today's reality.

Answers For Current IMSAI Users:

There are over 10,000 of you. And, we haven't forgotten. You might say that we thought of you before you even thought of us.

That's why every new product is designed to accommodate expansion, rather than outdate equipment.

For example, our new PCS-80 retrofit kit comes complete with MPU-B, replacement front panel photomask and additional hardware bracketing. So you can enjoy a single cabinet PCS-80 computer, with your choice of integrated component configurations.

The Answer For Everyone:

Dial (415) 483-2093, Ext. ACT. That's IMSAI's action hotline. Designed to answer the thousands of questions we didn't have a chance to answer in the space of this ad.

Call us. We'll assist you in putting together a system, direct you to your nearest IMSAI dealer, and send you our new catalog with all the details.

In short, if you have any questions at all regarding microcomputers, put us to the test.

Just ask IMSAI.

IMSAI®

The Standard of Excellence in Microcomputer Systems.

IMSAI Manufacturing Corporation
14860 Wicks Blvd., Dept. DD-9
San Leandro, CA 94577
(415) 483-2093 TWX 910-366-7287

Features and specifications subject to change without notice.

The 8080 "Ice Breaker"

Portable for
Development - Production Test - Field Service

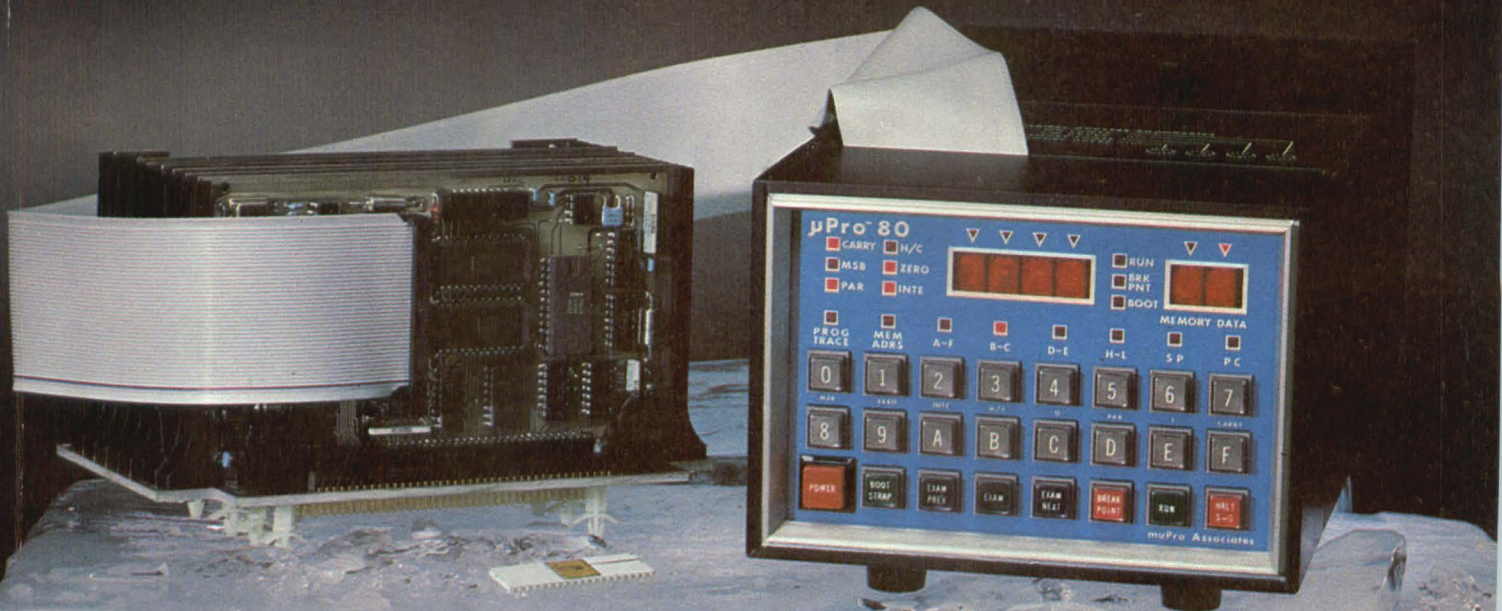

BREAKTHROUGH QUESTIONS

Portable for development, test, and field service?

Real time execution from emulator or users system memory?

Totally transparent control/display functions?

Memory available to user in 16K emulator system?

High-level relocatable language supported by 16K paper tape or 32K disk system?

Assembly language efficiency with high level language?

Multi-user/Multi-task disk operating system?

muPro-80E

YES, 4.6" x 6.6" x 15" 18 lbs.

YES, phase locked to user clock; rate up to 2.86 MHz

YES

ALL 16K

YES, BSAL-80

YES, BSAL-80

YES, plus concurrent batch capability

INTEL® MDS + ICE*

NO, 8.5" x 19" x 17" 65 lbs. Plus terminal

NO, emulator resident programs execute slower than real time

NO, imposes memory, I/O and interrupt restrictions

LESS THAN 4K (12K+ used by ICE-80 driver)

NO, PL/M® requires 64K disk system

NO, PL/M® burdened with typical compiler inefficiencies

NO, single user/single task

*INTEL and *PL/M are registered trademarks of INTEL CORP. from published specifications.

Consider Your Field Service and Production Requirements.

Manufacturers of Innovative OEM and End-User Microcomputer Systems

muPro Inc. ■ 424 Oakmead Pkwy ■ Sunnyvale, CA 94086 ■ (408) 737-0500



Circle 100 for Demonstration - Circle 100 for Literature

Intel delivers the first with resident EPROM.

Intel's new single chip microcomputer, the 8748, makes it easier than ever to add intelligence to your products. And it enables you to do it at a lower cost than ever before. It's a complete system with powerful central processor, full I/O facilities and, for the first time, resident EPROM program memory. All on a single 40-pin DIP and operating from a single +5V power supply. And you can purchase the 8748 from Intel distributors today.

During product development, the UV-erasable EPROM enables you to load and run your application programs in minutes. The 8748 also speeds debugging. Program changes can be made by erasing the EPROM and reloading with your updated software. This gets your new product out of the lab and onto the market months ahead of the competition, and with reduced development costs.

When you're ready for production, just substitute the fully compatible 8048 microcomputer with your program in low cost, resident masked ROM. If market entry timing has top priority, you can even ship your first production units with the 8748 while you gear up for the switchover to 8048. And by using the 8748 you can respond to non-standard customer requirements without waiting for ROM turn-around.

Intel's advanced MOS/LSI process technology allows a single 8748 or 8048 chip to replace up to 100 or more conventional TTL devices. The 8748/8048 contains an 8-bit general purpose CPU, 1024 bytes of EPROM or ROM program memory, 64 bytes of read/write data memory,

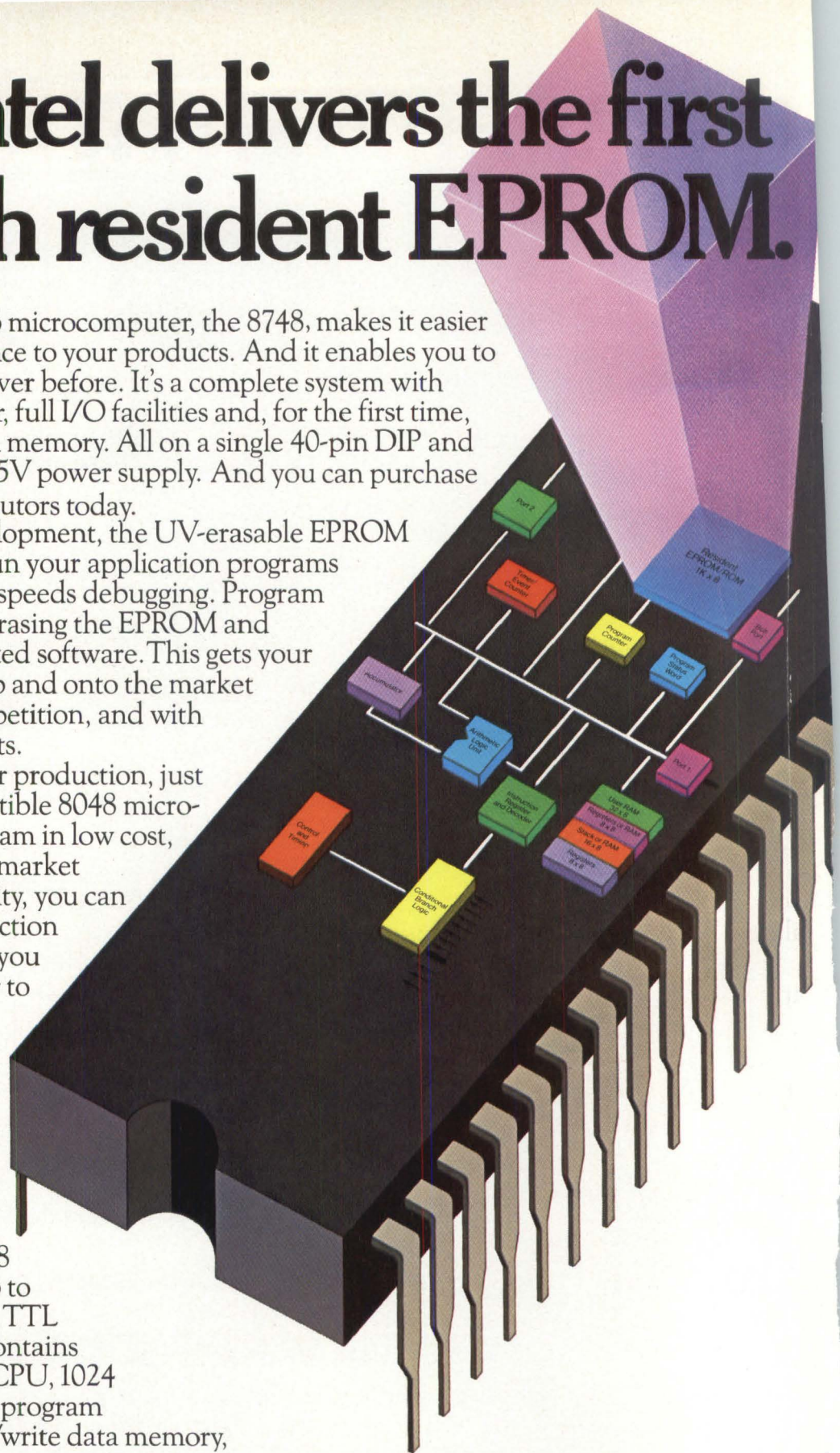

single chip microcomputer

The 8748.

three programmable 8-bit I/O ports, 8 additional control/timing lines, programmable interval timer/event counter, priority interrupts, system clock generator and a full set of system controls. It's a single chip solution to a wide variety of applications, yet it's fully expandable by adding compatible MCS-80™/MCS-85™ I/O chips and Intel® standard memories.

There's also a new 8035 microcomputer that is exactly like the 8748/8048 but without resident program memory. It enables you to precisely match system memory size to your needs, using external ROM or EPROM.

The 8748 is the best supported single chip microcomputer you can buy. To speed development there's the Intel® Microcomputer Development System with assembly language programming, symbolic debugging, and full EPROM programming capability. The ICE-48™ In-Circuit Emulation module simplifies hardware/software integration and debugging. And the Intel Prompt-48™ Design Aid is a low cost, stand alone alternative for 8748 programming, simulation and debugging. Intel supports you from prototype to production with development software, documentation, training and application assistance.

The new 8748 will give manufacturers of instruments, terminals, communications equipment, controllers, electronic games, automotive products, home appliances and hundreds of other products the competitive edge. It will help you get better products to market ahead of the competition at lower cost.

The 8748, 8035 and all compatible components can be purchased now from franchised Intel distributors: Almac/Stroum, Components Specialties, Cramer, Elmar, Hamilton/Avnet, Harvey Electronics, Industrial Components, Liberty, Pioneer, Sheridan, L.A. Varah, or Zentronics.

Or, for a copy of our single-chip microcomputer brochure write: Intel Corporation, 3065 Bowers Avenue, Santa Clara, California 95051. Telephone: (408) 246-7501.

Part No.	Description	Availability
MCS-48 Components		
8748	Single chip μ C with 1K bytes EPROM	NOW
8048	Single chip μ C with 1K bytes masked ROM	NOW
8035	Single chip μ C without resident program memory	NOW
8243	I/O Expander with 16 high current drive I/O lines	NOW
8355	ROM, 2K bytes, 16 I/O lines	NOW
8155	RAM, 256 bytes, 22 I/O lines and timer	NOW
Compatible MCS-80/85 Components		
2316E	Standard ROM, 2K \times 8, 450 ns	NOW
2708	Standard EPROM, 1K \times 8, 450 ns, light erasable	NOW
2716	Standard EPROM, 2K \times 8, 450 ns, light erasable	NOW
2111A-4	Standard RAM, 256 \times 4, 450 ns, common I/O	NOW
2101A-4	Standard RAM, 256 \times 4, 450 ns, standard I/O	NOW
5101	Standard RAM, 256 \times 4, 650 ns CMOS	NOW
8255A	Programmable Peripheral Interface	NOW
8251	Programmable Communications Interface	NOW
8214	Priority Interrupt Controller	NOW
8253	Programmable Interval Timer	NOW
8259	Programmable Interrupt Controller	NOW
8279	Programmable Keyboard/Display Controller	NOW



intel® delivers.



MODEL 70

The new standard for the CRT terminal industry from the first independent commercial CRT manufacturer.

- Microprocessor controlled
 - 80 characters X 25 lines
 - Upper/Lower case
 - Eight function keys
 - Tilt/Swivel screen
- AND MUCH MORE



*Stability
Age
Beauty*

TEC, Incorporated

2727 N. FAIRVIEW AVENUE • TUCSON, ARIZONA USA 85705 • (602) 792-2230 • TWX 910-952-1377

AN EQUAL OPPORTUNITY EMPLOYER M/F, COMMITTED TO AFFIRMATIVE ACTION — A TEC INCORPORATED CORPORATE POLICY

CIRCLE 6

THIS MONTH

Features

32

Enhancing Mini Capabilities

Dr. Robin Lake of Monolithic Systems Corp. discusses the Extended Memory Unit, a memory system for the PDP-11.

42

Where Conductive Elastomers Fit

Conductive elastomers, in use for some time as signal measurement and transmission probes, RFI shields and static arrestors, are now finding applications in digital systems.

54

What Do Logic Analyzers Do?

The 'oscilloscope of the digital world,' logic analyzers play an important role in debugging digital systems. Ken Pines tells you what they do and how to select one. Also, a manufacturer's guide and a special section on what logic analyzers are available.

78

Field Servicing Microprocessor-Based Systems

Systems built around microprocessors present unique field servicing problems; the problems they develop are often highly complex.

86

Computer Memory Technology

Completing our Benwill/Technocast coverage of memory technology, this month's report covers some of the newer technologies for data storage.



September, 1977
Vol. 7 No. 10

This month's cover story can help you get more out of your minicomputer via a memory extender. Intended to replace fixed head disks and extra core, Monolithic Systems Corporation's Extended Memory Unit is one such device. Cover illustration by Bill Zanitsch, design by J Porter.

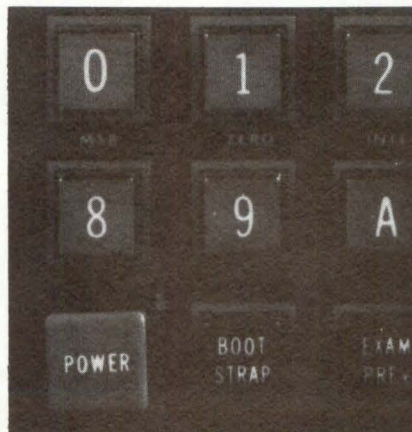
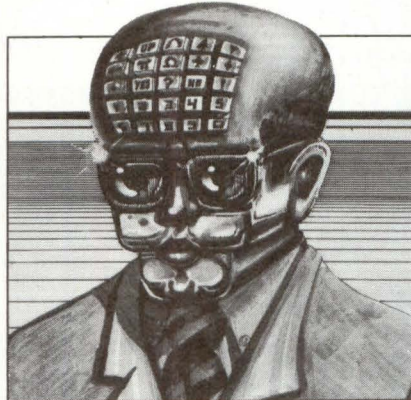

101

Using Microprocessor Development Systems

The microprocessor development system, introduced in response to the special design problems posed by microprocessor-based digital systems, plays an interactive role in the design process.

Departments

8

Memo From The Editor

12

Letters To The Editor

16

Technology Trends

48

Viewpoint

Are Engineers Really Different?

106

Product News

123

Advertiser's Index

124

Alpha Bits

Published monthly by Benwill Publishing Corp., 167 Corey Rd., Brookline, MA 02146. Application to mail at controlled circulation rates is pending at Waseca, MN 56093.

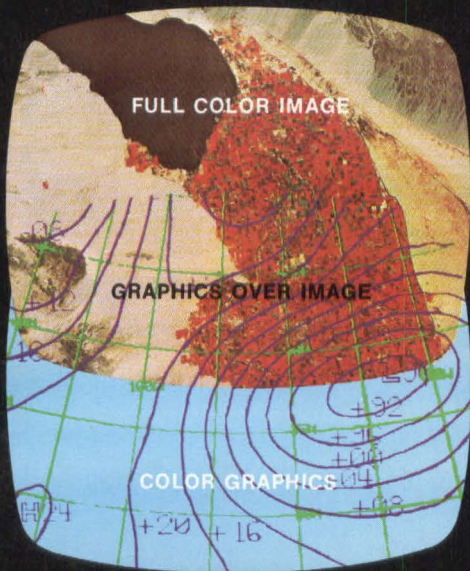

There's only one thing
about Genisco's full
color display systems
that isn't on the high side.

Their low price.*

High in performance, versatility, reliability, processing speed and data display density. These are just some of the highpoints that put Genisco's fully programmable GCT-3000 Series a whole generation ahead of stroke-writer and storage tube display systems. And they're expandable, so you can get "on-line" now at minimal cost, and make additions as the need arises. Check these feature highlights:

- Fully Programmable Microprocessor
with 150 ns Cycle Time**
- Fast Access MOS/RAM Refresh Memory**
- Automatic Color Circumfill**
- Selective Erase and Zoom/Scroll**
- 256 to 640 Elements per Scan Line**
- Up to 16 Bits per Pixel**
- Automatic DMA Access**
- High-Resolution Grey Scale Versions Too**

*All these highs, yet the basic GCT-3000 is priced on the low-profile pocketbook side — \$6,000 in OEM quantities; \$7,500 singly.

So contact Genisco, a name that has stood for technological leadership over the past 30 years, and get the whole story.



GENISCO COMPUTERS
A DIV. OF GENISCO TECHNOLOGY CORPORATION

17805-D SKY PARK CIRCLE DRIVE, IRVINE, CA 92714 • (714) 556-4916

Digital Design

The Magazine of Digital Systems

Publisher Yuri R. Spiro
Editorial Director Harold G. Buchbinder
Editor George King

Associate Editors William Belt
Jeff Spirer
West Coast Editor Henry K. Simpson, Jr.

Art Director J Porter
Assistant Editor Carol Baran

Staff Artists Mike Barisano
Jane Higgins
Mary Ann Parker
Rene Stawicki

Production E. Storm
Merrie Buchbinder
Joe Gillis
Joe T. Ingram

Composition Nancy Aldrich
Jonna Yager

Circulation Samuel Freedenberg
Regina Harrington

General Administration Esther Shershow
Sarah Binder
Marion Pearlman
Charles Vigilante
Joy Wallens

West Coast Editorial Office: George King, 442 Begonia, Corona del Mar, CA 92625. (714) 675-7123, (213) 454-0624.

SUBSCRIPTION POLICY

DIGITAL DESIGN is circulated only to qualified research, development and design engineers in all branches of industry, government institutions and universities. To obtain a complimentary subscription, request (on company letterhead) a qualification card from Circulation Director. For change of address; attach old address label from recent issue to new company letterhead or note telling us what your old address was; send this plus request for new qualification card to:

Circulation Director
DIGITAL DESIGN
167 Corey Road
Brookline, MA 02146

Subscription rates: Domestic subscriptions for non-qualified subscribers, groups, libraries or companies, \$25.00 per year. Foreign subscriptions, \$35.00 per year.

DIGITAL DESIGN solicits editorial material and articles from engineers and scientists. Contributors should submit their manuscripts in duplicate and typed with two spaces between lines. All illustrations should be clear; components on all schematics and line drawings should be labeled. The editors assume no responsibility for the safety or return of any unsolicited manuscripts.



PRINT RUN
OVER 51,000

Published monthly by Benwill Publishing Corporation, Harold G. Buchbinder, Chairman of the Board; George Palken, President; Esther Shershow, Treasurer, Executive, Editorial and Subscription Offices, 167 Corey Rd., Brookline, MA 02146. Telephone: (617) 232-5470.

The age of array processing is here...



and FLOATING POINT SYSTEMS is the array processor company.

- SIMULATION
- IMAGE PROCESSING
- GRAPHIC RESEARCH
- SPEECH PROCESSING
- METEOROLOGY
- SIGNAL PROCESSING
- VIBRATION ANALYSIS
- and MORE

FLOATING POINT SYSTEMS' ARRAY PROCESSORS provide the high throughput required for computer systems used in scientific, engineering, and signal processing applications. They can increase the throughput of minicomputers up to **two hundred** times...of maxicomputers up to twenty times. Yet the AP-120B system is typically less than \$50K.

While the conventional, scalar computers of today require the restructuring of algorithms to fit the computer, the architecture and instruction set of FPS Array Processors are specifically designed to accommodate algorithms in both scalar and vector form.

Floating Point Systems' Array Processors offer high reliability (more than 3600 hours MTBF) and compactness (only 26 $\frac{1}{4}$ " high in a 19" rack). They are found in shipboard and mobile installations, as well as computer rooms throughout the world.

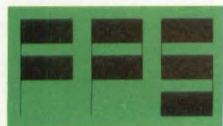

FLOATING POINT SYSTEMS, INC.

CALL TOLL FREE 800-547-1445
P.O. Box 23489, Portland, OR 97223
(503) 641-3151; TLX: 360470 FLOATPOINT PTL

FAST: 167 nanosecond multiply/add...2.7 millisecond 1024 point FFT.

EASY PROGRAMMING: More than 150 routines callable from FORTRAN or the AP assembly language. Its symbolic cross-assembler and simulator/debugger helps you create new routines.

COMPATIBLE: Interfaced to all popular computers and their operating systems. A flexible format converter translates data to and from the host CPU. And a high speed DMA port is available to use with other peripherals.

HIGH CAPACITY: 8k to 1 megaword of 167 or 333 nanosecond 38-bit memories.

PRECISION: 38-bit floating-point arithmetic, normalized and convergently rounded, produces eight decimal digit accuracy, not just six.

RELIABLE: Goes where your CPU goes—computer room, lab, or in the field.

FULL SUPPORT: All the software, installation and operation manuals, and consultation you need goes with your Floating Point Systems' Array Processor.

ECONOMY: A small fraction of what you must otherwise spend for comparable computing power.

Discover how Floating Point Systems has brought THE AGE OF ARRAY PROCESSING.



Please send me the ARRAY PROCESSOR BROCHURE with PRICE LISTS.

Name _____ Title _____

Company _____ Phone _____

Address _____

City _____ State _____ Zip _____

My Computer System is _____ My application is _____

punched tape readers

operating at ANY rate from 0 to 1,000 ch/s are available in 2 weeks from CHALCO for as low as \$250.00

Since 1957 CHALCO has delivered thousands of readers for many applications. Highly reliable, they will read ANY punched tape material . . . and ANY format interchangeably. They have MSI buffer memory, TTL I/O signals, and many other technical features. When you're serious about reading punched tape, read our FREE brochure. Or take advantage of our application and design services. Call or write CHALCO today.

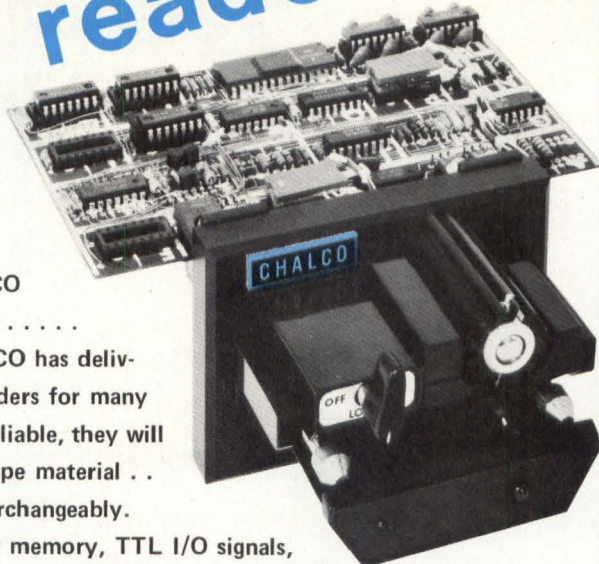

CHALCO ENGINEERING CORPORATION

15126 SOUTH BROADWAY • GARDENA, CA 90248
TEL: (213) 321-0121 • TWX (910) 346-7026

CIRCLE 9

ROYTRON™ plug-compatible reader/punch

Desktop combination reader/punch with serial asynchronous RS-232C compatible interface. Designed to operate with a terminal device on the same serial data lines or alone on a dedicated serial line. Reader will generate data at all standard baud rates up to 2400 baud.

Punch accepts data at all standard baud rates up to 600 baud continuous or 4800 baud batch, utilizing a 32 character buffer.

Two modes of operation are provided: *Auto Mode* — Simulates Model ASR 33 Teletype using ASCII defined data codes (DC 1, 2, 3 and 4) to activate/deactivate the reader or punch; *Manual Mode* — Code transparent mode. Panel switches control activation/deactivation of reader or punch and associated terminal device.

Tape duplication feature is provided by setting unit to LOCAL mode.

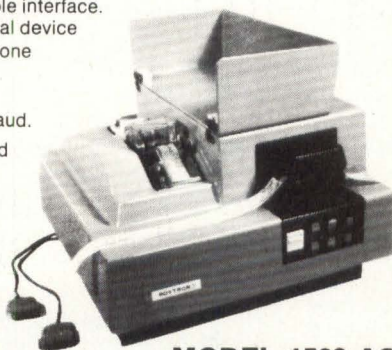

MODEL 1560-AS

High-speed, compact, with self-contained electronics and power supply. Complete in attractive noise dampening housing.



For full details, write or call us.

SWEDA INTERNATIONAL, INC.
Litton OEM Products

34 Maple Avenue, Pine Brook, N.J. 07058/(201) 575-8100
IN U.K. — ADLER BUS. SYSTEMS/OEM PRODS., Airport House, Purley Way, Croyden, Surrey, England
IN FRANCE — SWEDA INTERNATIONAL/OEM, 103-107 Rue de Tocqueville, 75017 Paris, France

CIRCLE 10

MEMO From The Editor



Associate Editor Spier

Growth and change—these two key words are as important to us, the journalists of the digital electronics industry, as they are to the industry itself.

Thus, **Digital Design** must grow and change: this month we add two Editors and take on a new look. The new editors will help us stay on top of the developments that you are interested in, and the new appearance will make it easier and more enjoyable for you to read **Digital Design**.

Joining **Digital Design** as West Coast Editor, Henry K. Simpson brings an extensive background in technical writing and communication. Henry holds a B.S.E.E. from San Diego State University and an M.A. in English from the University of California at Santa Barbara. He has worked as an engineer in the research industry and is the author of more than twenty technical reports and publications. Also an engineer by training, Carol Baran serves as an Assistant Editor of **Digital Design**. Carol received a B.S. in Mechanical Engineering from Worcester-Polytechnic Institute and has studied Science Communication at Boston University.

Our Art Director, J. Porter, takes full responsibility for redesigning the magazine. Shortly after joining our staff in April, J. began the difficult task of giving us a new look; this job is now completed.

Jeff Spier

At only \$1088,* you can't offer your customers a better buy.



* Our quantity-50 OEM price for the *Silent 700*† Model 743 KSR Terminal is now just \$1088. In larger quantities, the price goes below \$1000.

And it keeps on costing less because the real payoff is in the cost of ownership. In the long run, it costs less than any other printer terminal with comparable performance.

The reason is easy. Superior design. The 743 KSR is built around a TI microprocessor. So, there are fewer components and circuit boards than in other printer terminals. That means less maintenance and more uptime performance. Plus standard EIA and current loop interfaces in a lighter, desk-top package.

The 743 features the speed, reliability and quietness that made the *Silent 700* terminal family so popular. Incoming data is buffered, so you get true 30-character-per-second throughput.

Data entry. Interactive remote computing. Or as a message terminal network. And it's now available with APL. The 743 is backed by TI's worldwide maintenance and support services.

Find out more about TI's 743 KSR printer terminal. Fill out and mail the coupon today. Or call your nearest TI sales office, or Terminal Marketing, (713) 494-5115, extension 2126.



TI's Model 743 KSR

Disturbing noises associated with impact printers are eliminated with the 743's non-impact electronic printing.

Use it as a console I/O for software development. Keyboard terminal for inquiry/response.

TEXAS INSTRUMENTS
INCORPORATED

Yes! I am interested in the 743 KSR Printer Terminal.

Please have your representative call me.

Please send me more information.

Name _____

Title _____

Company _____

Phone _____

Address _____

City _____ State _____ Zip _____

Mail to: Texas Instruments Incorporated, P.O. Box 1444, M/S 784,
Houston, Texas 77001

2-9-DD

SILENT 700
electronic data terminals

† Trademark of Texas Instruments

©1977, Texas Instruments Incorporated
*U.S. Domestic Price

TEXAS INSTRUMENTS.

You've designed, debugged, and loaded your system software. Now you need several powerful capabilities to ensure trouble-free execution on the prototype: the ability to look at data in different ways . . . to compare known good data with new data quickly and easily . . . to analyze both system and peripheral-interface timing.

The TEKTRONIX 7D01F Logic Analyzer offers you all those capabilities in a single instrument.

Look at data in different ways.

The 7D01F lets you choose from five display modes: maps; state tables in hexadecimal, binary, or octal code; or timing diagrams. How often have you encountered a problem you knew you could spot just by scanning overall program flow? How often have you wished you could compare state tables in the hexadecimal code you work with as well as the binary code your microprocessor knows? How often have you wanted to switch from a state table display to its corresponding timing diagram? The 7D01F can help at each step of this troubleshooting procedure.

Troubleshooting a microprocessor-based system is easier...

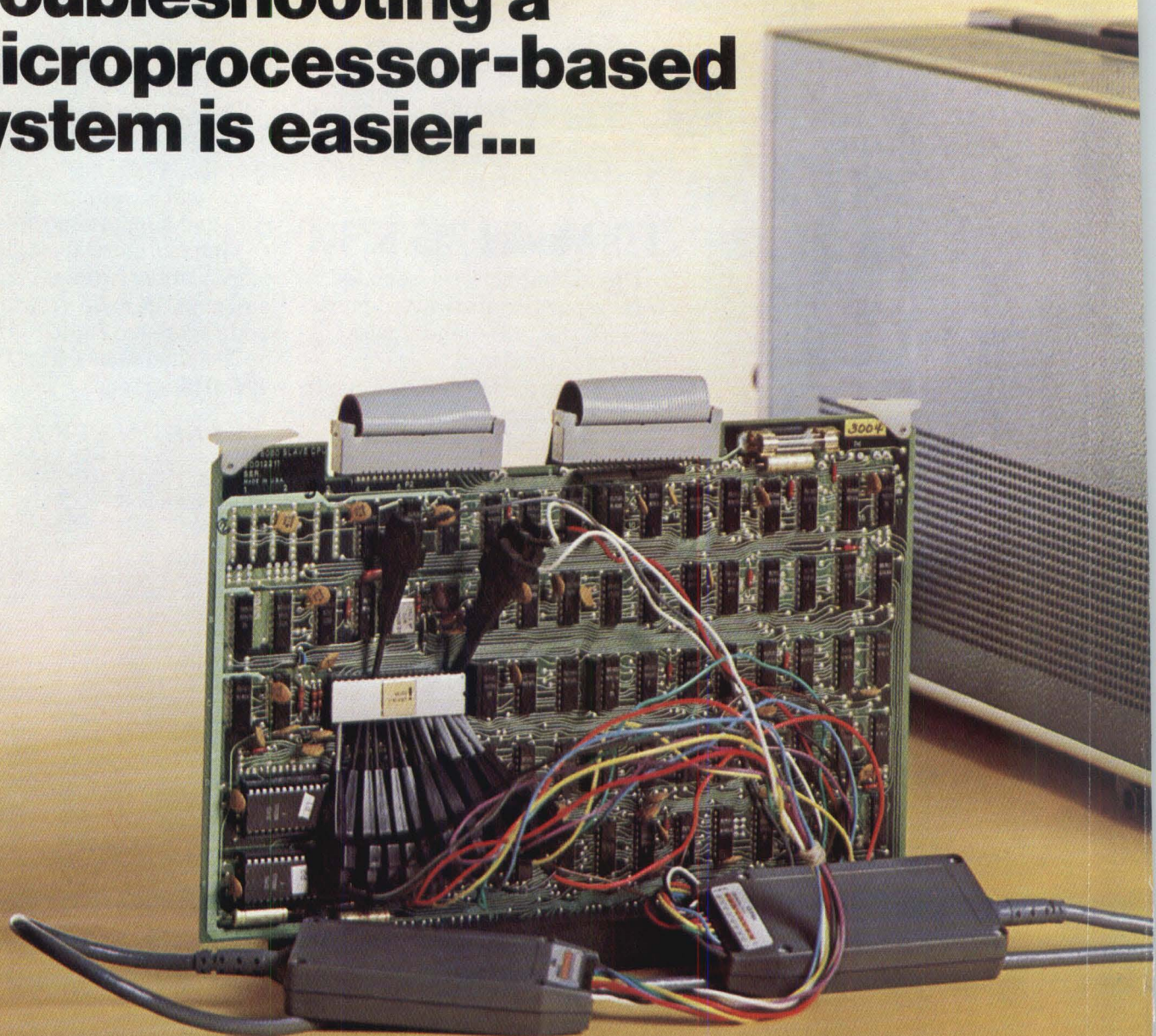

Compare known good data with new data.

The 7D01F features two comparison modes which facilitate in-depth software/hardware debugging. The EXCLUSIVE-OR and RESET-IF modes speed up what would otherwise be a very tedious process: checking the program flow chart against what falls out when the program is run.

For an EXCLUSIVE-OR comparison, simply verify known good data, store it in reference memory; acquire new data, and select a table comparison mode. The reference table and the compared table (which may be in hex, octal, or binary) will be displayed side by side, and the differences between the two will be highlighted for ready identification.

Use RESET-IF to track down an intermittent fault. In this mode the 7D01F can automatically acquire and compare up to 4096 bits of new data to 4096 bits of reference data. Data is continually reacquired until a mismatch occurs. If there is a mismatch, the instrument holds the display, highlights the differences, and displays the number of resets that occurred. This frees the operator from continually monitoring for wandering programs, intermittent loops, or ragged-edge timing problems.

Analyze system and interface timing.

The 7D01F offers synchronous data acquisition at speeds up to 50 MHz. But it is sometimes necessary to view microprocessor operation with increased timing resolution, as well as to locate timing discrepancies in the system's interface with the outside world. You may, for example, need to asynchronously examine data coming into the I/O port before you can determine whether incorrect information is coming from the I/O port itself or the hardware on the other side. The 7D01F offers asynchronous data acquisition at sample intervals of up to 100 MHz.

...with the Tektronix 7D01F Logic Analyzer.

All these unique features are available only in the TEKTRONIX Logic Analyzer. To find out more about how the 7D01F can simplify your work with microprocessor-based systems, just call your local Tektronix Field Engineer. He'll demonstrate the 7D01F in your application, and acquaint you with its many other features, including 16-channel word recognition, 1M Ω /5 pf logic probes, 16-channel data acquisition, 4k formattable memory, and 7000-Series mainframe compatibility.

You should also send for our newest application note, describing in detail how a 7D01F can be used with microprocessor-based systems. Write Tektronix, Inc., P.O. Box 500, Beaverton, Oregon 97077. In Europe, write Tektronix Limited, P.O. Box 36, St. Peter Port, Guernsey, Channel Islands.

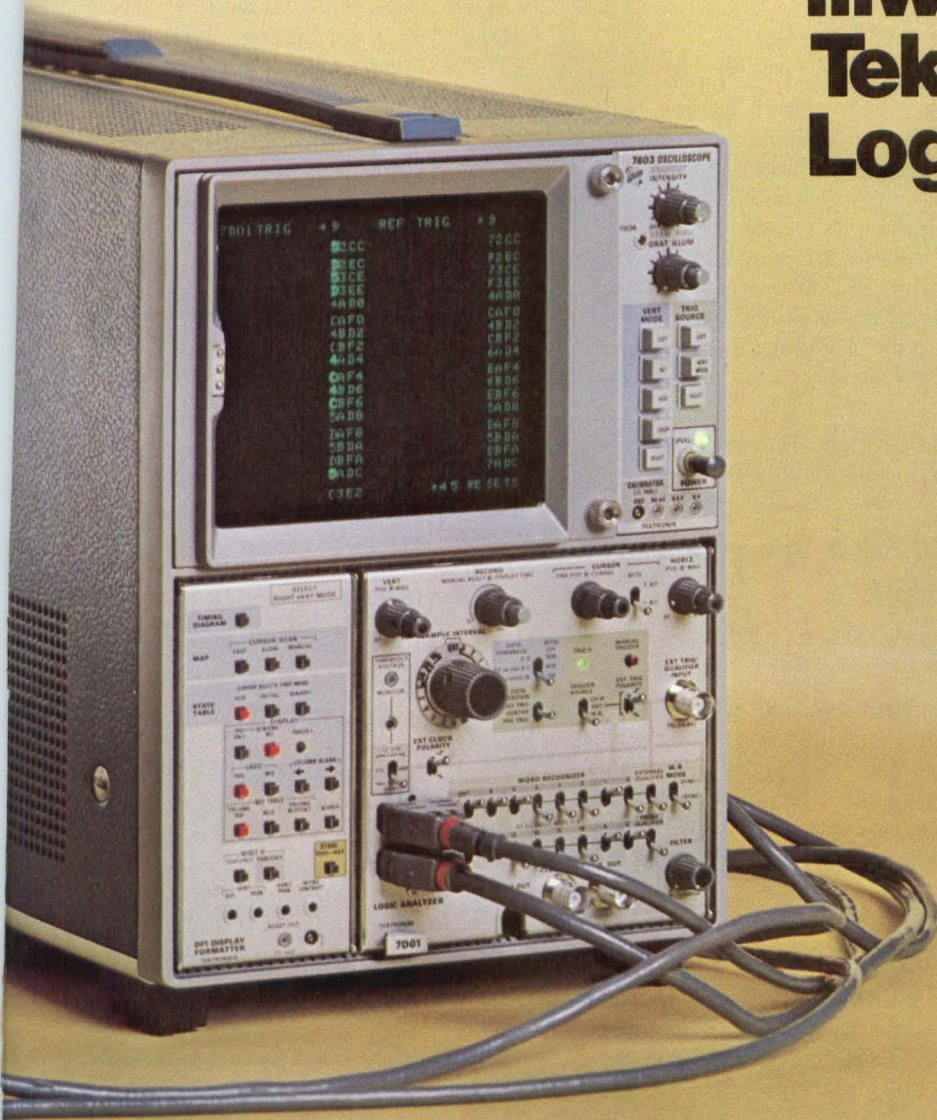

LETTERS

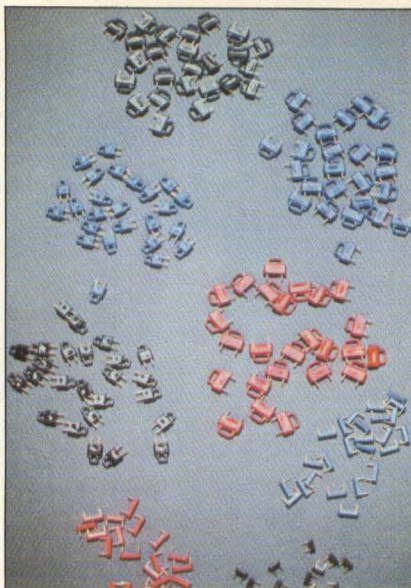

Uses are jumping for our low cost switches.

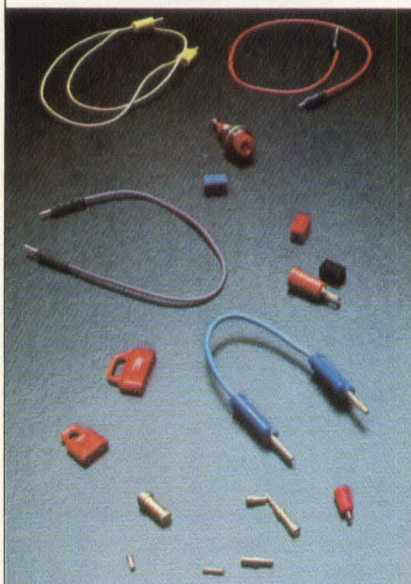

Tiny jumpers mated to spring-loaded receptacles are increasingly popular for use as low-cost highly reliable circuit switches. In longevity tests they easily passed 50,000 insertion/extraction cycles. Color coded and positive position indication adds to their usefulness and application possibilities. To help you put them to use, we offer a catalog, samples or a call from a sales engineer if you wish. Write: Cambridge Thermionic Corporation, 445 Concord Avenue, Cambridge, MA. 02138. Phone: 617-491-5400. In California: 2733 Pacific Coast Hgwy., Torrance, CA 90505. Phone: 213-326-7822.

Standardize on

CAMBION[®]
The Guaranteed Electronic Components

CIRCLE 13

Yes to no-language

Dear Editor:

We were interested in the Viewpoint by Karl Amatneek, 'Assembling the No-Language: Another Proposal' (June 1977). Diversified Technology has had available for approximately a year such a no-language device which we call a 'keytop assembler'. In fact our equipment appeared in DIGITAL DESIGN Product News (July 1976).

Gerald Youngblood
Diversified Technology
Rigeland, Mississippi 39157

List missed disks

Dear Editors:

In your Diskette Drive Buyer's Guide (June, 1977, p. 89) it was indicated that Wangco manufactures only mini-diskette drives. In fact, Wangco's Orbis Division manufactures IBM-compatible and double density standard size diskette drives. In addition Wangco offers flexible disk subsystems, controllers for standard and micro-floppys, micro-media and the micro-floppy diskette drive.

Bill Miller
Orbis Division, Wangco
Los Angeles, California 90066

Radiation mangles stored data?

Dear Editor:

Your item about the effects of nuclear radiation on magnetic storage media (June, 1977, p. 24) states that radiation will not affect the data but will degrade the plastic base over a long period of time and that fields strong enough to damage the base material are a human safety hazard and are unlikely to be encountered. However if radiation is from a pulse reaction rather than a continuous source, a strong electromagnetic field may exist for a short time. Depending on the size of the reaction and the distance and shielding considerations, the intensity of this pulse may be strong enough to change the data stored on the magnetic me-

dia. The short period of the pulse usually does not cause cell tissue damage and the question of human safety is likely to depend upon the other nuclear particles from the reaction. Although such a reaction is unlikely to occur during the normal operation of a controlled source such as a power plant reactor, strong electromagnetic fields must be considered for military and other critical applications.

Mike Hordeski
Siltran Digital
Silverado, CA 92676

Lost line

Dear Editor:

In my article on digital sequencers (May, 1977), one line was omitted. The text on page 78 should read:

Inconditional Jump. Disregarding the input lines X_i , the next state *does not correspond* to the next bistable in the register: consequently...

Angelo Yong
Universidad San Bolivar
Sarteneja-Caracas, Venezuela

Cassette left out

In the listing of cassette manufacturers (Digital Design, June, 1977), we inadvertently omitted MFE Corp., Kee-waydin Drive, Salem, New Hampshire, 03079.

In addition to the Model 250 digital cassette tape transport, MFE recently introduced a floppy disk drive, the Model 700/750.

Please don't call

In the July issue of DIGITAL DESIGN, we reported that CBS Laboratories was researching laser deflection and developing a piezoelectric device for laser beam deflection. This is an error; we apologize to the CBS Technology Center (formerly CBS Laboratories) and ask that readers do not contact them with regard to this.

All letters should be signed and are subject to editing for length, libel and standards of good taste. Signature may be omitted upon publication if so requested.

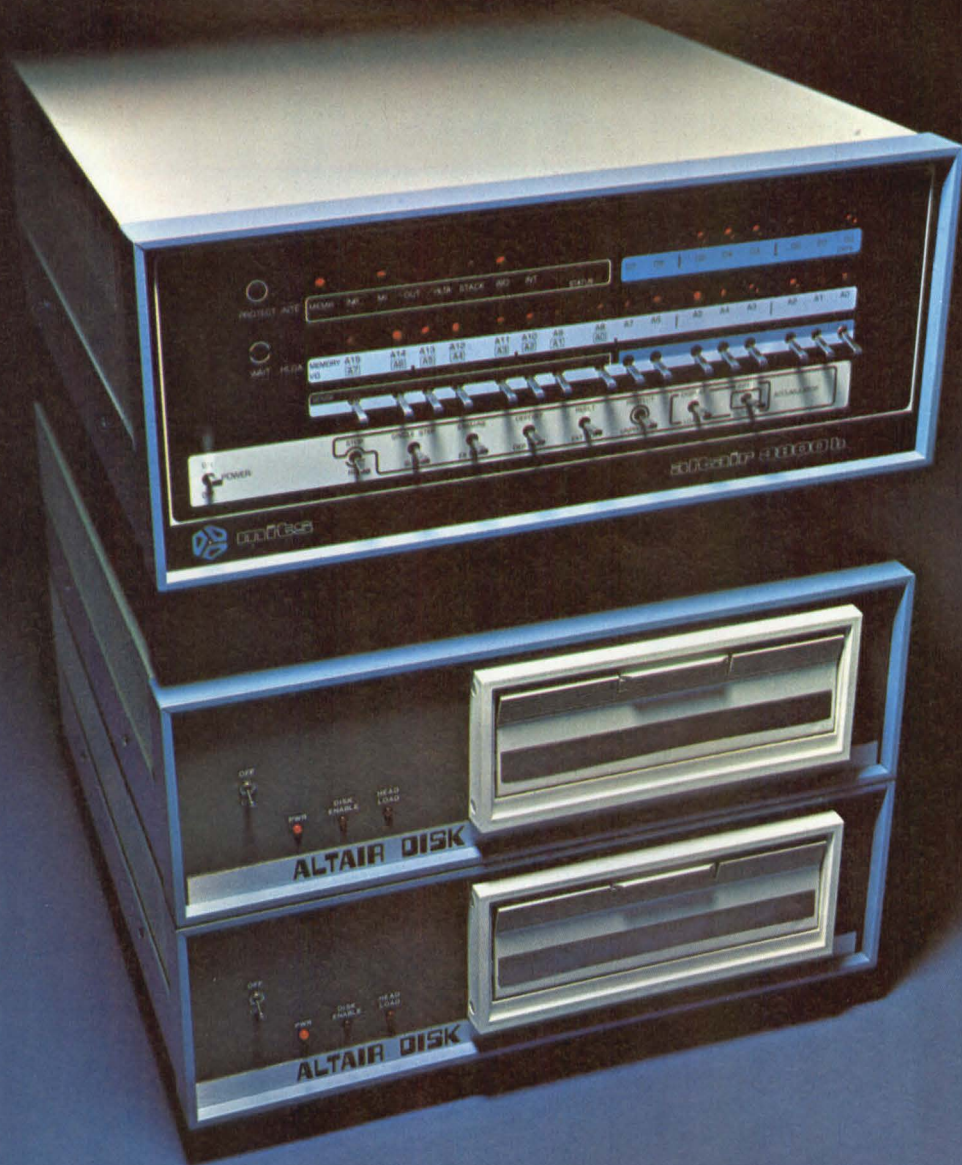

altair™ floppy disk system

Disk capabilities can transform an ordinary microcomputer system into one of infinite magnitude. By introducing one Altair Floppy Disk System (88-DCDD), your 8800 series system acquires a mass storage capacity of 310,000 bytes per diskette.

The 88-DCDD includes a disk drive, controller, power supply, interconnect cable and case. Featuring a Pertec FD-400, the disk drive unit has direct drive dc motor operation which is insensitive to disrupting line frequency variations.

Up to 16 disk drives may be interfaced with the Altair Disk Controller. Consisting of two PC cards that plug into the Altair 8800 bus, the

Disk Controller regulates all mechanical operations and disk status.

Two software systems are available for the Altair Floppy Disk. Altair Disk BASIC offers the many features of Altair Extended BASIC plus increased program and data file load/save facilities. Our new DOS provides comprehensive tools for assembly language program development and disk file maintenance.

See the Altair Floppy Disk System along with the complete Altair product line at your local Altair Computer Center, or contact the factory for further information.



2450 Alamo SE Albuquerque, N.M. 87106

A high-magnification photograph of a microchip die, showing a dense grid of circuitry and a central rectangular area. The die is dark blue with intricate gold-colored patterns.

**Your next high-speed
programmable memory
just doubled its density.**

Again.

The 16K PROM.

BIPOLAR PROM PROGRESS: Last year, we invented 8K. This year, we invented 16K. Next year, they'll both be industry standards.

Signetics' acknowledged technological leadership in Bipolar PROMs just took another lengthy stride forward.

Just over a year ago, we announced the world's first field-programmable Bipolar PROM with 8K memory capacity. It was news then, and it's an industry standard now.

Here's even more important news for users of high-density memories—the 16K PROM is a reality. It's the 82S190/191— from Signetics.

More than a Larger Memory. The 16K PROM has a lot more going for it than just raw storage. Like speed, for example—although it has twice the density of its 8K cousin, it's almost as fast, with a maximum address access time of only 80 nsec. Current drain, though, is unchanged—at 175 mA. That's a big advantage for you—half the power per bit, twice the storage capacity.

Like most of its smaller cousins, the 16K PROM is available with two output options: The 82S190 is Open Collector, the 82S191 is Tri-State. That means you can choose the output you need for optimizing word expansion in bused organizations.

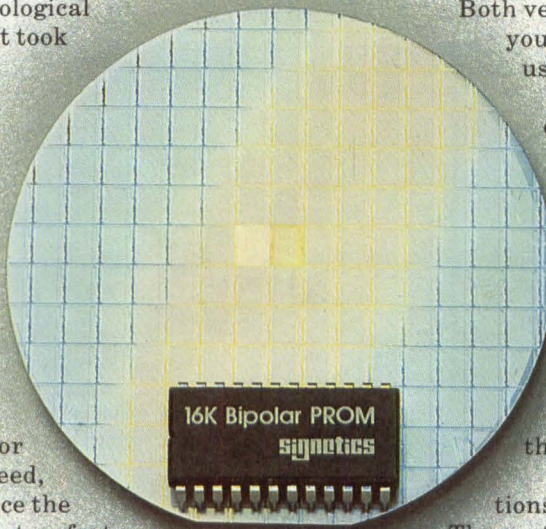

Both versions are field-programmable, so you can produce custom patterns by using prescribed fusing procedures.

On-chip decoding and three chip-enable inputs are also provided, permitting easy memory expansion.

Signetics—Your Supermarket for PROMs. The partial listing of

PROM products in the table below will give you a fair idea of why Signetics stands at the forefront of high-speed PROM technology. Each of the types listed is available in economical Power Plastic DIPs or packaged for use in the military temperature range.

Take a closer look at the specifications shown. There's a lot there to find.

The parts themselves can be found on your distributor's shelves. Call him today or use the coupon below to order additional evaluation data.

The 82S190/191 is available now in limited sample quantity. Full production due in January 1978.

signetics

a subsidiary of U.S. Philips Corporation

Signetics Corporation
811 East Arques Avenue
Sunnyvale, California 94086
Telephone 408/739-7700

SIGNETICS PROM SELECTION GUIDE (4K & ABOVE)

Size	Organization	Type	Output*	Pins	Max. T _{AA} (ns)	Max. I _{CC} (mA)	Key Benefits
4K PROMs	1024 x 4 (4096)	82S136	OC	18	60	140	High speed.
		82S137	TS	18	60	140	
	512 x 8 (4096)	82S115	TS	24	60	185	High speed. Has built-in latch.
		82S140	OC	24	60	175	Four chip-enable inputs for easy memory expansion.
		82S141	TS	24	60	175	
		82S146	OC	20	45	155	Fastest available 4K PROMs. .3" wide pkg. saves space.
82S147	TS	20	45	155			
8K PROMs	2048 x 4 (8192)	82S184	OC	18	100	120	Low current drain.
		82S185	TS	18	100	120	
	1024 x 8 (8192)	82S180	OC	24	70	175	High speed.
		82S181	TS	24	70	175	
		82S2708	—	24	70	175	
16K PROMs	2048 x 8 (16,384)	82S190	OC	24	80	175	16K capacity with drain of only 175mA. 80nsec speed.
		82S191	TS	24	80	175	

* OC - Open Collector; TS - Tri-State

To: Signetics Information Services, 811 E. Arques Ave. DD9
P.O. Box 9052, MS 27, Sunnyvale, CA 94086

- Please send me technical data on the 82S190/82S191 16K PROM.
- I'd like additional data on the _____ (type).
- Send me general product reference material on all PROMs, including those with smaller capacities.
- I have an urgent requirement. Please have a PROM specialist phone me at once: () _____

Name _____ Title _____

Company _____ Division _____

Address _____ MS _____

City _____ State _____ Zip _____

TECHNOLOGY TRENDS

DVST Technology Competes With Directed Beam

Designers of graphic display systems traditionally make heavy demands on the various display technologies, requiring high resolution (addressability), high vector density and maximum display interactivity (refresh), all at the lowest possible cost. According to Tektronix Corp. of Beaverton, Oregon, of the four presently available technologies — DVST, plasma, directed beam and video (raster) — only DVST and directed beam displays come close to meeting these demands. Both offer inherently high resolution (typically 60 to 100 addressable points per linear inch) and high vector density (several thousand inches of stored/refresh vector). The major difference between DVST and directed beam display is cost. DVST offers high resolution, high vector density displays at low cost. The cost of directed beam systems runs much higher, Tektronix says, because of the dependence on expensive refresh memory. Thus, even without refresh, DVST displays hold a significant position in the graphic display marketplace.

The two technologies have existed side-by-side in the graphic display market for a number of years; users choose between them on the basis of cost versus refresh. With the decline in the cost of refresh memory, directed beam displays appear to be gaining an edge. However, with the development of write-through, a technique allowing combined refresh-storage display, Tektronix is now confident that DVST displays will maintain their favorable cost/performance edge over directed beam, plasma and video displays. Write-through reduces beam intensity to just below the storage level of the DVST phosphor, allowing information to be written on the phosphor without storing. Using greater beam potential and high speed amplifiers, Tektronix produces up to 1200 inches of refreshed

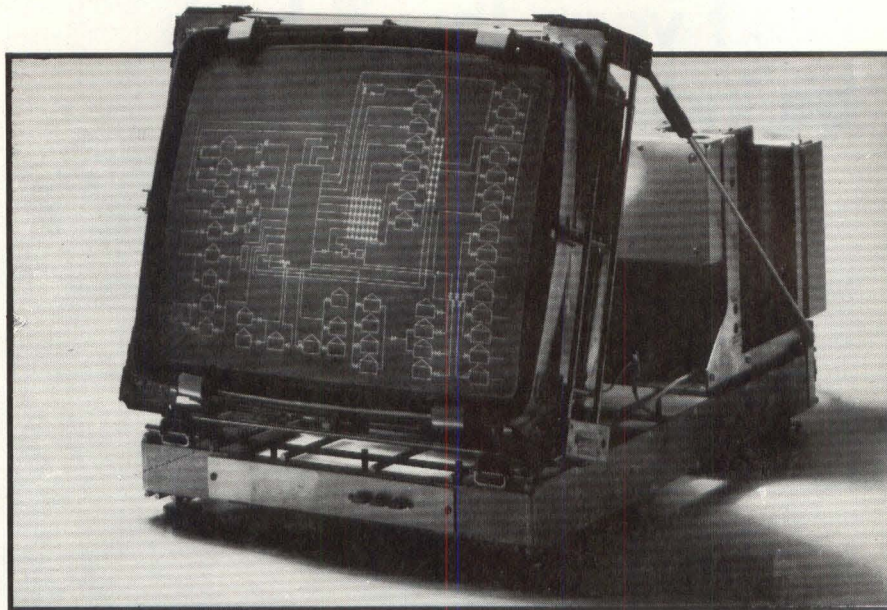

The GMA102A graphic display system uses a high speed vector character generator to provide up to 1200 inches of refreshed vector.

vector with their new graphic display module, the GMA102A, while still maintaining display storage capability.

The GMA102A 19" display offers a practical mix of performance, packaging and support options. The mechanical design uses the popular wireform-type construction and modular layout. Performance options include plug-in vector and character generator circuit cards; the unit may be ordered with either horizontal or vertical orientation. Electrically, the GMA102A operates with digital electronics except for the X and Y inputs; the interface is TTL-compatible.

Applications. When selecting a graphic display for their application, graphic system designers have traditionally asked the question, 'Do I need refresh?' With the advent of the GMA102A, Tektronix feels that the question becomes, 'How much refresh do I need?' A little ingenuity, they say, leads to the answer, 'Surprisingly little.'

One application considers computer-aided circuit board layout. Circuit boards are designed in layers; to display all the runs and pads of a six layer board in refresh requires a considerable refresh memory. Tektronix points out that the GMA102A permits laying out the circuit board in refresh, one layer

at a time. Thus, selective editing is possible while building the layer. When all runs and pads for a layer are established, that layer is stored and the next layer is built in refresh. A high resolution, high density circuit board system results, using only one-sixth the refresh memory required to design the same system with a directed beam display, Tektronix claims.

Another system presently using write-through involves a finite-element modeling system, used to build three-dimensional models for structural analysis. The software package for this system provides a menu of user commands; these commands are displayed on one side of the screen. The system also offers the ability to display parts of the model in refresh, allowing three-dimensional dynamic rotations of the model. Again, the system uses storage for those parts of the display that don't change; refresh is used for the parts that change or require selective editing.

With its combined storage-refresh capability, modular construction and performance and packaging options, Tektronix feels that the GMA102A should prove very popular in the OEM market. For further information, write Tektronix, Inc., P.O. Box 500, Beaverton, Oregon 97077, or call (503) 644-0161.

The concept and design of the Printronix 300 Impact Matrix Line Printer/Plotter offers you several remarkable cost/performance advantages.

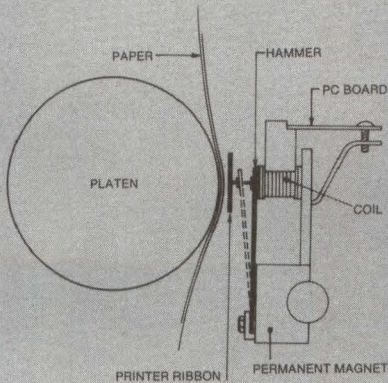

**Like the far greater MTBF
this elegantly simple
mechanism assures.**

Downtime frays nerves. It costs money, too. But take heart. You'll see a lot less of it with a Printronix 300. That's assured by its elegantly simple mechanism based on a flat strip of spring steel with a hardened tip, pictured below. Forty-four springs, or hammers, are mounted to a hammer bank. Each is fastened at one end and normally held retracted by a permanent magnet. (See the diagram.) A pulse of current thru a coil at the tip end of the hammer releases it to print a dot. The hammer bank is shuttled horizontally 0.3", enabling each hammer to cover the space between its tip and the tip of the next one, so that the total field covered is 132 columns. Aside from paper and ribbon feed, that is the only mechanical motion in the printer.

Since the Printronix 300 has 50% fewer components than mechanical font printers . . . a head life 4 to 8 times longer than serial printers . . . and never needs adjustments of hammer flight time or character alignment as drum/chain/belt printers do, you can see why it has a longer MTBF, and why we've felt comfortable offering a one-year warranty from the beginning.

Send for our brochure. You'll discover why it produces 300 lpm print quality others can't match, has a shorter MTTR, and can give you full plotting capability . . . at no extra cost! Printronix, Inc., 17421 Derian, Irvine, CA 92714. (714) 549-8272.

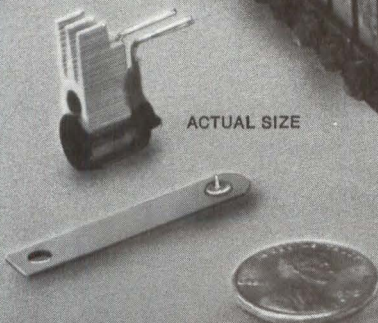
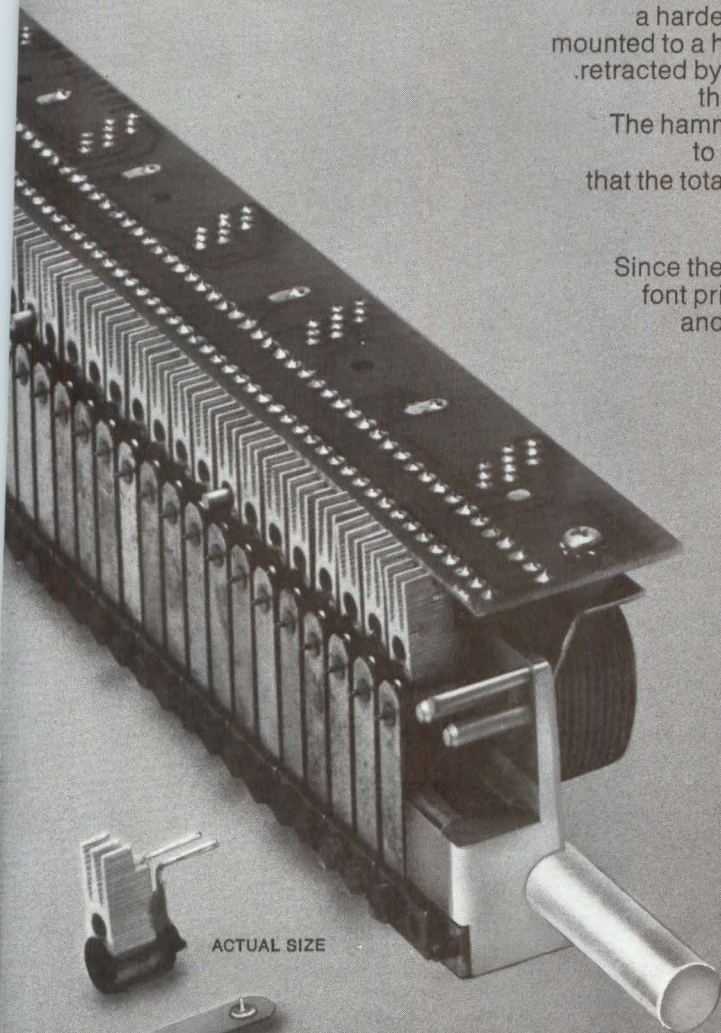

ACTUAL SIZE



PRINTRONIX 300
It's your best buy!

An Editing Pet That's

The perfect editing terminal for transaction processing must be more than a little bit smart. It has to be wise like our OWL-1200. With features that assure high accuracy source data entry, fast data editing, simplified host computer programming, and reduced host computer loading.

Our OWL gives you all the human engineering features you get with our FOX-1100, plus a lot more. And the price is right. Just \$1496 in quantities of 25.

Check the comparison chart of editing terminals to see all the reasons why the OWL-1200 is simply "incomparable."

USER REQUIREMENT FEATURES	PERKIN-ELMER	HAZEL-TINE	LEAR SIEGLER		ADDS	
	OWL-1200	MOD. 1 EDITING	ADM-1A	ADM-2	980	
High Operator Data Entry Accuracy	Protected fields Low-intensity fields Numeric only fields Inverse video fields Blink fields Line drawing capability	Yes Yes Yes Yes Yes Yes	Yes Partial No No No No	Yes Partial No No Yes No	Yes Partial No No Yes Yes	
Simple, Fast Editing of Data	Insert/delete character Insert/delete line	Yes Yes	Partial ¹ Partial ¹	Yes Yes	Yes Yes	
Minimized Loading on Host Computer	Host programmable send keys: send all data, send only unprotected data, send only data modified by operator, send only a "request to send" header.	Yes	No	No	No	
Simplified Programming	Ability of host CPU to read device status	Yes	No	No	No	
	Ability of host CPU to read device mode key settings and communication option straps	Yes	No	No	No	
	Program override on mode key settings	Yes	No	Yes	No	
Simplified Program Debugging	Transparent mode permits all characters to be displayed	Yes	No	No	No	
Cost Effectiveness	OEM price in quantities of 25*	\$1496	\$1670	\$1795 * \$1395	\$2395 * \$2095	\$1995

*When unit includes editing capabilities, 24 x 80 display, numeric pad, and upper/lower case characters.

¹No Key. Requires Two Key Code.

✦ Just announced price changes

PERKIN-ELMER | TERMINALS DATA SYSTEMS | DIVISION

Randolph Park West, Route 10 & Emery Avenue
Randolph, N.J. 07801 (201) 366-5550 TWX: 710-987-7913

Domestic, call:

(617) 890-0557 Boston, MA
(312) 437-3547 Chicago, IL
(214) 234-8880 Dallas, TX
(714) 544-9093 Los Angeles, CA
(201) 229-4040 Oceanport, NJ
(408) 249-5540 San Francisco, CA

Overseas, call:

887-1000 New South Wales, Australia
416-677-8990 Mississauga, Ontario, Canada
539-2260 Paris, France
753-34511 Slough, Berkshire, UK
089-753081 Germany
2200949 Singapore
031/450/160 Frolunda, Sweden

AVA
DEV

Wise as an Owl

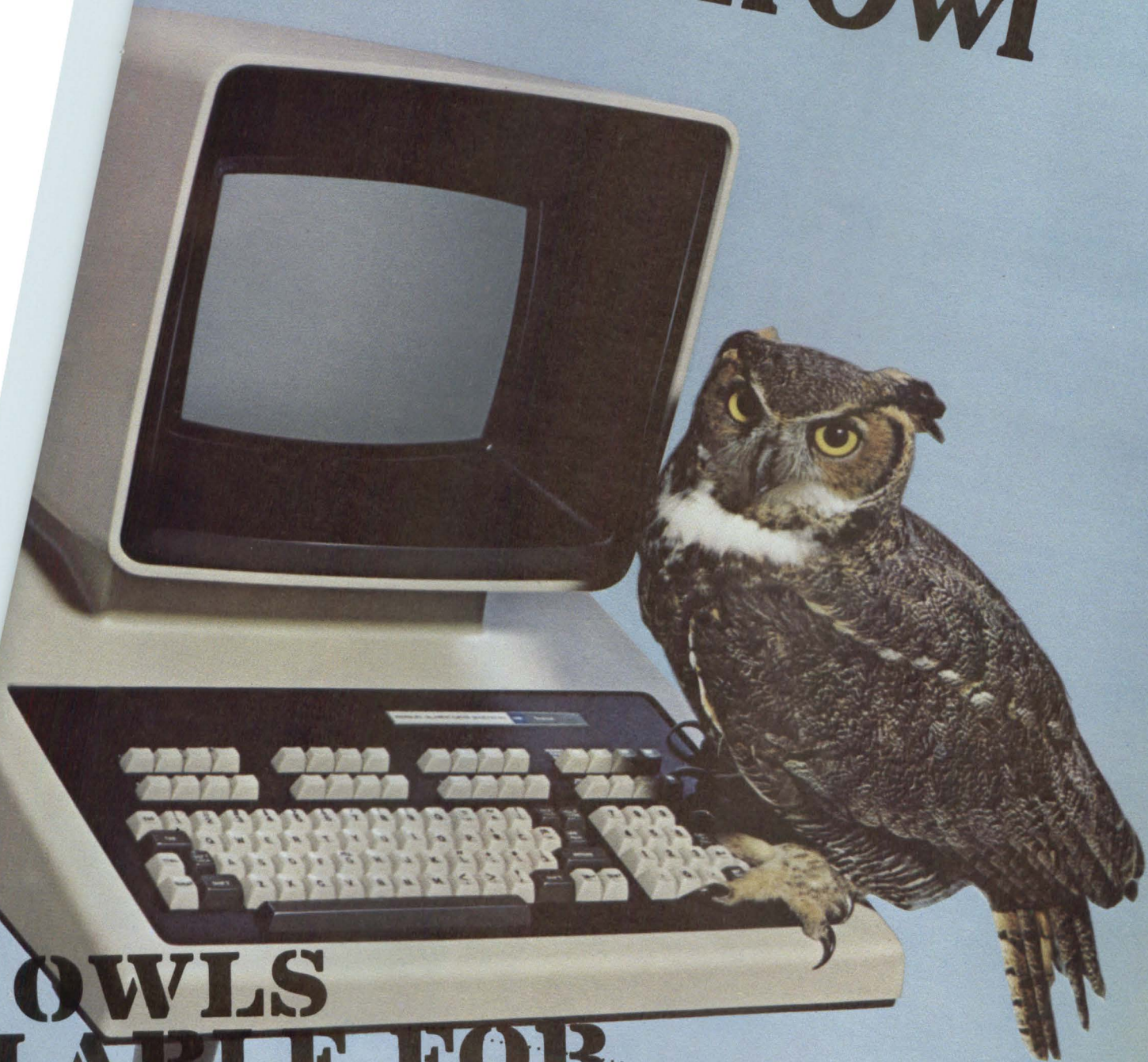

OWLS AVAILABLE FOR EVERY NOW!

Please send me more
information on the OWL 1200.
Attach your business card here.

CIRCLE 17

FCC Registered 'Protective Circuitry' Required on DAA's

The Federal Communications Commission ruled that, effective January 1, 1978, all data communications interface devices must be FCC certified as "registered protective circuitry".

Known as Data Access Arrangements (DAA), or data couplers, these interface devices connect customer-provided electronic data processing (EDP) and computer equipment with switched telecommunications networks for data communications.

The FCC registration requirement results from an FCC opinion and order (FCC Rule 68) issued in November 1975. The ruling, amended several times since its issue, includes reconsideration of policy and technical points, improvements in registration

filing procedures for data coupler manufacturers and standardization of plugs, jacks and cables for connection of telephone instruments, data and auxiliary equipment. A last minute amended tariff filing by AT&T on May 31, extended the ruling's complete implementation until January 1, 1978.

Under the ruling, EDP/computer manufacturers and users install registered data couplers to their equipment. This move allows users to purchase their own registered data couplers and other similar equipment and connect it to telephone company lines. EDP/computer equipment manufacturers can by-pass the traditional methods of interface connection by installing registered data couplers or similar registered protective circuitry directly into their product. Until this ruling, installation and ownership of data couplers for interface purposes was restricted to telephone companies when direct connection to the switched network was

desired. Installation of non-registered data couplers is still restricted to operating telephone companies.

A meeting was held June 29, 1977 for EDP/computer industry trade and business press editors at the Marriott Motor Hotel in Newton, Massachusetts. At this meeting Elgin Electronics representatives E. Joseph Seppala, marketing manager-telecommunications products and Harry A. Montgomery, vice-president-engineering, discussed the implications of the FCC ruling.

Since all DAA's, also called RPC's (for Registered Protective Circuitry), must be registered by the FCC, Montgomery outlined the steps that any company wanting to register their products must take. First, he said, the design engineer has to be educated and fully informed about the FCC design criteria. The earlier he becomes informed about FCC Part 68, the easier his designing becomes. If he finishes his design for the DAA without this information from the FCC he may have a lot of trouble getting the device registered and he may have to start over again.

Secondly, a number of tests have to be made on the finished product before application can be made to the FCC for registration. Tests for longitudinal balance, hazardous voltage, signal power limitations, timing circuits, temperature and humidity cycling and shock and vibration tests require a substantial investment in capital equipment. Laboratory personnel can easily spend 80 hours per unit running these tests, according to Montgomery.

Once the tests are completed and the device meets FCC requirements, the third step consists of documenting the test data and organizing it on paper so that the FCC sees that the device meets their requirements. Fourth, you must submit all the test forms and documentation to the FCC. Documentation includes complete schematics and photographs of the unit.

The design of the DAA's must allow for the different types of connection that the FCC has written into the technical rules. The FCC permits three means of connection. The first, called "permissive level", alludes to the power level to be transmitted over the switchboard network. The protective circuitry accepts the output of the modem, a tone device, and regulates it so that the noise level going to the

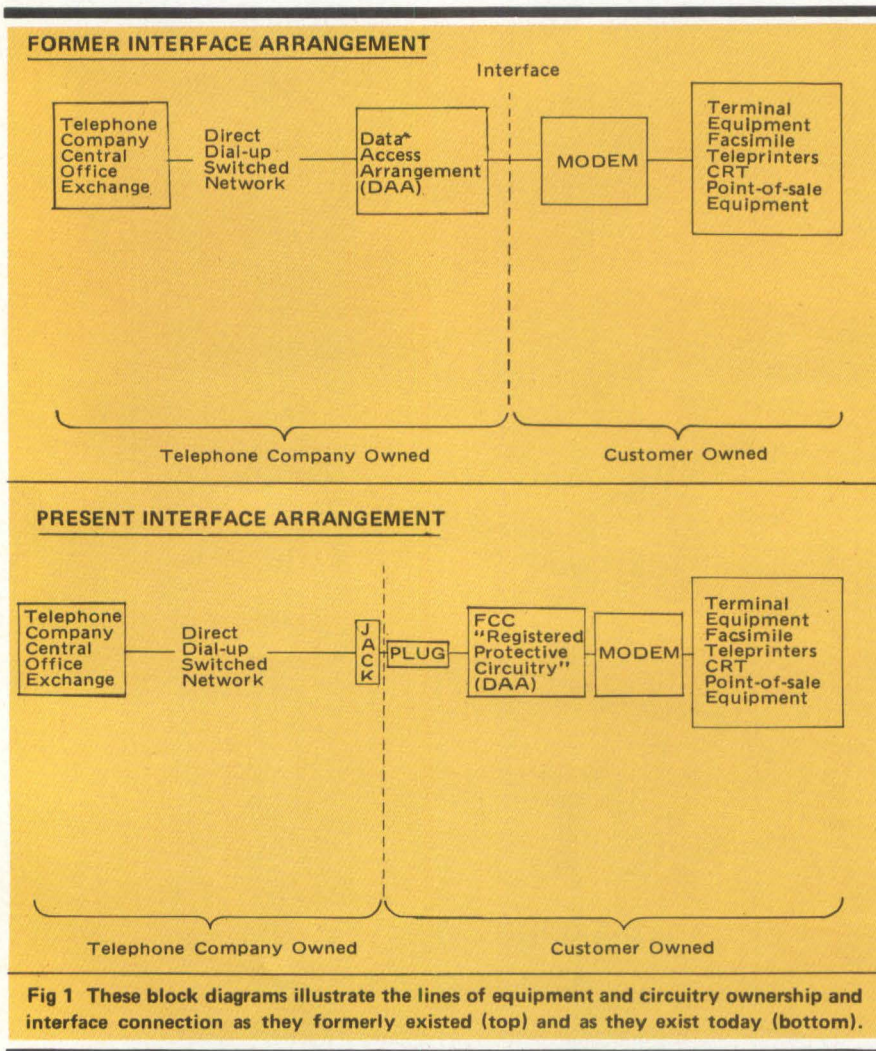
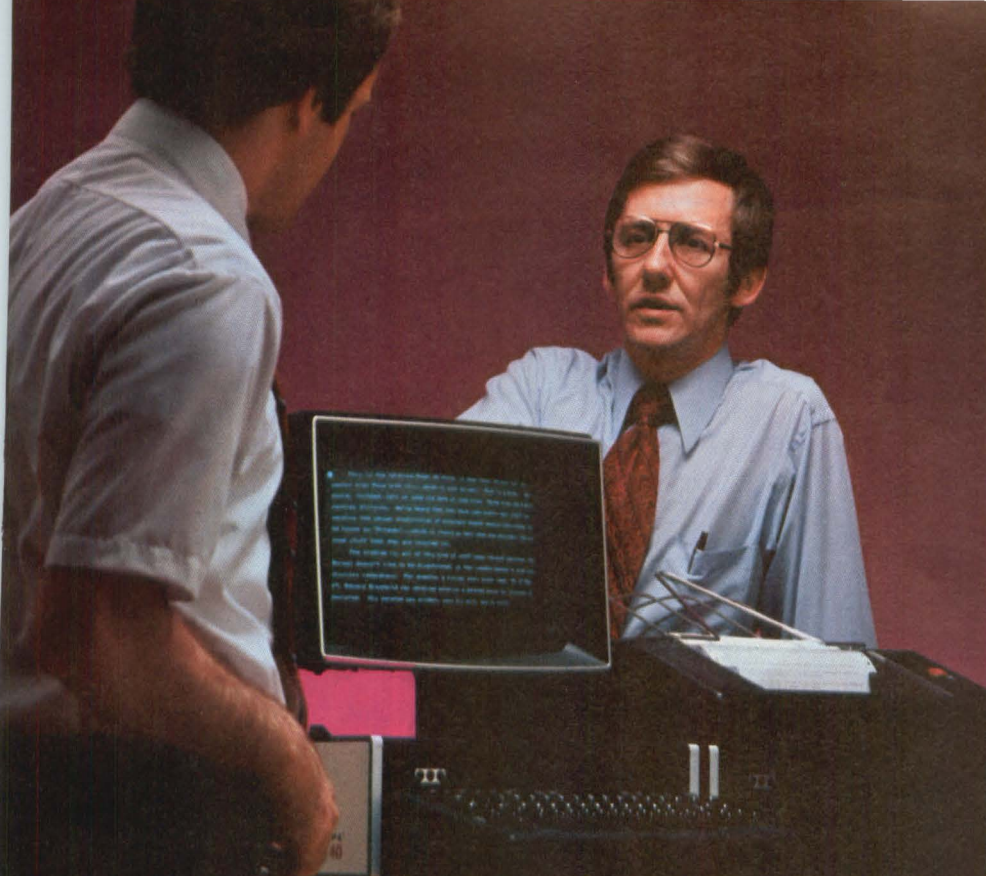

Fig 1 These block diagrams illustrate the lines of equipment and circuitry ownership and interface connection as they formerly existed (top) and as they exist today (bottom).



IF THE TELETYPE® MODEL 40 SYSTEM EVER MALFUNCTIONS, IT'S DESIGNED TO TELL YOU WHAT'S WRONG.

Even though we probably go to more trouble to insure uninterrupted reliability than anyone else, we're still realistic enough to admit that sometime something's going to go wrong.

So instead of burying our heads in the sand and pretending it won't, we've concentrated our efforts on what can be done to make downtime as short and painless as possible.

For starters, we gave the model 40 product line its own diagnostic capability. To tell you quickly what's wrong. Then, to make it easy to fix, we used a modular design concept. The result is an average mean-time-to-repair of only 3/4 hour.

We also made sure that when something does go wrong, you'll never be alone. We've got a nationwide service network standing behind every product with the Teletype name on it. We offer on-call repair service, maintenance contracts, and even an exchange repair service on components and parts.

The way we look at it, building something the best way humanly possible is only half our job. The other half is being ready for the unexpected.

For more information about the Teletype model 40 product line, write: Teletype, 5555 Touhy Ave., Skokie, IL 60076. Or call: 312/982-2000.



Teletype is a trademark and service mark registered in the United States Patent and Trademark Office.

Built-in diagnostics pinpoint trouble

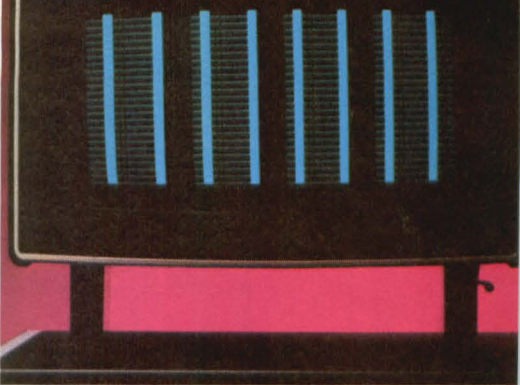

Average repairs take only 3/4 hour

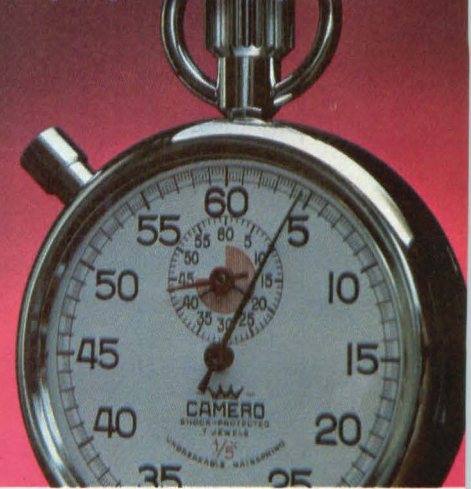

Exchange repair of major assemblies

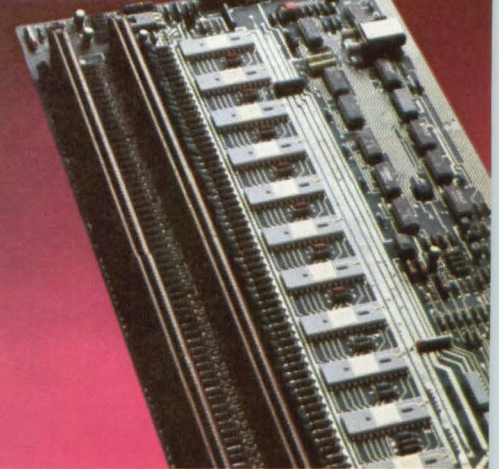

Nationwide service

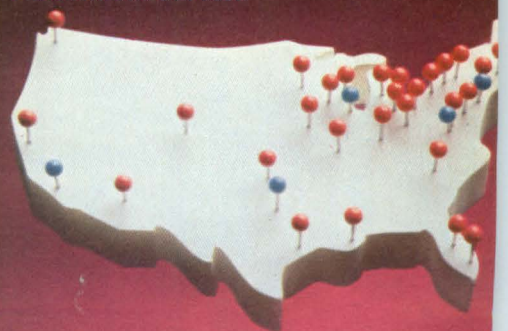

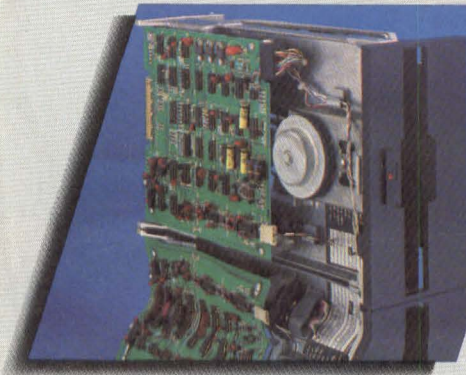

Flexible Disk Drive

GSI-FDD 110

A compact, random access, flexible disk drive for single or double density data storage.

It will accommodate up to 6.4M bits of data on one side of standard media using MFM or M²FM encoding techniques for double density applications. Single density storage in variable formats provides up to 3.2M bits of data. Fully IBM compatible the disk drive will read and write IBM 3740 formatted diskettes up to 1.9M bits. The high performance unit offers up to 4 drive daisy chain operation, parallel ready lines plus unit select, separation of clock and data and Track "00" photo sensing. It also has automatic diskette ejection and a fail safe interlock.

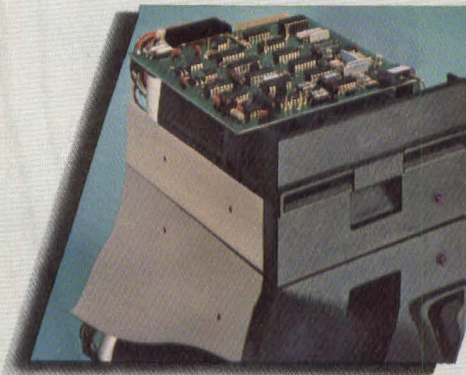

Flexible Mini-Disk Drive GSI-FDD 050

The GSI family of highly reliable small Mini-Disk Drives: MDD 050, 100K bytes; MDD 051, 200K bytes and the MDD 052, 465K bytes are designed to fit into many applications where conventional disk drives (GSI-FDD 110) are physically inappropriate and space is at a premium.

Low in cost, the MDD 050 Mini-Disk Drive utilizes a small flexible disk permanently housed in an envelope with the necessary apertures for drive spindle, head and sector hole access. Each envelope is 5¼" by 5¼" but otherwise is conceptually like the familiar IBM diskette.



Horizontal Autoloader

GSI-H155

The Horizontal Autoloader automatically loads and unloads open or closed flap diskettes to and from a GSI-FDD 110 Flexible Disk Drive. Diskettes are loaded sequentially from the hopper. After processing in the diskette drive, the diskettes are electronically selected and stacked horizontally in either of its two bins. The bins are removable and suitable for general handling of diskettes.



Flexible Disk Drive Sub-Systems GSI-FDD 2100

Packaged horizontally into a 19" Retma rack mount chassis, the GSI-FDD 2100 series sub-systems provide single and dual drive capability. Included in the sub-system is the necessary power to drive two flexible disk drives and a customer supplied formatter. Input AC power is supplied from the host computer controller via a relay system included in the GSI-FDD 2100.

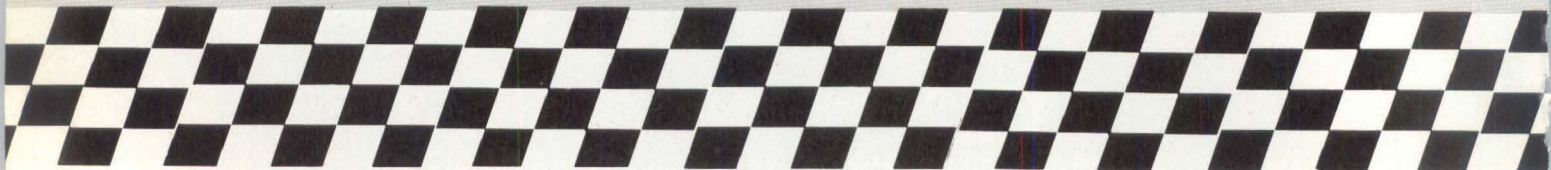

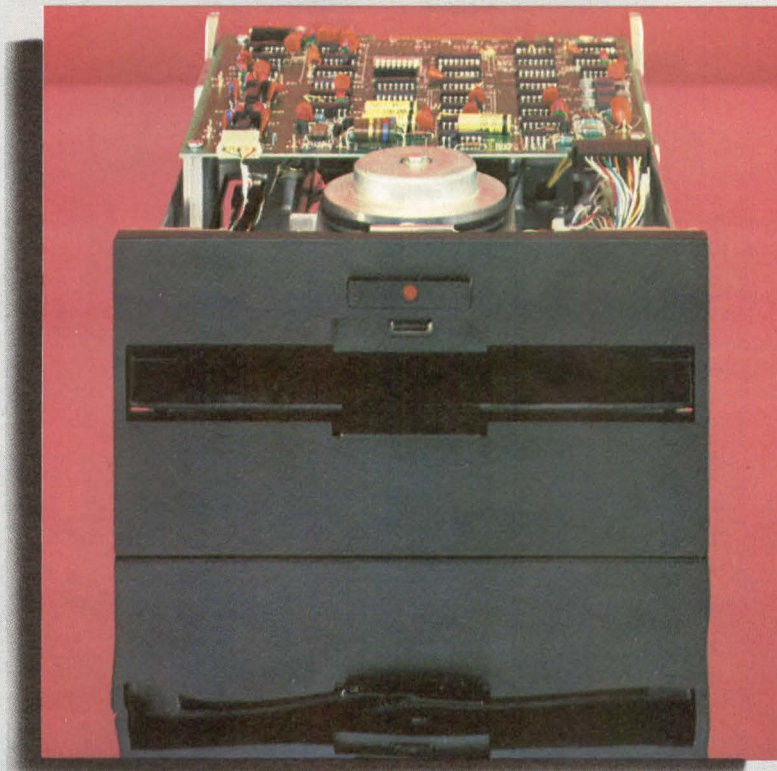

***Go with the winner-GSI-FDD 200.
Double-sided, double-track density, flexible disk drive.***

The winner in high quality, delivery and price. GSI's FDD 200 disk drive accommodates up to 25.6M bits using MFM or M²FM encoding techniques. Downward compatible with GSI's FDD 110 and available in the same package design, it is available for upgrading with minor system modifications. It is fully IBM compatible and will read and write IBM 3740 formatted diskettes. You also can daisy chain up to 4 drives.

Important features include: parallel ready lines plus unit select, separation of clock and data, Track "00" photo sensing, automatic diskette ejection and fail-safe interlock latch mechanism.

Go with the thousands of happy GSI winners. What have you got to lose?

CIRCLE 19

THE WINNER

GENERAL SYSTEMS INTERNATIONAL, INCORPORATED

GSI, 1440 Allec Street, Anaheim, California 92805, (714)956-7183, Telex 69-2488

NEW GARRY SBC 80/10 UNIVERSAL MICRO-PROCESSOR WIRE-WRAP INTERFACE BOARD

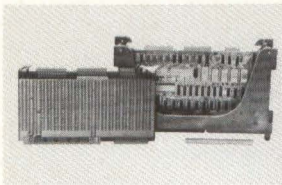

Garry Manufacturing Company now has available their new SBC 80/10 Universal Microprocessor Interface Board designed to plug directly into the Intel SBC 604 Modular Cardcage/Backplane bus system with power

interface connections for ± 5 and ± 12 volts dc.

The Garry SBC 80/10 Universal Wire-Wrap board provides 38 columns of 44 low-profile socket terminals per column, with alternate rows of committed ground and voltage wire-wrap terminations. The P/N EP 272-38-15 interface board will accommodate up to 95 16-position I.C. chips or an equivalent mix of 14, 16, 18, 22, 24, 28 or 40-position I.C. chips.

For complete information concerning the SBC 80/10 and other Universal Microprocessor/Minicomputer Wire-Wrap Interface boards, please contact Garry Manufacturing Company directly.

Garry Manufacturing Co., 1010 Jersey Avenue, New Brunswick, NJ 08902, 201-545-2424

Use the Reader Service Card number.

NEW SERIES OF SOCKETS FOR PACKAGING 8, 14, 16, AND 18 CONTACT DIPs

Has approved MIL-Spec 5-83734

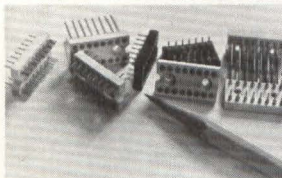

A new series of packaging sockets that accommodate 8, 14, 16, and 18 contact DIPs, as well as round-lead ICs with 0.016 to 0.020 inch diameter wires is now available from Garry Manufacturing Company of New Brunswick, NJ.

The new sockets have an ultra-low profile, for the most compact packaging of components.

The insulating bodies of these parts are of SE-O Grade Valox; the individual socket terminals are in two precision-machined pieces. The inner contact is gold-plated beryllium copper. The outer contact is brass, available in a variety of platings, including gold and tin. Both printed-circuit and wire-wrappable terminations (pins) are offered; the ends are closed to eliminate danger of solder or flux wicking.

The new DIP sockets are available off-the-shelf.

For complete information contact Garry Manufacturing Co. directly. Garry Manufacturing Co., 1010 Jersey Avenue, New Brunswick, NJ 08902, 201-545-2424.

Use Reader Service Card number.

MULTI-UNIVERSAL HIGH-DENSITY WIRE-WRAPPABLE PACKAGING PANELS

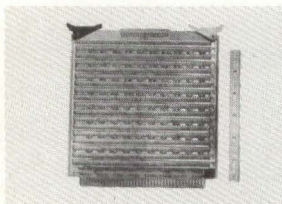

A new line of Multi-Universal High-Density wire-wrappable packaging panels, particularly suitable for use in microprocessor and digital-circuit applications, is now available from the maker, Garry Manufacturing Co., of New Brunswick, NJ.

These universal panels will accommodate:

- .100-inch spacing (SIP) Single-in-line packages
- .300-inch spacing (DIP) Dual-in-line packages
- .400-inch spacing (4K Ram) Memory packages
- .500-inch spacing (UART)
- .600-inch spacing (LSI) Large Scale Integrated Circuits

Designated the MU Series, the new packaging panels are available with 18 columns of 55 terminals per column, as plug-in modules P/N EP/80-18/55-15 or they can be manufactured to a customer's individual "slot" requirements. These panels are available in two to four weeks.

For complete information contact Garry Manufacturing Co. directly. Garry Manufacturing Co., 1010 Jersey Avenue, New Brunswick, NJ 08902, 201-545-2424.

Use Reader Service Card number.



We just got Mary Smith out of a bum wrap.

We gave Mary a pluggable Wire Wrap* board that worked at a very reasonable price. Get all the facts on our line of packaging panels as well as our line of other high quality, low cost products. I.C. sockets, adapter headers, microprocessor boards, racks, cable assemblies and much more.

Call or write Garry for the name and address of your nearest distributor or factory representative.

Garry Manufacturing, 1010 Jersey Avenue, New Brunswick, New Jersey 08902. (201) 545-2424.

*Registered trademark of Gardner-Denver Co.

We won't pin a bum wrap on you.

Garry

Manufacturing Co

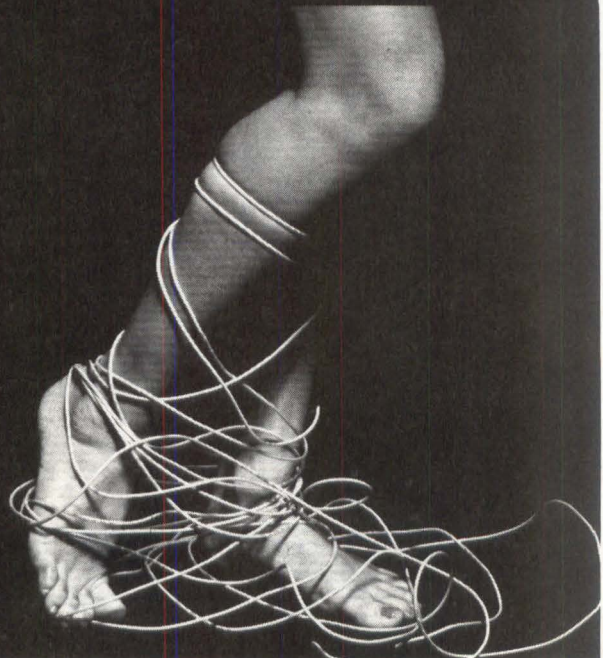

CIRCLE 20

Tandberg Data introduces a tape drive

SO WHAT ELSE IS NEW?

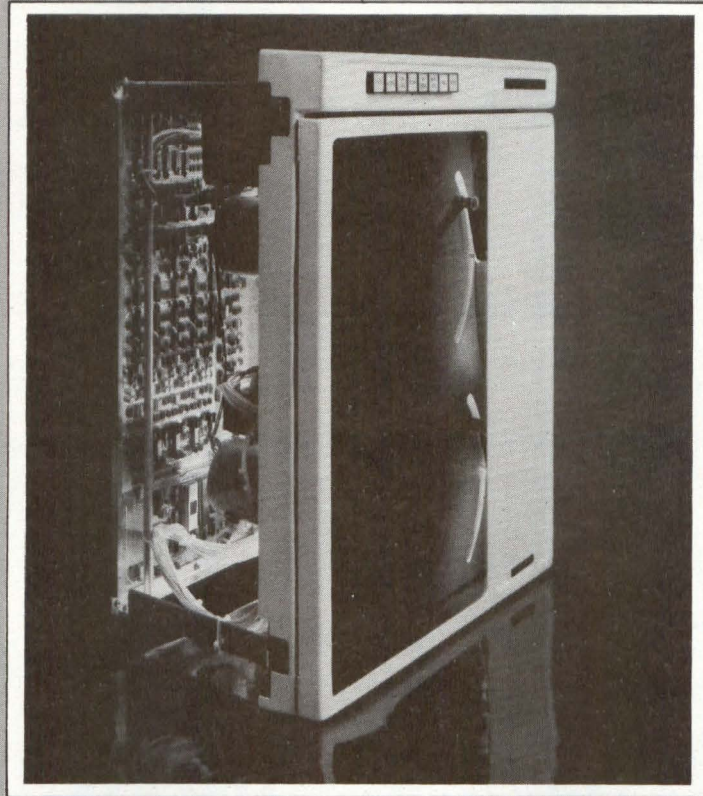

Performance. On an absolutely new level.

With the name Tandberg you expect top performance. And innovation. And being a little ahead of the competition in certain fresh and subtle ways. Ditto our new TDI 1050 Synchronous Tape Transport.

When you're a Johnny-Come-Lately with a product line you better try harder.

We did!

Your benefit? Greater reliability, maintainability, and programability as a result of our micro processor-based control logic. With its optional internal formatter, the 10½-inch-reel TDI 1050 makes your interfacing task a whole lot easier, giving unprecedented flexibility and performance when controlling the reading and writing of data.

With Tandberg's dual-format tape drive, you get both 1600 cpi PE and 800 cpi NRZI at speeds of 12.5 to 45 ips, with rewind speed of 200 ips. And there's no need for customer redesign with the in-

dustrial-wide compatibility of our interface.

For those who'd like multiple-drive capability in their system, our interface enables you to hook up four drives without the need for an outside power source.

Not only is the TDI 1050 less costly at the outset, but its built-in microprocessor is likely to reduce your operating costs. Its attractive design is another appealing plus for systems builders.

Just another tape drive? Yes and no. The task it performs has been around a while. A lot of horses ran a mile and a quarter and then along came Secretariat. Refinements count a lot, regardless of the track. Check out the TDI 1050. It'll change your ideas about what a tape transport can do.

Tandberg Data Inc.
4060 Morena Blvd.
San Diego, CA 92117
(714) 270-3990

TANDBERG

telephone central office does not exceed the permissible level of -12dBm. The second type of connection, "fixed loss loop", operates at -4dBm. The third type, said Seppala, coming in the near future, is called a "programmable" DAA. A "programmable" DAA can control the output of any modem's transmit level from 0 to -12dBm by means of a plug inserted into the standard jack, serving as a sensor to a telephone company installed resistor. The resistor, in discrete steps of resistance, will tell the equipment that it may transmit at a given level.

Limiting the level, said Seppala, is one of the things that protective circuitry concerns itself with. Data couplers also protect circuits the following ways:

Longitudinal Balance. Data coupler circuitry automatically balances voltages to ground from either tip or ring connections, eliminating voltage variances in the transmission or reception of signals.

Hazardous Voltage Protection. Tele-

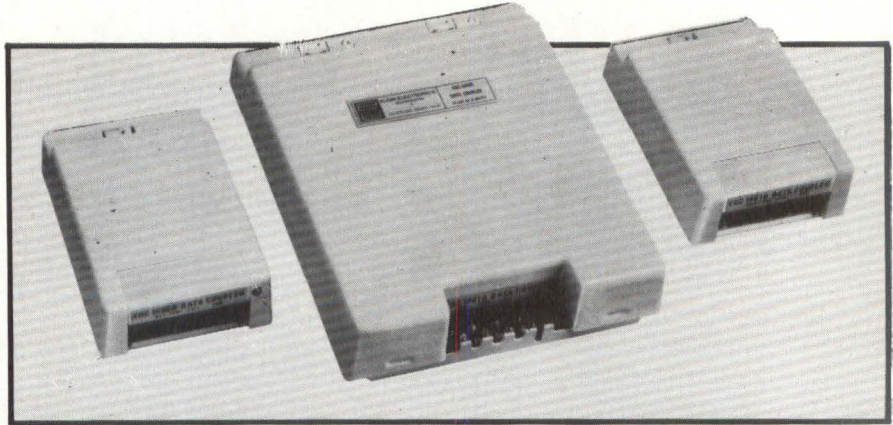

Fig 2 Elgin's three FCC registered data couplers interface customer-owned terminals, modems and the like with switched telecommunications networks for data communications.

phone companies and users are protected against hazardous voltages that can seriously damage either party's equipment.

Excessive Signal Power. Data couplers work to minimize excessive signal power, a main cause of signal distortion and crosstalk on the telecommunications network.

Timing Circuits. Timing circuits allow the telephone company's electronic

accounting equipment to determine the length of time a customer uses its circuits for transmission of data signals.

According to Montgomery and Seppala, these four essential types of protection must be built into a DAA somewhere along the line. The means to do this is changing very rapidly with modern technology and the use of devices such as microprocessors and large scale integrated circuits.

MDB SYSTEMS presents... The LSI-11 Connection

GP Logic Modules · Peripheral Controllers · Communications Interfaces · Special Purpose Modules · Accessory Hardware
Plus: DEC's own LSI-11 Microprocessor Module.

Here are some MDB Systems connections to LSI-11 microprocessors:

- General Purpose Interfaces: Parallel for programmed I/O and DMA.
Do-it-yourself dual and quad wire wrap for any DIP design.
- Device Controllers for most major manufacturer's Printers
Card equipment
Paper tape equipment
Plotters
- Communications/Terminal Modules
Asynchronous Serial Line
Synchronous Serial Line

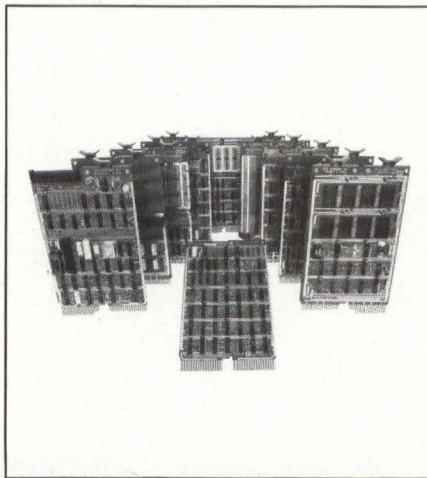

- MDB Backplane/Card Guide Assembly (8 Quad slots)
Rack mount chassis 5 1/4" front panel.
- Special Purpose Modules and Accessories
System monitoring unit provides front panel switch addressing, power on/off sequencing, line frequency clock.

- Bus extenders/terminators.
E-PROM and PROM modules.
Bus connectors for backplane assemblies.

MDB Systems products always equal and usually exceed the host manufacturer's specifications and performance for a similar interface. MDB interfaces are software and diagnostic transparent to the host computer. MDB products are competitively priced; delivery is usually within 14 days ARO or sooner.

MDB also supplies interface modules for DEC PDP-11 Data General NOVA* and Interdata minicomputers.

MDB
MDB SYSTEMS, INC.

1995 N. Batavia St., Orange, California 92665
714/998-6900 TWX: 910-593-1339

*TMs Digital Equipment Corp. & Data General Corp.

See us at Interface West, L.A.; Midcon, Chicago; & Systems '77, Munich.

CIRCLE NO. 90 FOR LSI-11; 91 FOR PDP-11; 92 FOR NOVA; 93 FOR INTERDATA

MFE's Mayflower Project Brings You The World's Smallest, Double Sided, Double Density, IBM Compatible Floppy Disc.

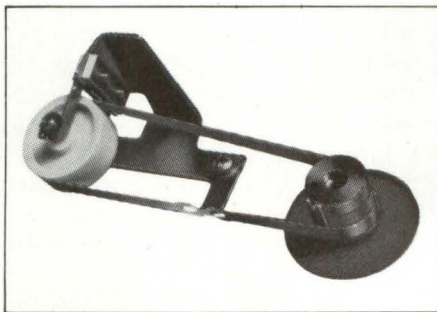
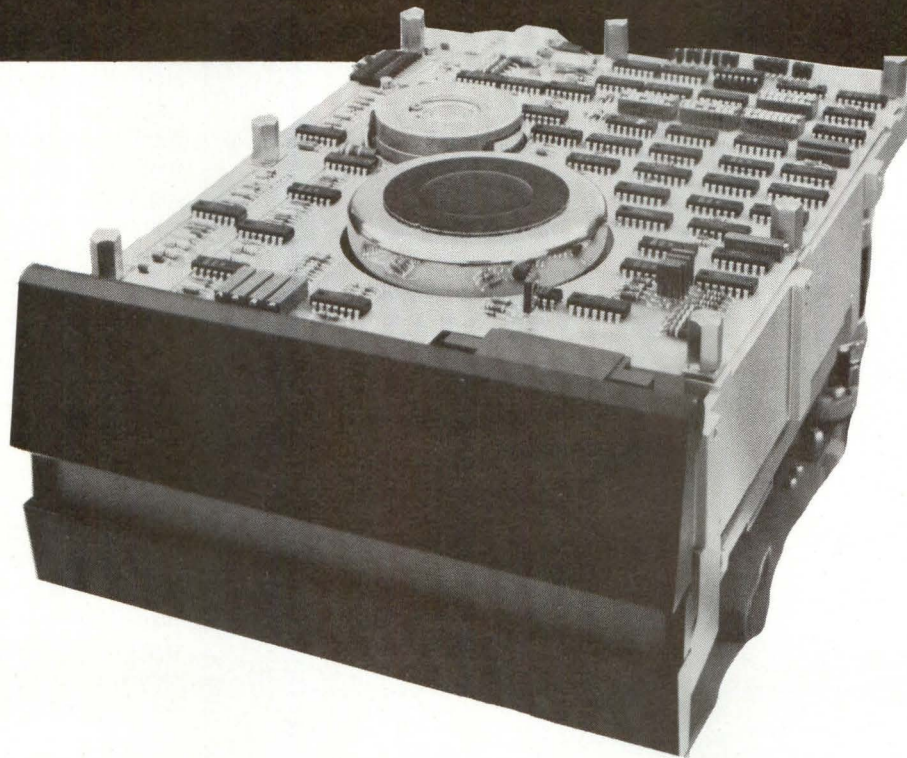

HELI-BAND™

- Translates 3.6° Rotation To One Full Track Of Head Travel
- Uses Low Power 200 Step/Rev Motor

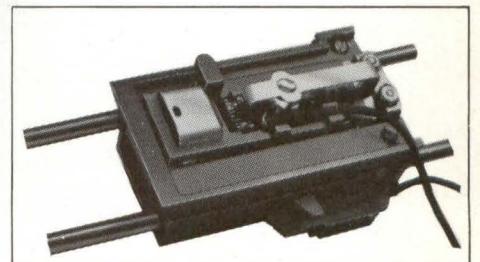
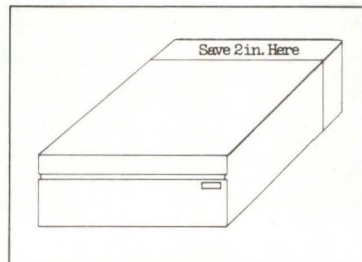

Dual Ceramic Heads

- Eliminate Felt Pressure Pads — Adds Head & Media Life
- IBM Compatible—Tunnel Erase Read/Write



KEEWAYDIN DRIVE, SALEM, N.H. 03079
(603) 893-1921, TWX 710-366-1887, TELEX 94-7477

MFE PRODUCTS SA
AV DU GENERAL GUI SAN 58
CH-1800 VEVEY SWITZERLAND
TELEPHONE 021 52.80.40
TELEX 26238 MFEPR CH

*Prices substantially lower for quantity purchasers.

Data Reliability: Cartridges Compete With Floppys

The boom in minicomputers and intelligent data terminals has spurred an unprecedented demand for low-cost mass storage devices such as the 3M

magnetic tape cartridge and the floppy disk. Both media store data in magnetic form; however their operating principles are very different. In general, the floppy disk permits faster access, but according to Dale A. Spencer, President of Tandberg Data Corporation, San Diego, California, the magnetic tape cartridge is more rugged, has a higher storage capacity and usually

simplifies data formatting. He also points out that the cartridge has advantages in data reliability that make it more desirable in some applications.

Spencer puts data errors into two categories, soft (recoverable) errors and hard (non-recoverable) errors. The medium causes soft errors; controlled re-reading can correct them. Drive equipment generates hard errors; thus they cannot be eliminated by a software process.

The signal to noise ratio no longer presents a problem in modern magnetic storage devices; it is high enough to eliminate errors due to statistical fluctuations and random noise. Drop-out rate depends on several factors including head to medium contact. Cartridge tape tension and disk loading problems normally insure good head-to-media contact, but dust particles can impair this contact and cause temporary dropouts.

Bit shifts occur when rewriting data; the amount of bit shift depends on write current and packing density. Tape drives hold down bit shift by operating at a constant 1600 bpi, but, Spencer says, variations in packing density cause bit shifts with disks.

Variations in drive unit sensitivity require maintaining a minimum signal level to ensure reliable data interchange when writing on one drive unit and then reading on another. The dual-gap, read-after-write head found on cartridge drives permits an immediate level check, so that software-generated re-write occurs if the level is insufficient. According to Spencer, floppy disk drives cannot ensure a minimum signal level because a single gap head is used. Thus, he says, data that was check read after one disk revolution will not necessarily reproduce well on a different drive. He claims that a cartridge drive has a typical error rate of 1 error per 10^{12} bits, and that floppy drive error rates range between 1 per 10^{11} and 1 per 10^{12} .

Spencer points out that error rates should be kept in their proper perspective. Soft errors pose different problems than hard errors; a high soft error rate does not decrease reliability because it can be corrected by repeated reading. A high hard error rate decreases data reliability because it cannot be corrected.

CITIZEN SERIES 8000 PRINTERS

heavy-duty
132 Columns
250-720 LPM
Chain Printer
Excellent
Quality
and Price

Manufactured by
CITIZEN WATCH CO.
Tokyo, Japan

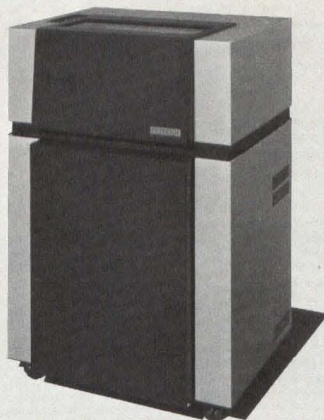

Exterior view of cabinet

Interior view of printer mechanism

Font train

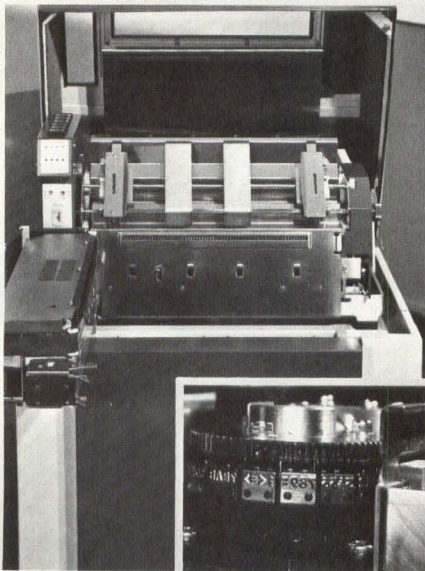

If you are an OEM in the computer industry, you know the crucial importance of gaining a competitive edge. We know it, too.

CITIZEN is the largest independent line printer manufacturer in Japan. We are new in the U.S. market. A very tough market. And we are growing fast because we offer our clients a very advantageous price/performance mix. The competitive edge.

The Citizen Series 8000 Line Printers are available in two basic models, with the following minimum speeds:

Model 8201	Model 8601
298 LPM — 48 characters — 720 LPM	
250 LPM — 64 characters — 600 LPM	
188 LPM — 96 characters — 444 LPM	

Full details on the competitive edge offered by the Citizen Series 8000 printers are yours for the asking. Call or write to:

Mike M. Fujiwara
Marketing Manager, Line Printers
C. ITOH ELECTRONICS, INC.
5301 Beethoven Street
Los Angeles, California 90066
Telephone: 213/390-7778

Distributed by:
C. ITOH ELECTRONICS, INC.

Part of C. Itoh & Co., Ltd., a firm with 118 years of international marketing experience.

CIRCLE 24

SAFER THAN SEMICONDUCTORS-- MORE POWERFUL
THAN CCD! --- **FASTER** THAN DISKS!!!



MEGASTORE IS THE DISK-REPLACEMENT
MEMORY FROM AMPEX THAT DOESN'T SPIN.
A COMPACT ARRAY OF RELIABLE CORE ELEMENTS,
MEGASTORE WON'T WEAR OUT, BURN OUT OR LOSE
DATA WHEN THE POWER FAILS!

AVAILABLE NOW AS DIRECT REPLACEMENT FOR DEC'S RJS0 3/4
AND DATA GENERAL'S NOVA DISK PRODUCTS.

AVAILABLE WITHOUT CONTROLLER FOR CUSTOM OEM APPLICATIONS.

AMPEX

AMPEX MEMORY PRODUCTS DIVISION 200 NORTH NASH STREET
EL SEGUNDO, CALIFORNIA 90245 213-640-0150

ENHANCING MINI CAPABILITIES

EMU

The speed at which information can be accessed in a computer system affects its system performance. Increase the speed of access and the increase in system performance is immediate and obvious. Using complex software such as real-time or time-shared operating systems may obscure the exact restriction in accessing information: is it the front-end communications interface, the processor, the overhead of swapping tasks, the latency in accessing commonly-used operating system utilities, latency in accessing user programs and data or the inability to address sufficient information in main memory?

Most potential bottlenecks involve latency in accessing information or the inability to access enough information at or near processor speeds ($1 \mu\text{s}$). Dr. Robin Lake of Monolithic Systems Corp., Englewood, CO and of Department of Biometry, Case Western University points out one solution to many system performance bottlenecks: provide a large increase in the processor's mass memory — memory which accesses information with little latency and transfers information near processor speed. The Extended Memory Unit (EMU, a trademark of Monolithic Systems Corp.) says Dr. Lake, provides exactly this capability for DEC's PDP-11 Unibus computer systems.

The EMU is a solid-state, plug-replacement for the DEC RF/RS-11 fixed-head disk. Computer systems

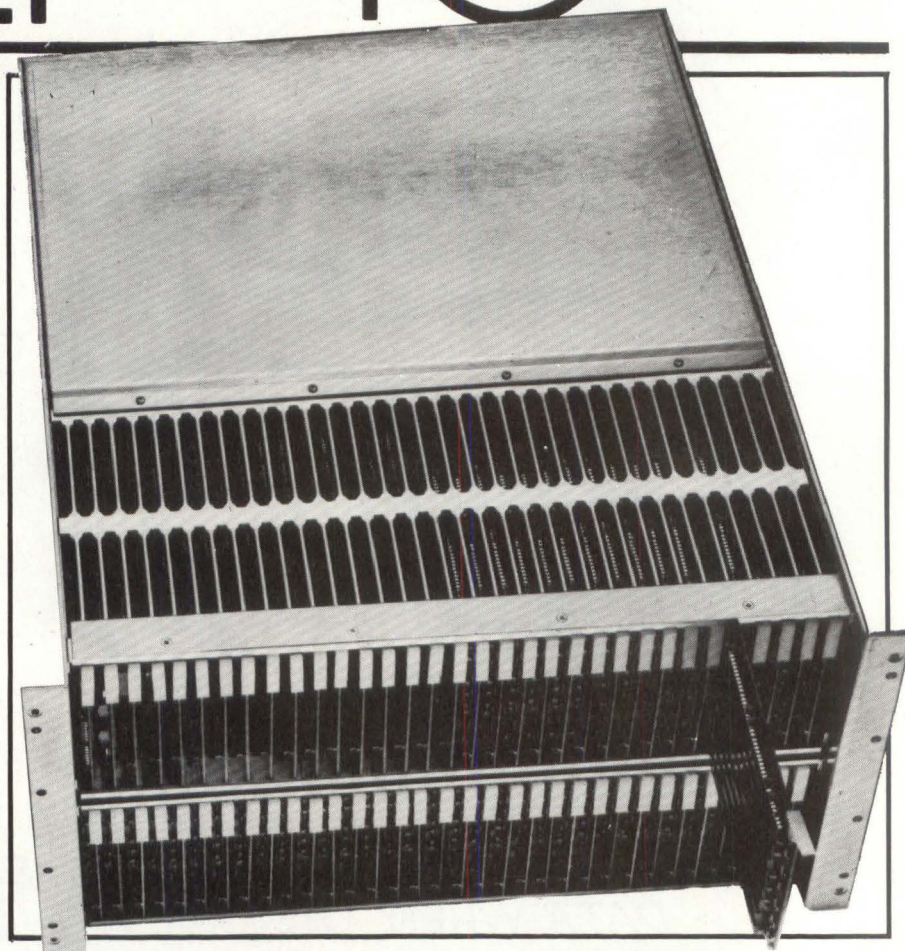

Fig 1 The solid-state EMU, manufactured by Monolithic systems, replaces fixed-head disks in PDP-11 systems.

typically include a fixed-head disk to reduce the latency (average time to access desired information) from the 55 ms rotational and positional latency of moving-head disks down to the 8.5-17 ms pure rotational latency of a fixed-head device. According to Dr. Lake, the

EMU completely eliminates this rotational latency. When accessing information is stored in the EMU, delay is the $2.1 \mu\text{s}$ required to set up EMU control registers and initiate the transfer of information to/from the main memory. Dr. Lake says that not only is the EMU

Another first for **ISS**

THE INDUSTRY'S MOST ADVANCED FIXED HEAD DRIVE

Announcing another in a long line of industry firsts for ISS—the ISS 550—the first fixed head disk drive to employ Winchester technology.

ISS is not only an innovator, but also one of the world's foremost manufacturers of OEM disk products, with all that means in the way of service back-up, spares, and technical assistance.

But at ISS, being first alone is not enough. The new ISS 550 has truly outstanding performance. Field upgradable capacity from 12.8 to 51.2 megabits. Average access time of 8.3 milliseconds. Sector formatting to meet individual requirements. And advanced technology that results in extremely low error rates.

Data transfer rate is 12MHz, and if that's too fast, you can slow it down with our data rate buffering feature.

But even high performance isn't everything. The new 550 is exceptionally reliable. It has only 25% as many

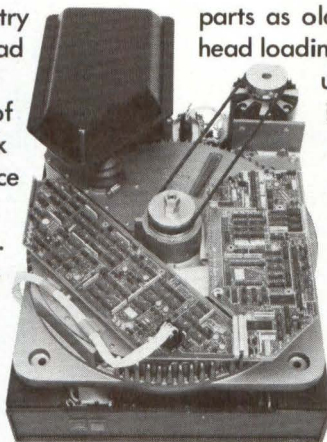

parts as older technology fixed head drives. There's no head loading mechanism. DC power supply is built in. The unit is self clocked. And the design incorporates interchangeable modular subassemblies for quick and easy maintenance.

All this performance and all this reliability go into a compact package that occupies just 14.5 inches of rack space.

But when all is said and done, the most significant statement we can make about the 550 is this: the price-performance ratio is twice as good as that of fixed head drives using older technology.

Get full details on this ISS first. ISS is an operating unit of Sperry Univac bringing technological leadership for the generations ahead. Write or call OEM Marketing, ISS, 10435 N. Tantau Avenue, Cupertino, California 95014, Telephone (408) 257-6220.

ISS 550. Twice the performance.

SPERRY  UNIVAC

SPERRY UNIVAC IS A DIVISION OF SPERRY RAND CORPORATION

CIRCLE 26

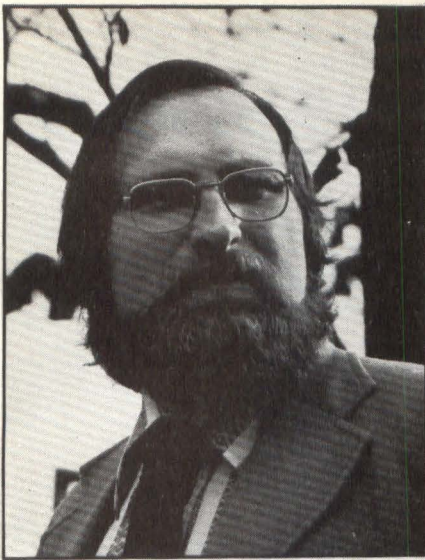

Dr. Robin Lake: A large increase in the minicomputer's mass memory clears up many system performance bottlenecks.

4,000 to 8,000 times faster than a fixed-head disk with respect to latency, but the EMU transfers information at a 1 μ s data rate — 16 times faster than the RF/RS-11 and 4 times faster than the RJS-04 disk.

Dr. Lake points out that the increases in system performance offered by such a device may be manifest in many ways:

- More users and faster response time in time-sharing systems;
- Faster assembly and compilation in program development;
- The ability to handle more communication lines per processor in data communications systems;
- Faster access to information in data base management systems;
- Higher sampling frequencies possible in data acquisition systems;
- Higher control loop bandwidths in process control systems;
- The ability to handle huge (1024 by 1024) data arrays at near processor speed with BASIC, FORTRAN and other high-level languages;
- The ability to use disk operating systems in harsh environments where rotational devices are precluded by shock, vibration or high particulate atmosphere.

Indeed, Dr. Lake claims, the EMU may provide years of added productive life to a PDP-11 system which appears

to be overloaded — time that may be of great importance to the user contemplating a system upgrade but faced with extended delivery delay for a new system.

Application

Dr. Lake provided us with the following details of enhancements extended memory units offer in some application areas.

Time-Sharing Systems. Many time-shared operating systems use highly paged program segments. A single PDP-11 instruction may require as many as five program segments for its execution: one each for the instruction, two indirect addresses and two operands. Each additional program segment could require system access to the paging device — with a rotational latency of 8,500 to 17,000 μ s. An extended memory unit eliminates this latency, reducing system overhead and increasing the

Most potential system bottlenecks involve latency in accessing information.

throughput of the operating system. According to one model of time sharing performance, the EMU will yield a 79% decrease in mean wait time for each user. In fact, even greater increases occur in operating systems which encounter additional disk latency overhead when creating files, accessing utility programs overlaying program segments, accessing data files and performing system accounting.

Program Development. Modern compilers typically make seven to fifteen passes through a source file and the intermediate files generated. Compiler references to symbol tables, macro code segments and compiler program overlays require many disk accesses.

Transfer from EMU to main memory:

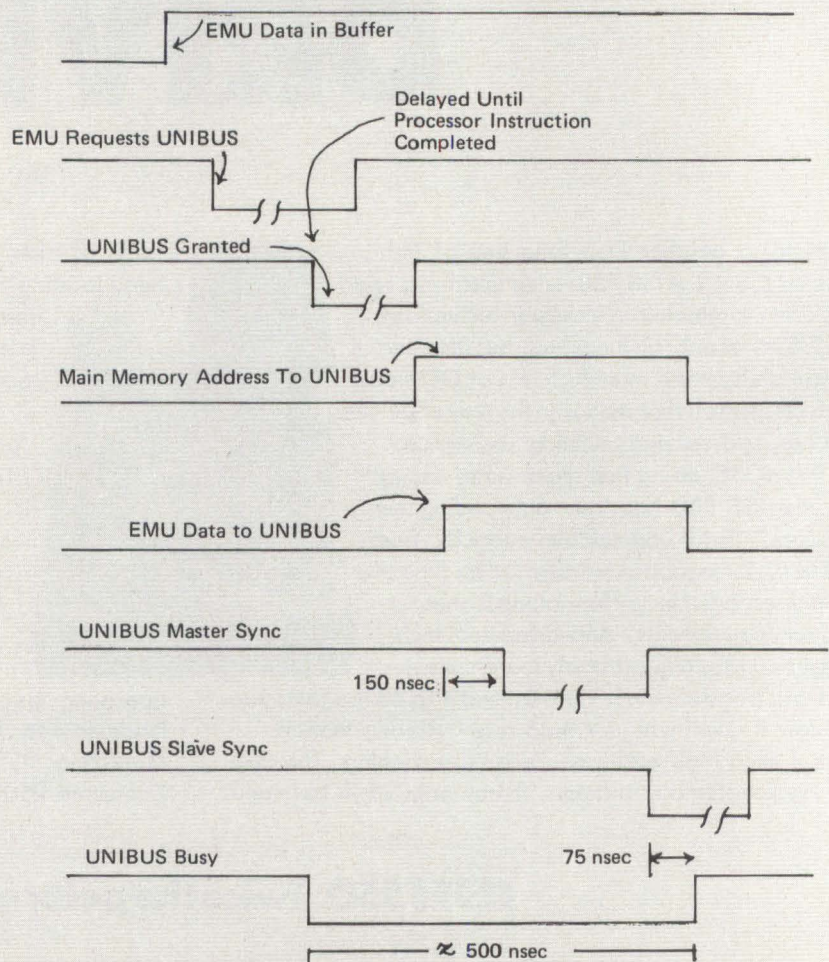

EMU™ Requires Only Approx. 500 nsec of UNIBUS Time for Each Word Transferred

Fig 2 The EMU in a single-port configuration.

NOW, LEAR SIEGLER AND BURROUGHS ARE ON SPEAKING TERMS.



You're probably very happy with your Burroughs mainframe.

But you'd undoubtedly like to have the versatility and dependability of Lear Siegler terminals. If only they were compatible with your present system.

Now they are. Complete with standard Burroughs polling and address line disciplines.

What's more, the ADM-2B's forms mode capability is compatible with the TD-820.

The ADM-2B gives you full text editing capabilities. Including erase to end of line/field/page. Insert and delete character and line. Blinking and blanking fields. And tabbing.

Just flick a switch and you can convert the ADM-2B to a standard ADM-2 with Burroughs line discipline.

Line diagnostic mode is switch selectable — which makes it extremely valuable for troubleshooting.

Of course, there's all the support that Lear Siegler is famous for. Throughout the United States and in many foreign countries.

\$2485.

That's the full price. Including serial printer port. Numeric keypad. 24x80 character screen. 16 function keys. 110-9600 baud. RS232 interface. Burroughs two-wire direct connect is available as an option.

The fact is, Lear Siegler's new ADM-2B terminal gives you the best of both terminals. So you can use it right alongside your present Burroughs terminals and mainframe.

So rest easy, Burroughs users. Because now Lear Siegler speaks your language.

For more information contact: Lear Siegler, Inc., E.I.D./Data Products, 714 N. Brookhurst St., Anaheim, CA 92803; (800) 854-3805. In California (714) 774-1010.



**THE ADM-2B.
SMART TERMINAL.
SMARTER BUY.**

The linker program also has high I/O requirements as program and library code segments are selected, relocated and written out as object files. Reduction in file access latency by use of an EMU to store compiler scratch files and other similar files should reduce compilation and linkage times.

Data Base Management. Data base management systems, notorious for their high use of disk storage, require high rates of disk access as a data item is pursued through disk-based links and pointers. Elimination of rotational latency by storage of data-base access keys, pointers and links in an EMU promises more rapid access to the DBMS data items.

Data Communications. In data communications, store-and-forward message switching and time-sharing front-end processors, one system design consideration is the amount of main memory available to buffer messages awaiting transfer to a mass storage device. The EMU wastes no time waiting for rotational latency, permitting a processor to handle many more communication lines and lines of higher data rates for a given main memory capacity. The

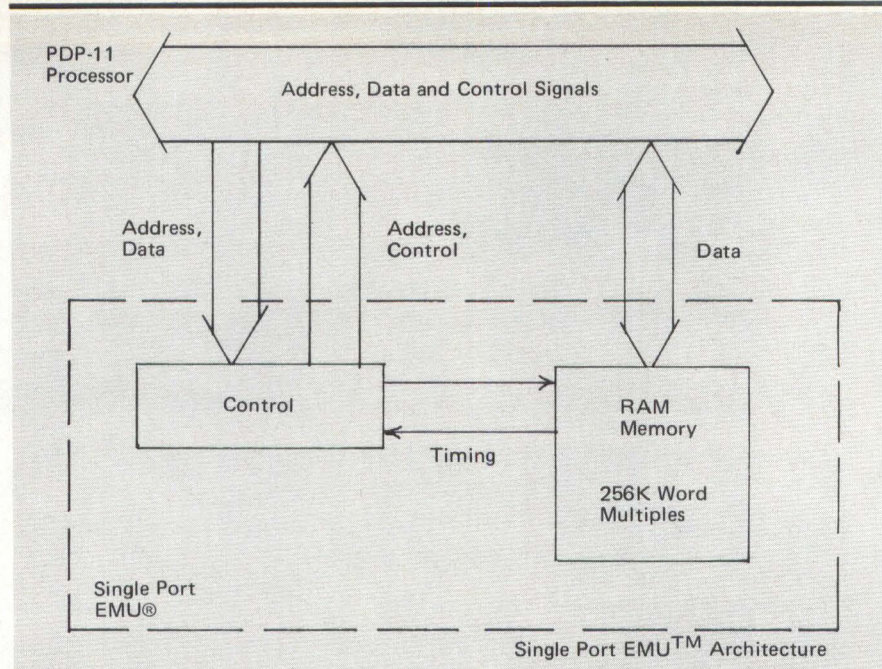

Fig 3 The EMU requires only 500 ns of Unibus time for each transferred word.

word addressability of the EMU permits message strings to be processed at their natural length without blocking into 512 byte sectors.

Data Acquisition and Control. Computer system performance in time-critical acquisition and control systems can

be considered in terms of processor and memory bandwidths. PDP-11 processor bandwidths range from less than a thousand floating-point fetch/execute cycles per second in the PDP-11/05 up to approximately 130,000 cps in the PDP-11/70 with floating-point proces-

DIGITAL TV MEMORY

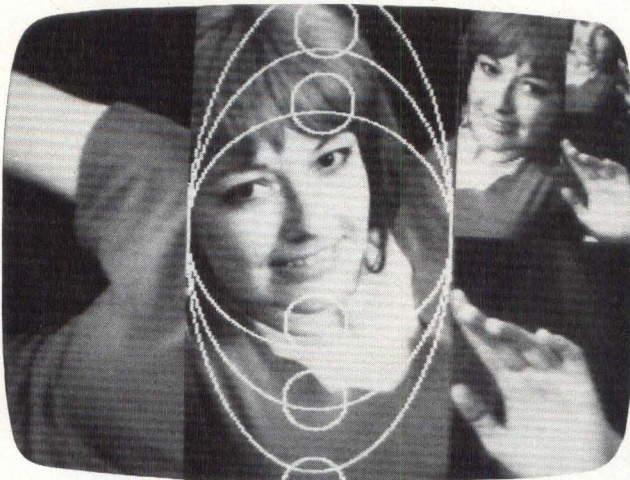

Video Expander 275

- Converts digital data to standard 525-line television format
- Full greyscale (to 256 levels)
- Resolution to 256x512 pixels
- Two-way digital data interaction, pictures may be written then altered one pixel at a time
- Options include stand-alone reconstruction of either digital or "slow scan TV" transmissions over phone lines, video "frame grabbing", reduced resolution and greyscale

CVI Model 275 with 256x256x6 memory and computer I/O board **\$9,000**

cv**i**

Colorado Video, Incorporated
Box 928 • Boulder CO 80306 USA • (303)444-3972 • TWX 910-940-3248 (COLO VIDEO BDR)
CVI Boston (617)256-3381 • CVI Dallas (214)233-5497 • CVI Los Angeles (213)889-3653
CVI New York (212)246-2490

Video Instruments for Data Acquisition, Processing, Transmission, Display

sor. For compute-bound systems, mass memory will help only in that I/O time for access to data arrays is reduced markedly. Main memory bandwidth ranges from approximately 1.1 million in the PDP-11/05 to approximately 2.4 million words/second in the PDP-11/70 cache memory. Mass memory band-

width for the RF/RS-11 fixed-head disk is 30.3 1K-word blocks/second; the RJS-04 FHD 80 1K-word blocks/second; and the EMU 1000 1K-word blocks/second. Where data acquired must be transferred to or from mass memory for storage and analysis, the EMU offers a 12-fold to 33-fold in-

crease in mass memory bandwidth.

FORTRAN Data Analysis. Data analysis problems which exceed the 32K word data space of PDP-11 FORTRAN tax many PDP-11 computer facilities. In the PDP-11/04 through 11/40 and in the PDP-11/60, only 32K words of main memory are accessible to FOR-

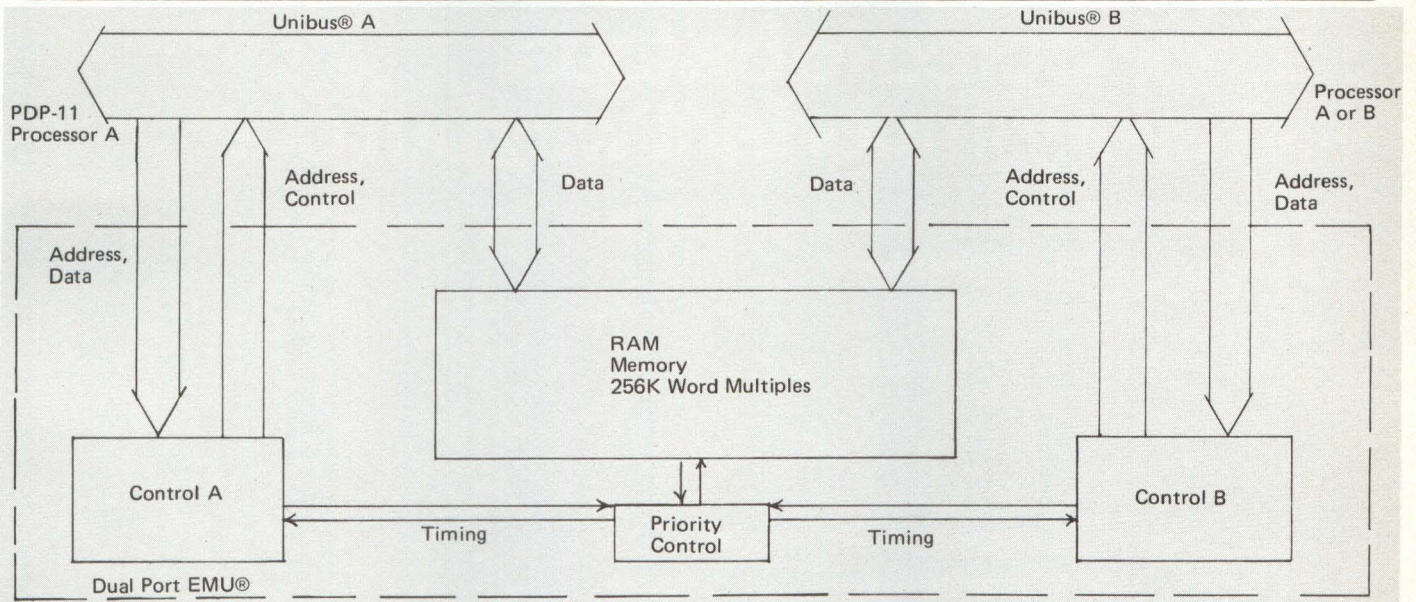

Dual Port EMU™ Architecture Resolves Priority Between Competing Requests for EMU™ Memory Access

Fig 4 The EMU in a dual-port configuration.

the only one of its Kind

...AN ALTERNATIVE TO NICKEL CADMIUM

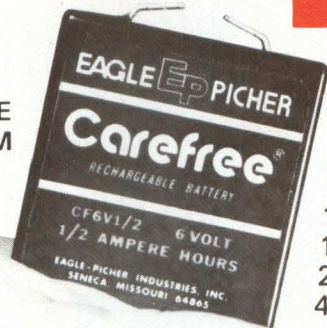

6 volt 1/2 ampere hour
1.92" length
1.00" width
2.00" height
4.8 ounces

**THE NEW
IMMOBILIZED
ELECTROLYTE
TECHNOLOGY THAT'S
MORE RELIABLE THAN GEL**

- No memory conditioning required
- No cell reversal
- Less expensive
- Better float life
- Entirely maintenance-free
- Spill-proof and rechargeable

EAGLE P ICHER
SINCE 1843

EAGLE-PICHER INDUSTRIES, INC.
Commercial Products Department DD
P.O. Box 130, Seneca, Mo. 64865
Telephone (417) 776-2258

Also available in 30 other sizes from 1/2 to 40 ampere hours

CIRCLE 29

Adtech Power Supplies.

Engineered to be tops in every important way but one.

Price.

OVER 50,000 HOUR MTBF / U.L. RECOGNIZED AS NOTED.

UNIVERSAL INPUT: 115/230 Vac $\pm 10\%$, 47-440 Hz
No derating for operation at 50 Hz.

AUTOMATIC FOLDBACK CURRENT LIMITING
AND SHORT CIRCUIT PROTECTION.

IC IS ZENER PROTECTED AGAINST OVERVOLTAGE

CHASSIS DESIGN PROVIDES
UP TO 40% MORE HEAT TRANSFER
AREA THAN OTHER MAKES.

INSULATED SHAFT
POTENTIOMETERS . . .
(No Humdingers!)
prevent shorting
during adjustment.

ELECTROSTATICALLY
SHIELDED TRANSFORMERS
reduce noise better than 4 to 1.

Transformers are larger than
on other makes . . .
for added reliability.

ALL TRANSISTORS AND IC's
ARE HERMETICALLY SEALED
(No Plastic types)

INTEGRATED CIRCUIT REGULATION
AND INTEGRATED DARLINGTON TO-3 OUTPUT STAGE
simple circuitry . . . increased reliability.

COMPUTER GRADE CAPACITORS
rated for 10-year life.

3 Day Delivery . . . 6 Year Guarantee!

Single Output Microcomputer Power Supplies.

REQUEST BULLETIN APS-277

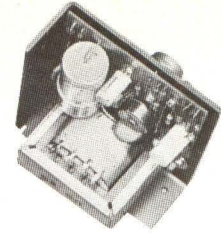

DIMENSIONS: 4"x2.75"x4.87"

15 TO 24 WATT "RED BARON" SERIES. *U.L. Recognized (File No. E58512)

MODEL NUMBER	RATING		REGULATION		RIPPLE (PK/PK)	OVP MODEL SUFFIX	PRICES-ALL MODELS		
	Vdc	Amps	Line	Load			QTY	POWER SUPPLY	OVP UNIT
APS 5-3*	5	3	+0.05%	+0.1%	3mV	OV1-53	1-4	34.00	7.00
APS 6-2.5	6	2.5	+0.05%	+0.1%	3mV	OV1-63	5-9	33.15	6.90
APS 12-1.6*	12	1.6	+0.05%	+0.1%	3mV	OV1-122	10-24	32.20	6.70
APS 15-1.5*	15	1.5	+0.05%	+0.1%	3mV	OV1-152	25-49	30.70	6.40
APS 20-1*	20	1.0	+0.05%	+0.1%	3mV	OV1-201	50-99	29.20	6.05
APS 24-1*	24	1.0	+0.05%	+0.1%	5mV	OV1-241	100-249	27.00	5.70
APS 28-0.8*	28	0.8	+0.05%	+0.1%	5mV	OV1-281	250-499	25.20	5.25

30 TO 60 WATT "GREEN HORNET" SERIES. †U.L. Recognized (File No. E58512)

MODEL NUMBER	RATING		REGULATION		OVP MODEL SUFFIX	POWER SUPPLY PRICES			
	Vdc	Amps	Line	Load		QTY	APS 48-1	ALL OTHERS	OVP PRICES
APS 5-6†	5	6.0	+0.05%	+0.1%	OV2-56	1-4	68.00	55.00	15.00
APS 6-5	6	5.0	+0.05%	+0.1%	OV2-65	5-9	66.70	53.65	14.85
APS 12-4†	12	4.0	+0.05%	+0.1%	OV2-124	10-24	64.75	52.10	14.40
APS 15-3†	15	3.0	+0.05%	+0.1%	OV2-153	25-49	61.75	49.65	13.75
APS 20-2.4*	20	2.4	+0.05%	+0.1%	OV2-203	50-99	58.75	47.25	13.05
APS 24-2.2†	24	2.2	+0.05%	+0.1%	OV2-245	100-249	55.15	44.35	12.25
APS 28-2.2†	28	2.0	+0.05%	+0.1%	OV2-284	250-499	50.75	42.00	11.30
APS 48-1*	48	1.0	+0.05%	+0.1%	OV2-481	500-999	49.60	40.00	11.05

* RIPPLE: (PK/PK) 5mV. All others 3mV.

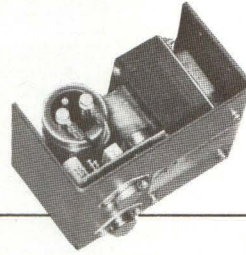

DIMENSIONS: 5.62"x3.40"x4.87"

50 TO 120 WATT "BLACK BEAUTY" SERIES. *U.L. Recognized (File No. E58512)

MODEL NUMBER	RATING		OVP MODEL SUFFIX	POWER SUPPLY PRICES				OVP PRICES	
	Vdc	Amps		QTY.	APS 5-9	APS 5-12	APS 5-18		ALL OTHERS
APS 5-9*	5	9	OV2-510	1-4	71.00	85.00	108.00	75.20	15.00
APS 6-10*	6	10	OV2-510	5-9	68.75	82.95	104.50	73.40	14.85
APS 12-5	12	5	OV2-512	10-24	66.74	80.55	101.45	71.30	14.40
APS 15-18	15	18	OV2-518	25-49	63.90	76.80	96.70	67.95	13.75
APS 12-7*	12	7	OV2-127	50-99	61.05	73.00	91.95	64.60	13.05
APS 15-6*	15	6	OV2-156	100-249	57.30	68.55	86.35	60.65	12.25
APS 20-5*	20	5	OV2-245	250-499	52.75	65.00	79.45	55.80	11.30
APS 28-4*	28	4	OV2-284	500-999	51.60	57.90	77.70	54.60	11.05

REGULATION: LINE +0.05% Load +0.1% RIPPLE (PK/PK): 3mV on 5, 12, 15V models. 5mV on 24, 28V.

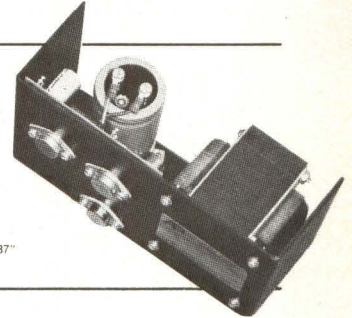

DIMENSIONS: 9"x3.65"x4.87"
APS 5-18 DIMENSIONS: 14"x3.65"x4.87"

125 TO 250 WATT "BLUE MAX" SERIES.

MODEL NUMBER	RATING		REGULATION	OVP MODEL SUFFIX	POWER SUPPLY PRICES				OVP PRICES
	Vdc	Amps			QTY.	APS 5-30	ALL OTHERS	OVP PRICES	
APS 5-25	5	25	+0.05%	+0.01%	OV3-525	1-4	163.00	158.00	25.00
APS 6-30	6	30	+0.05%	+0.01%	OV3-530	5-9	159.25	154.40	24.50
APS 12-15	12	15	+0.05%	+0.01%	OV3-622	10-24	154.65	149.95	24.25
APS 12-17	12	17	+0.05%	+0.01%	OV3-1217	25-49	147.45	142.95	23.15
APS 15-15	15	15	+0.05%	+0.01%	OV3-1515	50-99	140.20	135.90	22.00
APS 20-11	20	11	+0.05%	+0.01%	OV3-2011	100-249	131.65	127.60	20.65
APS 24-10	24	10	+0.05%	+0.01%	OV3-2410	250-499	121.10	117.40	19.00
APS 28-9	28	9	+0.05%	+0.01%	OV3-289	500-999	118.50	114.85	18.60

RIPPLE (PK/PK): 3mV on 5, 6, 12, 15V models. 5mV on 20, 24, 28V models.

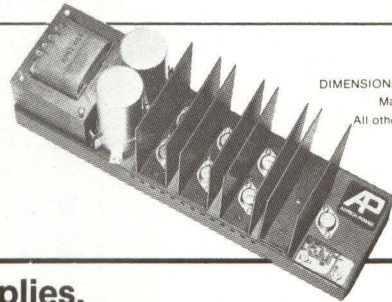

DIMENSIONS: 16.72"x4.87"x6.60"
Max. APS 5-30 only.
All others 16.72"x4.87"x5.75"

New Multiple Output Microprocessor Power Supplies.

DUAL OUTPUT MICROPROCESSOR SERIES U.L. Recognized (File No. E58512)

MODEL NUMBER	RATING		QUANTITY PRICES						
	Vdc	Amps	1-4	5-9	10-24	25-49	50-99	100-249	250-499
DAPS 5.8	±5	0.8	43.00	41.95	40.70	39.80	38.00	36.80	33.00
DAPS 9-12.5	±9-12	0.5	43.00	41.95	40.70	39.80	38.00	35.80	33.00
DAPS 12-15	±12	0.75	43.00	41.95	40.70	39.80	38.00	35.80	33.00
DAPS 15-60	±15	0.06	43.00	41.95	40.70	39.80	38.00	35.80	33.00
DAPS 5112.5	±5	1.0	43.00	41.95	40.70	39.80	38.00	35.80	33.00
DAPS 12-1.5	±12	0.5	59.00	57.60	55.90	53.30	50.65	47.60	43.80
DAPS 15-1.3	±15	1.3	59.00	57.60	55.90	53.30	50.65	47.60	43.80
DAPS 53121.5	±5	3.0	59.00	57.60	55.90	53.30	50.65	47.60	43.80
	±12	1.5							

REGULATION: +0.05% Line, +0.1% Load. RIPPLE (PK/PK) 3mV.

DIMENSIONS: (Small unit) 4"x2.75"x4.87" (Large Unit) 7"x3.40"x4.87"

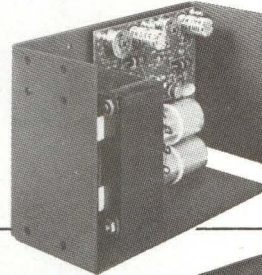

REQUEST BULLETIN DAPS - 976

TRIPLE OUTPUT "TAPS" MICROPROCESSOR/GENERAL PURPOSE SERIES

MODEL NUMBER	RATING		QUANTITY PRICES						
	Vdc	Amps	1-4	5-9	10-24	25-49	50-99	100-249	250-499
TAPS 1	5V	4.0	94.15	91.85	89.20	85.05	80.85	75.90	71.00
TAPS 2	±9-12*	0.5	107.00	104.60	101.60	96.85	92.10	89.00	87.50
TAPS 3	±9-12*	1.0	137.00	134.00	129.80	127.80	125.00	123.75	113.85
TAPS 4	±9-12*	1.5	163.00	159.00	154.45	151.50	149.00	148.00	147.00
	±9-12*	3.0							

* Also available with +12-15V output. Specify if desired. REGULATION: +0.1% Line, +0.1% Load. RIPPLE (PK/PK): 5mV

REQUEST BULLETIN TAPS - 377

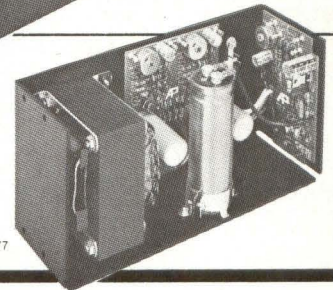

DIMENSIONS: 8.62"x3.65"x4.87" to 15"x4.5"x4.87"

CALL OUR ENGINEERING SALES OFFICE IN YOUR AREA FOR APPLICATION ASSISTANCE

Arizona, Phoenix (602) 946-9860
California, Long Beach (213) 426-7375
San Francisco (408) 733-6690
Colorado, Denver (303) 773-2830
Connecticut, Meriden (203) 237-9232
Georgia, Atlanta (404) 252-5360
Hawaii, Honolulu (808) 941-1574
Illinois, Chicago (312) 298-4830
Kansas, Kansas City (913) 381-0004
Wichita (316) 264-2662

Massachusetts, Boston (617) 245-0250
Michigan, Detroit (313) 576-4705
Minnesota, Minneapolis (612) 861-3343
Missouri, St. Louis (314) 569-1220
New Mexico, Albuquerque (505) 294-8408
Las Cruces (505) 524-0126
New York, Albany (518) 456-6667
Buffalo (716) 632-7880
New York (516) 487-3966
Rochester (716) 482-3000

New York, Syracuse (315) 637-9383
North Carolina, Winston-Salem (919) 725-6196
Ohio, Dayton (513) 434-8808
Pennsylvania, Philadelphia (215) 825-9515
Pittsburgh (412) 961-0414
Texas, Dallas (214) 387-2489
Houston (713) 665-0991
Washington D.C., (202) 363-9417
Wisconsin, Milwaukee (414) 421-2300

Canada: Montreal (514) 363-5120, Ottawa (613) 745-0541, Toronto (416) 787-0991, Winnipeg (204) 338-5050, Vancouver (604) 748-2392
In Europe: SOPHIA, Wholly Owned Subsidiary of Adtech Power, 46 BD. Roger Salengro, 78200 Mantes La Ville, France. Tel: 4775301+

Adtech Power Inc., 1621 South Sinclair Street, Anaheim, California 92806, Telephone: (714) 634-9211

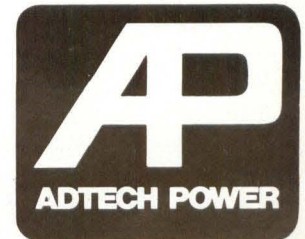

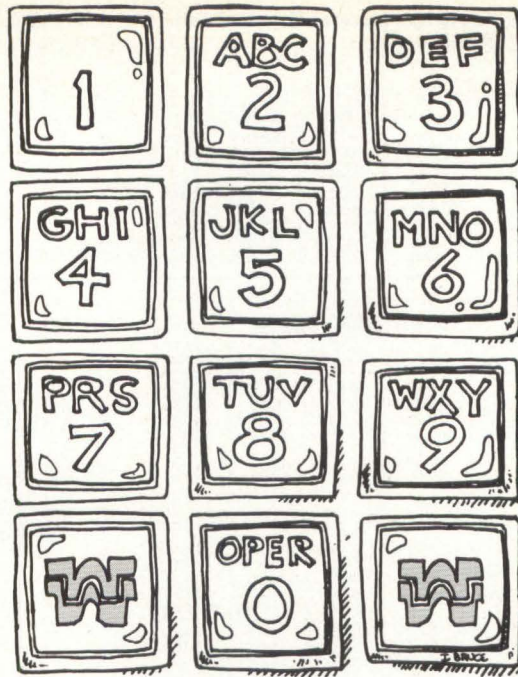

800-225-4620

INTERFACE WEST IS TAKING RESERVATIONS!

Micro engineers and system designers hungry for the latest information on micro technology and applications can satisfy their needs at INTERFACE WEST. Three days of conference sessions covering micro advances in hardware, software and applications plus an exposition of hundreds of exciting new micro-based products and services is drawing thousands of attendees. Register by phone to reserve your place at INTERFACE WEST, Nov. 1-3, at the Los Angeles Convention Center.

Program Organized by Ogdin

Carol Ogdin, the widely-read authority on microcomputer design and application, has organized a superb speaker line-up featuring herself, noted author and consultant Adam Osborne, and more than a dozen other top micro hardware/software designers and consultants. The comprehensive program of sessions will cover microprocessor architecture, large solid state memories, micros in terminals and distributed computing, interface and control ICs, micro software tools and languages and much more. Thousands of attendees will find a broad selection of topics to improve their micro decision making.

To round out your information needs, INTERFACE WEST also offers complete programs in data communications, telecommunications, and computing alternatives for small business.

Exhibits Galore

Picture a huge hall filled with hundreds of micro products and services. That's the exhibit floor of INTERFACE WEST. We're building a micro supermarket for your shopping convenience. Here's your chance to learn firsthand what solutions are best for your needs.

How to Register

Pick up the nearest phone and punch 800-225-4620 (toll free); if in Massachusetts, call 617-879-4502. Our staff will register you immediately and send all the exciting details. It's that easy!

November 1, 2, 3, 1977
Los Angeles Convention Center

Co-Sponsored by
DATAMATION
Magazine



TRAN for both program instruction codes and data. With the PDP-11/45 and 11/70 memory management units, separate 32K words of instruction and 32K words of data may be accessed by a FORTRAN program. With the EMU and its word-addressability, a PDP-11 can access 2 million words of data at a speed only slightly less than that of main memory, permitting FORTRAN data arrays of 1,024 by 1,024 floating-point words. The EMU allows the PDP-11 minicomputer to approach problems that currently challenge the storage capacity of the larger mainframe computing centers.

GeoData. In geophysical and oceanographic data processing, correlation, convolution and Fourier transformations of signals are performed directly, without the additional software nuisance of data blocking and unblocking. Using the EMU for acquisition of data and signals in the field permits higher data acquisition rates with some portion of the increase in system performance allocated to pre-processing of the acquired data. Pre-processing in the field assures data quality and yields preliminary impressions before extended data processing provides finer detail. Dr. Lake emphasizes that aboard ship, where reliability in data acquisition weighs heavily, the dual-port EMU offers fail-soft capabilities. In a single-processor data acquisition system, both EMU ports may be on the single Unibus at different device addresses. Should a port fail, the EMU may be accessed immediately through the second port. If a second processor is available for back-up, its Unibus may be attached to the EMU via the second port for data pre-processing while the first processor performs the primary task of data acquisition. The EMU memory is sufficiently faster than the Unibus that both processors appear to have simultaneous access to the EMU memory.

The modular design of the EMU, he points out, provides fail-soft reconfiguration and low mean-time-to-repair. Each RAM memory board contains 64K by 9 bits; all memory boards are interchangeable. Each 16K RAM chip is socketed for immediate replacement should an EMU parity error lead to identification of a bad bit. EMU memory banks may be logically interchanged by swapping the two timing control

An Extended Memory Unit eliminates the rotational latency of a fixed-head device.

boards — assuring that contiguous EMU addresses are immediately available if the EMU is reconfigured into a fail-soft condition. DIP switches for each EMU port select control register and interrupt vector addresses. Write protection for the EMU contents may be controlled by hardware and/or software.

With a mean-time between failures of 38,000 hours (4 years), reconfiguration of the EMU is unlikely. Nonetheless, Dr. Lake claims that the design reflects thoughtful consideration for the user who must maintain computer system operation.

System Design

The design criteria of utility, modularity, high mean-time-between-failures, low mean-time-to-repair and low cost are best demonstrated in the dual-port EMU design. The dual-port system contains two full Unibus interfaces which may reside at different addresses on a single Unibus or each at the same address on the Unibus of different processors. Nine card modules (4.5" x 8") comprise each Unibus interface port. Each port occupies the left hand side of one row in a 10.5" dual row card cage. Each card module interchanges with the one above it.

EMU memory modules are the same size as Unibus cards; each stores 64K by 9 bits using 16K MOS RAM memory chips. Any two memory cards interchange without re-addressing. Memory blocks of 256K words reside above and beside each other on the right hand side of each card cage row. Separate DC power connections, available for the top row and bottom row, permit redundant power supplies. Timing and control modules determine logical addresses within the EMU. Interchanging timing and control cards permits rapid reconfiguration of a multi-256K block EMU to prevent contiguous logical addresses. A single priority arbitration card provides apparent simultaneous access for both ports. Switching permits immediate forced assignment of the entire EMU memory exclusively to either port. DD

Now! Adtech Power Supplies are built in France for fast delivery anywhere in Europe!

The standard OEM power supplies that are the best buy in the United States are now manufactured and sold in Europe by SOPHIA, the wholly-owned subsidiary of Adtech Power, Inc., Anaheim, California, U.S.A.

For product literature, prices and application, contact: SOPHIA, 46 BD. Roger Salengro 78200 Mantes La Ville, France, Telephone: 4775301 +

See the Adtech Product listing on the preceding two pages.



WHOLLY OWNED SUBSIDIARY OF
ADTECH POWER, INC., ANAHEIM,
CALIFORNIA 92806, USA.

CIRCLE 32

Where Conductive Elastomers Fit

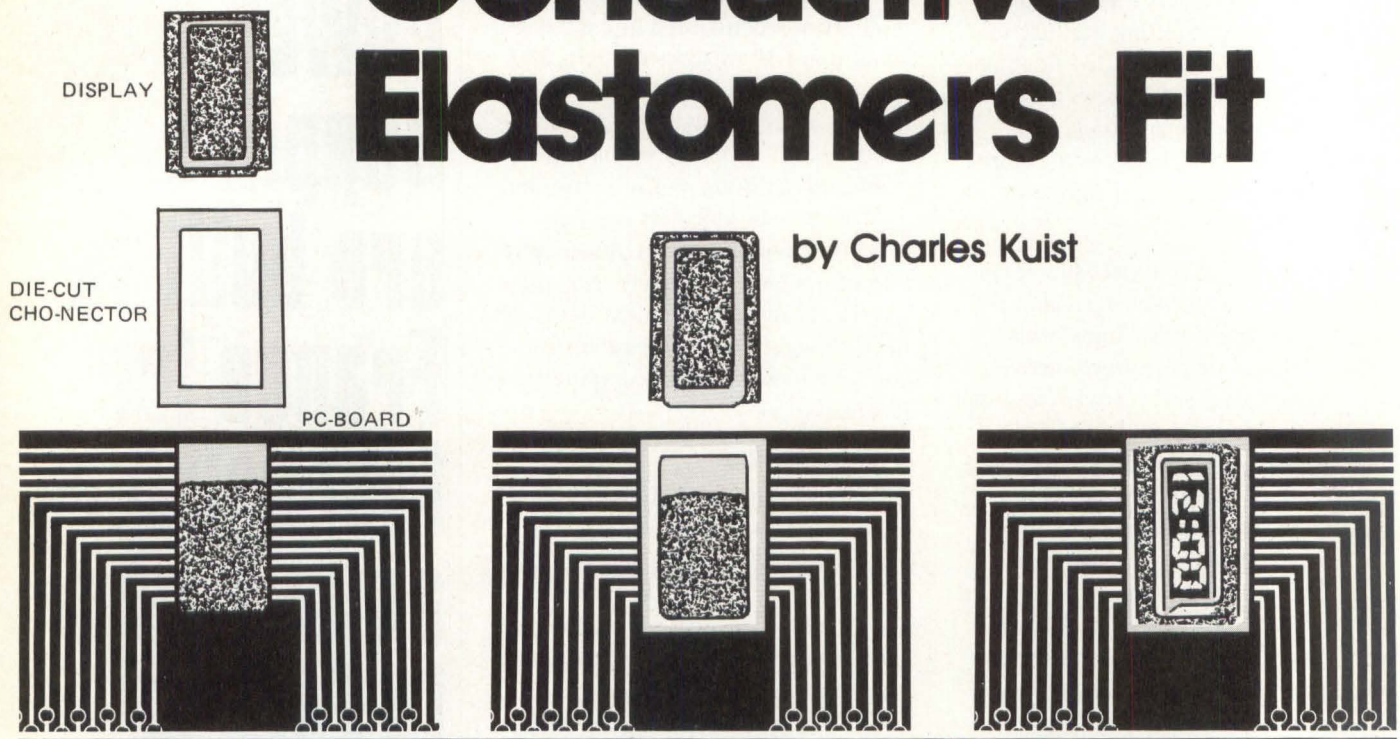

by Charles Kuist

As materials, electrically conductive elastomers are not new. They have been in use for some time as signal measurement and transmission probes, RFI shields and static arrestors. As circuit parts, however, they have only recently come into their own, but they have already added new looks and dimensions to package configurations.

These elastomers serve mainly as replacements for mechanical switches and connectors in electronic circuits and devices and as connectors between PC boards and LEDs, flat packs, leadless ICs and other PC boards. What makes them remarkable is that they can provide 7000 or more interconnections per sq in — a fact that has started a trend away from the traditional space-consuming practices of arranging connectors in a linear pattern and bringing sets of PC connectors to an edge tab.

Thermally conductive elastomers are somewhat newer materials and are being used to electrically isolate power transistors, diodes, SCRs, Triacs, plastic and ceramic dual/in-line packages, and even whole circuit boards from heat sinks. They are important because, as packaging densities push ever higher, they offer an effective means for reducing temperatures in and around heat-sensitive chips.

The most impressive feature of conductive elastomers is their ability to be blended to meet a range of electrical, thermal and mechanical properties.

Inside conductive elastomers

Most electrically conductive elastomers are blends of usually insulating elastomers, or matrix materials, and minute particles of metallic or nonmetallic conducting fillers. The filler densities are such that the particles constantly touch each other and form discrete, low-resistance paths from one surface of the materials to the other.

The most popular matrix material is silicone rubber, which remains stable at temperatures ranging from -100° to 400° F and resists moisture, oxygen, ozone and ultraviolet light. Other matrix materials include polyethylene, EDPM, butyl rubber, neoprene, and vinyl, all of which offer certain advantages for specific applications.

Filler materials are selected for their resistivities and include carbon (the most popular and least expensive but also the least conductive), silver or silver-plated materials, gold, nickel and others. The filler accounts for up to 85% of the compound's weight and offers a thermal conductivity many times that of the matrix material.

Elastomers for electrically conductive applications can be made into sheets, films, rods, and foams of various sizes, thicknesses, and densities. You can even precision-mold or extrude them into practically any configuration to provide conductivity wherever needed.

Fig 1 (above) No special orientation of the high-density interconnector is required for good electrical contact between the 26 pads of the display and the 26 lines on the PC board.

Verbatim™

You want to record your message verbatim—word for word—whether it's bits, bytes or "Dear Folks" translated into word processor language.

Our objective in manufacturing recording media for the electronics industry—digital tape cassettes, floppy disks, mag cards, computer cartridges—is to give you the finest, the best, the most dependable, the most cost-effective.

That means rugged, long-lived, abrasion-resistant recording media with superior magnetic qualities. If we made tires, they'd be steel-belted radials.

We delivered our first digital grade certified tape cassettes back in the beginning, 1969. We made the first commercial 3740-compatible floppy disks that didn't bear IBM's name. And the first Flippy® reversible flexible disks with *anyone's* name on them. The first mini data cassette is ours. And we've got the newest miniature flexible disk, the MD 525.

**The
whole
message
is quality.**

Now, Verbatim media. It's a new formulation of ferric oxides, an advanced macromolecular binder system to adhere it to the tough polyester film, and a process control system that demands over 200 separate quality checks before the material is cut, packaged, and certified to be 100% error-free.

The final quality check? "Make it pretty!" Our production people tell us that magnetic recording media is one of the rare instances in manufacturing where aesthetic appearance translates directly into final product quality. It has to look beautiful to work beautifully.

We have the formulas, the machines, the technology to make high quality recording media. But it takes the best people in the industry to deliver Verbatim disks, cards, cartridges and cassettes. You'll find them here. Write or call for our new monograph, "Data and Word Storage Media." Phone (408) 245-4400. TWX 910-339-9381. 323 Soquel Way, Sunnyvale, CA 94086.

In Europe: Information Terminals SA

Case Postale 296

1215 Genève

Switzerland

Tel: (022) 32-32-39

Telex: 22647 ITGE CH



Information Terminals Corp. 

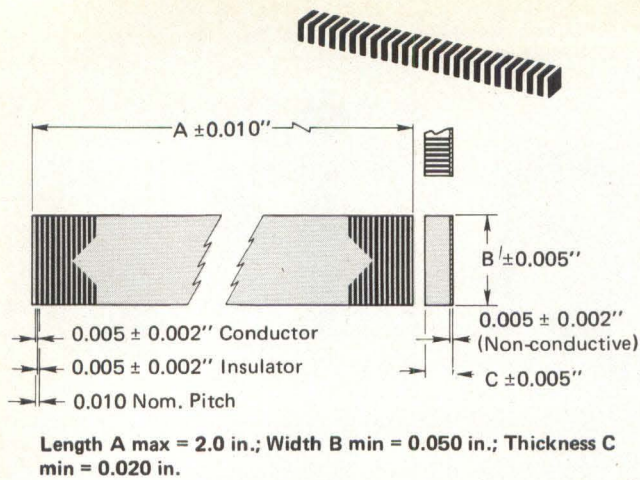

Fig 2 Strips of conductive and nonconductive silicone rubber are bonded alternately to form this one-dimensional, discrete-path conductive elastomer. Length A max = 2.0"; width B min = 0.050"; thickness C min = 0.020".

The material conforms to contacting surfaces and, unlike point contact connectors, it carries current in all areas of contact. While a dirt particle will keep rigid surfaces apart, rubber surfaces conform around the particle and ensure continued electrical contact. You can flex the material almost indefinitely without changing its mechanical or electrical properties, and it is soft enough to be used for shock and vibration damping in many applications. The elastomers resist corrosion, and many of them when torn or punctured close tightly enough to seal out adverse elements.

Thermally conductive elastomers blend silicone rubber and crystalline ceramic powders, which provide heat-transfer characteristics. They offer flexibility and conform well enough to allow for minor surface irregularities without thermal grease. Eliminating thermal grease has proved a major assembly advantage. These elastomers usually come in sheet, gasket and washer form, but you can mold them into a variety of shapes as required.

Applications for conductive elastomers

Electrically conductive elastomers in widespread use include switch-element materials, display-mounting materials and high-density interconnection material.

Made from silicone rubber and conductive metal powders, switch elements are spongy, nondiscrete-conductive-path elastomers that you can sandwich between circuit contacts to function as switches. In this application, the elastomer pads replace beryllium-copper spring fingers in a digital

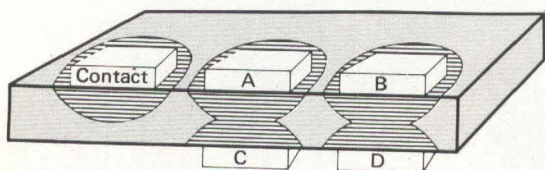

Fig 3 Low-resistance paths are created through, but not across, the elastomer when metal contacts are placed on opposite surfaces. Between points A-C and B-D, resistance is less than 1Ω. Between points A-B, C-D, C-B and A-D, the resistance exceeds 1000 MΩ.

watch. The pads are retained in slots in the plastic housing, but for other applications, you can laminate the elastomer to metal surfaces or bond it with adhesive. While pads cost more than metal connectors, they eliminate so much solder labor that they reduce overall package costs.

This conductive elastomer has also attracted attention from computer manufacturers, who have become more aware of what electromagnetic interference (EMI) does to systems and peripherals. Because the material was developed originally for use in EMI shielding and easily molds into gaskets, it provides a means for eliminating noise problems.

A one-dimensional discrete-path conductive elastomer mounts displays close to an outside surface to improve the appearance of digital panel meters and other products. Such upfront mounting proves difficult if not impossible to achieve with conventional spring connectors. The elastomer also connects flexible circuits, calculator displays and PCBs.

Termed Cho-Bra, this display-mounting material is made by alternately laminating 0.005"-thick conductive and non-conductive silicone rubber sheets (Fig 2). The conductive elements offer low resistance and are closely controlled during manufacturing for straightness, width and inter-element spacing. The connector also contains a nonconductive edge to prevent shorting against metallic surfaces. Cho-Bra is flexible, self-gasketing and easily compresses to as much as 15%

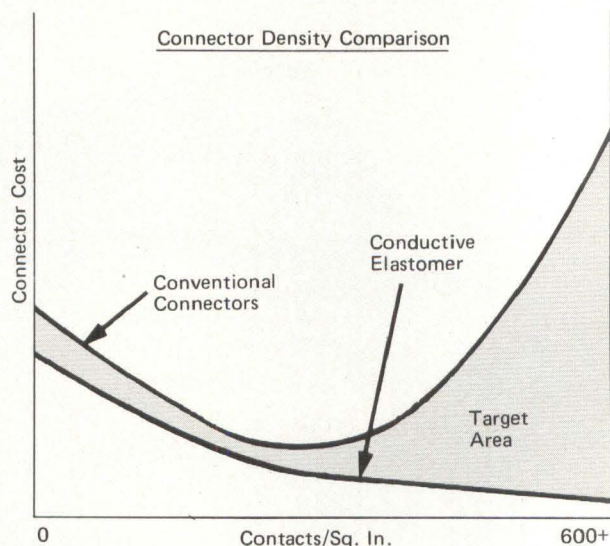

Fig 4 In high-density applications, the cost per contact decreases as the number of contacts increases.

of its relaxed thickness. For all practical purposes, the laminate consists of a single piece and will not come apart at the seams even under extreme pressure conditions. It also withstands shock and vibration — a characteristic that makes it ideal for packaging applications.

In applications requiring high-density interconnections, a conductive elastomer called Cho-Nector offers the greatest potential. Cho-Nector consists of a silicone matrix in which spherical metal particles of carefully controlled diameters are dispersed to form very small clusters. As a result, the elastomer exhibits short-range conduction, i.e., when die-cut parts or sheets of the material are sandwiched between opposing contact arrays and subjected to just enough pressure to ensure surface contact, conductive paths form through, but not across, the material (Fig 3).

Gulton's Non-Impact Thermal Printers

Printers don't have to use complex clicking and banging mechanical devices as their print mechanisms. Gulton proves it with a line of printers that provides totally quiet operation. With the Gulton non-impact thermal technique, only one moving part is required, the tape drive motor. The tape glides silently beneath the thermal print head at up to 4 line/sec. print rate to produce clear, readable characters. Three basic printer models are yours to choose from — each with distinctive characteristics that sets it apart from any other printer.



20 Column Full Alphanumeric Printer AP-20

Twenty columns. Full upper case 64 character ASCII subset. Panel mounting. Quiet reliable thermal printing. Complete with all electronics including power supply. Simple parallel interface. Print rate is 2.5 lines/second. **The most significant advance in printers yet!**



Seven Column Numeric Printer With Data Identification ANP-9

Seven columns of numbers with left hand decimal point in each column, or six with a plus/minus sign . . . and two columns of data identification numbers, letters and symbols. Eliminates transcription errors and unidentified numbers. Data identification characters can be specified to the left or right of the number columns. A standard 32 character set of data identification characters is provided. However, any special characters that can be formed by a 5 x 7 dot matrix are available.



Seven Column Numeric Printer NP-7

Seven columns of printing. Four print head styles to choose from: either seven columns of numbers, or six columns of numbers with plus/minus sign in first, second or third column. Character type is standard seven segment with left hand decimal point in each column. Panel mounting configuration. Fast, simple tape loading. Complete with electronics for easy interface to all popular digital panel meters.

gulton[®]

Measurement & Control Systems Division
Gulton Industries Inc., East Greenwich, Rhode Island 02818
401-884-6800 • TWX 710-387-1500

See us at Wescon Show, Booth 1752-54.

CIRCLE 34



Our adventures with LSI-11*

Of course the uphill climb is easier when we help:

For example, can you use EPROM Memory with on board programming? Or a Q-bus to Unibus adaptor? Or perhaps a Dual port memory? Heavy duty packaging, power supplies and the best line of modules in the LSI—business. Designed for reliability and to help you!

Write or call
LSI-11 order desk
(415) 657-7555

STANDARD ENGINEERING CORPORATION
4400 Industrial Drive - Fremont, Calif. 94538 • 415 657-7555
*Trademark Digital Equipment Corporation

CIRCLE 35

DIGITAL RECORDER

- Low cost, high reliability, compact
- One supply, 2 moving parts, excellent speed control
- Full electronics, TTL I/O, Auto-Sync® phase encode/decode
- Short IRG, 5.7 megabits, 8K Baud

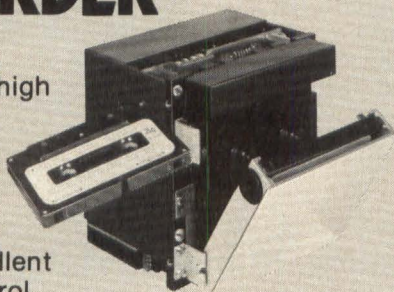

Model CS-400A

BRAEMAR
COMPUTER
DEVICES, INC.

11950 TWELFTH AVENUE SOUTH
BURNSVILLE, MINNESOTA 55337
(612) 890-5135

CIRCLE 71

The advantage of using Cho-Nector as an electrical interconnection is that you can create any configuration of independent contact pairs as long as they are separated by a distance slightly greater than the thickness of the elastomer. Under these conditions, the resistance through the material will usually prove less than 1Ω , and the resistance between contact pairs (circuit isolation) will exceed $1000\text{ M}\Omega$ (Fig 3).

Another advantage offered by this high-density interconnector is that it requires no particular orientation at assembly. Because of its flexibility, those contacts which are not coplanar still connect within the practical limit of the rubber's deformation. The flexibility of the silicone also allows it to follow any thermal expansion or contraction of the substrates.

Cho-Nector easily handles 6-mil contacts on 12-mil centers. Thus, you can make some 7000 connections per sq in. Another version of this material handles more than 16,000 contacts per sq in (128 x 128 discrete bits of data) for use in an array or parallel processing computer. In this application, the material will be used for assembling chips containing up to 16,000 array elements whose 4-mil contacts will be spaced on 8-mil centers. In such high-density interconnection applications, the cost per contact decreases as the number of contacts increases (Fig 4).

Cho-Nector conducts statistically in that the contact area and spacing in high-density applications directly affect the certainty with which all multiple connections will mate. If you probe the surface of the material with a point contact, you find many small areas that do not conduct. The larger the probe, the fewer areas you find. With a minimum-sized probe, you find no areas of nonconduction.

Although typical applications of Cho-Nector involve interconnecting electronic devices and substrates, the material has received serious consideration as an alternative to conventional IC wire bonding. If it proves successful, it will not only reduce package costs by eliminating gold wire and associated labor, but it will also allow you to salvage a package if an assembly proves defective — something that cannot now be done economically, if at all.

For applications requiring efficient heat transfer and electrical insulation, interface materials like Cho-Therm are used. These materials combine the best properties of conductive ceramics and thermal greases but have none of their drawbacks. Nontoxic Cho-Therm conducts heat as well as or better than greased beryllium oxide, greased hard anodized aluminum and aluminum oxide, and greased mica.

Solutions in search of problems

As you continue to learn how to use conductive elastomers, you will see some radical departures from traditional design concepts. Whereas the trend toward miniaturization of electronic circuits and devices followed an almost predictable path because of practical limitations, the trend toward device interconnection and component packaging will go the way of the designers' imaginations. No longer will designs be shelved because of the lack of interconnection methods. On the contrary, conductive elastomers will provide even greater design freedom because of their almost limitless potential.

Charles Kuist is VP of Chomerics, Inc., Woburn, MA.

You'll find our Series 700 is the *most significant* head per track disk memory introduced in years.

The reason. It's small. Low-cost. Lightweight. Reliable. And designed for easy servicing. Of course we're using our most proven technology in the Series 700. Technology that made General Instrument the world's leading independent supplier of rotating memories. But we're also using innovative design techniques that allow high performance and reliability...while keeping costs low.

The Series 700 offers up to 19.2 million bits. Up to 128 tracks in 32-track increments. A *fast* average access time of 8.5 milliseconds. 3600 rpm. And a data rate up to 4.5 megahertz.

You'll get a new head assembly that's been proven in current military programs. Modular construction so one unit can meet all requirements. Minicomputer compatibility. A completely self-contained system. Standard recording disk. And other important features all packaged in a 7-inch high unit. All at \$3985.

Serviceability. The Series 700 was designed for *service simplicity*. It's essential in many applications. Like point of sale, data entry and small business processing. Anywhere you'll need *maximum access* to service and inspection areas.

Our goals are still simple. Provide quality rotating memories. Be responsive. And maximize customer convenience.

We're in most major U.S. Cities and Europe. Call (213) 973-1741. Or write for our new Series 700 brochure. General Instrument Corporation, Rotating Memory Products, 13040 South Cerise Avenue, Hawthorne, Ca. 90250.

*OEM price @ 100 units per year.

\$3985 a megabyte

small... light... low cost

new head-per-track disk memory



SEE US AT
SYSTEMS '77 U.S. PAVILION



GENERAL INSTRUMENT CORPORATION
ROTATING MEMORY PRODUCTS
13040 South Cerise Avenue • Hawthorne, California 90250 • (213) 973-1741

VIEWPOINT

Are Engineers Really Different?

by Herbert F. Spirer

As an outsider — today — my viewpoint can't help but be conditioned by many years as a design engineer and a manager of engineers. What is lost in objectivity may be gained by a full understanding of both the technology and the unique pressures under which engineers perform their remarkable work.

About half the students and seminar attendees that I meet are engineers; my contacts go beyond the classroom and involve career and education counseling. What is common both to engineers and the others is a desire to manage, to manage better or to advance in the managerial hierarchy. Engineers (or for that matter, financial analysts) who are happy carrying out the purely technical functions do not meet me in discussion or class.

These contacts have led to a viewpoint about engineers as a group. Not a statistical study, but a purely personal, possibly inaccurate set of generalizations. Hopefully many of you will take the challenge and comment on the weaknesses and strengths of these generalizations; to the extent that the issues are opened, they may be of value to engineers. On the other hand, my viewpoint is a mirror in which the engineer can see his reflection as it is perceived by non-engineering management and executives, for that is the way I now look at the working world. Here are some of the general characteristics of engineers seeking greater knowledge of management; characteristics in which I perceive them as differing from the

Herbert F. Spirer is Professor of Management and Administrative Science in the MBA Program of the University of Connecticut at Stamford, Conn. His publications in the field of continuing education for engineers (The Engineering Manager Game Seminar, Financial Management for Engineers, etc.) have been adopted by the IEEE and over 20 other engineering/professional societies.

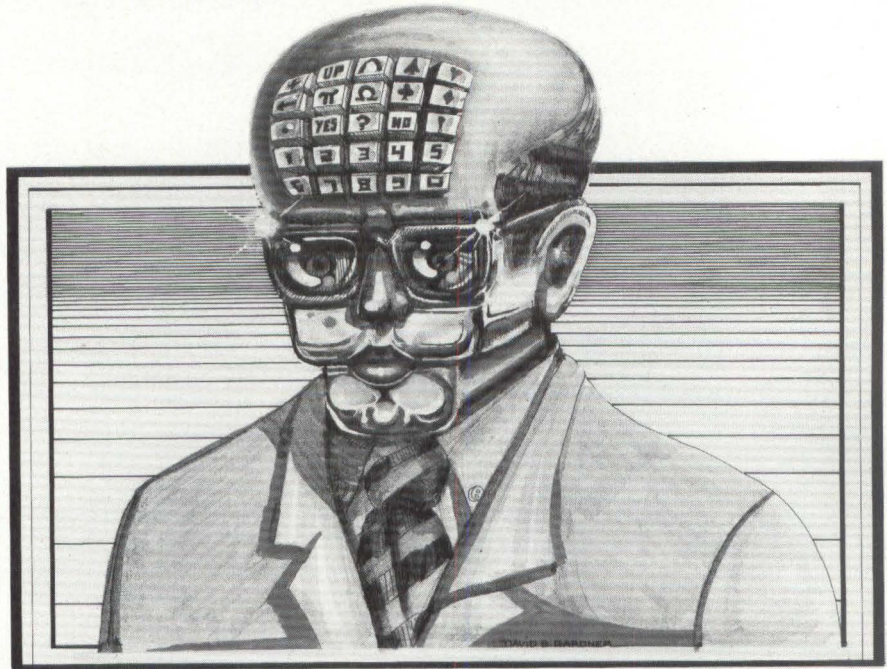

“ . . . The engineer seems to seek absolutes in all things including human relations . . . ”

financial analysts, the marketing personnel, the claims adjusters, the trust officers and so forth:

Rational decision-making. The ability and willingness to formulate decision-making situations in unemotional terms facilitating tradeoff analyses based on quantified criteria. This quality goes beyond the expected skill in mathematical manipulation; it involves the ability (and again, willingness) to categorize, to sort, to measure.

Lack of “give” in human relations. The engineer seems to seek absolutes in all things including human relations. Business life is marked by a continuing series of gives and takes: manager A does a favor for manager B and someday B will return the favor to A. The fact that the corporate policy did not require A to do this favor will not distress the business-oriented manager — it simply raises the value of the favor. The engineering-oriented manager argues that he doesn't have to do the favor, so why should he? In some cases, discussions of real-life instances arouses overt hostility from engineers against the concept of calculated “trades” in working situations.

A belief that taking human nature into account is “manipulation”. Salespeople know it instinctively, most teachers

learn it sooner or later, but only engineers seem to put a negative value judgement on a sensitivity and responsiveness to the other person's feelings. If you want someone to do something for you or to learn something from you, you don't deliberately offend them, putting artificial barriers in the way. All people have some “turnoffs” and it is only good management to learn what they are and to be sensitive to them in personal contact. If the chief draftsman is known to be offended by bare feet, then don't pitch him for a rush design job putting your sandaled feet on his desk. Yet in cases like this, I've had engineers (never any other profession) argue that to put shoes on to talk to the chief draftsman would be “manipulation,” “being untrue to myself,” “presenting a false image,” and so forth. They don't seem to understand what is being said to the other person: I don't give a damn about you!

Easily mobilized anxieties. The occupational psychologist named this (through extensive studies) characteristic of engineers many years ago. Engineers worry not only about their own jobs; they worry about the success of the organization as a whole. In their suppression of their own self-interest in

Now you have a choice of DEC[®]-compatible floppy disk systems.

The DEC RX01.

It costs \$4,095.

You can wait months for it.

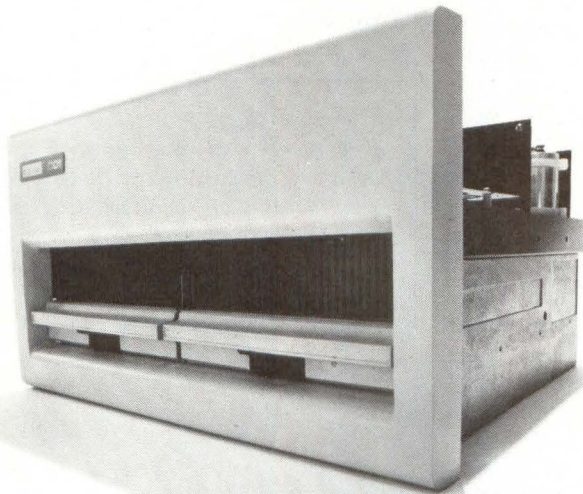

The DSD 210.

It costs \$3,295.

You can have it in weeks.

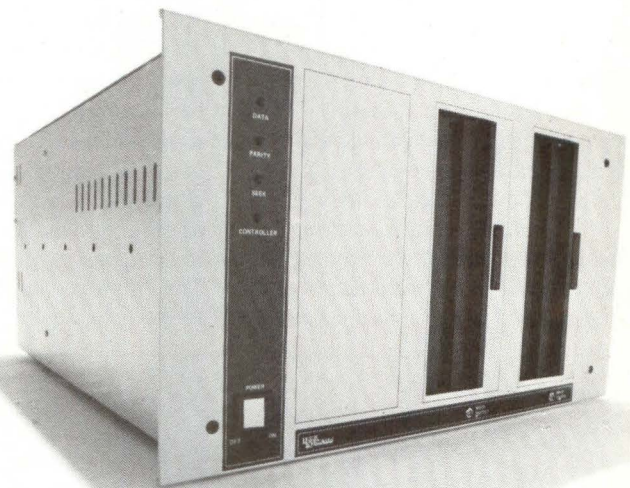

YES	PDP [®] -8, PDP [®] -11, LSI-11 plug compatible	YES
YES	Software compatible with all DEC operating systems	YES
YES	IBM 3740 Format	YES
NO	Write protect switches	YES
YES	Automatic head unload	YES
YES	Ceramic read/write head	YES
YES	Holds 256,256 bytes per diskette	YES
NO	Diskette formatting capability	YES
1 OR 2	Drives per controller	1, 2, OR 3
NO	Interchangeable 50/60 Hz operation	YES
YES	Digital phase-lock-loop data separation circuit	YES
NO	Front panel activity LED lights	YES
NO	Front panel system status indicators	YES
PARTIAL	Modular construction	COMPLETE
MINIMAL	Self-testing microcode	EXTENSIVE
NO	Field-proven Shugart drives	YES

Our DSD 210 floppy disk system is 100% hardware, instruction set, and media compatible with all DEC PDP-8, PDP-11 and LSI-11 systems. It costs \$800 less than DEC's RX01, has a far shorter delivery time, and has more useful features.

**Data
Systems**

For an expanded comparison and complete technical details, phone or write Data Systems Design, Inc., 3130 Coronado Drive, Santa Clara, CA 95051, 408/249-9353.

[®]registered trademark of Digital Equipment Corporation

VIEWPOINT

the interests of the needs of the project and the organization, they are truly outstanding among professional groups. It accounts for a lot of the conflict they experience with other groups. Years ago, after riding back from Washington in a plane with two of my engineers, the Director of Personnel of a large corporation said, "Your engineers are too highly motivated." They *cared* about the company; I thought this was great, but many members of organizations do not see beyond their own self-aggrandizement. Of course this quality has its negative aspects — for the engineer. What other group with so little long-term security works so much overtime without pay, and without even requesting pay? To have five engineers work all weekend, all you have to do is say that the job must be done by Monday; most others at a similar level expect and get time-and-a-half.

A lack of education in management.

Great advances have been made in recent years in knowledge of the behavior of people in working organizations in the fields of behavioral science, leading to such areas as organizational development and useful models. Similar gains

“...To have five engineers work all weekend, all you have to do is say that the job must be done by Monday . . .”

have been made in the scientific sides of management, in decision making, quantitative methods, operations management. Accounting (especially cost accounting) is as essential to the engineering manager as the general manager. I have observed not only that the engineers have had little exposure to these areas in formal studies; they do not seek continuing education in these areas as avidly as other upwardly-mobile professions. Of course, we can't rule out the effect of their employers. Many engineering employers are still refusing reimbursement to engineers for non-technical courses, to their own disadvantage. Whatever they are afraid of costs them dearly!

A naïvete about the essential conditions of employment. Being an employee is, in large part, a strictly business deal. The employee has something the employer wants (skill, effort, knowledge,

potential) and the employer has something that the employee wants (money, fringe benefits, security, opportunity for self-actualization). The employer pays so much for what he wants; the employee wants so much for what he has. A deal is made — an agreement — and a business relationship is made. When one or the other sees their needs differently, the situation is subject to change. It isn't a moral issue; it is simply a matter of trade. Years ago the manager of an employment agency told me, "Engineers are the only people who think that when they get a job they are married to the company." And, like many other infatuations, such "marriages" are subject to quick disillusionment and subsequent bitterness.

More could be said from this viewpoint, but one page isn't much to deal with the most important profession in our post-industrial society.

Do you see changes that should be made, trends that your colleagues haven't recognized, needs that aren't being met in your field? Digital Design would like to publish your viewpoint; just send it to Viewpoint Editor, Digital Design, 167 Corey Road, Brookline, Massachusetts 02146.

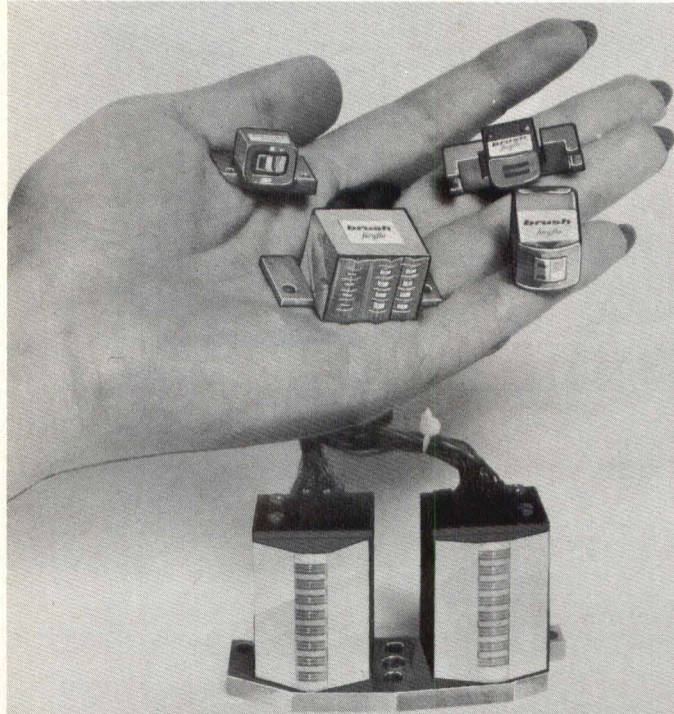

Selected heads shown include: (A) Reel-to-Reel Head, 1-inch, 14 tracks, interlaced; (B) Mini-Cartridge Data Head, full width, read/write; (C) Cartridge Data Head, 4 tracks, read-after-write, selective erase; (D) Credit Card Head, track 2 (ABA) — read; track 3 (thrift) — read narrow/write wide; (E) Cassette Digital Head, 2 tracks, read/write, with integral tape guide.

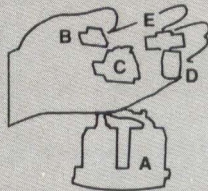

Brush DIGITAL MAGNETIC HEADS

We Read/Write YouLoud and Clear!

If you buy magnetic heads for data use, Brush is the name to know. We're the oldest company in the business. We produce magnetic heads for leading companies, large and small . . . to specification . . . and with consistent high quality, good delivery, and competitive prices.

We make them all. Cartridge, Mini-Cartridge, Cassette, Reel-to-Reel, and Card Stripe. And, for all applications: Credit Card & Passbook, MICR, Computer & Mini-Computer Peripheral, Terminal, Buffer Memory, Instrumentation, Process Control, Record & Billing System, Intelligent Typewriter, and more.

We can accommodate your needs. Stock, custom, or modified designs. Large or small quantities. Proprietary alloys for special applications. *Value-added extras* — mounts, guides, tape gutters, alignment and position references.

Call or write today. You will receive quick response and cost-efficient solutions.

brush™ magnetic heads

Division of FORGLO CORPORATION, Third and Reagan Streets
Sunbury, PA 17801 * Phone: 717-286-5611

First in Magnetic Heads

CIRCLE 38

Intel is a good second source for the 8080A microprocessor.

What's that you say?
Intel is the *primary* source
for the 8080A, not a secondary one?
Sez who?
Let's look at the facts.

National Semiconductor has
more of the things you want and
need in microprocessing systems.

We have twice as many support
products (our 8000 Series).

We have a broad line of other
electronic components, which Intel
doesn't, to provide a total solution to
any design problem.

We just sunk a million and a half
dollars into state-of-the-art micro-
processor testing facilities.

And finally there's price.

We make all our 8000 Series
products on the larger, 100mm dedi-
cated wafers. Which means more
stuff for less bucks.

And there's National's legendary
volume manufacturing efficiency.

So, we can beat Intel's prices.
Right down the line.
It's up to you.
Buy from the first.
Or buy from the best.

National Semiconductor
2900 Semiconductor Drive
Santa Clara, CA 95051

Gentlemen: Please send me information on
your 8080A family.

Name _____ Title _____

Company _____

Address _____

City _____ State _____ Zip _____

DD 9

All 8000 Series products are available from your
local National Distributor: Hall-Mark, Hamilton/
Avnet, Liberty, Carlton Bates, Avnet, Bell Indus-
tries, Elmer, Hamilton Electro Sales, Century,
Harvey, Schweber, Wilshire, Hammond, Pioneer,
Advent, P.I. Burks, Lionex, R-M, Summit,
Radio, Almac/Stroum, CAM/RPC, Mace,
Sterling, Taylor, Bowtec, L.A. Varah,
Electro Sonic, Preico, Semad.

 **National Semiconductor**

The 8080A diagram

At this writing, National Semiconductor is offering 60 support products for its 8080A microprocessor. (Most are off the shelf; all are compatible with National's standard MICROBUS,TM and with microprocessors of the future.)

Micro Bus

Digital I/O

Part No.	Description
8202	Tri-State 8-Bit Bus Driver
8203	Tri-State 8-Bit Bus Driver (Inverting)
82LS05	1 Out of 8 Binary Decoder
83C06	8-Bit I/O Latch
8208	8-Bit Bidirectional Bus Driver
8212	8-Bit Input/Output Port
8213	Bidirectional 8-Bit I/O Port
8216	4-Bit Bidirectional Bus Driver
8226	4-Bit Bidirectional Bus Driver (Inverting)

Peripheral Control

Part No.	Description
8244*	90-Key Keyboard Encoder
8245	16-Key Keyboard Encoder
8246	20-Key Keyboard Encoder
8247*	4-Digit Display Controller
8248*	6-Digit Display Controller
8253*	Programmable Interval Timer
8254	Programmable Bit Addressable Interface
8255	Programmable Peripheral Interface
8257*	Programmable DMA Controller
8258*	Advanced Programmable DMA Controller
8259*	Programmable Interrupt Controller
8272*	Floppy Disk Formatter/Controller
8276*	CRT Controller
8285	Character Generator
8292	8-Bit A/D Converter with 16-Channel Analog Mux
8294	3-3/4-Digit DVM with Multiplexed BCD Outputs
8298*	LLL 8080A "Basic" Interpreter Plus Hex Debugger

Intel couldn't run.

Intel offers only 29 support products.
Which leaves us with 31 more ways we can help you
get the job done.
And that's kinda nice.

8080A Microprocessor

Part No.	Description
8224	Clock Generator and Driver for the 8080A CPU
8228	System Controller and Bus Driver for the 8080A CPU
8238	System Controller and Bus Driver for the 8080A CPU

Communications

Part No.	Description
8250	Asynchronous Communications Element
8251	Programmable Communications Interface
8252*	Advanced Programmable Communications Interface
8261*	Programmable Communications Subsystem
8274*	Multi-Protocol Communications Controller-SDLC, ADCCP, Bisync, DDCMP
8283*	Advanced SDLC, ADCCP Protocol Controller

Memory

Part No.	Description
8356	2048X8 ROM, 128X8 RAM I/O
8154	128X8 Static RAM with 16-Bit I/O
8364/	8192X8 MOS Mask ROM
8364E*	(E is 2708 Compatible)
8316A/E	2048X8 MOS Mask ROM
8332E	4096X8 MOS Mask ROM (2708 Compatible)
1702A	256X8 EPROM
8704	512X8 EPROM
2708/8708	1024X8 EPROM
8101A-4	256X4 Static RAM with Separate I/O
8111A-4	256X4 Static RAM with Common I/O
8102A	1024X1 Static RAM
74C920	256X4 CMOS Static RAM with Separate I/O
74C921	256X4 CMOS Static RAM with Common I/O
74C929	1024X1 CMOS Static RAM
2114	1024X4 Static RAM
MM257	4096X1 Static RAM
DM87S296*	512X8 Bipolar PROM
5290	16K Dynamic RAM
8316A/E	Mask ROM (2708 Compatible)
DM74S472*	512X8 Bipolar PROM/20-Pin DIP
MM5204	512X8 EPROM

*Available soon.

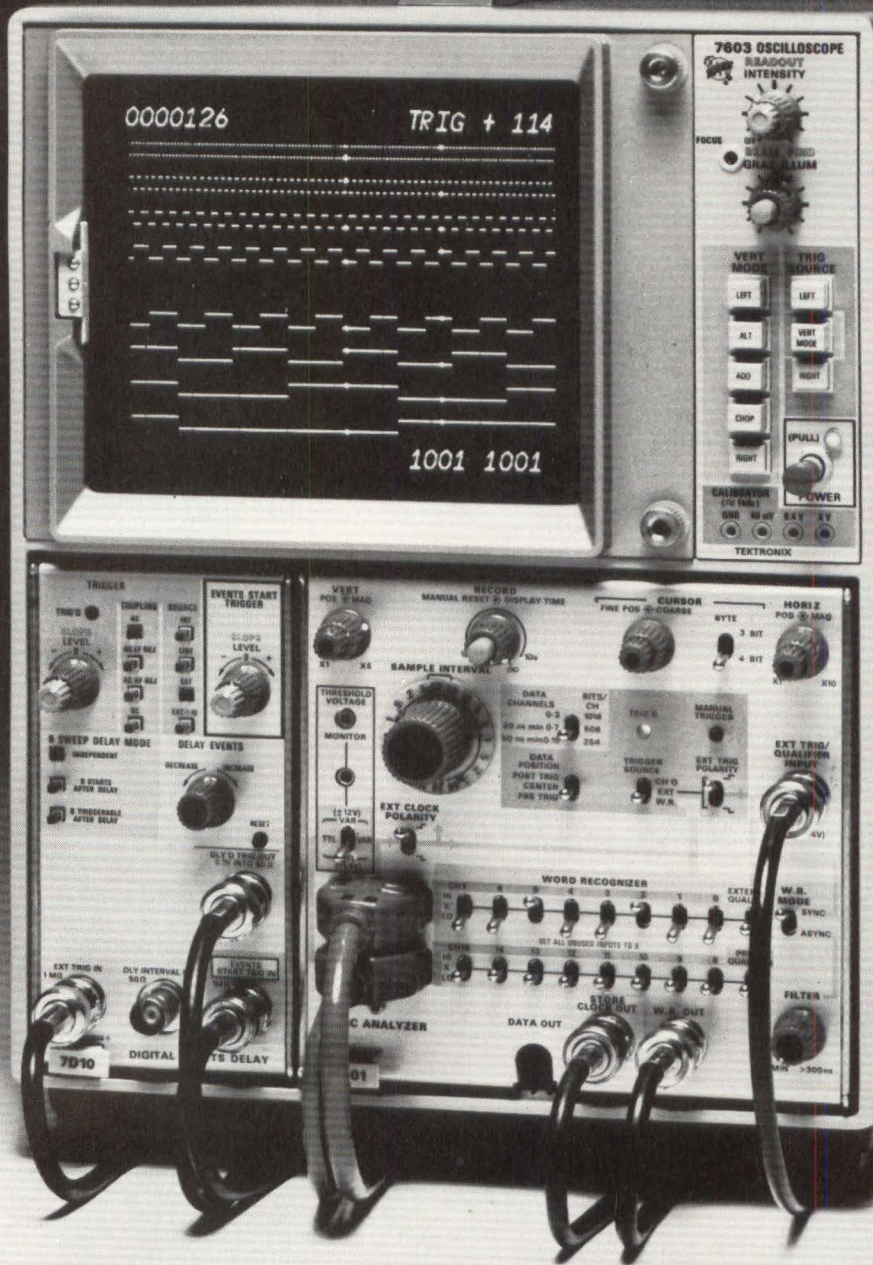

WHAT DO LOGIC ANALYZERS DO?

by Ken Pines

What the oscilloscope is to the analog world, the modern logic analyzer is to the digital world. In fact, the logic analyzer might better be called a logic scope, digital event storage scope or more simply, logic recorder. Logic or microprocessor analyzers as we know them today capture and store a number of digital channels and present them in some type of visual display for analysis. Since all analyzers perform the same basic functions, you can have a difficult time selecting a unit from the two dozen or more available at prices from \$300 to \$20,000. And we all know that the usefulness of any equipment, including logic analyzers may or may not depend upon the price of the unit or prestige of the manufacturer.

The satisfaction you will receive from an analyzer will be directly related to the usefulness in your particular application(s). Here, we'll give you a grounding by breaking down the analyzer into its basic components and discussing its features in detail. In this article, we will consider these basics; next month we will explore some actual field applications in which features of a particular machine were required to solve a problem. When we are through, you should have more insight into the choice of your next logic analyzer.

The Mouse in the Machine

When faced with an ever increasing number of highly complex logic and microprocessor analyzers, you should understand the basic concept of what will be called the "mouse" in the machine. Everyone who produces an analyzer must use a mouse from essentially the same source as anyone else who produces analyzers. Some of the mice run faster and some are bigger, but all come from the same sources such as Signetics, National, Motorola and others. As you may have guessed by now, the mouse is the memory, and all analyzers begin with a memory as the basic integrating factor. Every logic and microprocessor analyzer produced performs the same basic function: to "trap" or record a set of digital inputs, usually by sampling input data and storing it in a memory that varies in length from

16 to 2048 bits. The analyzer begins and ends the recording process and saves and outputs data of interest in some convenient manner for analysis. This is what a logic analyzer does and this is all it does. We will now begin to explore why and how analyzers perform these functions.

The Logic Analyzer vs. The Oscilloscope

The logic analyzer does not replace the oscilloscope, but functions as a companion device available for viewing several lines of digital data simultaneously. The major benefit derived from the use of the logic analyzer is the ability to freeze a low frequency or single event pattern that would not sweep the scope often enough to write a clear picture. Further, logic analyzers can stop the recording so as to save prior trigger information. In the analyzer, the trigger can be used to stop the record; in the scope, the trigger can only begin the recording or sweep of data. Short of expensive multichannel storage scopes that use glass delay lines, the logic analyzer is the answer for going back and viewing a multi-source sequence of digital events.

Basic Features

Threshold. Threshold detection at the input to the analyzer defines the logic states to be stored in memory. Available units are either fixed at a RTL, DTL or TTL level or else they allow adjustment throughout some range. Here the distinction between general purpose and special purpose machines begins to take place. A unit offered as a general purpose analyzer may have a number of fixed, switch selectable settings as well as a continuously variable range of from $\pm 2.5V$ to $\pm 15V$. Variable thresholds have two major benefits: the first is the ability to work on many different logic families and the second is that you can vary the thresholds about the specified value to check for marginal data transitions. For example, a TTL signal may be swinging close enough to the threshold to give intermittent results. Setting the analyzer thresholds to a value such as $+2V$ would clearly show if a signal is properly overdriving the $+1.4V$ TTL threshold. The general purpose analyzer can also set one group of channels at one threshold value while setting another group at a different value, thus allowing you to analyze two different logic families simultaneously.

Sampling. Logic analyzers use sampling for storing the input data into the memory. Based upon the information available at the threshold detectors, a high or low (1 or 0) representation is stored in memory on a periodic sample basis. The data stored for analysis is only a representation of the input data; your choice of analyzer will depend on the suitability of that representation to handle your requirements.

◀ Fig 1 A general purpose oscilloscope in the Tektronix 7D01 instrument shown here displays information for logic analysis. This analyzer can sample data asynchronously at rates up to 100 Mhz or synchronously at up to 50 Mhz and can format the 4096 bits in memory as 4 channels x 1016 bits, 8 channels x 508 bits or 16 channels x 254 bits. A digital events delay provides additional triggering flexibility.

Designing microprocessor

Get a system overview with this memory map. The 1600S shows how your memory is being utilized in an operating program. Knowing how your memory is organized, you can see at a glance what your program is doing and the relative time being spent in any one memory location. This helps you spot unwanted program sequences or parts of your program that aren't being implemented.

Base page data storage
I/O ports
Stack storage
Executive, interrupt and subroutine program
Interrupt vector address

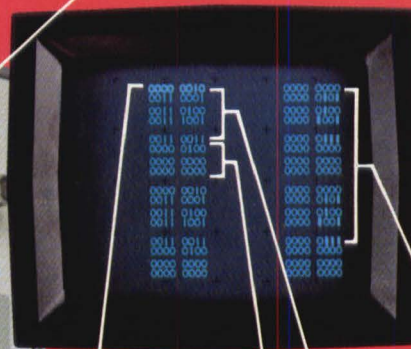
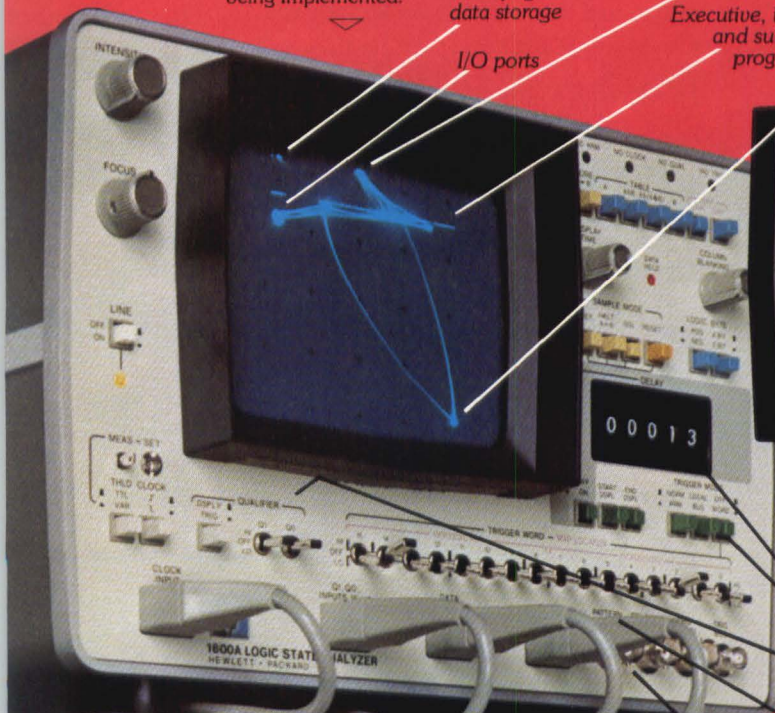

Monitor a serial data stream and compare new data with that previously stored. This display shows software conversion of BCD data at a 7-segment display to an ASCII format. Column blanking simplifies display by showing only 8 of 16 bits available.

Preamble
Postamble
ASCII of displayed data
Intensified bits are those that have changed since start-up.

Qualifiers, digital delay and various local or bus-triggering modes give you pinpoint selection of data flow for effective program tracing.

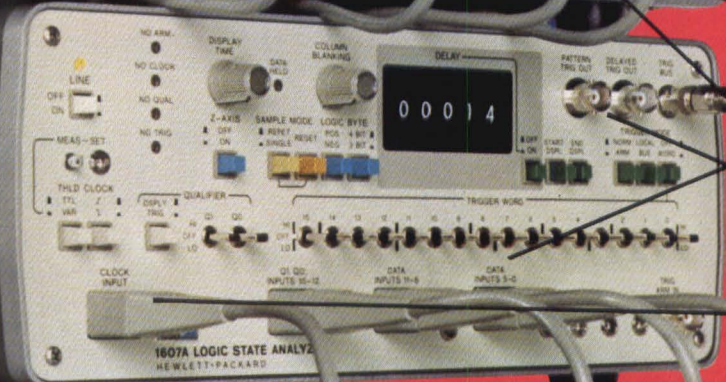

Up to 32 channels let you see all the action on the microprocessor address and data buses plus the I/O, peripherals or any other logic section of your microprocessor system.

Output triggers drive your scope—at the right instant—for making electrical measurements in the time domain.

Dual clock means you can easily relate bus activity to events occurring elsewhere at a different clock rate.

Serial-to-Parallel Converter (HP's 10254A) lets you directly view serial data in relation to parallel data on the system bus.

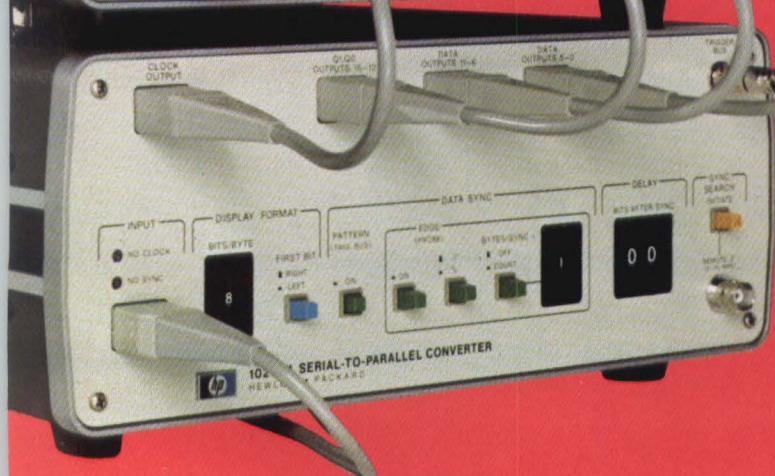

FREE DATA DOMAIN SEMINAR

Find out for yourself how HP Logic State Analyzers can broaden your view of the data domain and speed digital design and debugging of your microprocessor-based system. Seminars are scheduled in a number of cities throughout the country. Ask your HP field engineer about specific details on seminars in your area.

based systems? You've discovered

a new set of problems. Now discover HP's solutions.

HP's Logic State Analyzers give you a real-time view to help you spot and diagnose intermittent system operation. That can mean faster microprocessor system design and debugging.

The 1611A, priced at \$5000*, can be tailored to either 6800 or 8080 microprocessors now. And more "Personality Modules" will be available soon. The 1611A lets you view bus activity and external events from the microprocessor's viewpoint. And, mnemonic decoding greatly simplifies interpretation.

The 1600S, with up to 32 input channels, dual clock capability and priced at \$7100*, gives you a detailed real-time view of system activity from any

vantage point, regardless of differences in clock rate. Add the 10254A Serial-to-Parallel Converter for \$975* and you can simultaneously view serial data at peripherals.

One or more HP Logic State Analyzers give you greater insight for better understanding of your system's capabilities. That can mean earlier product introduction, lower development costs, a faster return on the development investment.

Your local HP field engineer has all the technical details. Give him a call today. And also ask him about HP's FREE seminars—An Introduction to the Data Domain. *Domestic U.S.A. price only

Debug your programs on operating hardware. Since the 1611A displays program flow in a real time inverse assembly, you can compare directly with your assembler listing. Trigger on an address, data, external lines or on any combination of the three to pinpoint a specific program location.

Fourth occurrence of interrupt

Trigger word (vector store location for interrupt sequence)

I/O port memory address

ENABLE TRIGGER	ADDRESS	DATA	EXTERNAL
TRIGGR	00XX	FFFB	29
DISABLE	0147	3E	00000011
TRIGGR	00000004	PRE-TRIGGR	00000000
ADDRS	OPCODE	DATA	EXTERNAL
0022	29	WRITE	0000 0010
0021	03	WRITE	0000 0010
0070	00	WRITE	0000 0010
006F	10	WRITE	0000 0010
006E	05	WRITE	0000 0010
006D	F0	WRITE	0000 0010
006C	0E	READ	0000 0010
FFFB	00	READ	0000 0010
2905	00	READ	0000 0010
0000	00	READ	0000 0010
000E	06	READ	0000 0010
2907	LDA	A 4000	0000 0010
4000	03	READ	0000 0010
290A	LDA	B 4000	0000 0010
4002	03	READ	0000 0010
290C	STA	B 0000	0000 0011

Mnemonic display of instructions

Read time intervals directly on the 1611A CRT to quickly determine elapsed time between any two program events. For example, this display shows the length of time it took to clear an interrupt so another interrupt could occur.

TRIGGER	ADDRESS	DATA	EXTERNAL
	4004		
ADDRS	OPCODE	DATA	EXTERNAL
4004	50	WRITE	0000 0011
4004	10	WRITE	0000 0011
4004	10	READ	0000 0011
4004	10	WRITE	0000 0011
4004	10	READ	0000 0011
4004	50	WRITE	0000 0011
4004	10	WRITE	0000 0011
4004	10	READ	0000 0011
4004	50	WRITE	0000 0011
4004	10	WRITE	0000 0011
4004	10	READ	0000 0011
4004	50	WRITE	0000 0011
4004	10	WRITE	0000 0011
4004	10	READ	0000 0011
4004	50	WRITE	0000 0011
4004	10	WRITE	0000 0011
4004	10	READ	0000 0011

Observe a selective store. For example, now you can observe all data transfer across an I/O port and exclude all other activity.

Read and write data at I/O port

Personality modules let you tailor the 1611A for either 6800 or 8080 microprocessors now, with others following soon.

Interrupt lines
Enable when interrupt line goes low
Disable when interrupt line goes high

Direct display of elapsed time



Output triggers drive your scope—at the right instant—for making electrical measurements in the time domain.

Keyboard mode selection and data entry speeds and simplifies set-ups and analyzer operation.

Self test and error messages give quick verification of correct instrument performance and signal when incorrect operation occurs.



1507 Page Mill Road, Palo Alto, California 94304

For assistance call: Washington (301) 948-6370, Chicago (312) 255-9800, Atlanta (404) 955-1500, Los Angeles (213) 877-1282

08717

CIRCLE 39

The available analyzers range in sample frequency from a few megahertz to 200 Mhz. The faster the analyzer, the higher the price, on what is almost a logarithmic scale. Analyzers in the range of 5 to 10Mhz generally sell from \$1000 to \$2000 range. 50Mhz analyzers run \$3500 to \$6000, while the 200Mhz entry hovers right around \$20,000. While slower units can cost more due to other features, in general "higher speed equals higher price". The question to focus upon when making a choice is how much speed will your application require.

Before we go any further on the question of speed, we should pause and explore the difference between the synchronous and asynchronous analyzer. The synchronous analyzer contains no clock of its own, and thus depends upon the system clock to drive its sample circuitry. This means that stored data will represent only the sequence of system logic occurring in synchronization with either the positive or negative edge of the system clock. The record contains no information about the relative timing or between-clock behavior of the signals. On the other hand, an asynchronous analyzer contains its own clock and can store timing and between-clock signal behavior as well as the sequence of system logic events. In order to clearly show the data and the timing information, asynchronous analyzers usually have memories many times longer (256 to 2048 bits) than the synchronous units (16 to 64 bits). The longer memory allows enough resolution of the stored data to clearly sort out anomalies (such as ringing and glitches) from the actual system data bits. For this reason, the synchronous units have a greater use in software applications whereas the asynchronous machines are more desirable for hardware debug. Fig 2 shows a situation where both synchronous and asynchronous analyzers captured the desired logic event with the asynchronous analyzer giving more insight as to the cause of the problem. It is important to note that all

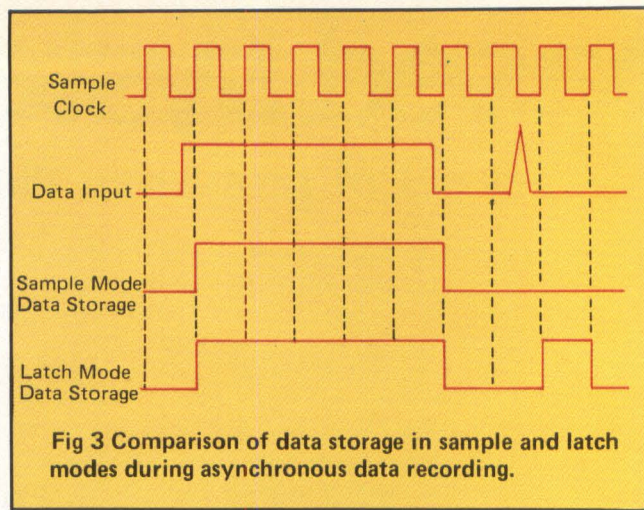
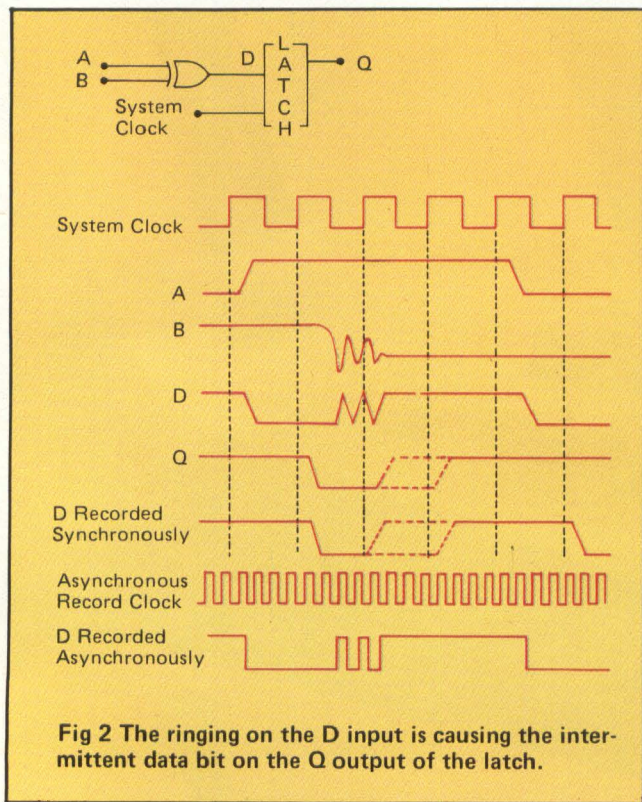

asynchronous analyzers can also operate synchronously from the system clock.

Now, we will go back to the question of how much speed is required. On a synchronous analyzer, the frequency limit need be only as high as the fastest system clock encountered. You need only make an estimate as to what you expect to see in system speeds over the next few years and choose accordingly. On the other hand, more thought is required when choosing an asynchronous analyzer.

Theoretical limitations of sampling data with an asynchronous clock require a minimum of two samples per data cycle. Practically, this limit is somewhere above four samples per cycle, and for good resolution of the data, the ratio can run as high as 10 or 20. The reason for the high multiples is that the one bit recording error associated with sampling becomes a much smaller percentage of the data, thus giving a much better visual representation when sampling at higher multiples. You can easily see the effect that a sample recording error would have on data sampled at 4 times per cycle and data sampled at 10 times per cycle. The general rule of thumb in purchasing an asynchronous logic analyzer should be to purchase as high a frequency as the budget allows with a minimum of somewhere in the range of 4 times the data frequency to be sampled.

Latch Mode. One item included in many asynchronous logic analyzers that you should examine closely is commonly known as latch mode. Latch mode allows an analyzer to capture data spikes or events that are narrower than the sample clock interval; latch mode can thus effectively increase the bandwidth or sample frequency of the analyzer. To better visualize the use of latch mode, see Fig 3. The narrow data spike would ordinarily be missed with a straight sampling technique since it appears after the clock edge and disappears before the next clock edge. The sampling circuitry would never know that the spike occurred. The latch mode circuitry captures the transition and holds it until the next clock cycle. In this way, the analyzer captures the high speed anomaly or glitch and stores it in its proper time sequence in relation to the rest of the data.

Latch mode has two major benefits to the user. The most obvious is the ability to capture high speed data anomalies, more commonly called glitches. The second, not quite as obvious, relates to extending the bandwidth capability of a unit when operating at slower speeds. An exam-

Pardon the tongue in cheek, but we wanted to say something in a "memorable" way:

Data 100 knows what an OEM wants in a line printer.

Like high performance with low noise.

That's because line printers are often located in offices. And offices have people in them. People who think better, work better in a quieter environment.

Meet our complete line of 62-300 lpm printers in optional Whisper Quiet cabinet. It lowers



the decibel reading from an annoying 77 to a people-pleasing 68. Yet delivers full performance.

Sound good to you?

It should. We're

proud to use these Whisper Quiet line printers in our Data 100 systems, too.

DATA 100
CORPORATION

**Data 100 knows
what an OEM wants
in a line printer.**

Whisper Quiet.

**Our OEM printers are so quiet they won't shatter glass.
Or nerves.**

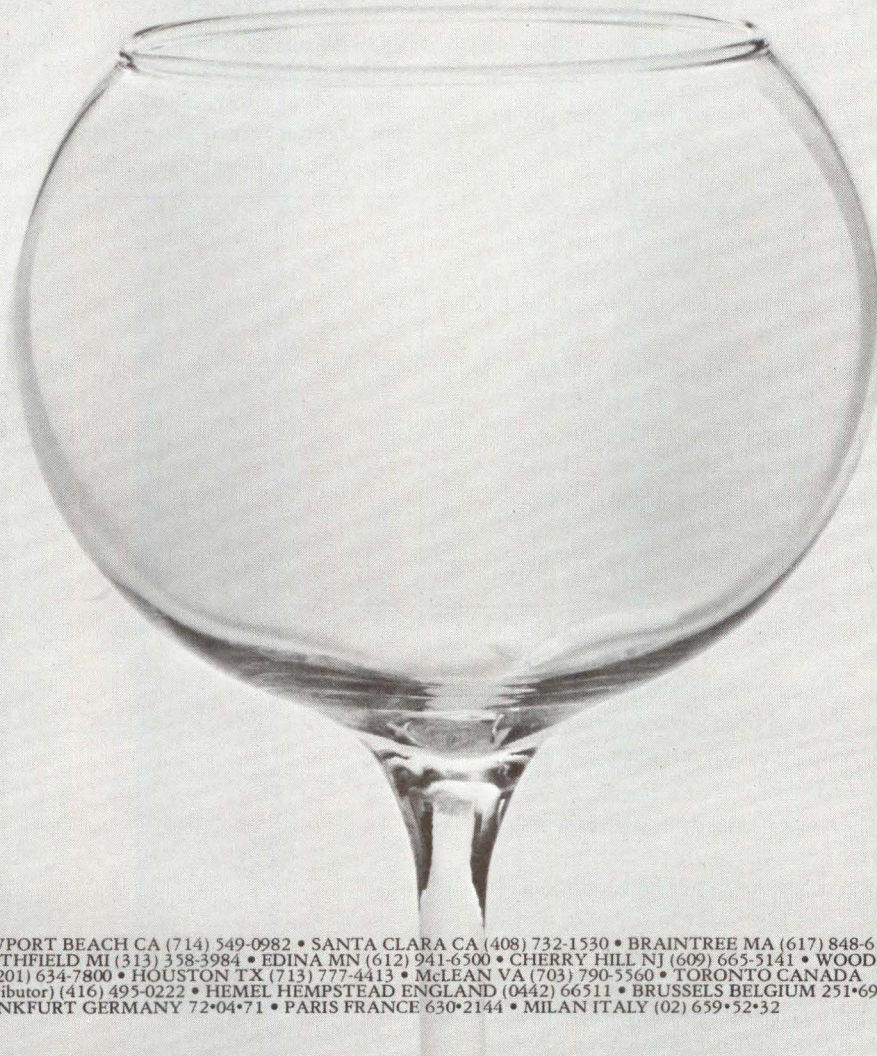

NEWPORT BEACH CA (714) 549-0982 • SANTA CLARA CA (408) 732-1530 • BRAINTREE MA (617) 848-6100 •
SOUTHFIELD MI (313) 358-3984 • EDINA MN (612) 941-6500 • CHERRY HILL NJ (609) 665-5141 • WOODBRIDGE
NJ (201) 634-7800 • HOUSTON TX (713) 777-4413 • McLEAN VA (703) 790-5560 • TORONTO CANADA
(distributor) (416) 495-0222 • HEMEL HEMPSTEAD ENGLAND (0442) 665111 • BRUSSELS BELGIUM 251•69•72 •
FRANKFURT GERMANY 72•04•71 • PARIS FRANCE 630•2144 • MILAN ITALY (02) 659•52•32

CIRCLE 40

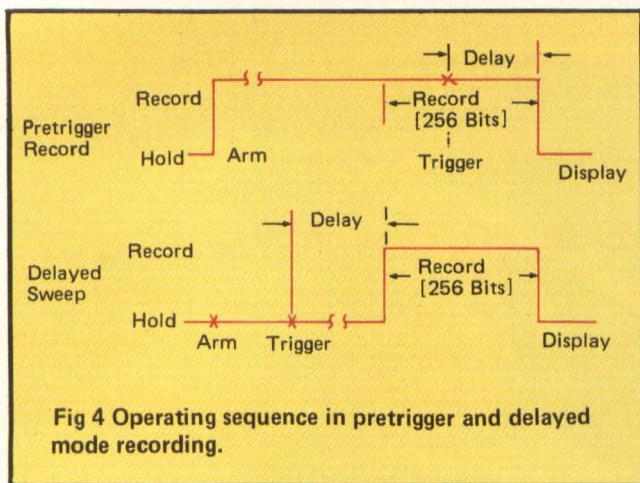

Fig 4 Operating sequence in pretrigger and delayed mode recording.

ple of this might be the desire to check timing between two 100ns pulses that occur in a system every 50 to 100ms. To see a full 100ms of recording, the sample interval might have to be as wide as 500ns. Without latch mode, you would not be certain of capturing the pulses of interest since they are five times narrower than the sample clock interval. This ability to capture data with certainty while running the clock at intervals wider than the data bits should be considered very carefully. It is probably the most important feature in a logic analyzer.

Record Modes. What we have explored so far, shows you that the logic or microprocessor analyzer is a very simple tool that records data in a snap shot fashion. In other words, what the analyzer does is take a picture of data that allows you to view the events for analysis. We will now look at the viewfinder of the data camera. The viewfinder allows you to focus in on precisely the time sequence of interest and ignore that which is not useful to your analysis.

As was stated earlier, all the available analyzers incorporate the ability to look at prior trigger data, a feature commonly known as pretrigger recording. The available variations allow setting the trigger at the beginning, middle or end of the record, or in some, at any location along the X-axis. Most analyzers also have a delayed mode feature whereby the sweep of data can be held off for 10,000 to 100,000 clock samples after a trigger event. This mode is very closely analogous to the delayed sweep mode in an oscilloscope and is very useful when looking at data that is delayed in time from some synch event or start bit. Fig 4 is a visual representation of the sequence of events in pretrigger and delayed mode recording.

Since pretrigger mode, given enough delay, could accomplish everything that delayed mode can accomplish, you might justifiably ask why include delayed mode on the logic analyzer? Including delayed mode lets you to put the unit in a mode most often called delayed repeat.

Delayed repeat mode operates so that after recording a sweep of data, the analyzer automatically re-arms, or re-sets; it is then available for a new trigger or synch event. This is sometimes referred to as a pseudo real time mode. The necessity for having a delayed mode in order to do the repeat type recording is because in pretrigger mode, the stored data begins to disappear immediately upon arming or re-setting. In that case, automatically rearming the unit at the end of record would ensure that no data would be held

in memory. In the delayed repeat mode, the old data is held upon rearming until a new trigger event occurs and the delay is counted out. At that time, the memory is refreshed with a new sweep of data. The stored information is always based upon the last event that triggered the analyzer.

Implementation of delayed repeat occurs in one of two basically different manners. In the first, the rearming process does not occur until the data has made a complete sweep of the output display. In this way, by watching the screen you can see that data jump if a pattern based upon a given event changed during one of the sweeps. This mode, although very esthetically pleasing, leaves the analyzer unavailable for data capture for a large percentage of the time that the analyzer is used, since the scope sweep takes more time than is required for filling the memories. The second manner of implementing delayed repeat is to re-arm the machine immediately upon the end of record. Thus the machine becomes available immediately after recording for a new trigger input. The esthetics of this type of implementation are somewhat less pleasing because the scope picture will appear scrambled during trigger cycling unless the triggers appear at a rate of a few hundred hertz or less. The benefit is that the machine is unavailable for triggering only during the delay count and recording process; the statistical probability of capturing the data based on the last repeating trigger event is much higher than in the first manner.

In the delayed sweep mode, the analyzer can count synch events. In some systems two levels of triggering might be required to see the data of interest that lies some given number of synch events from another start event. With an analyzer that allows event delay, the unit could be armed upon the start event and the synch events counted out before the data sweep was taken. This feature usually lets

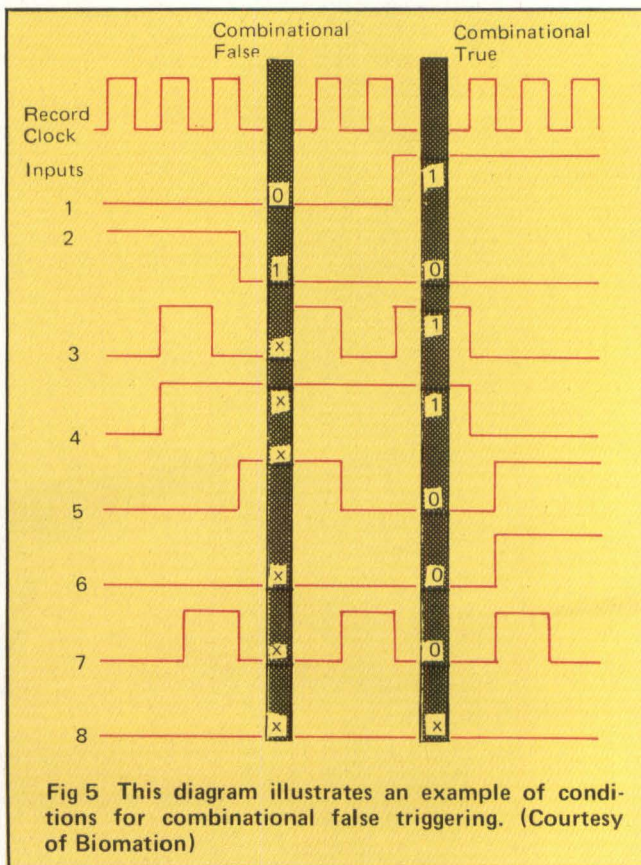
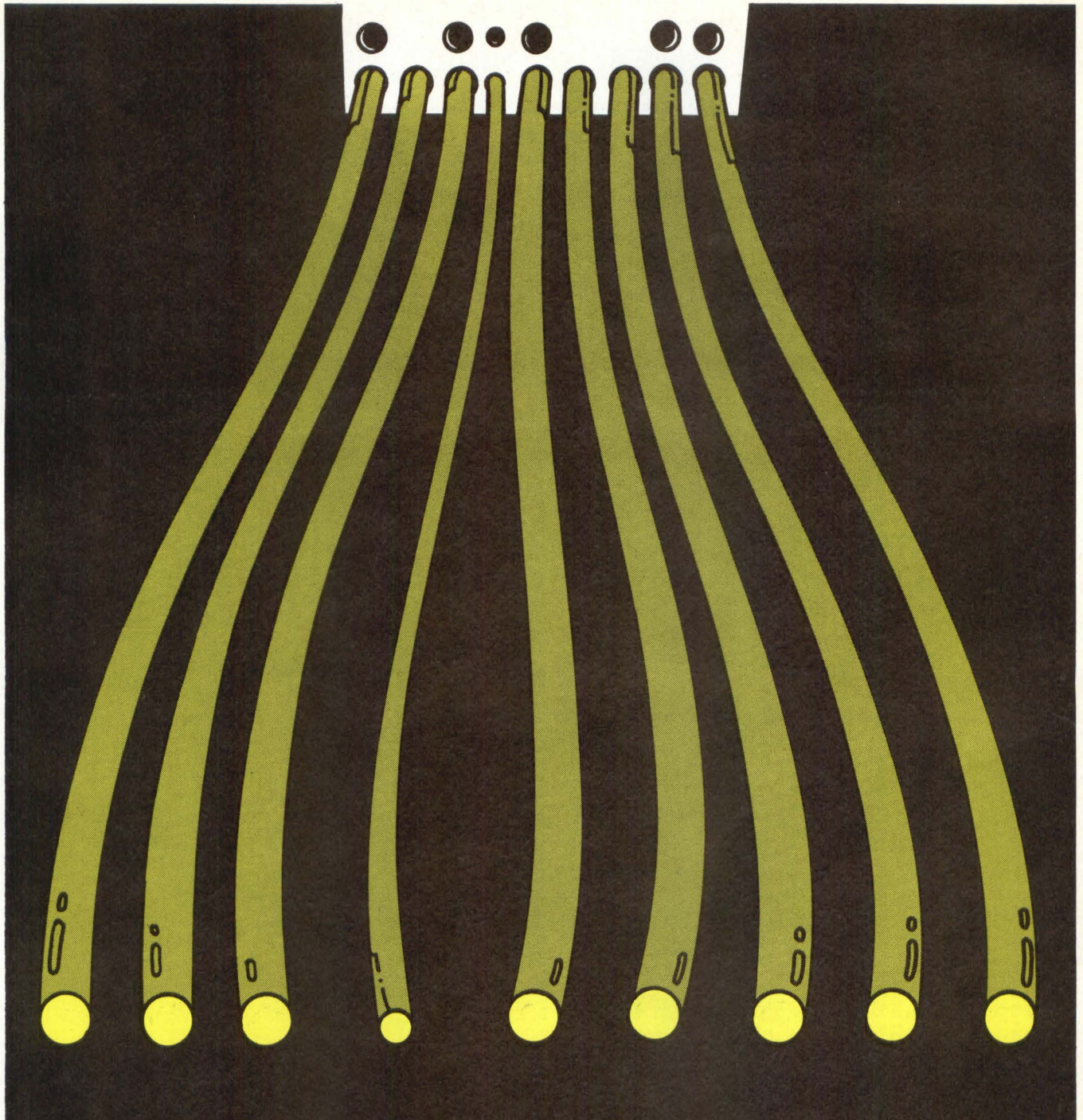

Fig 5 This diagram illustrates an example of conditions for combinational false triggering. (Courtesy of Biomation)



Our readers make light work.

Decitek photoelectric punched tape readers were all designed with state-of-the-art reliability — a fiber optic light distribution system and a beautifully simple patented dual-sprocket drive, which eliminates the need for level switches, tape guides and keepers. Since fewer actual parts go into our readers, greater performance comes out. It also gives us the lowest spare parts volume in the business. Decitek has, in a few

years come from nowhere to such a strong penetration of the market that we are now the number one supplier to the photo-typesetting OEM industry and gaining in the machine control and mini-micro computer field. We got where we are purely because of performance, quality, reliability and price.

We will work with you to make your equipment work better.

The more you know about punched tape equipment, the better you read us.

DECITEK

A DIVISION OF JAMESBURY CORP.
250 CHANDLER STREET, WORCESTER, MASSACHUSETTS 01602, U.S.A. (617) 798-8731

More

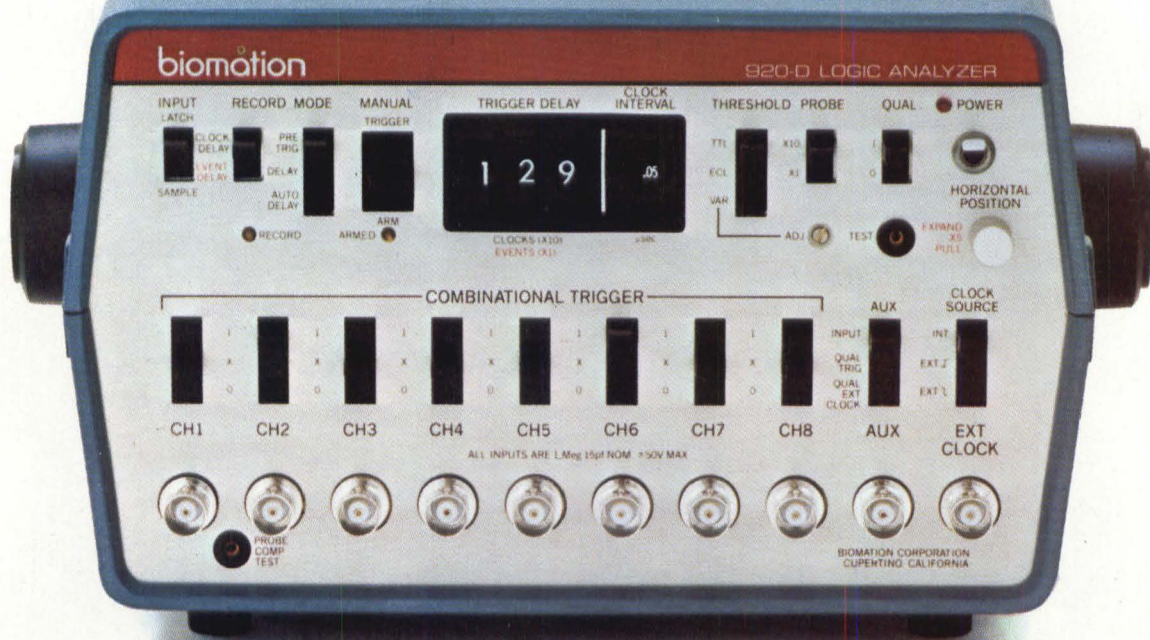

Introducing the 920-D logic analyzer. Nine channels, 20 MHz and much, much more.

Don't let the low price mislead you. Biomatron's new 920-D stands up to logic analyzers costing twice, even three times as much. It includes the functional features design engineers ask for most. And combines them with 9½ pound portability, making the 920-D an ideal field troubleshooting tool.

Nine channels — not just eight — give you added capability for more applications. Use the extra channel for recording data, or to mark a trigger location. And select between trigger or clock qualifier. Attach the optional Biomatron 10-TC probe pod and you can select up to a 19-bit combinational trigger word.

The 920-D enables you to set a precise interval between the actual trigger and the start of recording, using either clock periods or number of trigger events. Or the pre-trigger recording mode can be selected to capture data from before the actual trigger. The logic threshold level is selectable — TTL, ECL

or variable. And you can record at rates from DC to 20 MHz.

Captured data, at 256 bits per channel, can then be displayed on any single channel scope or CRT display in timing diagram format.

Compare the 920-D with other logic analyzers, for both price and performance. Then ask yourself if you can afford to settle for less.

Don't let the 920-D's many features and high performance mislead you. It's priced less — far less — than any comparable logic analyzer.

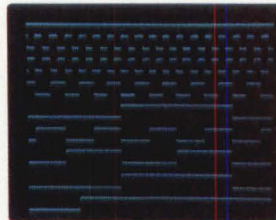

In fact, the 920-D's \$1295* price tag makes it practical to put its extensive capabilities to work

wherever you design, debug or troubleshoot TTL logic.

The 920-D is a cost-effective first logic analyzer for most applications. Years of experience providing

Less

\$1295.00

**BIOMATION 920-D
LOGIC ANALYZER**



thousands of engineers and technicians with the industry's leading family of logic analyzers has helped us design the 920-D with proven real-world features you can put to good use.

Low price makes the 920-D a great choice for your second... or third or fourth logic analyzer. You won't need to stand in line or share your company's only

logic analyzer when you have a 920-D of your own.

We built the 920-D for lightweight portability. It weighs in at under 10 pounds and connects to

the nearest oscilloscope or CRT. That makes the 920-D the newest tool for field service.

Biomation has led the way in logic analyzer developments. Today there are seven Biomatron analyzers, offering from 8 to 16 channels, 10 to 200 MHz capture rate, memory lengths from 256 bits to 2048 bits per channel and operating in both time and data domains.

What more can we tell you? Plenty. Ask for the 920-D product sheet. Or give us a call to arrange a demonstration. Ask for Ed Jacklitch (408) 255-9500. Or write Biomatron, 10411 Bubb Road, Cupertino, CA 95014.

biomatron

*U.S. price only

Circle No. 42 for information. Circle No. 102 for information and demonstration.

you look at a memory full of data prior to, or after the last counted synch event.

Triggering. To further carry on the analogy of a logic analyzer to a camera, we will now look at the shutter of the camera or the manner in which we generate synch or trigger events. Virtually all the analyzers in the marketplace have what can best be described as combinational trigger. This feature allows the selection on each data input of a 1, 0 or don't care status when making up the trigger event. The simplest way that this works is that when the data matches the setting of the combinational trigger, the machine receives a trigger event input. The availability of qualifiers and the selection of a make true or make false trigger enhances the combinational trigger.

Qualifiers allow you to look at a data bus location where different devices may put similar data. To use it for this purpose, you set the trigger to respond to a given address on the bus only when a particular device is transferred on the bus. The make true, make false conditioning allows the user to set the triggering in an "and" combination or an "or" combination of the trigger settings. Note in Fig 5 how the make true trigger responds when the set word ap-

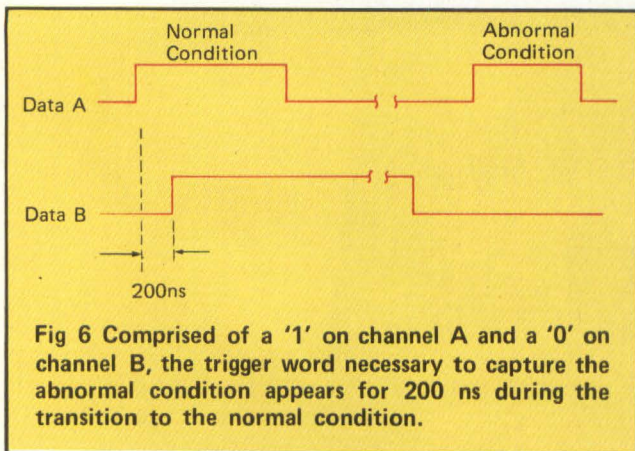

pears at the inputs, while the make false trigger responds when that word goes away. The make false triggering is often used when a change in any one of several control lines is desired as a trigger.

One major variation on the combinational trigger is the ability to trigger on events that are not being recorded. This seems to be more and more available as an adjunct to the logic analyzer, and not necessarily built into it. This approach finds favor because more often than not the desired trigger word is much wider than the data of interest. Auxiliary combination trigger boxes include all the other trigger features found in the logic analyzers themselves such as qualifiers, true/false conditioning and delay.

If you are considering the purchase of an asynchronous unit, one item to consider with some care is the ability to insert delay in the trigger. For an analyzer to capture a single or low frequency event based on a given word combination, anomalies in the data which might otherwise make up that combination must be "delayed" from or screened out of the trigger. Trigger delay is currently offered in two different manners; the first allows the insertion of up to 300ns of analog delay, while the second allows some maximum number of sample bits of delay. Fig 6

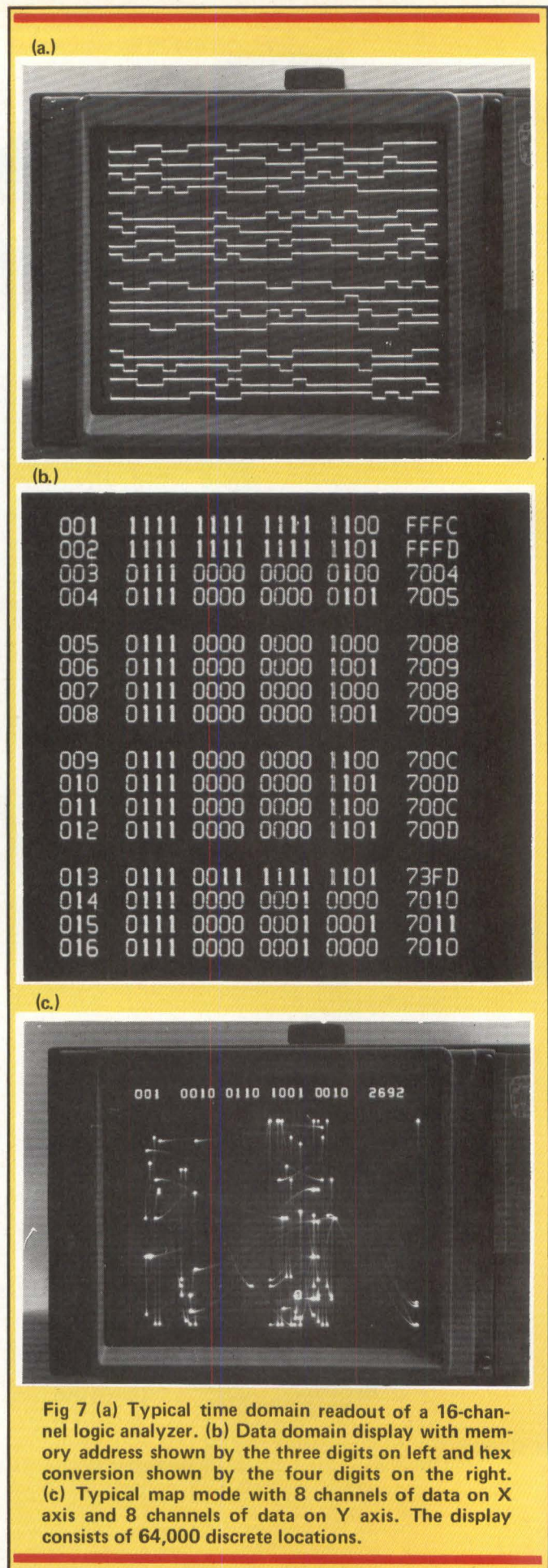

Why Toggle?

(when you can turnkey)

Power-on-start means automatic program execution when computing with the Altair™ Turnkey Models from MITS. Both highly acclaimed Altair mainframes, the 8800b and 680b, are obtainable in easy-to-implement turnkey versions—offering the same capabilities as their full front panel counterparts—and then some.

Our 8800b Turnkey Model incorporates a Module Board complete with serial I/O channel, 1K of RAM, and provisions for 1K of PROM. All 8800 hardware and software are compatible with the 8800b Turnkey Model.

In addition to the 8800b Turnkey, we are introducing these new 8800 system peripherals. The Altair 88-AD/DA converter is our eight channel analog I/O system for applications where analog to digital and digital to analog conversion is necessary. For economical mass storage, the Altair Minidisk System (88-MDS) provides a fast access storage capacity of over 71K bytes per minidiskette.

A big computer in a small package—the Altair 680b Turnkey Model—is a low cost mainframe capable of home, business and process control applications. The 680b CPU module contains all the logic circuitry needed for immediate computing plus 1K of RAM, serial I/O port and provisions for 1K of PROM.

You may expand your 680b Turnkey with these new additions to the 680b line. Load and save programs on audio cassette with the 680b-KCACR. This inexpensive mass storage device is highly reliable under widely varying conditions and requires no circuitry adjustments. Interface your 680b Turnkey to the practical world of process control with the 680b-PCI. Monitor and compensate for changes in any operation, from tracking the sun to watering the lawn.



mits

a subsidiary of Perdec Computer Corp.
2450 Alamo S.E.
Albuquerque, New Mexico 87106
(505) 243-7821

shows what happens when triggering on a microprocessor bus that has anomalies occurring on device transfer that might otherwise trigger the analyzer. Without a delay of 200ns or greater, the normal condition that occurs many more times than the abnormal condition would continually trigger the analyzer and make it virtually impossible to see what occurred at the abnormal condition. In the example shown, the analog delay would work as well as the digital

delay. You should look, however at your particular application and see if 300ns suffices for all applications. In one application discussed in the second part of this article (appearing next month), an example will be shown where 300ns of delay is not nearly enough. Digital trigger delay in an asynchronous analyzer should be considered carefully since its value in the ease and certainty of data capture rivals that of the latch mode discussed earlier.

Logic Analyzing Instruments

Manufacturer	Model No.	No. of Channels	Maximum Frequency (MHz)	Memory Format	Asynch (Internal Clock)	Latch Mode	Domain State	Timing State	Type of Display
BP Instruments	20D	8	20	8 x 256	Yes	Yes	Yes	No	Separate Scope or XY Display
	50D	8, 16 (optional)	50	8 x 512 (Dual)	Yes	Yes	Yes	Optional	Separate Scope or XY Display
Biomation	810-D	8	10	8 x 256	Yes	Yes	Yes	No	Separate Scope or XY Display
	851-D	8	50	8 x 512	Yes	Yes	Yes	Optional	Separate Scope or XY Display
	920-D	9	20	9 x 256	Yes	Yes	Yes		Separate Scope or XY Display
	1650-D	16	50	16 x 512	Yes	Yes	Yes	No	Separate Scope or XY Display
	8100-D	8	100	8 x 2048	Yes	Yes	Yes	No	Separate Scope or XY Display
	8200	8	200	8 x 2048	Yes	Yes	Yes	No	Built-in
Davco	DM 230	32	4.2, 11 (optional)	32 x 256	No	No	Yes	Yes	Separate Scope; Built-In Hex LED Display
Digital Broadcast	80-M	8	20	8 x 1024	Yes	Yes	Yes	No	Separate Scope or XY Display
Digital Labs	DSR-505	2	10	2 x 512	Yes	Yes	Yes	No	Separate Scope
E-H Research	1320	2 to 16	50	100/ channel	Yes	Yes	Yes	No	Built-In
	1330	8	20	8 x 1000	Yes	Yes	Yes	Yes	Built-In
Hewlett-Packard	1600A	16	20	16 x 16	No	No	No	Yes	Built-In
	1607-A	16	20	16 x 16	No	No	No	Yes	Separate Scope or XY Display
	1602A	16	10	16 x 64	No	No	No	Yes	Built-In LED Display
	1610A	32	10	32 x 64	No	No	No	Yes	Built-In
Paratronics	100A	8,24 (optional)	8	8 x 16	No	No	No	Yes	Separate Scope or XY Display
	150	56	no information available at press time						
Scanoptik	LC-32A	8	4	8 x 64	No	No	No	Yes	External or Built-In
Tektronix	LA 501W	up to 16	up to 100	4 x 1016 8 x 50B 16 x 254	Yes	No	Yes	No	Built-In
	7 D01	up to 16	up to 100	4 x 1016 8 x 50B 16 x 254	Yes	No	Yes	No	Built-In (Binary)
	7 D01F	up to 16	up to 100	4 x 1016 8 x 508 16 x 254	Yes	No	Yes	Yes	Built-In (Display Formats, Binary, Octal or Hexadecimal)
Vector	1625A	16	25	16 x 256	Yes	Yes	Yes	Optional	Built-In

GIVE YOUR COMPANY

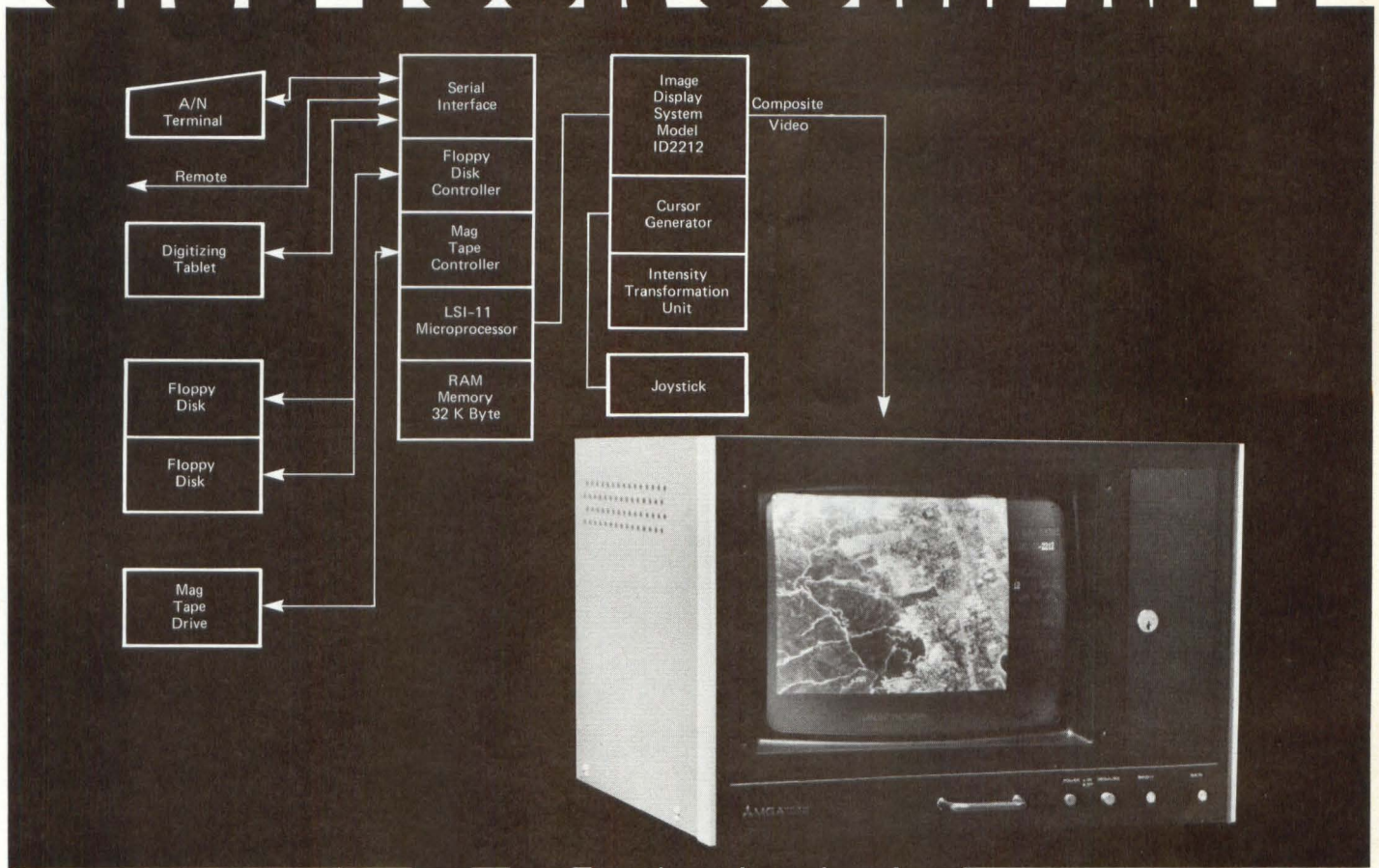

A BETTER IMAGE

Everybody can use a little image enhancement now and then. Let DeAnza Systems make the most of what you've got. Our Image Enhancement Console Model IEC 2212 is intended as a general purpose image display system particularly well suited for use as a remote terminal for processing and displaying image data which has been recorded on floppy disk or nine track tape in monochrome or color.

The model IEC 2212 Image Enhancement Console consists of a microprocessor controlled disk operating system, with two single or dual density floppy disk drives, 32 K Bytes of memory (64 K Bytes optionally), and

a keyboard terminal and interface. Optional RS 232 interfaces are available for communication with a host computer and other interactive devices such as a digitizing tablet.

Applications for the IEC 2212:

- Tomography studies
- Digital television studies
- Image feature extraction
- Earth resources data analysis
- Nuclear medicine image analysis
- Pseudo color image enhancement of any of the above applications.

De Anza Systems Incorporated

3444 De La Cruz Blvd.
Santa Clara, CA 95050 (408) 988-2656

CIRCLE 44

How Are Logic Analyzers Going to Change?

During the next two or three years, industry requirements will lead manufacturers who build logic analyzers to market 3 types of models, according to Dave Parmley, Tektronix. One model will be aimed at testing microprocessors, a second will test specialized complex devices and the third will be a more sophisticated general-purpose instrument. These three categories will fall into a new class of test and measurement equipment called logic measurement and development products.

Microprocessor analyzers will evolve in two directions: noninteractive, dedicated analyzers, and interactive analyzers, such as the Tektronix 8002 μ Processor Lab (which is already available), dedicated totally to microprocessor development.

Likewise, vendors will develop instruments dedicated to specific applications and classify them as logic analyzers. These instruments (for example, signature analyzers) will become more numerous as more industries use digital components in their systems.

A group of logic analyzers will become even more general-purpose than the general-purpose logic units on the market today, Parmley continued. The need that exists today for synchronous and asynchronous data sampling with large formattable memories will stay. As memory chip prices come down, larger logic analyzer memories will be available for markets that require high speed sampling rates or high numbers of data channels. Logic analyzers will be general-purpose enough to be used as a design tool and as a service instrument. Although the designer will continue to use logic analyzers, he will transfer troubleshooting more often to the service technician. Therefore, the designer will have to supply such data as timing diagrams and state tables in the system documentation, for the technician to compare the information with what it should be. In a similar manner, a logic analyzer with a reference memory could supply quick and easy data on the manufacturing line.

Producers of microprocessor analyzers place much emphasis on triggering. Typically, microprocessor analyzers are recorders of the synchronous type and are set up to meet the triggering needs of the microprocessor designer. The microprocessor analyzer is set up to trigger on break points in the program, at the beginning or end of loops, or at the beginning or end of a set number of loops. This latter ability is typically related to triggering on "nested loops". In choosing between a microprocessor analyzer and a logic analyzer, you should avoid the pitfall of the "mystique of the microprocessor". Often the general purpose analyzer will have all the trigger capability necessary to capture the data of interest while having far greater capability for debugging the peripheral circuitry.

Compare Memories. Many units now available contain dual or compare memories that allow the user to compare a new recording against a stored or held recording. Analyzers do

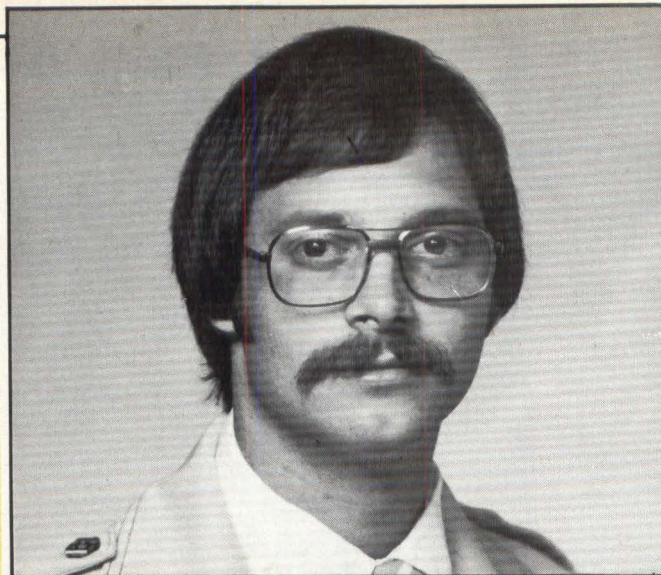

Dave Parmley, Marketing Product Specialist for Tektronix in Beaverton, Oregon.

To be useful as a service or manufacturing technician's tool, a logic analyzer must do the job without requiring extensive operator training in its use. Improved interfaces must do away with a large assortment of dials, switches and knobs to a more simplified method of selecting the logic analyzer parameters. Therefore, new logic analyzers will be smarter and more straightforward to operate; they may be programmable or preprogrammed, declared Parmley.

Logic analyzer triggering will become more sophisticated. The operator of a logic analyzer will be able to preselect the series of events that must happen before a trigger occurs. Triggering will be programmable and based on such measurements as the length of time between events happening, a number of events, software routine conditions (number of branches), and pulse width, duration, and speed.

More instruments will talk to each other through standard interfaces, such as the IEEE general-purpose interface bus (GPIB). Standard interfacing techniques will allow logic measurement and development products from more than one manufacturer to communicate directly with these instruments, predicted Dave Parmley.

this in two different ways: one method sends the output through an exclusive or, showing a 1 where the memories are different and a 0 where they are the same; the other method flashes back and forth between the two memories where the changing patterns or numbers on the screen indicate the difference. A further variation on the compare memory, halt upon non-compare mode, allows the unit to capture data, compare it against the stored data and rearm if they are the same. In this manner, captured data that differs from stored data causes the unit to go into display and show the areas where the data differs. The use for the compare memory seems obvious, yet another less obvious use seems to be generating much interest. This is where the fault condition can be captured and saved and the machine put back into recording for an attempt to capture it again. Thus the engineer doesn't have to draw out the erroneous pattern for reference.

MEMO:

TO: *All potential Microprocessor Users*
Consider the NEW Memodyne 760 Series of high-performance digital cassette recorders with your micro processor (or your mini-computer or terminal)

Model 764
(Shown)

HIGH PERFORMANCE DIGITAL CASSETTE RECORDERS

FEATURES

HIGH SPEED Up to 32 kilobits per second. Searches forward and reverse at 100 inches per second.

FAST RESPONSE 200 millisecond start-stop-settle time.

RUGGED AND RELIABLE Only 2 moving parts. • MTBF > 10,000 hours. Soft error rate of 1 in 10^7 .

LARGE CAPACITY Up to 1600 flux changes per inch or 5 million bits per standard Philips cassette.

VERSATILITY Accurate speed, very low skew and ANSI/ECMA compatibility permits use of all popular encoding schemes.

STATUS INDICATIONS BOT/EOT hole and leader sensor, Cassette-In-Place, File Protect and Busy/Ready.



DESCRIPTION

The Memodyne 760 Series of cassette recorders are compact, removable medium, storage devices for digital information. Their two track and high density capability provide up to 5 million bits of storage on a single standard Philips cassette. In their standard configuration they are capable of storing or retrieving data at a rate of 16 kilobits per second per track. A patented reel-to-reel constant tape speed servo (U.S. Patent Office #3,733,529) coupled with precision tape guid-

ance allows implementation of any of the popular encoding schemes with low error rates, minimal tape wear, and high tape utilization. The simplicity of the transport mechanism and the use of conservatively rated, high quality parts give high reliability and maintenance-free operation. Three of these compact units can be fit on a single 5" x 19" standard panel. The enclosed cassette chamber holds the cassette firmly, resisting vibration while shielding the cassette from airborne contaminants.

SPECIFICATIONS

Status Signals:

Cassette-In-Place, File Protect, B/EOT, Busy/Ready — TTL Compatible.

Control Signals:

Run/Stop, Forward/Reverse, Slow/Fast — TTL Compatible.

READ AND WRITE PERFORMANCE (Read-While-Write)

Gap Spacing:

.150, \pm .005 inch.

Dynamic Skew:

\pm 100 microinches max.

Recording Density:

To 1600 flux reversals per inch nominal.

Transition Spacing:

Down to 625 microinches nominal.

Read and Write Rate:

Up to 32,000 transitions per second.

TAPE MOTION

Tape Speed:

20 inches per second,
100 inches per second,

Start Time to \pm 5% of 20 Inches Per Second:
75 milliseconds.

Start Distance to \pm 5% of 20 Inches Per Second:
1.00 to 1.25 inch.

Start Distance to \pm 5% of 100 Inches Per Second:
500 milliseconds maximum.

Stop and Settle Time:
150 millisecond recommended minimum.

ERROR RATES

Soft errors: 1 in 10^7 is easily obtainable in typical applications.

Priced \$300. and up in OEM Quantities F.O.B. Newton, Mass.
Write for latest Memodyne Product Catalog

Memodyne
CORPORATION

385 ELLIOT STREET, NEWTON UPPER FALLS, MA 02164
TELEPHONE (617) 527-6600-TELEX 922537

CIRCLE 45

Manufacturers' Guide to Logic Analyzers

All the manufacturers listed below market some form of logic analyzer; Biomation, Hewlett-Packard, Systron Donner and Tektronix also make analyzers designed specifically for use with microprocessors. Contact them directly or use the circle number on one of our reader service cards.

BP Instruments, Inc.
10601 De Anza Blvd.
Cupertino, CA 95014
(408) 446-4322

Circle 189

Biomation Corp.
10411 Bubb Rd.
Cupertino, CA 95014
(408) 255-9500

Circle 190

Davco Mfg. Co.
169 Ridgedale Ave.
Morristown, NJ 07960
(201) 267-4990

Circle 191

Digital Broadcast Sys.
Box 381
Madison, AL 35758
(205) 837-2183

Circle 192

Digital Laboratories
600 Pleasant St.
Watertown, MA 02172
(617) 924-1680

Circle 193

E-H Research Labs.
515 11th St.
Oakland, CA 94607
(415) 834-3030

Circle 194

Hewlett-Packard
Garden of the Gods Rd.
Colorado Springs, CO
80907
(303) 598-1900

Circle 195

Paratronix, Inc.
150 Tait Ave.
Los Gatos, CA 95030
(408) 354-7766

Circle 196

Scanoptik
P.O. Box 1745
Rockville, MD 20850
(301) 977-9660

Circle 197

Systron-Donner Corp.
10 Systron Dr.
Concord, CA 94518
(415) 676-5000

Circle 198

Tektronix, Inc.
Box 500
Beaverton, OR 97077
(503) 644-0161

Circle 199

Vector Associates
685 Station Rd.
Bellport, NY 11713
(516) 286-9000

Circle 200

Data Output. The most popular method for outputting the data is via an oscilloscope or CRT-type display. The two major categories of displays fall into what is termed the timing domain and the data domain. In the timing domain display, data is written across the scope in a pseudo waveform representing a timing diagram of the captured data. Enhancement of this mode can include a marker at the trigger and a movable cursor marker around which the data can be expanded. Further, readouts are available that give the distance and sample bits between the two markers.

The data domain display exhibits data on the oscilloscope or XY display in a truth table-type format — the data is shown in both binary form and a user-chosen converted form. The converted data can be shown in hex, octal or decimal coding. The data domain display, although derived from exactly the same data as the timing diagram display, finds favor with the microprocessor designer.

In summary, we take a memory and some method of stopping and starting a recording and add a way to visualize what is in the memory and we then have a logic analyzer: a very simple device used to capture data related to a specific event or set of events. In Part II (appearing next month), we will explore some actual field experiences and applications where the microprocessor or logic analyzer was used to solve a particular problem.

Logic Analyzers: Untangling the Terminology

Do you know the difference between a logic state analyzer and a logic timing analyzer? Many systems designers don't, and the extent of their confusion has increased steadily during the last four years, says Bruce Farley, a product marketing manager for Hewlett-Packard's Colorado Springs, CO, division.

Farley blames much of the problem on the logic analyzer manufacturers themselves, who he admits have not always used the terms "logic state analyzer" and "logic timing analyzer" as accurately as they should have in characterizing their products.

To help clarify some of the muddled terminology, Farley recently visited Boston where he enumerated what he feels are some of the main differences between these two types of testing instruments. Speaking during a demonstration of the Colorado division's two latest logic state analyzers — the models 1610 and 1602 — Farley explained that the phrase "logic analyzer" is a generic term and can refer to either a logic state analyzer or a logic timing analyzer. Whether an instrument qualifies as a state or a timing device depends primarily on the type of clock it uses. A logic state analyzer has an external, synchronous clock; a logic timing analyzer, an internal clock, he says.

Depending on the type of clock, a logic analyzer performs one of two basic kinds of tests. With its synchronous timing device, a state analyzer traces the flow of electrical signals through a digital system's data bus. A timing analyzer, on the other hand, examines sequences of multi-channel or asynchronous events like handshaking, erase conditions or glitches, Farley explains.

More specifically, designers performing state analysis try to answer questions like the following:

- During tests, did a piece of digital equipment produce the sequence of electronic events predicted by the designers' algorithms?
- If not, in what respects did the observed output differ from the expected results?

In timing analysis, by contrast, typical questions asked by systems designers include the following:

- Did two or more events occur when they were supposed to?
- Did one event trigger a second event within the time limit specified by the designers?

Because of the type of data they sample, timing analyzers usually have no more than eight channels. If the number of channels were much higher, systems designers probably could not reliably interpret their test results, Farley explains.

Intelligent Terminals

The Ontel OP-1 series...
User programmable...
Flexible, Versatile,
Reliable...Modular
structure...Up to 64K of
memory...Designed
for field upgrade of
features...Cluster or
stand-alone configura-
tions...Up to three

microprocessors...
Easily programmed...
Full range of communica-
tions controllers and
peripheral interfaces...

Ontel terminals...your
best hardware buy for
the money.

That's intelligent

and Common Sense

Ontel software
packages...
Comprehensive...
Designed for today's
needs...
Includes
an extensive set
of utilities...
Word processing...
Text editing...
Forms generation...

Two high level lan-
guages...
Communication
emulators...
Diagnostics...
And more.

Ontel terminals...your
best software buy for
the money.

**That's common
sense**

Ontel

Ontel terminals...tops
in reliability and
software...Priced to be
competitive and
affordable.

**And that's the
right price**

Edward J. Heinze
National Sales Manager
Ontel Corporation
250 Crossways Park Drive
Woodbury, NY 11797

(516) 364-2121



CIRCLE 46

LOGIC ANALYZERS: WHAT YOU CAN BUY

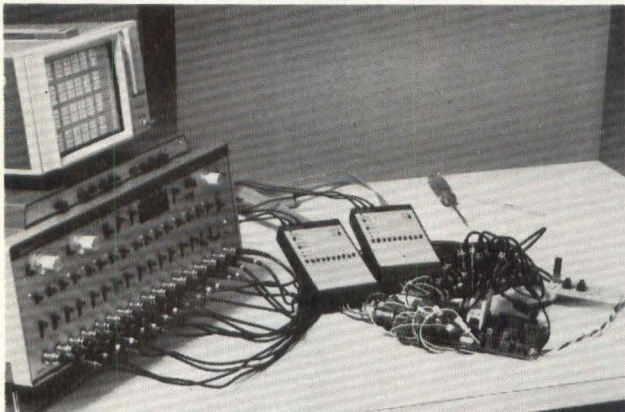

Biomation 1650-D

Biomation's Model 1650-D logic analyzer, combined with a 116 display control unit, a 10-TC probe pod and a 10X probe set, can detect and analyze malfunctions in many microprocessor systems. Even though the design team has assembled and verified the software for the microprocessor system on a development unit, problems can occur. By observing program flaws in the system under test, the instrument detects and analyzes failures.

Circle 179

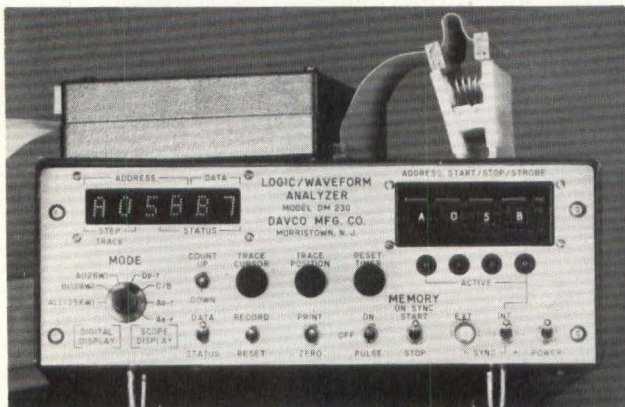

Davco DM 230

The DM 230 waveform analyzer from Davco Manufacturing turns a standard single-channel oscilloscope into a 32-channel measuring tool for detecting marginal or defective ICs and system software in computing systems. A fast memory option increases throughput rate from 4.2 to 11 MHz and an optional RS-232 interface allows the user to connect a video terminal to the analyzer.

Circle 180

Hewlett-Packard 1602-A

About the same size as an average briefcase, Hewlett-Packard's Model 1602-A weighs 10 pounds. Equipped with an F8 microprocessor and a 16 bit wide by 64 word deep memory, it can capture 64 events — 63 words following, preceding or surrounding the event designated as trigger. It automatically

tests itself every time every time it's turned on and through its keyboard, it interacts with its user by pointing the way through every operation. The manufacturer offers an op-



tional programming capability via the HP interface bus; this capability makes the analyzer entirely programmable and able to dump, on command, its 64-word memory store on-to the bus for analysis by the controlling computer.

Circle 183



Digital Broadcast Systems 80-M

Memory of the Model 80-M logic analyzer, marketed by Digital Broadcast Systems, stores a 1K-bit record of digital waveforms under test. The unit continuously monitors and records data on up to 8 input lines at user-selected sampling rates. When the 8-bit word recognizer detects the proper event, the system stops recording after a delay period, which determines the trigger position. This mode of operation can capture any false data condition programmable into the word recognizer.

Circle 181

(Continued on page 77)

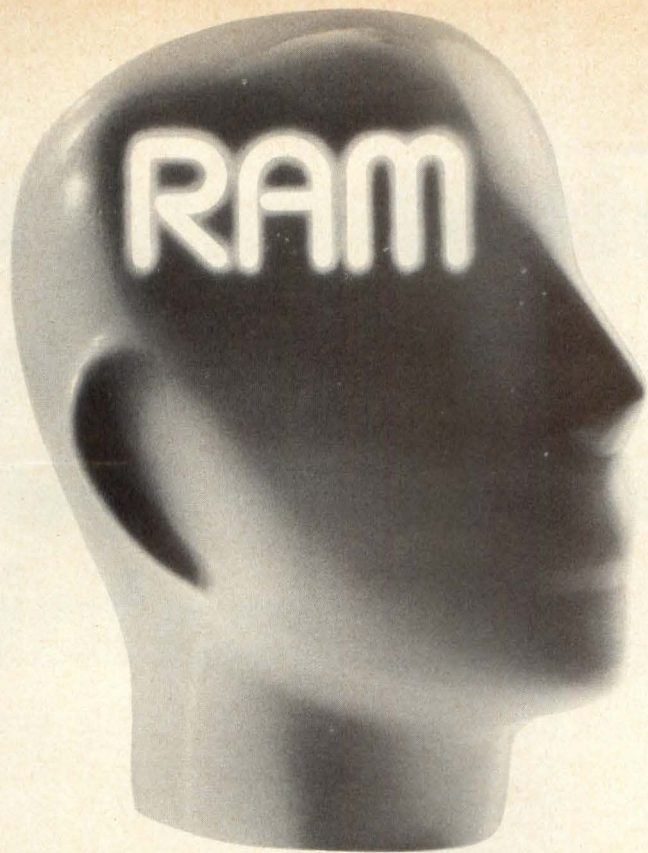

LOOK!!
 we've added to the family
 fold here

There are only 2 types of memory. yours and ours.

Ours is the **16K SPACE BYTE**

A fully static, state of the art RAM

\$599. Fully assembled,
 burned in and tested

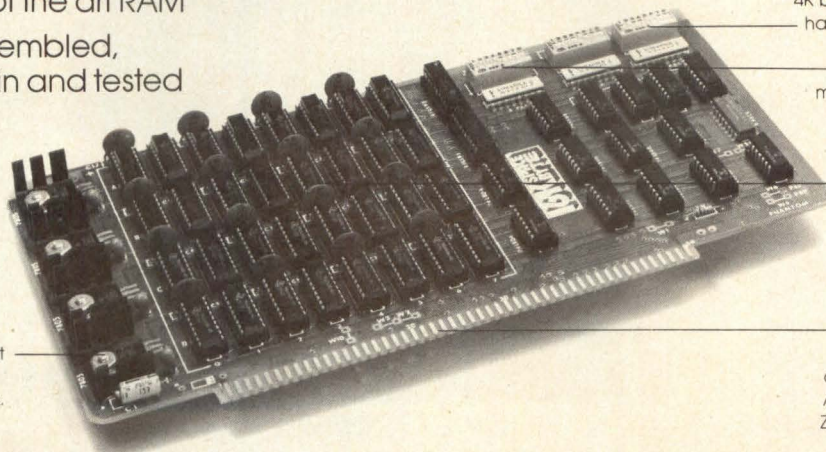

Addressable in 4K blocks at any 4K border by dip switch... as if you had 4 individual 4K static boards

Memory write protect and memory disable (phantom) are controllable in 4K blocks by dip switch

The state of the art TMS-4044 (4K by 1 bit) fully static RAM by Texas Instruments

The all popular S100 bus...
 The 16K SPACE BYTE is fully compatible with the VECTOR 1, ALTAIR, SOL-20, IMSAI, POLY-88, Z-80, COMPAL-80, and AM-100 (DMA DISK)

Single +8 volt power requirement
 4 independent 7805 voltage regulators, one for each 4K block.
 Typical worst case power dissipation is less than 2 amps

CIRCLE 47

Introducing the **SPACE 8085** **BYTE**™ A self-contained

Two RS-232C serial I/O ports—
a CRT in one and a printer in the
other with software selectable
baud rates

Fully buffered parallel I/O ports
interface directly with the ICOM®
FD 3700 or Frugal Floppy disk
systems

The state of the art INTEL®
8085 CPU is 50% faster than the
8080A. It operates at 3MHz, using
450 ns memory and is fully
compatible with all existing 8080
software

Complete 3K system monitor with
2708* EPROMs including
extensive de-bugging, fdos,
tarbell and video driver routines.
*Jumper selectable for use with
2716 EPROMs for up to 6K of on
board system monitor

The all popular S100 bus...

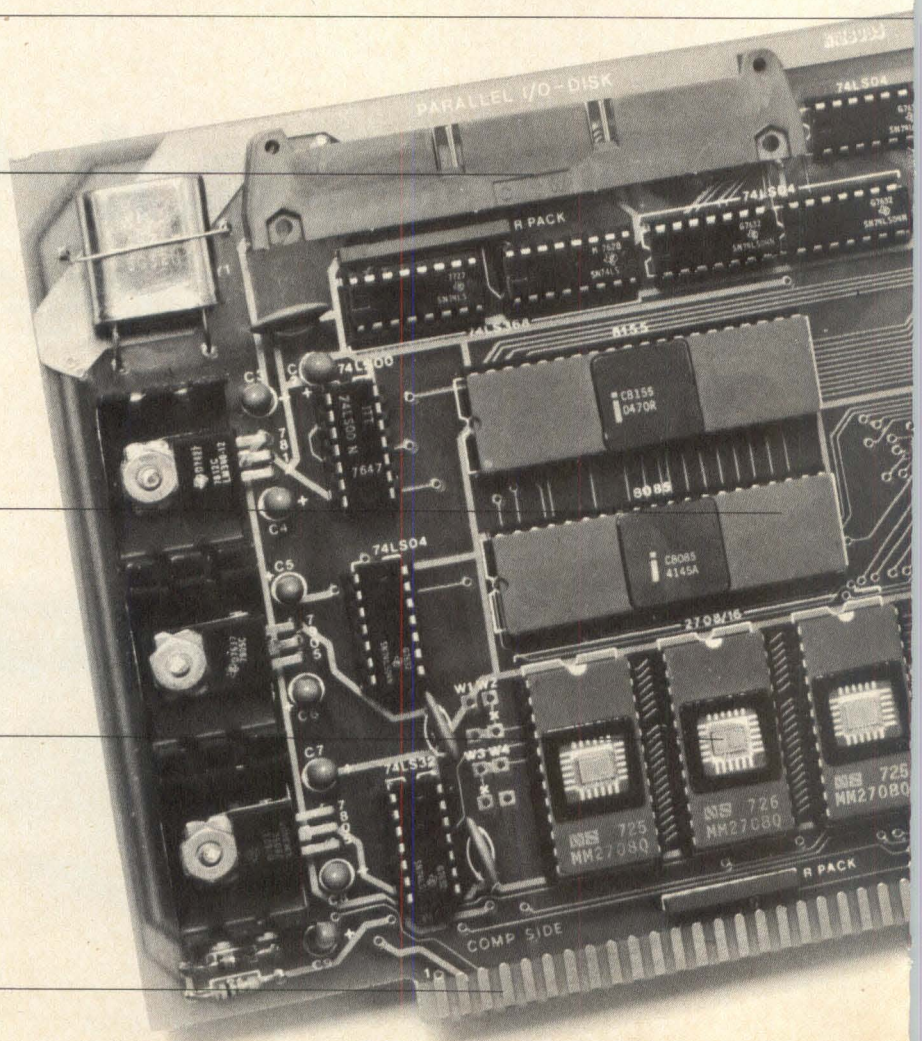

the 5CPU ed computer

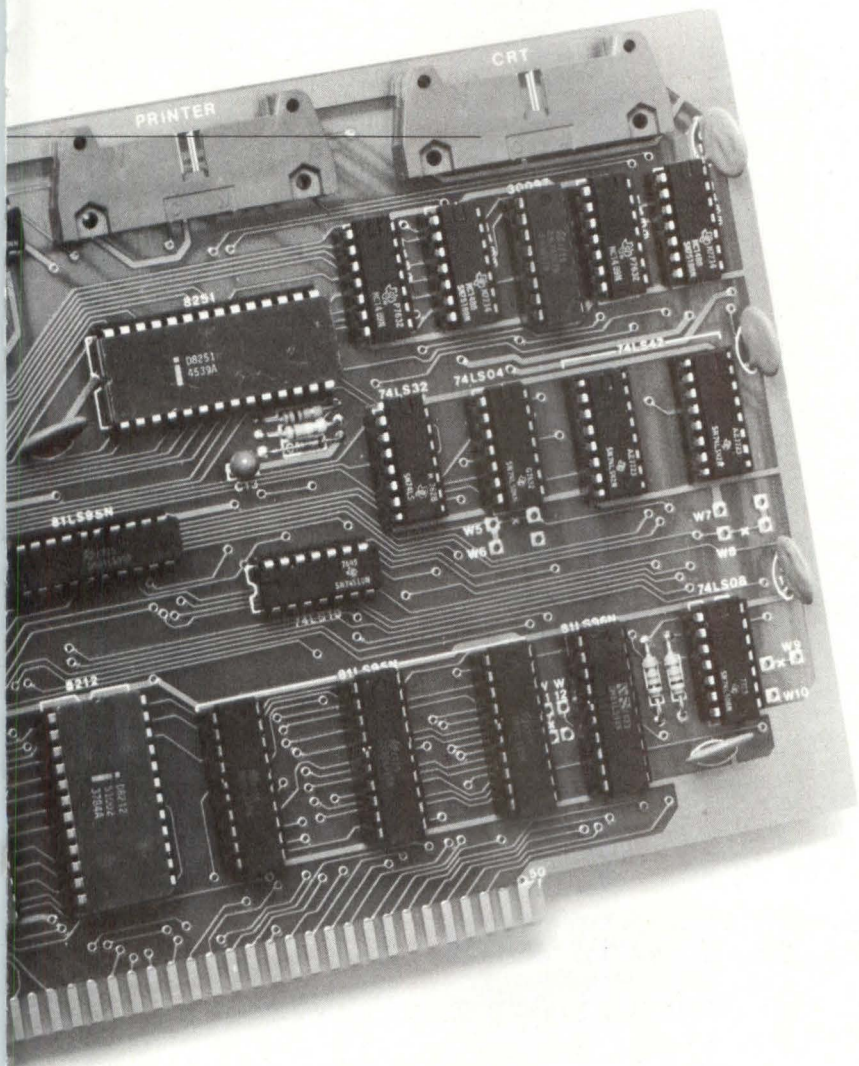
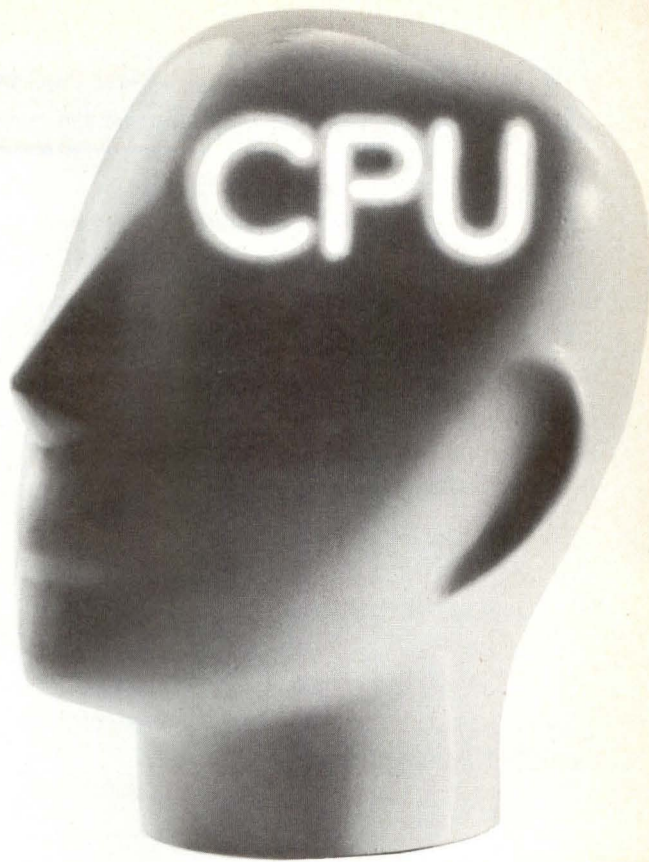

Other features include:
256 bytes of RAM
4 vectored interrupts
programmable 14 bit binary timer/counter
optional 2708/2716 EPROM PROGRAMMER
complete dedicated system controller capability
(see back page)

\$499.

end user quantity one.
fully assembled, burned in and tested.
OEM, retailer and distribution margins available

CIRCLE 49

The SPACE BYTE 8085 CPU- As the dedicated controller with its own software development system*

Applications for dedicated system controllers are virtually limitless. The SPACE BYTE 8085 CPU is a complete dedicated system controller because it has full I/O capability, 256 bytes of RAM, 14 bit binary interval timer/counter, 3MHz operational speed and the capacity for 3K or 6K of on board application firmware.

Additionally, the SPACE BYTE 8085 CPU will serve as the heart of its own software development system when installed in a S-100 type mainframe. With the optional SPACE BYTE 2708/2716 EPROM PROGRAMMER, application firmware can be developed and tested on the very device for which it was conceived.

By inserting programmed EPROMS in the sockets on board the SPACE BYTE 8085 CPU, the dedicated controller can now be tested "as itself," while still installed in the S-100 mainframe.

The SPACE BYTE 8085 CPU and increments of 16K SPACE BYTE fully static memory offer perhaps the most innovative, versatile and cost effective software development system in the industry.

**The SPACE BYTE 8085 is:
a self contained computer
a software development system
a dedicated controller**

*A complete software development system requires in addition to the SPACE BYTE 8085 CPU: RAM (such as the 16K SPACE BYTE), an EPROM programmer (such as the SPACE BYTE 2708/2716 EPROM PROGRAMMER), floppy disk system, CRT, line printer, and mainframe.



THE SPACE BYTE CORPORATION

1720 Pontius Ave. Suite 201 Los Angeles, California 90025 (213) 468-8080

SPACE BYTE microcomputer products are now available at computer retailers everywhere.

All specifications and information provided without warranty expressed or implied and subject to change without notice.

© The Space Byte Corporation 1977. All rights reserved.

CIRCLE 50

Logic Analyzers: What You Can Buy

(Continued from page 72)



Systron-Donner 50

Usable with all microprocessor families with an accessible bus structure, Systron-Donner's Model 50 analyzer provides three modes of delays: single or multiple machine cycle, instruction or loop cycle and combinations of both. Clock rate is 4 MHz; instruction cycles may include up to 8 machine cycles. In addition to displaying the address and first byte of an instruction fetch, the instrument can independently strobe and display 7 more machine cycles of data

Circle 187

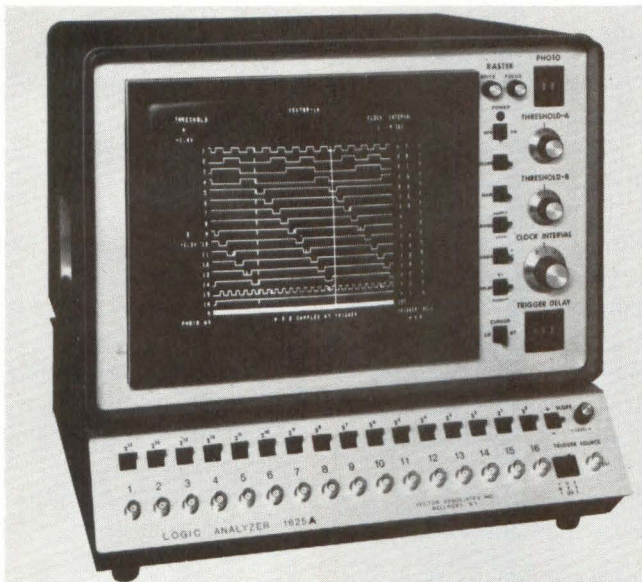

Vector Associates 1625A

Displaying 16 channels of input data when triggered by a second set of 16 inputs (address data), Model 1625A logic analyzer from Vector Associates can detect failures in most microprocessor models. The instrument includes a 12" CRT, switch register/comparator, trigger delay generator readout of all front switch positions and the 1 and 0 readouts of all data at the cursor position. Cursor operator control permits the user to look forward and backward in time in chosen increments of 0 to 255.

Circle 185

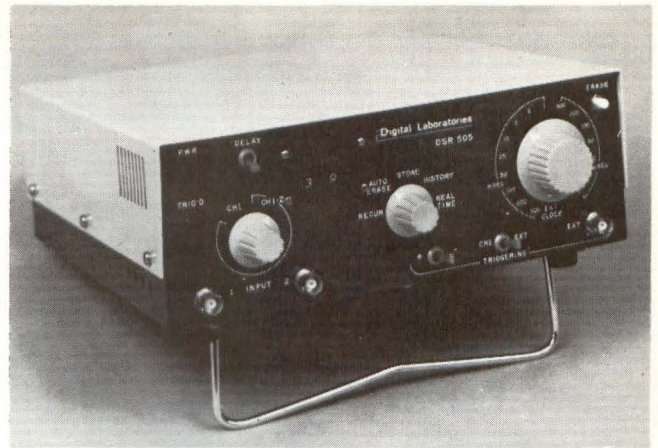

Digital Laboratories DR-505

Hardware troubleshooting DR-505 digital signal recorder, manufactured by Digital Laboratories, provides pretrigger viewing, uses standard 10:1 probes, stretches glitches, indicates when signal is between logic thresholds and stores 512 samples per channel.

Circle 186

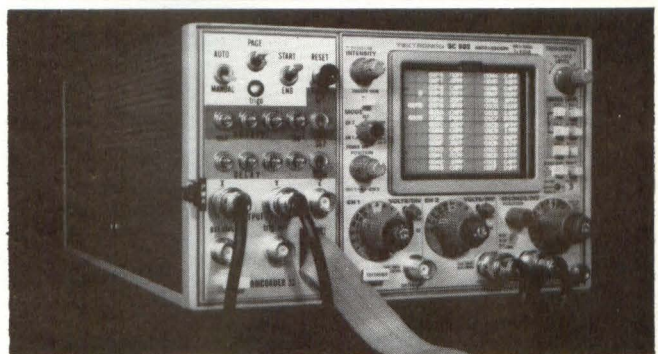

Scanoptik LC-320

The LC-320 Instrument Package from Scanoptik combines the power of a 32-channel by 64 word logic state analyzer with a two channel, 15 MHz oscilloscope. Front panel switches set a 16-bit trigger address. When the logic state of the synchronous address bus agrees with the present trigger address, the analyzer will store the next 64 states of both the address and data busses. The analyzer then displays this 64X32-bit word block into a 64X8-digit hexadecimal block.

Circle 188

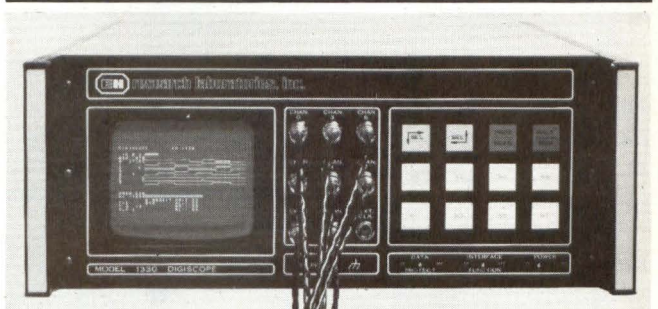

E-H 1330

Intended for developing, testing and maintaining digital circuits and systems, E-H 1330 Series logic analyzers do pre-trigger, simultaneous multichannel and transient recording. Each logic analyzer provides alphanumeric readouts of all instrument settings on its CRT.

Circle 182

FIELD SERVICING MICROPROCESSOR- BASED SYSTEMS

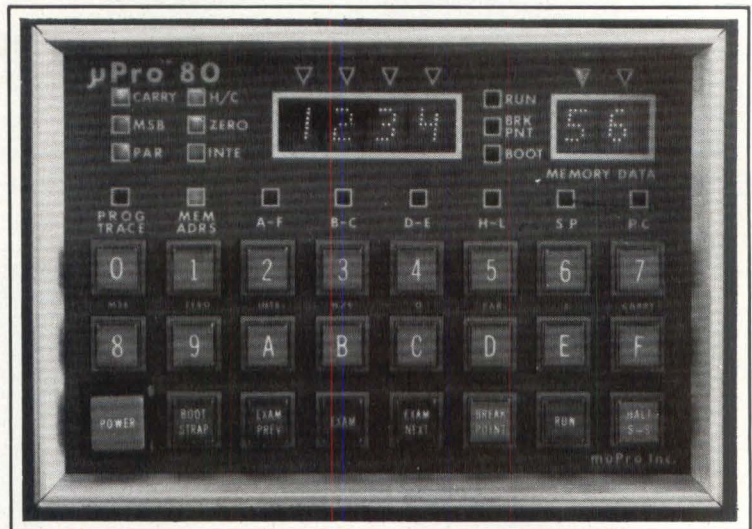

As a designer of microprocessor-based systems, you must address the problem of field servicing your products. Systems built around microprocessors present unique field service problems, problems so complex that they consume excessive engineering time, eroding corporate profits. In the past, engineers solved these problems by designing special purpose devices to use with an array of test equipment such as portable oscilloscopes, portable voltmeters and portable signal generators. But with microprocessor-based systems, problems requiring more sophisticated field service equipment occur, forcing the evolution of a new generation of test equipment. This in turn brings on a proliferation of new test concepts, procedures and documentation to support the equipment.

During the initial installation of newly-developed microprocessor-based systems, servicing centers around locating design problems. The early period in the life of a product requires major debugging efforts by the hardware designers and software engineers. When a field failure occurs, it may not be apparent whether a hardware design error, software bug or something totally outside of the system caused the problem. Also, whenever there is an in-field product upgrading, similar problems occur. After the initial hardware and software bugs are eliminated, hardware failures cause most field problems; however, some problems arise due to external system modification that the hardware

or software can't handle. Also, system software may need changes to compensate for hardware limitations discovered after initial system installation.

The problems and constraints discussed above have several things in common, according to James B. Moon and Brent C. Olson of MuPro Inc., including:

Cost. The test equipment should cost as little as possible and get the system operational as quickly as possible.

Portability. Service personnel should be able to easily carry the unit under their arms or aboard an airplane.

Easy to interface. The test equipment should interface quickly and easily to the system being tested.

Rugged. Test equipment must survive fairly rough handling in the field.

Transparent. The test equipment you use should not introduce additional variables into the system being tested.

Identifying the Problem

Moon and Olson point out that with most installations, hardware and software engineers troubleshoot the new system. These engineers must understand the conceptual design of the system and its method of operation; test gear must be flexible and powerful.

The test equipment must control and exercise the user's system; this capability should include the ability to change memory contents. If the system memory is PROM or ROM, individuals handling the troubleshooting probably prefer to first use the test equipment to find the problem and then program a new PROM to solve the problem. Moon and Olson

The front panel (above) of muPro's 80-E emulator provides total control of the 8080-based system under test.

If you're designing equipment that requires a numeric or alphanumeric printer here's an opportunity to upgrade capabilities, increase reliability, and maybe even cut costs, too.

"Spanning Hammers" Reduce Parts, Raise Reliability
Our innovative microprinters have only about one third the number of parts you'll find in conventional single hammer per column printers. Ours are simpler, so they're more reliable. Each spanning hammer forms the characters for three columns, therefore, only five hammers are required to print all fifteen columns.

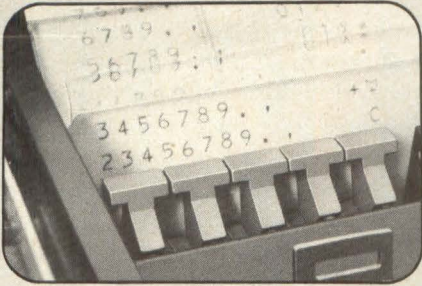

Full 54 Character Printing In All Columns Our special bar matrix character formation permits printing of A-Z, 0-9, and eighteen symbols in all columns at speeds at up to 90 lines/minute.

More Good News Users of your equipment will like our easy-handling snap-in ribbon cartridges, the economy of printing on inexpensive plain paper, and the flexibility of being able to make multiple impressions when the need arises. In addition, there are also optional ticket and ticket/tape mechanisms available.



```

DEFGHIJK
EFGHIJKL
FGHIJKLM
GHIJKLMN
:/012345
/0123456
0123456
123456
    
```

And you'll like the fact that our printers are made right here in the U.S.A. So your design and engineering people can have easy access to our design and engineering people.

Let's Exchange Print-Outs
Send us a sample of your present printout and we'll send you a copy of ours. Plus, we'll send you full details on our series PR 1500 printer. Sheldon-Sodeco, 4 Westchester Plaza, Elmsford, N.Y. 10523; Phone (914) 592-4400. *in 100's
SHELDON-SODECO
A COMPANY OF

LANDIS & GYR

**NOW... A FULL
ALPHANUMERIC,
15-COLUMN
IMPACT PRINTER...
FOR LESS
THAN
\$110.00***



SPECIAL OFFER
Thru Jan. 1, 1978
15-column alphanumeric printer
with control electronics for
ASCII/BCD input.
Only \$295.
You save \$106.

**The Most Versatile System Available
For Controlling Position, Velocity
And Acceleration!**

NEW...

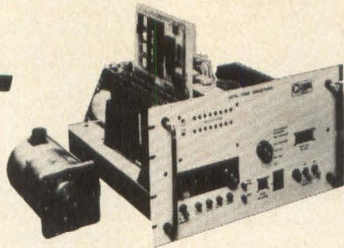

**Torque Systems' New Microprocessor
Digital Servo Control System!**

- * Programmable for Position, Velocity and Acceleration!
- * Generates smooth vector with "Phase Lock" speed control
- * Performs critical "In Progress" functions without reprogramming!

Easily Reprogrammed — optimum efficiency!

The versatile Torque Microprocessor Digital Servo Control System has applications wherever acceleration, velocity and position must be accurately controlled! It's compatible with Torque's full range of amplifiers and drive systems.

For further information contact: **TORQUE SYSTEMS, Inc.**,
P.O. Box 588, 225 Crescent Street, Waltham, MA 02154,
(617) 891-0230, Telex 92-3424



"Torque Systems, When You Demand Reliable Performance"

CIRCLE 52

**One small Accuflo®
roll keeps
a ribbon
inked for life.**



An Accuflo roll holds a generous supply of ink in large, internal pores — meters it out gradually through fine surface pores to the ribbon.

Adding ink with an Accuflo roll maintains print intensity for the life of the ribbon. You get darker characters up to four times as long as with conventional ribbons. Accuflo adds lubricity as it adds ink, so your whole system lasts longer. And if you need specially formulated inks, you can take advantage of our 17 years of experience in ink technology.

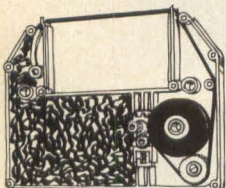

Improve your system with an Accuflo ink roll. Or let us manufacture a ribbon cartridge just for your requirements — complete with an Accuflo ink roll.

Write for your free
Accuflo Design Guide.

PORELON, INC.

Racine, Wisconsin 53403

Accuflo is a trademark.

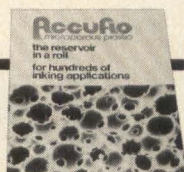

CIRCLE 53

say that if the test equipment has the capability of programming a PROM, this feature alone could pay for the equipment if it eliminates a second field service trip. The test equipment must also control the user's system to force it to operate in those ways that isolate the problem and locate a convenient, easy solution. Also, the test equipment must display all the necessary information to indicate the type and nature of the problem.

The test equipment should have the capability to function as a completely passive monitor, rendering no effect on the user's system while monitoring. However, it should be capable of assuming control of the system when conditions dictate.

After initial installation and debugging, field service technicians take over; test equipment must allow full-capability operation by these personnel. Equipment so complex that it looks like a pinball machine crossed with a porcupine becomes useless in the hands of these technicians who usually have only a basic knowledge of electronics and system operation. Therefore, test equipment should clearly indicate proper system operation to aid in quickly separating true problems from customer errors.

Chances are the field service technician is not the original hardware and/or software design engineer; he thus needs test flow charts, diagrams or structured test procedures and test equipment that is easy to use. The technician must be able to select test programs, modify constants and observe memory location contents.

Today's options. A quick look at some of the current field service methods and techniques shows how they measure up to the tasks of field service of microprocessor-based systems. Moon and Olson point out problems with several methods that have been used previously.

Logic signature testing works well while running a fixed test sequence of instructions for hard-wired logic or microprocessor systems. However, typical microprocessor-based systems require an exact means of duplicating the sequence of instructions used in the working model to compare to the signatures. Scope testing works for a small subset of the system, but is generally not viable due to the rapidly escalating amount of information on the display required as the problems become more complex. This technique does find use in conjunction with other test equipment, and allows you to effect looping and repetitive displays of simple signals.

Logic analyzers play a key role in initial hardware analysis and debug. They can observe sequences of events which occur only rarely, and which therefore must be captured and stored; some analyzers generate time domain, data domain, state diagrams or assembly language mnemonic representations of the events observed. All logic analyzers present in some form a "snapshot" of the system operation, although Moon and Olson claim that none of them provide the ability to observe or manipulate the CPU register contents or memory contents. They also say that logic analyzers do not provide the ability to readily modify the program itself, should a software problem need to be corrected.

Other methods that Moon and Olson feel have little use for field servicing include parametric testing and subsystem swapping. Parametric testing results require interpretation by personnel more skilled than most field service technicians;

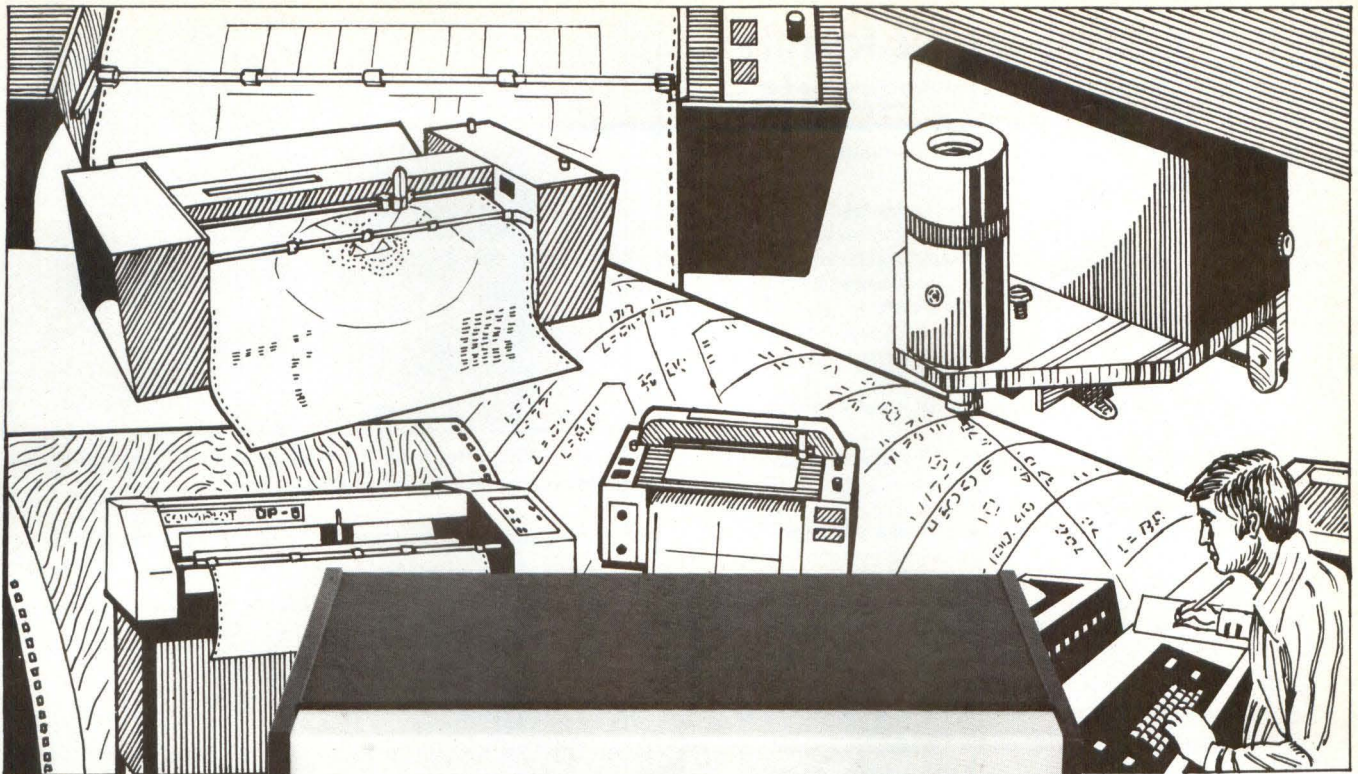

Two Models
PTC 5A-1
 \$1945 *
 and
PTC-5A-3
 \$2595 *

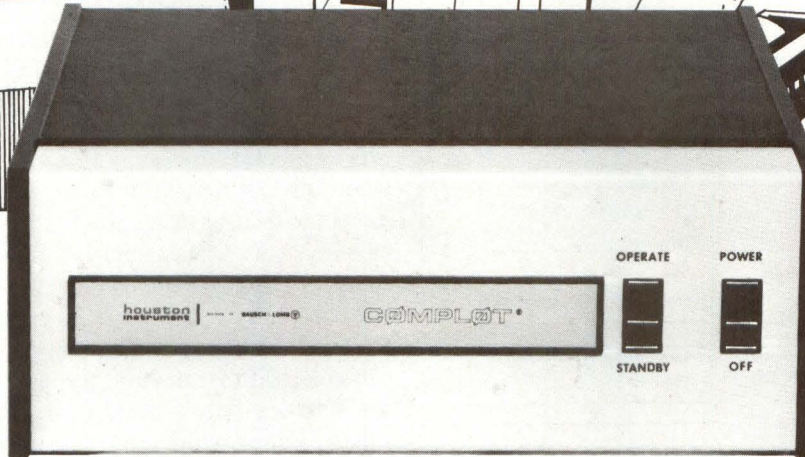

the new
COMPLØT®
PTC-5
 Remote
 Time Share
 Digital Plotter
 Controller

MICROPROCESSOR CONTROLLED PLOTTING

New Features:

- ✓ 16 special centered symbols (in addition to the standard character set)
- ✓ Circle generation capability
- ✓ Enhanced vector length
- ✓ Will work with offline tape cassette

Call Rod Schaffner at (512) 837-2820

Tried and Proven Features:

- ✓ Totally interruptable without loss of origin
- ✓ Hardware character vector generation
- ✓ Error detection/retransmission
- ✓ 196 or 1024 character buffer
- ✓ Operates at 110,300 and 1200 baud
- ✓ Use with IBM 5100 calculator, Wang 2200 series and others listed in the brochure

**houston
 instrument**

**THE
 RECORDER
 COMPANY**

DIVISION OF BAUSCH & LOMB

ONE HOUSTON SQUARE (at 8500 Cameron Road) AUSTIN, TEXAS 78753
 (512) 837-2820 TWX 910-874-2022 cable HOINCO
 TELECOPIER

EUROPEAN OFFICE: Rochesterlaan 6 8240 Gistel Belgium
 Phone 059/277445 Telex Bausch 813

*U.S. Domestic Price Only

®A registered trademark of
 Houston Instrument

CIRCLE 54

The fabulous **Phi-Deck**[®] family of 5 cassette transports under \$100 in quantities of 10

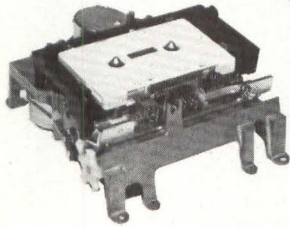

- Featuring:
- Die-cast frames
 - Remote controllable
 - Precise, fast head engage/disengage
 - Quick braking
 - Search FF/rewind 120 ips
 - Speed ranges from .4 to 20 ips

Electronic packages and mag heads for most applications

For application in:

- | | |
|-----------------------------------|---------------------------------------|
| 1. Micro processing | 7. Security/automatic warning systems |
| 2. Data recording/logging/storage | 8. Test applications |
| 3. Programming | 9. Audio visual/education |
| 4. Instrumentation | 10. Telephone interconnect |
| 5. Industrial Control | 11. Hi-Fi |
| 6. RS-232 Data storage | 12. Point of sale |



Title I Incorporated
4605 N. Stiles P.O. Box 18209
Oklahoma City, Oklahoma 73118 (405) 521-9000

- I am interested in application no. _____
 Have Representative call Send application notes

Name _____ Title _____
Company Name _____
Address _____
City _____ State _____ Zip _____
Phone Number _____

CIRCLE 55

AMS Presents . . .
"THE PROBLEM SOLVER"

The AMS Model 704 GPIB/HPIB Interface is a multi-channel data acquisition and instrument control device. Designed for use in programmable instrumentation systems, the Model 704 conforms to the IEEE 488-1975 STD. used by Tektronix Model 4051, Hewlett-Packard Models 9825 and 9830, and Wang Model 2200 small computers.

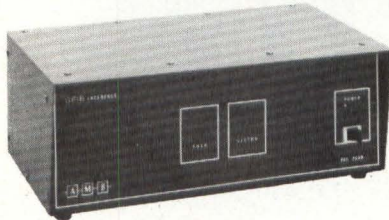

AMS produces the Model 704 Analog and Digital Interface with features including;

- 8 Channel Digitizer, combined with digital inputs and outputs.
- Controls instruments from IEEE Bus.
- Puts measured analog and digital data on the IEEE 488 Bus.
- Upgrades existing instruments that are not IEEE 488 compatible.
- Eliminates custom interfaces.

System Problems? . . . AMS also offers the best in system and design consultation.

The model 704 is priced at \$2750.00



The Systems Solvers

P.O. Box 873
Lake Elmo, MN 55042 (612) 770-1007

CIRCLE 56

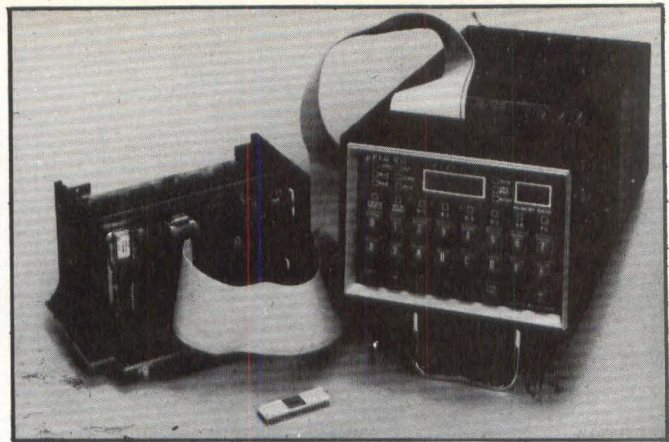

To use the 80-E, after removing the 8080 chip the user inserts a 40 pin cable header into the vacant 8080 socket.

subsystem swapping, commonly used after initial installation, enjoys limited success during the early stages of system life due to its high cost and the limited availability of swappable subsystems. Size, complexity and features of the overall system can also affect the swapping technique.

The Alternative

Moon and Olson point to a new class of test equipment that solves the field-servicing problem, particularly for 8080-based systems. One example of this type of device is the in-circuit emulator, which combines such features as versatility and portability with a RAM, a control and display panel and the necessary emulator circuitry. MuPro's 80-E, an in-circuit emulator that ties into the circuit under test, replacing the 8080 and fully controlling the system, allows true real-time operation without introducing extraneous wait states. The technician may change programs at will without constantly programming and reprogramming PROMs. Recent advances allow it to function as the nucleus of a multi-user, multi-task floppy disk development system; using this capability with system software can significantly speed program development.

As we are all aware, a rapid proliferation of microprocessor based systems is taking place throughout the industry. Field service personnel must tackle problems they have not seen before.

To address these problems, many organizations use traditional and time-worn field service techniques and equipment. However, as the installed base increases and new generations of systems appear, the techniques and equipment of the past grow unwieldy and cost prohibitive. Thus Moon and Olson say that management must now examine significantly different field service techniques to reduce repair time and costs. They must also examine test equipment designed specifically for microcomputers like the 8080.

The test equipment and procedures they implement must be versatile, compact, portable, rugged, easy-to-operate and relatively inexpensive. Portable in-circuit emulators such as the 80-E represent a new generation of test equipment that permits the timely, easy and economical repair of microprocessor-based systems.

DD

For more information about MuPro's 80-E in-circuit emulator, circle number 178.

Start your own revolution



with a personal computer

Dramatic developments in computer technology have made it possible for you to *completely reorganize* and *improve* the ways you manage your personal and business life.

Today, for as little as \$600, you can buy a complete computer system about the size of a typewriter. These new computers are called *personal* computers. They are every bit as powerful as yesterday's room-sized computers that cost millions of dollars.

A personal computer can be your *equalizer* in dealing with our complicated society. You'll have the same organizing, calculating, and information storage **POWER** that was previously only in the hands of large institutions. You can have a computer to deal with *their* computers.

As a reader of **PERSONAL COMPUTING** magazine, you'll be in the heart of the

computer revolution. We'll show you how to use your own computer for business and home management—for education, income tax preparation, research, text editing, environmental control, art, games, recipe files, budgeting, inventory control and hundreds of other applications.

PERSONAL COMPUTING is a consumer magazine that makes computers more *understandable* and *useable*. Our readers include businessmen, teachers, accountants, doctors, lawyers, engineers, programmers, and scientists.

Each issue of **PERSONAL COMPUTING** brings you page-upon-page of useful information and colorful, people oriented articles. Subscribe now so you can be a part of this new revolution.

Please start my subscription to **Personal Computing**

Name _____

Address _____

City _____ State _____ Zip _____

USA

- 1 year (12 issues) \$14
- 2 years (24 issues) \$26
- 3 years (36 issues) \$38

Charge my: Master Charge Bank Americard
 Account # _____
 Card expiration date _____

- Bill me
- Check enclosed (you'll receive one extra issue for each year!)
 please allow two months for processing.

Additional Postage per year:

- Canada & Mexico \$ 4.00 surface
 \$ 8.00 air
- Other foreign \$ 8.00 surface
 \$36.00 air

Please remit in US funds — Thank you

MAIL TO: PERSONAL COMPUTING, 167 COREY ROAD, BROOKLINE, MASS. 02146.

Is your computer smart enough

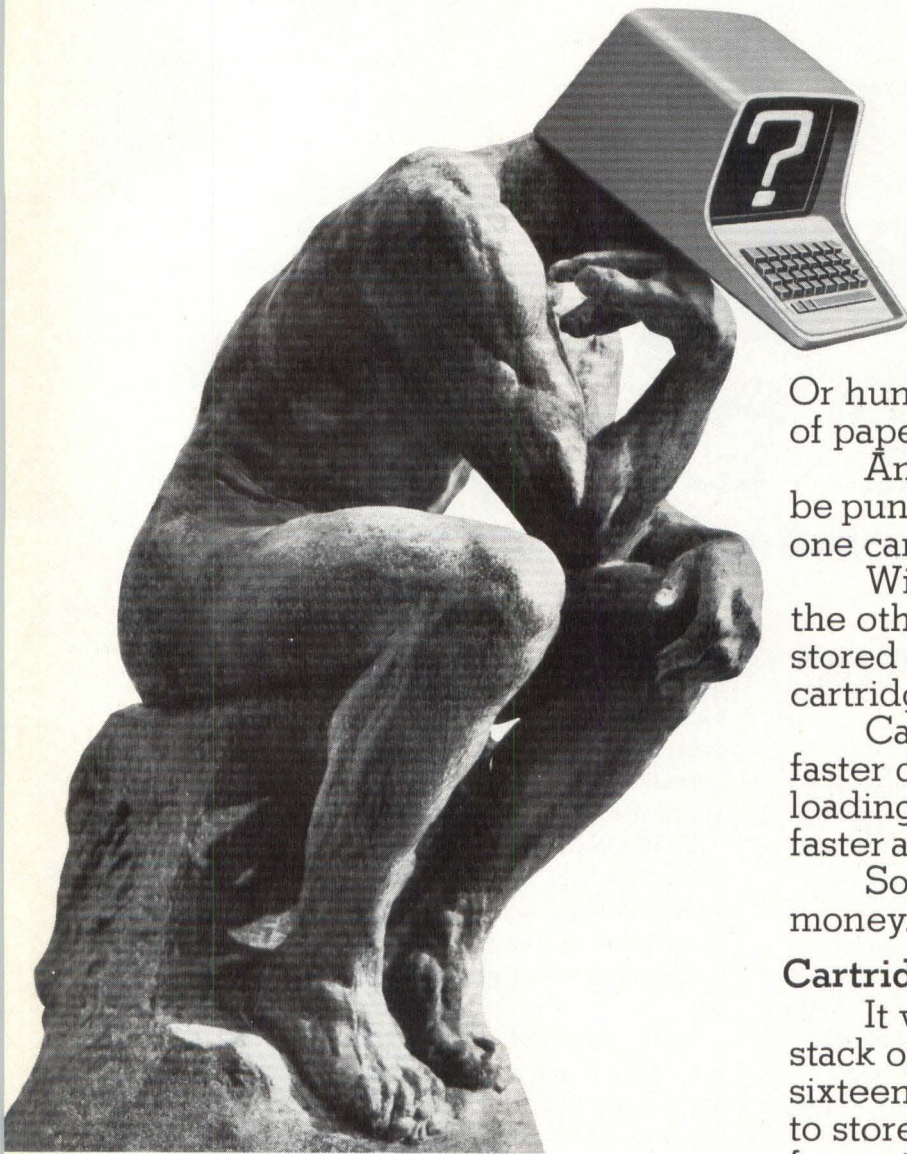

One DC-300A cartridge equals almost 16 feet of cards.

Or hundreds of feet of paper tape.

And each program must be punched, verified and read one card at a time.

With our drive system, on the other hand, programs are stored on a single tape cartridge.

Cartridges offer much faster data storage, program loading, data transfer and faster access to the computer.

So you save time and money.

Cartridges take less space.

It would take a stack of cards almost sixteen feet high to store all the information you can store on a single 3MDC-300A data cartridge.

With cartridges, you can store all of your programs in a fraction of the space you'd need for cards or paper tape.

Your filing system is simplified and overhead is greatly reduced.

Cartridges won't fold, spindle or mutilate.

Unlike paper cards, you never touch the media. It's well

A 3M peripheral drive which uses 3M data cartridges is better than any drive which uses punched cards or paper tape.

And, if you'd take the time to ask it, your computer would probably tell you so.

It's simple logic.

Cartridges are faster than cards.

Cards and paper tape are slow. It takes hundreds of cards for a single computer program.

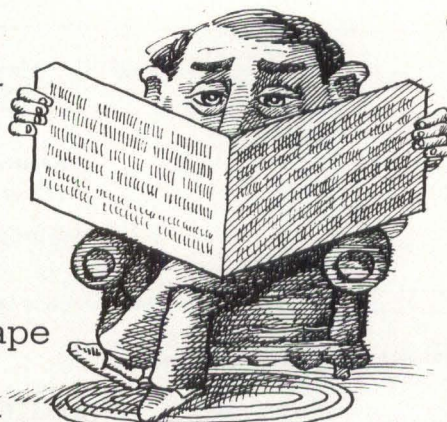

Cards must be read one at a time.

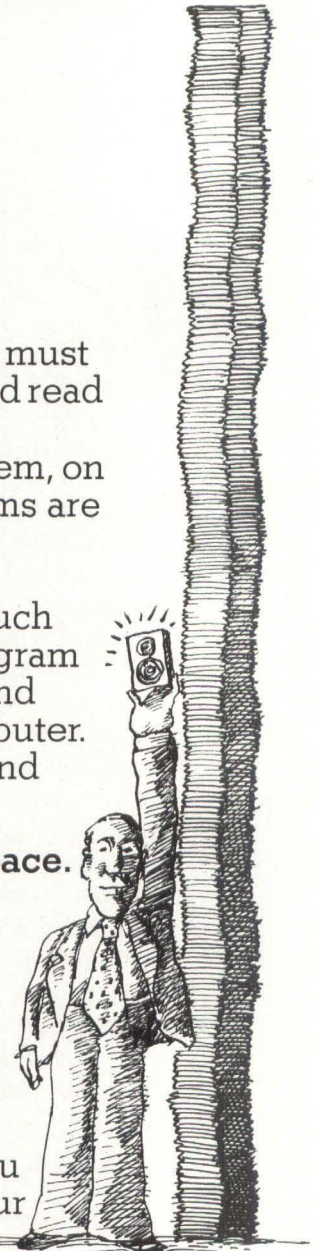

to choose our cartridge drive?

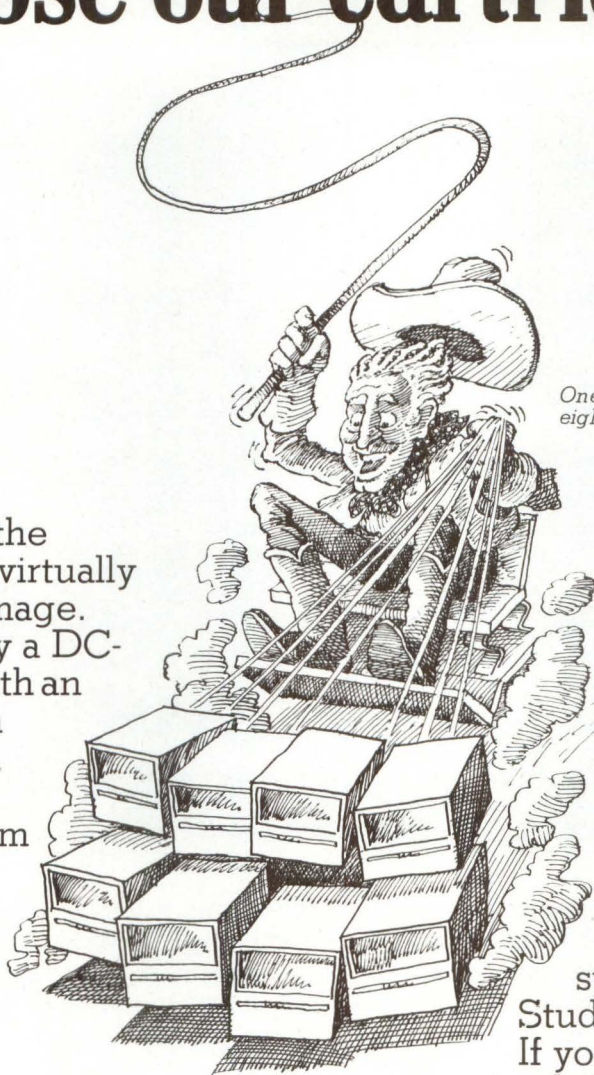

One formatter can control eight drives at once.

protected inside the cartridges, so it's virtually impossible to damage.

You can carry a DC-100A cartridge with an entire program in your shirt pocket.

Even if you drop it, the program will survive unscathed.

Remember that the next time you drop a stack of cards.

Don't take our word for it. Ask your computer.

If you'll send us the coupon, we'll send you the specifications for all three of our drive systems.

Ask your computer to compare them with any other type of drive system.

We'll bet your computer will prefer ours.

Maybe it'll choose our famous DCD-3 drive. It's people-proof, jam-proof and wear-resistant.

Or maybe your computer will decide upon our DCS-3000 series, an ANSI-formatted system that allows one formatter to control up to eight drives.

The DCS-3000 is extremely easy to integrate into your system. Only one cable to the user's logic is required.

But if you require compact size, your computer will probably choose our

unique DCD-1. It offers many of the features of our bigger systems, yet it will fit inside a five-inch cube.

The cartridge alone measures just 2.4 x 3.2 x .5 inches.

See for yourself.

Send us the coupon. There's much more we can tell you about our drive systems.

Study the information carefully. If your computer isn't smart enough to choose our drive systems, we'll bet you will be.

Send me more information.

Name Title

Firm Address

City State

Zip

Phone

3M
COMPANY

Mail to: 3M Company
Data Products, Dept. 125
Mincom Division, Bldg. 223-5F
3M Center
St. Paul, Minnesota 55101





Photo courtesy of American Microsystems, Inc.

This month we complete our state-of-the-art and patent activity analysis reporting on computer memory technology. In May we covered magnetic bubble memories; in June we covered cassette, cartridge and diskette drives; July included a patent report on floppy disks; and in August, we covered charge coupled devices, core, semiconductor, CRT, and optical memories. This article discusses mag-optical, holographic, superconductive, ferroelectric, plated wire, planar film and domain tip propagation.

COMPUTER MEMORY TECHNOLOGY: PART II

magneto-optical memories

Magneto-optical memories optically record on or retrieve information from magnetic films by modulating the films' physical characteristics. Generally, laser beams store digital information one bit at a time on the magneto-optical medium. The information is read by sensing the magnetic field induced change in the polarization of the laser light. The physical modulating mechanisms applied on magnetic films include: thermo-magnetostrictive recording, Curie point writing, compensation temper-

ature writing, temperature dependent coercivity, Kerr effect and Faraday effect.

Patent Activity

Recent patent activity has been directed to the reading and writing of data in magnetic domains by the action of a laser beam on a magnetic film. Patents issued since May 1974 include:

3,949,387 – Beam Addressable Film Using Amorphous Magnetic Material (Chaudhari et al, IBM Corporation) – This patent discloses a beam addressable file that uses

INTEL DELIVERS FOUR NEW BESTSELLERS.

Intel's newest microcomputers, memory components and memory systems give your products the edge in a competitive world. Now, to help you get those products to market sooner, easier and more economically, Intel

delivers four important new books: MCS-48™ User's Manual, MCS-85™ User's Manual, 1977 Intel Memory Design Handbook and the 1977 Intel Data Catalog. Get your hands on copies of your own today.



1. MCS-48™ User's Manual
304 pages
Intel delivers the world's best supported single chip microcomputer, the 8048—and the user's manual that helps you take full advantage of it. Provides an overview of the complete MCS-48 system, including the companion 8748 and 8035 cpu's, data sheets, instruction sets, application notes and specs on the full family of compatible peripherals.

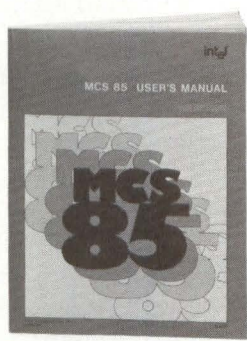

2. MCS-85™ User's Manual
288 pages
We designed our new 8085 to give you a high performance microcomputer with a built-in head start—bus and software compatibility with the industry standard 8080. User's manual details MCS-85 system operation, data sheets and application notes, plus specs on compatible peripherals and standard memories.

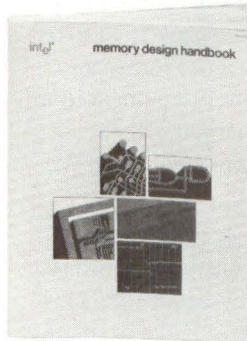

3. 1977 Intel Memory Design Handbook 288 pages
For the facts on efficient memory system design, come to the source: Intel. We're the pioneers and leading suppliers of semiconductor memory. Our new design handbook is the definitive compendium of memory applications. Covers system design using RAMs, PROM/ROMs, CCD and memory support circuits. Includes actual PC board layouts for many applications.



4. 1977 Intel Data Catalog
928 pages
Here are 928 pages detailing what Intel delivers. Complete electrical specs on 286 Intel memory components, systems and support circuits, microcomputer systems, peripherals and development aids. Includes data sheets and comprehensive information on our MCS4/40, MCS 48, MCS 80/85 and Series 3000 microcomputer families. Provides an index of available software and workshop programs.

	Qty.		Total	Name/Title
1	<input type="checkbox"/>	@\$5.00	\$	_____
2	<input type="checkbox"/>	@\$5.00	\$	Company _____
3	<input type="checkbox"/>	@\$5.00	\$	Address _____
4	<input type="checkbox"/>	@\$2.50	\$	City/State/Zip _____
				Bill my Mastercharge <input type="checkbox"/> BankAmericard/VISA <input type="checkbox"/>
Amount enclosed, check or money order. \$ _____				Card Number _____ Exp. date _____
P.O. okay on orders over \$100.				Signature _____
Write for quantity prices.				
Intel Corporation /Literature Department, 3065 Bowers Avenue, Santa Clara, California 95051.				DD intel delivers.

Table 1 Distribution of Magneto-Optical Memory Patents

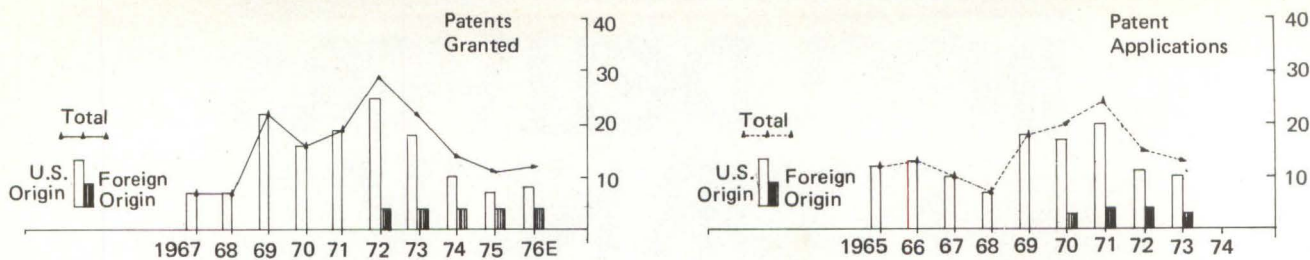

	By Patent Grant Date										Total	By Patent Application Filing Date										Total
	1967	68	69	70	71	72	73	74	75	76E		67-76E	1965	66	67	68	69	70	71	72	73	
Total Patents	7	7	22	16	19	29	22	14	11	12	159	12	13	10	7	18	20	24	15	13	132	
United States	7	7	22	16	19	25	18	10	7	8	139	12	13	10	7	18	17	20	11	10	118	
Total Foreign						4	4	4	4	4	20					3	4	4	3		14	
Germany						3					2					3					3	
Netherlands								3			3								2	1	3	
France								2			4							2			2	
Finland										2	2											
United Kingdom							1	1			2							1	1		2	
Japan								1		1	2								1	1	2	
Italy										1	1									1	1	
Canada						1					1							1			1	

an amorphous magnetic composition having uniaxial anisotropy as a storage medium. Either light beams or electron beams can be used to write information into the storage medium with Curie point or compensation point methods. It is asserted that this method will extend the ambient temperature range of the film due to the stability of the composition.

3,947,890 – Magneto-Optical Readout Apparatus (Travot et al, Eastman Kodak Co.) – Discloses apparatus for retrieving magnetically recorded information by Kerr or Faraday effects. The magnetic recording is irradiated by a beam of coherent light whose plane of polarization is periodically varied. The transmitted or reflected light from the recorded medium is then analyzed for changes in polarization.

3,944,992 – Magneto-Optical Information Storage Device Using Photoconductive Control Element (Krumme et al, U.S. Phillips Corp.) – Discloses a device for magneto-optic memories including a storage plate of magnetizable material and a light beam for recording and retrieving information in the plate. A photoconductive layer on the storage plate is activated by the light beam and is controlled by electrodes provided thereon via a current or voltage source.

3,899,780 – Magnetic Bubble Store Having Optical Centering Apparatus (Ojala, U.S. Phillips Corp.) – Discloses a storage system including a plate of magnetic material in which digital information can be stored in the form of domains. The domains are written and read by means of electromagnetic radiation generated by a highly coherent light source which can be modulated. The domains are maintained by a constant magnetic field, which is generated by a permanent magnetic layer.

3,836,895 – Opto-Magnetic Memory (De Jonge, U.S. Phillips Corp.) – Discloses the storage of data by cylindrical magnetic domains in a plate of ferric material having an easy axis of magnetization extending normal to the plane of the plate and a compensation temperature for magnetization. The size of the magnetic domains is varied by their selective

heating with a laser light source to indicate the presence or absence of data. Faster writing speeds are asserted.

3,824,570 – Magneto-Optical Transducer Using Bubble Domains (De Bot, U.S. Phillips Corp.) – Discloses a device for converting image information into magnetic information including a light source for projecting the image onto a plate of magnetic material capable of accommodating domains. A domain pattern is produced as the result of thermal action of the incident light. A magnetic domain displacement plate is provided for reading purposes.

3,815,151 – Optical Memory With Readout Beam Anneal (Schmit, Honeywell Inc.) – Discloses optical storage of information by Curie point writing on manganese bismuth film which has multiple temperature dependent crystallographic phases. Readout is obtained by laser beam heating of the magnetized area to a temperature which removes quench crystallographic phases, yet is below the normal phase Curie temperature. The magneto-optic effect of the magnetized area rotates the polarization of the laser light in relation to the stored data. An improved readout signal-to-noise ratio is asserted.

3,810,131 – Devices Employing The Interaction Of Laser Light With Magnetic Domains (Ashkin et al, Bell Telephone Laboratories Inc.) – Discloses bubble and strip magnetic domains that are thermally nucleated, annihilated, captured or moved by an incident laser beam of variable power without the use of outside connections, conductor loops or magnetic elements. The laser beam is directed at the domains in a low coercivity, magnetically isotropic, single crystal of orthoferrites and ferrimagnetic garnets for heating to above the Curie point within the crystal's thermal time constant. A large storage capacity and high operating speeds are asserted.

holographic memories

Holographic memory systems record data by illuminating a photosensitive material simultaneously with two beams of

Table 2 Distribution of Holographic Memory Patents

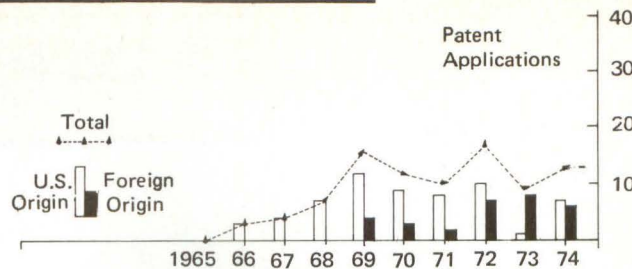
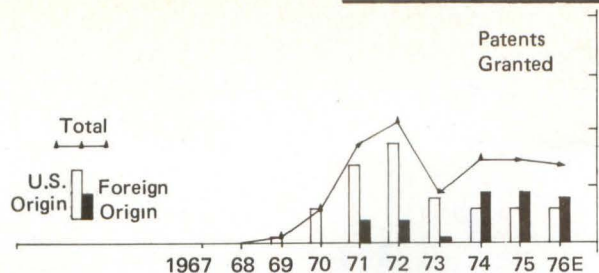

	By Patent Grant Date										Total 67-76E	By Patent Application Filing Date									Total 65-74
	1967	68	69	70	71	72	73	74	75	76E		1965	66	67	68	69	70	71	72	73	
Total Patents			1	6	18	22	9	15	15	14	100		3	4	7	16	12	10	17	9	78
United States			1	6	14	18	8	6	6	6	65		3	4	7	12	9	8	10	1	54
Total Foreign					4	4	1	9	9	8	35				4	3	2	7	8	8	24
Japan					2	1	1	4	7	2	17				2	1	1	4	3		11
Germany						1		4	2	2	9						1	2	4		7
France							1		1		6				1			1	1		3
United Kingdom					2	1					3				1	2					3

coherent light; one beam illuminates an object plane and carries the data for recording, the other constitutes a reference beam. Plural individual holograms are stored on each photosensitive memory medium, each hologram representing a different data bit pattern or "page." To read out a page, a laser beam selectively illuminates a stored hologram thereby projecting a real image of the bit pattern onto a matrix of photodetectors which convert the light into electronic signals.

Recent Activity

Recent emphasis has been on optical systems for reading and writing hologram memories. Patents issued since May 1975 include:

3,964,032 – Optical System For Storing Information (Bardos, Harris Corp.) – Discloses a wideband holographic information storage system which records Fourier holograms on film in rapid succession, each hologram storing 128 bits of data. The holograms are successively recorded in adjacent positions across a photosensitive film by scanning a light beam wide enough to cover two facets of a rotating polygonal scanning mirror.

3,959,784 – High Speed Optical Read-Out Of Data Stored In An Array (Meier, Actron) – Discloses an optical system which illuminates successive frames of holographic data with light of different wavelengths and then images the data on successive photodetector arrays. The color of light being used for illumination determines which array the image of the frame is formed on.

3,946,370 – Method Of Making Light-Dot Distribution For The Holographic Storage Of Binary Information With The Aid Of Electronically Controlled Switching Masks (Schmidt et al, U.S. Phillips Corp.) – Discloses a method of making light data distributions for the holographic storage of binary information through the use of an electronic switching mask. The mask has its individual elements modulated in their path length through fading of the interference structure of the hologram to transmit a constant quantity of light independent of the information distribution.

3,936,139 – Holographic Memory Providing Both Angular And Translational Reference Beam Deflections (Huignard et al, Thomson-CSF) – Discloses an optical system for storage and retrieval of data using a hologram incorporating

two light deviating devices. One device enables selection of an elementary area of the storage medium while the second device allows superimposed holograms to be stored within the elementary area.

3,924,924 – Holographic Memory Utilizing A Changeable Phase Object and Coherent Subtraction (Fukuhara, Hitachi Ltd.) – Discloses a holographic recorder which uses a pattern generator to reduce the hologram's dependency upon the incident angle of irradiated light. The pattern generator comprises plural biaxial, birefringent, irregular, ferroelectric crystals with mutually opposing planes normal to any one of the a-, b-, or c-axes and having a thickness of a half-wave plate. The crystals are arranged as a matrix on a plane perpendicular to incident light and are modulated by a threshold voltage applied to their Z-planes to phase modulate the information pattern onto a photosensitive medium and form a hologram.

3,891,976 – Hologram Memory With Sequential Data Storage and Beam Angular Relationship (Carlsen, GTE Laboratories, Inc.) – Discloses an optical data beam and an optical reference beam passed through deflectors to intersect and form holograms at the recording medium. Each data bit is recorded with a distinct angular relationship between the intersection data and reference beams. These relationships are used to identify the position of each data bit.

3,833,893 – Holographic Memory Including Corner Reflectors (Rajchman, RCA Corp.) – Discloses a holographic storage medium in which lenses are eliminated and corner reflectors are used. A laser beam is deflected to an illumination hologram to illuminate an array of controllable corner reflectors to represent binary data.

3,883,216 – Holographic Memory Having Spherical Recording Medium (Lee, Honewell, Inc.) – Discloses a holographic memory in which a constant angle is maintained between the object beam and the reference beam at the memory medium. The object and reference beams are each pivoted about respective pivot points and the memory medium has a spherically curved surface, with multiple data storage locations.

superconductive memories

Superconductive memory devices employ as the memory element an electric current in a loop of material cooled be-

Table 3 Distribution of Superconductive Memory Patents

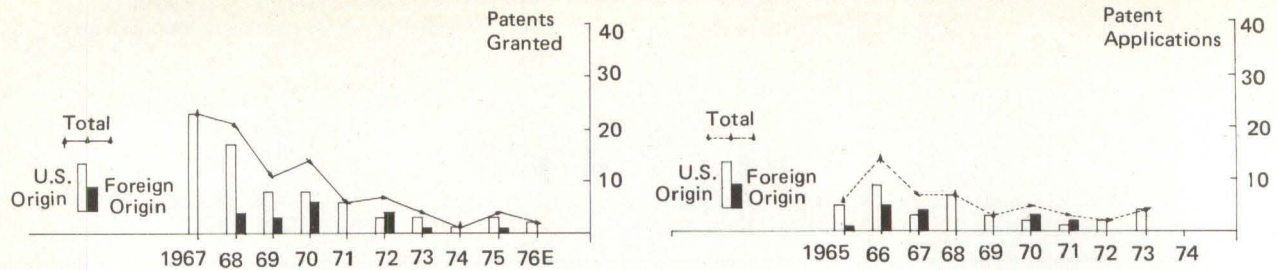

	By Patent Grant Date										Total 67-76E	By Patent Application Filing Date										Total 65-73
	1967	68	69	70	71	72	73	74	75	76E		1965	66	67	68	69	70	71	72	73		
Total Patents	23	21	11	14	6	7	4	1	4	2	93	6	14	7	7	3	5	3	2	4	51	
United States	23	17	8	8	6	3	3	1	3	2	74	5	9	3	7	3	2	1	2	4	36	
Total Foreign		4	3	6		4	1		1		19	1	5	4		3	2				15	
France		1	2	2		2					7		3	1		1	1				6	
Germany			1	2		1	1				5		1	2		1	1				5	
United Kingdom		3									3	1									1	
Netherlands						1					1					1					1	
Japan					1						1		1								1	
Switzerland									1		1										1	
Italy				1							1		1								1	

low its critical point. The material has the property of losing all electrical resistance when so cooled so that the electric current persists indefinitely with no measurable attenuation. Included are Josephson junction memories consisting of one or more Josephson junctions connected in a superconducting loop. These memories exhibit extremely fast switching speed and high density.

Patent Activity

Recent patent activity has focused on using Josephson junctions in memory devices with emphasis on material and structural features. Patents issued since February 1972 include:

3,936,809 – Single Flux Quantum Storage Devices and Sensing Means Therefor (Zappe, IBM Corp.) – Discloses a single Josephson tunnelling device made with two superconductive materials spaced apart by an insulator. The Josephson current density profile is characterized by a larger magnitude at the boundary portions than at the center. A sensing arrangement is also described.

3,916,391 – Josephson Junction Memory Using Vortex Modes (Gueret, IBM Corp.) – Discloses a memory array of Josephson junctions arranged in rows and columns of a matrix. The junction parameters are chosen so that the junctions, while remaining in their superconductive state, can assume either of two vortex modes in which, respectively, no flux quanta or a certain number of flux quanta can be trapped within the junction.

3,825,906 – Superconductive Shift Register Utilizing Josephson Tunnelling Devices (Hamel et al, IBM Corp.) – Discloses a two phase superconductive shift register using Josephson tunnelling devices. Included are a plurality of shift register stages energized from a DC current source wherein each stage contains a first and second branch circuit in parallel. A Josephson tunnelling device is located in each branch.

3,705,393 – Superconducting Memory Array Using Weak Links (Anacker et al, IBM Corp.) – Discloses memory cells containing superconductive rings capable of supporting Jo-

sephson tunnelling current. Coincident currents are used to trap flux in the rings and to release the trapped flux for read-out of the memory cells.

3,691,539 – Superconductive Device for Electronic Storage of Large Quantities of Data Using Magnetic Particles (Erben et al, Messerschmitt-Bolkow-Blohm GmbH) – Discloses a three layered storage element made up of an insulating film sandwiched between two superconductive layers with magnetic particles applied to the upper superconductive layer. An electron beam is used to reorient the particles for storage purposes.

3,646,528 – Self-Searching Memory Utilizing Improved Memory Elements (Davies, TRW, Inc.) – Discloses an associative memory system using the presence or absence of a persistent current in single control superconductor devices to represent binary information. Readout is accomplished by association in comparators which may be selectively masked.

3,643,237 – Multiple-Junction Tunnel Devices (Anacker, IBM Corp.) – Discloses memory circuits which employ non-linear tunnelling devices. Each device is a series arrangement of tunnel junctions causing the memory to have built in redundancy. Better reliability is asserted.

3,641,517 – Superconductive Data Storage Arrangement (Brilman et al, Societe Alsacienne de Constructions Atomiques de Telecommunications et d'Electronique "Alcatel") – Discloses a cryogenic device made up of an arrangement of elementary storage cells connected to an addressing device for the storage and the non-destructive reading of information. The cells are grouped so that the circuits for energizing the storage loops and the test conductors are interconnected in columns, and the writing conductors and the reading conductors are interconnected in lines.

ferroelectric memories

Ferroelectric memories contain a ferroelectric material either directionally polarized or modified in its inherent polarization direction by the application of an electric field to the domains of collectively oriented molecules in the materi-

Table 4 Distribution of Ferroelectric Memory Patents

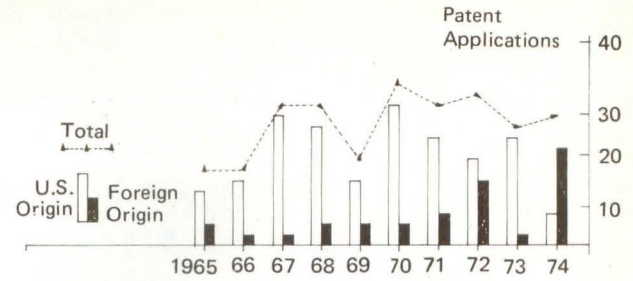
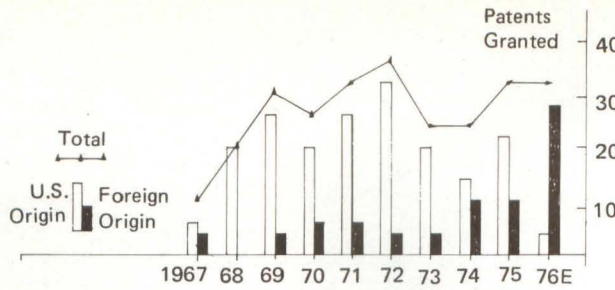

	By Patent Grant Date											Total 67-76E	By Patent Application Filing Date											Total 65-73
	1967	68	69	70	71	72	73	74	75	76E	1965		66	67	68	69	70	71	72	73				
Total Patents	5	10	15	13	16	18	12	12	16	16	133	7	7	13	13	8	15	13	14	11	101			
United States	3	10	13	10	13	16	10	7	11	2	95	5	6	12	11	6	13	10	8	10	81			
Total Foreign	2		2	3	3	2	2	5	5	14	38	2	1	1	2	2	2	3	6	1	20			
Japan				1	2	1	2	1	2	8	17			1		2	2	2	1	1	9			
Germany			1	1	1	1				2	2	1	1		1			1	1		5			
France								2	1	4	7								2		2			
Switzerland	1										1													
Sweden								1			1									1	1			
Mexico				1							1				1						1			
USSR							1				1								1		1			
Czechoslovakia	1										1													
United Kingdom		1									1	1									1			

al. The electric field is typically applied through two electrodes mounted upon the ferroelectric material. Polarization modulation caused by the electric field is used to control the intensity of incident light in a binary mode, in accord with data signals. The piezoelectric properties of ferroelectrics provide an additional mode of memory operation. The magnitude and sign of the electrical charge in the materi-

al, caused by the piezoelectric effect, are used to represent binary states.

Patent Activity

Recent patent activity has been directed towards storing information in ferroelectric material using the different effects engendered by the electric field. Patents issued since

The next time you have a technological problem, call the world!

Now, for only \$10, you can get everything you need to access a billion-dollar, worldwide computer system with a data bank of technology wanted and technology for sale! You can search the system with your own computer or teletype terminal, use one of the public terminals maintained by Control Data Corporation in major cities throughout the world, or we will search the data bank for you.

This special introductory offer to our subscribers is made possible by TECHNOTE, a technology exchange service of the Control Data Corporation. Companies worldwide use TECHNOTE to buy and sell products, processes and expertise across all industry lines and cultures.

You can search right from your own office. Local telephone numbers are used to access the system in 120 cities. TWX, Telex and satellites give the system interactive communication throughout the world. Mail and telephone service are available if you don't have a terminal.

The cost is amazingly low. You pay only \$10 for start-up charges, instruction manuals, etc. Thereafter, you pay time-sharing charges to search the data bank on your terminal (8-10 dollars per search is average). A small surcharge is added if we conduct the search for you on our terminal. After buyers and sellers locate each other, they are free to negotiate directly. TECHNOTE does not charge brokerage fees, royalties, etc.

TECHNOTE can save your company thousands of dollars every year, and keep you up-to-date on new products and processes available worldwide. To get started, simply mail this coupon today!



I'm interested! Enclosed is \$10.00 (or a company purchase order). Please send TECHNOTE identification and instruction materials immediately.

NAME _____
 TITLE _____
 COMPANY _____
 ADDRESS _____
 CITY _____
 STATE _____ ZIP _____

Send to:
DIGITAL DESIGN, % TECHNOTE
 P.O. Box 1985 • Twin Cities Airport Branch
 St. Paul, MN 55111

Table 5 Distribution of Plated Wire Memory Patents

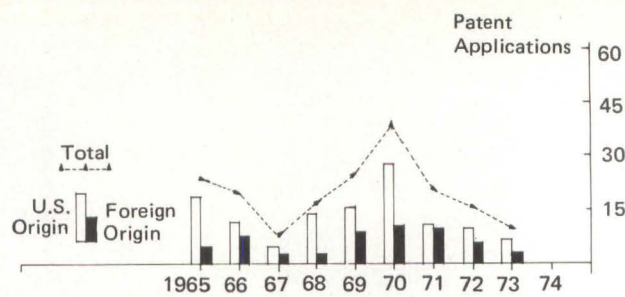
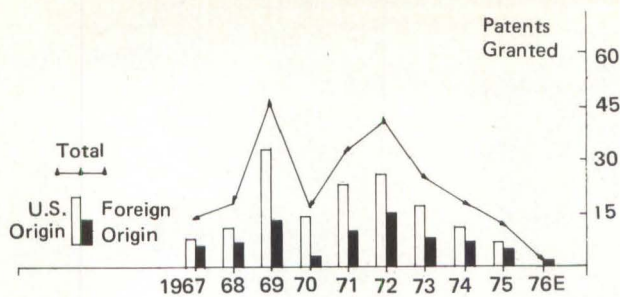

	By Patent Grant Date											Total	By Patent Application Filing Date											Total
	1967	68	69	70	71	72	73	74	75	76E	67-76E		1965	66	67	68	69	70	71	72	73	65-73		
Total Patents	14	18	45	17	33	41	25	18	12	2	226	24	20	8	17	25	39	21	16	10	180			
United States	8	11	33	14	23	26	17	11	7		150	19	12	5	14	16	28	11	10	7	122			
Total Foreign	6	7	13	3	10	15	8	7	5	2	76	5	8	3	3	9	11	10	6	3	58			
Japan	6	7	13	3	9	11	7	7	5	2	70	5	8	3	3	8	7	9	6	3	52			
France						2	1				3						2	1			3			
Germany					1	2					3					1	2				3			

November 1973 include:

3,964,033 – Electro-optic Storage Device (Wasa et al, Matsushita Electric Industrial Co. Ltd.) – Discloses a memory storage system utilizing a transparent ferroelectric ceramic plate and a pair of erasing electrodes on the opposite edges of the plate. The writing electrodes consist of thermally sensitive transparent resistor layers.

3,958,230 – Arrangement Including A Piezo-Ferroelectric Body (Petersen, U.S. Phillips Corp.) – Discloses a storage electrode terminating impedance for a piezo-ferroelectric memory. The impedance reduces deleterious electromechanical variations at adjacent storage electrodes upon partial polarization or depolarization of an electrode on a piezo-ferroelectric body.

3,930,240 – Ferroelectric Memories and Method of Activating The Same (Hadni et al, Agence Nationale de Valorisation de la Recherche (Anvar)) – Discloses a high capacity, non-destructive memory comprising a thin plate of ferroelectric material (triglycine sulfate) cut at right angles to its ferroelectric axis and metalized on two sides. Polarization modulating voltages are transmitted through the metalized sides of the material in order to switch the ferroelectric domains in the areas where a light source (laser) has scanned. A large storage capacity, by virtue of high density of writing and reading cells, is asserted.

3,890,604 – Selective Dipole Orientation Of Individual Volume Elements Of A Solid Body (Schroder) – Discloses a magnetic cube containing ferroelectric particles to which intersecting elastic waves are applied so that the volume element of said body which intersects with the superimposed portions of the waves at any given time has a higher energy density than any other portion of the body. A sensing element detects the changes in dipole orientation of the ferroelectric particles.

3,868,652 – Multi-Layer Ferroelectric Optical Memory System(Cooper et al, IBM Corp.) – Discloses a ferroelectric optical memory system utilizing a light scanner for selectively setting the birefringent level associated with a region or storage location of the ferroelectric layer. The birefrin-

gent levels collectively set for regions of each particular storage location indicate the digital information stored.

3,832,700 – Ferroelectric Memory Device (Wu et al, Westinghouse Electric Corp.) – Discloses a memory element utilizing the remanent polarization of a thin, ferroelectric film to control the surface conductivity of a bulk semiconductor. When a potential of one polarity is applied to a gate electrode of the ferroelectric material and the semiconductive substrate, and then removed, a persisting inversion layer or conducting channel is formed. When a potential of opposite polarity is applied, the channel will be depleted.

3,798,619 – Piezoelectric Transducer Memory With Non-Destructive Read Out (Samofalov et al) – Discloses a long-term storage device with non-destructive reading of information which uses a strip of ferroelectric material with at least two piezoelectric transducers. The ferroelectric material acquires piezoelectric properties when placed in an electric field.

3,774,174 – Polarization And Optical Switching Of Quadrizable Ferroelectric Films By Singular Electrodes (Francombe et al) – Discloses a ferroelectric material with at least two independently reversible polarization components and single-crystal domains. At least one set of electrodes are positioned to apply electric fields to single-crystal domains of the ferroelectric material at an angle to the reversible polarization components, so that one electric field can reversibly polarize both components and a second field can reverse one of the components without reversing the other

plated wire memories

Plated wire memories are non-destructive read-out type devices composed of a cylindrical magnetic film electroplated onto a conductive wire substrate. During fabrication, easy and hard axes of magnetization are established in the magnetic film with the easy axis being able to support two stable states representing a binary "1" and "0". These axes are organized into matrices and provided with the necessary circuitry to write and sense stored information.

DEC® RC-11 and RF-11 fixed-head disc...and Data General Novadisc® users:

Replace Fixed-Head Disc with Dataram

BULK CORE

See us in the U.S. Section at Systems 77

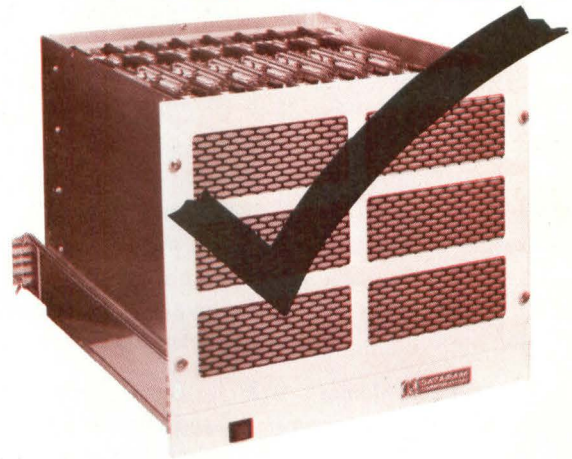
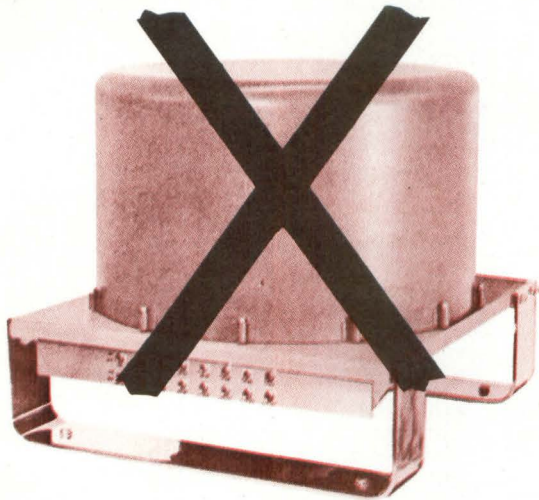

Now, all the remarkable features of Dataram's BULK CORE memory system are available to you in a unique storage peripheral with complete interfaces to emulate DEC and Data General fixed-head discs.

Basic building block of this dramatic, new peripheral is Dataram's BULK CORE module, which provides 256 kilobytes of storage on a single board. Eight of these modules can be packaged in a standard 19" chassis to provide two megabytes of storage.

To give you more of what you can't get from fixed-head discs. BULK CORE gives you microsecond-range access time, high reliability, and greatly improved maintainability. And at a price unheard of for core or semiconductor memory. Until now.

Until Dataram made its BULK CORE memory system plug-compatible with PDP-11 and Nova® minicomputers. To provide:

- Access time 1/10,000 of FHD
- High Throughput
- Zero Error Rate
- Self-Test for Fault Isolation
- Hardware & Software Transparent
- LED-spotlighted Fault Isolation
- 256 KB Modularity
- Non-Volatile
- Non-Mechanical
- High MTBF/Low MTTR
- Low Power
- Parity Check

Reasons enough to find out more about BULK CORE. If you use a DEC or Data General mini-computer—or any kind—and want to move ahead in performance, move a BULK CORE into your system.



PRINCETON-HIGHTSTOWN ROAD
CRANBURY, NEW JERSEY 08512
TEL:609-799-0071 TWX:510-685-2542

I'd like to learn more about BULK CORE for my

- PDP-11 Nova _____
 Please send information.
 Please have a salesman contact me.

Name _____

Title _____ Phone _____

Company _____

Address _____

City _____ State _____ Zip _____

- Please send me information about Dataram's ADD-ON/ADD-IN memory for minicomputers.

DEC and PDP are registered trademarks of Digital Equipment Corporation. Nova and Novadisc are registered trademarks of Data General.

Canada: Tracan Electronics Corporation, Ontario/Quebec/British Columbia • Belgium/Luxembourg/Netherlands: Synelec Information Systems, (02) 647-67-12 • France: YREL, 950-2224 • Italy: Telcom, s.r.l. 422-8646 • Sweden/Finland/Norway: Teleinstrument AB, 08-380370 • Spain: Apoca, (01) 457-53-12 • Switzerland: Interrest AG, 031-224481 • United Kingdom: Sintrom Ellinor Ltd., (0734) 85464 • West Germany/Austria: O.E.M. Elektronik GmbH, 0711-798047 • India: Industrial Electronic Instruments, 79281 • Israel: K.D.M. Electronics Ltd., (03) 58232 • Japan: Matsushita Electric Trading Co. Ltd., (03) 435-4552 • Australia/New Zealand: Anderson Digital Electronics, (03) 543-2077.

CIRCLE 61

Recent Activity

Recent patent activity generally has focused on memory arrangements which allow high packaging density and on the structural features of the plated wire memory element itself. Patents issued since April 1974 include:

3,906,467 – Plated Wire Memory (Velishek et al, Control Data Corp.) – Discloses a plated wire memory consisting of a barrier layer between the core of non-magnetic conductive material and an outer layer of highly permeable magnetic material. The barrier layer is constructed of conductive material such as gold or gold-copper alloy that does not diffuse into the magnetic material.

3,898,634 – Magnetic-Wire Memory System (Yoneyama, Toko Kabushiki Kaisha) – Discloses a balanced address selecting matrix type memory system composed of a first and second memory stack each including the same number of information lines and work lines arranged in a symmetrical manner. Circuitry is provided to compensate for noise created in the information lines.

3,895,362 – Integrated Magnetic Wire Memory (Yamakawa et al, Oki Electric Industry Co., Ltd.) – Discloses a memory cell composed of a plurality of parallel coplanar magnetic wires enclosed by an insulating film, and a plurality of U-shaped conductive non-magnetic wires disposed in a plane parallel to the plane of the magnetic wires and in a direction normal to the projected direction of the magnetic wires.

3,863,233 – Magnetic Memory Array (Edey et al, Goodyear Aerospace Corp.) – Discloses an associative processor which is a digital computer system capable of operating upon many independent sets of data simultaneously. Each data set is processed sequentially bit by bit, giving an overall effect that is analogous to a large bank of serial computers all executing the same program but on different data.

3,852,725 – Magnetic Plated Wire Memory Device (Ogura et al, Oki Electric Industry Co., Ltd.) – Discloses a magnetic memory device in which at least two independent memory planes are arranged on each side of a rigid base board. Readout driving current is taken from each opposing edge of the rigid base board surfaces.

3,824,566 – Magnetic Thin Film Plated Wire Memory (Kobayashi et al, Fuji Denki Kagaku Kabushiki Kaisha) – Discloses a memory with fewer digit drivers to attain lower cost and higher density. The memory contains a plurality of digit pair wires intersecting substantially at right angles with word wires. The digit wire pairs are grouped into a plurality of shift sense sections, each of which includes an equal number of digit pair wires.

3,810,134 – Memory Bit Drive Circuitry Providing Common Terminating Impedance to a Sense Line (Culp, General Electric Co.) – Discloses a matrix memory having an arrangement for providing write current to bit lines through the same wires on which output or sense signals are carried, without affecting the sense signals. Each bit is written into a storage cell which is magnetically coupled to a sense pair. A bit driver, composed of a current source, is connected across each pair.

3,803,656 – Plated Wire Memory Plane (Johnson et al,

**Table 6 Memory Comparisons:
Cost, Speed and Capacity**

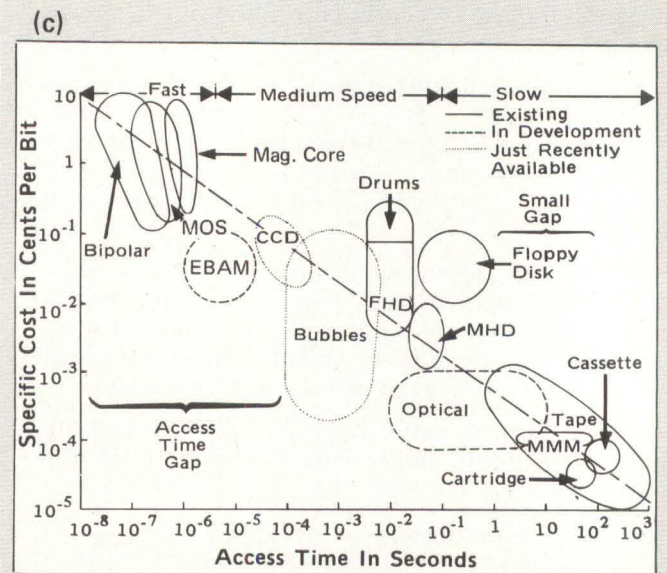
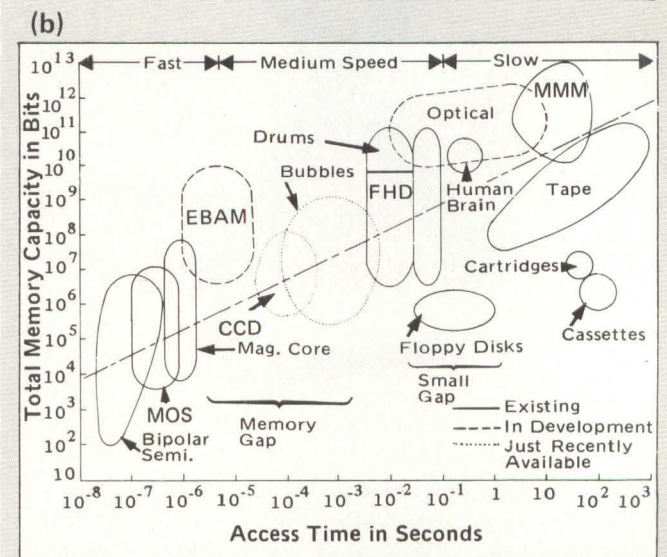
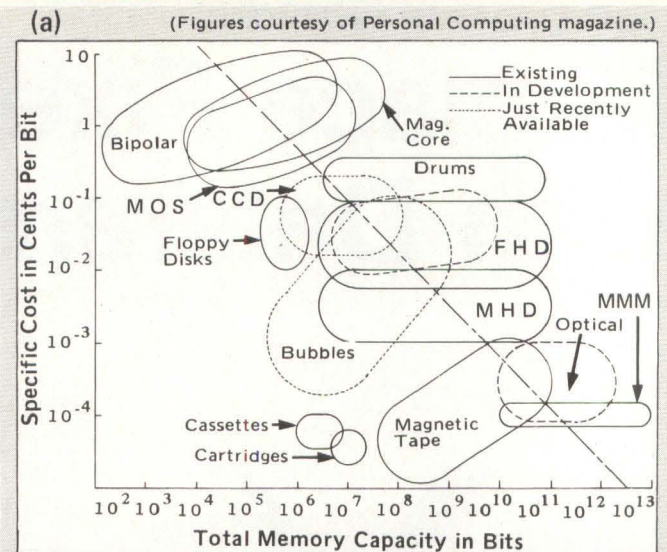

(a) Cost as a function of memory capacity. (b) Memory capacity as a function of access time. (c) Cost as a function of access time. MOS: Metal-Oxide Semiconductor; CCD: Charge-Coupled Devices; EBAM: Electron Beam Accessed Memories; FHD: Fixed Head Disks; MMM: Magnetic Mass Memory (magnetic tape automated library).



TRIPLE SAVINGS!

(LIMITED TIME OFFER)

- **20% OFF** ANY GROUP/3 EDUCATIONAL PRODUCT THIS MONTH
- **FREE** ATTACHE CASE AND RECORDER WHEN YOU ORDER ALL 4
- **SAVE TIME** AND INCREASE EFFICIENCIES IN YOUR SHOP

SOMETHING FOR EVERYONE! GROUP/3'S COMPLETE LINE OF DP EDUCATIONAL PRODUCTS COVERS ALL LEVELS OF COMPUTER USAGE AND MANAGEMENT – EVEN END USERS. EACH COURSE CONTAINS AUDIO CASSETTE INSTRUCTIONAL TAPES, WORKBOOKS, VISUALS AND REFERENCE MATERIAL.



CCM	COMPUTER CONCEPTS FOR MANAGEMENT	TEACHES THE BASIC FUNDAMENTALS ABOUT COMPUTERS IN NON-TECHNICAL LANGUAGE FOR TOP MANAGEMENT AND LINE MANAGEMENT.
DUOS	DEVELOPING USER ORIENTED SYSTEMS	PROVEN SYSTEMS DEVELOPMENT METHOD—PROJECT PLANNING AND CONTROL—DOCUMENTATION AND AUDIT PROCEDURES—BASIC STANDARDS AND PROCEDURES—ORIENTATION AND TRAINING GUIDE.
RPG-TOP	RPG II TECHNIQUES OF PROGRAMMING	BEGINNING RPG II FOR THOSE WHO WISH TO LEARN RPG II AS THEIR FIRST PROGRAMMING LANGUAGE OR WISH TO ADD IT TO THE LANGUAGE THEY ALREADY KNOW. PRE-REQUISITE FOR ADV-30.
ADV-30	ADVANCED RPG II & ARRAY PROCESSING	SAVES 30-50% IN PROGRAMMING TIME—ADVANCED RPG II TRAINING WHICH COVERS LOOK AHEAD, EXCPT, FORCE, READ AND ARRAY PROCESSING.

Rush Order Form or CALL NOW TOLL FREE (800) 423-5148 – In California, Call (213) 884-6678 Collect

PLEASE CHECK ONE OR MORE OF THE FOLLOWING:

- I'M TAKING ADVANTAGE OF THE 20% SAVING— PLEASE SEND ALL 4 PRODUCTS PLUS MY FREE ATTACHE CASE AND CASSETTE PLAYER/RECORDER
TOTAL PRICE: \$516.00 \$ _____
- CCM — \$120.00 (REGULARLY \$150.00) \$ _____
- DUOS — \$140.00 (REGULARLY \$175.00) \$ _____
- RPG-TOP — \$156.00 (REGULARLY \$195.00) \$ _____
- ADV-30 — \$100.00 (REGULARLY \$125.00) \$ _____
- \$3.00 Handling Charge (Omit if check is included) \$ _____
- Calif. Residents add 6% Sales Tax. \$ _____
- TOTAL** \$ _____

- PLEASE SEND FREE GROUP/3 PRODUCTS CATALOG
ALL PRICES SUBJECT TO CHANGE WITHOUT NOTICE

COMPANY		
NAME		TITLE
ADDRESS		
CITY	STATE	ZIP
PHONE	PURCHASE ORDER NO.	
SIGNATURE		
DD		

GROUP/3 and Informatics are Registered U.S. Trademarks
GROUP 3 is a part of Informatics Inc., the world's largest independent supplier of software products

GROUP/3
P.O. Box 1452
21050 Vanowen Street Canoga Park, CA 91304

Table 7 Distribution of Planar Film Memory Patents

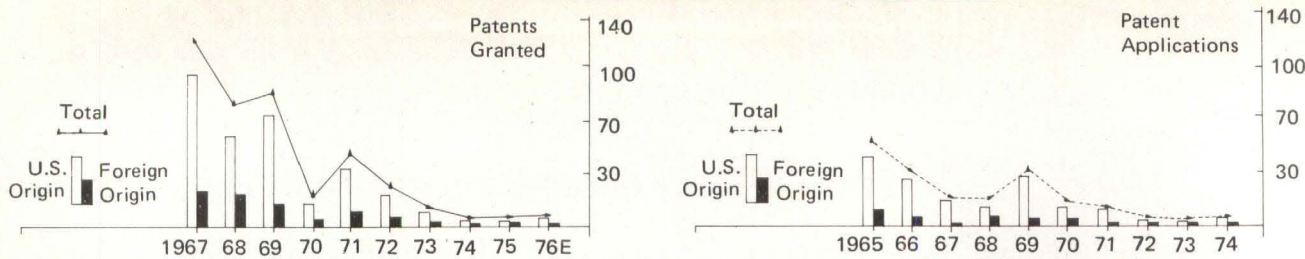

	By Patent Grant Date										Total 67-76E	By Patent Application Filing Date										Total 65-73
	1967	68	69	70	71	72	73	74	75	76E		1965	66	67	68	69	70	71	72	73		
Total Patents	122	80	88	20	48	27	13	6	7	8	419	56	36	19	18	37	17	13	6	5	207	
United States	99	59	73	15	38	21	10	4	4	6	329	45	30	17	12	32	12	11	4	3	166	
Total Foreign	23	21	15	5	10	6	3	2	3	2	90	11	6	2	6	5	5	2	2	2	41	
United Kingdom	10	6	4		1	1					22	2	1			1	1				5	
Germany	6	5	2	2	2				1	2	20	3	1	2	1					1	8	
France	1	1	2	1	5	3	1	2			16	2	1		3	3	1	2	2		14	
Japan	2	5	1	1	1	2	2		2		16	1	2		1	1	3			1	9	
Netherlands	3		1	1	1						6	1			1						2	
Switzerland	1	2	3								6	1									1	
Canada			2								2	1	1								2	
Indonesia			2								2											

Xerox Corp.) – Discloses a plated wire memory plane which includes a support member, an insulator having a plurality of parallel grooves, a plated wire, an annular magnetic coating uniformly deposited in all of the preformed grooves and a substantially U-shaped word drive laminate. The preformed grooves facilitate insertion of the plated wires into the insulator.

planar film memories

Planar film memories use anisotropic magnetic films of permalloy which contain a preferred axis of magnetization, called easy axis, and a perpendicular axis, the hard axis. The magnetic vector of the film aligns itself with the easy axis when no external magnetic fields are present. Magnetic fields generated by passing a current through a conductor mounted close to the film rotate this vector towards the hard axis. The realignment and rotation of the magnetic vector is the basis for two distinguishable, reversible states. Typically, planar films are classified according to their four major modes of construction: single plane film; coupled planar films; bicore elements; and mated-film elements.

Patent Activity

Recent patent activity has been directed towards more efficient planar film memory systems, such systems allowing for higher densities and lower power consumption. Patents issued since February 1973 include:

3,962,690 – Thin Film Magnetic Storage Device (Koenig et al, BASF Akteingesellschaft) – Discloses a ferromagnetic thin film with areas of differing coercive forces and electric conductors extending in planes parallel with the film's support, and at right angles to strip-like channels having low coercive force. The conductors produce magnetic fields required for propagation of magnetic domains in the low coercive force channels.

3,922,651 – Memory Device Using Ferromagnetic Substance Lines (Imamura, Kokusai Denshin Denwa Kubushiki Kaisha) – Discloses a word-selection memory comprising a plurality of non-magnetic lines arranged in parallel to one another and a plurality of memory lines. The magnetic lines

utilize ferromagnetic thin film orthogonally arranged with the nonmagnetic lines. Each of the memory lines is formed from conductive, ferromagnetic material having an axial easy magnetization axis.

3,798,623 – Quad Density Solid Stack Memory (Kaske et al, Sperry Rand Corp.) – Discloses an electrically alterable random access memory system which contains mated film elements as memory cells. The memory cells are arranged on each two-dimensional memory plane along two parallel running sense digit lines. A single word line, passing orthogonally through the stacked, superposed memory planes, is inductively coupled to a pair of memory cells, each cell associated with each sense-digit lines on each memory plane.

3,786,444 – Magnetic Thin Film Memory Packaging Design (Sly, U.S. Army) – Discloses a memory store unit made by aligning film core areas and bonding them in pairs on either side of a single piece of printed wire overlay which supplies word and common sense lines. Top and bottom insulators, apertured to receive the film core arrays are applied to the overlay for support and to maintain a uniform distance between the overlay and ground planes.

3,742,467 – Sense-Digit Line Selection Matrix For Memory System (Benrud et al, Sperry Rand Corp.) – Discloses a circuit for addressing a sense-digit line of a group of such lines that form part of a selection matrix of a ferroelectric thin film memory system. The group addressing circuit is a matrix of eight FET transistors for gating one of eight associated active sense-digit lines and one FET transistor for gating an associated dummy sense-digit line for reading and writing.

3,727,199 – Static Magnetic Memory System (Lekven, Signals Galaxies, Inc.) – Discloses a static magnetic memory which includes individual binary storage members that are afforded directional preferential magnetic characteristics in order to establish the preferred axis of magnetization. Conductors for driving the individual binary storage members are provided in a flat planar pattern.

3,723,983 High Density Thin Film Register (Lienhard, Ampex Corp.) – Discloses a magnetic thin film geometry

Table 8 Distribution of Domain Tip Propagation Memory Patents

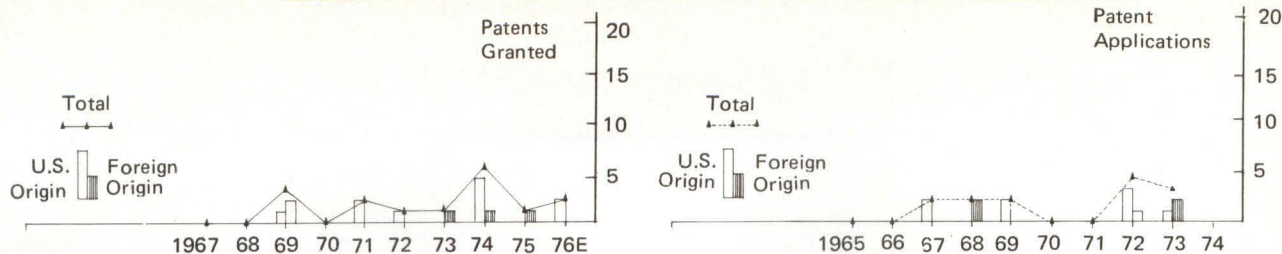

	By Patent Grant Date											Total 67-76E	By Patent Application Filing Date							Total 65-73
	1967	68	69	70	71	72	73	74	75	76E	1965		66	67	68	69	70	71	72	
Total Patents			3		2	1	1	5	1	2	15			2	2	2		4	3	13
United States					2	1		4		2	9			1		2		3	1	7
Total Foreign			3				1	1	1		6			1	2			1	2	6
France			3				1	1	1		6			1	2			1	2	6

wherein thin film strips have a preselected width to length ratio, film thickness, and value of coercive force. The geometry provides storage and transfer of stable magnetic domains with well defined boundaries and decreased interaction while allowing high packing densities.

domain tip propagation memories

Domain tip memories use the controlled motion of magnetic domains on a plane surface. Magnetic domains progress, stepwise, under the control of time varying magnetic fields in a medium of thin polycrystalline anisotropic layers in which a magnetic zone having low coercivity is surrounded by a basic layer having higher coercivity. The difference in coercivity restricts the formation and propagation of the domains to within a propagation channel. Binary information is represented by the presence or absence of a magnetic domain. Read out is accomplished by a number of methods generally including electromagnetic induction, Hall effect, direct optical sensing and magneto-resistance.

Recent Activity

Recent patent activity has generally focused on propagation techniques in the magnetic material. Emphasis has been placed on forming propagation channels suitable for stable movement of the magnetic domains. Patents issued since April 1972 include:

3,889,246 – Propagation Register for Magnetic Domains (Battarel, Techniques et Systemes Informatiques) – Discloses a new geometrical configuration of flat electrical conductors deposited on the same substrate as a polycrystalline layer. The electrodes are used for ensuring the propagation of magnetic domains, in a shift register operation, between an input division (write-in by nucleation) and an output division (reading).

3,855,584 – Improved Register For Propagating Magnetic Domains (Battarel et al, Techniques et Systemes Informatiques) – Discloses a shift register having a thin polycrystalline anisotropic magnetic film of low coercivity. The film has a ridge which is inclined 45° to the difficult axis of magnetization, has variations in slope between the two ends, and is formed by two separate zones of coercivity.

3,846,770 – Serial Access Memory Using Magnetic Domains in Thin Film Strips (Schwee et al, United States Navy) – Dis-

closes a polycrystalline thin film strip to store information in a serial manner in the form of reversal domains. The reversal domains are propagated along the thin film strip, which may be Permalloy, and then sensed to detect the stored digital information.

3,806,900 – Multiplexing System for Thin Film Magnetic Propagation Channels (Spain et al, Cambridge Memories, Inc.) – Discloses a magnetic device employing domain tip propagation in assemblies which include a number of shift registers within a single propagating drive coil. A high speed transfer in and out rate is achieved by employing multiplexing selector lines, one for each shift register within the coil, to select, within each period of drive propagation, each shift register channel in sequence for write in and read out.

3,786,449 – Magnetic Thin Film Shift Register Having Bi-directional Transmission Elements and Offset Block Sites (Jauvtis, Cambridge Memories, Inc.) – Discloses a digital shift register propagating information as discrete regions of reverse magnetization. The shift register has a bidirectional transmission path and produces magnetic fields along the path. Domain-blocking fields are produced at sites along the path offset uniformly from the domain-holding locations by less than one-half the spacing between adjacent hold locations.

3,739,358 – Shift Register Operating By Propagation of Domains in Thin Films of Magnetic Material (Battarel, Techniques et Systemes Informatiques) – Discloses two zones of magnetic coercivity, the first zone extending along the axis of relatively difficult magnetization and being divided from the second zone on opposite sides by first and second boundaries in the form of regular saw teeth, with the second axis being displaced relative to the first by half the width of a saw tooth.

3,656,126 – Bi-Directional Shift Register – (Jauvtis, U.S. Air Force) – Discloses a magnetic domain punch-through diode shift register having a pair of vertical low coercive channels in a region of high coercivity. Dispersed in the channels are punch-through magnetic domain diodes which alternate with opposing polarities. A domain can be propagated in only one direction by applying a conducting pulse to a chosen diode at the same time as a drive pulse is applied.

Patent Activity For CRT And Optical Memories

Table 9 Distribution of Optical Memory Patents

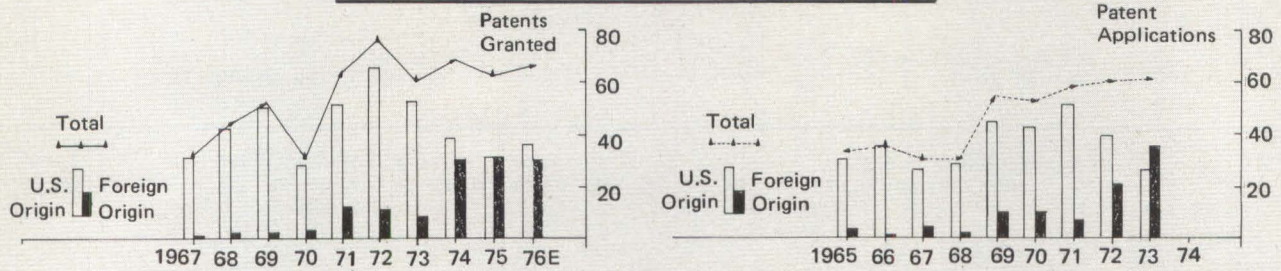

	By Patent Grant Date											Total 67-76E	By Patent Application Filing Date											Total 65-73
	1967	68	69	70	71	72	73	74	75	76E	1965		66	67	68	69	70	71	72	73	65-73			
Total Patents	32	44	52	31	63	76	60	68	62	66	554	33	35	30	30	54	52	58	60	61	413			
United Kingdom	31	42	50	28	51	65	51	38	31	36	424	30	34	26	28	44	42	51	39	26	320			
Total Foreign	1	2	2	3	12	11	8	30	31	30	130	3	1	4	2	10	10	7	21	35	93			
Japan			1		5	3	2	10	13	16	51				1	5	4	1	9	10	30			
Germany			1		1	4	3	6	7	4	27	1		2		1	2	5	3	9	23			
France					1	3		8	6	4	22			1		1	2		4	8	16			
United Kingdom	1		2		3	1		3			10	2		1		2	2		2	1	10			
Canada					1			1	2	2	6		1						1	2	4			
Switzerland					1			1		2	4			1					1	2	2			
Sweden							1	1	2	2	4								1	1	2			
Netherlands									2	2	2													
Italy									2	2	2								2	2	2			

In the August 1977 issue of *Digital Design*, Benwill/Technocast reported on charge coupled devices, core memory, semiconductor memory, cathode ray tube memory and optical memory. We inadvertently left these charts and tables out of that report. Table 9 details patent activity for optical memories. Optical memories include those memory systems in which laser beams are used to read or write information

from photosensitive films, semiconductors or ferroelectric materials. Table 10 details patent activity for cathode ray tube memories. CRT memories use photo-sensitive surfaces as a target upon which an electron beam reads and writes. For details of selected patents, see the August issue, available for \$3.00 (please send check) from Benwill Publishing, 167 Corey Road, Brookline, MA 02146. DD

Table 10 Distribution of CRT Memory Patents

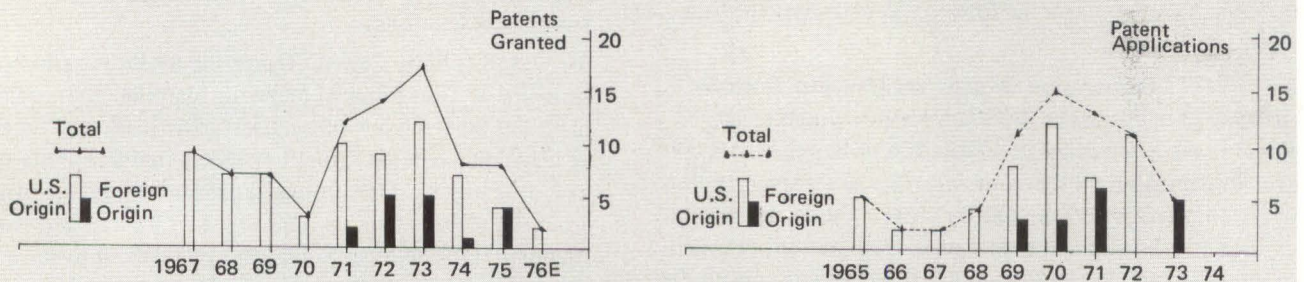

	By Patent Grant Date											Total 67-76E	By Patent Application Filing Date											Total 65-73
	1967	68	69	70	71	72	73	74	75	76E	1965		66	67	68	69	70	71	72	73	65-73			
Total Patents	9	7	7	3	12	14	17	8	8	2	87	5	2	2	4	11	15	13	11	5	68			
United States	9	7	7	3	10	9	12	7	4	2	70	5	2	2	4	8	12	7	11		51			
Total Foreign					2	5	5	1	4		17					3	3	6		5	17			
Germany						3	3		1		7					1	2	3		1	7			
France								1	3		4									4	4			
Japan					1	1					2					1	1				2			
Canada					1	1					2					1		1			2			
Netherlands								1			1								1		1			
United Kingdom									1		1							1			1			

Using Microprocessor Development Systems

by Greg Miller

In the past few years, two powerful development tools for the digital designer have appeared. The first is the logic analyzer, covered in detail in this issue (see p. 55). The second tool, the microprocessor development system, has been introduced in response to the special development problems posed by microprocessor-based digital systems.

The logic analyzer, primarily a passive observational tool, does for digital domain information essentially what the oscilloscope has long done for time domain information. Using various display formats (timing diagram, state diagram, state map) the logic analyzer aids the designer in performing both logic state analysis and logic timing analysis. The former requires synchronous sampling of the digital information; the latter needs fast, asynchronous sampling. As opposed to microprocessor development systems, logic analyzers find application in all types of digital design, not just in the highly important area of microprocessor-based systems. It should be noted that logic analyzers can be sub-divided into two categories: general purpose types, which offer both state analysis and timing analysis, and those dedicated to microprocessor applications, usually offering state analysis only.

Development Systems Are Not Logic Analyzers

Microprocessor development systems, while restricted in application to the design of microprocessor-based digital systems, do cover that area thoroughly. Unlike the logic analyzer, the development system plays an active, and in fact, interactive role in the design process. The flowchart in Fig 1 traces the parallel development of software and hardware for a microprocessor-based system and the all important step of integrating the two. The development system applies to all three parts of the design process.

On the software side, the designer enters source code programs into the development system via an input terminal. Fig 2 shows a block diagram of a universal microprocessor development system. After editing, the program is assembled into the object code of the new system's microprocessor. The program then runs under some form of debug control. Typically the user can step through the program one instruction at a time and print out the contents of registers internal to the microprocessor. Also, the user can change the contents of these registers.

Depending upon the development system employed, the

program run may use either a simulation or an emulation of the chosen microprocessor. Emulation (run on the actual microprocessor type) has an advantage over simulation (run on some other processor) in that it tests not only for pure software errors, but also for program-hardware interactions such as timing peculiarities of the specific microprocessor. Any detected program errors are corrected in source code; the program is then reassembled and rerun until no further errors are detected.

Some development systems include an in-prototype emulation capability. This entails a cable extending from the development system to the microprocessor socket of the hardware prototype. It allows the microprocessor and memory of the development system to emulate those of the hardware prototype. This in turn makes possible an orderly section-by-section check-out of the complete system when

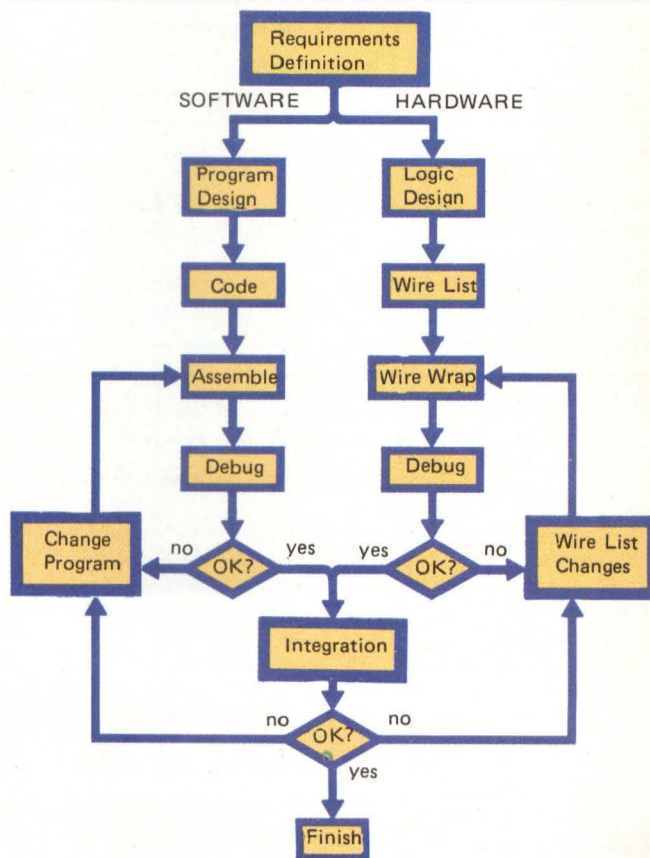

Fig 1 This flowchart shows the development of hardware and software in system design.

digital design

SUBSCRIPTION QUALIFICATION CARD

FOR NEW SUBSCRIBERS ONLY.

Use this form only if you do not already receive this magazine in your name. Please be sure to sign and date this form.

My Name _____ Title _____ SIGNATURE _____ DATE _____
 (please print or type)

Company Name _____
 Company Address _____
 Dept. No. _____ Bldg. No. _____ M.S. No. _____
 City _____ State _____ Zip Code _____

Home Address _____
 City _____ State _____ Zip Code _____

Fill in below if company requires home delivery: but company & zip MUST be included above.

PART I If I qualify, I would like to start to receive a free subscription to:

DIGITAL DESIGN Yes No

PART II My principal responsibility is (circle only one):

1. Management 2. Engineering

PART III My principal job function is (circle only one):

- | | |
|----------------------------------|---------------------------|
| 1. Corporate & Operating Mgmt. | 6. Circuit Design Eng. |
| 2. Manufacturing Mgmt. | 7. QC/QA/Reliability/Test |
| 3. Process Development Eng. | 8. R&D Eng. |
| 4. Production/Manufacturing Eng. | 9. Engineering Support |
| 5. Systems/Equip. Design Eng. | 10. Marketing/Sales |

PART IV The primary end product (or service performed) at my plant and the product (or service) that is my own work:

my plant my own work (Insert number in each box even if the same)

- | | |
|--|---|
| 1. Large Computers | 12. Materials and Hardware |
| 2. Mini-computers | 13. Aircraft, Missile, Space and Ground Support Equip. |
| 3. Computer Peripheral Equip. | 14. Oceanography and Support Equip. |
| 4. Data Processing Systems (systems integration) | 15. Medical Electronics |
| 5. Office and Business Machines | 16. Industrial Co. within the OEM Incorporating Electronic Equip. in Their End Product, not Elsewhere Classified |
| 6. Test, Measurement and Instrumentation Equip. | 17. Independent Research, Test and Design Laboratories and Consultants (only if you are not connected with a manufacturing company) |
| 7. Communications Systems and Equip. | 18. Govt. Agencies and Military |
| 8. Navigation and Guidance Systems and Equip. | 19. School University or Library |
| 9. Consumer Electronic Appliances | |
| 10. Industrial Controls, Systems and Equip. | |
| 11. Components and Sub-assemblies | |

WHO qualifies for DIGITAL DESIGN?

Engineers and engineering managers who design and specify digitally controlled or operated systems. With a professional interest ranging from integrated circuitry to computer systems, these readers configure and design equipment such as data processing and acquisition systems, industrial and process control systems, data communications hardware and instrumentation packages.

WHY should you want to read DIGITAL DESIGN?

Because each month DIGITAL DESIGN publishes fact-packed news and feature articles with solutions to digital design problems. And twice each year, DIGITAL DESIGN publishes the DIGITAL DESIGN HANDBOOK, an indispensable reference issue with product surveys in such areas as memories, minicomputers, microcomputers, printers and plotters, reel-to-reel drives, floppy-disk drives, hard-disk drives, cartridge drives, CRT terminals, displays, modems, keyboards and connectors.

PART IV A The products I expect to select, specify or buy are primarily for (circle one or both):

- In-plant or department use
- Design into components or systems my company sells to the Original Equipment Market

PART V Within the next 12 months I expect to select, specify or buy (please circle no more than 20 items; read carefully before selecting):

- | | |
|--|--|
| DIGITAL SYSTEMS DESIGN | 35. Power Supplies, Switching |
| 1. Computer Interfaces | 36. Printers |
| 7. Meters, Digital/Counters | 37. Microprocessors |
| 8. Motors, Peripheral Drive | 38. Punched Tape Equipment |
| 10. Motors, Stepper | 39. Readouts & Displays |
| 16. Keyboards | 40. Magnetic Recording Media |
| 17. Switches, Solid State | 41. Programmable Controllers |
| 19. Sensing Devices | 42. Tape Drives, Cassette or Cartridge |
| 20. Ruggedized Computer & Peripheral Equip. | 43. Tape Drives, Reel-to-Reel |
| 22. Computers, Mini | 44. Terminals, Intelligent/Data Entry |
| 23. Computers, Micro | PACKAGING |
| 24. Data Acquisition Modules | 45. Cabinets, Enclosures |
| 25. CRT Terminals & Displays | 46. Connectors |
| 26. Digital Circuit Components | 47. Cooling, Fans & Blowers |
| 27. Disc or Drum Storage Units | 49. Backplanes |
| 28. Floppy Disc Storage Units | TEST & MEASUREMENT INSTR. |
| 29. Memory Chips | 55. Component Function Testers |
| 30. Add-on Memories, Core & Semi | 56. Logic Analyzers |
| 31. Modems | 57. I/C Function Testers |
| 32. Software Development Aids for Microcomputers | 58. Instruments, Recording |
| 34. Plotters | 59. Oscilloscopes |
| | 60. Sub-Assembly Function Testers |

please fill in **all**
appropriate sections

hardware and software are brought together. The in-prototype emulation cable also permits some basic testing of the hardware prototype even before software is completed. By writing some short routines, the designer can exercise the hardware to see if basic functions such as printer I/O are working at all.

The Place of Microprocessor Development Systems and Logic Analyzers in the Design of Digital Systems

Microprocessor Development System Only	Joint Use	Logic Analyzer Only
Program entry and editing	Stimulus of prototype by development system and monitoring response of prototype with logic analyzer during hardware development phase.	Developing and checking out random logic (i.e., non-microprocessor-based) segments of prototype.
Program assembly	Debugging of program problems which result from hardware timing considerations.	Production or field testing of logic patterns against known good patterns.
Pure software debugging of program	Simultaneous monitoring of all microprocessor and all prototype I/O lines during checkout.	Logic timing analysis
Emulation of microprocessor and program memory PROM programming		

Advances in Development Systems

Historically, microprocessor manufacturers have marketed development systems that support only one microprocessor type. Recently Tektronix brought out a universal development system, the 8002 μ P Lab; this system supports development when using one of several common microprocessor types.

One significant advantage offered by this new development system is the addition of a feature termed "hardware trace." Software trace, the ability to single-step through programs looking at details such as internal register contents, was described earlier. While extremely useful, problems due to hardware phenomena may be overlooked when using software trace, since constant interrupts prevent the program from running in real time as it will in the final system. "Hardware trace" can be thought of as a partially dedicated logic state analyzer. The program runs in real time and 40 bits of information are recorded in a memory for each of the most current 128 sequential instructions. The 40 bit word includes 16 memory address lines and 16 data lines for the microprocessor plus 8 probes which the designer may use to look at whatever he chooses (I/O portion of his prototype, for example). The program runs in real time and interrupts only at established breakpoints representing an error or other condition of interest to the designer. Upon encountering a breakpoint, the program halts and memory contents are displayed on the development system's terminal. When a real time display is required, the breakpoint can trigger an oscilloscope.

UP YOUR DATA STORAGE CAPABILITIES

... with Genisco's ECRs, the first fully-militarized digital cartridge recorders using IBM/ANSI 9-track formats.

Now realize the best of both worlds — reel-to-reel and cartridge recorders — with Genisco's ECR Series that replaces reel-to-reel machines where space/weight are prime considerations, and 3M cartridge drives where higher capacity and faster throughput are essential requisites. Here's just a briefing on their benefits. Contact us for the complete "best-seller" story!

- Use existing software** — compatible with IBM/ANSI 9-track formatting.
- High data density/fast transfer** — stores up to 46 megabits and transfers data at a 160K bits/second rate at 25ips.
- Lightweight and compact** — measures roughly 4" x 8" x 13" and weighs just 14 lbs.
- MIL performance** — designed, tested-to, and meeting MIL-E-5400.
- Use existing controllers** — simple modifications allow interfacing with IBM/ANSI 9-track formatting.
- Proven track-record** — used in such major D.O.D. programs as the AN/TSSQ-73 Missile Minder, the AN/TTC-39 Tri-Tac, etc.

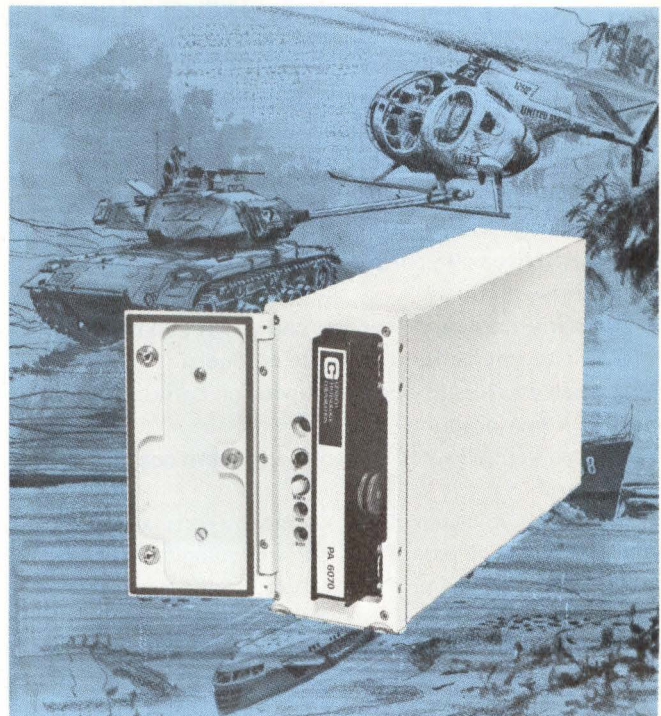

GENISCO TECHNOLOGY CORP.
SYSTEMS DIVISION

18435 Susana Road, Compton, CA 90221 • (213) 537-4750

CIRCLE 62

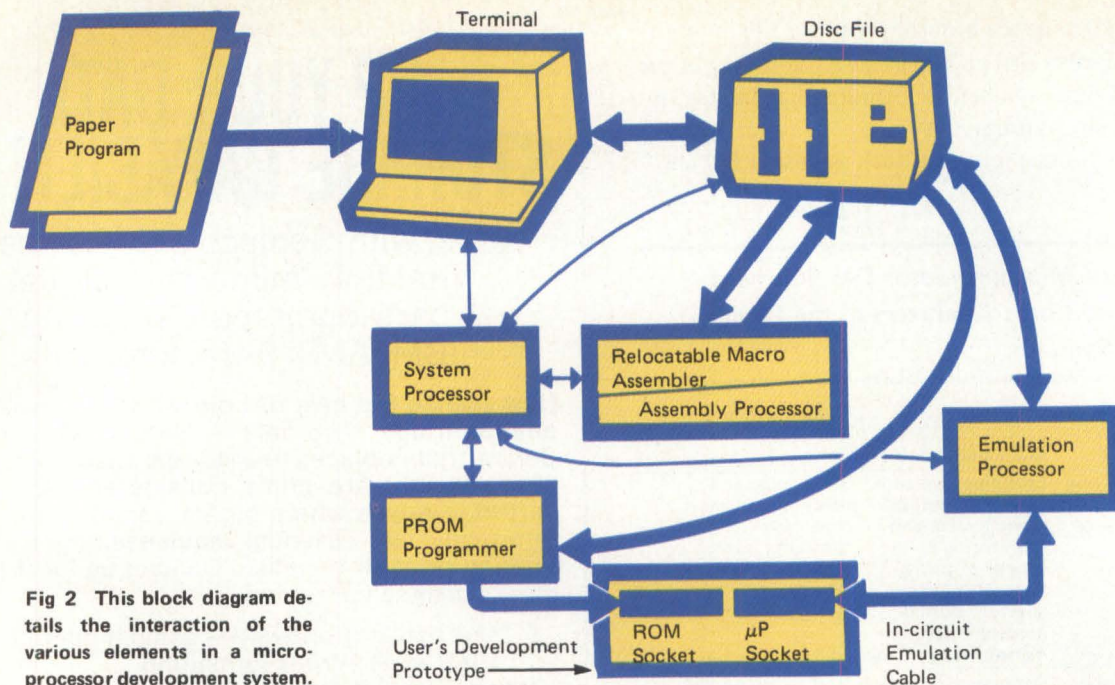

Fig 2 This block diagram details the interaction of the various elements in a micro-processor development system.

Development Systems and Logic Analyzers Working Together

With attention to detail by the instrument manufacturer, microprocessor development systems and logic analyzers can work as a complementary pair to solve the problems posed by design of microprocessor based system. A micro-processor development system could include a complete

general purpose logic analyzer by expanding on the "hardware trace" concept. In general, however, it is probably advantageous to keep the two separate so that the designer can exercise the choice of when to use them on independent tasks. The table on p. 103 shows you when to use each instrument.

DD

Greg Miller is with Tektronix Corp., Beaverton, OR.

STATE-OF-THE-ART PROFILES

Those of you who have the responsibility of determining what your company or division will be developing, marketing and financing three to five years from now worry about:

- How well protected will the products be you plan to introduce?
- How effective will your proprietary position be on your planned new product?
- What early-warning procedures can you set up or pursue to anticipate competition for these products?
- How can you identify your competition before they introduce their new products?
- How can you tell what known or unknown competition is doing now?

Your economic strength as a company rests largely on your technological base. And your technological base is a function of your technical know-how, your patents and your knowledge of what your competition is doing.

If you're in research, development and design, you need to know the prior art and who owns it.

If you're in marketing management, you need to know who else may enter your markets with competitive products.

If you're in top management, you need to know how much money — if any — should be released for research, development and marketing programs.

To assist you in answering these questions, Benwill Publishing Corporation in conjunction with Technocast, Inc. of Washington, DC, publishers of Technocast™ Reports is introducing a new service. Using a unique computer program and comprehensive data bases, we can provide you with the names of potentially competitive companies and the patents they hold. And we can deliver all of this on almost any clearly well-defined single subject for a low, low base cost of \$350.

All you need do is identify the specific subject of your interest and give a degree of specificity that will allow our computers to discriminate among the thousands of subjects within our data base.

Want more information?

Call us and ask for the Benwill/Technocast Service Bureau.

BENWILL/TECHNOCAST

Boston Office: 167 Corey Road, Brookline, MA 02146 (617) 232-5470

KERONIX

- ◎ MINI COMPUTERS
- ◎ PERIPHERAL CONTROLLERS
- ◎ ADD-IN MEMORIES
- ◎ ADD-ON MEMORIES
- ◎ TERMINALS
- ◎ SYSTEMS

A Total System

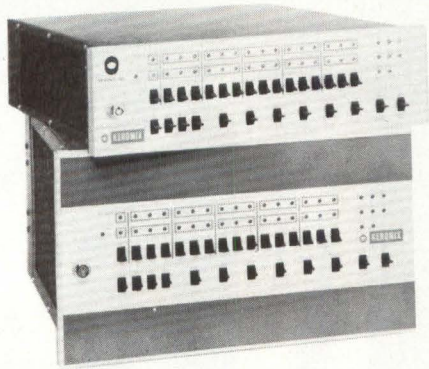

KERONIX IDS - 16 MINICOMPUTERS

A 16-Bit Full Parallel Synchronous, High-Speed
General Purpose, Mini Computer

- INSTRUCTION SET, I/O INTERFACE & MEMORY INTERFACE COMPLETELY COMPATIBLE WITH NOVA™ SERIES OF MINI COMPUTERS
- ADDRESS UP TO 65K (Without the Use of Costly Memory Management)
- HINGED FRONT PANEL WITH FRONT LOADING CIRCUIT BOARDS
- POWER FAIL & RESTART—STANDARD
- FOUR 16 BIT ACCUMULATORS
- 800, 1000, or 1200 NANOSECOND MACHINE CYCLE TIME USING ONE BOARD CPU'S
- 4, 8, 10, 13 OR 17 SLOT CAPACITY
- INTEGRATED MSI & LSI CIRCUITS THROUGHOUT. TRI-STATE ELEMENTS ARE USED FOR ALL I/O & MEMORY LINES
- FORCED-AIR COOLING (UP TO 4 COOLING FANS)
- POWER SUPPLY IS MODULAR FOR EASY SERVICING & PROVIDES UP TO 50% MORE POWER THAN COMPARABLE UNITS
- MANY OPTIONAL FEATURES AVAILABLE
- EXTENSIVE SOFTWARE AVAILABLE
- LOANERS AVAILABLE ON OUR ONE-YEAR WARRANTY

**LOOK FOR OUR COMPLETELY INTELLIGENT
KERONIX MODEL KX-8000, COMING SOON!**

For more extensive information on our IDS-16, please contact us directly.

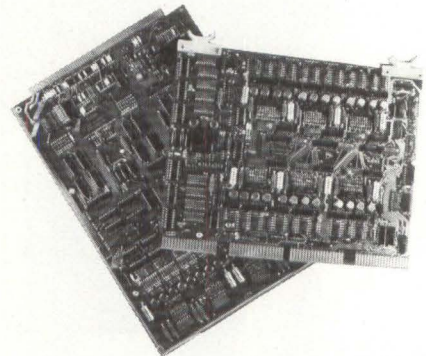

KERONIX ADD-IN MEMORY PRODUCTS

4K, 8K, And 16K Words
PLUG COMPATIBLE CORE MEMORY SYSTEMS

- P-3 SERIES . . . FULLY COMPATIBLE WITH DATA GENERAL NOVA™ 1200 & DCC™-116
- P-4 SERIES . . . FULLY COMPATIBLE WITH DATA GENERAL NOVA™ 800, 820 and 840
- P-5 SERIES . . . FULLY COMPATIBLE WITH DATA GENERAL NOVA™ 2 SYSTEMS
- I SERIES . . . FULLY COMPATIBLE WITH INTERDATA™ 70, 74, 7/16, 7/32 SYSTEMS
- D SERIES . . . FULLY COMPATIBLE WITH PDP-11™_s
- J-1 SERIES . . . FULLY COMPATIBLE WITH MICRODATA™ 800 AND CIP™ 2000
- J-2 SERIES . . . FULLY COMPATIBLE WITH MICRODATA™ 1600
- G SERIES . . . FULLY COMPATIBLE WITH PRIME™ 100, 200, & 300
- E SERIES . . . FULLY COMPATIBLE WITH PDP™ 8E, F, M, AND A

IN ADDITION TO THE ABOVE, KERONIX MANUFACTURES ADD-ON MEMORIES, OEM MEMORIES, AND CUSTOM MEMORIES

**ONE-YEAR WARRANTY
WITH ALL KERONIX MEMORIES**

TM Trademarks registered by Data General Corp., Digital Computer Controls, Inc., Interdata, Digital Equipment Corp., Microdata, Cincinnati Milacron, and Prime. Endorsement of Keronix products not to be implied.

KERON

WE HAVE REPRESENTATIVES

George
250 E. Emerson St. • Orange, C
TWX 91

ms Capability



VIDEO DISPLAY TERMINAL KERONIX MODEL K-4000

- FULL KEYBOARD (Optional 10-Key Pad Available)
- HIGH RESOLUTION, NON-REFLECTING SCREEN; 9" X 7" (12" Diagonal); SWIVEL BASE; EASY VIEWING UP TO 10 FEET; BRIGHTNESS CONTROL; REVERSE VIDEO (Black Characters on White Background, Selectable)
- 80 CHARACTERS PER LINE, 25 LINES, 2000 CHARACTER DISPLAY; STORE UP TO 51 LINES & 4080 CHARACTERS; BLINKING CHARACTERS AT 3Hz RATE
- CURSOR CONTROL (Non-Destructive)
- INTERCHANGEABLE WITH TELETYPE USES STANDARD ASCII CODE
- INTERNAL POWER SUPPLY; RUNS OFF A SINGLE 15" X 15" P.C. BOARD
- VARIABLE BAUD RATE (75 to 9600 Bits Per Second); 10 OR 11 BIT CODE
- ODD OR EVEN OR MARK PARITY
- EITHER EIA OR 20 MA CURRENT LOOP

LOOK FOR OUR COMPLETELY INTELLIGENT

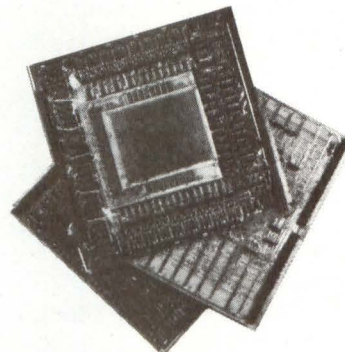

I/O AND PERIPHERAL CONTROLLERS FOR KERONIX IDS 16 COMPUTERS AND NOVA™ SERIES OF COMPUTERS

- 1007 I/O BOARDS
- 1008 REAL TIME CLOCK
- 1010 TTY INTERFACE
- 1011 PAPER TAPE READER CONTROL
- 1012 PAPER TAPE PUNCH CONTROL
- 1016 CARD READER CONTROLLER
- 1023 EIA INTERFACE
- 1034 LINE PRINTER CONTROLLER
- 1038 MULTI-PROCESSOR COMMUNICATIONS ADAPTER
- 1046 DISK CONTROLLER
- 1146 FLEXIBLE DISK CONTROLLER
- 1054 EXTENDER BOARDS
- 1060-4 FOUR LINE ASYNCHRONOUS MULTIPLEXER FOR FOUR EIA STANDARD LEVEL LINES (MUX)
- 1060-8 MUX FOR EIGHT EIA STANDARD LEVEL LINES

IN ADDITION TO THE ABOVE, KERONIX MANUFACTURES ADD-ON MEMORIES, OEM MEMORIES, AND CUSTOM MEMORIES

ONE YEAR WARRANTY ON ALL KERONIX I/O PERIPHERAL CONTROLLERS

TM Trademarks registered by Data General Corporation
Endorsement of Keronix products by Data General not to be implied.

KERONIX INC.

AND DISTRIBUTORS WORLDWIDE

Földvary
California 92662 • (714) 974-0800
(714) 593-1344

PRODUCTS

RECORDER/REPRODUCER SPORTS μ P

The Sabre X IRIG magnetic tape recorder/reproducer incorporates a programmable microprocessor, ten electrically selectable tape speeds and dual functioning channel electronics. The unit includes serial and/or parallel high density (HDR) electronics, tape lifting from the R/R heads during a slew mode, vacuum tape tensioning and modular design for immediate servicing access. The Sabre X operates at ten speeds from 240 thru 15/32 ips for record and reproduce. Each channel of electronics is dual functional for direct or FM process. Bandpass capabilities for each speed meet or exceed all IRIG requirements with bandpass capability extending to a 4 MHz at 240 ips for Wideband II. Sangamo Data Recorder Division, PO Box 3347, Springfield, IL 62714. (217) 544-6411. **Circle 157**

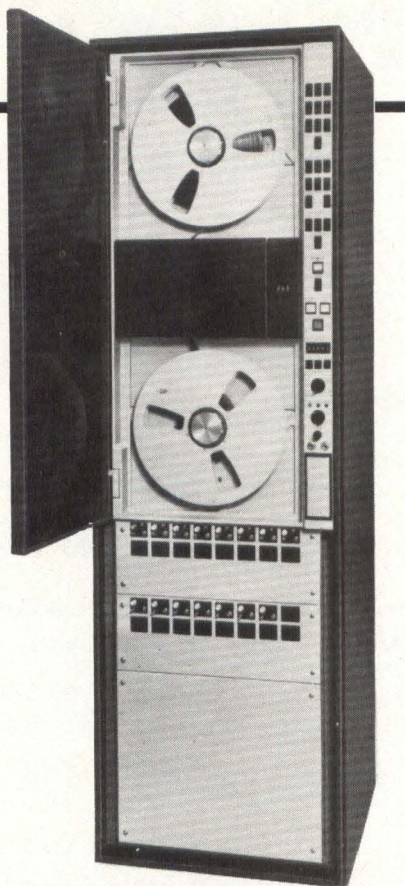

PROGRAMMABLE WAVEFORM DIGITIZER

The TEKTRONIX 7912AD programmable waveform digitizer brings full programmability of operating parameters to what is said to be the world's fastest waveform digitizer. The 7912AD operates like an

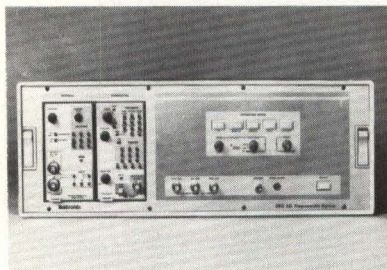

oscilloscope except that acquired waveforms are output as digital information for waveform processing instead of presented as CRT displays. A built-in microprocessor directs setting scale factors and other controls from a remote terminal or software program. The 7912AD is fully compatible with the IEEE 488 bus so that control can be exercised by a wide range of programmable calculators, microcomputers, and mini-computers. The 7912AD captures

single-shot transients up to 500 Mhz in its conventional operating mode and up to 1 GHz using direct access to the CRT deflection plates. Operation is fully programmable to 200 Mhz. The digitizer uses scan conversion to capture single-shot transients. Equivalent writing rate of the instrument is 800 div/ μ s; acquired signals are digitized in 15 ms using a precise raster scanning approach. 512 points can be resolved on the horizontal axis within a time window as narrow as 5 ns; vertical resolution is also 512 points. Price is approximately \$22000 including programmable plugins. Tektronix Inc., P.O. Box 500, Beaverton, OR 97077. (503) 644-0161. **Circle 201**

DOUBLE-SIDED, DOUBLE-DENSITY DISK DRIVE

A double-sided, single- or double-density "floppy" disk drive designed for the OEM market, the CDC 9406 flexible disk drive, provides unformatted storage capacity of 1.6 Mbytes of data using IBM compatible storage media. An enhanced version of the microprocessor-controlled

flexible disk subsystem, the CDC 9474, incorporates one or more of the double-sided drives, providing up to 6.4 Mbytes of unformatted data storage capacity in a four-drive configuration. Applications for the drive and subsystem include use with small business computer and intelligent terminal systems, dedicated minicomputer system installations, and in terminal, word processing and data entry subsystems.

The CDC 9406 double-sided drive operates with data formatting and timings resident in the host controller. A printed circuit board contains the drive electronics at the back of the drive chassis; the unit requires no electrical adjustment for either hard- or soft-sector operation. Access time is 6 ms track-to-track and recording density is 48 tpi and 3268/6536 bpi. The 9474 disk subsystem uses an Intel 8080 microprocessor to control the operations of up to four floppy drives. Single- and double-bit density, single- and double-sided units intermix on a subsystem to provide up to 6.4 Mbytes of data storage. The CDC 9474 quantity one price starts at \$2,600. Control Data Corp., Box O, Minneapolis, MN 55440. (612) 853-4656 **Circle 202**

A/D CONVERTS IN 50 μ S

This general purpose A-to-D converter, the ZAD3013, provides a conversion time of 50 μ Sec and offers a choice of four input ranges

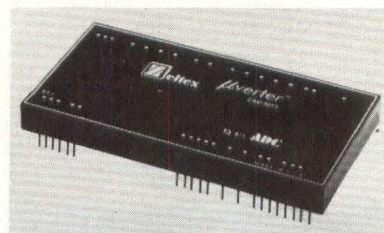

(+10V, +5V, 0 to 5V and 0 to 10V) and three output coding modes (unipolar binary, offset binary or 2's complement). Power required is less than 2.5 watts. Overall case dimensions are 2" x 4" x 0.4". Price: \$248.00 in 100 unit quantities. Zeltex Inc., 940 Detroit Ave., Concord, CA 94518. (415) 686-6660. **Circle 153**

PRODUCTS

GRAPHICS SYSTEM INCLUDES REFRESH MEMORY

The ALT-256**2, a 256 x 256 high resolution graphics device, plugs directly into Altair, Insai or similar S-100 bus computers. The card contains all interface electronics, a TV sync generator and 65,536 x 1 bit

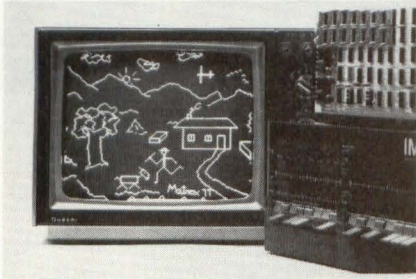

refresh memory. Because of the built-in refresh memory, no CPU time is required to refresh the screen. The composite video signal output connects to any TV monitor or the video portion of a TV set. The ALT-256**2 board occupies a single S-100 bus slot and requires 4 output ports and 1 input port. Multiple ALT-256**2 cards combine to form graphic systems with grey scale or color capability. Price: \$395. Matrox Electronics Systems, P.O. Box 56, Ahuntisic Stn., Montreal, Que. H3L 3N5. (514) 481-6838. **Circle 169**

GRAPHIC DISPLAY SYSTEM USES MODULAR DESIGN

Using modular design so that special configuration requirements can be met, the GMR-26 graphic display system generates displays in a dot-matrix grid consisting of up to 512 horizontal television raster lines, with as many as 512 pixels along each line. Display entities may be positioned at any pixel location on this grid, and each pixel may be individually addressed and altered. Refresh memory channels store all alphanumeric, graphic and image data; these channels are periodically scanned to provide standard video output signals. Only 1.5 μ s are required to access any point on the display; 256x256 resolution 8-bit images can be written into refresh memory in less than 1/10 sec. Prices start at \$5450. Grinnell Systems, 2986 Scott Blvd., Santa Clara, CA 95050. (408) 988-2100. **Circle 203**

DIGITAL PRESSURE TRANSDUCER SIMPLIFIES CONNECTIONS

The 8 bit output from this pressure transducer connects to the 8255 or the 6820 interfaces for 8080 or 6800 systems. Transducer outputs are unclocked and available for sampling at any rate defined by main program control. Power input is +5Vdc or 110Vac with pressures up to 30,000 psi available. Siltran Digital, PO Box 437, Silverado, CA 92676. (714) 649-2704. **Circle 162**

PRINTHEAD MIXES DATA FORMATS

The DM1099 and DM10101 thick film dot matrix thermal printheads permit simultaneous printing of analog, graphic and alphanumeric data. Each printhead contains a single continuous row of printing elements on a pitch of 50 points per inch.

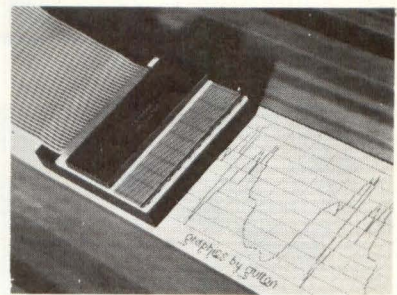

Each dot is composed of two halves printing in parallel. The printing elements are organized into decades for multiplexed operation. Complete diode isolation of each element is provided on the printhead. The DM10101 has 101 dot elements where the 101st dot is for applications requiring both a zero and 100th data point. The DM1099 contains 99 dot elements to be used with the DM10101 for data expansion. Price: \$121.20 each, \$75.75 100-499 quantities. Gulton Industries Inc., 212 Durham Ave., Metuchen, NJ 08840. (201) 548-2800 X201. **Circle 148**

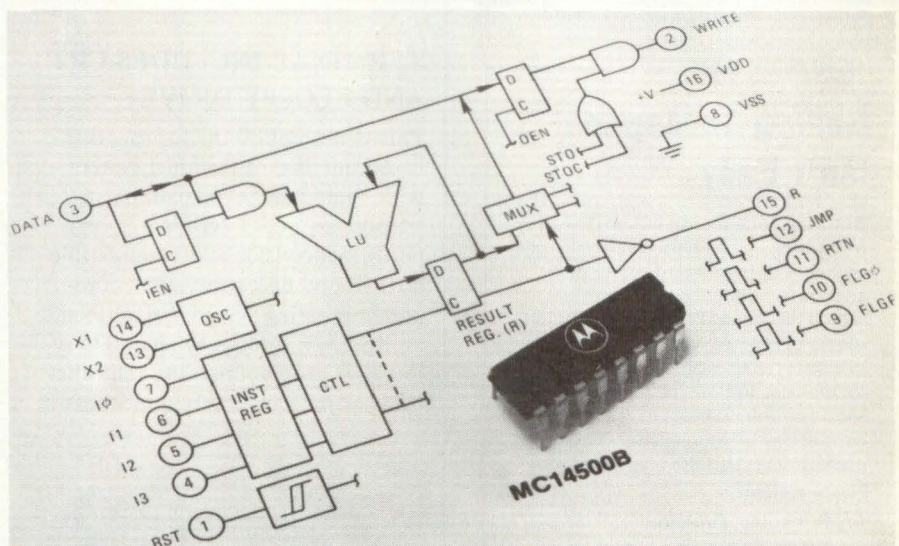

DIGITAL PROCESSING: ONE BIT AT A TIME

A one-bit static CMOS processor, the MC14500B Industrial Control Unit (ICU), performs logical operations on data occurring on a one-bit bidirectional bus and on data in a one-bit accumulating result register within the ICU. The MC14500B operates with a 16-instruction set. ICU applications include traffic controllers, copier controllers, microprogram-control sequencers,

serial bit-stream communications and telephone dialing systems. The ICU incorporates an oscillator circuit on the chip, executes one instruction per clock cycle, operating from DC to 1.0 MHz. The four instruction inputs are TTL-compatible; the outputs can drive one Schottky load or two TTL loads. The circuit is offered in a 16 pin DIP. The 100-999 price is \$7.58. Motorola I.C. Division, 3501 Ed Bluestein Blvd., Austin, TX 78721. (512) 928-2600. **Circle 145**

1500 CPS PAPER TAPE READER MODEL 27

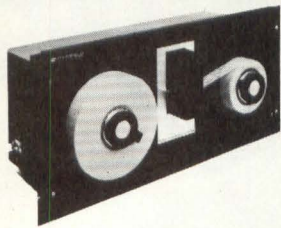

- ... Semiconductor buffer provides 1500 cps stop-on-character
- ... Virtually any tape (up to 80% transmissive)
- ... Extremely low tape wear
- ... Programmable parallel interface

THE PAPER TAPE
PEOPLE:

GNT AUTOMATIC, INC.



440 Totten Pond Road
Waltham, Massachusetts
02154

Tel: (617) 890-3305
CIRCLE 67

Selling To Japan Isn't Easy

But that's one reason Nihon Teksel is in business . . . to help electronics and component manufacturers to plan and implement successful overseas selling programs. We've become a successful representative/distributor in Japan for several leading electronics makers, and maybe we can do the same for you. Selling, purchasing and consulting . . . aggressive, experienced professionals. In Japan and the USA. Please contact:

S. Akutsu, Director
Nihon Teksel Co., Ltd.
Kyoshin Bldg.
13-14 Sakuragaoka-machi
Shibuya-ku
Tokyo 150 Japan
(03) 461-5121

S. Zimmerman, V-pres.
Teksel Inc.
One Padanaram Rd. Suite 118
Danbury, Conn. 06810 USA
(203) 792-4477

TKSOL

Electronics Marketing Services

CIRCLE 68

PRODUCTS

ARRAY PROCESSOR FITS LARGE COMPUTERS

The model AP-190L Array Processor interfaces to major mainframes such as IBM 370, UNIVAC 1100, CDC Cyber Series, and the PDP-10. A typical AP-190L increases the throughput of major mainframe systems by factors up to 20 times, yet sells for less than \$97k, including an extensive software development package and library of more than 150 routines. The AP-190L consists of fast registers, program source memory, data memory, floating-point adder and floating-point multiplier—all interconnected by seven parallel synchronous data buses. A fast (167 ns) instruction cycle and large (up to 1 million 38-bit words) floating-point data memory provides high throughput; thus increasing speed and the ability to conveniently handle batches of data. Floating Point Systems, P.O. Box 23489, Portland, OR 97223. (503) 641-3151. **Circle 204**

TERMINAL INCLUDES CRT AND FLOPPY DRIVE

This Omron 8080 microprocessor-based, intelligent terminal system with "stand-alone" capability incorporates a CRT terminal, a high performance IBM 3740-compatible dual floppy disk subsystem, complete operating system software and an RS-232C interface. The 8035 offers user programmability; all functions of the system are under soft-

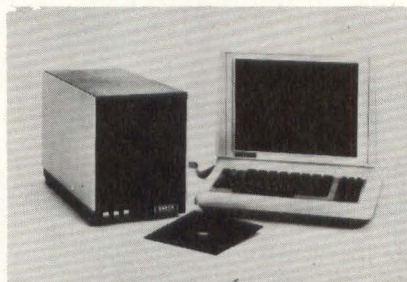

ware control. Dual-drive floppy disk subsystem for auxiliary data storage and generation of a program library provide up to 4 Mbits of memory. In communication applications, the 8035 system operates up to 9600 baud. Price: \$7,200.00. B.J. Johnson & Associates, 2503 Eastbluff Dr., Suite 203, Newport Beach, CA 92660. (714) 644-6037. **Circle 166**

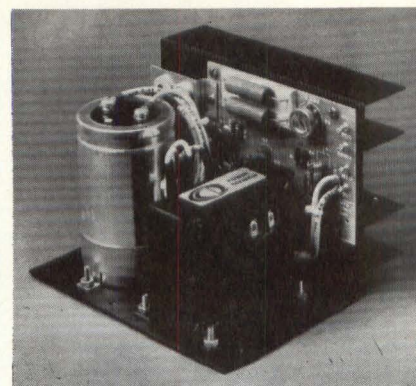

POWER SUPPLY HAS FEWER COMPONENTS

The LN series 60 watt open frame power supply, designed for the OEM market, includes complete short circuit protection by automatic fold-back limitation, integrated circuit regulation, high MTBF, fewer components, all American made parts and the availability of a five year limited warranty. Price: \$61.00 each. Control and Computing Devices, 3130 Benton, Garland, TX 75042. (214) 272-6435. **Circle 177**

μP TO SCIENTIFIC CALCULATOR INTERFACE IN KIT

This interface board utilizes hardware for mathematical calculations, employing a scientific calculator circuit for use by 8080, Z-80, 6800 and other microprocessor systems. The interface, to a powerful scientific calculator chip, the 7529-103, makes basic and complex math functions possible with simple software. 1K of memory suffices for interpreter or compiler calculations usually requiring 8K to 16K. The board avails the user of the functions of a 40-key scientific calculator including trig functions, inverse trig, logarithms, anti-logarithms, exponentiation and factorials. Two versions of the board are available: the RM Series matches the Motorola Exerciser bus and adapts to an Intel SBC 80/10 system, another version has an S-100 standard bus. The power requirements using CMOS and 74LS IC's: ½A at +5V and 30 MILS at +12V. Available in kit form at \$99.95. Mini Micro Mart, 1618 James St., Syracuse, NY 13204. (315) 422-4467. **Circle 146**

ADD-IN MEMORY FITS LSI-11

The LS-IN-11, a semiconductor add-in memory for the DEC LSI-11 and PDP 11/03 microcomputers provides 8, 16, 24, or 32K of memory on a card, using 8K or 16K dynamic MOS N-channel chips. The LS-IN-11 uses a 2-wide connector which plugs into a single chassis slot position. Card size is 8.5"H x 5.187"W x .375"T. Memory segments are switch-selectable from 0-32K in 4K increments. Fabri-Tek Inc., 5901 South Country Rd. 18, Minneapolis, MN 55436. (612) 935-8811.

Circle 155

CONTROL METERS HANDLE TO 4½ DIGITS

4100 Series process control meters are available in 3½, 3-3/4 and 4½ digit models, with analog input accommodating standard and special current or voltage loops. Differ-



ential input is standard with parallel, latched BCD output optional. The meters come in standard NEMA-sized cases and use either .6" LEDs or Beckman displays. Electro Numerics Inc., 1811 Reynolds St., Irvine, CA 92714. (714) 549-8821.

Circle 158

RS-232C INTERFACE FOR SMS ROM SIMULATORS

RS-232C interface plugs into SMS ROM Simulator mainframe allowing direct connection to host computer. Reflected data is provided to users for software verification of transmitted data at user's option. Use of the same data/control format as paper tape reader allows existing software to be utilized with only modification of the output driver. Price: \$970. Analytix Electronic Systems Inc., 106 Daniel Webster Highway South, Nashua, NH 03060.

Circle 167

We've made High Isolation Transformers for years.

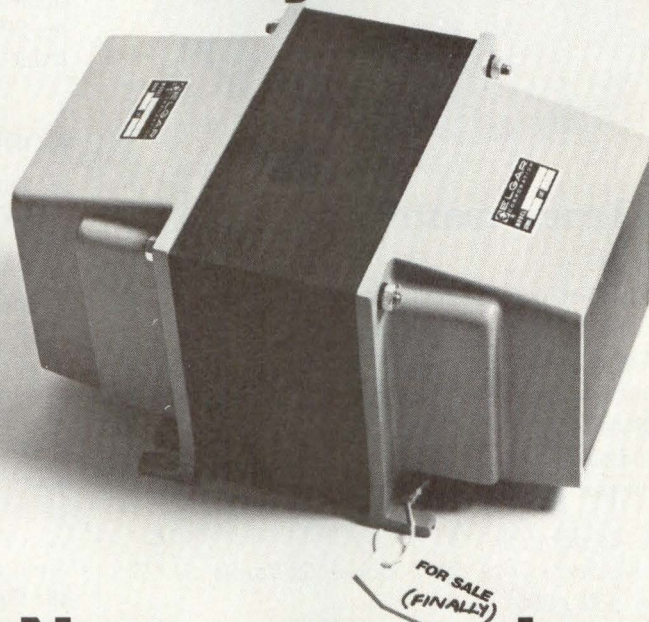

Now we're going to sell some.

Since 1965, we've been making High Isolation Transformers to a set of rigid specifications for one customer: Elgar. If you've ever bought an Elgar line conditioner, you've bought an Elgar High Isolation Transformer (HIT).

But now, you don't have to buy a whole Line Conditioner just to eliminate the noise and spikes from your AC power line. You can order one of our new line of HITs. They come in ratings from 1 KVA single phase to 60 KVA three phase with effective interwinding capacitance as low as .0005pF, providing up to 146dB attenuation of common mode noise.

All HIT models can be wired for 120VAC or 240VAC input or output (240 or 480VAC on the larger models), for use as a combination stepdown transformer and noise isolation device. They are rated for either 50 or 60Hz operation and are designed to UL specifications.

If you'd like to know more about our High Isolation Transformers, contact us. We've been using them for years. Elgar Corporation, 8225 Mercury Ct., San Diego, California 92111.

Phone (714) 565-1155.

ELGAR

Elgar also is a leading manufacturer of Uninterruptible Power Systems, AC Line Conditioners, and AC Power Sources.

See us at Wescon, Booths 1150/52

CIRCLE 69

MODEL 612



Paper Tape Transmitter

50-9600 baud
RS 232 / Current loop or parallel outputs available
5-8 level tape, 7-11 frames per character
Stops and starts on character at all speeds
Uses manual control or x-on, x-off
90-260 volt, 50-60 Hz power
Even or odd parity
Desk top or rack mount

Addmaster Corporation
416 Junipero Serra Drive San Gabriel, California 91776
Telephone: (213) 285-1121

CIRCLE 70

own your own byline

Our editors are always looking for articles of interest to design engineers. If you have a manuscript to submit for publication, send it to Editor, DIGITAL DESIGN, 167 Corey Rd., Brookline, MA 02146. You'll get a prompt reply, and if we accept your article, exposure to more than 51,000 of your colleagues.

If writing is not your forte and you have something of interest for our readers, why not let us work with you in organizing your material for publication. Just drop a note to the Associate Editor Jeff Spierer or call (617) 232-5470.

Digital Design
The Magazine of Digital Systems

PRODUCTS

BINARY COUNTERS OPERATE FROM DC TO 600 MHZ

The SP8735B and SP8736B high speed counters with ± 8 circuits and binary outputs, operate from dc to 600 Mhz, respectively. Both devices accept input from 400 to 800 mV, gate to their maximum operating frequencies and dissipate 450 mW. Price: \$22.50 for the SP8735B, \$16.00 for the SP8736B. Plessey Semiconductors, 1641 Kaiser Ave., Irvine, CA 92714. (714) 540-9979.

Circle 150

MODEM USERS CAN PURCHASE DAA'S

Modem users can now purchase Data Access Arrangements (DAA's) instead of renting them from the telephone company. The DAA's have been designed to meet or exceed the direct connect registration requirements of FCC Rule 68. Connecting to either the Bell type 97A Universal Data Jack (RJ41S) or the type 97B programmable data jack (RJ45S), the DAA includes a transmit level control circuit that continuously monitors the modem's output level. All circuitry mounts on a 6-3/8" x 13" p.c. board and the front end card-edge connector plugs into the chassis motherboard. The rear end of the PCB provides a hardwired connector cable, a plug-in connector and the line output indicator for each DAA channel. The hardwired connector provides the 8-pin data jack interface and the plug-in connector accepts the 9-pin modem interface cable. Price: VA851 single channel \$135, VA852 dual channel \$215. Vadic, 505 Middlefield Rd., Mountain View, CA 94043. (415) 965-1620.

Circle 147

16K ROM WITH PROGRAMMER FITS PDP-11

The RMP-116 combines an EPROM programming facility with a read-only memory on one PDP-11 small peripheral board. The system based upon Intel 2716 UV erasable PROM or its masked equivalent (2316) ROM, accommodates 16,384 16-bit words on each board. The system may be expanded to include a "solid-state software" library or data. 16 EPROMs load onto the board and program while in place: two independent addressing modes, direct and indirect, read from memory. RMP-116 costs \$895. Digital Pathways Inc., 4151 Middlefield Rd., Palo Alto, CA 94306. (415) 493-5544.

Circle 168

BOOTSTRAP FOR DEC DISKETTE SYSTEM

A hardware bootstrap for the DSD 210 DEC compatible floppy disk system allows PDP-11 or LSI-11 users to load RT-11 from the diskette unit with a single command. The bootstrap instruction sequence is contained on a PROM, part of the DSD 210 interface. This saves the cost and back-plane slot of the REV-11 board for LSI-11 users and it can reduce start-up time on the PDP-11. The controller, power supplies, and up to three diskette drives come packaged as a complete unit which can be used with LSI-11, PDP-11 or PDP-8 minicomputers simply by changing interfaces. DSD 210 price is \$1000. Data Systems Design Inc., 3130 Coronado Dr., Santa Clara, CA 95051. (408) 249-9353

Circle 172

REALTIME MPU LOGIC ANALYZER

Yuccalyzer Model YA-20, a real time, non-interfering analyzer, comes equipped with probe and data display, using 8-bit data bus structured 6800 and 8080 type uP's. Up to 128 30-bit data words can be trapped and stored at any address, data or user input in the program.

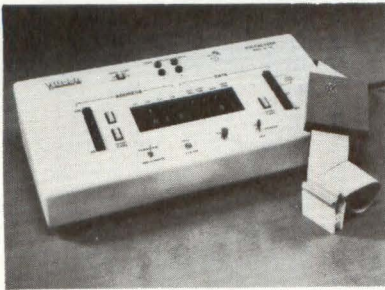

YA-20's selective trapping permits 'write only' selection and VMA selection for 6800 μ P's - DBI for 8080's. Instructions can be read a data word at a time (32 words back - 96 words ahead) on hexadecimal LED displays. Trigger can be generated by an address on the bus, by a selected data word, by any combination of address, data or external inputs, or by an external trigger. A clip-on probe for either 6800 or 8080 μ P's has a 10 megohm impedance. Yuccalyzer YA-20 cabinet measures 18" x 9" x 4", and runs on 115Vac. Price with probe is \$875. Yucca International Inc., 14415 North Scottsdale Rd., Scottsdale, AZ 85260. (602) 991-1491.

Circle 154

SOLID-STATE MEMORY FITS PDP-8

The VM816 semiconductor memory system plugs directly into the DEC PDP-8 Omnibus chassis and packs up to 16K of memory per slot. The memory system is software compatible with all standard PDP-8 operating systems and comes in four models: 4K x 12, 8K x 12, 12K x 12, and 16K x 12. The 4096 x 1 NMOS STATIC RAM design uses 3.1A @ +5Vdc per 16K of memory. A field select DIP switch allows memory field assignment for each 4K increment. Computer Extension Systems Inc., 17311 El Camino Real, #176, Houston, TX 77058. (713) 488-8830.

Circle 165

The Perfect Cover-Up!!!

For The Computer Designer and Builder

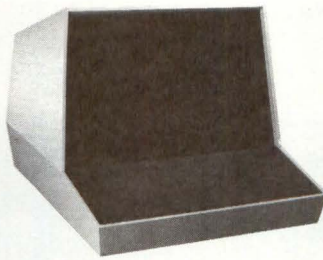

VTE 101
TERMINAL ENCLOSURE
\$78.95

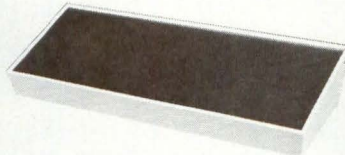

KBE 101
KEYBOARD ENCLOSURE
\$24.95

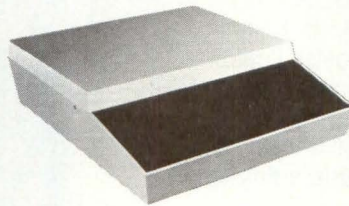

TVT 101
TYPEWRITER ENCLOSURE
\$47.95

... AND THESE FEATURES ARE STANDARD:

- High Impact Structural Plastic Construction
- Flame Retardant
- Attractive Professional Appearance
- Easily Machinable Using Ordinary Woodworking Tools
- Highly Adaptable to Your Needs
- Ribs & Bosses for Component Mounting
- Molded Ventilation Grills
- Removable Keyboard Mounting Plate
- Available Unfinished or in Three Standard Colors

Inquire about special designs

Enclosure Dynamics Products Are Distributed Worldwide By:

CALIFORNIA

Byte Shop Computer
Store of Diablo Valley
2989 North Main Street
Walnut Creek, CA 94596
415-933-6252

Computer Land
22634 Foothill Blvd.
Hayward, CA 94542
415-538-8080

Computer Land
of West L.A.
6840 La Cienega Blvd.
Englewood, CA 90302
213-776-8080

Computer Playground
6789 Westminster Ave.
Westminster, CA 92683
714-898-8330

COLORADO

Byte Shop
2040 30th Street
Boulder, CO 80301
303-449-6233

Byte Shop
3464 So. Acoma St.
Englewood, CO 80110
303-761-6232

Gateway Electronics
2839 West 44th Ave.
Denver, CO 80211
303-458-5444

Miti-Mini Computer Co.
621 So. Broadway
Denver, CO 80209

FLORIDA

Microcomputer Systems
144 So. Dale Mabry Hwy.
Tampa, FL 33609
813-879-4301

ILLINOIS

American Microprocessors
Equipment & Supply Corp.
20 North Milwaukee Ave.
Prairieview, ILL 60069
312-634-0076

Bits N Bytes
Computer Store
2928 West 147th St.
Posen, ILL 60469
312-389-7112

Lillipute Computer Mart
4446 Oakton St.
Skokie, ILL 60076
312-674-1383

INDIANA

The Computer Mart
of Indiana
901 Strong Ave.
Elkhart, IN 46514
219-293-7378

IOWA

Micro Bus, Inc.
1910 Mt. Vernon Rd. S.E.
Cedar Rapids, Iowa 52403
319-364-5075

KENTUCKY

Computer Land
of Louisville
813 B Lyndon Lane
Louisville, KY 40222
502-425-8308

MARYLAND

Computer Land
of Rockville
16065 Frederick Rd.
Rt. # 355
Rockville, Maryland 20850
301-948-7676

MASSACHUSETTS

Computer Mart, Inc.
1097 Lexington St.
Waltham, MA 02154
617-899-4540

Microtec
23 Hamburg St.
Springfield, MA 01107
413-734-3818

MICHIGAN

Compumart, Inc.
1250 North Main
Ann Arbor, MI 48103
313-994-4445

MINNESOTA

Microprogramming, Inc.
12033 Riverwood Drive
Burnsville, Minn. 55337
218-894-3510

MISSOURI

Gateway Electronics
8123 Page Blvd
St. Louis, MO 33130
314-427-6116

MONTANA

Computers Made Easy
415 Morrow
Bozeman, MT 59715
406-586-3065

NEW JERSEY

Computer Land
of Morristown
2 De Hard St.
Morristown, NJ 07960
201-539-4077

William Electronics Supply
1863 Woodbridge Ave.
Edison, NJ 08817
201-985-3700

NEW YORK

Computer Land
of Tonawanda
1612 Niagara Falls Blvd.
Tonawanda, NY 14150
716-836-6511

Computer Mart
of New York
118 Madison Ave.
New York, NY 10016
212-686-7923

Computer Microsystems
1309 Northern Blvd.
Manhasset, NY 11030
516-627-3640

The Computer Shoppe
444 Middle Country Rd.
Middle Island, NY 11953
516-732-4446

PENNSYLVANIA

Lectro-Media, Ltd.
New Market-Front & Pine
Philadelphia, PA 19105
215-925-4477
800-523-2906

TEXAS

The Micro Store
634 So. Central Expwy.
Richardson, TX 75080
214-231-1096

UTAH, NEVADA, IDAHO

The Computer Room
3455 So. West Temple
Salt Lake City, Utah 84115
801-486-4311

FOREIGN DISTRIBUTORS

ENGLAND

West Hyde
Developments, Ltd.
Ryefield Crescent
Northwood, Middlesex
England HA6 1NN

GERMANY

Datameg KG
D 8011 Putzbrunn
Munich, Germany
4-60-49-93

AUSTRALIA

Digital Electronics
Pty. Ltd.
4/29 Hotham PDE
Artarmon, N.S.W.
Australia
438-2444

ENCLOSURE DYNAMICS, Inc.
P.O. Box 6276
Bridgewater, New Jersey 08807
201-725-7982

CIRCLE 72

PRODUCTS

LED INDICATORS MOUNT ON PC BOARDS

These light emitting diodes for logic state and fault indication in black plastic packages mount on printed circuit boards. The 547 and 555 Series indicators can be driven directly from TTL and DTL logic circuits. Standard ratings range from 3 to 20mA and 3.6 to 14Vdc. Less than

0.1"W x 0.3"H, these units mount as closely as ten per inch for logic state and fault indication, binary data display and similar applications. The 550 Series for PC or panel mounting come in a package configuration nominally 0.25 x 0.25 x 0.36 in., with or without an integral resistor. Prices start at \$0.39. Dialight, 203 Harrison Pl., Brooklyn, NY 11237. **Circle 156**

MODEM TRANSMITS AT SPEEDS UP TO 56Kbps

The 263A Wire Line Modem transmits and receives digital data over a non-loaded metallic loop at rates of 2.4, 4.8, 9.6 or 56 Kbps. It operates in a full-duplex or half-duplex



mode with 4-wire loops and in a simplex mode with 2-wire loops. 2.4, 4.8, and 9.6 Kbps arrangements conform to EIA interface specifications RS-232-C and RS-334. For the 56 Kbps unit, clock and data signals meet CCITT Recommendation V.35, with control signals conforming to RS-232-C. The unit's internal clock provides transmitter signal element timing. A buffer allows received data to be clocked out into synchronous networks for data multiplex applications. The wire line modem is equipped with automatic line build-out facilities with an equalization range of 0 to -34 dB. Extensive built-in test functions include remote loopback, digital loopback and analog loopback. GTE Lenkurt Inc., 1105 County Rd., San Carlos, CA 94070. (415) 591-8461.

Circle 174

THREE MICROCOMPUTER BOARDS EXPAND CAPABILITIES

The Z80-VDB video display board, with 256 bytes of dynamic RAM for line buffering to the MCB, interfaces the Z80-MCB directly to TTL horizontal, vertical and video drives of a standard TV monitor. Providing programmable control of up to 64 I/O lines, the Z80-IOB includes four Z80-PIO parallel interface controllers. The Z80-SIB Serial I/O board with two onboard Z80-CRT programmable timers provides eight serial (four full duplex) channels, each capable of synchronous or asynchronous data transmission including Bi-Sync protocol. Prices: Z80-VCB \$475, Z80-IOB \$350, Z80-SIB \$375. Zilog, 10460 Bubb Rd., Cupertino, CA 95014. (408) 446-4666. **Circle 160**

POSITION SCALES CODE DISCS APERTURE PLATES in glass, plastics & metals

for use in DISK DRIVES, TAPE TRANSPORTS, PRINTERS,
PLOTTERS, CARD READERS, TAPE READERS,
FACSIMILE EQUIPMENT, PHASE-LOCK SERVOS

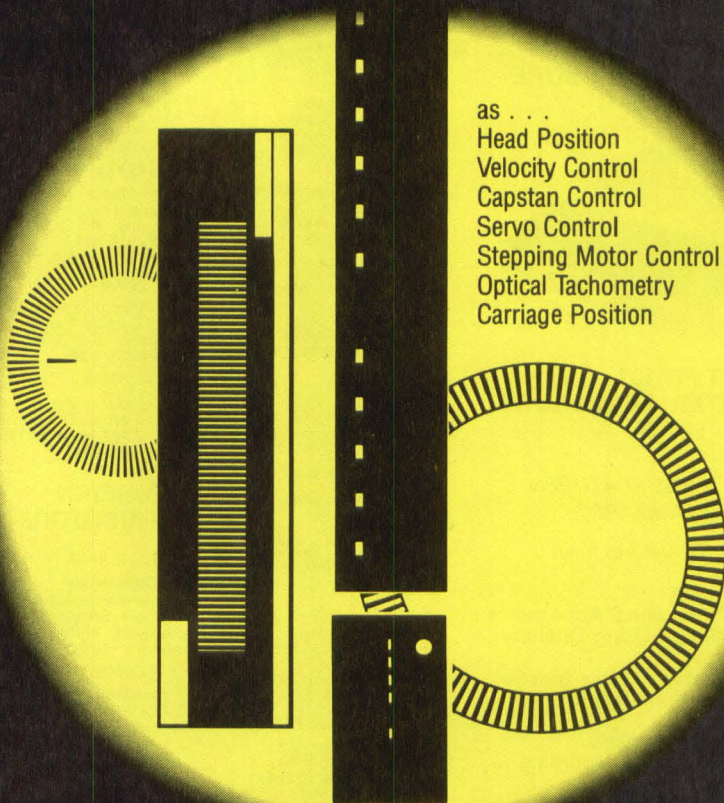

as . . .
Head Position
Velocity Control
Capstan Control
Servo Control
Stepping Motor Control
Optical Tachometry
Carriage Position

Ask about our New .006" thick METRIFILM GLASS DISCS . . . combine the low cost and weight of plastic, film or thin metals with the high performance of glass.

METRIGRAPHICS DIVISION
DYNAMICS RESEARCH CORPORATION

50 Concord Street · Wilmington, Mass. 01887 · 617/438-3900

control thru measurement



CHARACTER GENERATOR DRAWS SPACE SHIPS

This programmable character generator for S-100 bus computers adds the ability to dynamically create the characters generated by a video display device. For those who require special mathematical or scientific symbols such as APL characters, sub- and superscripts, high density bar graphs, Greek letters or game characters such as space ships, the device creates and stores new characters while the original character set remains intact and available for use. Keyboard interface and dual joystick interfaces are provided on the board. Objective Design Inc., P.O. Box 20325, Tallahassee, FL 32304. **Circle 170**

RATECHANGER CONNECTS DDS TO ANALOG CIRCUITS

The 50/56 Kbit Ratechanger permits tandem interconnection of DDS circuits operating at 56K bits per second and analog wideband circuits operating at 50K bits per second with Bell 303 modems or equiv-

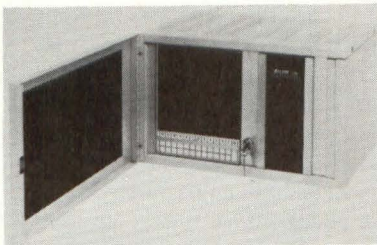

alent. The same hardware used in the Ratechanger permits rate changing between any two of the commonly used wideband data transmission speeds (i.e. 40.8, 48, 50, 56 Kbps). Price: in pairs, \$2040 per end. Micom Systems Inc., 9551 Iroindale Ave., Chatsworth, CA 91311. (213) 882-6890. **Circle 152**

EXPANDER CREATES 16 BIT ANALYZER PACKAGE

The Model 10 Trigger Expander mates with the 8-bit Paratronics Model 100A to form an integrated 24 bit logic analyzer package for microprocessor troubleshooting training and system development applications, or functions stand-alone as a 16-bit "word recognizer," providing a programmable sync pulse for

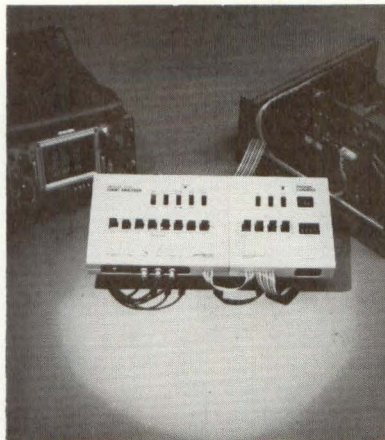

scope triggering at (or delayed from) the occurrence of a particular machine state. Besides expanding the triggering capability of the Model 100A from 8 bits to 24 bits, the Model 10 utilizes a multiplexing scheme which permits an 8-bit x 16-word deep truth table display of the microprocessor's data byte. Paratronics Inc., 800 Charcot Ave., San Jose, CA 95131. (408) 263-2252. **Circle 138**

INEXPENSIVE PANEL METERS RUNS DC OR AC

The Series B500 contains one IC, 7 passive components and the display. The bipolar differential unit is auto-zeroing and accepts 200mV to 1000V input; it operates from either 5Vdc or 115/230Vac, 47-400Hz, and consumes 200 to 800 mW. The display is .5" high L.E.D. red. Price: \$59 each; \$39 in 100 quantities. International Microtronics Corp., 4016 E. Tennessee St., Tucson, AZ 85714. (602) 748-7900. **Circle 159**

8-CHANNEL MULTIPLEXER INTERFACES DG MINIS

A multiport communications interface for Data General and Data General emulating minicomputers is available in either a four or eight channel configuration. Each board has all necessary control logic on a single 15" by 15" printed circuit board that inserts into the minicomputer. Data format and baud rate are jumper selectable on an individual channel basis. Prices start at \$1250. Custom Systems Inc., 2415 Annapolis La., Minneapolis, MN 55441. (612) 553-1112. **Circle 133**

RK-II/RK-05 MEDIA CARTRIDGE

fully DEC compatible

The AED 2200 hard disk subsystem offers complete compatibility with all RK-11/RK-05, and associated DEC software. Plugging directly onto the PDP-11 Unibus[®], the 2200 Controller can handle up to 4 drives, providing 4,915,200 16-bit words of economical storage. The AED 2200 subsystem is supplied with Diablo Series 30 or similar type disk drives, and is available immediately on a 30-60 day delivery basis. Check our competitive prices below.



Compare these features

- Direct substitute for RK-11/RK-05 System
 - Complete DEC media/software compatibility
 - A 2-drive power supply is included with controller
 - Complete with Unibus[®] and controller-to-drive cables
- ® Reg. Trademark of Digital Equipment Corp.

Compare these prices

Quantity 11 with 1 drive (2.5 Mbytes): \$7,255
Quantity 11 with 1 drive (5.0 Mbytes): \$8,110
Quantity 11 with 2 drives (10 Mbytes): \$13,060
Quantity 11 with 4 drives (20 Mbytes): \$22,960

Advanced Electronics Design
P.O. Box 61779, Sunnyvale, California 94088
Telex: 357 498 Cable: Disksystem

call
Disk City
PHONE 408-733-3555

PRODUCTS

DRIVERS WORK WITH CORE, BUBBLE MEMORIES

Two quadruple memory driver ICs have TTL compatible logic inputs and are designed for use with core and bubble memories. The SN75328 and SN75330 each contain four 600mA memory drivers and operate from two power supplies — one of 5V, the other from 4.75 to 24 V.

The SN75328 driver comes in 16-pin, dual-in-line plastic or ceramic packages; the SN75330 driver comes in 20-pin, dual-in-line plastic package. Prices in quantities of 100: SN75328, \$2.47 plastic; \$3.20 ceramic; SN75330, \$3.20 plastic. Texas Instruments, P.O. Box 5012, Dallas, TX 75222. (214) 238-2481.

Circle 130

RESPNSYN[®]

fine angle stepping motors

- Excellent Position Control
- High Transient Performance
- Low System Cost

□ Fine Step Angle — RESPNSYN motors are fine-angle, high-resolution stepping motors. They offer step angles from 0.75° to 0.18° and resolution from 480 to 2000 steps per revolution.

□ High Accuracy — RESPNSYN design ensures accurate stepping via a positive spline coupling between stator and rotor. For example, the HDM 155 motor's maximum one-step error is ±4 arc minutes, non-accumulative.

□ Low Overshoot — The RESPNSYN motor has a single-step crossover time on the order of one millisecond and an overshoot of approximately 40% of one step. Consequently, the RESPNSYN motor rapidly positions a load in a corridor only a few arc minutes wide.

□ Excellent Settling Time — The short settling time of RESPNSYN motors, as little as three or four milliseconds, makes them well suited to critical applications. Fast settling as well as low overshoot are accomplished without elaborate and expensive electronic drives.

□ High Start/Stop Rate — RESPNSYN motors handle load inertia at high start/stop rates.

□ Low System Cost — RESPNSYN performance and efficient design result in lower total system costs. RESPNSYN motors eliminate the added expense of sophisticated electronic drives, gearing, and damping devices.

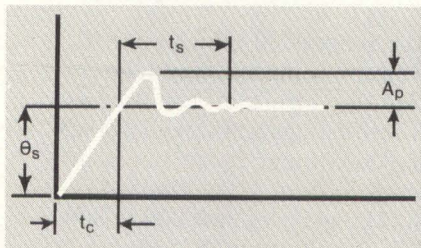

Transient Characteristics

Typical values for the HDM-155-800-4 RESPNSYN[®] motor are:

Crossover Time (tc)	— 1.2 milliseconds
Settling Time (ts)	— 6.3 milliseconds
Overshoot (Ap)	— 40 percent
Step Angle (θs)	— .45 degree



Circle Reader Service Number or Write for Free Brochure Today.



Harmonic Drive Division

51 Armory Street, Wakefield, Massachusetts 01880
Tel: (617) 245-7802 TWX 710-348-0586 Telex 94-9442

USM Corporation

CIRCLE 75

RECEIVER USES FIBER OPTICS TECHNOLOGY

Designed for optical communications and data transmission, light collection efficiency is optimized with maximum operating bandwidth with the FOD-100 fiber optics receiver. It has a fiber interface, a receiver area of 5.1 mm², a responsivity greater than 0.65 amperes/watt at 904 nanometers, a spectral range of 350-1100 nm and a rise time (10-

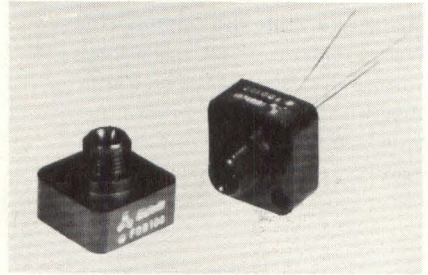

90%) of less than 1 ns. EG&G Inc., 35 Congress St., Salem, MA 01970. (617) 745-3200.

Circle 137

D/A CONVERTER COMES PACKAGED IN DIP

The MN3310 16 Bit Digital to Analog Converter has guaranteed monotonicity better than 14 bits over 0 to +70°C operating temperature range. The MN3310 consumes 420 mW of power, has a 35 μSec setting time and is packaged in a hermetic, 24 pin, dual-in-line package. Typical applications for these converters include precision servo and control systems, high accuracy instrumentation, non-linear function generation and microprocessor system applications. Micro Networks, 324 Clark St., Worcester, MA 01606. (617) 852-5400.

Circle 131

CASSETTE STORES DATA USING AUDIO RECORDERS

The LT-4800 tape cassette, specifically made for digital data storage with audio recorders, contains 150 ft. of tape in a digital-quality cassette enclosure, but has the linear response and high output of top-grade audio tape. Price: \$3.00 each in quantities of 100-up. Digital Laboratories, 600 Pleasant St., Watertown, MA 02172. (617) 924-1680.

Circle 136

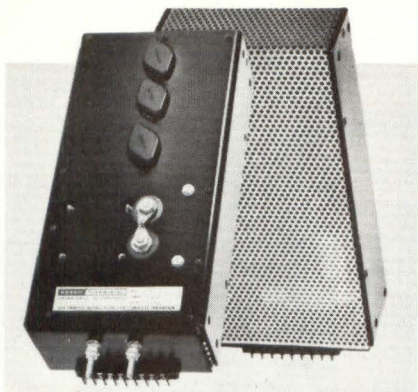

POWER MODULE RUNS AT 80% EFFICIENCY

The DC100 series of high efficiency switching regulated power modules designed specifically for computer and computer peripheral applications in the telecommunications and interconnect industries, run on 41 to 52Vdc. Three units are available with outputs of 5Vdc, ± 12 Vdc and ± 15 Vdc with total power of 100 watts. Line and load regulation is less than 0.5% and peak-to-peak ripple less than 100mV. The power modules include overvoltage protection, short circuit protection, over-temperature shut-down and remote error sensing. Measured efficiency is as high as 80%, and they come packaged in a case 5.5" x 10.5" x 2.5". Price: \$325 each. Abbott Transistor Laboratories Inc., 5200 W. Jefferson Blvd., Los Angeles, CA 90016. (213) 936-8185. **Circle 175**

TERMINAL CONTROLLER PLUGS INTO PDP-11

A plug-in controller that enables the PDP-11 to serve as the intelligence for up to 32 remote CRT stations includes two-monitor capability and a video/data multiplexer allowing keyboard, printer and TV monitor to share a single coax wire. Applications are seen in areas such as banking, text editing and data entry. The CVD-11 consists of a controller card that plugs into a hex slot and two small remote interfaces. The controller card contains all the electronics to support two remote CRT stations, including independent display memories, character generators, TV sync generator, and Unibus® interface. The CRT display is 1920 characters in an 80x24 format. The printer interface is capable of

driving commonly available serial-input character printers at 30 characters per second. Echolab Inc., 213 Middlesex Tpke., Burlington, MA 01803. (617) 273-1512. **Circle 132**

COMMUNICATIONS INTERFACE SERVES μ P BASED EQUIPMENT

Designed for 8-bit microprocessor serial communications, the 2651 PCI MOS/LSI circuit combines the functions of a Universal Synchronous/Asynchronous Receiver/Transmitter (USART) with those of a baud rate generator in a single 28-pin, dual-in-line package. Capabilities of the 2651 include modem control, support of IBM's BISYNC protocol, asynchronous echo mode and local and remote self-testing. Independent double-buffered transmitter and receiver sections permit either half or full-duplex operation. The internal baud rate generator provides 16 different program-selectable baud rates, ranging from 50 to 19.2 Kbits per second, for the transmit and receive clocks. Price is \$13.70 in 100 quantities. Signetics, 811 E. Arques Ave., Sunnyvale, CA 94086. (408) 739-7700. **Circle 135**

CRT TERMINAL INCLUDES MK 3870 MICROCOMPUTER

A CRT terminal built around the MK 3870 single-chip microcomputer, the video adaptor board (VAB-2) forms a complete video terminal when connected to an ASCII keyboard and video monitor. The board offers a screen format of 16 lines of 64 characters (5 x 8 dot matrix), and a ROM character generator for 96 alpha numerics and symbols including lower case letters. Output is EIA composite video; data rates of both 110 and 300 baud are supported with either 20mA current loop or RS-232 interface compatibility. The board fits standard ASCII keyboards (14" x 5") and operates from 5.0Vdc on board power supply. The complete board is priced at \$195. Mos-tek, 1215 W. Crosby Rd., Carrollton, TX 75006. (214) 242-0444.

Circle 129

CIRCLE 76 ▶

8-BIG DISK, 4-CPU μ CONTROLLER for DEC/DGC software

The new AED 8000 mass storage system with micro-programmable controller can be completely integrated into your DEC or Data General system. You can now enjoy patch-free use of any OS changes generated by the mainframe manufacturer, because AED's emulation capability ensures continuous compatibility to standard software. Add to this AED 8000's unique ability to serve up to 4 CPUs per controller at the same time, its built-in Error Correction System, and a multiple-register scroll that displays mainframe register information plus valuable diagnostic data, and you'll see why the AED 8000 is way ahead of the competition. AED's field-proven reliability and fast 45-60 day delivery make the AED 8000 mass storage system a serious contender for your disk dollars.



Compare these features

	AED 8000	DEC DGC
Megabytes per drive	67.4→250	40 92
No. of drives per controller	1→8	8 4
Megabytes per controller	540→2,000	320 368
No. of CPU's per controller	4	1 2
16-bit transfer rate	1.6 μ s	6.4 μ s 2.5 μ s
16-bit buffer	256	6 8
Error Correction Code	by controller	none
Bootstrap	IPL in controller	CPU ROM
Micro-processor	40 ns. 24 bits	none
• Emulates DEC/DGC controller	yes	—
• Macro Instruction Code	yes	none
• Data Scanning & Management	in controller	in CPU
• Variable Sector Length	yes	none
• CPU to CPU transfers	bypass the disk	none via disk

Price: Quantity 1 \$20,250 incl. 67.4 Mbyte drive

Advanced Electronics Design
P.O. Box 61779, Sunnyvale, California 94088
Telax: 357 498 Cable: Disksystem

call
Disk City
PHONE 408-733-3555

PRODUCTS

SPROM INCLUDES POWER-SWITCH CIRCUITRY

The SPROM, a bipolar PROM with built-in power-switch circuitry, fits directly into existing designs without wiring changes and programs with conventional equipment and an adaptor card. Both 256 x 4 and 512 x 4 SPROM's come in either open-collector or tri-state configura-

tions using standard industry pin-outs. Prom power switching allows memory banks not in use to be switched off, for energy savings of up to 90% in open-collector versions and 75% in tri-state versions. A commercial version accesses in 70 ns max. 100-up quantity prices start at \$4.25. Raytheon Semiconductor, 350 Ellis St., Mountain View, CA 94040. (415) 968-9211. **Circle 171**

Put A Fixed-Head Disc Where Your RK05 Is...

Now there's an economical alternative for PDP-11 users who feel restricted by RK05, RF11 or RC11 data storage. With our DC-111 Controller you can reduce access time, while getting fixed-head performance and reliability—all for less than \$8,000.

Installation of the DC-111 Controller is simple. Packaged on three DEC-type "quad" boards, it can be installed as a sub-chassis in the CPU—or be ordered with its own separate chassis.

The DC-111 is transparent to RSX-11 or DOS software, and is unibus-compatible. When used as an RK05 system, it's the only controller available that makes the fixed-head disc "look" like the RK11/RK05 disc system to the CPU. This means you can bootstrap directly from our Model 980 fixed-head disc, just as with an RK05. Similarly, when replacing RF11 or RC11 systems, the DC-111 fixed-head disc system is fully transparent to the DEC fixed-head software.

With an 8.5-ms average access time at transfer rates up to 8.4 Mbits/sec, the fast Model 980 system features our interchangeable Disc Cell™—a unique fixed-

head disc cartridge containing spindle, Winchester-type media, and read/write head assemblies. The Model 980 provides storage from 0.5 to 4.0 Mbytes, (larger capacities by daisy-chaining).

We make a fixed-head disc controller for Data General users, too. Transparent to RDOS software, our DC-100 Controller slides into a circuit board slot in the CPU for quick and easy installation.

Seismic, Process Control, POS, Data Processing—whatever application you have in mind, you can count on us for fixed-head storage systems that are priced commercially, but built to meet military environmental specifications. For prices and technical details on any of our products, circle the R.S. number or call us at (408) 732-7070 in the West, (516) 487-2232 in the East.



DATAFLUX
1050 Stewart Dr., Sunnyvale, CA 94086

CIRCLE 77

DIGITAL SCAN CONVERTER INCORPORATES MOS MEMORY

A solid state graphic memory providing digital storage and multi-channel display capability, the Model 300 YT Graphic Memory accepts analog signals, converts them to digital form and stores them in MOS memory for continuous television display or video recording. This model accepts up to thirteen inputs simultaneously, plots signals against an internal time base and permits selection of one or any combination of

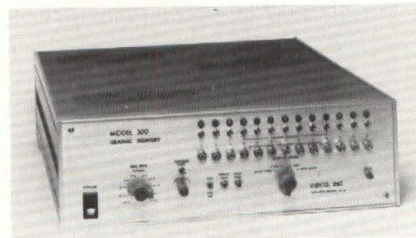

the thirteen inputs for immediate display via front panel switches. The Model 300 YT Graphic Memory is expected to have broad use in the medical, research and scientific fields. Vidco Inc., P.O. Box 25452, Portland, OR 97225. (503) 292-4104. **Circle 140**

FIRST 16-SEGMENT DISPLAYS OFFERED BY HEWLETT-PACKARD

HDSP-6504 and HDSP-6508 four- and eight-character light-emitting-diode (LED) alphanumeric displays have a 16-segment font plus centered decimal point and colon and offer complete 64 character ASCII set capability. The red LEDs are magnified by an internal lens that enhances character intensity while

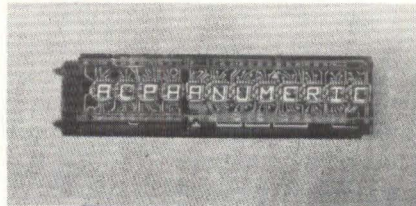

keeping power use at a minimum. Price: \$19.00 each for HDSP-6504 and \$38.00 each for HDSP-6508 in 100 quantities. Hewlett-Packard, 1501 Page Mill Rd., Palo Alto, CA 94304. (415) 493-1501. **Circle 139**

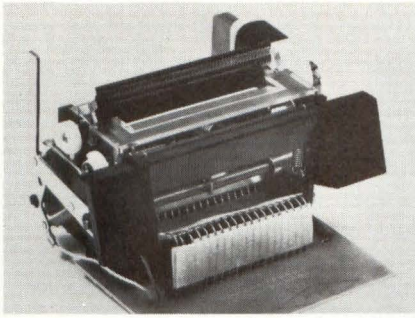

THERMAL PRINTHEAD HAS 14 COLUMN CAPACITY

A 14 column 5 x 7 matrix alphanumeric thermo printhead, the Facit 4506 can be readily incorporated into calculators, cash registers, measuring or data logging systems. The 4506 has a 14 column capacity, character spacing of 3.1 mm, line spacing of 4.5 mm and a printing speed of 2 lines per second. The unit uses the thermal principle for printing on temperature sensitive paper. The only moving part is the line-feed solenoid. Facit-Addo Inc., 66 Field Point Rd., Greenwich, CT 06830. (203) 622-9150. **Circle 141**

16K STATIC RAM BOARD AVAILABLE IN KIT

The MB-7 16K static RAM board allows for system expansion beyond 64K, operates on low power and is fully-buffered. Automatic memory unprotect and protect features allow users to protect memory in 4K block segments with automatic unprotect at power-on. Price is \$525.00 in kit form and \$625.00 fully-assembled and tested. Solid State Music, 2102A Walsh Ave., Santa Clara, CA 95050. (408) 246-2707. **Circle 126**

INTERFACE HAS SELECTABLE BAUD RATE

The 2031 Series asynchronous line interfaces interface a CRT or Teletype® at any baud rate using a single interface card. Baud rates, address selection and operating mode are all DIP switch selectable. EIA Voltage level or current loop are selectable with a cable connector. The

Model 2031-01 replaces DECTM Models DL11-A and C 20 mA current loop operation only. Baud rates vary from 75 to 9600. Price: Model 2031-01 is \$525, Model 2031-02 is \$575. Gen/Comp Inc., 6 Algonquin Rd., Canton, MA 02021. (617) 828-2008. **Circle 163**

MONOCHIP DESIGN KIT

This IC design kit, the MO-K, contains the information necessary to design linear or digital custom circuits. The kit contains a 212-page handbook with sections on component parameters, computer analysis, pre-designed functional blocks, IC layout and chip selection. As an introduction, the kit contains an audio cassette with a 30-minute overview of IC design. The kit also contains 20 dual-in-line kit parts for breadboarding and several design tools. Price: \$59. Interdesign Inc., 1255 Reamwood Ave., Sunnyvale, CA 94086. (408) 734-8666. **Circle 173**

IRIS

The foremost business operating system for NOVA* type minicomputers

*New Features: BUFFER POOLING
PARTITIONING*



Educational Data Systems

1682 Langley Ave. • Irvine, California 92714 • (714) 556-4242

PRODUCTS

PROGRAMMABLE SONIC DIGITIZER PERFORMS MATH FUNCTIONS

The Model NT-503 programmable sonic digitizer performs mathematical functions which previously required hand calculation or external data processing equipment. The unit incorporates a GP-3 bus allowing any Graf/Pen™ GP-3 interface to

be used with it. Model NT-503 requires two point sensors above the work area, allowing interaction with

a variety of inputs, such as CRT or plasma displays, projected images and maps or drawings on drafting tables. Price: \$5,500. Science Accessories Corp., 970 Kings Highway West, Southport, CT 06490. (203) 225-1526. **Circle 127**

MODEL 1900 LSI-11 TO UNIBUS TRANSLATOR

The Model 1900 bus translator allows LSI-11 peripherals to operate with a Unibus CPU (any of the PDP-11 series). The Model 1900 inserts directly into the Unibus; it consists of a quad size board (8½" x 10") that plugs into the C-D-E-F positions of any of the four slots of a DEC DD11A system unit. Adac Corp., 15 Cummings Park, Woburn, MA 01801. (617) 935-6668. **Circle 144**

WHAT COSTS \$59 AND MAKES YOU A COLLEAGUE OF THE FINEST I.C. DESIGNERS IN AMERICA?



THE NEW MONOCHIP DESIGN KIT

The Monochip Design Kit has become a vital tool for progressive electronic engineers. It teaches you fast and easy ways to convert discrete digital or linear circuits to economical, high reliability IC's.

For \$59, you receive an easy to follow design text, more than 100 predesigned circuits, a set of breadboard parts, and a variety of handy design tools. It's everything you need to design your own sophisticated IC.

And it gives you access to one of the largest IC design groups in the world. Powerful advice, free of charge.

Don't procrastinate. Return your coupon today or, better yet, call in your purchase order.

Please ship _____ MO-K Design Kits @ 59.00 (Ca res. add 6½% sales tax) DD

Date _____ P.O. Number _____

Name _____

Company _____ Dept. _____

Address _____

City, State, Zip _____

Phone _____

interdesign

P.O. Box 7065 1225 Reamwood Ave. Sunnyvale, CA 94086 (408) 734-8666

SWITCHING SUPPLIES SERVE COMMUNICATION APPLICATIONS

Designed specifically for computer and computer peripheral applications in the telecommunications and interconnect industries, the DC50 series of switching regulated power supplies are available with outputs of 5Vdc, ±12Vdc and ±15Vdc with total power of 50 watts. Line and load regulation is less than 5% and peak-to-peak ripple is less than 100mV. Other devices in this line include 100 and 150 watt units. Package size is 5.5"x9.4"x2.0". Price: \$310. Abbott Transistor Laboratories, 5200 W. Jackson Blvd., Los Angeles, CA 90016. (213) 936-8185.

Circle 142

MICROCOMPUTER BASED VIDEO TERMINAL BOARD FITS S-100

A video terminal board, designed around the Mostek 3870 microcomputer, fits S-100 systems, but also stands alone. The SCT-100 includes both ASCII and BAUDOT serial interfaces, full X-Y cursor control (both absolute and relative), screen clear, clear to end of line, page mode and autscroll, 96 displayable characters, 16 line by 64 character display and multiple baud rates up to 300 baud ASCII. In S-100 systems the SCT-100 may be powered from the unregulated +7 Vdc bus. Stand-alone, the board runs directly from an external 6.3Vac, 1.0A transformer. The board is available as a kit or fully assembled. Vectron, P.O. Box #20887, Dallas, TX 75220. (214) 350-5291. **Circle 151**

CONVERTERS HAVE 8 BIT RESOLUTION

The ADC541 Series analog-to-digital converters include 8 bit resolution with 10 μ s conversion time using 700 mW from standard $\pm 15V$ and +5Vdc power supplies. All models come sealed in a 24-pin DIP package with a thin-film DAC, clock, comparator, reference and register. All models pin-connect externally for 3 unipolar and 3 bipolar input ranges. Output coding in the bipolar mode is user selectable as either offset binary or 2's complement codes. Applications include data transmission, transducer digitizing and infinite sample and holds. Price each: ADC541-8 \$107.00; ADC541C-8 \$114.00; ADC541B-8 \$124.00. Hybrid Systems Corp., Crosby Dr., Bedford, MA 01730. (617) 275-1570. **Circle 149**

SINGLE BOARD HOLDS DIGITAL AND ANALOG COMPONENTS

Incorporating four independent power planes, each one bussed to all 264 pad positions, the UMB universal printed board allows both analog and digital components to be used. The grid of 792 holes available for components is aligned on .100 inch centers in both X and Y axes, and none of the component pads are tied to any of the power planes; power planes are bussed beside every pad position and require only short jumper wires to make a connection. Dual-inline packages as large as 66 pins may be accommodated. Size: 4.5"W x 4.0"L. Board substrate is .062" G10-FRY glass-epoxy, with 2 oz. of copper plating below .001" solder plate. Hole diameters are .043" and plated-through. Cost: \$13.25 (100 quantity). Midgard Electronics, 26 Walnut St., Watertown, MA 02172. (617) 924-9053. **Circle 134**

PDP-11 INTERFACE SERVES IEEE BUS

This PDP-11 compatible interface allows any PDP-11 series computer to be a talker, listener or a controller on the IEEE Std 488-1975 Gen-

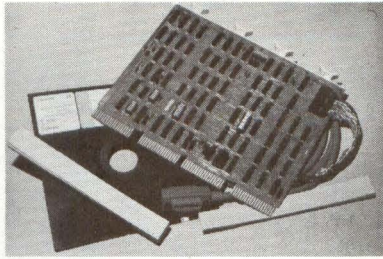

eral Purpose Interface Bus. Packaged as a single quad-height card,

the GPIB11-1 provides hardware decoding of bus messages. A two meter cable comes with a standard GPIB connector on one end. The software package provides for transmission and reception of ASCII or free formatted data. Price, \$1,495, including cable and software. National Instruments, 8330 Burnet Road, Austin, TX 78758. (512) 453-3475. **Circle 143**

Two New Refreshing Alternatives MEGRAPHIC 5000 & 7000 SERIES

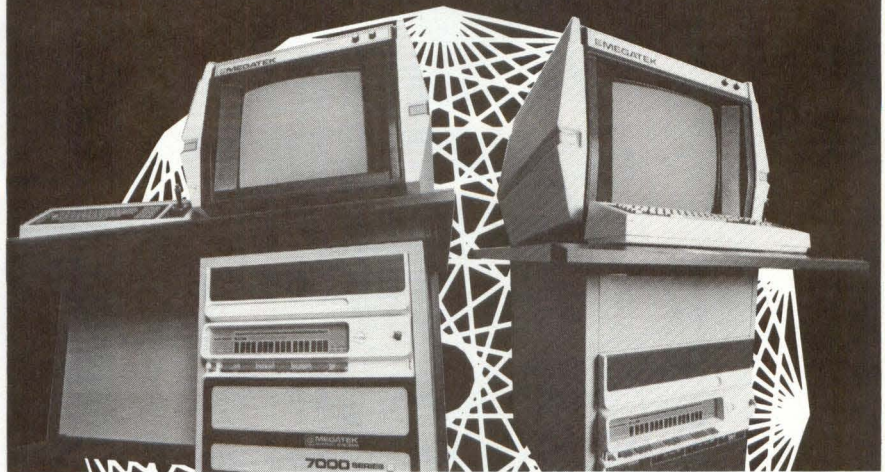

Dollar For Dollar, The Best Performing, Most Powerful, Intelligent Graphics Systems

DYNAMIC REFRESH

All MEGAPHIC Systems feature 100% vector refresh. Sharp, bright lines with 12 bits of screen resolution. Individual vectors or symbols can be erased, translated, rotated or scaled in real-time. No need to blank the entire screen to change one, one hundred, one thousand, ten thousand, or more points!

Local minicomputer power eliminates the host or minimizes its support requirements.

TEKTRONIX®* COMPATIBLE

Our 5014 emulates all Tektronix® 4010/4014™ Series storage terminals. MEGATEK's EDS™ adds powerful local edit capabilities, not available on a storage tube.

Easy to use, easy to pay for. Flexible cost effective systems, backed by MEGATEK engineering and software support. PDP-11, DATA GENERAL, and OEM interfaces available. We listen to your problems and solve them with quality products.



MEGATEK
CORPORATION

The Refreshing Alternative

1055 Shafter Street, San Diego, California 92106 Telephone: (714) 224-2721

*"TEKTRONIX" is a registered trademark of Tektronix, Inc., use of which in no way constitutes endorsement.

CIRCLE 80

Reach the rich European market... now



Many perceptive marketers get a third of their sales from Europe. Where U.S. technology is welcome.

There's no better time than now to parlay potential into profits. If you know where to go. And how to get your message across the Atlantic.

DIGITAL DESIGN gets it there. Talk to our regular U.S. readers at our normal low cost-per-thousand rates and you talk to our European readers at the same time.

Not just any Tom, Dick or Guiseppe either. Qualified prospects, all. Customers whose interests, installations and buying intentions are catalogued on our own com-

prehensive qualifications questionnaire. Rifle stuff, not shotgun.

We're in major international trade shows, too. With extra distribution. We monitor markets, sense trends, glean prospects, sift feedback. So that when you advertise in **DIGITAL DESIGN**, low cost-per-thousand isn't the only name of the game. It's sales.

Digital Design
The Magazine of Digital Systems
the market makers

Benwill Publishing Corporation, 167 Corey Road, Brookline, MA 02146

★ West (213) 454-0624 ★ East (617) 232-5470

ADVERTISER'S INDEX

112
ADDMASTER
Agency: Mich
38, 39, 41
ADTECH POWER
Agency: William E. Wilson
115, 117
AED
Agency: Art-Effects
31
AMPEX
Agency: Glenn, Bozell & Jacobs
82
AMS
62, 63
BIOMATION
Agency: Regis McKenna
46
BRAEMAR COMPUTER DEVICES
Agency: Thomas E. Dewey
12
CAMBRIDGE THERMIONIC
Agency: Provandie & Chirurg
8
CHALCO ENGINEERING
Agency: Clarke
36
COLORADO VIDEO
Agency: O'Connell
118
DATAFLUX
Agency: Associated Ad*Ventures
59
DATA 100
Agency: Chuck Ruhr
93
DATARAM
Agency: Louis Zimmer
49
DATA SYSTEMS DESIGN
Agency: Tycer-Fultz
67
DE ANZA
Agency: McDonough
61
DECITEK
Agency: Provandie & Chirurg
114
DYNAMIC RESEARCH
Agency: Robert Hartwell Gabine
37
EAGLE PICHER INDUSTRIES
Agency: Adventures
119
EDUCATIONAL DATA SYSTEMS
Agency: Sylvester
111
ELGAR
Agency: Chapman & Troast
113
ENCLOSURE DYNAMICS
Agency: Comp Shop
7
FLOATING POINT SYSTEMS
50
FORGFLO/BRUSH
Agency: Com-mar-ad

24
GARRY
Agency: Barbetta Miller
47
GENERAL INSTRUMENT
Agency: Darryl Llyod
22, 23, P.C.
GENERAL SYSTEMS
Agency: LaMantia
6, 103
GENISCO TECHNOLOGY
Agency: William E. Wilson
110
GNT AUTOMATIC
Agency: Robert Hartwell Gabine
C-4
GRINNELL SYSTEMS
Agency: Murphy
95
GROUP/3
45
GULTON INDUSTRIES
56, 57
HEWLETT-PACKARD/Colorado Springs
Agency: Tallant/Yates
81
HOUSTON INSTRUMENT
Agency: Cooley & Shillinglaw
C-2, P.C.
IMSAI
Agency: Republic
43
INFORMATION TERMINALS
Agency: Paul Pease
2, 3, 87
INTEL
Agency: Regis McKenna
120
INTERDESIGN
Agency: Tridar
40
INTERFACE
33
ISS/S PERRY UNIVAC
Agency: La Centra
30
C. ITOH
Agency: Zam & Kirshner
105, 107, 109
KERONIX
35
LEAR SIEGLER
Agency: LeAnce & Reiser
84, 85
3M/MINCOM/DATA PRODUCTS
Agency: Martin/Williams
28
MDB SYSTEMS
Agency: Sunshine Group
121
MEGATEK
Agency: Masar/Johnston
69
MEMODYNE
Agency: KMC

29
MFE
Agency: Schneider Parker
13, 65
MTS
Agency: Boylhart, Lovett & Dean
1
MUPRO
51, 52, 53
NATIONAL SEMICONDUCTOR
Agency: Chiat/Day
71
ONTEL
Agency: David A. Toren
18, 19
PERKIN-ELMER
Agency: Nigberg
83
PERSONAL COMPUTING
80
PORELON
Agency: Andrews/Mautner
17
PRINTRONIX
Agency: William E. Wilson
79
SHELDON-SODECO
Agency: Sommer
14, 15
SIGNETICS
Agency: Associated Ad*Ventures
73, 74, 75, 76, P.C.
SPACE BYTE
46
STANDARD ENGINEERING
8
SWEDA INTERNATIONAL
Agency: GHB
C-3
SYSTEM INDUSTRIES
Agency: Associated Ad*Ventures
27
TANDBERG DATA
Agency: Grant & Millard
4
TEC
Agency: Tec-ad
110
TEKSEL
10, 11 **TEKTRONIX**
Agency: Tektronix
21
TELETYPE
Agency: NW Ayer
9
TEXAS INSTRUMENTS
Agency: Glenn, Bozell & Jacobs
80
TORQUE SYSTEMS
Agency: Allied
82
TRIPLE I
Agency: Adpub
116
USM
Agency: John F. Norris

SALES OFFICES

PUBLISHER Yuri Spiro **MARKETING PROGRAMS DIRECTOR** George Palken **NEW ENGLAND** George Palken 167 Corey Road, Brookline, MA 02146 (617) 232-5470 **NEW YORK, WASHINGTON DC, PHILADELPHIA** Wes Schneider 30 P Village Green, Budd Lake, NJ 07828 (201) 347-7920 **MIDWEST, SOUTH** Ralph Petersen, 1 Wheaton Center No. 1706, Wheaton, IL 60187 (312) 653-2480 **LOS ANGELES, PHOENIX, DALLAS, SAN FRANCISCO** Alan Cazier 823 Enchanted Way, Pacific Palisades, CA 90272 (213) 454-0624 **WEST GERMANY** Maurice A. Coates Int'l. Media Reps. D-675 Kaiserlautern, Box 1610 **JAPAN** Hiro H. Irie International Business Corp. 11-8 Narita-Higashi 1-Chome, Suginami-KU, Tokyo 166 Phone: (03) 311-1746

ALPHA BITS

Learn about microprocessors . . .

Microprocessor Basics collects articles from *Electronic Design* magazine to provide you with a view to the growing applications and design features of the available microprocessors. The book covers both hardware and soft-

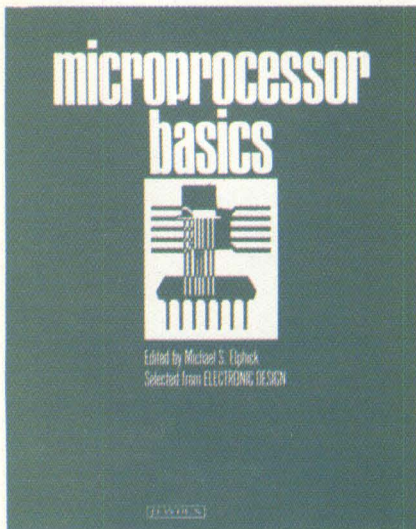

ware, with separate sections devoted to currently popular microprocessors. Specific models discussed include the 8080, F8, 6800, 2650, 6100, 1802 and PACE. **Microprocessor Basics**, edited by Michael S. Elphick, emphasizes the practical aspects of architecture, capabilities and applications. Published by Hayden Book Company, **Microprocessor Basics** costs \$9.95.

. . . Then use them

In a few short years, microprocessors have developed from a promising new technology into the most versatile and powerful tools electronics engineers have ever had. Their applications seem almost limitless; wherever a programmable, large-scale-integrated circuit can be worked into a system, there's a remarkably inexpensive (considering the work it does) microprocessor for the job.

Applying Microprocessors, edited by Laurence Altman and Stephen E. Scrupski, brings together recent articles from *Electronics* magazine that should help you master the new micro-

processor design methods. The 191-page book gives you both an overview of the state-of-the-art and a wealth of design ideas, practical applications and analysis.

Part 1 deals with hardware, covering the latest devices. Part 2, **Software and Prototype Design**, covers not only specific devices and systems, but also methodological topics you need to consider when embarking on a design project. Finally, Part 3 goes over many applications, including teleprinters, video games, display terminals and blood analyzers. Published by McGraw-Hill Publications, cost is \$15.00.

Computer cartoons

The 15 chapters of **The Colossal Computer Cartoon Book**, edited by David Ahl, range from robots to computer dating to computers at work and at home. The 128-page collection costs \$5.95 postpaid from Creative Computing, Attn: Pamela, P.O. Box 789-M, Morristown, NJ 07960. From the same address, **The Best of Byte – Volume I** (\$12.95), **The Best of Creative Computing – Volume II** (\$9.95) and **Computer Rage**, an \$8.95 board game that uses three binary dice.

CMOS handbook

A 556-page handbook providing detailed data on CMOS integrated circuits describes National Semiconductor Corporation's complete line of CMOS products. The **CMOS Databook** includes many new developments in LSI technology, such as keyboard encoders and DVM chips, and also details other National CMOS products: gates, buffers, flip-flops, counters, shift registers, decoders/multiplexers, RAMs and other devices. To obtain the handbook, send \$3.00 to Marketing Services Department, National Semiconductor Corp., 2900 Semiconductor Drive, Santa Clara, CA 95051.

8080 Programming

Practical Microcomputer Programming—The Intel 8080 promises software relief for 8080 users. Authors W.J.

Weller, A.V. Shatzel and H.Y. Nice address the book to the programmer and cover the use of 8080 instructions to accomplish binary arithmetic including multiple precision, software multiplication and division, stack-pointer use and management, handling of arrays and tables and software conversions between binary and other number bases. Example programs illustrate the process in 8080 assembly language. Northern Technology Books is accepting prepaid orders at \$21.95 a copy at P.O. Box 62, Evanston, IL 60204. The 18-chapter book will be available in a few weeks.

Electrical noise

Electrical noise manifests itself as a deviation of a current or voltage from its expected or desired value; like death and taxes, noise is omnipresent

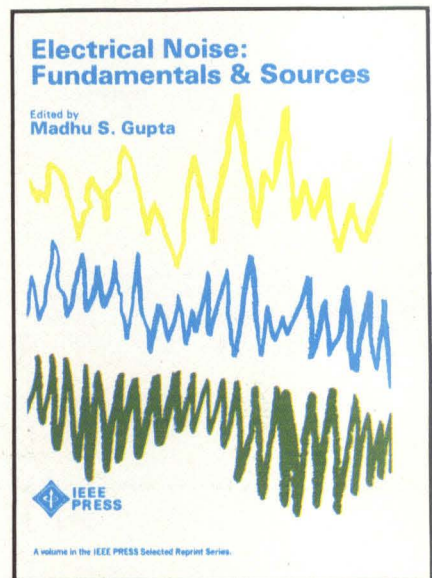

and inevitable. No matter what your specialty, you will benefit from a good understanding of noise. **Electrical Noise: Fundamentals and Sources**, an IEEE Press publication, collects tutorial-review papers on the physical theory and generation of electrical noise and its presence in electron devices. Edited by Madhu S. Gupta, the book includes 22 papers covering all aspects of fluctuation noise, rather than external noise or interference. Order from the IEEE Service Center, 445 Hoes Lane, Piscataway, NJ 08854.

When you buy disk systems from us, you get a lot more than just high-performance hardware...

At System Industries, we take great pride in translating the latest disk storage technologies into high-performance hardware. But by itself, superior hardware would not have made us the world's largest independent supplier of minicomputer disk systems. Equally important have been the people behind the hardware.

High-performance people. That's what you get with every disk system you purchase from System Industries. From responsive delivery to complete software support, our people know how to meet your specific requirements.

You can also add low price—the lowest in the industry for OEM-quantity purchases. Because we buy more disk drives than any other independent, we

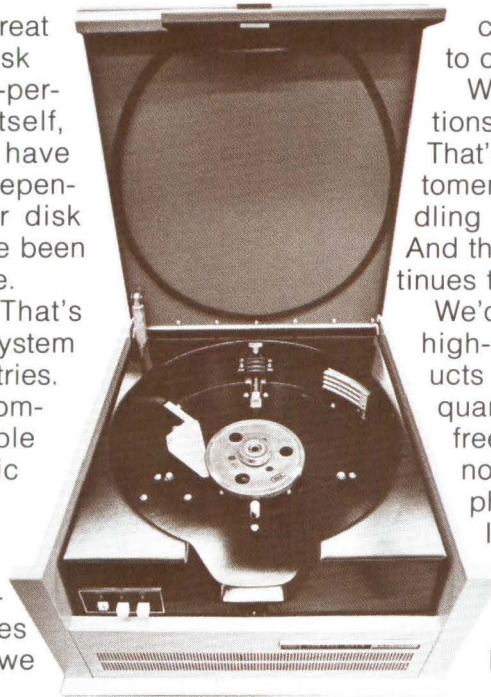

can afford to pass the savings on to our customers.

We believe the best business relationship is a mutually profitable one. That's why we're ready to help our customers become self-sufficient in handling their future disk storage needs. And that's why our customer base continues to grow rapidly.

We'd like to tell you more about our high-performance people and products by sending you "The Bit" — our quarterly newsletter. To receive your free copies, simply drop us a short note with your business card. Or phone your request to the System Industries sales/service office nearest you.

We make good disk drives work better, and we think you should know why.

...you get the support of high-performance people.

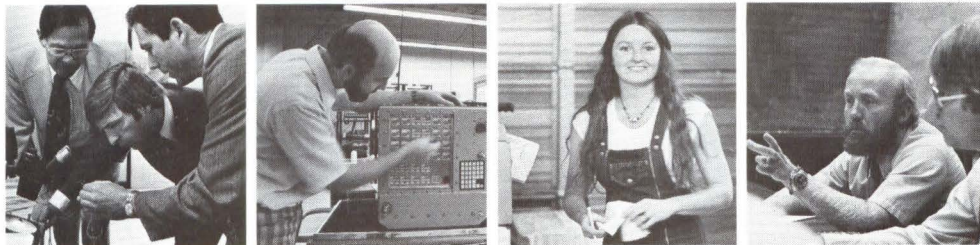

System Industries
an equal opportunity employer

535 Del Rey Avenue
Sunnyvale, California 94086
(408) 732-1650, Telex 346-459

Sales/Service Representatives:

Boston: (617) 492-1791. **New York:** (201) 461-3242; (201) 694-3334; (516) 751-8686; (716) 385-3021.

Washington, D.C.: (202) 337-1160. **Cincinnati:** (513) 661-9156. **Los Angeles:** (714) 752-8904.

Houston: (713) 465-2700. **Atlanta:** (404) 491-0161. **Sunnyvale HQ:** (408) 732-1650.

United Kingdom, Woking: (4862) 70725. **Germany, Dusseldorf:** 0211-400606.

GRINNELL DISPLAYS:

THE GEORGE E. FREEMAN LIBRARY
STATE TECHNICAL INSTITUTE
5983 M
Me

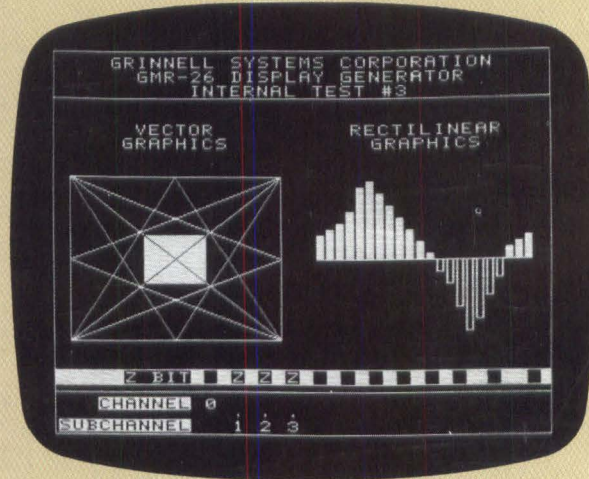
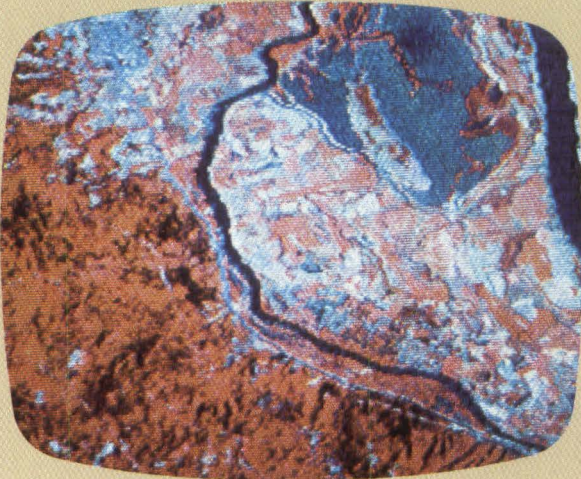
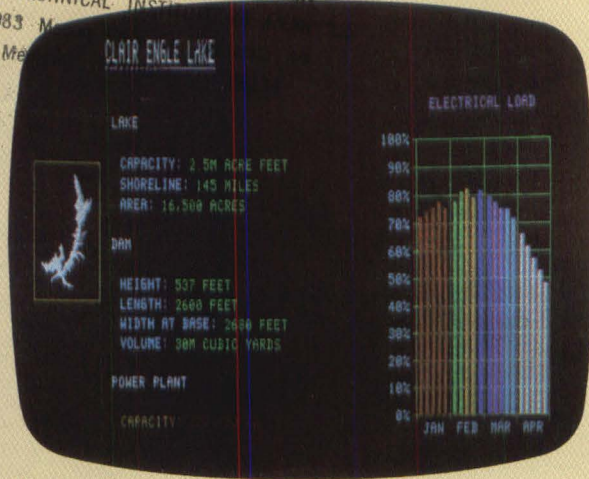
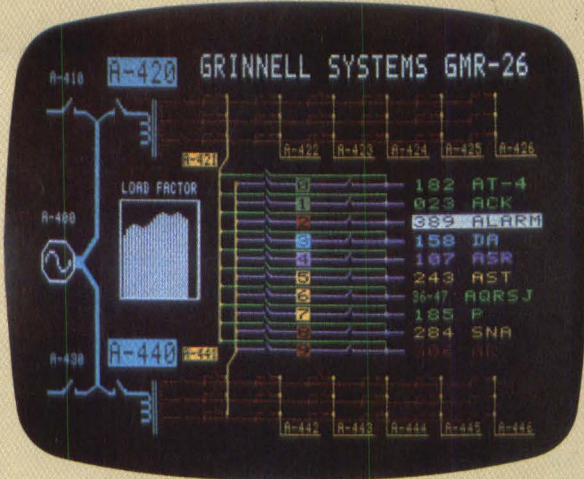

Complex color imaging . . . graphics . . . grey scale . . . basic black and white: our 100% solid state graphic television display systems can be matched to your computer display requirement, easily and economically.

And, they're intelligent. Powerful instruction sets minimize software overhead, simplify programming and eliminate the need for complex macro-instructions and

high order programming languages.

Further, every Grinnell system includes a standard computer interface, full alphanumeric and graphics, 4K MOS random access refresh memories and your choice of standard resolutions: 256 x 256, 256 x 512 or 512 x 512. Plug-compatible interfaces for most minicomputers are available, along with a large number of

operating options. All systems drive standard TV monitors.

So, before you make any decision about computer display systems, talk to the Grinnell experts. Our engineers have been in the display picture longer than most, and their experience shows. Complete operating systems start at \$5,700, and quantity discounts are available. For detailed specs and/or a quotation, call or write.

GRINNELL SYSTEMS

2986 Scott Boulevard, Santa Clara, California 95050 (408) 988-2100