

Hardware Maintenance Guide

Software Version 7.55, Site Manager Version 1.55

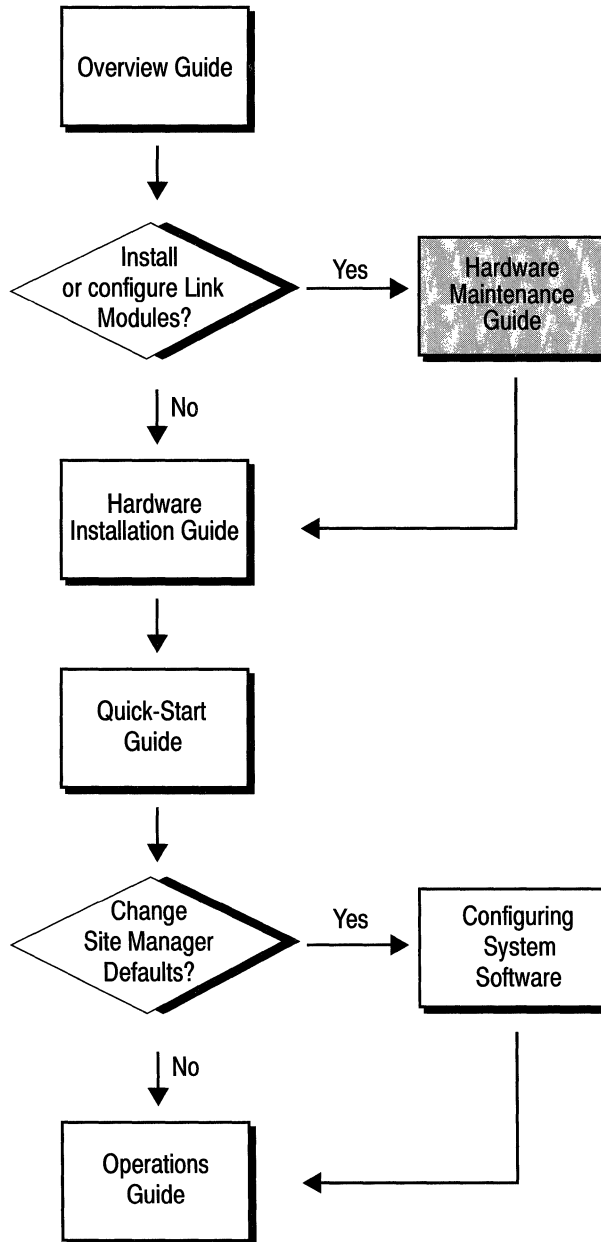

Reading Path



Part Number: 105546, Revision B

Copyright 1988-1993 Wellfleet Communications, Inc. (Unpublished)

All Rights Reserved. Printed in USA. March, 1993.

Information presented in this document is subject to change without notice. This information in this document is proprietary to Wellfleet Communications, Inc. and/or its suppliers.

The software described in this document is furnished under a license agreement or non-disclosure agreement. The terms of the Software License are provided for reference on the following page.

Notice to U.S. Government Licensees

For Department of Defense
Restricted Rights Legend

Use, duplication, or disclosure by the government is subject to restrictions as set forth in subparagraph (c)(1)(ii) of the Rights in Technical Data and Computer Software Clause at DFARS 252.227-7013.

For All Other Executive Agencies
Notice

Notwithstanding any other license agreement that may pertain to, or accompany the delivery of, this computer software, the rights of the Government regarding its use, reproduction, and disclosure are as set forth in the Commercial Computer Software-Restricted Rights clause at FAR 52.227-19.

AppleTalk is a registered trademark of Apple Computer, Inc.
DEC, DECnet, VAX, and VT-100 are trademarks of Digital Equipment Corporation.
Distinct is a registered trademark and Distinct TCP/IP is a trademark of Distinct Corporation.
Ethernet is a registered trademark and XNS is a trademark of Xerox Corporation.
HP is a registered trademark of Hewlett-Packard Company.
IBM, IBM PC, NetBIOS, and Token Ring are trademarks of International Business Machines Corp.
Internet Packet Exchange (IPX) and Novell are trademarks of Novell, Inc.
Intel is a registered trademark of Intel Corporation.
Microsoft and MS-DOS are registered trademarks and Microsoft Windows is a trademark of Microsoft Corporation.
Sun Workstation and SUN OS are trademarks of Sun Microsystems, Inc.
UNIX is registered trademark of AT&T Bell Laboratories.
Wellfleet is a trademark of Wellfleet Communications, Inc.
X Window System is a trademark of the Massachusetts Institute of Technology.
VINES is a trademark of Banyan Systems Incorporated.
Other product names are trademarks or registered trademarks of their respective owners.
3COM is a trademark of 3COM Corporation.

Wellfleet Communications, Inc., 8 Federal Street, Billerica, MA 01821

Software License

This license governs the licensing of all Wellfleet software (Software) provided to licensee for use with Wellfleet equipment (Equipment). Licensee is provided with Software in machine-readable form and related documentation. The Software provided under this license is proprietary to Wellfleet and to third parties from whom Wellfleet has acquired license rights. Wellfleet does not grant any Software license whatsoever, either explicitly or implicitly, except by acceptance of an order for either a Software license or for a Wellfleet product that is packaged with Software. Each such license is subject to the following restrictions:

1. Licensee is granted a license to use the Software when payment for the license fee is made. Upon receipt of payment, licensee is granted a personal, nontransferable, nonexclusive license to use the Software with the specific item of Equipment with which or for which it was originally acquired, including use at any of licensee's facilities to which the Equipment may be transferred, for the useful life of the Equipment unless earlier terminated by default or cancellation. Use of the Software shall be limited to such specific item of Equipment and to such facility. Software which is licensed for use on hardware not offered by Wellfleet (e.g. Site Manager) is not subject to restricted use on any Equipment, however, unless otherwise specified in the Documentation, each licensed copy of such Software may only be installed on one item of hardware at any time.
2. Licensee may use the Software with the backup Equipment only if the Equipment with which or for which it was acquired is inoperative.
3. Licensee may make a single copy of the Software (but not firmware) for safekeeping (archives) or backup purposes.
4. Licensee may modify Software (but not firmware), or combine it with other software, subject to the provision that those portions of the resulting software which incorporate licensed Software are subject to the restrictions of this license. Licensee shall not make the resulting software available for use by any third party.
5. Wellfleet and third parties from whom Wellfleet has acquired license rights shall at all times retain title to and ownership of their respective portions of the Software including new versions, new releases, updates and modifications provided to licensee. Licensee agrees and acknowledges that licensee will obtain only such rights to a license or sublicense for the Software as are specifically provided herein.

Software License (continued)

6. Licensee shall not provide, or otherwise make available, any Software, in whole or in part, in any form, to any third party. Third parties do not include consultants, subcontractors or agents of licensee who have licensee's permission to use the Software at licensee's facility, and who have agreed in writing to use the Software only in accordance with the restrictions of this license.
7. Third party owners from whom Wellfleet has acquired license rights to software that is incorporated into Wellfleet products shall have the right to enforce the provisions of this license against licensee.
8. Licensee shall not remove or obscure any copyright, patent, trademark, trade secret or similar intellectual property or restricted rights notice within or affixed to any Software and shall reproduce and affix such notice on any backup copy of Software or copies of software resulting from modification or combination performed by licensees as permitted by this license.
9. Notwithstanding any foregoing terms to the contrary, if Customer licenses the Product "Site Manager", Customer may duplicate and install the Site Manager Software as specified in the Documentation. This right is granted solely as necessary for use of the Site Manager Software on hardware installed within Customer's network. [Note: For licensees in the European Community, the Software Directive enacted by the Council of European Communities Directive dated 14 May 1991 shall apply for interoperability purposes. Licensee must notify Wellfleet in writing of any such intended examination of the Software and Wellfleet may provide review and assistance.]
10. Licensee shall not reverse assemble, reverse compile, or in any way reverse engineer the Software.
11. This license will automatically terminate upon improper handling of Software, such as by disclosure, or Wellfleet may terminate this license by written notice to licensee if licensee fails to comply with any of the material provisions of this license and fails to cure such failure within thirty (30) days after the receipt of written notice from Wellfleet. Upon termination of this license, licensee shall discontinue all use of the Software and return the Software and related documentation, including all copies, to Wellfleet.
12. Licensee's obligations under this license shall survive expiration or termination of this license.

Table of Contents

Chapter 1

Accessing the Interior

About this Chapter	1-1
Removing and Replacing the Front Bezel	1-2
Attaching the Antistatic Wrist Strap	1-4
Removing and Replacing the RFI Shield	1-6
Removing and Installing an Air Flow Module	1-8

Chapter 2

Hot Swapping the Hardware

About this Chapter	2-1
Replacing a Flash Memory Card	2-2
Replacing a Link Module or SRM-L.....	2-5
Replacing a FRE or SRM-F	2-9
Replacing a Power Module in a BCN	2-14
Replacing a Fan Tray in a BCN	2-17

Chapter 3

Configuring Hardware Modules

About this Chapter	3-1
5200 and 5201 Dual Port T1 Frammer Link Module (PN 100831 and 101667)	3-2
5250 Dual Port E1 Link Module (PN 101337)	3-4
5280 Quad Port Sync Link Module (PN 102285)	3-6
5290 Single HSSI Link Module (PN 104932)	3-10
5405 Dual Ethernet Link Module (PN 100003 or 100809)	3-12
5410 Single Sync/Single Ethernet Link Module (PN 102296)	3-14
5420 Dual Sync/Single Ethernet Link Module (PN 102293)	3-16
5430 Dual Sync/Dual Ethernet Link Module (PN 102279)	3-18
5450 Quad Ethernet Link Module (PN 102690)	3-20
5505 Dual Ethernet High Speed Filters Link Module (PN 102495)	3-22
5530 Dual Sync/Dual Ethernet High Speed Filters Link Module (PN 102494)	3-24
5705 Single Token Link Module (PN 102484)	3-26
5710 Dual Token Link Module (PN 103366)	3-28
5720 Single Sync/Single Token Link Module (PN 102483)	3-30
5740 Dual Sync/Single Token Link Module (DST-4, PN 101988)	3-32
5740 Dual Sync/Single Token Link Module (DST-4/16, PN 101531)	3-34
5740 Dual Sync/Single Token Link Module (TS416 1X2, PN 102482)	3-36
5930 FDDI Multimode Link Module (PN 102675) and 4995 Daughterboard (PN 103269)	3-38
5940 FDDI Single Mode Link Module (PN 103755) and 4995 Daughterboard (PN 103269)	3-40

75000 System Resource Module-Link (PN 103782)	3-42
75010 System Resource Module-Front (PN 103985)	3-43
75150 Fast Routing Engine (PN 103790) and Daughterboard (PN 102713)	3-44

Chapter 4

Switches and LEDs

About this Chapter	4-1
Front Panel	4-2
Rear Panel	4-4
SRM-F and FRE Modules	4-13

Appendix A

Replacing Fuses

About this Appendix	A-1
Replacing Fuses in the BLN	A-2
Replacing Fuses in the BCN	A-9

About this Guide

Audience and Scope

The procedures described in this guide are written for two audiences, with different skills and backgrounds. This section describes these audiences and indicates the procedures which may be performed by experienced network operators and those which require trained service personnel.

Experienced network operators who are maintaining Wellfleet Backbone Nodes (BNs) may follow the procedures described in the first four chapters of this guide: *Accessing the Interior*, *Hot Swapping the Hardware*, *Configuring Hardware Modules*, and *Switches and LEDs*. These chapters assume that the reader has a technical understanding of electronic apparatus and data communications.

Only service personnel may follow the procedures described in Appendix A, *Replacing Fuses*. These procedures are detailed in the statement below.



Danger - High Energy

Due to high-energy hazards, the following procedures are to be performed by service personnel only: removing the fuse access shield, removing fuses, and replacing fuses.



Service Personnel

Service personnel are required to have experience installing and servicing Wellfleet network hardware, and have training in taking precautions to minimize danger to themselves and others while performing a task inside a hazardous service access area.

Document Set

The following guides complete this documentation set:

Overview Guide

Describes the user interface, called the Site Manager application, the system software, and the router hardware.

Hardware Installation Guide

Describes how to physically install the router hardware.

Quick-Start Guide

Describes how to configure the router's initial IP network interface, install the Site Manager application software, and remotely create a pilot configuration for the Wellfleet router using the Site Manager.

Configuring System Software, Volumes I and II

Describes how to use the Site Manager's Configuration Manager application to set Wellfleet router parameters in one of three modes: local, remote, or dynamic.

Operations Guide

Describes how to use the Site Manager to perform day-to-day operations and how to use the Technician Interface to perform software maintenance.

If you are missing any guides, contact Wellfleet Customer Support at 1-800-2LANWAN.

Conventions

This document set uses the following conventions:

Convention:

filename

command

Denotes:

Italics denote file and directory names.

Bold text denotes text the user needs to enter.

Chapter 1

Accessing the Interior

- About this Chapter 1-1
- Removing and Replacing the Front Bezel 1-2
- Attaching the Antistatic Wrist Strap 1-4
- Removing and Replacing the RFI Shield 1-6
- Removing and Installing an Air Flow Module 1-8

List of Figures

Figure 1-1. Removing the Front Bezel from the BLN 1-2

Figure 1-2. Removing the Front Bezel from the BCN 1-3

Figure 1-3. Connecting the Wrist Strap 1-5

Figure 1-4. Removing the RFI Shield from the BLN 1-6

Figure 1-5. Removing the RFI Shield from the BCN 1-7

Figure 1-6. BLN with Air Flow Module 1-8

Figure 1-7. Back Edge of Air Flow Module 1-9

Accessing the Interior

About this Chapter

This chapter describes how to do the following:

- ❑ Remove the front bezel.
- ❑ Connect the antistatic wrist strap to the Wellfleet router to avoid damage to electronic components when handling hardware modules.

The antistatic strap is in a plastic pouch attached to the inside of the front bezel (panel).

- ❑ Remove the RFI shield from the front panel of the router to access the interior.

You need to access the interior to replace or insert additional Flash memory cards and FRE modules.

- ❑ Remove and install an air flow module.

Each unused slot is equipped with an air flow module, which redirects cool air to the FRE module below it, or to the side of it. You remove the air flow module to replace it with a FRE module.

Removing and Replacing the Front Bezel

You remove the front bezel to access the antistatic wrist strap, remove and insert Flash memory cards, FRE modules, and the SRM-F (System Resource Module-Front) in the BLN and BCN, replace hardware module fuses in the BLN, and replace the fan tray in the BCN.

Using both hands, pull the bottom of the front bezel and remove it from the chassis (see Figure 1-1 or 1-2).

Note: The front bezel should be kept on during normal operation to comply with air flow requirements.

You replace the front bezel as follows:

1. Align the mounting retainers on the inside of the bezel with the holes on the front of the RFI shield.
2. Push the sides of the bezel into place.

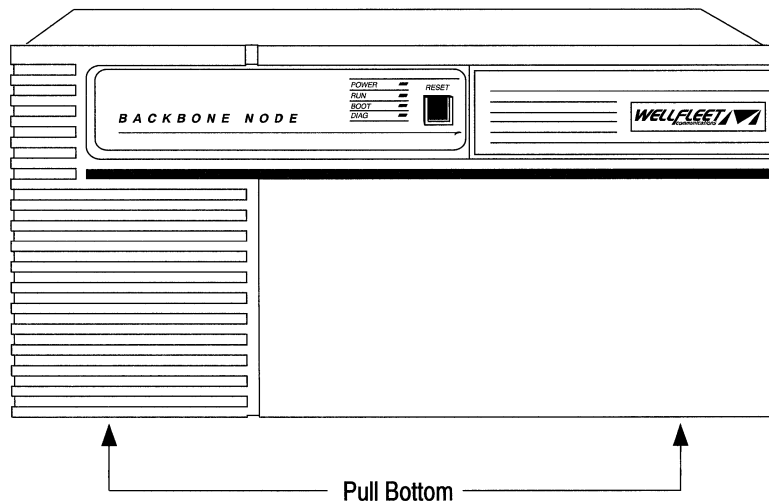

Figure 1-1. Removing the Front Bezel from the BLN

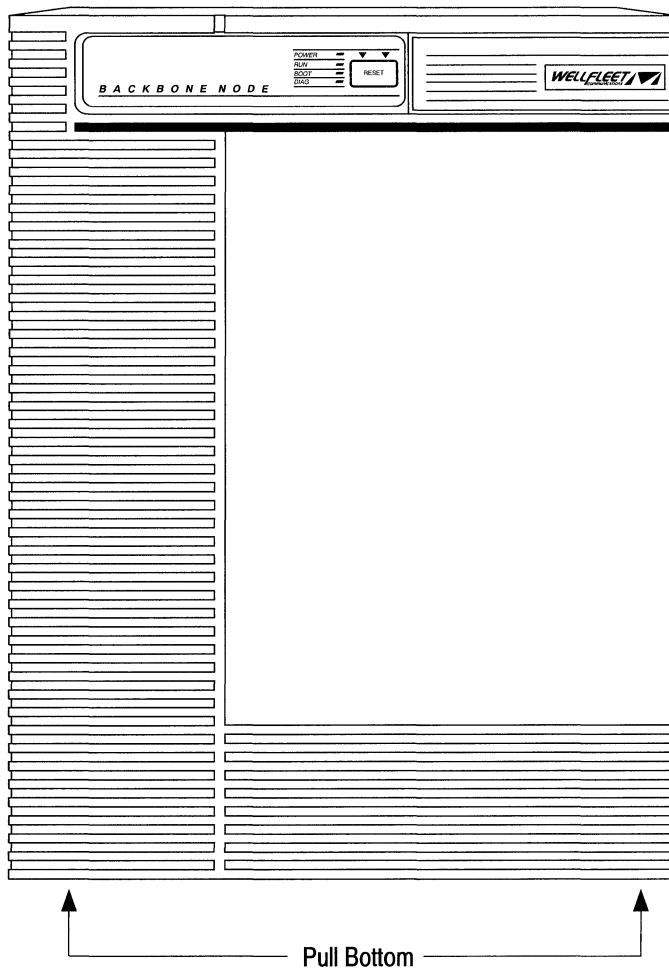

Figure 1-2. Removing the Front Bezel from the BCN

Attaching the Antistatic Wrist Strap

The antistatic wrist strap is located on the inside of the front bezel (front panel). Refer to the section *Removing and Replacing the Front Bezel* to access the antistatic strap.

Wearing an antistatic strap is required whenever you do the following:

- ❑ Remove, install, and handle Flash memory cards
- ❑ Remove, install, configure, and handle FRE (Fast Routing Engine) Modules, the SRM-F (System Resource Module-Front), and Link Modules (including the SRM-L [System Resource Module-Link]).
- ❑ Remove and replace module fuses

An antistatic strap directs the discharge of static electricity from your body to the chassis of the BN, thereby avoiding discharge to sensitive electronic components.



Warning: Electrostatic discharge can damage hardware. Follow the procedure in this section to protect your equipment from damage.

Attach the antistatic wrist strap as follows (see Figure 1-3):

1. Remove the front bezel (refer to *Removing and Replacing the Front Bezel*).
2. Remove the strap from the package attached to the back of the front bezel.
3. Insert your hand inside the band at one end of the antistatic strap.

Ensure the metal buckle inside the band is in contact with your skin. (Swing open the metal buckle to adjust the strap to form a snug fit if necessary).

4. Remove the alligator clip from the wrist strap and insert the end of the wrist strap into the antistatic receptacle if you are accessing a Flash card, hardware module, BCN Power Module, or BCN fuse.

If you are replacing a BLN fuse, refer to the appendix *Replacing Fuses* for the correct place to connect the wrist strap.

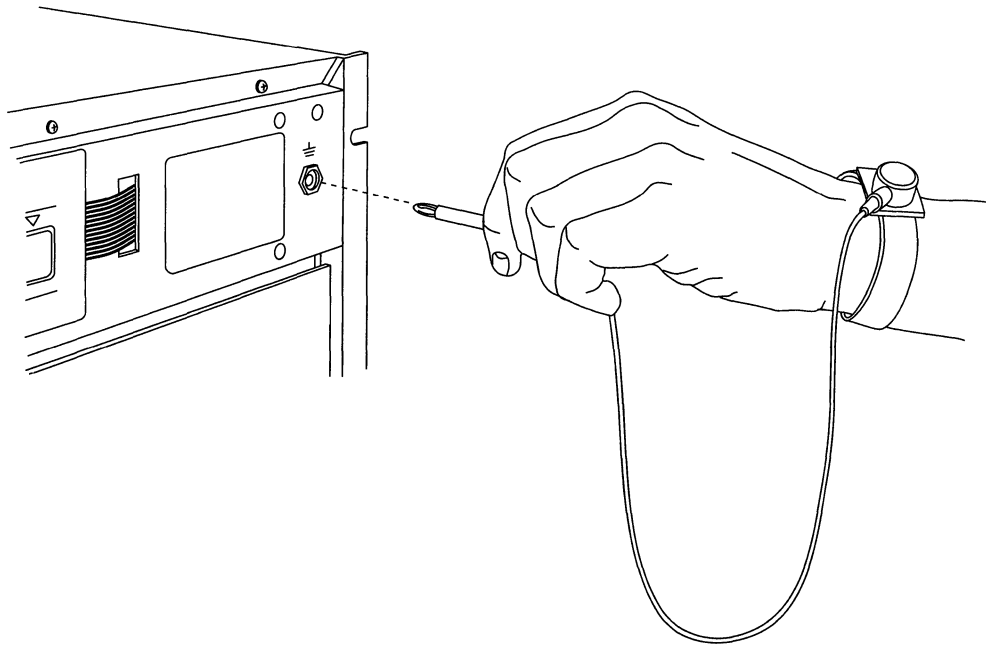

Figure 1-3. Connecting the Wrist Strap

Removing and Replacing the RFI Shield

You remove the radio frequency interference (RFI) shield to access the Flash memory cards and FRE modules.

Warning: Do *not* operate the BCN with the RFI shield removed for more than five minutes. The BCN overheats if the RFI shield is removed for more than five minutes. The BCN's temperature sensor does not function properly when the RFI shield is removed.

You remove the RFI shield as follows (see Figure 1-4 or 1-5):

1. Remove the front bezel (refer to the previous section for instructions).
2. Loosen the captive thumbscrews that fasten the RFI shield to the chassis.
3. Remove the RFI shield from the chassis.

The RFI shield must be in place to replace the front bezel. You replace the RFI shield as follows:

1. Position the RFI shield in front of the chassis.
2. Tighten the captive thumbscrews that fasten the RFI shield to the chassis.

Refer to the previous section to replace the front bezel.

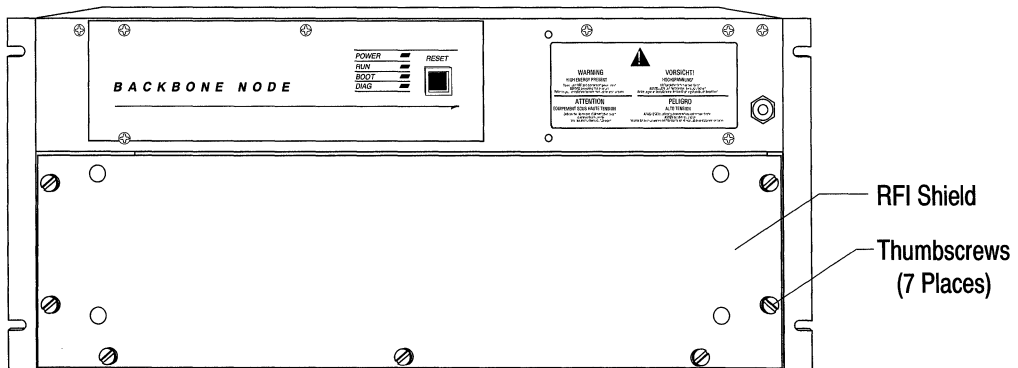

Figure 1-4. Removing the RFI Shield from the BLN

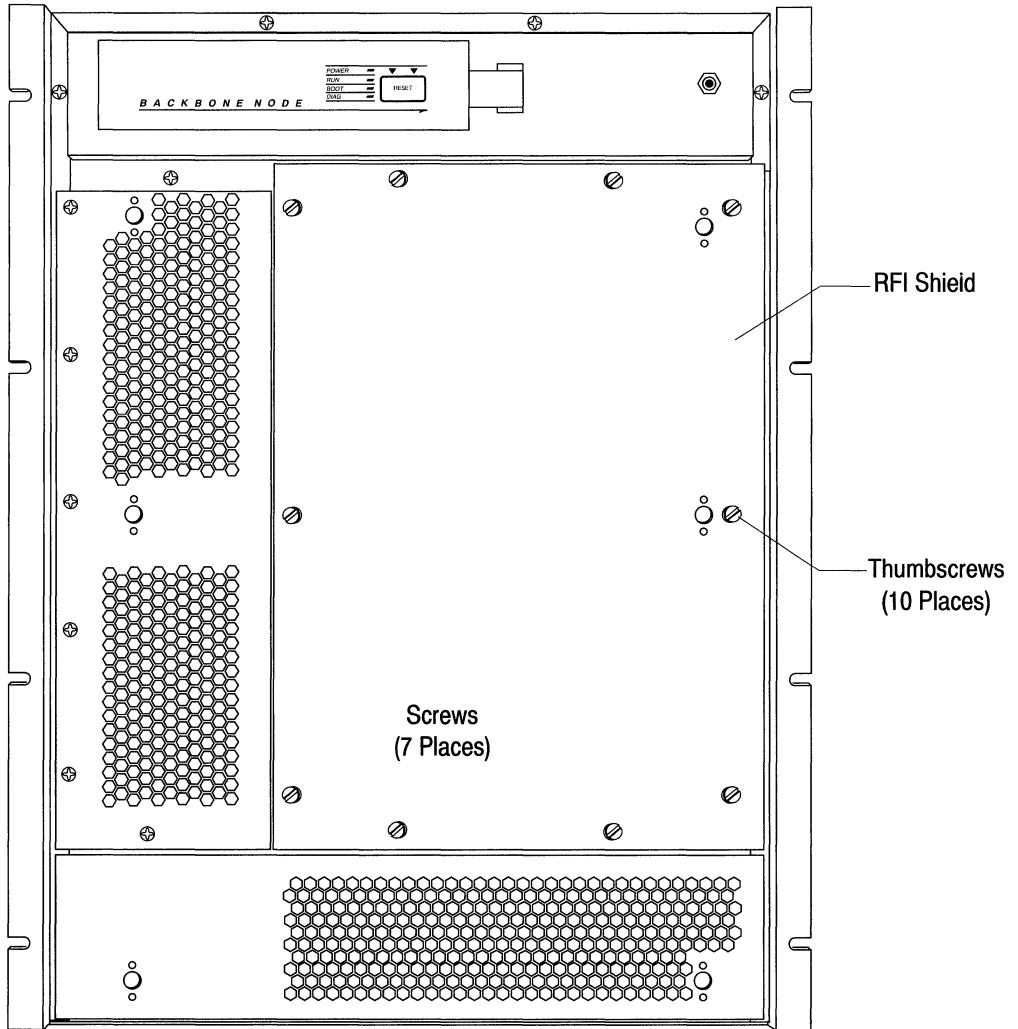

Figure 1-5. Removing the RFI Shield from the BCN

Removing and Installing an Air Flow Module

Wellfleet ships an air flow module in each empty FRE slot. Each air flow module redirects cool air to the FRE module below it in a BLN, or to the FRE module to the side of it in a BCN. Figure 1-6 is a sample illustration of how an air flow module is used. You remove the air flow module to replace it with a FRE module.

You remove an air flow module as follows:

1. Remove the front bezel (refer to the section *Removing and Replacing the Front Bezel*).
2. Remove the RFI shield (refer to the section *Removing and Replacing the RFI Shield*).

If you have a BLN, use a Phillips screwdriver to remove the screw that fastens the bottom of the board retainer bracket to the chassis. Then remove the board retainer bracket.

3. Pull the sides of the air flow module to remove it.

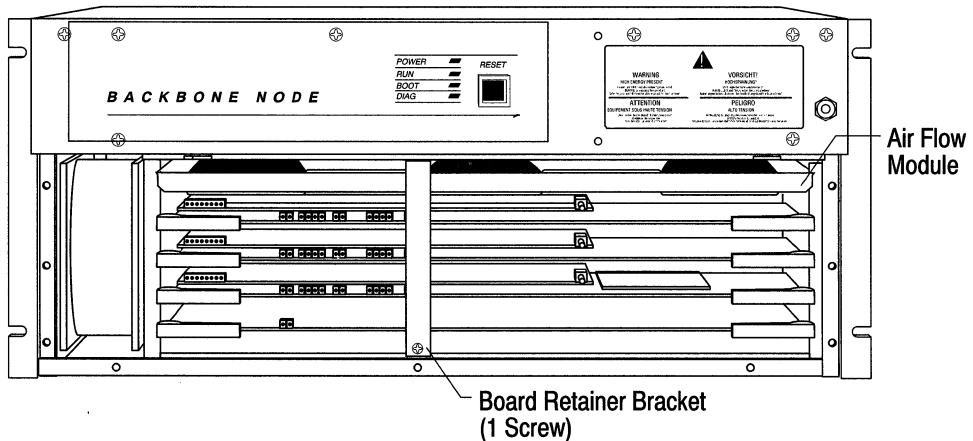

Figure 1-6. BLN with Air Flow Module

To install an air flow module, hold it by its sides and insert it, back edge first, into the desired slot along the card guides.

The back edge of the air flow module contains spaces to accommodate the slot's power connector and locating pin (see Figure 1-7).

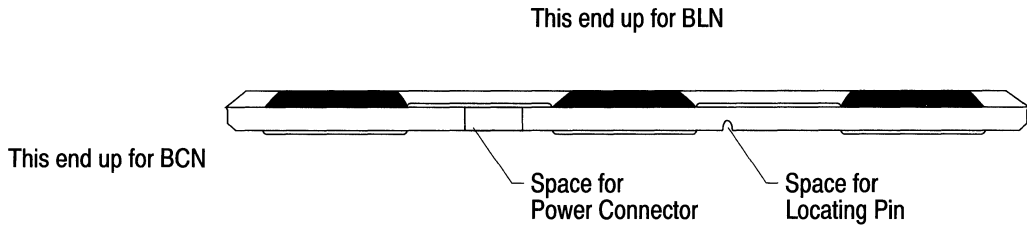

Figure 1-7. Back Edge of Air Flow Module

Chapter 2

Hot Swapping the Hardware

About this Chapter	2-1
Replacing a Flash Memory Card	2-2
Replacing a Link Module or SRM-L	2-5
Replacing a FRE or SRM-F	2-9
Replacing a Power Module in a BCN	2-14
Replacing a Fan Tray in a BCN	2-18

List of Figures

Figure 2-1. Wellfleet Flash Memory Card2-2
Figure 2-2. Removing a Flash Card2-4
Figure 2-3. Removing a Link Module or SRM-L from a BLN2-7
Figure 2-4. Removing a Link Module or SRM-L from a BCN2-8
Figure 2-5. Removing a FRE or SRM-F from a BLN2-10
Figure 2-6. Removing a FRE or SRM-F from a BCN2-12
Figure 2-7. Location of Power Switch on FRE and SRM-F2-13
Figure 2-8. Removing a Power Module from a BCN2-16
Figure 2-9. Removing Fan Tray Screws from a BCN2-19
Figure 2-10. Removing the Fan Tray from a BCN2-19

List of Tables

Table 2-1. Flash Memory Card Approved Vendors2-3
Table 2-2. BCN ILI +5 V Power Draw Configuration2-15

Hot Swapping the Hardware

About this Chapter

This chapter describes how to replace Flash memory cards and hardware modules. This chapter also describes how to replace a power supply module and a fan tray in a BCN. Wellfleet's hot swap capability allows you to replace these components with the power on. The procedures for replacing these components are the same whether the power is off or on.

Replacing a Flash Memory Card

This section describes how to hot swap a Flash memory card. You have at least one Flash card installed in your BN (see Figure 2-1). However, the BN supports one Flash card per FRE module. You install additional cards to provide redundancy or add storage capacity.



Figure 2-1. Wellfleet Flash Memory Card

When you remove a formatted Flash card, the Non-Volatile File System (NVFS) removes access to the card. When you insert and format a Flash card or insert a formatted Flash card, the NVFS automatically provides access to the card.



Warning: Electrostatic discharge can damage hardware. You must remove the front bezel, attach the antistatic strap to your wrist, and connect it to the antistatic receptacle before you remove or install a Flash card (refer to the chapter *Accessing the Interior* for instructions.)

Table 2-1 lists the 2 Mb, Personal Computer Memory Card International Association (PCMCIA) standard Flash memory cards that are qualified for use in a BN:

Table 2-1. Flash Memory Card Approved Vendors

Vendor	Part Number
Maxell	EF2MTB (AA)
Maxell	EF2MTB (BA)
INTEL	IMONC002FLKA
AMD	AMC002FLKA
Mitsubishi	MF82M1-G1EAT01
C Centennial	CC2048FLXX-15
Fujitsu	MB98A811220

Remove a Flash card as follows:

1. Press the rectangular button adjacent to the Flash card receptacle (see Figure 2-2).
2. Pull the Flash card toward you.

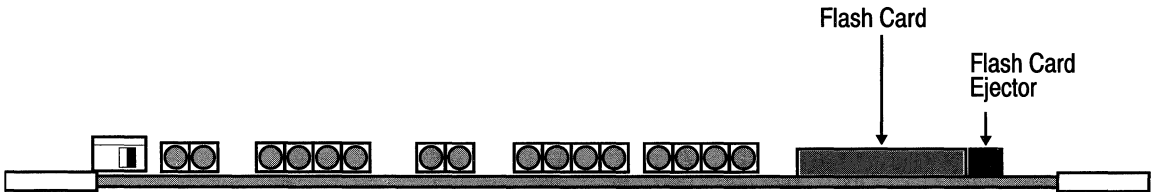

Figure 2-2. Removing a Flash Card

You insert a Flash card into any FRC module as follows:

1. Position the Flash card with the label facing up and the INSERT arrow pointing toward the BN.
2. Insert the Flash card into the Flash card receptacle.
3. Gently push the Flash card until it fits snugly into place.

You close the BN as follows (refer to the chapter *Accessing the Interior* for detailed instructions.)

1. Replace the RFI shield.
2. Insert the wrist strap into the wrist strap pouch attached to the back of the front bezel.
3. Replace the front bezel.

Format the Flash card using the Site Manager or **TI format** command before attempting to write to it if the card is new and you did not obtain it from Wellfleet. (Refer to the *Operations Guide* for instructions.)

Replacing a Link Module or SRM-L

You can remove and replace a Link Module or an SRM-L with the power on or off. You follow the same procedure to replace a Link Module or an SRM-L.

When you remove a Link Module, connectivity to the slot in question and the services provided by the slot are disrupted. The other FRE modules resynchronize their routing tables after the slot fails to receive packets.

Warning: The SRM-L and SRM-F each supply two backbones. Thus, two backbones become inactive if you remove one, and four backbones become inactive if you remove both. When you insert one, its associated backbones become active.

When you insert a Link Module in a slot, the FRE module in that slot detects the presence of the Link Module and provides connectivity to it. The FRE module alerts the other FRE modules that it can receive packets and the other FRE modules resynchronize their routing tables accordingly.



Warning: Electrostatic discharge can damage hardware. You must remove the front bezel, attach the antistatic strap to your wrist, and connect it to the antistatic receptacle before you handle BN components (refer to the chapter *Accessing the Interior* for instructions).

Refer to Figure 2-3 if you have a BLN, or to Figure 2-4 if you have a BCN. The procedures are the same for the BLN and BCN.

Remove a Link Module as follows:

1. Disconnect all exterior cables (device, LAN, and/or WAN connections).
2. Twist off the two captive screws on each end of the board.
3. Grasp the sides of the Link Module and pull it out of the node.
4. Place the Link Module in an antistatic protective bag.

Install a Link Module as follows:

1. Slide the Link Module into the desired slot inside the card guides until the board's connector panel is up against the BN's rear panel.
2. Secure the two captive screws on both sides of the Link Module.
3. Connect any device cables or LAN/WAN interface cables to the Link Module.

Note: Wellfleet recommends that you issue the **diags** command to the associated slot immediately after you insert a Link Module (refer to *the Operations Guide: Technician's Interface*). Otherwise, the Link Module FAIL LED will remain lit, indicating diagnostics have *not* been run on the ILI (refer to the *Switches and LEDs* chapter). However, regardless of whether you issue the **diags** command, the Link Module will be initialized and become operational if it is functional and its ports are configured.

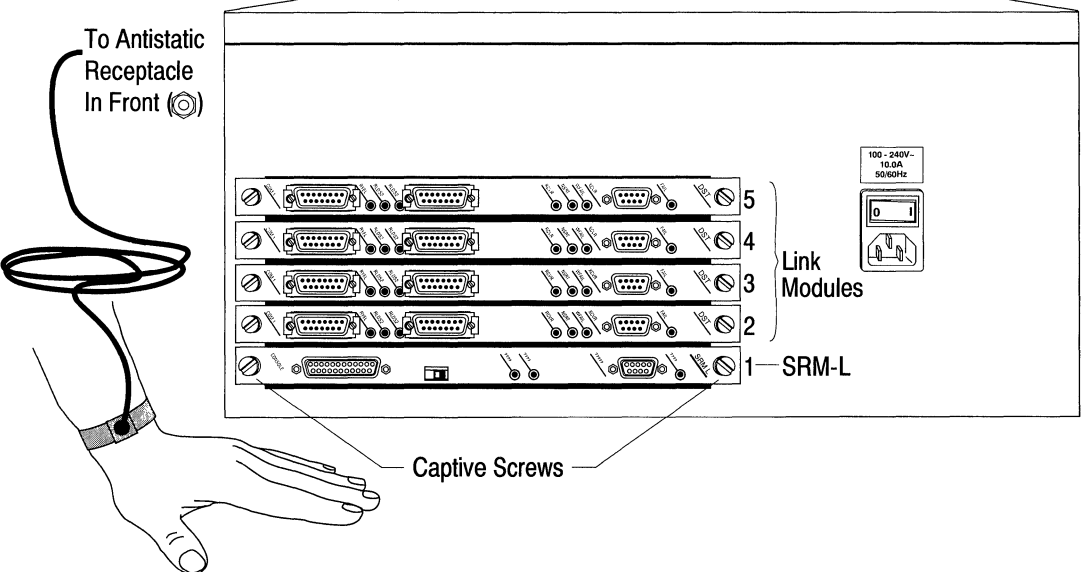

Figure 2-3. Removing a Link Module or SRM-L from a BLN

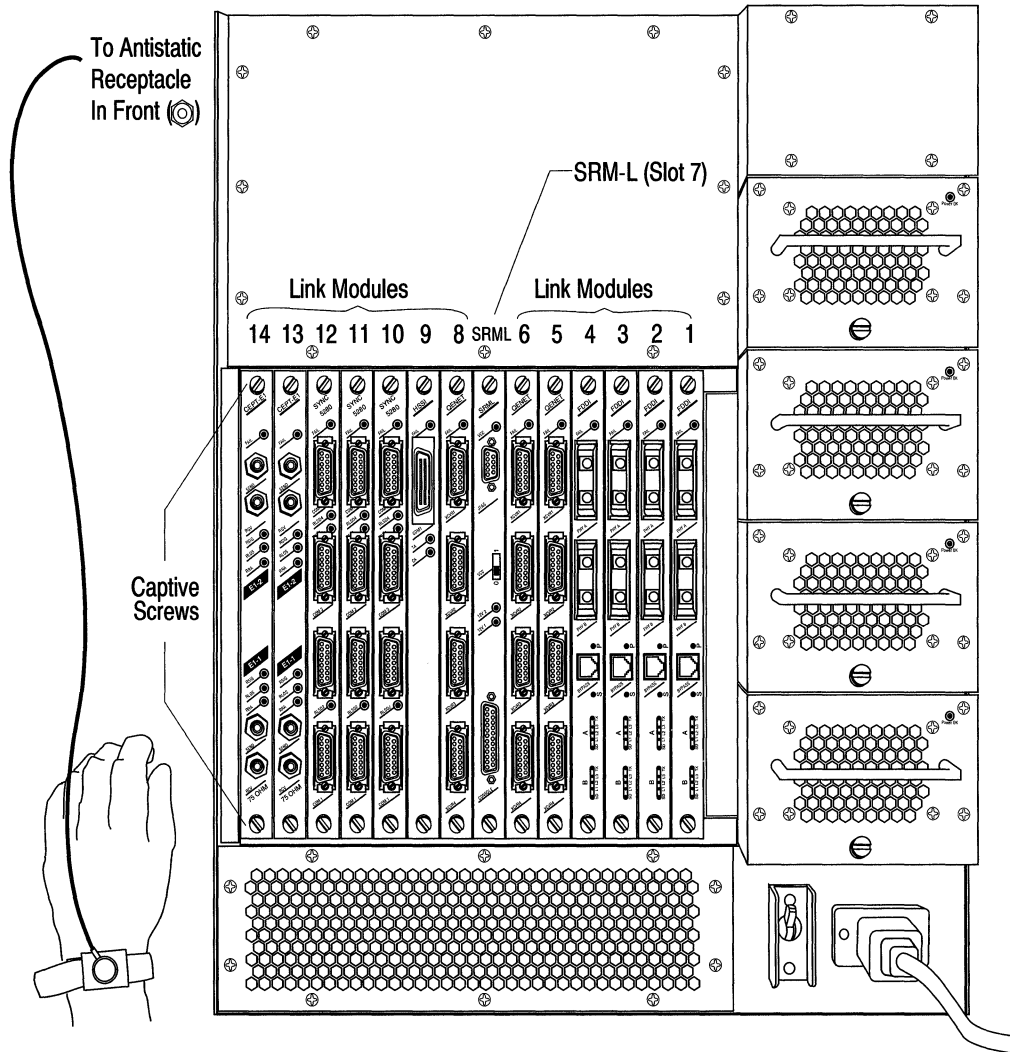

Figure 2-4. Removing a Link Module or SRM-L from a BCN

Replacing a FRE or SRM-F

You can remove and replace a FRE module or SRM-F with the power on or off. You must remove the front bezel and RFI shield to access it (refer to the chapter *Accessing the Interior* for instructions.)

When you remove a FRE Module, connectivity to the slot in question and the services provided by the slot are disrupted. The other FRE modules resynchronize their routing tables after the slot fails to receive packets.

Warning: The SRM-L and SRM-F each supply two backbones. Thus, two backbones become inactive if you remove one, and four backbones become inactive if you remove both. When you insert one, its associated backbones become active.

When you insert a FRE module in a slot and power is determined to be stable for the slot, the FRE module automatically resets as follows:

1. The newly inserted FRE module executes the diagnostics image resident on the Flash E-PROM.
2. The newly inserted FRE module completes the boot process.



Warning: Electrostatic discharge can damage hardware. You must attach the antistatic strap to your wrist and connect it to the antistatic receptacle before you handle BN components (refer to the chapter *Accessing the Interior* for instructions).

Refer to Figure 2-5 if you have a BLN, or to Figure 2-6 if you have a BCN. The procedures are the same for the BLN and BCN. However, you must remove a board retainer bracket from the BLN in order to gain access to the front modules.



Danger - High Energy

A potential energy hazard exists during power on (hot swap) service of link modules. Do not remove more than two (2) adjacent boards/brackets without powering off the unit and removing the power cord.

Remove a board retainer bracket from a BLN as follows (see Figure 2-5):

1. Use a Phillips screwdriver to release the screw that fastens the board retainer bracket to the chassis.
2. Pull the bottom of the board retainer bracket to remove it.

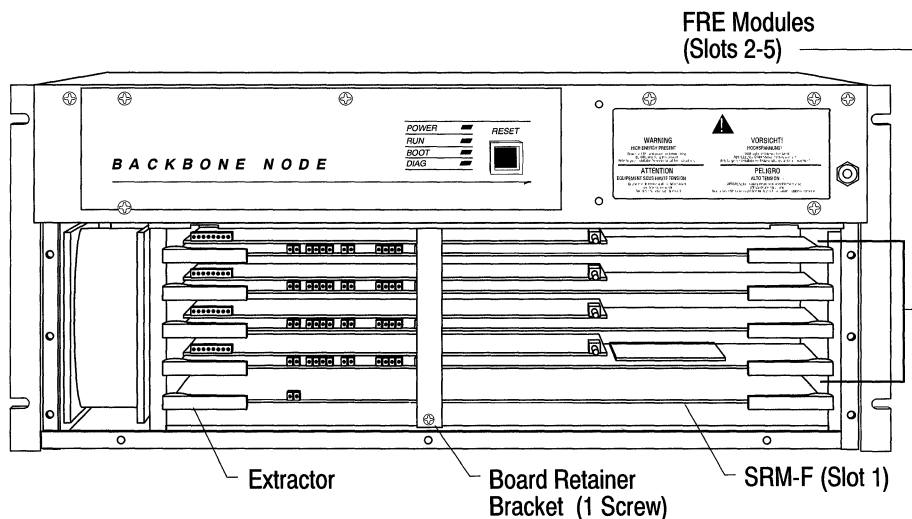

Figure 2-5. Removing a FRE or SRM-F from a BLN

Note: Only slot 1 (the bottom slot) in the BLN may contain an SRM-F. Only slot 7 in the BCN may contain an SRM-F. The remaining slots are available for FREs.

Remove a FRE or SRM-F from a BLN or BCN as follows (see Figure 2-5 or 2-6):

1. Swing open the extractors at each end of the board that you are removing by gently pulling the inside of the extractors toward you.
2. Pull the extractors to remove the board.
3. Place the FRE or SRM-F in an antistatic protective bag.

Insert a FRE or SRM-F in a BLN or BCN as follows:

1. Ensure the power switch on the board you inserted is pushed to the right if it is equipped with a power switch (see Figure 2-7).
2. Holding the board extractors open, slide the FRE into the desired slot inside the card guides.

If you have a BLN, lift the middle of the board slightly and push it gently to ensure the connector in the middle engages.
3. Swing the extractors forward to lock the board in place.

Note: Slide the board out and repeat steps 1 and 2 if the extractors do not lock into place easily.

Replace a board retainer bracket in a BLN as follows (see Figure 2-5):

1. Slide the top of the board retainer bracket into its designated ridge and align the bottom of the bracket with the screw hole at the bottom of the chassis.
2. Use a Phillips screwdriver to secure the board retainer bracket to the chassis.

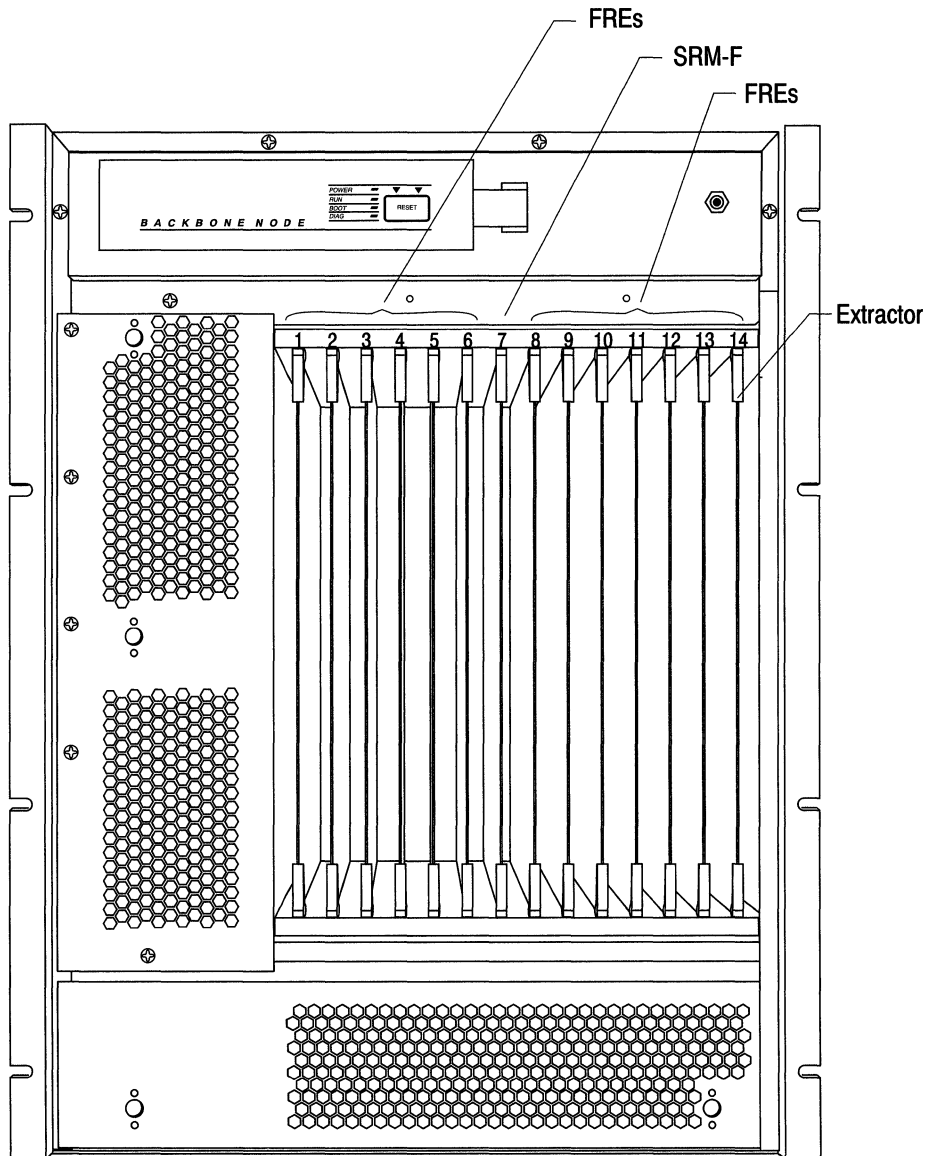

Figure 2-6. Removing a FRE or SRM-F from a BCN



Figure 2-7. Location of Power Switch on FRE and SRM-F

When you are finished, replace the RFI shield and front bezel (refer to the chapter *Accessing the Interior* for instructions.)

Note: If your FRE or SRM-F is *not* equipped with a power switch, it powers on automatically when you connect it.

When you insert a FRE, the DIAG LED lights during diagnostics and goes out if diagnostics determine that the FRE is functional.

If diagnostics determine the FRE is not functional, the DIAG LED on the front panel and LED 8 on the FRE module daughterboard remain on (refer to the *Switches and LEDs* chapter to identify LED 8). If this occurs, ensure the modules are seated properly in the Wellfleet router and issue the TI **diags** command. Call Wellfleet customer service if the DIAG LED does not go out.

If diagnostics determine the FRE is functional and a Link Module is connected to the FRE, diagnostics are also performed on the Link Module. If the Link Module or any of its ports are not functional, the Link Module Fail LED lights. Regardless of the results of Link Module diagnostics, the BOOT LED then lights, indicating the FRE is booting. If a Link Module fails diagnostics, it does not become operational. If a Link Module succeeds diagnostics, it becomes operational. However, any Link Module ports that fail diagnostics do not become operational.

Replacing a Power Module in a BCN

The 620 Watt Hot Swap Power Modules are inserted in the rear panel of the BCN and are easily accessible.

The GAME operating system generates an event message in response to a change in the status of each Hot Swap Power Module. These messages identify the Power Module by its slot. The Power Module slots are numbered 1 through 4 from the bottom of the BCN to the top.

Each Power Module is equipped with a green Power OK LED which when lit indicates the Power Module is operational and direct current is on. The Power LED on the front panel of the BCN indicates

When the BCN is powered on and you remove an operational Power Module, the Power OK LED goes out, and the BCN automatically redistributes the load among the remaining Power Modules.

When the BCN is powered on and you insert an operational Power Module, the Power OK LED lights, indicating the Power Module is operational, and the BCN automatically redistributes the load among the Power Modules.

Each Power Module provides up to 90 amps at +5 V. You need at least three Power Modules to supply power to a fully-loaded BCN. Table 2-2 lists the average +5 V power draw for each Intelligent Link Interface (ILI).

The following occurs if you power up the BCN with an insufficient number of Power Modules to supply power to its ILI configuration, or you remove a Power Module necessary to supply sufficient power:

1. The Power Modules go into overcurrent mode.
2. The BCN powers off.

Verify that the remaining operational Power Modules can provide sufficient power for the BCN's ILI configuration if you are removing a Power Module and there are already less than four operating Power Modules.

If the power supply will not be sufficient when you remove a Power Module, remove network cables, Link Modules, and FREs from the least critical slots until the ILI configuration draws less power than the Power Modules will supply.

Table 2-2. BCN ILI +5 V Power Draw Configuration

ILI	+5 V Power Draw
Quad Port Sync	18 amps
Ethernet Single Port Sync	18 amps
Quad Port Ethernet	19 amps
Multimode FDDI	20 amps
Dual Port T1 Framer/Multiplexer	18 amps
Dual Port T1 Framer/Multiplexer - DACS 56K	18 amps
Dual Port E1 (CEPT) Framer/Multiplexer	18 amps
Single Port HSSI	21 amps
Dual Port Token Ring	18 amps
Single Port Token Ring/Dual Sync	18 amps

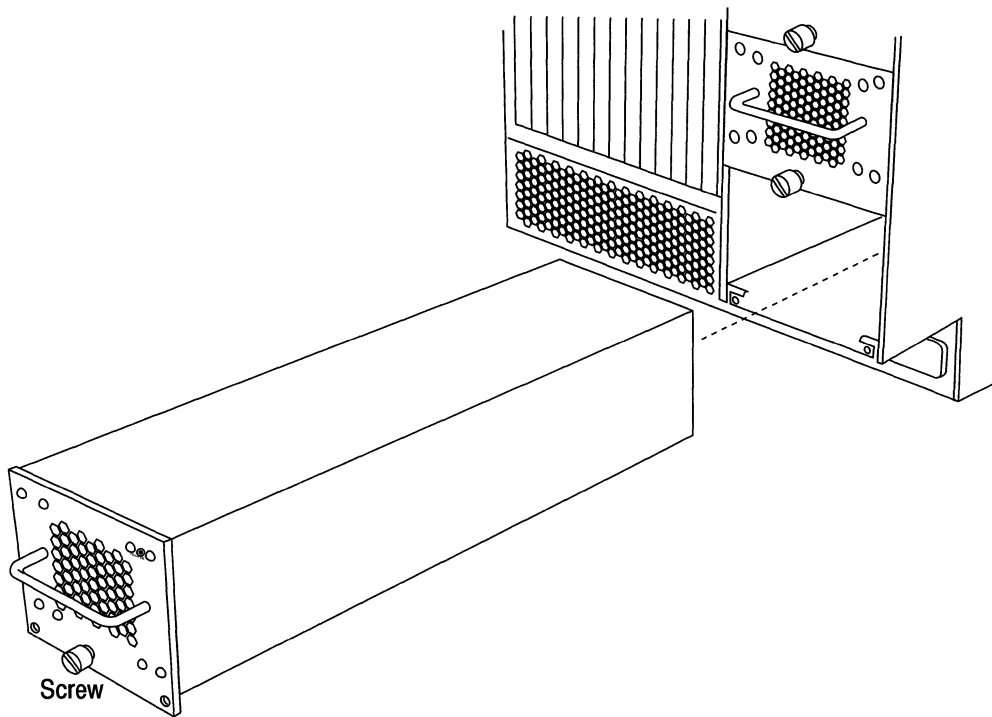

Figure 2-8. Removing a Power Module from a BCN

You can remove and replace a Power Module in a BCN with the power on or off.

Remove a Power Module as follows (see Figure 2-8):

1. Using a flat-head screwdriver, loosen the captive screw until the Power Module disengages.
2. Grasp the handle and pull it out of the BCN.

**Danger**

The sides of the Power Module are hot when removed from a BCN that has been operating recently. Hold the Power Module by the bottom.

After a Power Module is removed with the power on, wait thirty seconds before inserting another. This delay allows the overvoltage circuitry to reset.

Insert a Power Module as follows:

1. Grasp the handle and guide the module into the desired slot along the side guides and *gently* insert the module until the power supply connector comes into contact with the mating connector on the power supply backplane.

Note: Stop when you feel resistance. The Power Module does *not* fully insert until you tighten the thumbscrew.

2. Using a flat-head screwdriver, turn the captive screw until the power module is seated firmly.

The Power OK LED lights when the BCN is powered on and the Power Module is fully engaged.

3. Turn the captive screw an additional 1/4 turn. Do *not* overtighten the screw.

If the Power OK LED does not light, the Power Module you inserted is not operational. Repeat the procedure to install a new Power Module.

Replacing a Fan Tray in a BCN

The BCN fan tray is located on the front panel of the chassis above the RFI Shield.

The GAME operating system generates two event messages in response to a change in the status of the fan tray.

Warning: The BCN may overheat if the fan tray is removed for more than two minutes. If the BCN is powered on, quickly replace the fan tray to prevent overheating.

You can remove and replace a fan tray in a BCN with the power on or off.

Remove a fan tray as follows:

1. Remove the front bezel (refer to the chapter *Accessing the Interior*).
2. Remove the antistatic strap and alligator clip from the package attached to the back of the front bezel. Insert your hand into the wristband of the strap.
3. Connect the alligator clip to the connector at the other end of the antistatic strap and connect the clip to the vent holes in the power supply panel.

The power supply panel is the vented panel to the left of the RFI shield.

4. Remove the RFI shield (refer to the chapter *Accessing the Interior*).
5. Use a Phillips screwdriver to remove the screws that fasten the fan tray to the chassis (see Figure 2-9).
6. Grasp the bottom of the fan tray and pull it out of the BCN (see Figure 2-10).

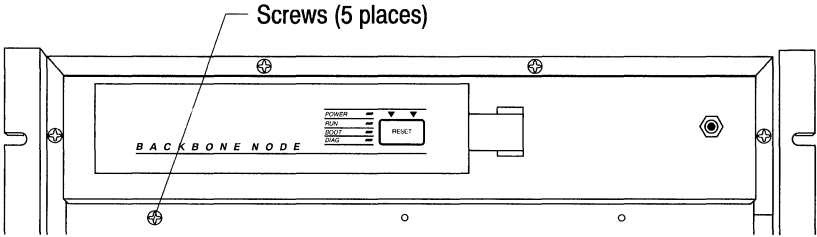

Figure 2-9. Removing Fan Tray Screws from a BCN

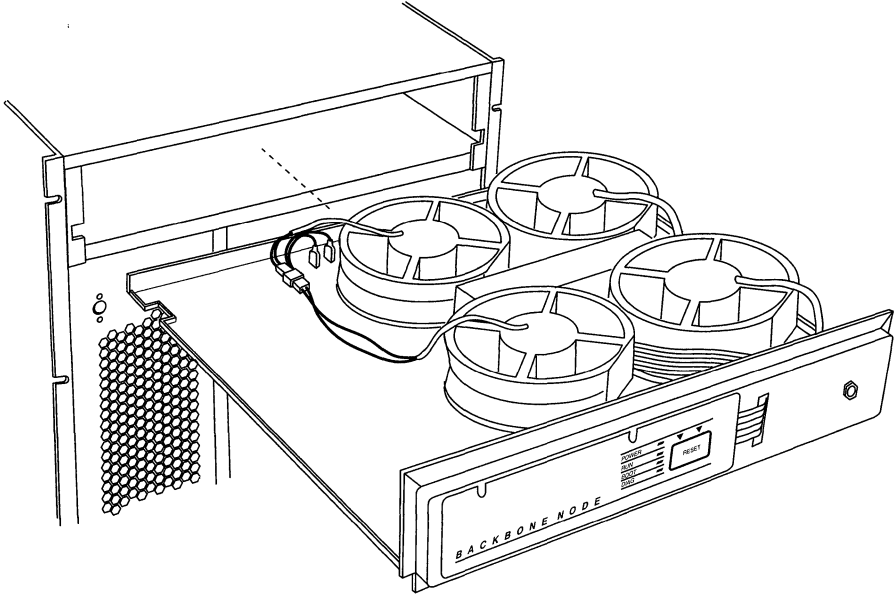

Figure 2-10. Removing the Fan Tray from a BCN

Insert a fan tray as follows:

1. Grasp the bottom of the fan tray and guide it into the slot until the connectors at the rear of the fan tray engage.

The fans start up when the BCN is powered on and the fan tray is fully engaged.

If the fans do not start up, the fan tray you inserted is not operational. Repeat the procedure to install a new fan tray.

2. Use a Phillips screwdriver to secure the screws that fasten the fan tray to the chassis.

Note: Do not insert Phillips screws into the two lower right screw holes on the fan tray. They are reserved for the RFI shield.

3. Install RFI shield and the front bezel.

Chapter 3

Configuring Hardware Modules

About this Chapter	3-1
5200 and 5201 Dual Port T1 Framer Link Module (PN 100831 and 101667)	3-2
5250 Dual Port E1 Link Module (PN 101337)	3-4
5280 Quad Port Sync Link Module (PN 102285)	3-6
5290 Single HSSI Link Module (PN 104932)	3-10
5405 Dual Ethernet Link Module (PN 100003 or 100809)	3-12
5410 Single Sync/Single Ethernet Link Module (PN 102296)	3-14
5420 Dual Sync/Single Ethernet Link Module (PN 102293)	3-16
5430 Dual Sync/Dual Ethernet Link Module (PN 102279)	3-18
5450 Quad Ethernet Link Module (PN 102690)	3-20
5505 Dual Ethernet High Speed Filters Link Module (PN 102495)	3-22
5530 Dual Sync/Dual Ethernet High Speed Filters Link Module (PN 102494)	3-24
5705 Single Token Link Module (PN 102484)	3-26
5710 Dual Token Link Module (PN 103366)	3-28
5720 Single Sync/Single Token Link Module (PN 102483)	3-30

5740 Dual Sync/Single Token Link Module (DST-4, PN 101988)	3-32
5740 Dual Sync/Single Token Link Module (DST-4/16, PN 101531)	3-34
5740 Dual Sync/Single Token Link Module (TS416 1X2, PN 102482)	3-36
5930 FDDI Multimode Link Module (PN 102675) and 4995 Daughterboard (PN 103269)	3-38
5940 FDDI Single Mode Link Module (PN 103755) and 4995 Daughterboard (PN 103269)	3-40
75000 System Resource Module-Link (PN 103782)	3-42
75010 System Resource Module-Front (PN 103985)	3-43
75150 Fast Routing Engine (PN 103790) and Daughterboard (PN 102713)	3-44

List of Figures

Figure 3-1. Dual Port T1 Framer	3-2
Figure 3-2. Dual Port E1	3-4
Figure 3-3. Quad Port Sync	3-6
Figure 3-4. Single HSSI	3-10
Figure 3-5. Dual Ethernet	3-12
Figure 3-6. Single Sync/Single Ethernet	3-14
Figure 3-7. Dual Sync/Single Ethernet	3-16
Figure 3-8. Dual Sync/Dual Ethernet	3-18
Figure 3-9. Quad Ethernet	3-20
Figure 3-10. Dual Ethernet High Speed Filters	3-22
Figure 3-11. Dual Sync/Dual Ethernet High Speed Filters	3-24
Figure 3-12. Single Token	3-26
Figure 3-13. Dual Token	3-28
Figure 3-14. Single Sync/Single Token	3-30
Figure 3-15. Dual Sync/Single Token (DST-4)	3-32
Figure 3-16. Dual Sync/Single Token (DST-4/16)	3-34
Figure 3-17. Dual Sync/Single Token (TS416 1X2)	3-36
Figure 3-18. FDDI Multimode	3-38
Figure 3-19. FDDI Daughterboard	3-39
Figure 3-20. FDDI Single Mode	3-40
Figure 3-21. FDDI Daughterboard	3-41
Figure 3-22. SRM-Link	3-42
Figure 3-23. SRM-Front	3-43
Figure 3-24. FRE and Daughterboard	3-44

List of Tables

Table 3-1.	5200 and 5201 Dual Port T1 Framer Settings (PN 100831 and 101667)	3-3
Table 3-2.	5250 Dual Port E1 Settings (PN 101337).....	3-5
Table 3-3.	5280 Quad Port Sync Settings (PN 102285).....	3-7
Table 3-4.	5290 Single HSSI Settings (PN 104932).....	3-11
Table 3-5.	5405 Dual Ethernet Settings (PN 100003 or 100809)	3-13
Table 3-6.	5410 Single Sync/Single Ethernet Settings (PN 102296)	3-15
Table 3-7.	5420 Dual Sync/Single Ethernet Settings (PN 102293)	3-17
Table 3-8.	5430 Dual Sync/Dual Ethernet Settings (PN 102279).....	3-19
Table 3-9.	5450 Quad Ethernet Settings (PN 102690).....	3-21
Table 3-10.	5505 Dual Ethernet High Speed Filters Settings (PN 102495)	3-23
Table 3-11.	5530 Dual Sync/Dual Ethernet High Speed Filters Settings (PN 102494)	3-25
Table 3-12.	5705 Single Token Settings (PN 102484)	3-27
Table 3-13.	5710 Dual Token Settings (PN 103366).....	3-29
Table 3-14.	5720 Single Sync/Single Token Settings (PN 102483)	3-31
Table 3-15.	5740 Dual/Sync Single Token Settings (DST-4, PN 101988).....	3-33
Table 3-16.	5740 Dual Sync/Single Token Settings (DST-4/16, PN 101531).....	3-35
Table 3-17.	5740 Dual Sync/Single Token Settings (TS416 1X2, PN 102482)	3-37
Table 3-18.	5930 FDDI Multimode Settings (PN 102675)	3-39
Table 3-19.	5940 FDDI Single Mode Settings (PN 103755).....	3-41

Configuring Hardware Modules

About this Chapter

This chapter shows the jumper and switch settings of the hardware modules in the BN. Both factory-default jumper and switch settings and optional configuration settings are shown.

Each section title in this chapter identifies a board's 4-digit Link Module (LM) model number, name, and 6-digit part number (PN). Before configuring a board, be sure its part number matches the one in the section title. Part numbers are printed on the boards.

Each illustration shows the cable connector panel and the component side of the board. The illustration of the board shows the factory-default positions of the jumpers and switches. The pins that are jumpered on the solder (back) side of the board are *not* configurable. Also, some pins identified as “not configurable” may not appear on the board, depending on the release of the board.

A table after each illustration shows the option (function) of each jumper/switch, a description of the factory-default setting (if configurable), and the associated jumper/switch position.

The term “not configurable” in the Setting column means that changing the setting could jeopardize the functioning of the board. If an option is user-configurable, alternative settings and associated jumper/switch positions are listed after the factory-default setting.

Note: S1 jumpers are *not* included in the drawings and tables. S1 jumpers designate the current revision of the board; they are *not* user-configurable.

5200 and 5201 Dual Port T1 Framer Link Module (PN 100831 and 101667)

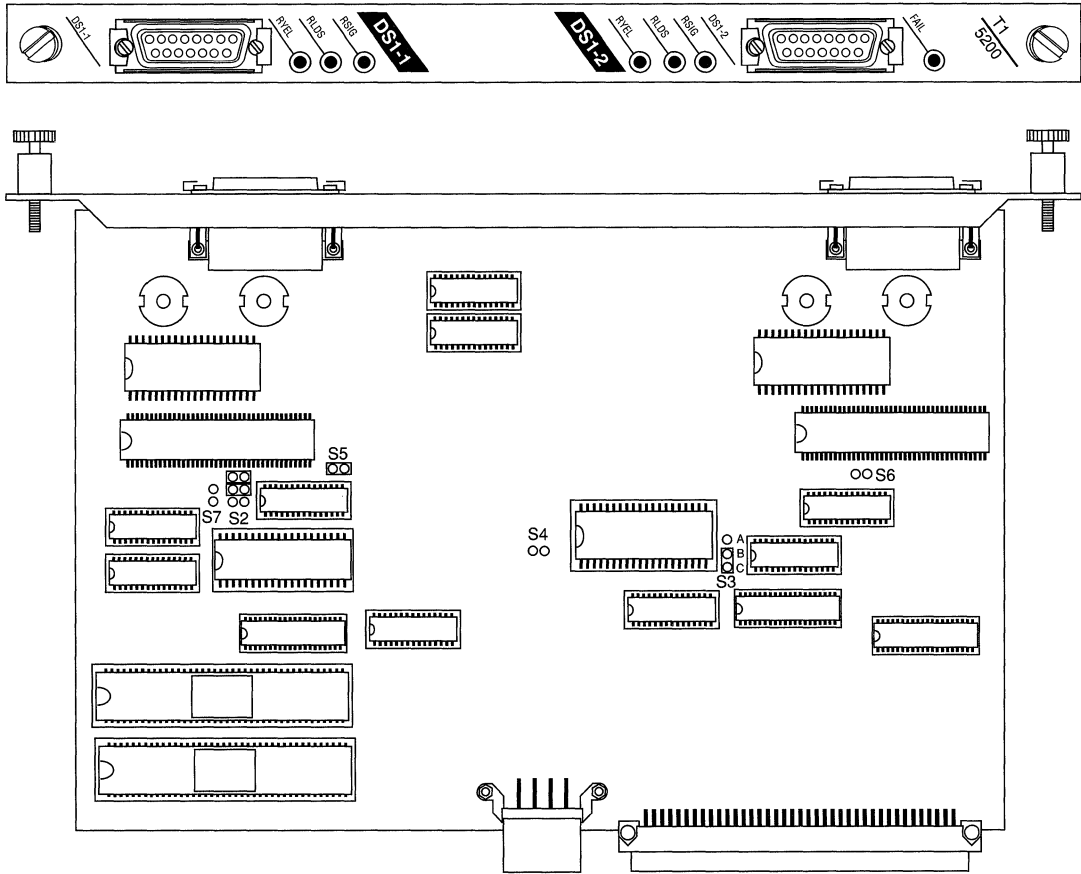









Figure 3-1. Dual Port T1 Framer

Table 3-1. 5200 and 5201 Dual Port T1 Framer Settings (PN 100831 and 101667)

Option	Setting	Jumper
Option	Not configurable	S2 
32-pin EPROM option	Not configurable	S3 
Power for 28-pin EPROM	Not configurable	S4 
Internal clock	Enabled (master)	S5 
	Disabled (slave)	S5 
Unused (Installed on E1)	Not configurable	S6  S7 

The jumper settings for both models (5200 and 5201) are the same.

Note: A T1 framer normally reports a yellow alarm whenever it receives a 0 in Bit 2 of 256 consecutive channels. Wellfleet uses several encoding algorithms to prevent the reporting of a false alarm when a normal data stream happens to contain a 0 in Bit 2 of 256 consecutive channels.

The DACS T1-64K model (Model 5200; PN 101667) uses a proprietary encoding algorithm to accept an all 0's condition without reporting a false yellow alarm. However, a Wellfleet DACS T1-64K must be on the other side of the wire to decode the data.

The DACS T1-56K model (Model 5201; PN 100831) sets Bit 7 of every channel to a 1. This prevents the false yellow alarm by forcing every eighth bit to a 1. Even if an all 0's condition occurs, the 1 maintains framer sync. This method allows the use of any standard T1 framer on the other side of the wire, but reduces the bandwidth to 56K.

5250 Dual Port E1 Link Module (PN 101337)

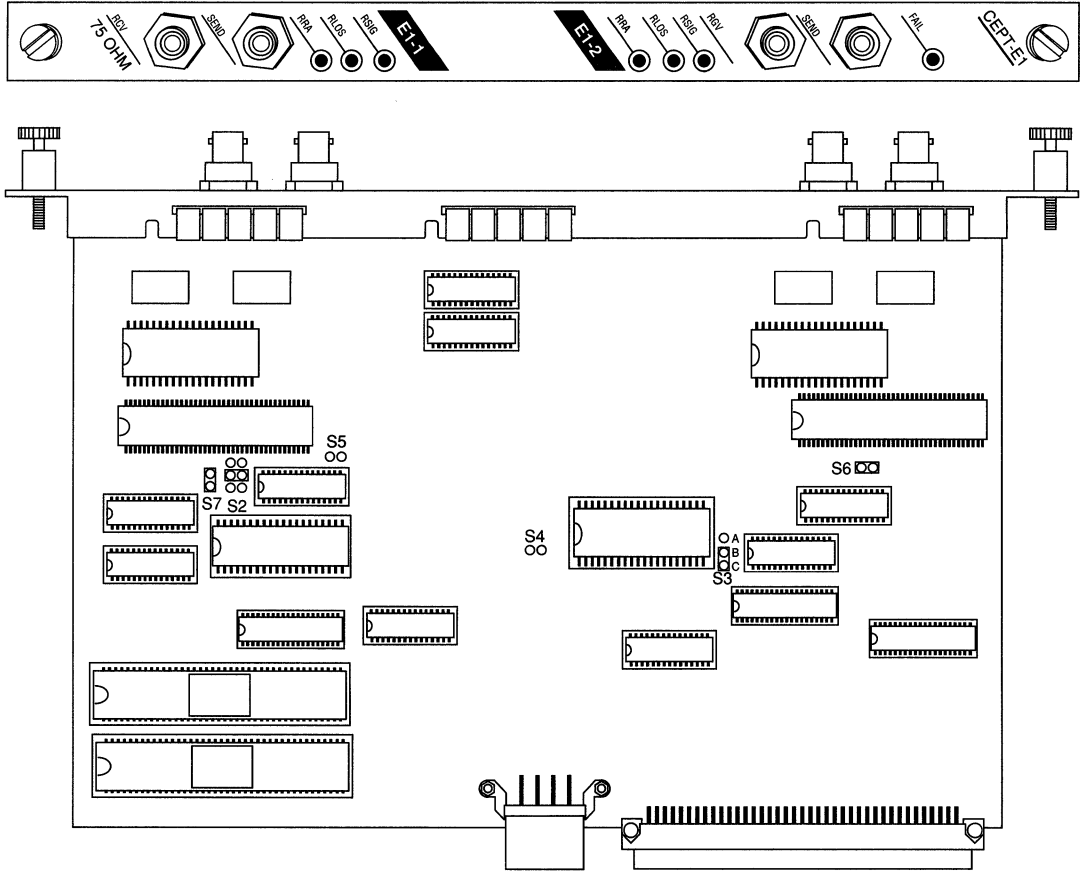









Figure 3-2. Dual Port E1

Table 3-2. 5250 Dual Port E1 Settings (PN 101337)

Option	Setting	Jumper
Option Setting	Not configurable	S2 
Address line for 32-pin EPROM option)	Not configurable	S3 
Power for 28-pin EPROMs	Not configurable	S4 
Internal clock	Enabled (master)	S5 
	Disabled (slave)	S5 
Installed on E1	Not configurable	S6  S7 

5280 Quad Port Sync Link Module (PN 102285)

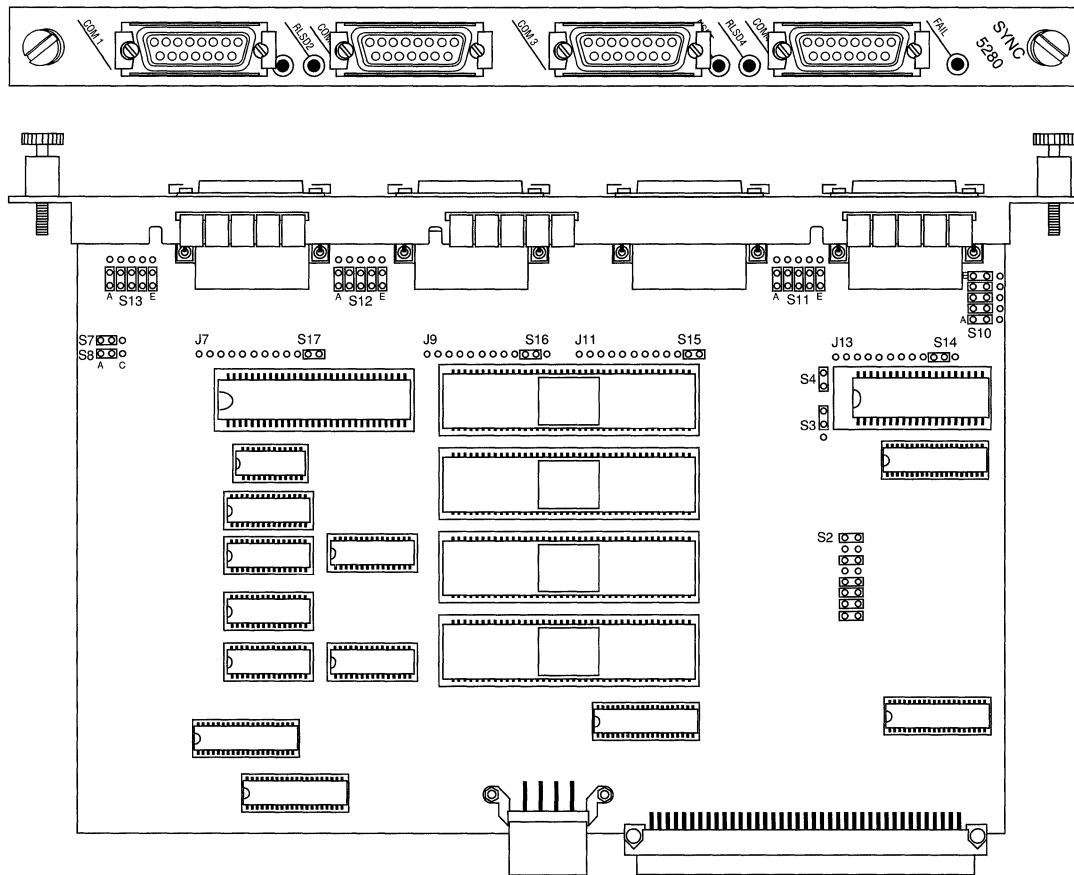

Figure 3-3. Quad Port Sync

Table 3-3. 5280 Quad Port Sync Settings (PN 102285)













Option	Setting	Jumper	Option	Setting	Jumper
Model ID and board option	Not configurable	S2 	Com port 1	Unbalanced signal for RS-232, RS-423, V.28	S10 
	Address line for 32-pin EPROM	Not configurable		S3 	Balanced signal for RS-422, X.21
Power for 28-pin EPROM	Not configurable	S4 	Com port 2	Unbalanced signal for RS-232, RS-423, V.28	S11 
Interface Voltage ±5 or ±12	±12 for RS-232, V.28, V.35	S7  S8 		Balanced signal for RS-422, X.21	S11 
	±5 for RS-422, RS-423, X.21	S7  S8 	Com port 3	Unbalanced signal for RS-232, RS-423, V.28	S12 
		Balanced signal for RS-422, X.21		S12 	
			Options continued on next page		

Table 3-3. 5280 Quad Port Sync Settings (PN 102285), Continued

Option	Setting	Jumper
Com port 4	Unbalanced signal for RS-232, RS-423, V.28	
	Balanced signal for RS-422, X.21	
Daughterboard Note: Each J-to-S row is in a separate location on the board.	Daughterboard <i>not</i> installed	
	Daughterboard <i>not</i> installed	

This page is intentionally left blank.

5290 Single HSSI Link Module (PN 104932)

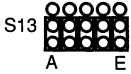
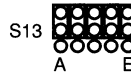
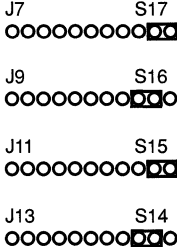
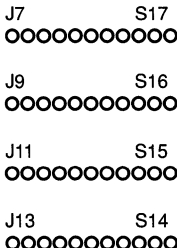
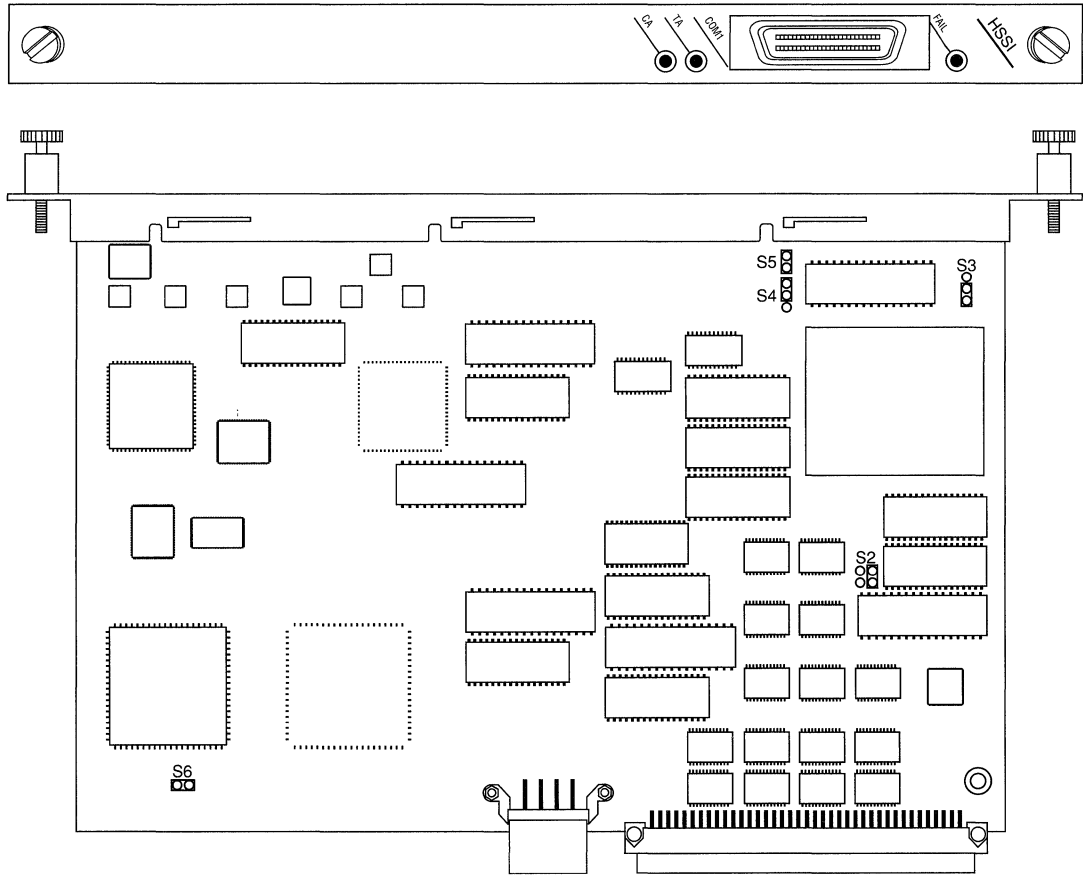







Figure 3-4. Single HSSI

Table 3-4. 5290 Single HSSI Settings (PN 104932)

Option	Setting	Jumper
Options	Not configurable (Single HSSI)	S2 
PROM Configuration	Not configurable	S3 
PROM Configuration	Not configurable	S4 
PROM Configuration	Not configurable	S5 
Clock select	Not configurable	S6 

5405 Dual Ethernet Link Module (PN 100003 or 100809)

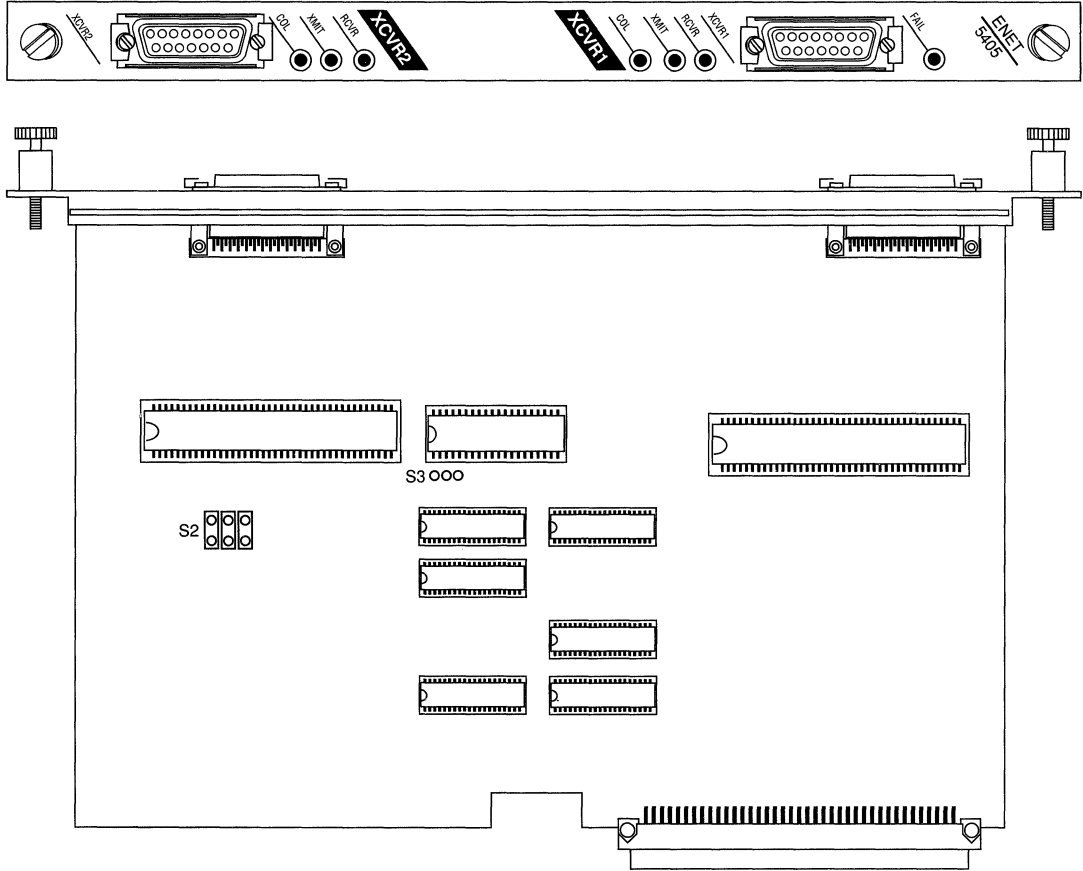



Figure 3-5. Dual Ethernet

Table 3-5. 5405 Dual Ethernet Settings (PN 100003 or 100809)

Option	Setting	Jumper
Model ID and board option Note: This jumper may be hard-wired.	Not configurable	S2 
32-bit EPROM option	Not configurable	S3 000

5410 Single Sync/Single Ethernet Link Module (PN 102296)

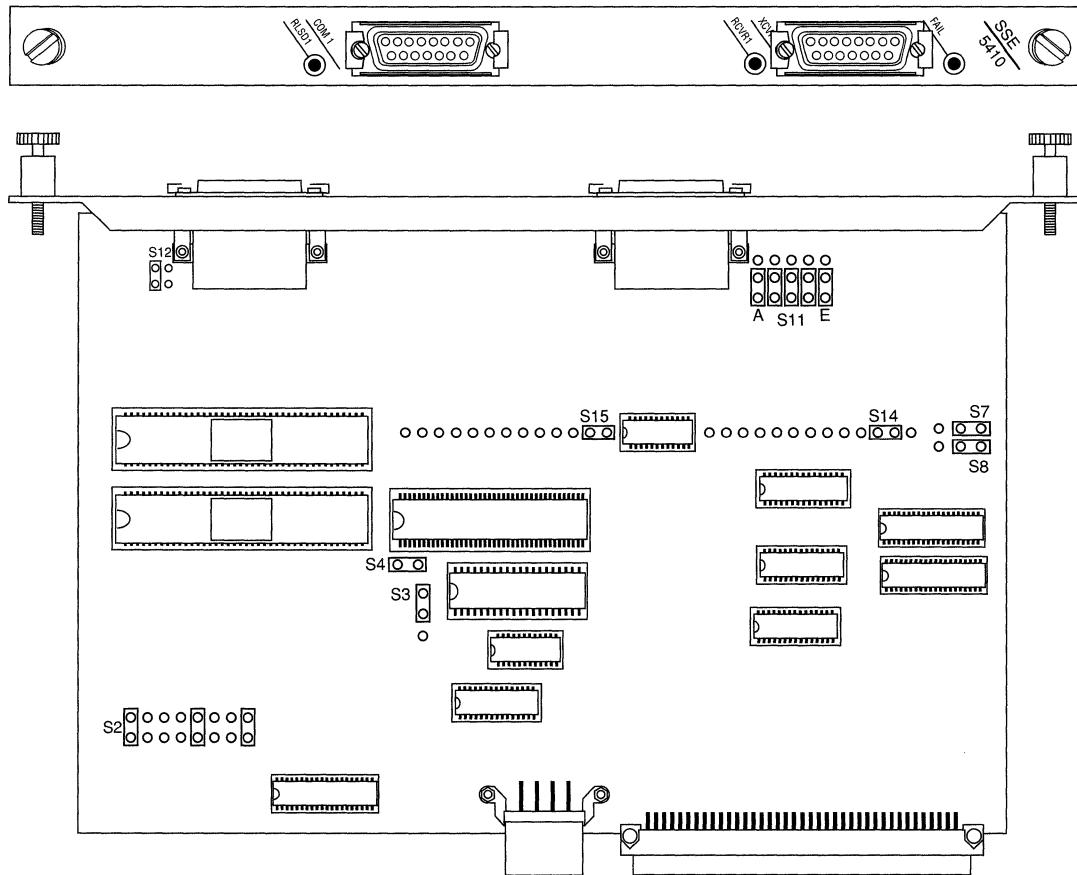

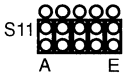

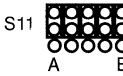



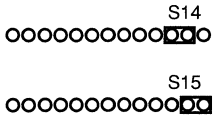



Figure 3-6. Single Sync/Single Ethernet

Table 3-6. 5410 Single Sync/Single Ethernet Settings (PN 102296)

Option	Setting	Jumper	Option	Setting	Jumper
Model ID and board option	Not configurable	S2 	Com port 1	Unbalanced signal for RS-232, RS-423, V.28	S11 
Address line for 32-pin EPROM	Not configurable	S3 		Balanced signal for RS-422, X.21	S11 
Power for 28-pin EPROM	Not configurable	S4 	Chassis ground connection for unused pins on J1	Not configurable	S12 
Interface Voltage ±5 or ±12	±12 for RS-232, V.28, V.35	S7  S8 	Installation of V.35 daughter-board	Not configurable	
	±5 for RS-422, RS-423, X.21	S7  S8 			

5420 Dual Sync/Single Ethernet Link Module (PN 102293)

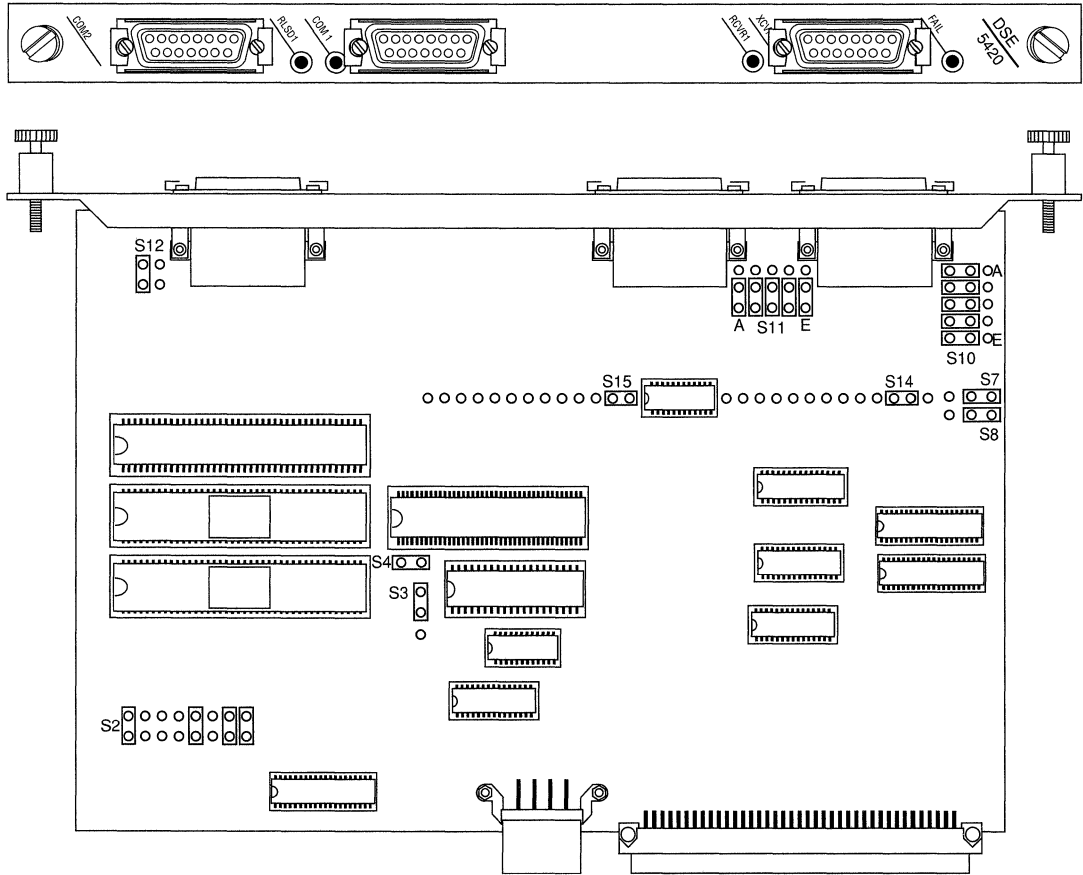

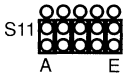

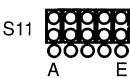



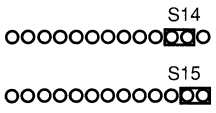

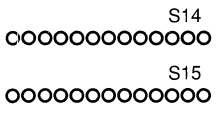
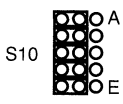
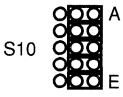

Figure 3-7. Dual Sync/Single Ethernet

Table 3-7. 5420 Dual Sync/Single Ethernet Settings (PN 102293)

Option	Setting	Jumper	Option	Setting	Jumper
Model ID and board option	Not configurable	S2 	Com port 1	Unbalanced signal for RS-232, RS-423, V.28	S11 
	Address line for 32-pin EPROM	S3 		Balanced signal for RS-422, X.21	S11 
Power for 28-pin EPROM	Not configurable	S4 	Chassis ground connection for unused pins on J1	Not configurable	S12 
Interface Voltage ±5 or ±12	±12 for RS-232, V.28, V.35	S7 	Installation of V.35 daughter-board	V.35 daughter-board <i>not</i> installed	S14 
	±5 for RS-422, RS-423, X.21	S7 		V.35 daughter-board installed	S14 
Com port 2	Unbalanced signal for RS-232, RS-423, V.28	S10 		Balanced signal for RS-422, X.21	S10 

5430 Dual Sync/Dual Ethernet Link Module (PN 102279)

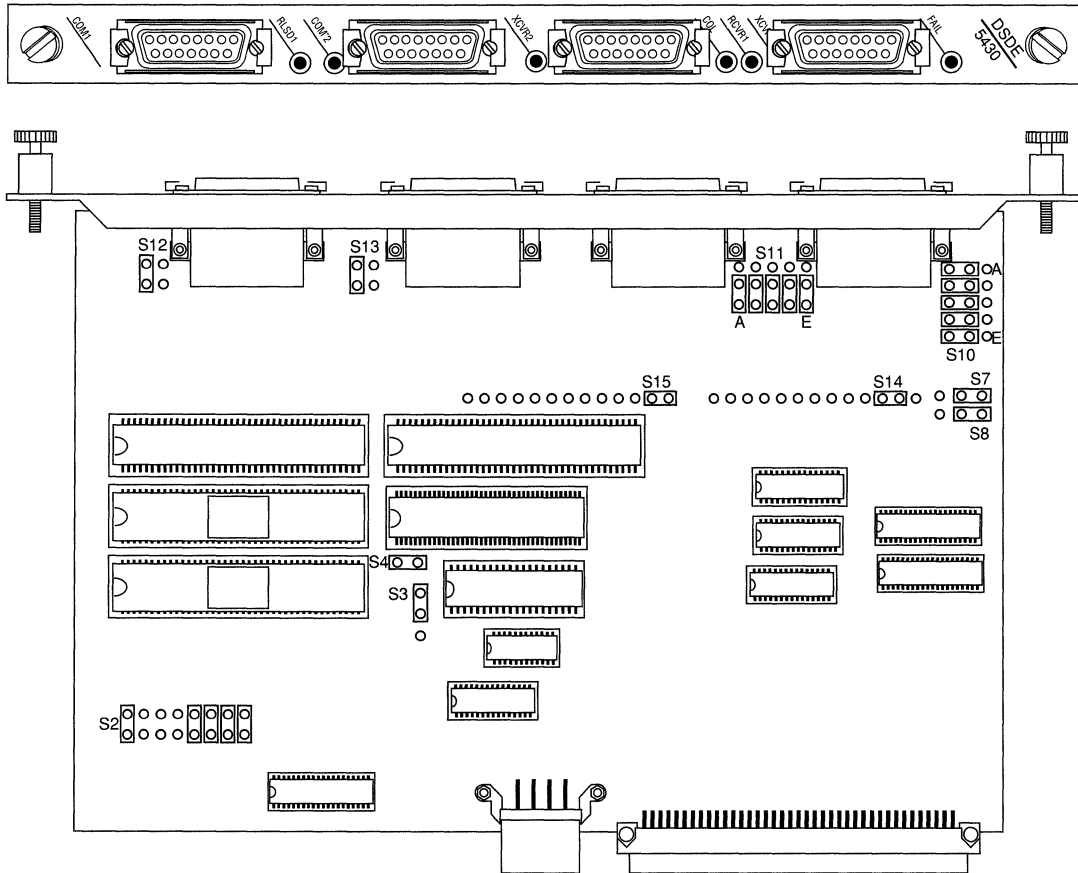

















Figure 3-8. Dual Sync/Dual Ethernet

Table 3-8. 5430 Dual Sync/Dual Ethernet Settings (PN 102279)

Option	Setting	Jumper	Option	Setting	Jumper
Model ID and board option	Not configurable	S2 	Com port 1	Unbalanced signal for RS-232, RS-423, V.28	S11 
Address line for 32-pin EPROM	Not configurable	S3 		Balanced signal for RS-422, X.21	S11 
Power for 28-pin EPROM	Not configurable	S4 	Chassis ground connection for unused pins on J1	Not configurable	S12 
Interface Voltage ±5 or ±12	±12 for RS-232, V.28, V.35	S7  S8 	Chassis ground connection for unused pins on J2	Not configurable	S13 
	±5 for RS-422, RS-423, X.21	S7  S8 		Installation of V.35 daughter-board	V.35 daughter-board <i>not</i> installed
Com port 2	Unbalanced signal for RS-232, RS-423, V.28	S10 		V.35 daughter-board installed	S14  S15 
	Balanced signal for RS-422, X.21	S10 			

5450 Quad Ethernet Link Module (PN 102690)

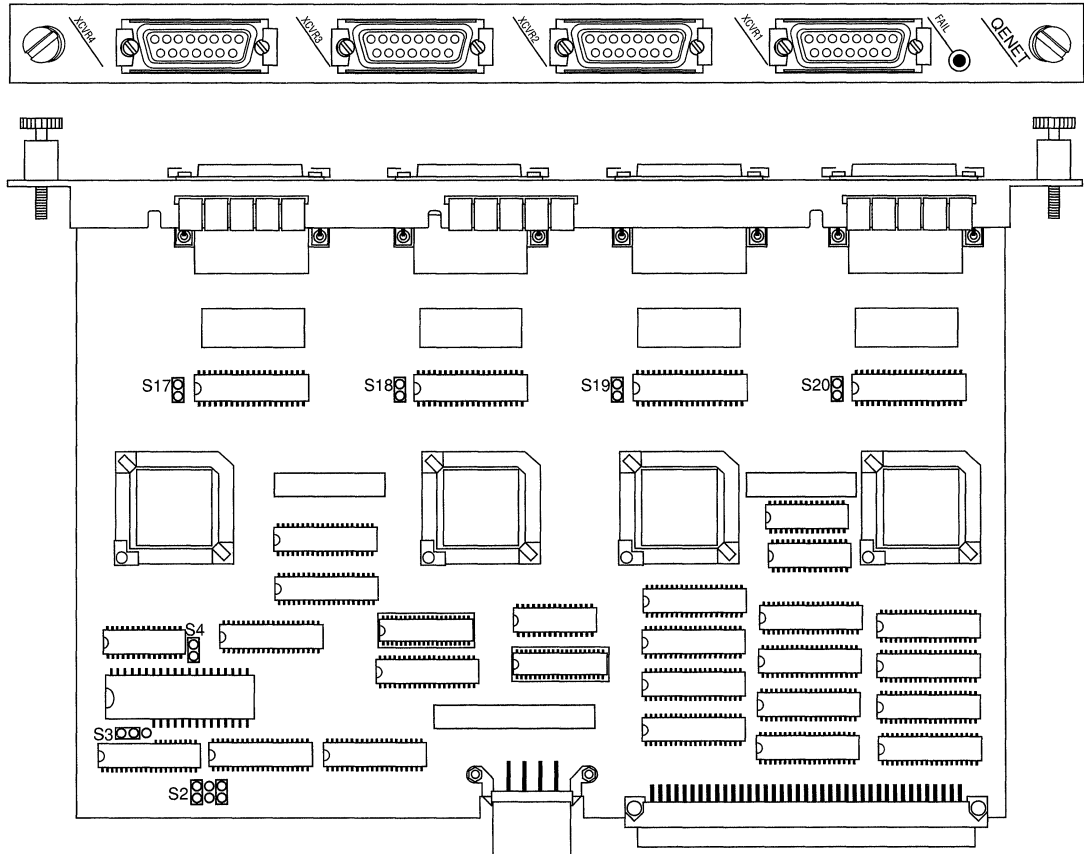
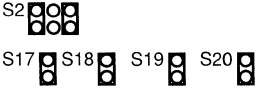
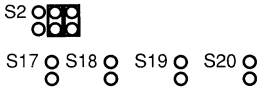



Figure 3-9. Quad Ethernet

Table 3-9. 5450 Quad Ethernet Settings (PN 102690)

Option	Setting	Jumper
Daughterboard Note: The jumpers are in separate locations on the board.	Daughterboard <i>not</i> installed (<i>not</i> customer-configurable)	
	Daughterboard installed (<i>not</i> customer-configurable)	
512 K EPROM	(not configurable)	

5505 Dual Ethernet High Speed Filters Link Module (PN 102495)

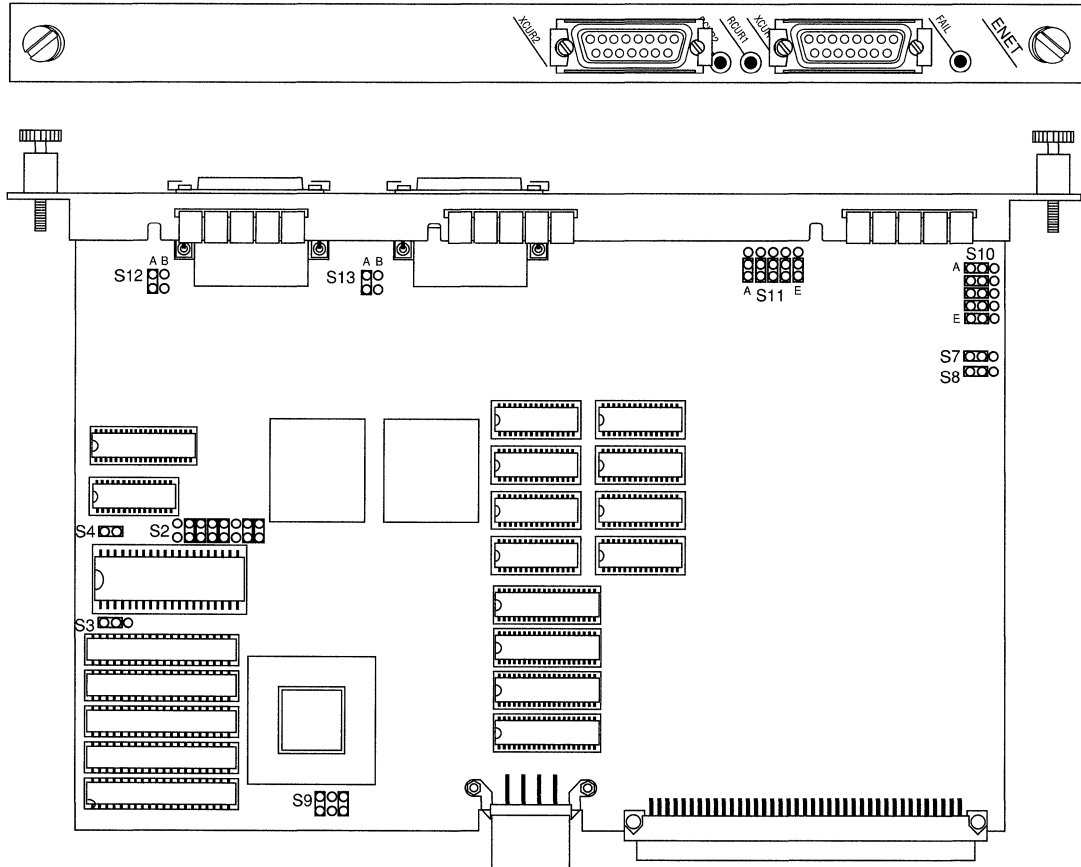







Figure 3-10. Dual Ethernet High Speed Filters

Table 3-10. 5505 Dual Ethernet High Speed Filters Settings (PN 102495)

Option	Setting	Jumper
Model ID and board option	Not configurable	S2 
Address line for 32-pin EPROM	Not configurable	S3 
Power for 28-pin EPROM	Not configurable	S4 
2 cams installed	Not configurable	S9 
Chassis ground connection for unused pins on J1	Not configurable	S12 
Chassis ground connection for unused pins on J2	Not configurable	S13 

Note: The S7, S8, S10, and S11 pins have no function on this board, and may or may not be installed.

5530 Dual Sync/Dual Ethernet High Speed Filters Link Module (PN 102494)

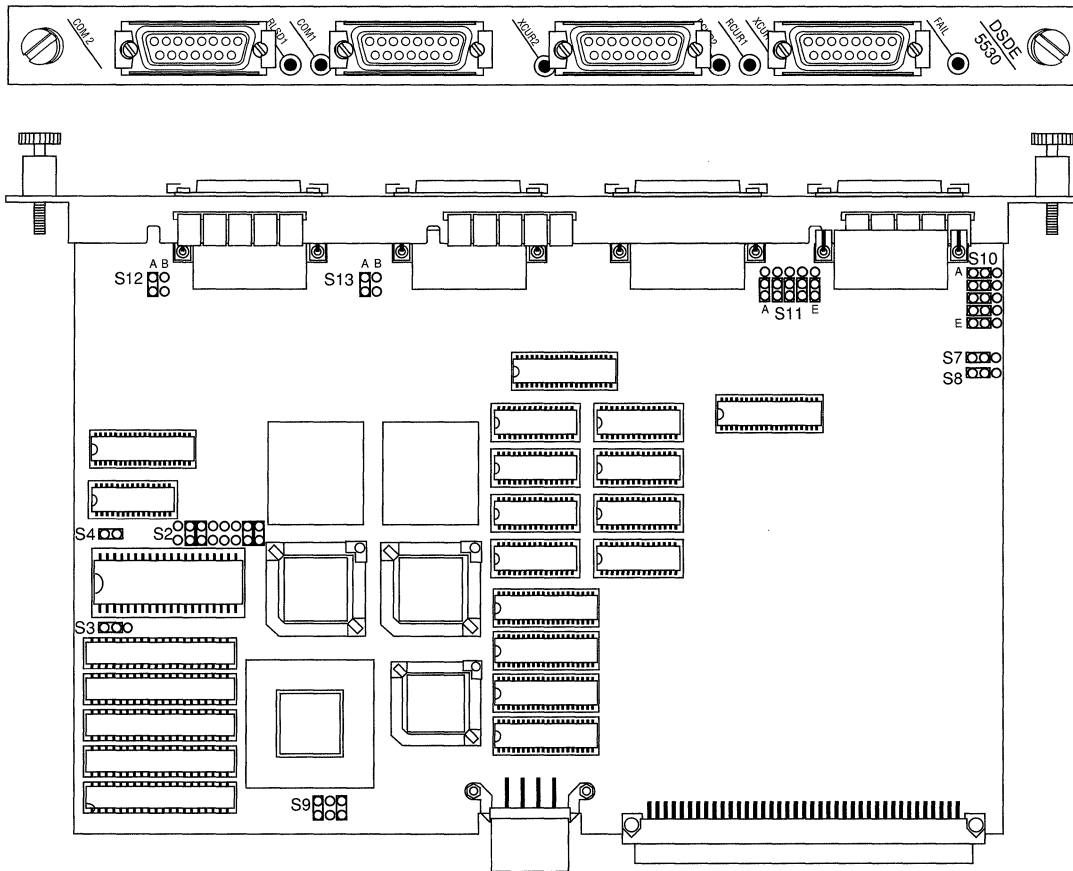

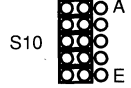

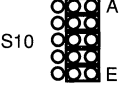

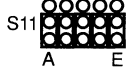

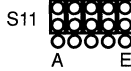







Figure 3-11. Dual Sync/Dual Ethernet High Speed Filters

Table 3-11. 5530 Dual Sync/Dual Ethernet High Speed Filters Settings (PN 102494)

Option	Setting	Jumper	Option	Setting	Jumper
Model ID and board option:	Not configurable	S2 	Com port 2	Unbalanced signal for RS-232, RS-423, V.28	S10 
Address line for 32-pin EPROM	Not configurable	S3 		Balanced signal for RS-422, X.21	S10 
Power for 28-pin EPROM	Not configurable	S4 	Com port 1	Unbalanced signal for RS-232, RS-423, V.28	S11 
Interface Voltage ± 5 or ± 12	± 12 for RS-232, V.28, V.35	S7  S8 		Balanced signal for RS-422, X.21	S11 
	± 5 for RS-422, RS-423, X.21	S7  S8 	Chassis ground connection for unused pins on J1	Not configurable	S12 
2 cams installed	Not configurable	S9 	Chassis ground connection for unused pins on J2	Not configurable	S13 

5705 Single Token Link Module (PN 102484)

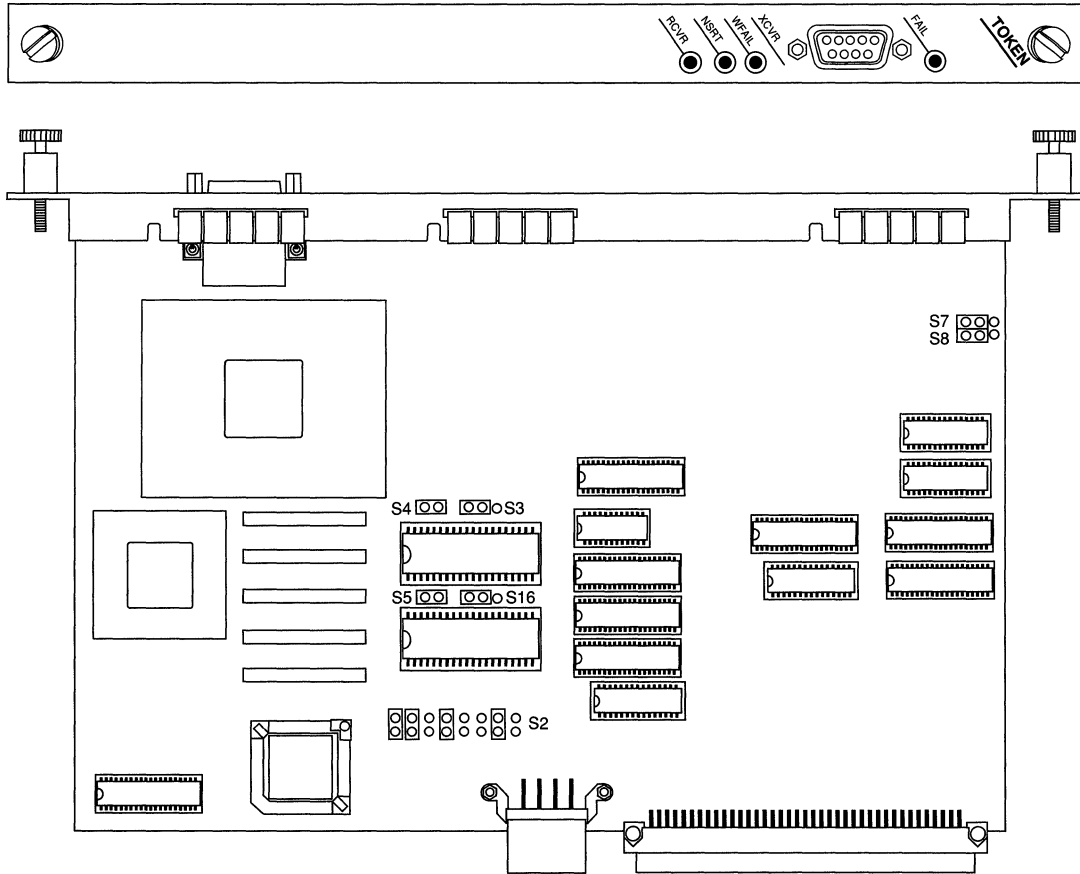









Figure 3-12. Single Token

Table 3-12. 5705 Single Token Settings (PN 102484)

Option	Setting	Jumper
Model ID and board option	Not configurable	S2 
Address line for 32-pin EPROM at U39	Not configurable	S3 
Power for 28-pin EPROM at U39	Not configurable	S4 
Power for 28-pin EPROM at 50	Not configurable	S5 
Reserved for future use	Not configurable	S7  S8 
Address line for 32-pin EPROM at U50	Not configurable	S16 

5710 Dual Token Link Module (PN 103366)

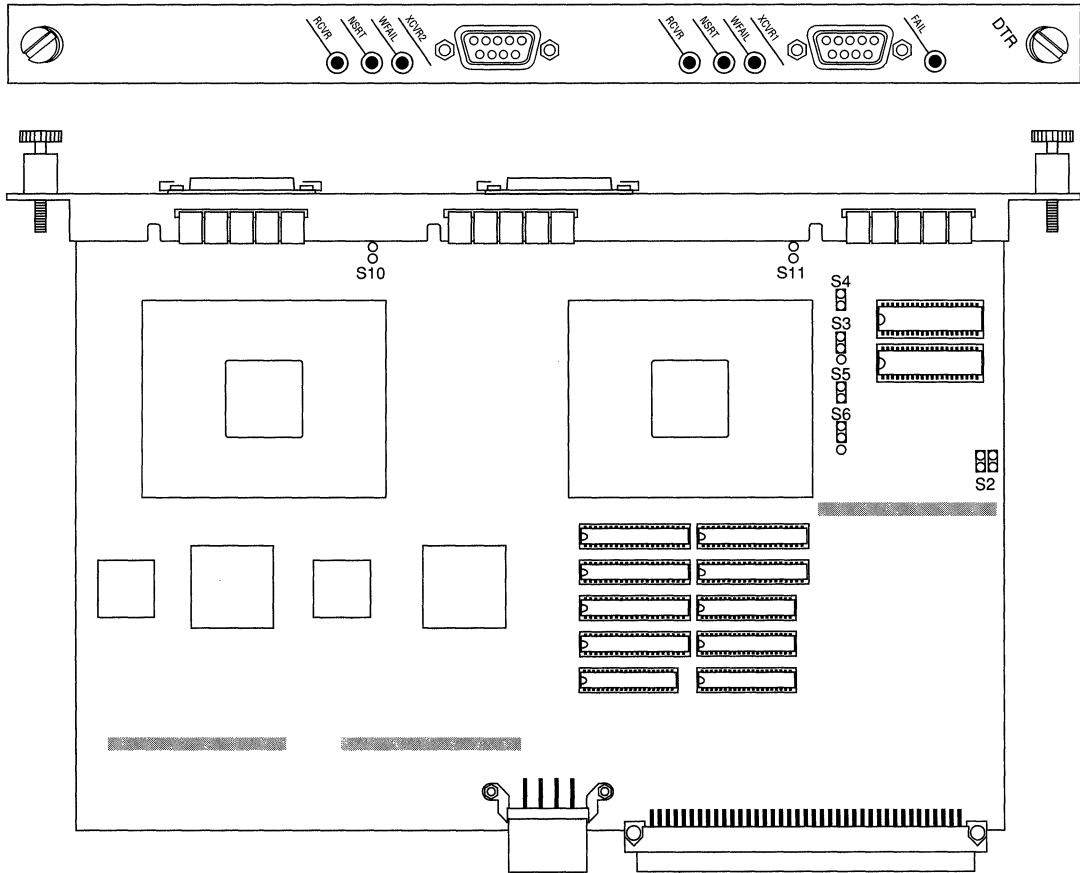









Figure 3-13. Dual Token

Table 3-13. 5710 Dual Token Settings (PN 103366)

Option	Setting	Jumper
Board Option	Not configurable	 S2
Address line for diagnostic EPROM at U8	Not configurable	 S3
Power for diagnostic EPROM at U8	Not configurable	 S4
Power for BUD/MAC EPROM at U11	Not configurable	 S5
Address line for BUD/MAC EPROM at U11	Not configurable	 S6
Reserved for future use	Not configurable	 S10
Reserved for future use	Not configurable	 S11

5720 Single Sync/Single Token Link Module (PN 102483)

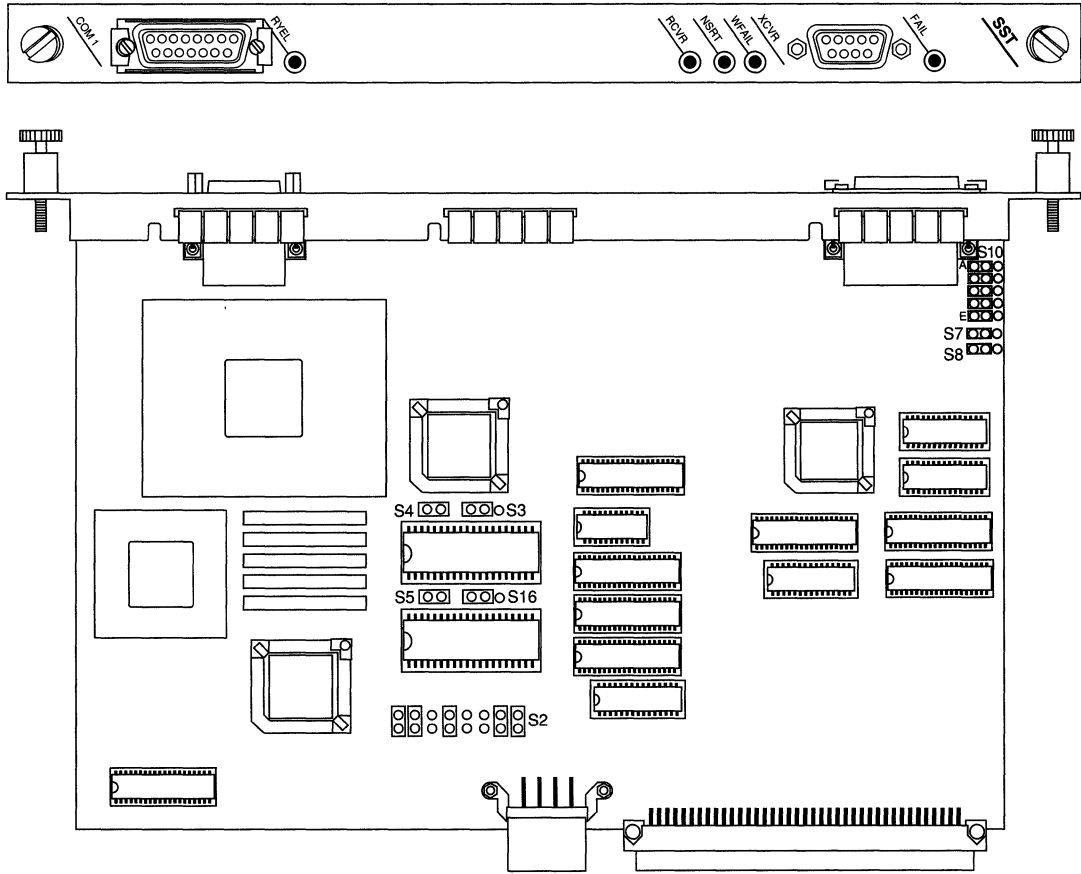













Figure 3-14. Single Sync/Single Token

Table 3-14. 5720 Single Sync/Single Token Settings (PN 102483)

Option	Setting	Jumper
Model ID and board option	Not configurable	S2 
Address line for 32-pin EPROM at U39	Not configurable	S3 
Power for 28-pin EPROM at U39	Not configurable	S4 
Power for 28-pin EPROM at U50	Not configurable	S5 
Address line for 32-pin EPROM at U50	Not configurable	S16 
Interface Voltage ±5 or ±12	±12 for RS-232, V.28, V.35	S7  S8 
	±5 for RS-422, RS-423, X.21	S7  S8 
Com port 1	Unbalanced signal for RS-232, RS-423, V.28	S10 
	Balanced signal for RS-422, X.21	S10 

5740 Dual Sync/Single Token Link Module (DST-4, PN 101988)

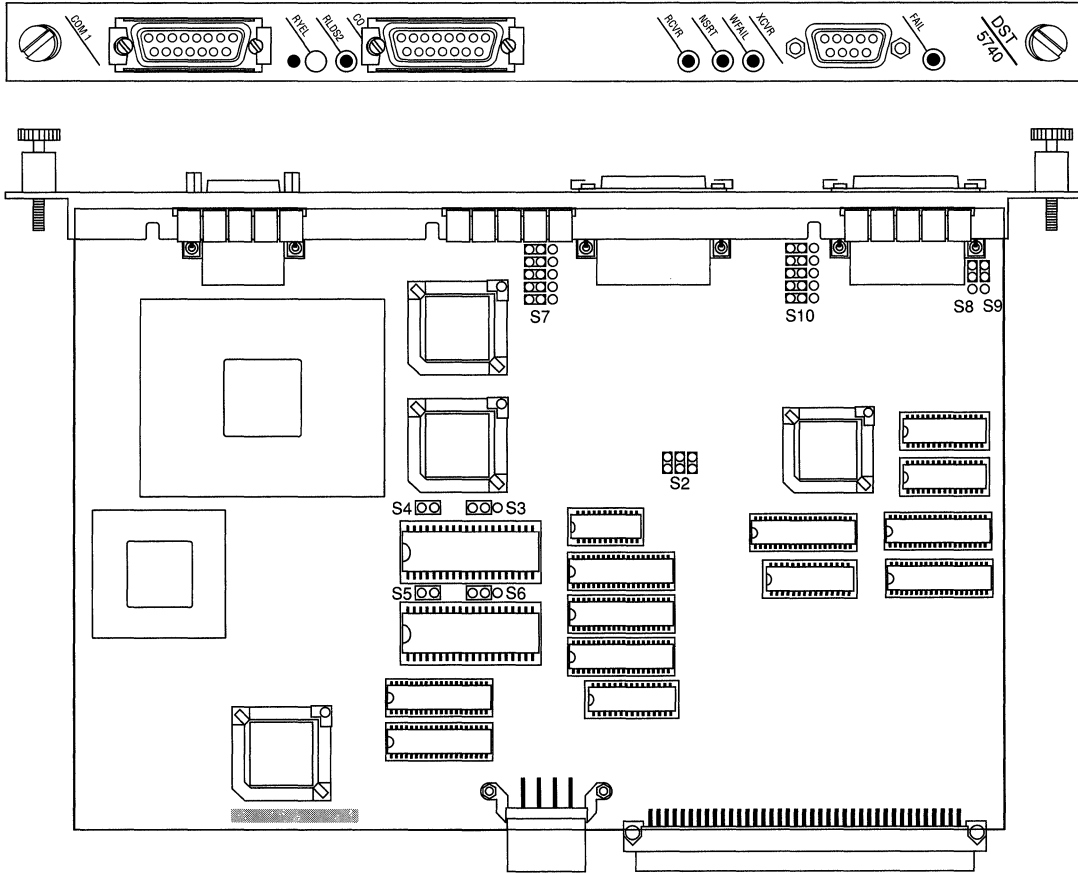













Figure 3-15. Dual Sync/Single Token (DST-4)

Table 3-15. 5740 Dual/Sync Single Token Settings (DST-4, PN 101988)

Option	Setting	Jumper	Option	Setting	Jumper
Model ID and board option	Not configurable	S2 	Com port 2	Unbalanced signal for RS-232, RS-423, V.28	S7 
32-bit EPROM option at V36	Not configurable	S3 		Balanced signal for RS-422, X.21	S7 
Power for 28-pin EPROM	Not configurable	S4 	Interface Voltage ± 5 or ± 12	± 12 for RS-232, V.28, V.35	S8 
Power for 28-pin EPROM at U48	Not configurable	S5 		± 5 for RS-422, RS-423, X.21	S8 
32-bit EPROM option at U48	Not configurable	S6 	Com port 1	Unbalanced signal for RS-232, RS-423, V.28	S10 
				Balanced signal for RS-422, X.21	S10 

5740 Dual Sync/Single Token Link Module (DST-4/16, PN 101531)

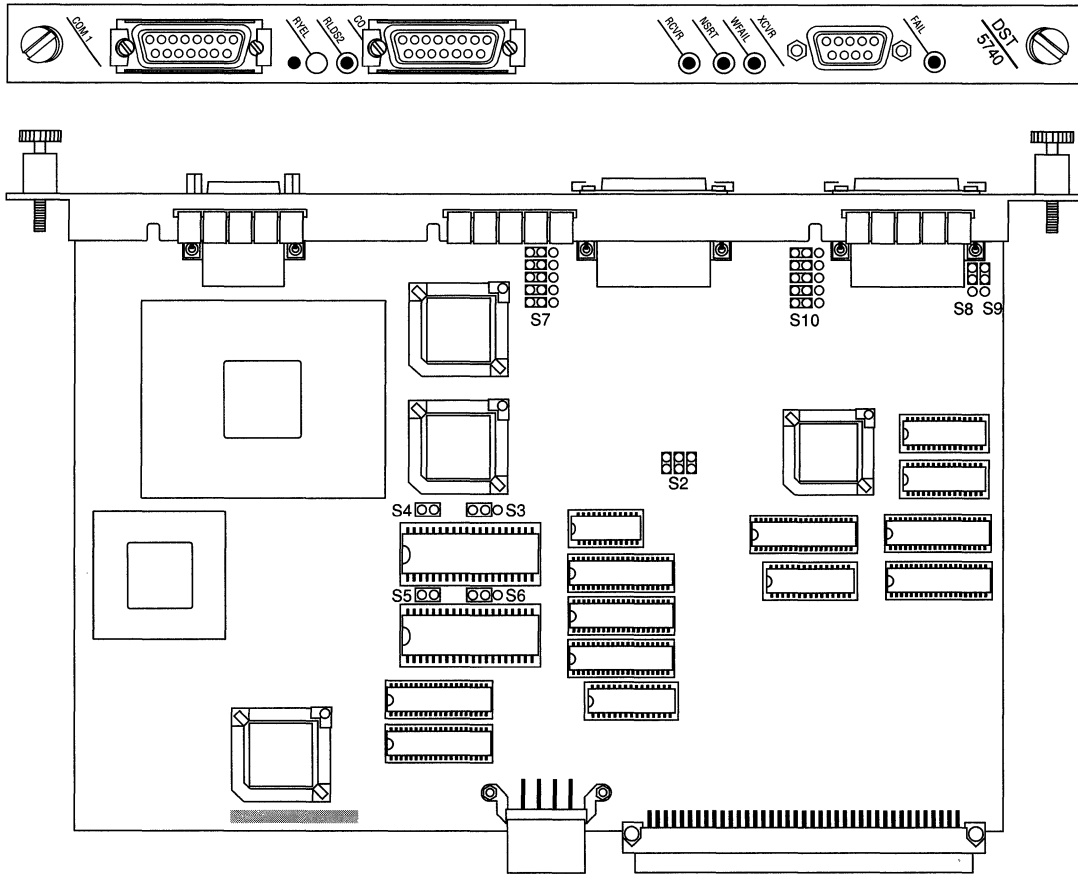













Figure 3-16. Dual Sync/Single Token (DST-4/16)

Table 3-16. 5740 Dual Sync/Single Token Settings (DST-4/16, PN 101531)

Option	Setting	Jumper	Option	Setting	Jumper
Model ID and board option	Not configurable	S2 	Com port 2	Unbalanced signal for RS-232, RS-423, V.28	S7 
32-bit EPROM option at V36	Not configurable	S3 		Balanced signal for RS-422, X.21	S7 
Power for 28-pin EPROM	Not configurable	S4 	Interface Voltage ± 5 or ± 12	± 12 for RS-232, V.28, V.35	S8 S9 
Power for 28-pin EPROM at U48	Not configurable	S5 		± 5 for RS-422, RS-423, X.21	S8 S9 
32-bit EPROM option at U48	Not configurable	S6 	Com port 1	Unbalanced signal for RS-232, RS-423, V.28	S10 
				Balanced signal for RS-422, X.21	S10 

5740 Dual Sync/Single Token Link Module (TS416 1X2, PN 102482)

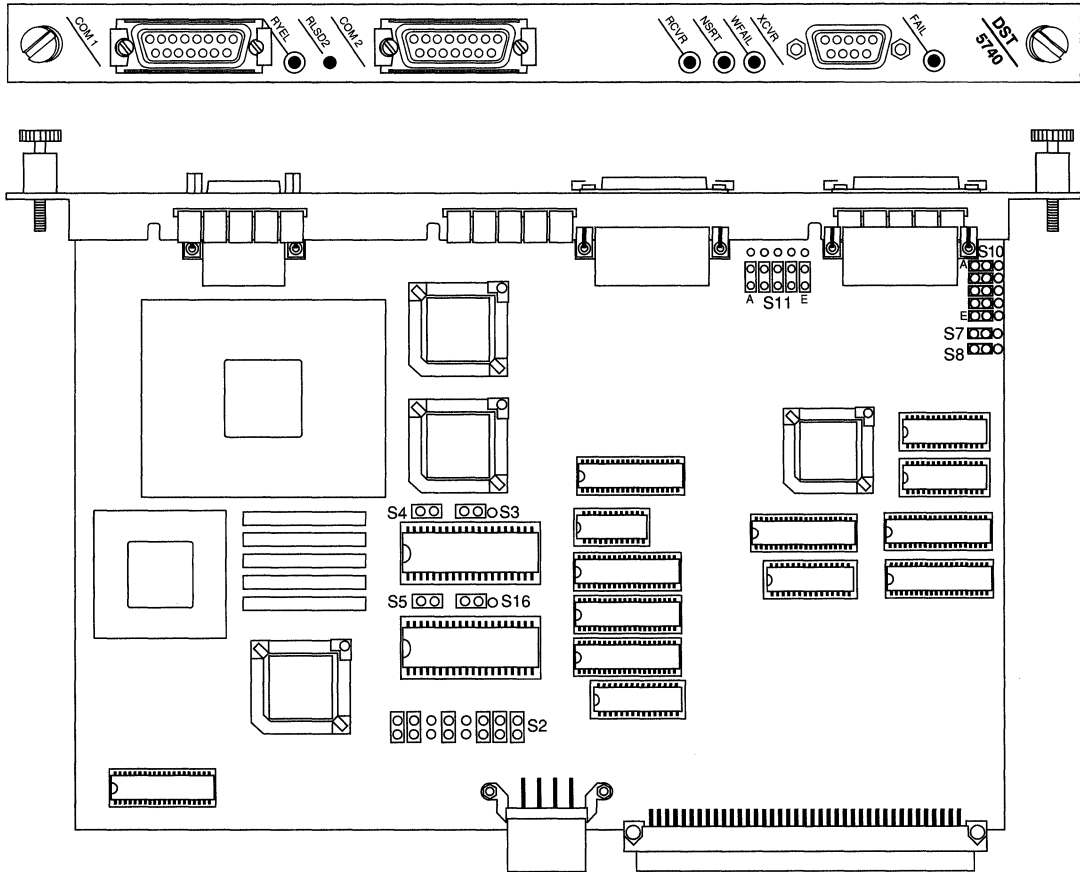















Figure 3-17. Dual Sync/Single Token (TS416 1X2)

Table 3-17. 5740 Dual Sync/Single Token Settings (TS416 1X2, PN 102482)

Option	Setting	Jumper	Option	Setting	Jumper
Model ID and board option	Not configurable	S2 	Interface Voltage ± 5 or ± 12	± 12 for RS-232, V.28, V.35	S7  S8 
Address line for 32-pin EPROM at U39	Not configurable	S3 		± 5 for RS-422, RS-423, X.21	S7  S8 
Power for 28-pin EPROM at U39	Not configurable	S4 	Com port 1	Unbalanced signal for RS-232, RS-423, V.28	S10 
Power for 28-pin EPROM at 50	Not configurable	S5 		Balanced signal for RS-422, X.21	S10 
Address line for 32-pin EPROM at U50	Not configurable	S16 	Com port 2	Unbalanced signal for RS-232, RS-423, V.28	S11 
				Balanced signal for RS-422, X.21	S11 

5930 FDDI Multimode Link Module (PN 102675) and 4995 Daughterboard (PN 103269)

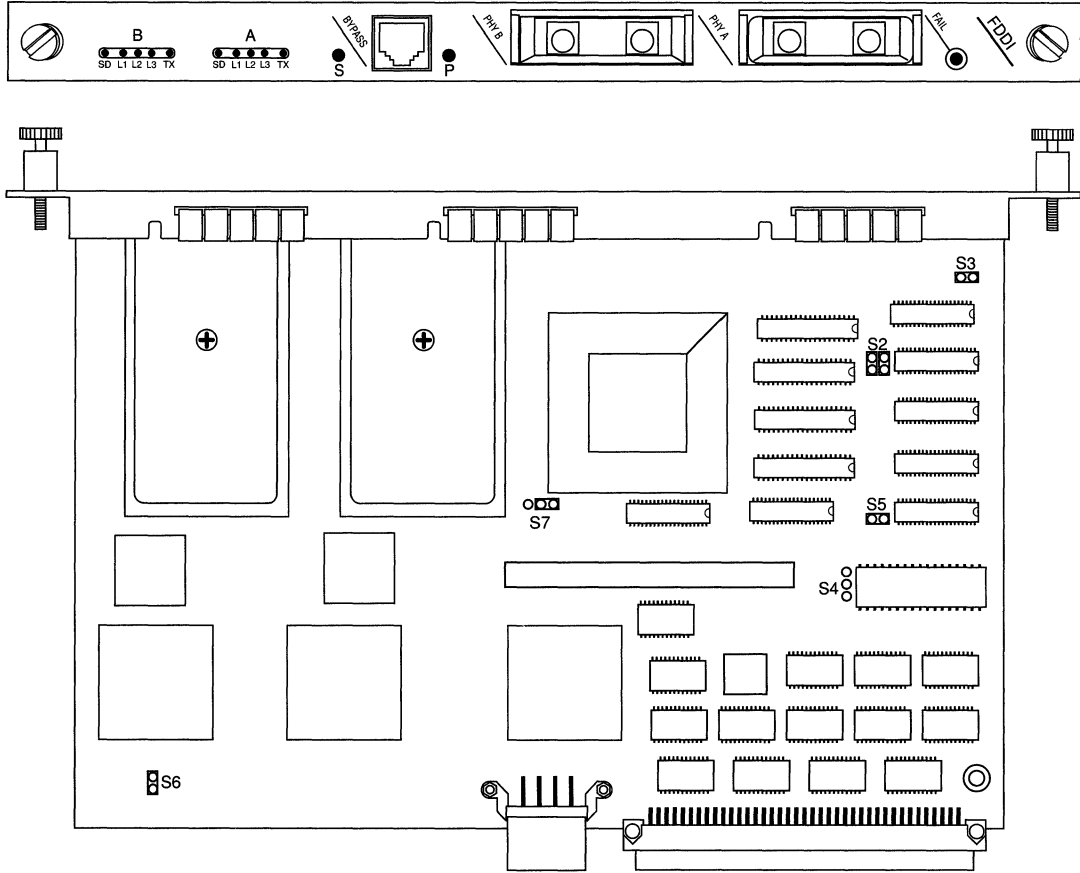







Figure 3-18. FDDI Multimode

Table 3-18. 5930 FDDI Multimode Settings (PN 102675)

Option	Setting	Jumper	Option	Setting	Jumper
Options	Not configurable	S2 	PROM Configuration	Not configurable	S5 
PROM Configuration	Not configurable	S3 	Clock select	Not configurable	S6 
PROM Configuration	Not configurable	S4 	Future compatibility	Not configurable	S7 

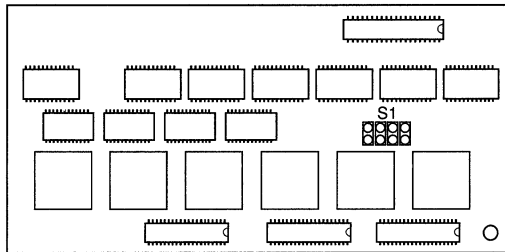

Figure 3-19. FDDI Daughterboard

The FDDI Daughterboard does *not* have user-configurable jumpers or switches.

5940 FDDI Single Mode Link Module (PN 103755) and 4995 Daughterboard (PN 103269)

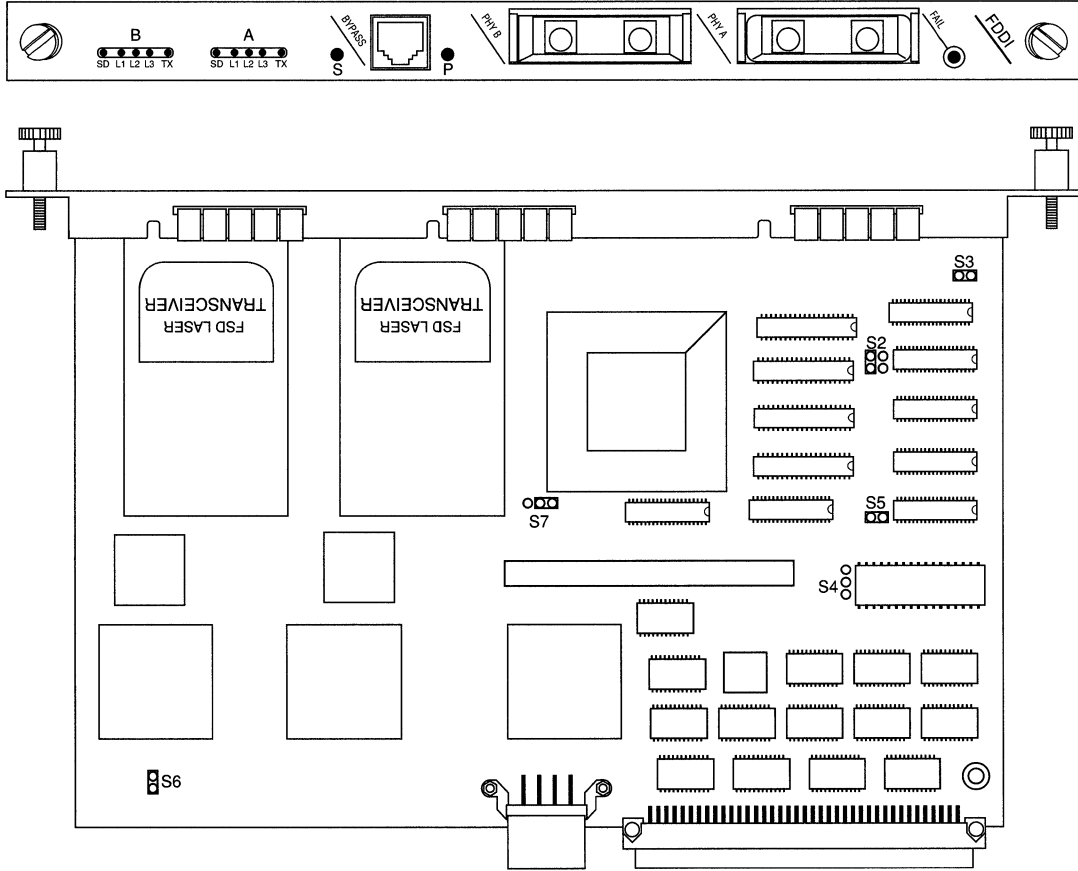







Figure 3-20. FDDI Single Mode

Table 3-19. 5940 FDDI Single Mode Settings (PN 103755)

Option	Setting	Jumper	Option	Setting	Jumper
Options	Not configurable	S2 	PROM Configuration	Not configurable	S5 
PROM Configuration	Not configurable	S3 	Clock select	Not configurable	S6 
PROM Configuration	Not configurable	S4 	Future compatibility	Not configurable	S7 

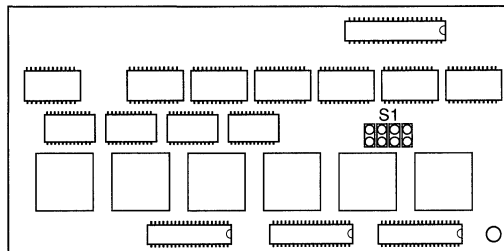

Figure 3-21. FDDI Daughterboard

The FDDI Daughterboard does *not* have user-configurable jumpers or switches.

75000 System Resource Module-Link (PN 103782)

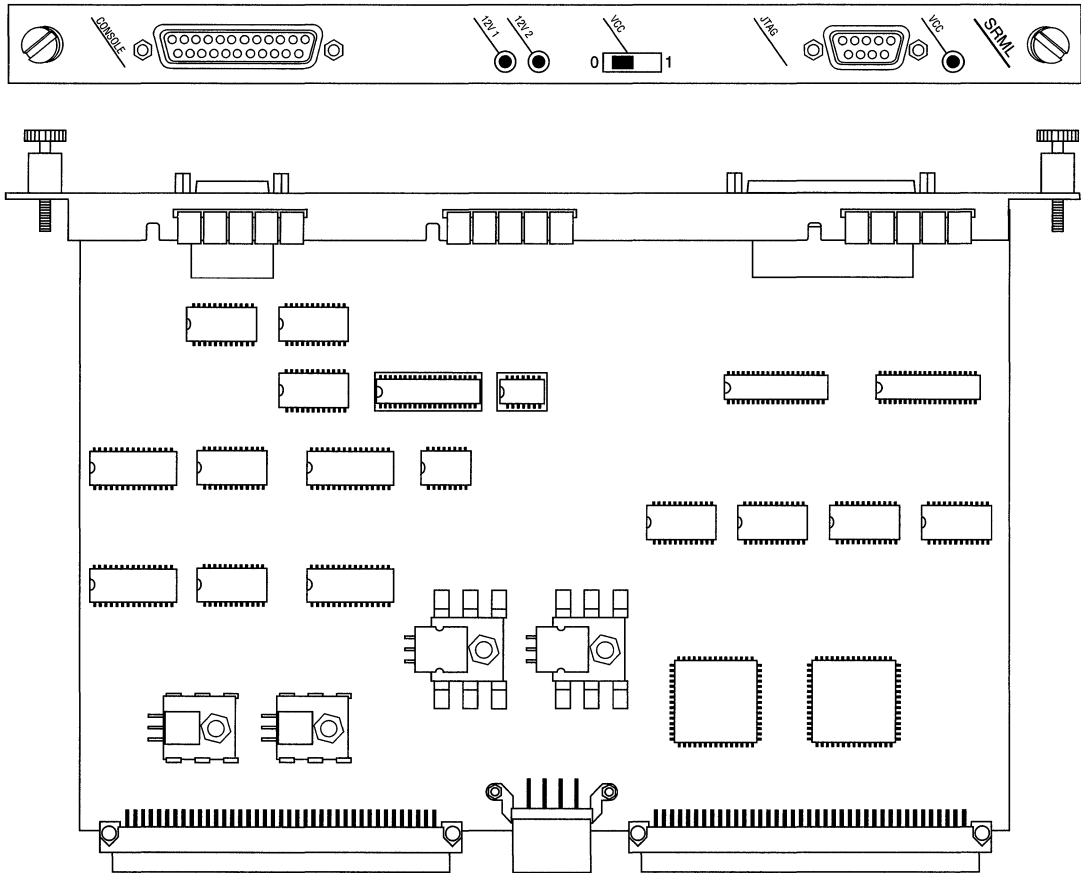

Figure 3-22. SRM-Link

Note: This board does *not* contain jumpers or switches.

C 75010 System Resource Module-Front (PN 103985)

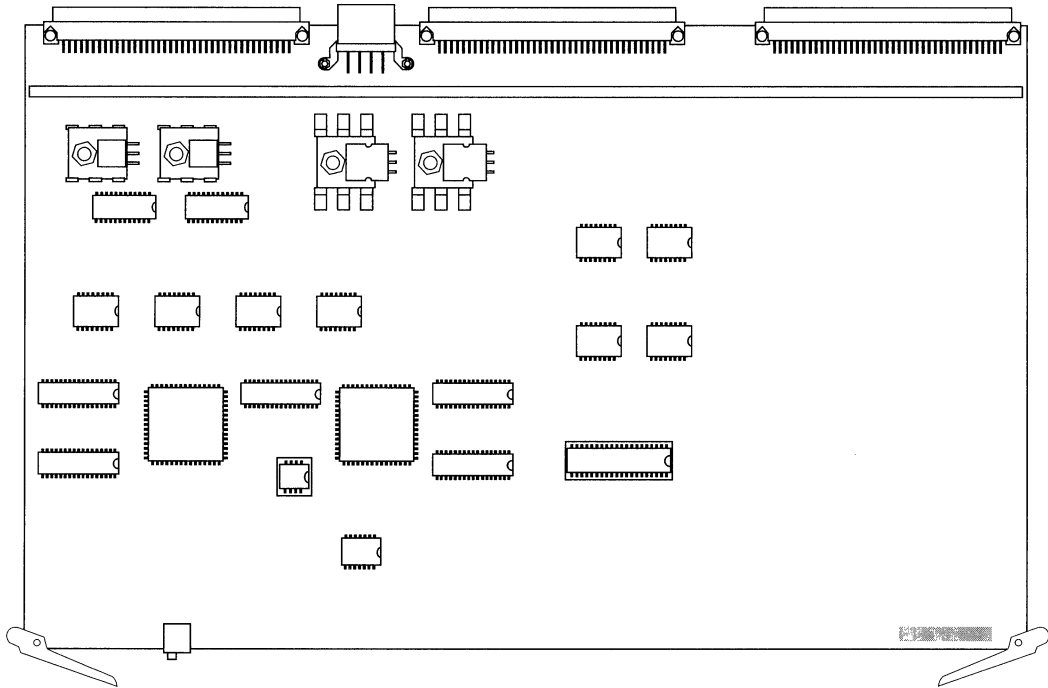

Figure 3-23. SRM-Front

Note: This board does *not* contain jumpers or switches.

75150 Fast Routing Engine (PN 103790) and Daughterboard (PN 102713)

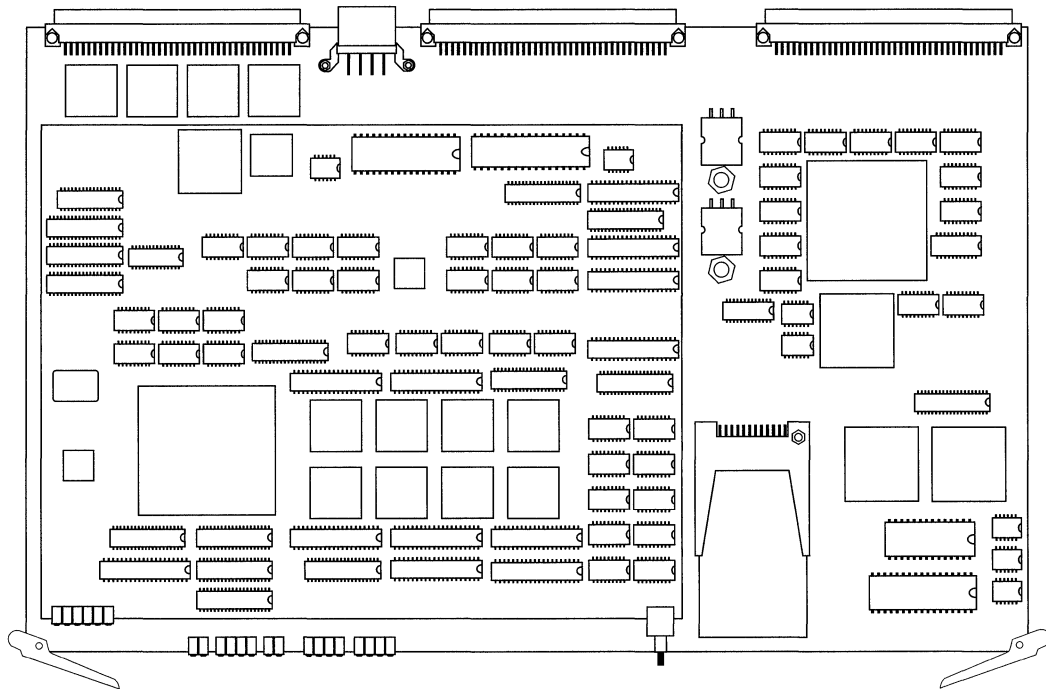

Figure 3-24. FRE and Daughterboard

Note: This board does *not* contain jumpers or switches.

Chapter 4

Switches and LEDs

About this Chapter	4-1
Front Panel	4-2
Rear Panel	4-4
SRM-L LEDs	4-4
E1 and T1 LEDs	4-5
Ethernet LEDs	4-6
FDDI LEDs	4-7
HSSI LEDs	4-9
Sync LEDs	4-10
Token Ring LEDs	4-11
BCN 620 Watt Hot Swap Power Module LED	4-12
SRM-F and FRE Modules	4-13
SRM-F Switch and LEDs	4-13
FRE Module Switch and LEDs	4-14

List of Figures

Figure 4-1. Front Panel LEDs4-2

Figure 4-2. SRM-L Connector Panel4-4

Figure 4-3. FDDI LEDs4-7

Figure 4-4. HSSI LEDs4-9

Figure 4-5. Token Ring LEDs4-11

Figure 4-6. 620 Watt Hot Swap Power Module Power OK LED4-12

Figure 4-7. SRM-F LEDs4-13

Figure 4-8. FRE Module LEDs4-14

List of Tables

Table 4-1. FDDI L1, L2, and L3 LEDs4-7

Table 4-2. FDDI S and P LEDs.....4-8

Table 4-3. FRE Module Diagnostic Codes4-16

Switches and LEDs

About this Chapter

This chapter describes the function of every switch and Light Emitting Diode (LED) on the BN.

The BN is equipped with switches and LEDs on the front panel and the rear panel. Also, the front edge of each FRE module inside the BN is equipped with LEDs for diagnostic purposes and a Flash memory card ejector button.

Front Panel

This section describes the function of the Reset switch and the LEDs on the front panel of the BN (see Figure 4-1).

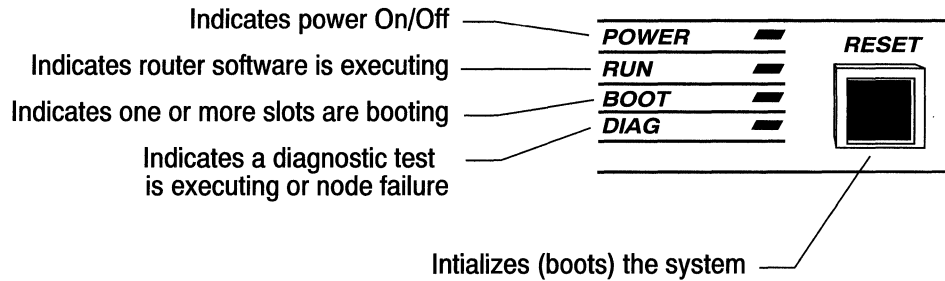

Figure 4-1. Front Panel LEDs

The front panel displays the following switch and LEDs:

The Reset switch warm-starts the router. It is equivalent to issuing the **boot** command from the Site Manager or the TI. Refer to the *Operations Guide* for a description of the warm-start procedure.

The Power LED indicates that the power supply voltages are within normal limits.

The Diag LED indicates that a diagnostic test is in progress on one or more slots. Diagnostic testing occurs when you cold-start the router. You cold-start the router when you power-cycle it or issue the **diags** command from the TI. Diagnostic testing takes one to two minutes. If a Token Ring Link Module is attached to a FRE, the diagnostic test for that slot takes about four minutes. The DAIG LED turns off when the testing terminates successfully.

When lit on a BCN, the DIAG LED may also indicate a fan failure. If a fan failure has occurred, refer to the chapter *Hot Swapping the Hardware* to hot swap the fan tray. You can verify whether the problem is a fan failure by doing one of the following:

- ❑ View the event messages generated by the GAME operating system. Event messages will report *System fan module failure...* and *System temperature has risen into cautionary range.*
- ❑ Remove the RFI shield to view the FRE module LEDs. If the DIAG LED on the front panel of the BCN is lit, and LEDs F and 8 on all FRE modules are *not* lit, a fan failure has occurred. Refer to the section *FRE Module* in this chapter to identify LEDs F and 8.

The Boot LED indicates that one or more slots are booting.

The Run LED indicates that one or more slots are executing system software.

The POWER and RUN LEDs remain lit when the BN is operating normally.

Rear Panel

The sections that follow describe the switches and LEDs on the Link Modules. You can see these switches and LEDs on the rear panel of the Wellfleet router. The Power OK LED on each of the 620 Watt Hot Swap Power Modules inserted in the rear panel of the BCN is also described.

SRM-L LEDs

The SRM-L is installed in the bottom slot (slot 1) on the rear panel of the BN (see Figure 4-2).

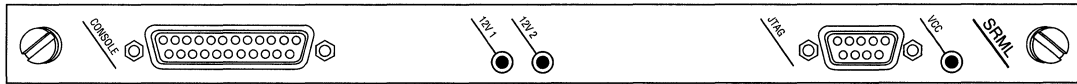

Figure 4-2. SRM-L Connector Panel

The LEDs on the SRM-L indicate the following:

- ❑ When the 12V 1 LED is *not* lit, the F7 fuse is blown in the BLN, or the F9 fuse is blown in the BCN. (Refer to *Replacing Specialized Fuses* in the appendix *Replacing Fuses*.)
- ❑ When the 12V 2 LED is *not* lit, the F6 fuse is blown in the BLN, or the F12 fuse is blown in the BCN. (Refer to *Replacing Specialized Fuses* in the appendix *Replacing Fuses*.)
- ❑ VCC indicates that the power supply voltages are within normal limits.

E1 and T1 LEDs

The E1 and T1 LEDs are as follows:

- FAIL is normally off. It lights when one of the following occurs:
 - Diagnostic testing is in progress. Diagnostic testing occurs when you cold-start the slot. You cold-start the slot when you power-cycle the BN, issue the **diags** command from the TI, or perform a hot swap of the Link Module. This LED blinks three times and goes out when the diagnostic testing terminates successfully.
 - Power-up diagnostic testing failed and the Link Module is waiting for an automatic attempt to reinitiate diagnostic testing. If the FAIL LED lights again, please call Wellfleet Customer Service.
 - A catastrophic failure due to a hardware problem on the Link Module occurred and the Link Module is waiting for an automatic attempt to reinitiate diagnostic testing. If the FAIL LED lights again, please call Wellfleet Customer Service.
- RLOS (Receiver Frame Loss) is normally off. It lights when the received signal has at least two framing errors for every four frames.
- RSIG (Receiver Signal Loss) is normally off. It lights when the received signal drops below .5V, or when more than 32 zeroes are detected.
- RYEL (Received Yellow Alarm) or RRA (Received Remote Alarm) is normally off. It lights when one of the following occurs:
 - RLOS is on at the remote end
 - RSIG or RLOS is on (at the local end)

Ethernet LEDs

The LEDs displayed on the Ethernet Link Module connector panels depend on which Ethernet Link Modules are installed in the BN. The following list includes the LEDs that may be displayed:

- ❑ COL indicates a collision detection.
- ❑ COM1 or COM2 indicates Carrier Detect is present on the respective COM port.
- ❑ FAIL indicates one of the following:
 - Diagnostic testing is in progress. Diagnostic testing occurs when you cold-start the slot. You cold-start the slot when you power-cycle the BN, issue the **diags** command from the TI, or perform a hot swap of the Link Module. This LED blinks three times and goes out when the diagnostic testing terminates successfully.
 - Power-up diagnostic testing failed and the Link Module is waiting for an automatic attempt to reinitiate diagnostic testing. If the FAIL LED lights again, please call Wellfleet Customer Service.
 - A catastrophic failure due to a hardware problem on the Link Module occurred and the Link Module is waiting for an automatic attempt to reinitiate diagnostic testing. If the FAIL LED lights again, please call Wellfleet Customer Service.

RCVR, RCVR1, or RCVR2 indicates data is being received by the respective port.

RLSD1 indicates Carrier Detect is present.

XCVR1 or XCVR2 indicates Ethernet traffic is present (either transmitting or receiving) on the respective port.

XMIT indicates data is being transmitted by the respective port.

FDDI LEDs

Figure 4-3 shows the LEDs on the FDDI Multimode Link Module.

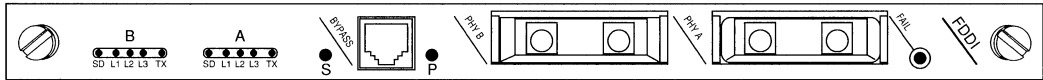

Figure 4-3. FDDI LEDs

The groups of LEDs labeled **A** and **B** indicate the status of physical connectors A and B as follows:

- ❑ The yellow LED labeled SD indicates the detection of an incoming signal.
- ❑ The green LED labeled TX indicates that the FDDI is transmitting across the interface.
- ❑ The red LEDs labeled L1, L2, and L3 indicate the line state. Table 4-1 shows the L1, L2, and L3 codes.

Table 4-1. FDDI L1, L2, and L3 LEDs

L1	L2	L3	Line State (LS)
On	On	On	Idle 16 (ILS16)
On	On	Off	Halt (HLS)
On	Off	On	Master (MLS)
On	Off	Off	Quiet (QLS)
Off	On	On	Idle 4 (ILS4)
Off	On	Off	Reserved
Off	Off	On	Active (ALS)
Off	Off	Off	Noise

The **S** (Secondary) and **P** (Primary) LEDs light only when an optional FDDI Dual Switch Module is cabled to the **BYPASS** connector on the FDDI display panel and is in **OPERATE** mode. (The switch is in **OPERATE** mode during normal FDDI Link Module operation.)

The **S** and **P** LEDs turn off when the FDDI Dual Switch Module bypasses the physical connectors **A** and **B** and redirects the incoming and outgoing signals to its own connectors. This occurs whenever:

- ❑ The router is powered off.
- ❑ The router is reset.
- ❑ The FDDI circuit is disabled.

Table 4-2 summarizes the **S** and **P** LED codes.

Table 4-2. FDDI S and P LEDs

S and P LEDs	Router Status
On	Router is present on the FDDI ring.
Off	Router is bypassed (absent) from the FDDI ring.

The **FAIL** LED lights when the FDDI Link Module fails power-up diagnostics.

HSSI LEDs

This section identifies the LEDs on the High Speed Serial Interface (HSSI) Link Modules.

Figure 4-4 shows the LEDs on the HSSI Link Module.

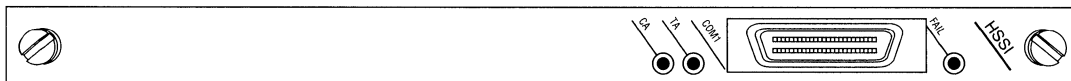

Figure 4-4. HSSI LEDs

The HSSI LEDs are as follows:

- ❑ The green LED labeled CA indicates the DSU is active and ready to receive or transmit data.
- ❑ The green LED labeled TA indicates that the router is active and ready to receive or transmit data.
- ❑ The red LED labeled FAIL indicates one of the following:
 - Diagnostic testing is in progress. Diagnostic testing occurs when you cold-start the slot. You cold-start the slot when you power-cycle the Wellfleet router, issue the **diags** command from the TI, or perform a hot swap of the Link Module. This LED blinks three times and goes out when the diagnostic testing terminates successfully.
 - Power-up diagnostic testing failed and the Link Module is waiting for an automatic attempt to reinitiate diagnostic testing. If the FAIL LED lights again, please call Wellfleet Customer Service.
 - A catastrophic failure due to a hardware problem on the Link Module occurred and the Link Module is waiting for an automatic attempt to reinitiate diagnostic testing. If the FAIL LED lights again, please call Wellfleet Customer Service.

Sync LEDs

The LEDs displayed on the Sync Link Module connector panels depend on which Sync Link Modules are installed in the BN. The following list includes the LEDs that may be displayed:

- ❑ RLSD1, 2, 3, or 4; or COM indicates Carrier Detect is present on the respective port. RLSD stands for Received Line Signal Detect.
- ❑ FAIL indicates one of the following:
 - Diagnostic testing is in progress. Diagnostic testing occurs when you cold-start the slot. You cold-start the slot when you power-cycle the BN, issue the **diags** command from the TI, or perform a hot swap of the Link Module. This LED blinks three times and goes out when the diagnostic testing terminates successfully.
 - Power-up diagnostic testing failed and the Link Module is waiting for an automatic attempt to reinitiate diagnostic testing. If the FAIL LED lights again, please call Wellfleet Customer Service.
 - A catastrophic failure due to a hardware problem on the Link Module occurred and the Link Module is waiting for an automatic attempt to reinitiate diagnostic testing. If the FAIL LED lights again, please call Wellfleet Customer Service.

Token Ring LEDs

This section identifies the LEDs on the Token Ring Link Modules. Figure 4-5 shows the LEDs on the Dual Token Ring Link Module.

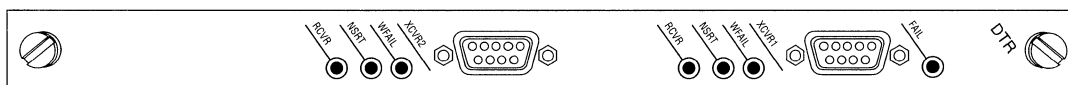

Figure 4-5. Token Ring LEDs

The Token Ring LEDs assist in monitoring receive and transmit activities across a Token Ring connection. The LEDs are as follows:

- ❑ The green LED labeled RCVR indicates that data is being received across the Token Ring connection.
- ❑ The green LED labeled NSRT indicates the node is inserted into the Token Ring connection.
- ❑ The red LED labeled WFAL indicates a wire fault on either receive or transmit.
- ❑ The red LED labeled FAIL indicates one of the following:
 - Diagnostic testing is in progress. Diagnostic testing occurs when you cold-start the slot. You cold-start the slot when you power-cycle the Wellfleet router, issue the **diags** command from the TI, or perform a hot swap of the Link Module. This LED blinks three times and goes out when the diagnostic testing terminates successfully.
 - Power-up diagnostic testing failed and the Link Module is waiting for an automatic attempt to reinitiate diagnostic testing. If the FAIL LED lights again, please call Wellfleet Customer Service.
 - A catastrophic failure due to a hardware problem on the Link Module occurred and the Link Module is waiting for an automatic attempt to reinitiate diagnostic testing. If the FAIL LED lights again, please call Wellfleet Customer Service.

BCN 620 Watt Hot Swap Power Module LED

This section describes the function of the green Power OK LED on each of the 620 Watt Hot Swap Power Modules inserted in the rear panel of the BCN. Figure 4-6 shows the LED on a Hot Swap Power Module.

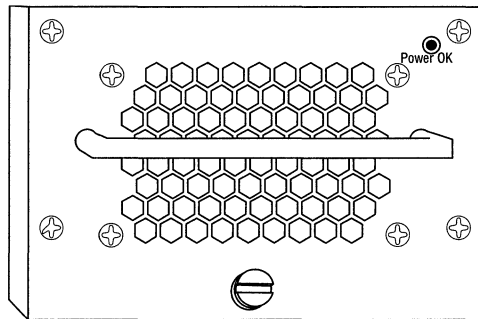

Figure 4-6. 620 Watt Hot Swap Power Module Power OK LED

The Power OK LED indicates that the BCN is powered on, and that the Hot Swap Power Module is fully engaged and operational.

SRM-F and FRE Modules

Use the SRM-F and FRE module LEDs for troubleshooting only. You remove the front bezel and the RFI shield to view the LEDs (refer to the chapter *Accessing the Interior* for instructions).

SRM-F Switch and LEDs

The front edge of the SRM-F module in slot 1 inside the BN is equipped with two LEDs. A power switch may also be included (see Figure 4-7).



Figure 4-7. SRM-F LEDs

Note: The power switch is installed on some SRM-F modules.

The power switch powers on the SRM-F when you switch it to the right and powers off the SRM-F when you switch it to the left.

LED A, when lit, indicates the board is held in reset due to a catastrophic hardware failure.

LED B, when lit, indicates 5 Volts are available to the SRM-F.

FRE Module Switch and LEDs

The front edge of each FRE module inside the BN is equipped with LEDs, an HDCM (Harpoon Diagnostic Console Monitor) button, and a Flash Card Ejector (see Figure 4-8). A power switch is included on some FRE modules.

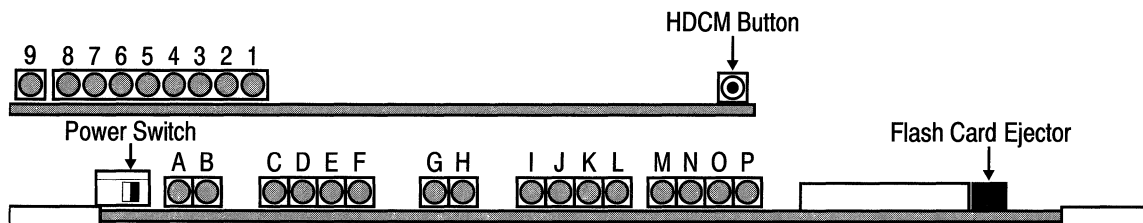

Figure 4-8. FRE Module LEDs

LEDs 1 through 9 and the HDCM button are located on the daughter board.

LEDs 1-8 indicate the following during diagnostic testing. (Diagnostic testing occurs during a cold-start (power-cycle or TI **diags** command.)

- 1 to 7 Diagnostic test number executing. The diagnostic test number is represented in hexadecimal notation. Lighted LEDs indicate 1's; darkened LEDs indicate 0's.
- 8 Diagnostic testing is in progress.

LEDs 1-8 indicate the following when LED F is also lit. (When LED F is lit, the Gate Access Management Entity [GAME] operating system is executing.)

- 1 to 6 Least significant digits of the second counter expressed in binary. The counter is updated each second. (During a boot, these LEDs flicker rapidly.)
- 7 Slot is running TI. (Only one slot runs the TI at a time.)
- 8 FRE module is booting (or resetting) and PROM read/write protection is disabled. This LED also lights during the

execution of the TI **prom -w** (write) command, which is issued to update a PROM.

LED 9 lights whenever a reset is sent to the CPU.

The HDCM button has three functions:

- ❑ Cold-starts the FRE module when you press it for more than one second and release it (regardless of the session).
- ❑ Establishes an HDCM session when pressed for less than one second and released. The HDCM is for Wellfleet Customer Service only.
- ❑ Warm-starts the FRE module when an HDCM session is established and you press it for less than one second and release it.

The LEDs A through P, the power switch, and Flash Card Ejector are located on the mother board.

The mother board LEDs indicate the following when lit:

- A The backbone is held in reset due to a hardware or software error. This LED also flashes briefly when the FRE is reinitialized or reset.
- B The backbone DMA logic is accessing the DRAM.
- C, D These LEDs display a code which reveals the diagnostic test under execution (see Table 4-3).
- E Diagnostics code execution is in progress.
- F The GAME operating system is executing.
- G The CPU is accessing the DRAM.
- H Hardware is resetting.
- I The FRE module is transmitting on Backbone A.
- J The FRE module is transmitting on Backbone B.
- K The FRE module is transmitting on Backbone C.
- L The FRE module is transmitting on Backbone D.
- M Backbone A is asserting flow control.

- N Backbone B is asserting flow control.
- O Backbone C is asserting flow control.
- P Backbone D is asserting flow control.

The power switch powers on the FRE module when you switch it to the right and powers off the FRE module when you switch it to the left. The power switch is installed on some FRE modules.

The Flash Card Ejector disconnects the Flash card.

Table 4-3. FRE Module Diagnostic Codes

C LED	D LED	E LED	Diagnostic Test in Progress
on	on	on	CPU
off	on	on	Backbone
on	off	on	Link Module
off	off	on	HDCM (Harpoon Diagnostic Console Monitor)

Appendix A

Replacing Fuses

About this Appendix	A-1
Replacing Fuses in the BLN	A-2
Replacing Fuses in the BCN	A-9

List of Figures

Figure A-1. Removing the Fuse Access Panel from the BLN A-3
Figure A-2. Connecting the Antistatic Strap to the BLN Chassis A-4
Figure A-3. Disconnecting the Back of the Fuse Access Panel
on the BLN A-5
Figure A-4. Location of Specialized Fuses in the BLN A-5
Figure A-5. Specialized Fuse (New) A-6
Figure A-6. Removing the Fuse Access Panel from the BCN A-10
Figure A-7. Location of Specialized Fuses in the BCN A-11
Figure A-8. Specialized Fuse (New) A-11

List of Tables

Table A-1. BLN Fuses A-7
Table A-2. BCN Fuses A-12

Replacing Fuses

About this Appendix

This appendix describes how to inspect and replace specialized fuses in the BLN and BCN. It is divided into two sections: *Replacing Fuses in the BLN* and *Replacing Fuses in the BCN*.

The following warning applies to the BLN and BCN.



Danger - High Energy

Due to high-energy hazards, all procedures described in this chapter are to be performed by service personnel only.



Service Personnel

Service personnel are required to have experience installing and servicing Wellfleet network hardware, and have training in taking precautions to minimize danger to themselves and others while performing a task inside a hazardous service access area.

The BLN is equipped with a power supply fuse to protect the power supply from excessive current. If the BLN will not power on, contact Wellfleet Customer Support. (This document does *not* provide instructions for replacing the power supply fuse.)

The BCN is equipped with a circuit breaker to protect the power supply from excessive current. If the BLN has an AC power supply, but will not power on, contact Wellfleet Customer Support. (This document does *not* provide instructions for replacing the power supply fuse.)

Replacing Fuses in the BLN

The BLN is equipped with eight fuses to protect individual slots, the Ethernet ports, and the SRM-L Console port. Refer to the instructions in this section if the *Slot disconnected* or *Backbone disconnected* event message is displayed on the log and one of the following occurs:

- ❑ All LEDs on a Link Module connector panel are not lit.
- ❑ The CR2 or CR3 LED on the SRM-L connector panel is not lit.
- ❑ The LEDs on a FRE module are not lit. (Refer to the chapter *Accessing the Interior* to remove the front bezel and RFI shield to view the FRE module LEDs. Then replace the RFI shield.)

The specialized fuses are located behind the fuse access panel, the metal panel where the Reset switch is mounted (see Figure A-1).



Warning: Electrostatic discharge can damage hardware. You must attach the antistatic strap to your wrist and connect it to the chassis behind the fuse access panel before you handle BLN components (refer to the instructions that follow.)

Remove the fuse access panel as follows:

1. Power down the BLN and disconnect the plug from the power receptacle.
2. Refer to the chapter *Accessing the Interior* to remove the front bezel.
3. Remove the antistatic strap, alligator clip, and fuse puller from the pouch attached to the back of the front bezel.

4. Insert the end of the antistatic strap into the hole in the alligator clip.
5. Insert your (left) hand inside the band at one end of the antistatic strap.

Ensure the metal buckle inside the band is in contact with your skin. (Swing open the metal buckle to adjust the strap to form a snug fit if necessary).

You connect the other end of the wrist strap after you remove the fuse access panel.

6. Use a Phillips screwdriver to remove the screws that secure the fuse access panel to the chassis (see Figure A-1).

Note: Hold the fuse access panel in place several inches away from the chassis to avoid pulling the wires that connect the back of the panel to the BLN.

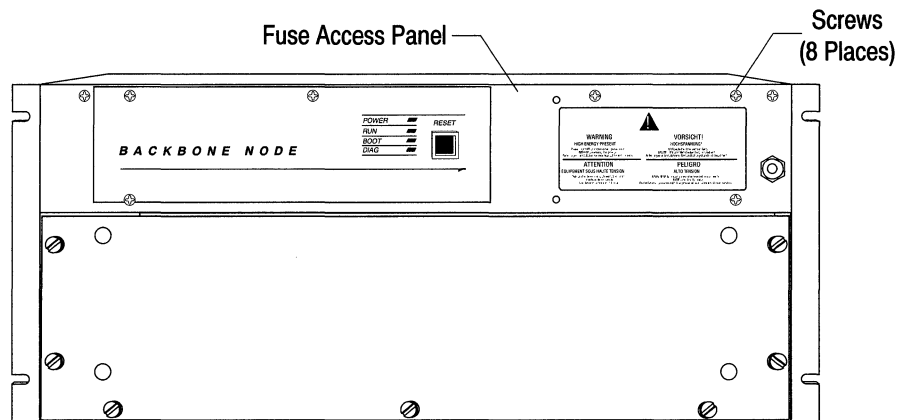

Figure A-1. Removing the Fuse Access Panel from the BLN

7. Connect the alligator clip on the other end of the antistatic strap to the chassis behind the fuse access panel (see Figure A-2).

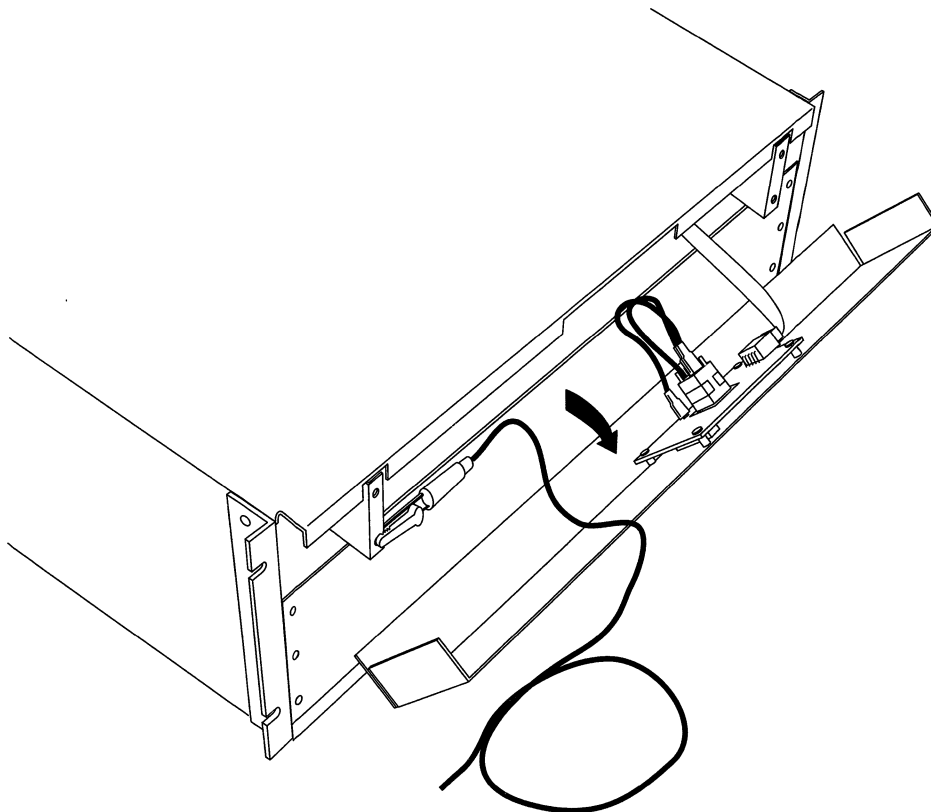

Figure A-2. Connecting the Antistatic Strap to the BLN Chassis

8. Lift the ejectors behind the fuse access panel (see Figure A-3).
The ejectors connect the component behind the fuse access panel to a ribbon cable connector.
9. Slide the component to the right to disconnect it.

Note: The red line on the ribbon cable connector aligns with the arrow on the connector attached to the back of the fuse access panel.

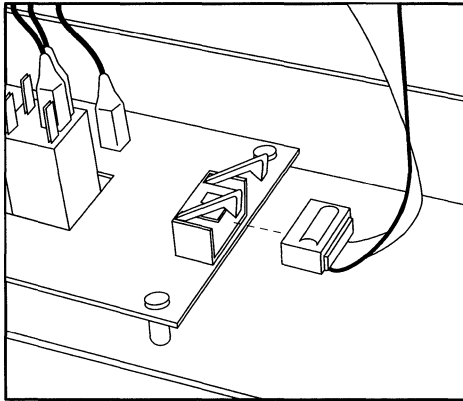

Figure A-3. Disconnecting the Back of the Fuse Access Panel on the BLN

10. Remove the fuse access panel.

The specialized fuses are inserted in fuse connectors mounted on a vertical plane inside the BLN (see Figure A-4). Each fuse connector is labeled with a fuse (F) number. Refer to Table A-1 to determine which fuse to replace.

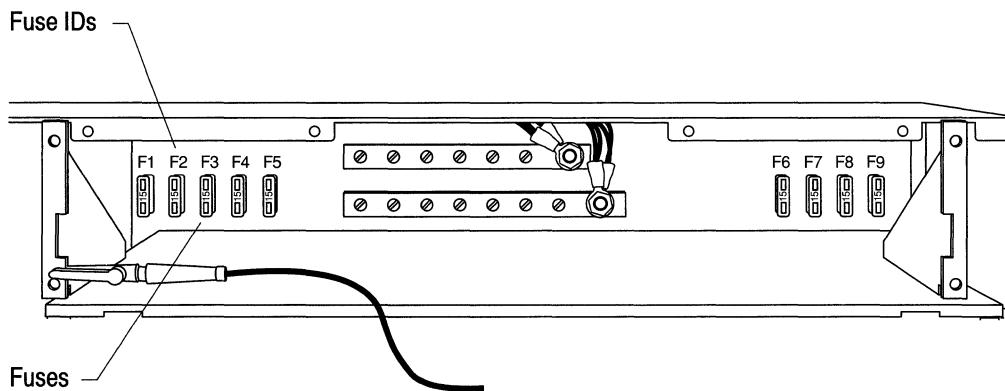

Figure A-4. Location of Specialized Fuses in the BLN

To remove a fuse, push the forked edge of the fuse puller over the fuse until it locks into place and pull it toward you.

Replace the fuse with a new one if the fuse is smoked or the loop between the two sides of the fuse is broken (see Figure A-5).

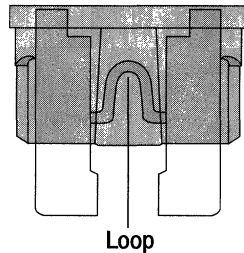

Figure A-5. Specialized Fuse (New)

To install a fuse, insert and push it into the fuse connector.

Replace the BLN hardware components as follows:

1. Hold the fuse access panel several inches away from the chassis.
2. Align the red line on the ribbon cable connector with the arrow on the connector attached to the back of the fuse access panel.
3. Close the ejectors to secure the connection.
4. Disconnect the wrist strap from the chassis.
5. Insert and tighten the screws that fasten the fuse access panel to the chassis.
6. Replace the front bezel (refer to the chapter *Accessing the Interior* for instructions).

Table A-1. BLN Fuses

Fuse ID	Fuse Part No.	Amperage (Voltage)	Function	Physical Indicators	Event Messages
F1	103541	25 Amp (+5 Volt)	Slot 1 SRM-F	All SRM-F LEDs are off.	GAME: Backbones 0 and 1 became disconnected
F2	103541	25 Amp (+5 Volt)	Slot 1 SRM-L, Slot 2 Link Module, and FRE	All FRE and Link Module LEDs in slot 2 are off.	GAME: Backbones 2 and 3 became disconnected GAME: Slot 2 became disconnected
F3	103541	25 Amp (+5 Volt)	Slot 3 Link Module and FRE	All FRE and Link Module LEDs in 3 are off.	GAME: Slot 3 became disconnected
F4	103541	25 Amp (+5 Volt)	Slot 4 Link Module and FRE	All FRE and Link Module LEDs in slot 4 are off.	GAME: Slot 4 became disconnected
F5	103541	25 Amp (+5 Volt)	Slot 5 Link Module and FRE	All FRE and Link Module LEDs in slot 5 are off.	GAME: Slot 5 became disconnected
F6	104395	7.5 Amp (+12 Volt)	Ethernet ports on Slots 4 and 5	All FRE Module LEDs in slots 4 and 5 and the SRM-L 12V 2 LED in slot 1 are off.	GAME: Backbones 0 and 1 became disconnected GAME: Slots 4 and 5 became disconnected

Table A-1. BLN Fuses

Fuse ID	Fuse Part No.	Amperage (Voltage)	Function	Physical Indicators	Event Messages
F7	104395	7.5 Amp (+12 Volt)	Ethernet ports on Slots 2 and 3	All FRE Module LEDs in slots 2 and 3 and the SRM-L 12V 1 LED in slot 1 are off.	GAME: Backbones 2 and 3 became disconnected GAME: Slots 2 and 3 became disconnected
F8	104394	5 Amp (-12 Volt)	SRM-L (TI) Console Port	No response at TI console	Not Applicable
F9	103541	25 Amp (+5 Volt)	Spare	Not Applicable	Not Applicable

Replacing Fuses in the BCN

The BCN is equipped with fuses to protect individual slots, the SRM-F, the SRM-L, and the fan tray. Refer to the instructions in this section if the *Slot disconnected* or *Backbone disconnected* event message is displayed on the log and one of the following occurs:

- All LEDs on a Link Module connector panel are not lit.
- The CR2 or CR3 LED on the SRM-L connector panel is not lit.
- The LEDs on a FRE module are not lit. (Refer to the chapter *Accessing the Interior* to remove the front bezel and RFI shield to view the FRE module LEDs. Then replace the RFI shield.)

The specialized fuses are located behind the fuse access panel, the bottom rear panel of the BCN (see Figure A-6).



Warning: Electrostatic discharge can damage hardware. You must attach the antistatic strap to your wrist and connect it to the chassis before you handle BCN components (refer to the instructions that follow.)

Remove the fuse access panel as follows:

1. Power down the BCN and disconnect the plug from the power receptacle.
2. Refer to the chapter *Accessing the Interior* to remove the front bezel.
3. Remove the antistatic strap and fuse puller from the pouch attached to the back of the front bezel.
4. Insert your hand inside the band at one end of the antistatic strap and connect the other end to the antistatic receptacle on the fan tray panel, which is mounted to the front of the BCN's chassis. (Refer to the chapter *Accessing the Interior* for details.)
5. Use a Phillips screwdriver to remove the screws that secure the fuse access panel to the chassis (see Figure A-6).
6. Remove the fuse access panel.

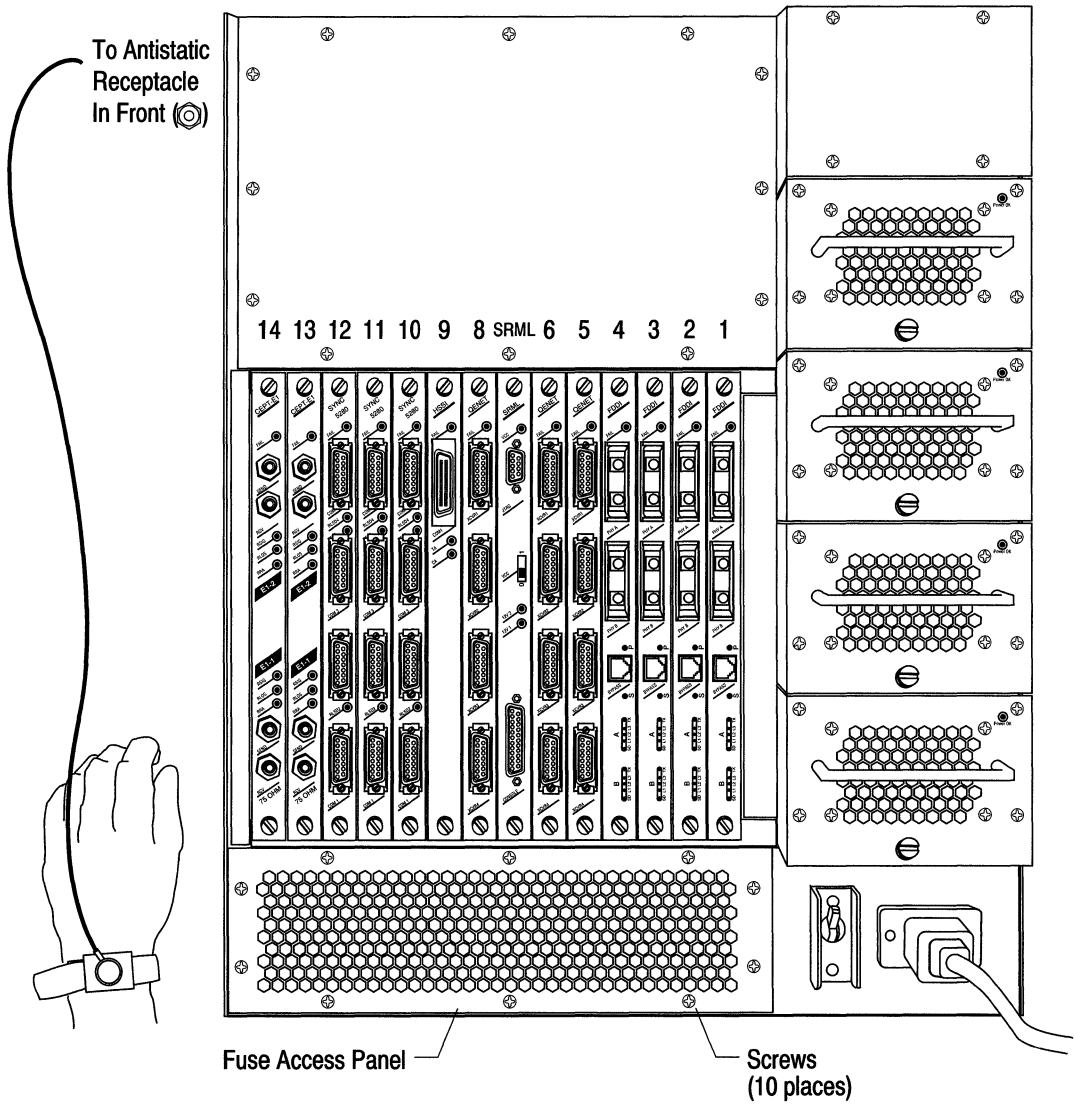

Figure A-6. Removing the Fuse Access Panel from the BCN

The specialized fuses are inserted in fuse connectors mounted on a vertical plane inside the BCN (see Figure A-7). Each fuse connector is labeled with a fuse (F) number. Refer to Table A-2 to determine which fuse to replace.

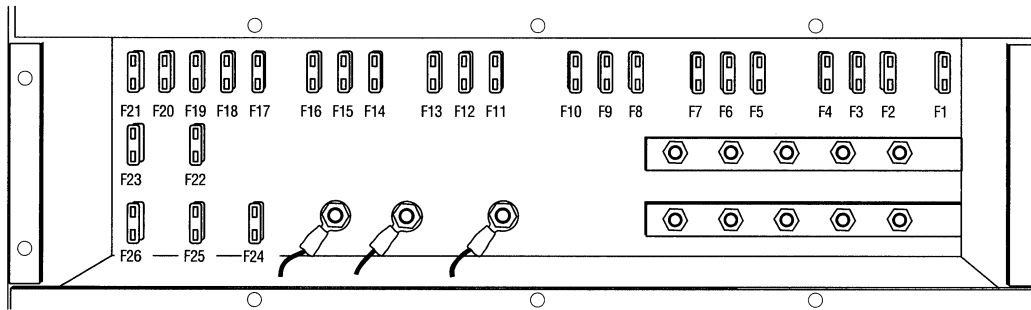

Figure A-7. Location of Specialized Fuses in the BCN

To remove a fuse, push the forked edge of the fuse puller over the fuse until it locks into place and pull it toward you.

Replace the fuse with a new one if the fuse is smoked or the loop between the two sides of the fuse is broken (see Figure A-8).

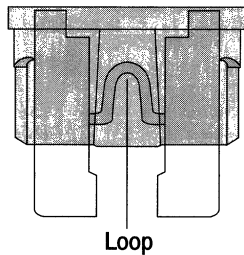

Figure A-8. Specialized Fuse (New)

To install a fuse, insert and push it into the fuse connector.



Danger - High Energy

Be sure to replace and secure the BCN fuse access panel before powering on.

Table A-2. BCN Fuses

Fuse ID	Fuse Part No.	Amperage (Voltage)	Function	Physical Indicators	Event Messages
F1	103541	25 Amp (+5 Volt)	Slot 1 Link Module and FRE	All FRE and Link Module LEDs are off in Slot 1	GAME: Slot 1 became disconnected
F2	103541	25 Amp (+5 Volt)	Slot 2 Link Module and FRE	All FRE and Link Module LEDs are off in Slot 2	GAME: Slot 2 became disconnected
F3	104395	7.5 Amp (+12 Volt)	Slots 1 and 3 Link Modules and FREs	All FRE and Link Module LEDs are off in Slots 1 and 3	GAME: Slots 1 and 3 became disconnected
F4	103541	25 Amp (+5 Volt)	Slot 3 Link Module and FRE	All FRE and Link Module LEDs are off in Slot 3	GAME: Slot 3 became disconnected
F5	103541	25 Amp (+5 Volt)	Slot 4 Link Module and FRE	All FRE and Link Module LEDs are off in Slot 4	GAME: Slot 4 became disconnected

Table A-2. BCN Fuses

Fuse ID	Fuse Part No.	Amperage (Voltage)	Function	Physical Indicators	Event Messages
F6	104395	7.5 Amp (+12 Volt)	Slots 2 and 4 Link Modules and FREs	All FRE and Link Module LEDs are off in Slots 2 and 4	GAME: Slots 2 and 4 became disconnected
F7	103541	25 Amp (+5 Volt)	Slot 5 Link Module and FRE	All FRE and Link Module LEDs are off in Slot 5	GAME: Slot 5 became disconnected
F8	103541	25 Amp (+5 Volt)	Slot 6 Link Module and FRE	All FRE and Link Module LEDs are off in Slot 6.	GAME: Slot 6 became disconnected
F9	104395	7.5 Amp (+12 Volt)	Slots 5 and 8 FREs and SRM-L	All FRE and Link Module LEDs are off in Slots 5 and 8, and all SRM-L LEDs are off.	GAME: Backbones 2 and 3 became disconnected GAME: Slots 5 and 8 became disconnected
F10	103541	25 Amp (+5 Volt)	SRM-F	All SRM-F LEDs are off.	GAME: Backbones 0 and 1 became disconnected
F11	103541	25 Amp (+5 Volt)	Slot 8 Link Module, FRE, and SRM-L	All FRE and Link Module LEDs are off in Slot 8, and all SRM-L LEDs are off.	GAME: Backbones 2 and 3 became disconnected GAME: Slot 8 became disconnected

Table A-2. BCN Fuses

Fuse ID	Fuse Part No.	Amperage (Voltage)	Function	Physical Indicators	Event Messages
F12	104395	7.5 Amp (+12 Volt)	Slots 6 and 9 Link Modules, FREs, and SRM-F	All FRE and Link Module LEDs are off in Slots 6 and 9, and all SRM-F LEDs are off.	<p>GAME: Backbones 0 and 1 became disconnected</p> <p>GAME: Slots 6 and 9 became disconnected</p>
F13	103541	25 Amp (+5 Volt)	Slot 9 Link Module, FRE, and BCN fan tray	All FRE and Link Module LEDs are off in Slot 9, and all front panel LEDs are off.	<p>GAME: System fan module failure, one or more fans not operating properly</p> <p>GAME: System temperature has risen into cautionary range</p> <p>GAME: Slot 9 became disconnected</p>
F14	103541	25 Amp (+5 Volt)	Slot 10 Link Module and FRE	All FRE and Link Module LEDs are off in Slot 10.	GAME: Slot 10 became disconnected
F15	104395	7.5 Amp (+12 Volt)	Slots 10 and 12 Link Modules and FREs	All FRE and Link Module LEDs are off in Slots 10 and 12	GAME: Slots 10 and 12 became disconnected
F16	103541	25 Amp (+5 Volt)	Slot 11 Link Module and FRE	All FRE and Link Module LEDs are off in Slot 11.	GAME: Slot 11 became disconnected

Table A-2. BCN Fuses

Fuse ID	Fuse Part No.	Amperage (Voltage)	Function	Physical Indicators	Event Messages
F17	103541	25 Amp (+5 Volt)	Slot 12 Link Module and FRE	All FRE and Link Module LEDs are off in Slot 12	GAME: Slot 12 became disconnected
F18	104395	7.5 Amp (+12 Volt)	Slots 11 and 13 Link Modules and FREs	All FRE and Link Module LEDs are off in Slots 11 and 13	GAME: Slots 11 and 13 became disconnected
F19	103541	25 Amp (+5 Volt)	Slot 13 Link Module and FRE	All FRE and Link Module LEDs are off in Slot 13	GAME: Slot 13 became disconnected
F20	104395	7.5 Amp (+12 Volt)	Slot 14 Link Module, FRE, and BCN fan tray	All FRE and Link Module LEDs are off in Slot 14, and all front panel LEDs are off.	GAME: System fan module failure, one or more fans not operating properly GAME: System temperature has risen into cautionary range GAME: Slot 14 became disconnected
F21	103541	25 Amp (+5 Volt)	Slot 14 Link Module and FRE	All FRE and Link Module LEDs are off in Slot 14	GAME: Slot 14 became disconnected

Table A-2. BCN Fuses

Fuse ID	Fuse Part No.	Amperage (Voltage)	Function	Physical Indicators	Event Messages
F22	104395	7.5 Amp (+12 Volt)	Reserved for future use. If fuse is blown, disregard.	Not Applicable	Not Applicable
F23	104395	7.5 Amp (+12 Volt)	Reserved for future use. If fuse is blown, disregard.	Not Applicable	Not Applicable
F24	103541	25 Amp (+5 Volt)	Spare	Not Applicable	Not Applicable
F25	104394	5 Amp (-12 Volt)	Sync Connectors in Slots 2, 4, 6, 9, 11, and 13	Not Applicable	<p>Sync : Connector COM <no.> : can't run BOFL with chosen WAN protocol.</p> <p>Sync : Connector COM <no.> LLC<1_or_2> service withdrawn.</p> <p>Sync : System error, service attempting restart.</p>

Table A-2. BCN Fuses

Fuse ID	Fuse Part No.	Amperage (Voltage)	Function	Physical Indicators	Event Messages
F26	104394	5 Amp (-12 Volt)	Sync Connectors in Slots 1, 3, 5, 8, 10, 12, and 14; and SRM-L (TI) Console Port	No response at TI console	<p>Sync : Connector COM <no.> : can't run BOFL with chosen WAN protocol.</p> <p>Sync : Connector COM <no.> LLC<1_or_2> service withdrawn.</p> <p>Sync : System error, service attempting restart.</p>

Numerics

- 12V SRM-Link LEDs 4-4
- 4995 FDDI Daughterboard for Multimode Link Module 3-39
- 4995 FDDI Daughterboard for Single Mode Link Module 3-41
- 5201 Dual Port T1 Link Module 3-2
- 5250 Dual Port E1 Link Module 3-4
- 5280 Quad Port Sync Link Module 3-6
- 5290 Single HSSI Link Module 3-10
- 5405 Dual Ethernet Link Module 3-12
- 5410 Single Sync/Single Ethernet Link Module 3-14
- 5420 Dual Sync/Single Ethernet Link Module 3-16
- 5430 Dual Sync/Dual Ethernet Link Module 3-18
- 5450 Quad Ethernet Link 3-20
- 5505 Dual Ethernet High Speed Filters Link Module 3-22
- 5530 Dual Sync/Dual Ethernet High Speed Filters Link Module 3-24
- 5705 Single Token Link Module 3-26
- 5710 Dual Token Link Module 3-28
- 5720 Single Sync/Single Token Link Module 3-30
- 5740 Dual Sync/Single Token (DST-4) Link Module 3-32
- 5740 Dual Sync/Single Token (DST-4/16) Link Module 3-34
- 5740 Dual Sync/Single Token (TS416 1X2) Link Module 3-36
- 5930 FDDI Multimode Link Module 3-38
- 5940 FDDI Single Mode Link Module 3-40
- 75000 System Resource Module-Link 3-42
- 75010 System Resource Module-Front 3-43
- 75150 Fast Routing Engine 3-44

A

- A FDDI Multimode Link LED 4-7
- antistatic wrist strap
 - instructions 1-4
 - location 1-4

B

- B FDDI Multimode Link LED 4-7
- BOOT LED, front panel 4-3

C

CA HSSI Link LED 4-9
Carrier Detect Ethernet LED 4-6
Carrier Detect Sync LED 4-10
COL Ethernet LED 4-6
COM Ethernet LEDs 4-6
COM Sync LED 4-10

D

DIAG LED 4-3
Dual Ethernet High Speed Filters Link
5505 3-22
Dual Ethernet Link 5405 3-12
Dual Port E1 Link 5250 3-4
Dual Port T1 Link 5201 3-2
Dual Sync/Dual Ethernet High Speed
Filters Link 5530 3-24
Dual Sync/Dual Ethernet Link 5430
3-18
Dual Sync/Single Ethernet Link 5420
3-16
Dual Sync/Single Token (DST-4) Link
5740 3-32
Dual Sync/Single Token (DST-4/16)
Link 5740 3-34
Dual Sync/Single Token (TS416 1X2)
Link 5740 3-36
Dual Token Link 5710 3-28

E

E1 Link LEDs 4-5
Ethernet Link LEDs 4-6

F

FAIL LED
Ethernet Link 4-6
FDDI Multimode Link 4-8
HSSI Link 4-9
Sync Link 4-5, 4-10
Token Ring Link 4-11
fan tray
replacing in the BCN 2-18
Fast Routing Engine 75150 3-44
FDDI Daughterboard 4995 for
Multimode Link 3-39
FDDI Daughterboard 4995 for Single
Mode Link 3-41
FDDI Multimode Link 5930 3-38
FDDI Single Mode Link 5940 3-40
Flash card
approved vendors 2-3
ejector button 4-15
replacing 2-2
system's response to installation
and removal 2-2
FRE
LEDs 4-14
replacing 2-9
system's response to installation
and removal 2-9
front bezel, removing and installing 1-2
front panel
switches and LEDs 4-2
fuses
indicators, functions, and part
numbers A-7, A-12
replacing A-1

H

HDCM button *4-14*
hot swap instructions *2-1 to 2-13*
hot swap power module
 LED *4-12*
HSSI Link LEDs *4-9*

L

L1, L2, and L3 FDDI Multimode Link
 LEDs *4-7*

LEDs

 BOOT *4-3*
 DIAG *4-3*
 E1 Link *4-5*
 Ethernet Link *4-6*
 FDDI Multimode Link *4-7*
 FRE module *4-14*
 HSSI Link *4-9*
 POWER *4-2*
 Power OK *4-12*
 RUN *4-3*
 SRM-F *4-13*
 SRM-L *4-4*
 Sync Link *4-10*
 T1 Link *4-5*
 Token Ring Link *4-11*

Link Module

 replacing *2-5*
 system's response to installation
 and removal *2-5*

N

NSRT Token Ring Link LED *4-11*

P

P FDDI Multimode Link LED *4-8*
PCB boards, configuring *3-1*
POWER LED, front panel *4-2*
Power Module
 replacing in the BCN *2-16*
 BCN's response to installation and
 removal *2-14*
Power OK LED *4-12*
power switch
 location of FRE and SRM-F *2-13*

Q

Quad Ethernet Link 5450 *3-20*
Quad Port Sync Link 5280 *3-6*

R

RCVR Ethernet LEDs *4-6*
RCVR Token Ring Link LED *4-11*
rear panel switches and LEDs *4-4*
Reset switch *4-2*
RFI Shield, removing and installing
 1-6
RLSD1 Ethernet LED *4-6*
RLSD1 Sync LED *4-10*
RUN LED, front panel *4-3*

S

S FDDI Multimode Link LED 4-8
SD FDDI Multimode Link LED 4-7
Single HSSI Link 5290 3-10
Single Sync/Single Ethernet Link 5410
 3-14
Single Sync/Single Token Link 5720
 3-30
Single Token Link 5705 3-26
SRM-F
 power switch location 2-13
 removing with SRM-L, effect on
 system 2-5
 replacing 2-9
 switches and LEDs 4-13
SRM-L
 removing with SRM-F, effect on
 system 2-5
 replacing 2-5
 switches and LEDs 4-4
Sync Link LEDs 4-10
System Resource Module-Front 75010
 3-43
System Resource Module-Link 75000
 3-42

T

T1 Link LEDs 4-5
TA HSSI Link LED 4-9
Token Ring Link LEDs 4-11
TX FDDI Multimode Link LED 4-7

V

VCC SRM-Link LED 4-4

W

WFAIL Token Ring Link LED 4-11
wrist strap
 instructions 1-4
 location 1-4

X

XCVR LEDs 4-6
XMIT LED 4-6

Maintenance Guide **Revision B**

What did you find most useful about this guide?

What did you find least useful about this guide?

What information that you expected or needed was missing?

Please note any errors or ambiguities.

Name:
Title:
Company:
Address:

BULK RATE
U.S. Postage
PAID
Permit No. 84
Woburn, MA 01888

Wellfleet Communications, Inc.
Technical Publications
15 Crosby Drive
Bedford, Massachusetts 01730